

# HP P2000 G3 SAS MSA System User Guide

Part number: 614561-002  
First edition: July 2011



**Legal and notice information**

© Copyright 2011 Hewlett-Packard Development Company, L.P.

Confidential computer software. Valid license from HP required for possession, use or copying. Consistent with FAR 12.211 and 12.212, Commercial Computer Software, Computer Software Documentation, and Technical Data for Commercial Items are licensed to the U.S. Government under vendor's standard commercial license.

The information contained herein is subject to change without notice. The only warranties for HP products and services are set forth in the express warranty statements accompanying such products and services. Nothing herein should be construed as constituting an additional warranty. HP shall not be liable for technical or editorial errors or omissions contained herein.

**Acknowledgements**

Microsoft and Windows are U.S. registered trademarks of Microsoft Corporation.

UNIX is a registered trademark of The Open Group.

# Contents

About this guide . . . . .	11
Intended audience . . . . .	11
Prerequisites . . . . .	11
Related documentation . . . . .	11
Document conventions and symbols . . . . .	12
Rack stability . . . . .	13
HP technical support . . . . .	13
Customer self repair . . . . .	13
Product warranties . . . . .	13
Subscription service . . . . .	13
HP websites . . . . .	14
Documentation feedback . . . . .	14
1 Overview . . . . .	15
Features and benefits . . . . .	15
2 Components . . . . .	17
Front panel components . . . . .	17
P2000 G3 SAS MSA System LFF . . . . .	17
P2000 G3 SAS MSA System SFF . . . . .	17
Disk drive bay numbers . . . . .	18
Rear panel view — controller module . . . . .	18
P2000 G3 SAS MSA System controller module face plate . . . . .	18
Rear panel components . . . . .	19
P2000 G3 SAS MSA System SFF and P2000 G3 SAS MSA System LFF . . . . .	19
D2700 6Gb drive enclosure . . . . .	19
P2000 6Gb 3.5" 12-drive enclosure . . . . .	20
MSA70 3Gb drive enclosure . . . . .	20
MSA2000 3Gb 3.5" 12-drive enclosure . . . . .	20
Cache . . . . .	20
Transportable CompactFlash . . . . .	21
Super-capacitor pack . . . . .	21
3 Installing the enclosures . . . . .	23
Installation checklist . . . . .	23
Connecting controller and drive enclosures . . . . .	24
Connecting controller and D2700 6Gb drive enclosure . . . . .	24
Connecting controller and P2000 6Gb 3.5" 12-drive enclosure . . . . .	24
Connecting controller and MSA70 3Gb drive enclosure . . . . .	24
Connecting controller and MSA2000 3Gb 3.5" 12-drive enclosure . . . . .	24
Connecting controller and mixed drive enclosures . . . . .	25
Additional cable requirements for drive enclosures . . . . .	25
P2000 G3 MSA System cable requirements . . . . .	25
Additional cabling considerations . . . . .	26
Testing enclosure connections . . . . .	33
Powering on/powering off . . . . .	33
Power supply . . . . .	33
Power Cords . . . . .	34
AC model . . . . .	34
DC model . . . . .	35
Power cycle . . . . .	35
4 Connecting hosts . . . . .	37
Host system requirements . . . . .	37

Connecting the enclosure to data hosts . . . . .	37
SAS host ports . . . . .	37
Connecting direct attach configurations . . . . .	38
Single controller configuration . . . . .	38
One server/one HBA/single path . . . . .	38
Dual controller configurations . . . . .	38
One server/one HBA/dual path . . . . .	38
Two servers/one HBA per server/dual path . . . . .	38
Four servers/one HBA per server/dual path . . . . .	39
Connecting remote management hosts . . . . .	39
Updating firmware . . . . .	39
<b>5 Connecting to the controller CLI port . . . . .</b>	<b>41</b>
Device description . . . . .	41
Preparing a Linux computer before cabling to the CLI port . . . . .	41
Downloading a device driver for Windows computers . . . . .	41
Obtaining IP values . . . . .	41
Using the MSA Device Discovery Tool to discover controller's IP addresses . . . . .	41
Setting network port IP addresses using DHCP . . . . .	42
Setting network port IP addresses using the CLI port and cable . . . . .	42
<b>6 Basic operation . . . . .</b>	<b>45</b>
Accessing SMU . . . . .	45
Configuring and provisioning the storage system . . . . .	45
<b>7 Troubleshooting . . . . .</b>	<b>47</b>
CLI port connection . . . . .	47
Fault isolation methodology . . . . .	47
Gather fault information . . . . .	47
Determine where the fault is occurring . . . . .	47
Review the event logs . . . . .	47
Isolate the fault . . . . .	47
If the enclosure does not initialize . . . . .	48
Correcting enclosure IDs . . . . .	48
Diagnostic steps . . . . .	48
Is the front panel Fault LED amber? . . . . .	48
Is the controller back panel OK LED off? . . . . .	49
Is the controller back panel Fault/Service Required LED amber? . . . . .	49
Are both disk drive module LEDs off (Online/Activity and Fault/UID)? . . . . .	49
Is the disk drive module Fault/UID LED blinking amber? . . . . .	49
Is a connected host port's Host Link Status LED off? . . . . .	50
Is a connected port's Expansion Port Status LED off? . . . . .	50
Is a connected port's Network Port Link Status LED off? . . . . .	50
Is the power supply's Input Power Source LED off? . . . . .	51
Is the power supply's Voltage/Fan Fault/Service Required LED amber? . . . . .	51
Controller failure in a single-controller configuration . . . . .	51
If the controller has failed or does not start, is the Cache Status LED on/blinking? . . . . .	52
Transporting cache . . . . .	52
Isolating a host-side connection fault . . . . .	52
Host-side connection troubleshooting featuring SAS host interface ports . . . . .	52
Isolating a controller module expansion port connection fault . . . . .	53
Resolving voltage and temperature warnings . . . . .	54
Sensor locations . . . . .	54
Power supply sensors . . . . .	54
Cooling fan sensors . . . . .	54
Temperature sensors . . . . .	55
Power supply module voltage sensors . . . . .	55
<b>A LED descriptions . . . . .</b>	<b>57</b>
Front panel LEDs . . . . .	57

Disk drive LEDs . . . . .	58
Rear panel LEDs . . . . .	59
P2000 G3 SAS MSA System SFF and P2000 G3 SAS MSA System LFF . . . . .	59
D2700 6Gb drive enclosure . . . . .	61
P2000 6Gb 3.5" 12-drive enclosure . . . . .	61
MSA70 3Gb drive enclosure . . . . .	61
MSA2000 3Gb 3.5" 12-drive enclosure . . . . .	62
Power supply LEDs . . . . .	63
<b>B Environmental requirements and specifications . . . . .</b>	<b>65</b>
Safety requirements . . . . .	65
Site requirements and guidelines . . . . .	65
Site wiring and AC power requirements . . . . .	65
Site wiring and DC power requirements . . . . .	65
Weight and placement guidelines . . . . .	66
Electrical guidelines . . . . .	66
Ventilation requirements . . . . .	66
Cabling requirements . . . . .	66
Management host requirements . . . . .	66
Physical requirements . . . . .	67
Environmental requirements . . . . .	68
Electrical requirements . . . . .	68
Site wiring and power requirements . . . . .	68
Power cord requirements . . . . .	69
<b>C Electrostatic discharge . . . . .</b>	<b>71</b>
Preventing electrostatic discharge . . . . .	71
Grounding methods to prevent electrostatic discharge . . . . .	71
<b>Index . . . . .</b>	<b>73</b>



---

## Figures

1	P2000 G3 MSA System component connection combinations . . . . .	25
2	Cabling connections between P2000 G3 MSA System controllers and P2000 6Gb drive enclosures . .	28
3	Cabling connections between P2000 G3 controllers and D2700 6Gb drive enclosures . . . . .	28
4	Cabling connections between P2000 G3 controllers and MSA2000 3Gb drive enclosures . . . . .	28
5	Cabling connections between P2000 G3 controllers and an MSA70 3Gb drive enclosure . . . . .	29
6	Fault-tolerant cabling: P2000 G3 controllers and P2000 6Gb drive enclosures . . . . .	29
7	Cabling connections between P2000 G3 controllers and D2700 6Gb drive enclosures . . . . .	30
8	Fault-tolerant cabling: P2000 G3 controllers and MSA2000 3Gb drive enclosures . . . . .	31
9	Fault-tolerant cabling: P2000 G3 controllers and MSA70 3Gb drive enclosures . . . . .	31
10	Cabling connections between dual controllers and drive enclosures of mixed type . . . . .	32
11	AC PSU . . . . .	33
12	DC PSU and AC PSU with power switch . . . . .	34
13	DC Power cable featuring sectioned D-shell and lug connectors . . . . .	35
14	Connecting a USB cable to the CLI port . . . . .	43





---

# Tables

1	Document conventions	12
2	Installation checklist	23
3	SAS expansion cable requirements: controller module to expansion module connection	26
4	SAS expansion cable requirements: expansion module to expansion module connection	27
5	Terminal emulator display settings	43
6	Terminal emulator connection settings	43
7	Power supply sensors	54
8	Cooling fan sensor descriptions	54
9	Controller module temperature sensors	55
10	Power supply temperature sensors	55
11	Voltage sensor descriptions	55
12	LEDs — HP P2000 G3 MSA Systems controller enclosure front panels	57
13	LEDs — Disk drive LEDs	58
14	LEDs — Disk drive combinations	58
15	LEDs — HP P2000 G3 SAS MSA System LFF and SFF rear panel	59
16	LEDs — HP P2000 6Gb rear panel	61
17	LEDs — HP MSA2000 3Gb rear panel	62
18	LEDs — HP P2000 G3 MSA System power supply units — rear panel	63
19	Rackmount enclosure dimensions	67
20	Rackmount enclosure weights	67
21	Operating environmental specifications	68
22	Non-operating environmental specifications	68



---

# About this guide

This guide provides information about hardware setup for the HP P2000 G3 SAS MSA System controller enclosures.

## Intended audience

This guide is intended for storage system administrators.

## Prerequisites

Prerequisites for installing and using this product include knowledge of:

- Servers and computer networks
- Network administration
- Storage system installation and configuration
- Storage area network (SAN) management and direct attach storage (DAS)
- Relevant protocols:
  - Serial Attached SCSI (SAS)
  - Ethernet

## Related documentation

In addition to this guide, please refer to online help and the following documents for this product:

- HP MSA System Racking Instructions
- HP P2000 G3 MSA Systems Installation Instructions
- HP P2000 G3 MSA System Cable Configuration Guide
- HP P2000 G3 MSA System SMU Reference Guide
- HP P2000 G3 MSA System CLI Reference Guide
- HP P2000 G3 MSA System Event Descriptions Reference Guide


You can find these documents from the Manuals page of the HP Business Support Center website:  
<http://www.hp.com/support/manuals>

# Document conventions and symbols

**Table 1** Document conventions

Convention	Element
Medium blue text: <a href="#">Figure 1</a>	Cross-reference links and e-mail addresses
Medium blue, underlined text ( <a href="http://www.hp.com">http://www.hp.com</a> )	Web site addresses
<b>Bold font</b>	<ul style="list-style-type: none"><li>• Key names</li><li>• Text typed into a GUI element, such as into a box</li><li>• GUI elements that are clicked or selected, such as menu and list items, buttons, and check boxes</li></ul>
<i>Italics font</i>	Text emphasis
Monospace font	<ul style="list-style-type: none"><li>• File and directory names</li><li>• System output</li><li>• Code</li><li>• Text typed at the command-line</li></ul>
<i>Monospace, italic font</i>	<ul style="list-style-type: none"><li>• Code variables</li><li>• Command-line variables</li></ul>
<b>Monospace, bold font</b>	Emphasis of file and directory names, system output, code, and text typed at the command-line

---

 **WARNING!** Indicates that failure to follow directions could result in bodily harm or death.

---

---

 **CAUTION:** Indicates that failure to follow directions could result in damage to equipment or data.


---

---

 **IMPORTANT:** Provides clarifying information or specific instructions.

---

---

 **NOTE:** Provides additional information.

---

---

 **TIP:** Provides helpful hints and shortcuts.

---

## Rack stability

---

⚠ **WARNING!** To reduce the risk of personal injury or damage to equipment:

- Extend leveling jacks to the floor.
  - Ensure that the full weight of the rack rests on the leveling jacks.
  - Install stabilizing feet on the rack.
  - In multiple-rack installations, secure racks together.
  - Extend only one rack component at a time. Racks may become unstable if more than one component is extended.
- 

## HP technical support

Telephone numbers for worldwide technical support are listed on the HP support web site:

<http://www.hp.com/support>.

Collect the following information before calling:

- Technical support registration number (if applicable)
- Product serial numbers
- Product model names and numbers
- Applicable error messages
- Operating system type and revision level
- Detailed, specific questions

For continuous quality improvement, calls may be recorded or monitored.

## Customer self repair

HP customer self repair (CSR) programs allow you to repair your storage product. If a CSR part needs replacing, HP ships the part directly to you so that you can install it at your convenience. Some parts do not qualify for CSR. Your HP-authorized service provider will determine whether a repair can be accomplished by CSR.

For more information about CSR, contact your local service provider. For North America, see the CSR website:

<http://www.hp.com/go/selfrepair>

## Product warranties

For information about HP storage product warranties, see the warranty information website:

<http://www.hp.com/go/storagewarranty>

## Subscription service

HP strongly recommends that customers sign up online using the Subscriber's choice web site:

<http://www.hp.com/go/e-updates>.

- Subscribing to this service provides you with e-mail updates on the latest product enhancements, newest versions of drivers, and firmware documentation updates as well as instant access to numerous other product resources.
- After signing up, you can quickly locate your products by selecting **Business support** and then **Storage** under Product Category.

## HP websites

For additional information, see the following HP websites:

- <http://www.hp.com>
- <http://www.hp.com/go/storage>
- [http://www.hp.com/service\\_locator](http://www.hp.com/service_locator)
- <http://www.hp.com/support/manuals>
- <http://www.hp.com/support/downloads>
- <http://www.hp.com/storage/whitepapers>
- <http://www.hp.com/go/p2000>

## Documentation feedback

HP welcomes your feedback.

To make comments and suggestions about product documentation, please send a message to [storagedocs.feedback@hp.com](mailto:storagedocs.feedback@hp.com). All submissions become the property of HP.

---


# 1 Overview

The HP P2000 G3 SAS MSA System is a high-performance storage solution combining outstanding performance with high reliability, availability, flexibility, and manageability.

## Features and benefits

Product features and supported options are subject to change. Online documentation describes the latest product and product family characteristics, including currently supported features, options, technical specifications, configuration data, related optional software, and product warranty information.

---

 **NOTE:** Check the Quickspecs for a complete list of supported servers, operating systems, disk drives, and options. Quickspecs can be found from your HP MSA products page at <http://www.hp.com/go/p2000>. Quickspecs links are located on the right.

---

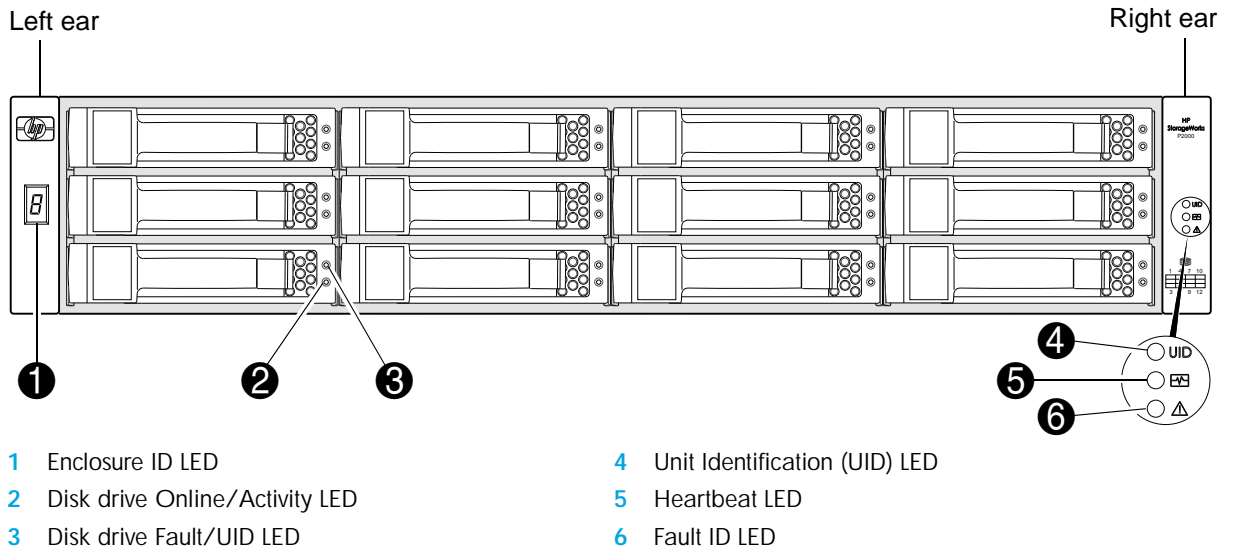




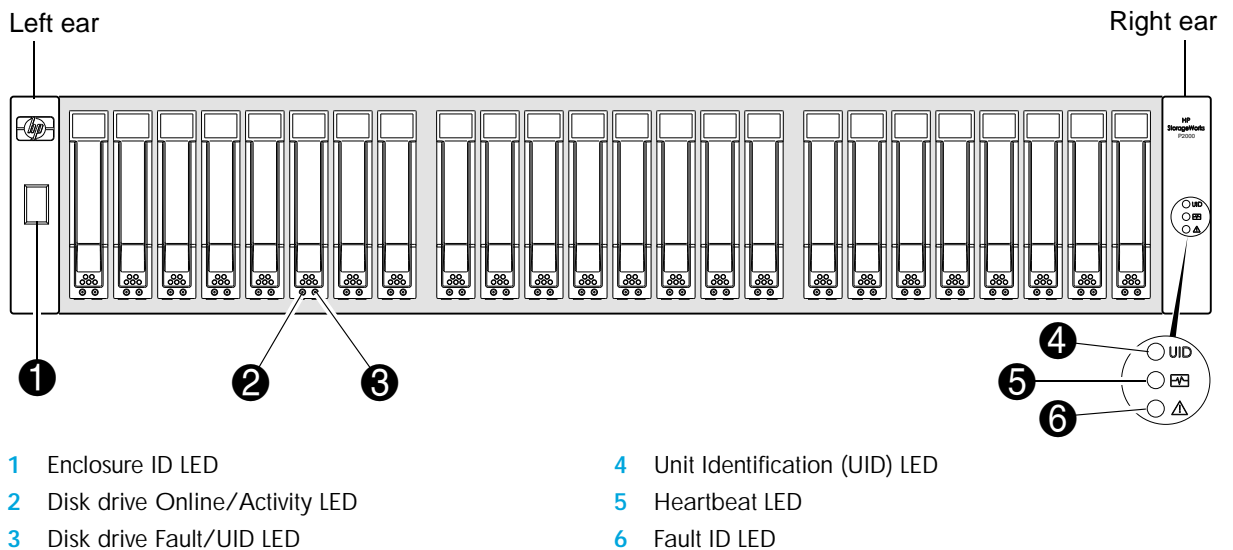
## 2 Components

### Front panel components

#### P2000 G3 SAS MSA System LFF

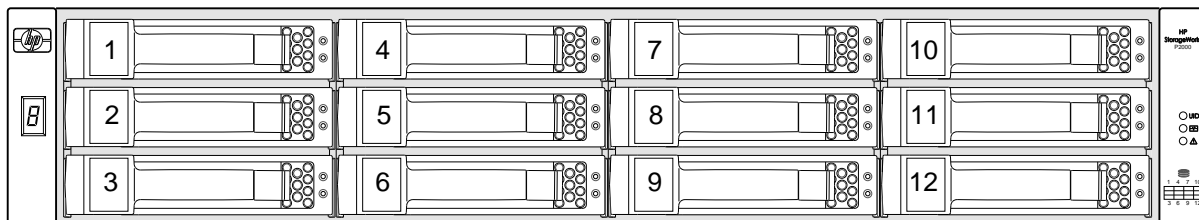


#### P2000 G3 SAS MSA System SFF

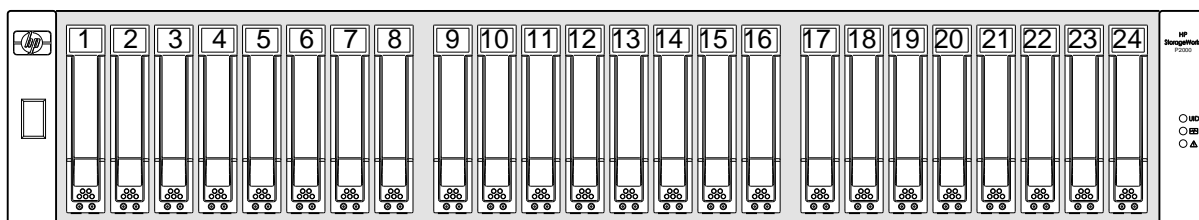


# Disk drive bay numbers

## P2000 G3 SAS MSA System LFF



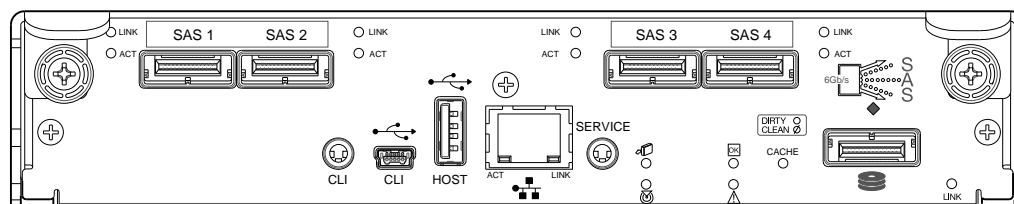
## P2000 G3 SAS MSA System SFF



# Rear panel view — controller module

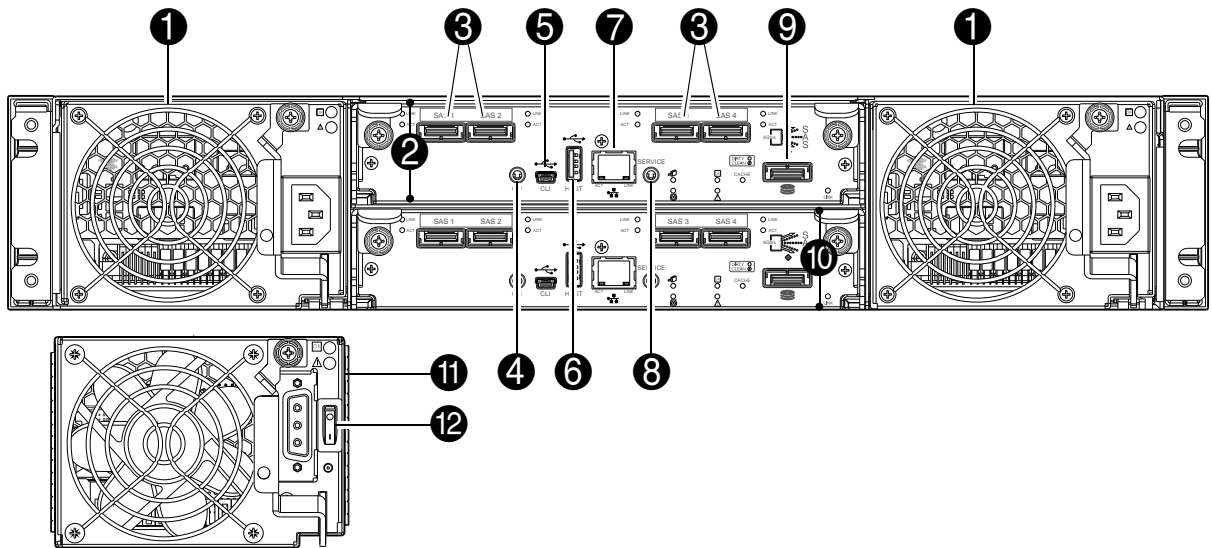
The P2000 G3 MSA System controller module shown below is not proportionately sized relative to preceding controller enclosure views. The controller module face plate is enlarged to show relevant detail.

## P2000 G3 SAS MSA System controller module face plate



## Rear panel components

### P2000 G3 SAS MSA System SFF and P2000 G3 SAS MSA System LFF



- |  |   |
|--|---|
| 1 AC Power supplies                          | 7 Network port                                  |
| 2 Controller module A                        | 8 Service port (used by service personnel only) |
| 3 Host interface ports (mini-SAS)            | 9 SAS expansion port                            |
| 4 Reserved for future use                    | 10 Controller module B                          |
| 5 CLI port (USB - Type B)                    | 11 DC Power supply (2) — (DC model only)        |
| 6 USB - Type A port: reserved for future use | 12 DC Power switch                              |

**IMPORTANT:** See [Connecting to the controller CLI port](#) for information on enabling the controller enclosure's USB Type B CLI port.

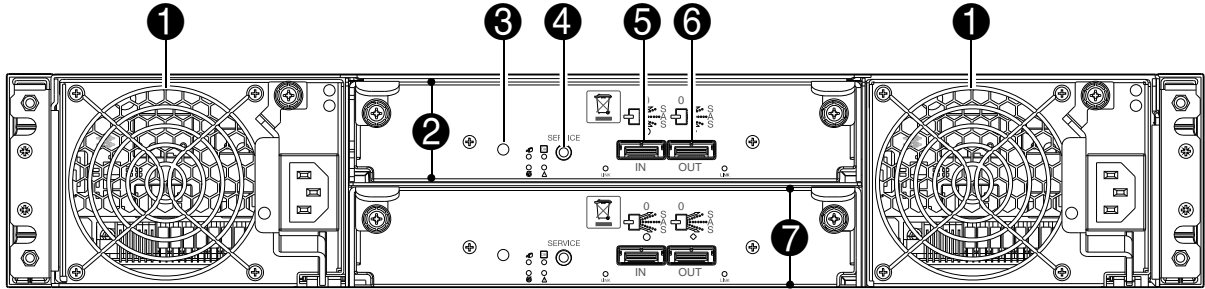
*Drive enclosures* attach to the controller enclosure for the purpose of expanding storage capacity. Drive enclosures supported by the P2000 G3 MSA System controllers are described in the following sections. The 3Gb drive enclosures supported by the newer controller enclosures are listed for customers upgrading existing legacy systems.

**NOTE:** For optimal performance, 6Gb P2000 G3 MSA System controller enclosures should be cabled to 6Gb P2000 G3 MSA System drive enclosures when expanding storage capacity.

## D2700 6Gb drive enclosure

P2000 G3 MSA System controllers support D2700 6Gb drive enclosures. For information about P2000 G3 MSA System products, visit <http://www.hp.com/go/p2000>. Select **Related products**, select your drive enclosure, select **Support > HP Support & Drivers** from the right side of the page, select your product name, and select **Manuals**.

## P2000 6Gb 3.5" 12-drive enclosure

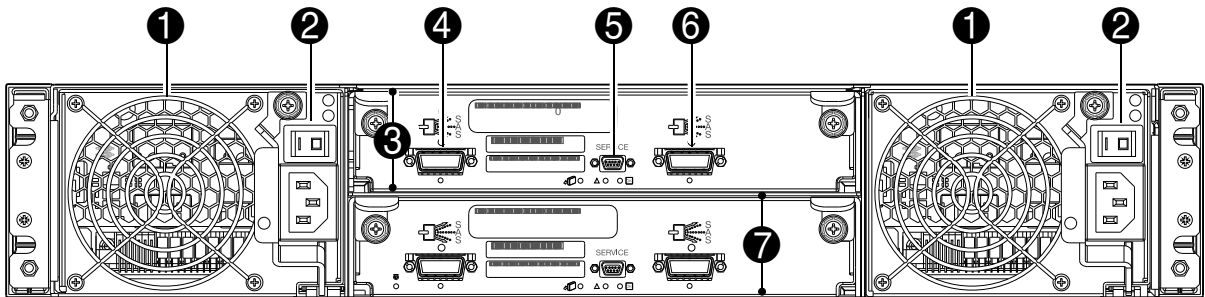


- |   |                |
|---|----------------|
| 1 Power supplies                                | 5 SAS In port  |
| 2 I/O module A                                  | 6 SAS Out port |
| 3 Disabled button (used by engineering only)    | 7 I/O module B |
| 4 Service port (used by service personnel only) |                |

## MSA70 3Gb drive enclosure

P2000 G3 MSA System controllers can also be attached to an MSA70 3Gb drive enclosure that is running firmware version 2.18 or later. For information about the MSA70 3Gb drive enclosure, see the *HP StorageWorks 70 Modular Smart Array Enclosure user guide* located on the *MSA2000 Software Support/Documentation CD* shipped with your product, or accessible from your HP MSA products page at <http://hp.com/support/manuals>.

## MSA2000 3Gb 3.5" 12-drive enclosure




- |   |   |
|---|---|
| 1 Power supplies                                  | 5 Service port (used by service personnel only) |
| 2 Power switches (not applicable to newer models) | 6 SAS Out port                                  |
| 3 I/O module A                                    | 7 I/O module B                                  |
| 4 SAS In port                                     |   |

## Cache

To enable faster data access from disk storage, the following types of caching are performed:

- Write-back or write-through caching. The controller writes user data in the cache memory on the module rather than directly to the drives. Later, when the storage system is either idle or aging — and continuing to receive new I/O data — the controller writes the data to the drive array.
- Read-ahead caching. The controller detects sequential array access, reads ahead into the next sequence of data, and stores the data in the read-ahead cache. Then, if the next read access is for cached data, the controller immediately loads the data into the system memory, avoiding the latency of a disk access.

---

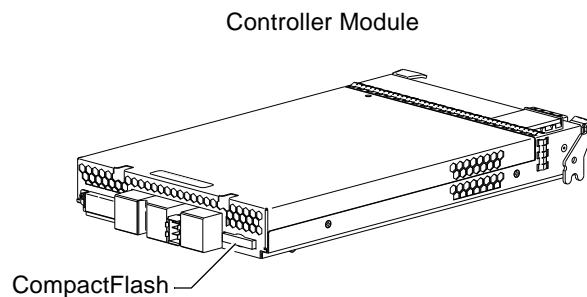
 **NOTE:** See *HP P2000 G3 MSA System SMU Reference Guide* for more information about volume cache options.

---


## Transportable CompactFlash

During a power loss or array controller failure, data stored in cache are saved off to non-volatile memory (CompactFlash). These data are then written to disk after the issue is corrected. To protect against writing incomplete data to disk, the image stored on the CompactFlash is verified before committing to disk.

In single-controller configurations, if the controller has failed or does not start, and the Cache Status LED is on or blinking, the CompactFlash will need to be transported to a replacement controller to recover data not flushed to disk (See [Controller failure in a single-controller configuration](#) on page 51 for more information).




---

 **CAUTION:** To preserve the existing data stored in the CompactFlash, you must transport the CompactFlash from the failed controller to the replacement controller using a procedure outlined in the *HP Controller Module Replacement Instructions*, shipped with the replacement controller. Failure to use this procedure will result in the loss of data stored in the cache module. The CompactFlash must stay with the same enclosure. If the CompactFlash is used/installed in a different enclosure, data loss/data corruption will occur.

---

---

 **IMPORTANT:** In dual controller configurations featuring one healthy peer controller, there is no need to transport a failed controller's cache to a replacement controller because the cache is duplicated between the controllers.

---

## Super-capacitor pack

To protect RAID controller cache in case of power failure, P2000 G3 MSA System controllers are equipped with super-capacitor technology, in conjunction with CompactFlash memory, built into each controller module to provide unlimited cache memory backup time. The super-capacitor pack provides energy for backing up unwritten data in the write cache to the CompactFlash in the event of a power failure. Unwritten data in CompactFlash memory are automatically committed to disk media when power is restored. While the cache is being maintained by the super-capacitor, the Cache Status LED flashes at a rate of 1/10 second on and 9/10 second off.



# 3 Installing the enclosures

## Installation checklist


The following table outlines the steps required to install the enclosures and initially configure the system. To ensure a successful installation, perform the tasks in the order they are presented.

**Table 2** Installation checklist

Step	Task	Where to find procedure
1.	Install the controller enclosure and optional drive enclosures in the rack, and attach ear caps.	See the racking instructions poster.
2.	Connect controller enclosure and LFF/SFF drive enclosures.	See <a href="#">Connecting controller and drive enclosures</a> on page 24.
3.	Connect power cords.	See the installation poster.
4.	Test enclosure connections.	See <a href="#">Testing enclosure connections</a> on page 33.
5.	Install required host software.	See <a href="#">Host system requirements</a> on page 37.
6.	Connect data hosts.	See <a href="#">Connecting the enclosure to data hosts</a> on page 37.
7.	Connect remote management hosts.	See <a href="#">Connecting remote management hosts</a> on page 39.
8.	Obtain IP values and set management port IP properties on the controller enclosure.	See <a href="#">Obtaining IP values</a> on page 41. <sup>1</sup> See <a href="#">Connecting to the controller CLI port</a> ; with Linux and Windows topics.
9.	Perform initial configuration tasks <sup>2</sup> : <ul style="list-style-type: none"><li>• Sign in to the web-based storage management application (SMU).</li><li>• Initially configure and provision the storage system using SMU.</li></ul>	Topics below correspond to bullets at left:  See "Getting Started" in the <i>HP P2000 G3 MSA System SMU Reference Guide</i> .  See "Configuring the System" and "Provisioning the System" topics (SMU reference guide or online help).

<sup>1</sup>MSA Device Discovery Tool, introduced in [Obtaining IP values](#), provides the optimal method for setting network port IP addresses.

<sup>2</sup>SMU is introduced in [Accessing SMU](#) on page 45. See the SMU reference guide or online help for additional information.

 **NOTE:** For optimal performance, 6Gb P2000 G3 MSA System controller enclosures should be cabled to 6Gb P2000 G3 MSA System drive enclosures when expanding storage capacity.

P2000 G3 MSA System controller to drive enclosure cabling is described within this chapter. Cabling of 3Gb drive enclosures to newer 6Gb controllers is addressed for customers upgrading existing legacy systems.

 **NOTE:** For information on NEBS Level 3-compliant carrier-grade enclosures, see [http://www.hp.com/products1/servers/carrier\\_grade/products/cgblades/enclosure](http://www.hp.com/products1/servers/carrier_grade/products/cgblades/enclosure).


## Connecting controller and drive enclosures

P2000 G3 MSA System controller enclosures — available in either 24-drive (2.5") or 12-drive (3.5") chassis — support up to eight enclosures (including the controller enclosure) for storage/expansion, or a maximum of 149 disk drives. You can also configure drive enclosures of mixed type, as shown in [Table 3](#) on page 26.

The firmware supports both straight-through and reverse SAS cabling. Reverse cabling allows any drive enclosure to fail — or be removed — while maintaining access to other enclosures. Fault tolerance and performance requirements determine whether to optimize the configuration for high availability or high performance when cabling. P2000 G3 MSA System controller enclosures support both 3Gbps and 6Gbps internal disk drive speeds, together with 3Gbps and 6Gbps expander link speeds. Controller and expansion modules are identified by <enclosure-ID><controller-ID>. When connecting multiple drive enclosures, use reverse cabling to ensure the highest level of fault tolerance.

For example, [Figure 6](#) on page 29 shows controller module 1A is connected to expansion module 2A, with a chain of connections cascading down (blue). Controller module 1B is connected to the lower expansion module (5B) of the last drive enclosure, with connections moving in the opposite (reverse) direction (green).

---

 **NOTE:** P2000 G3 MSA System controller enclosures support hot-plug replacement of redundant controller modules, fans, power supplies, and I/O modules. Hot-add of drive enclosures is also supported.

---

## Connecting controller and D2700 6Gb drive enclosure

A D2700 6Gb drive enclosure, supporting 6Gb internal disk drive and expander link speeds, can be attached to a P2000 G3 SAS MSA System LFF or P2000 G3 SAS MSA System SFF controller enclosure using supported mini-SAS to mini-SAS cables of 0.5m to 2m length (see [Figure 3](#) on page 28).

## Connecting controller and P2000 6Gb 3.5" 12-drive enclosure

A P2000 6Gb 3.5" 12-drive enclosure, supporting 6Gb internal disk drive and expander link speeds, can be attached to a P2000 G3 SAS MSA System LFF or P2000 G3 SAS MSA System SFF controller enclosure using supported mini-SAS to mini-SAS cables of 0.5m to 2m length (see [Figure 2](#) on page 28).

## Connecting controller and MSA70 3Gb drive enclosure

P2000 G3 MSA System controllers support MSA70 3Gb drive enclosures running firmware version 2.18 or later.

For information about the MSA70 3Gb drive enclosure, including detailed steps to upgrade the firmware, see the *HP StorageWorks 70 Modular Smart Array Enclosure User Guide* located on the *MSA2000 Software Support/Documentation CD* shipped with your product, or at <http://hp.com/support/manuals>.


If you connect a 3Gb drive enclosure to a 6Gb controller enclosure, data throughput occurs at the drive enclosure's 3Gb data rate (see [Figure 5](#) on page 29).

Diagrams within this document use IOM (I/O Module; also referred to as *expansion module*).

## Connecting controller and MSA2000 3Gb 3.5" 12-drive enclosure

Connecting an MSA2000 3.5" 12-drive enclosure to a P2000 G3 SAS MSA System LFF or P2000 G3 SAS MSA System SFF requires supported mini-SAS to SAS cables. If you connect a 3Gb drive enclosure to a 6Gb controller enclosure, data throughput occurs at the drive enclosure's 3Gbps data rate (see [Figure 4](#) on page 28).

---

 **IMPORTANT:** Adding a fourth drive enclosure may require a separate, longer cable. For a current list of supported cables, check the MSA2000 G2 Quickspecs located on the HP MSA products page at <http://www.hp.com/go/msa>. Select your product. Quickspecs links are located on the right.

---



## Connecting controller and mixed drive enclosures

P2000 G3 MSA System controller modules support cabling of 3Gb and 6Gb SAS link-rate LFF and SFF expansion modules — in mixed fashion — as shown in [Figure 10](#) on page 32, and as further described in [Additional cabling considerations](#) (below); the *HP P2000 G3 MSA System Cable Configuration Guide*; and HP white papers (listed on the following page).

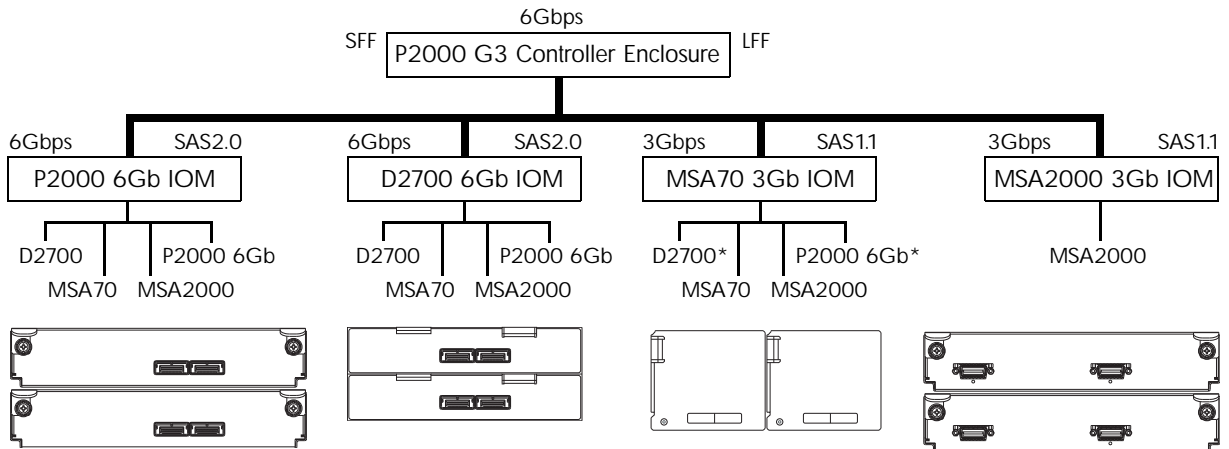
## Additional cable requirements for drive enclosures

### **IMPORTANT:**

- When installing SAS cables, use only supported SAS 4x cables with connectors supporting your application (6Gb, 3Gb, or both).
- Mini-SAS to mini-SAS 0.5m cables are provided with each of the following drive enclosures (one per expansion module): P2000 6Gb 3.5" 12-drive enclosure and D2700 6Gb drive enclosure.
- If additional or longer cables are required, they must be ordered separately (see relevant MSA2000 G2 Quickspecs or P2000 G3 Quickspecs for your products).
- The maximum cable length allowed in any configuration is 2m.
- When expanding storage capacity, a maximum of eight enclosures — including the controller enclosure — *or* one hundred forty nine (149) disk drives are allowed in the array.

## P2000 G3 MSA System cable requirements


[Figure 1](#) (below) and [Table 4](#) on page 27 jointly describe cabling requirements and connection combinations for P2000 G3 MSA System components. Components are labeled with back-end SAS data rates and other relevant attributes. Simplified IOM face plates are shown.



\*Cabling a 6Gbps drive enclosure behind the MSA70 3Gb drive enclosure will adjust its link-rate speed to 3Gbps.

**Figure 1** P2000 G3 MSA System component connection combinations

[Table 3](#) below provides SAS cable requirements for connection combinations between MSA controller and expansion modules. [Table 4](#) on page 27 provides details for cabling expansion modules.


 **NOTE:** Check Quickspecs addressing your respective product with regard to cabling. Quickspecs can be found from your HP MSA products page <http://www.hp.com/go/p2000>. Quickspecs links are located on the right.

**Table 3** SAS expansion cable requirements: controller module to expansion module connection


Product model-to-model storage component attachment		SAS Expansion (In/Out) cable data		
Controller module	Drive enclosure	Type	Length	Connectors
P2000 G3 SAS MSA SFF and P2000 G3 SAS MSA LFF	P2000 6Gb drive enclosure	mini-SAS to mini-SAS <sup>1</sup>	0.5m	6Gbps
	D2700 6Gb drive enclosure	mini-SAS to mini-SAS <sup>1</sup>	0.5m	6Gbps
	MSA2000 3Gb drive enclosure	mini-SAS to SAS <sup>2</sup>	0.5m, 1m, 2m	6Gbps 3Gbps
	MSA70 3Gb drive enclosure	mini-SAS to mini-SAS <sup>1</sup>	0.5m	6Gbps 3Gbps


<sup>1</sup>One 0.5m cable is required per controller module to I/O (expansion) module connection.

<sup>2</sup>One 0.5m, 1.0m, or 2.0m cable is required per controller module to expansion module connection.

 **NOTE:** Additional cabling notes:

- Cables required, if not included, must be separately purchased.
- When adding more than two drive enclosures, you may need to purchase additional 1m or 2m cables:
  - Spanning 3, 4, or 5 drive enclosures requires 1m cables.
  - Spanning 6 or 7 drive enclosures requires 2m cables.
- See [Table 4](#) on page 27 and related footnotes for cabling multiple drive enclosures.

 **IMPORTANT:** Controller modules within the enclosure must be of the same type. Do **not** install an HP P2000 G3 FC MSA System and HP P2000 G3 SAS MSA System controller module in the same chassis.

 **IMPORTANT:** Connecting 3Gb and 6Gb drive enclosures limits performance and should be done only when upgrading legacy product configurations.

For additional information concerning cabling of P2000 G3 MSA System controllers and MSA2000 G1 or G2 drive enclosures, visit your HP MSA products page <http://www.hp.com/go/p2000>. From the HP MSA products page, browse for the following reference documents:

- *HP P2000 G3 MSA Best practices*
- *HP MSA2000 Family Best practices*
- *Upgrading the HP MSA2000 G2 to the P2000 G3 MSA*
- *Upgrading the HP MSA2000 G1 to the P2000 G3 MSA*

## Additional cabling considerations

P2000 G3 MSA System controller enclosures (both LFF and SFF models) support each of the drive enclosures listed above. However, when cabling supported drive enclosures of mixed type, consider the following factors regarding components equipped with SAS2.0 and SAS1.1 expanders (labeled in [Figure 1](#) on page 25):

- P2000 G3 MSA System controller enclosures support 6Gb and 3Gb drive enclosures.
- To avoid performance limitations in a mixed-type drive enclosure environment, cable 3Gb drive enclosures after 6Gb drive enclosures as shown in [Figure 10](#) on page 32. Do not mix 6Gb and 3Gb disk drives in the same enclosure.
- Performance will be limited if a 3Gb drive enclosure is cabled *before* a 6Gb drive enclosure — and cannot be avoided — if reverse cabled. A 6Gb drive enclosure will perform at a 3Gbps data transfer rate if cabled after a 3Gb drive enclosure.

- If used together with mixed drive enclosures, an MSA2000 3Gb drive enclosure should be cabled after other supported models, using straight-through cabling.


**Table 4** SAS expansion cable requirements: expansion module to expansion module connection

Product model-to-model storage component attachment		SAS expansion (In/Out) cable data		
Expansion module	Expansion module	Type	Length	Connectors
<b>P2000 6Gb drive enclosure</b>	P2000 6Gb drive enclosure	mini-SAS to mini-SAS <sup>1</sup>	0.5m	6Gbps
	D2700 6Gb drive enclosure	mini-SAS to mini-SAS <sup>1</sup>	0.5m	6Gbps
	MSA70 3Gb drive enclosure	mini-SAS to mini-SAS <sup>1,2</sup>	0.5m	6Gbps 3Gbps
	MSA2000 3Gb drive enclosure	mini-SAS to SAS <sup>1,2</sup>	0.6m	6Gbps 3Gbps
<b>D2700 6Gb drive enclosure</b>	D2700 6Gb drive enclosure	mini-SAS to mini-SAS <sup>1</sup>	0.5m	6Gbps
	P2000 6Gb drive enclosure	mini-SAS to mini-SAS <sup>1,2</sup>	0.5m	6Gbps
	MSA2000 3Gb drive enclosure	mini-SAS to SAS <sup>1,2</sup>	0.5m	6Gbps 3Gbps
	MSA70 3Gb drive enclosure	mini-SAS to mini-SAS <sup>1,2</sup>	0.5m	6Gbps 3Gbps
<b>MSA70 3Gb drive enclosure</b>	MSA70 3Gb drive enclosure	mini-SAS to mini-SAS <sup>1</sup>	0.5m	3Gbps
	P2000 6Gb drive enclosure	mini-SAS to mini-SAS <sup>1</sup>	0.5m	3Gbps 6Gbps
	D2700 6Gb drive enclosure	mini-SAS to mini-SAS <sup>1</sup>	0.5m	3Gbps 6Gbps
	MSA2000 3Gb drive enclosure	mini-SAS to SAS <sup>1</sup>	0.6m	3Gbps
<b>MSA2000 3Gb drive enclosure</b>	MSA2000 3Gb drive enclosure	SAS to SAS <sup>3</sup>	0.6m	3Gbps

<sup>1</sup>One 0.5m cable required per I/O module to I/O module connection.

<sup>2</sup>Cables required, if not included, must be separately purchased.

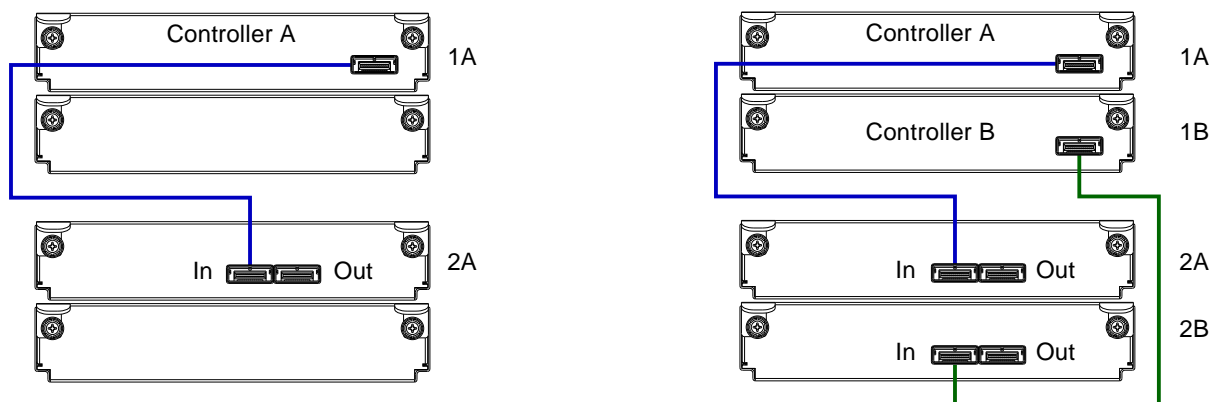
<sup>3</sup>One 0.6m cable required per I/O module to I/O connection.

 **NOTE:** Additional cabling notes:

When adding more than two drive enclosures, you may need to purchase additional 1m or 2m cables:

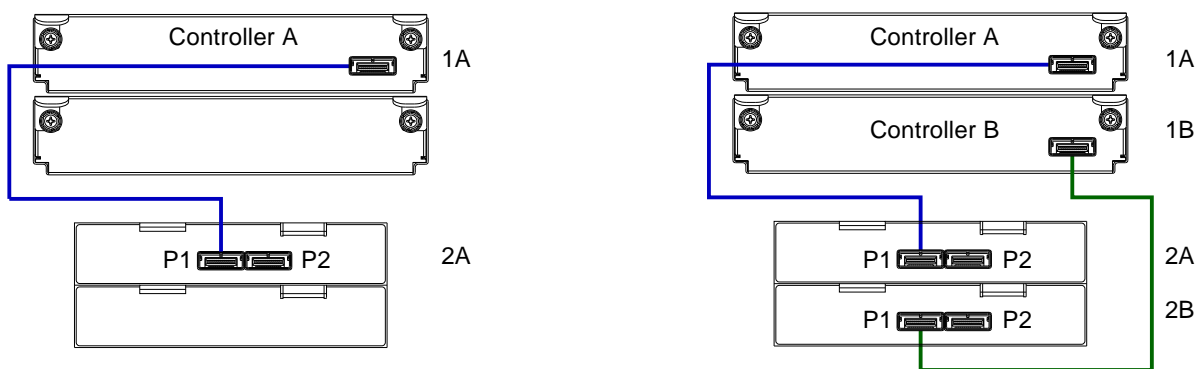
- Spanning 3, 4, or 5 drive enclosures requires 1m cables.
- Spanning 6 or 7 drive enclosures requires 2m cables.

**NOTE:** For clarity, the schematic illustrations of controller and expansion modules shown in this section provide only relevant details such as expansion ports within the module face plate outline. For detailed illustrations showing all components, see [Rear panel components](#) on page 19.

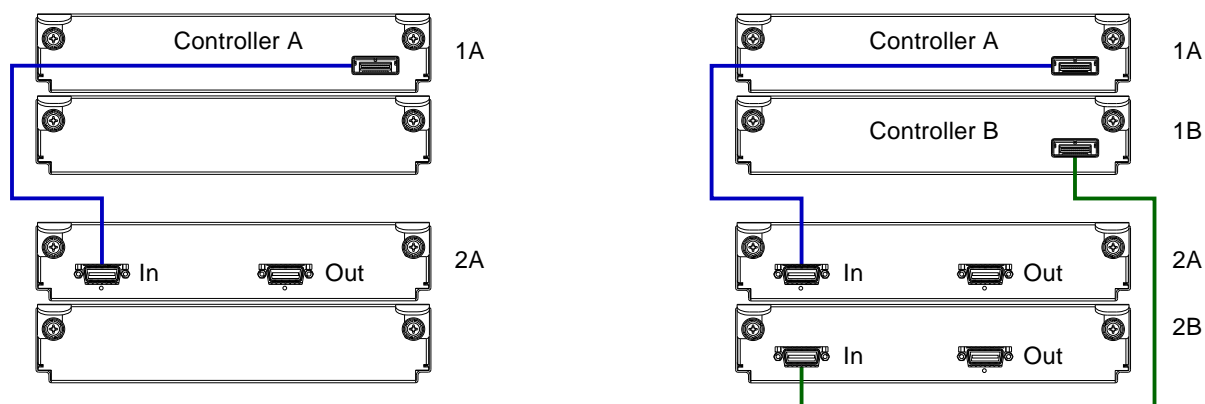


**Figure 2** Cabling connections between P2000 G3 MSA System controllers and P2000 6Gb drive enclosures

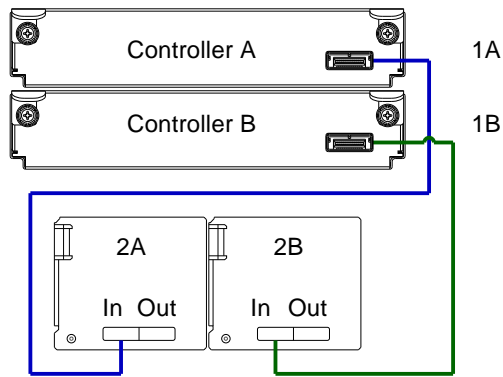
Figures 2 - 4 show a single controller module connected to a single expansion module (illustrations on left), with dual controller modules connected to dual expansion modules (illustrations on right).



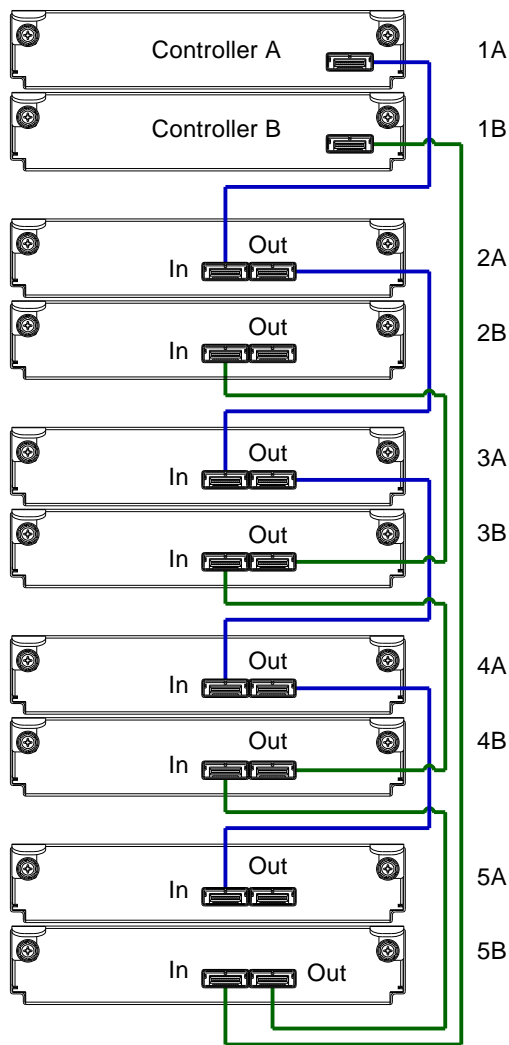
**Figure 3** Cabling connections between P2000 G3 controllers and D2700 6Gb drive enclosures



**Figure 4** Cabling connections between P2000 G3 controllers and MSA2000 3Gb drive enclosures

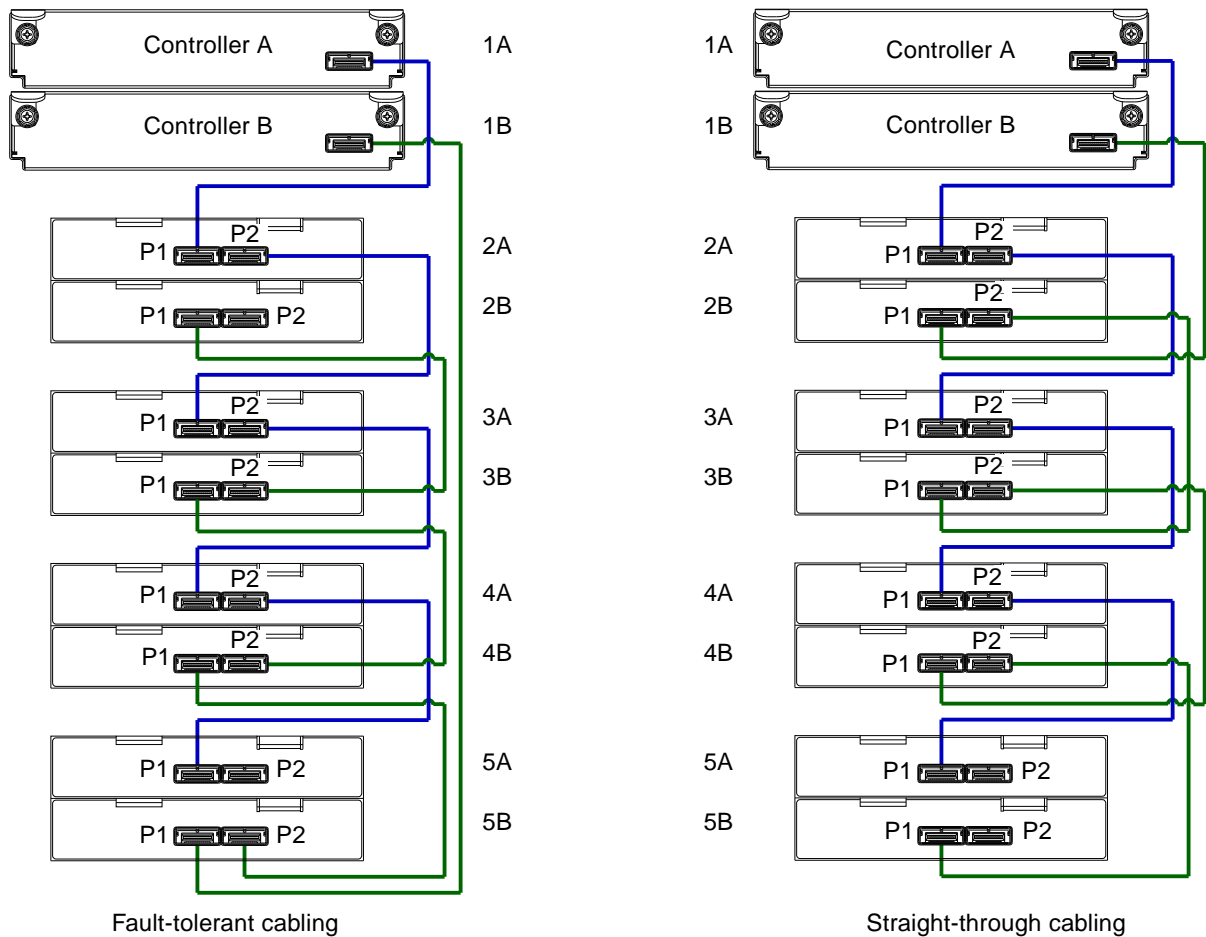


**Figure 5** Cabling connections between P2000 G3 controllers and an MSA70 3Gb drive enclosure  
 The diagram above shows dual-controller modules connected to dual-expansion modules.



**Figure 6** Fault-tolerant cabling: P2000 G3 controllers and P2000 6Gb drive enclosures

The diagram above shows a dual-controller enclosure cabled to P2000 6Gb drive enclosures featuring dual-expansion modules. Controller module 1A is connected to expansion module 2A, with a chain of connections cascading down (blue). Controller module 1B is connected to the lower expansion module (5B), of the last drive enclosure, with connections moving in the opposite direction (green). This logic applies to the fault tolerant cabling diagrams that follow.



**Figure 7** Cabling connections between P2000 G3 controllers and D2700 6Gb drive enclosures

The figure above provides sample diagrams reflecting cabling of P2000 G3 controller enclosures and D2700 6Gb drive enclosures.

The diagram at left shows a dual-controller enclosure cabled to D2700 6Gb drive enclosures featuring dual-expansion modules. Controller module 1A is connected to expansion module 2A, with a chain of connections cascading down (blue). Controller module 1B is connected to the lower expansion module (5B), of the last drive enclosure, with connections moving in the opposite direction (green).

The diagram at right shows the same storage components connected using straight-through cabling.

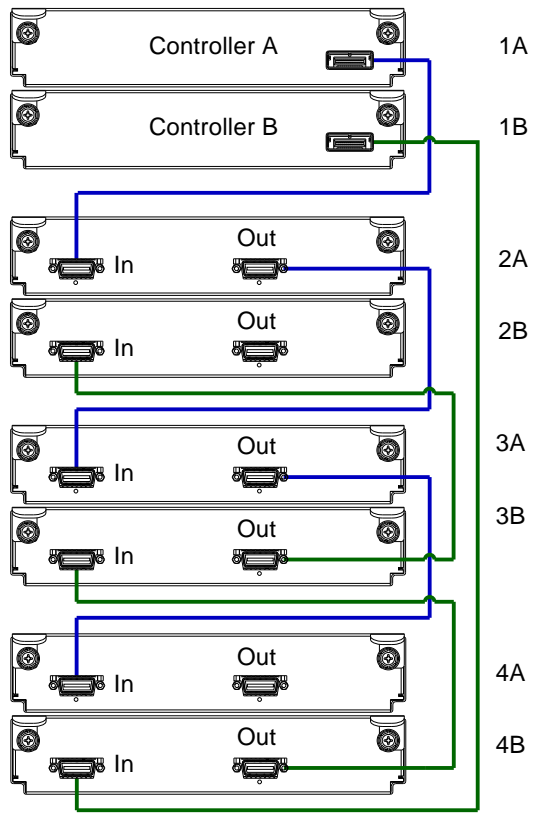


Figure 8 Fault-tolerant cabling: P2000 G3 controllers and MSA2000 3Gb drive enclosures

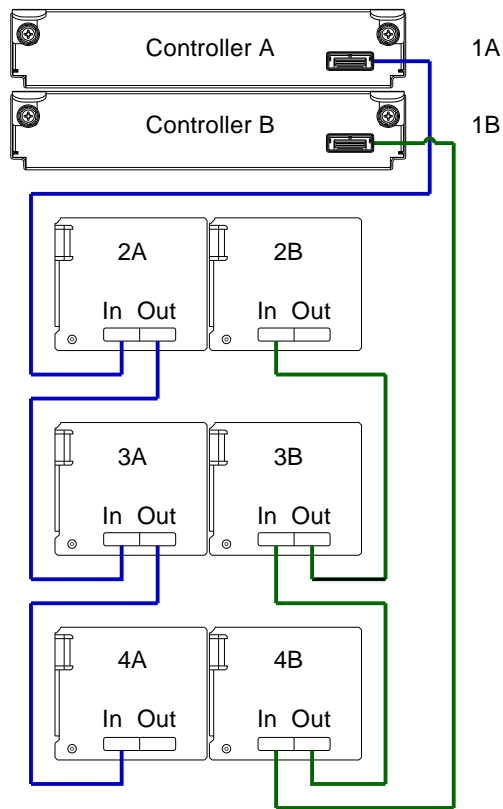
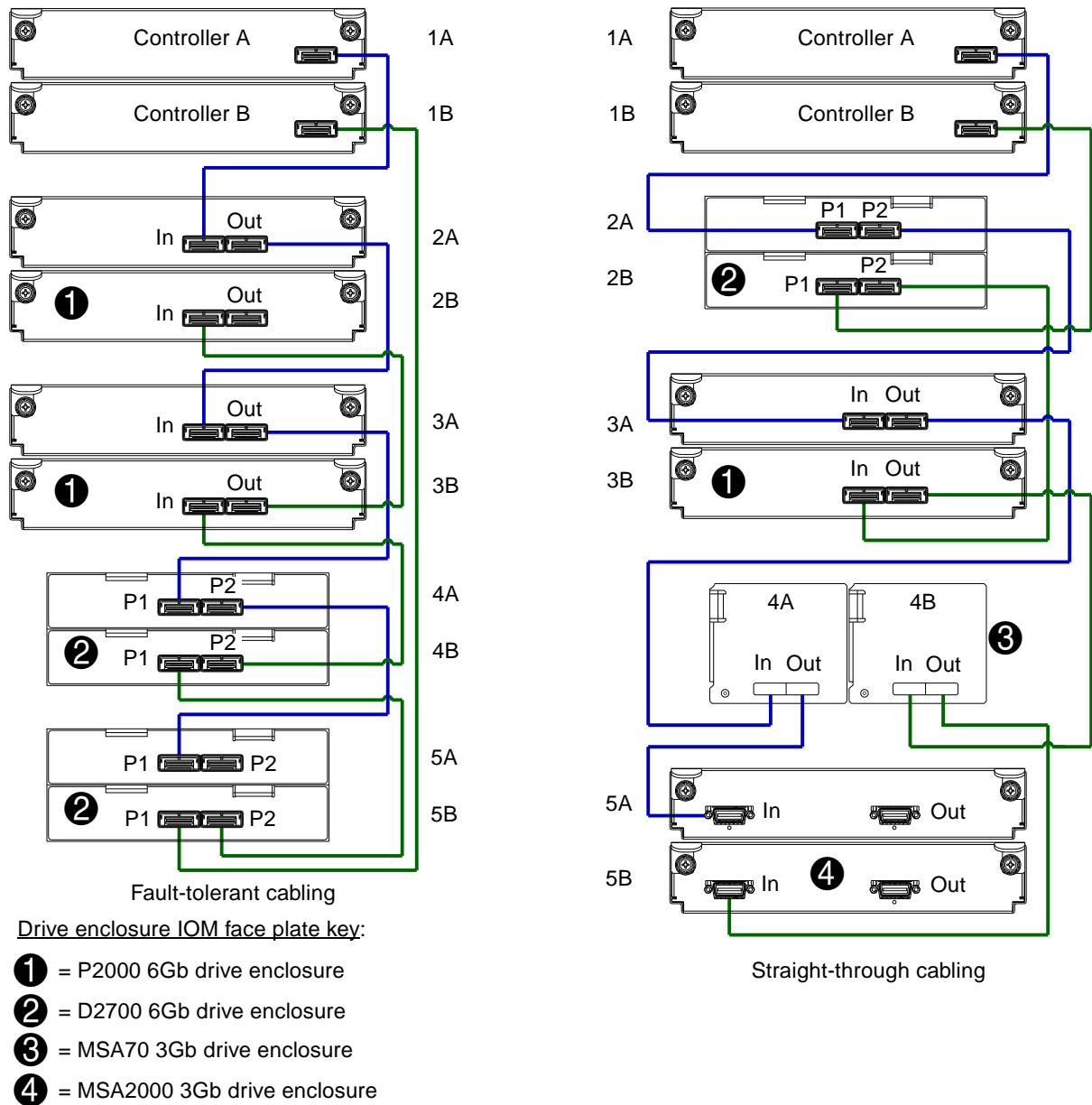


Figure 9 Fault-tolerant cabling: P2000 G3 controllers and MSA70 3Gb drive enclosures



**Figure 10** Cabling connections between dual controllers and drive enclosures of mixed type

The figure above shows a sample fault-tolerant cabling scenario on left, and a straight-through cabling scenario on right. Both diagrams show drive enclosures of mixed type. Do not mix SAS1.1 and SAS2.0 expanders, except as described in [Additional cabling considerations](#) on page 26. Avoid mixing them except when upgrading legacy systems.


In the illustration on the left, note that the D2700 6Gb drive enclosures could alternatively be cabled before the P2000 6Gb drive enclosures. The illustration at the right shows a D2700 6Gb drive enclosure before a P2000 6Gb drive enclosure, MSA70 3Gb drive enclosure, and MSA2000 3Gb drive enclosure. Note that the MSA2000 3Gb drive enclosure is cabled after the other drive enclosures, using straight-through cabling.

Although 6Gb drive enclosures can be cabled after an MSA70 3Gb drive enclosure, performance of the 6Gb devices will be limited to 3Gb.

**IMPORTANT:** For comprehensive configuration options and associated illustrations, refer to the *HP P2000 G3 MSA System Cable Configuration Guide*.




## Testing enclosure connections

 **NOTE:** Once the enclosures' power-on sequence succeeds, the storage system is ready to be connected to hosts, as described in [Connecting the enclosure to data hosts](#) on page 37.

## Powering on/powering off

Before powering on the enclosure for the first time:

- Install all disk drives in the enclosure so the controller can identify and configure them at power-up.
- Connect the cables and power cords to the enclosures as explained in the installation sheet.

 **NOTE:** P2000 G3 controller enclosures and some P2000 G3 drive enclosures do not have power switches. They power on when connected to a power source, and they power off when disconnected.

- Generally, when powering up, make sure to power up the enclosures and associated data host in the following order:

- Drive enclosures *first*


This ensures that disks in the drive enclosure have enough time to completely spin up before being scanned by the controller modules within the controller enclosure.

While enclosures power up, their LEDs blink. After the LEDs stop blinking — if no LEDs on the front and back of the enclosure are amber — the power-on sequence is complete, and no faults have been detected. See [LED descriptions](#) on page 57 for descriptions of LED behavior.

- Controller enclosure *next*

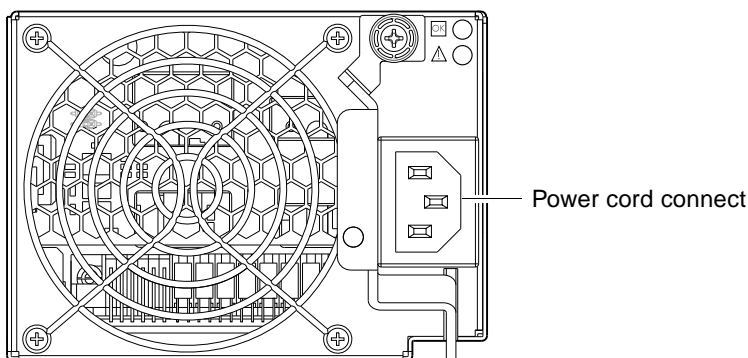
Depending upon the number and type of disks in the system, it may take several minutes for the system to become ready.

- Data host *last* (if powered down for maintenance purposes).

 **TIP:** Generally, when powering off, you will reverse the order of steps used for powering on.

## Power supply

Many controller and expansion enclosures rely on the power cord for power cycling. Connecting the cord from the PSU power cord connector to the appropriate power source facilitates power on; whereas disconnecting the cord from the power source facilitates power off.



**Figure 11** AC PSU

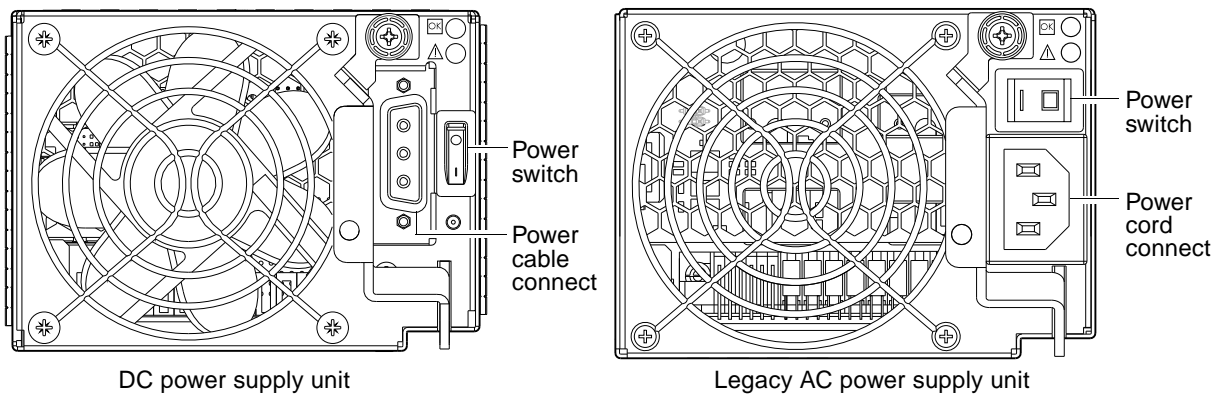
**To power on the system:**

1. Obtain a suitable AC power cord for each AC PSU that will connect to a power source.

2. Plug the power cord into the power cord connector on the back of the drive enclosure (see [Figure 11](#)). Plug the other end of the power cord into the rack power source. Wait several seconds to allow the disks to spin up.  
Repeat this sequence for each PSU within each drive enclosure.
3. Plug the power cord into the power cord connector on the back of the controller enclosure (see [Figure 11](#)). Plug the other end of the power cord into the rack power source.  
Repeat the sequence for the controller enclosure's other PSU.

**To power off the system:**

1. Stop all I/O from hosts to the system.
2. Shut down both controllers using *either* method described below:
  - Use SMU to shut down both controllers, as described in the online help and web-posted *HP P2000 G3 MSA System SMU Reference Guide*.  
Proceed to [step 3](#).
  - Use the command-line interface (CLI) to shut down both controllers, as described in the *HP P2000 G3 MSA System CLI Reference Guide*.
3. Disconnect the power cord's male plug from the power source.
4. Disconnect the power cord's female plug from the power cord connector on the PSU.



**Figure 12** DC PSU and AC PSU with power switch

## Power Cords

**IMPORTANT:** See [Environmental requirements and specifications](#) for additional information.

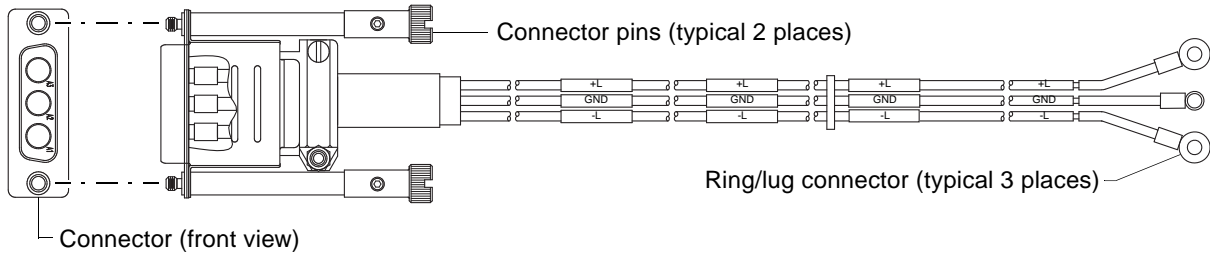
### AC model

Obtain two suitable AC power cords: one for each AC PSU that will connect to a separate power source. See the illustration at right (in [Figure 12](#) on page 34) when performing the following steps:

1. Verify that the enclosure's power switches are in the **Off** position.
2. Identify the power cord connector on the PSU, and locate the target power source.
3. For each PSU, perform the following actions:
  - a. Plug one end of the cord into the power cord connector on the PSU.
  - b. Plug the other end of the power cord into the rack power source.
4. Verify connection of primary power cords from the rack to separate external power sources.  
See [Power cycle](#) on page 35.

## DC model

Locate the two DC power cables provided with your controller enclosure.

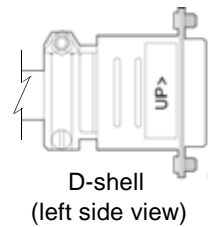


**Figure 13** DC Power cable featuring sectioned D-shell and lug connectors

See [Figure 13](#) and the illustration at left (in [Figure 12](#)) when performing the following steps:

1. Verify that the enclosure's power switches are in the **Off** position.
2. Connect a DC power cable to each DC power supply using the D-shell connector. Use the **UP**> arrow on the connector shell to ensure proper positioning (see adjacent left side view of D-shell connector).
3. Tighten the screws at the top and bottom of the shell, applying a torque between 1.7 N-m (15 in-lb) and 2.3 N-m (20 in-lb), to securely attach the cable to the DC power supply module.
4. To complete the DC connection, secure the other end of each cable wire component of the DC power cable to the target DC power source.

Check the three individual DC cable wire labels before connecting each cable wire lug to its power source. One cable wire is labeled *ground* (GND) and the other two wires are labeled *positive* (+L) and *negative* (-L), respectively (shown in [Figure 13](#) above).



---

△ **CAUTION:** Connecting to a DC power source outside the designated -48V DC nominal range (-36V DC to -72V DC) may damage the enclosure.

---

## Power cycle

### To power on the system:

1. Power up drive enclosure(s).  
Press the power switches at the back of each drive enclosure to the **On** position. Allow several seconds for the disks to spin up.
2. Power up the controller enclosure next.  
Press the power switches at the back of the controller enclosure to the **On** position. Allow several seconds for the disks to spin up.

### To power off the system:

1. Stop all I/O from hosts to the system.
2. Shut down both controllers using either method described below:
  - Use SMU to shut down both controllers, as described in the online help and *HP P2000 G3 MSA System SMU Reference Guide*.  
Proceed to [step 3](#).
  - Use the command-line interface (CLI) to shut down both controllers, as described in the *HP P2000 G3 MSA System CLI Reference Guide*.
3. Press the power switches at the back of the controller enclosure to the **Off** position.
4. Press the power switches at the back of each drive enclosure to the **Off** position.



---


## 4 Connecting hosts

### Host system requirements

Data hosts connected to P2000 G3 MSA System arrays must meet the following requirements:

- Depending on your system configuration, data host operating systems may require that multi-pathing is supported.

---

 **TIP:** See the *HP MSA System VDS and VSS Hardware Providers Installation Guide* and *HP MSA System MPIO DSM Installation Guide* to aid in planning and implementing your MPIO DSM installation.

---

If fault tolerance is required, then multi-pathing software may be required. Host-based multi-path software should be used in any configuration where two logical paths between the host and any storage volume may exist at the same time. This would include most configurations where there are multiple connections to the host or multiple connections between a switch and the storage.

- Use Windows Server MPIO DSM with **Windows Server 2003**. To obtain the MPIO DSM, go to the HP MSA products page at <http://www.hp.com/go/msa>. Select your product and go to **Related Products**.
- Use native Microsoft MPIO DSM support with **Windows Server 2008**. Use either the Server Manager or the command-line interface (mpclaim CLI tool) to perform the installation. Refer to the following web sites for information about using the Windows 2008 native MPIO DSM:  
<http://support.microsoft.com/gp/assistsupport>  
<http://technet.microsoft.com> (search the site for “multipath I/O overview”)
- Use the HP Multi-path Device Mapper for Linux Software with Linux servers. To download the appropriate device mapper multi-path enablement kit for your specific enterprise Linux operating system, go to <http://www.hp.com/go/devicemapper>.
- To prevent **Microsoft Windows 2003** data hosts from displaying the Found New Hardware Wizard when the storage system is discovered, install the SCSI Enclosure Services driver. Download your product’s SCSI Enclosure Services (SES) driver package from <http://www.hp.com/go/msa>. Select your product and go to **Related Products**.

---

 **NOTE:** P2000 Family SCSI Enclosure Services driver is required for Microsoft Windows 2003.

---

### Connecting the enclosure to data hosts

A *host* identifies an external port to which the storage system is attached. Cable connections vary depending on configuration. Common cable configurations are shown in this section. A list of supported configurations resides on the P2000 G3 product site at <http://www.hp.com/go/p2000>. Select **HP Support & Drivers**, select your product, select **Manuals**:

- *HP P2000 G3 MSA Systems Installation Instructions*
- *HP P2000 G3 MSA System Cable Configuration Guide*

These documents provide installation details and describe newly-supported direct connect, switch-connect, and expansion configuration options for P2000 G3 MSA System products.

Any number or combination of LUNs can be shared among a maximum of 64 host ports, provided the total does not exceed 512 LUNs per P2000 G3 storage system (single or dual controller configuration).

### SAS host ports

The P2000 G3 SAS MSA System controller modules use the Serial Attached SCSI (Small Computer System Interface) interface protocol for host port connection, featuring either one or two controller modules. Each controller module provides two dual SFF-8088 mini-SAS host ports supporting data rates up to

6Gb/second per lane — and four lanes per connector — featuring a 1.2 GHz processor with 256 MB memory, and 2GB cache. SAS host ports connect to SAS hosts or switches; they are not used for replication.

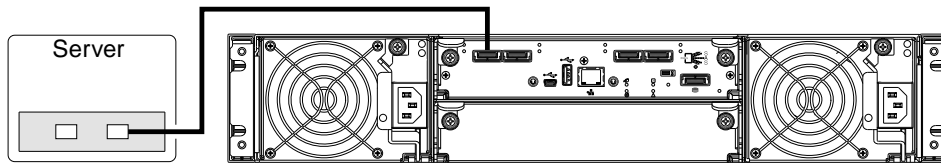
## Connecting direct attach configurations

P2000 G3 SAS MSA System LFF and P2000 G3 SAS MSA System SFF support up to eight direct-connect server connections, four per controller module. Connect appropriate cables from the servers' HBAs to the controller host ports as described below, and shown in the following illustrations.

To connect the P2000 G3 SAS MSA System controller to a server or HBA switch — using the controller's SAS host ports — select SAS cables supporting 3/6Gb data rates that are compatible with the controller module's host port SFF connector.

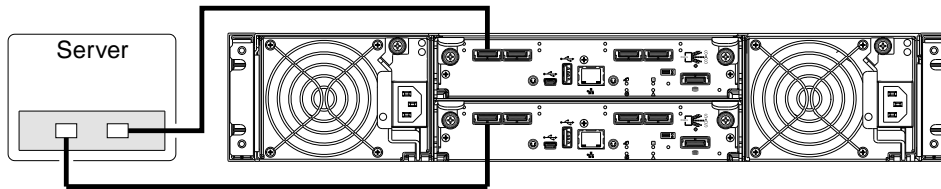
### Single controller configuration

One server/one HBA/single path

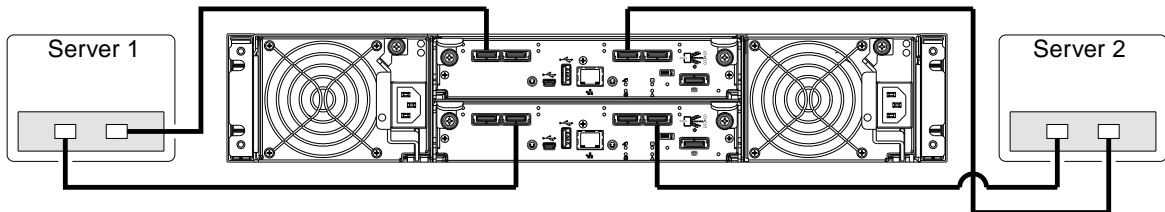


### Dual controller configurations

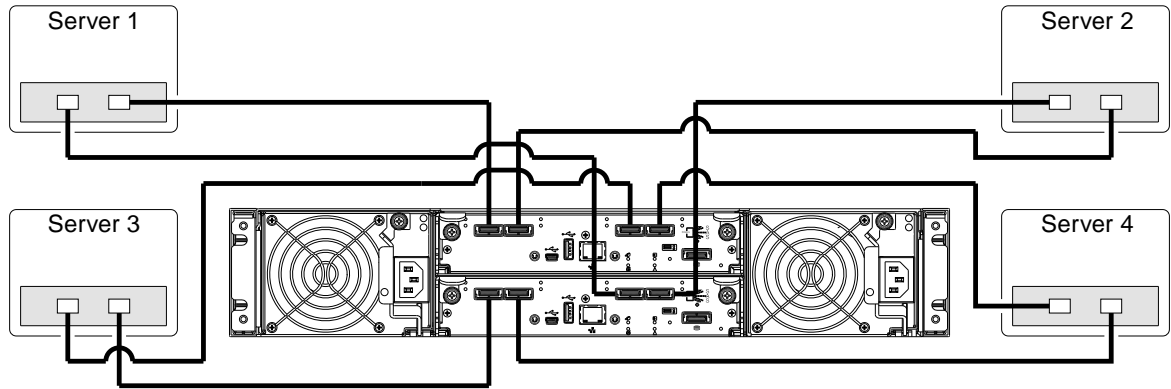
One server/one HBA/dual path



Two servers/one HBA per server/dual path



## Four servers/one HBA per server/dual path




## Connecting remote management hosts

The management host directly manages systems out-of-band over an Ethernet network.

1. Connect an RJ-45 Ethernet cable to the network management port on each P2000 G3 MSA System controller.
2. Connect the other end of each Ethernet cable to a network that your management host can access (preferably on the same subnet).

---


 **NOTE:** Connections to this device must be made with shielded cables – grounded at both ends – with metallic RFI/EMI connector hoods, in order to maintain compliance with FCC Rules and Regulations.

---

## Updating firmware

After installing the hardware and powering on the storage system components for the first time, verify that the controller modules, expansion modules, and disk drives are using the current firmware release. Using SMU, right-click the system in the Configuration View panel, and select **Tools > Update Firmware**. The Update Firmware panel displays the currently installed firmware versions, and enables you to update them.

---

 **NOTE:** To locate and download the latest software and firmware update for your product, go to <http://www.hp.com/go/p2000>. Select **Models** — select your product — select **HP Support & Drivers**, then select **Download drivers and software**.

---





---


## 5 Connecting to the controller CLI port

### Device description

P2000 G3 MSA System controllers feature a new command-line interface (CLI) port used to cable directly to the controller and initially set IP addresses, or perform other configuration tasks. This port differs from G1 and G2 controllers. It employs a mini-USB Type B form factor, and requires a new cable and additional support so that a server or other computer running a Linux or Windows operating system can recognize the controller enclosure as a connected device. Without this support, the computer might not recognize that a new device is connected or might not be able to communicate with it. For Linux computers, no new driver files are needed, but a Linux configuration file must be created or modified.

For Windows computers, a special device driver, `gserial.inf`, must be downloaded from a CD or HP website, and installed on the computer that will be cabled directly to the controller's CLI port.

---

 **NOTE:** Directly cabling to the CLI port is an out-of-band connection because it communicates outside the data paths used to transfer information from a computer or network to the controller enclosure.

---

An in-band connection can also be used to configure a new controller. If used, cabling to the CLI port might not be necessary. The in-band method uses the MSA Device Discovery utility on the *Software Support/Documentation CD* that is included with your system, and is the best way to discover the controller's IP addresses automatically, so that you can use them to log into and manage your controllers using a web browser for SMU, or telnet for the CLI. See [Using the MSA Device Discovery Tool to discover controller's IP addresses](#) for instructions about how to use the MSA Device Discovery Tool over your existing in-band connection to discover controller IP addresses without using the CLI port.

### Preparing a Linux computer before cabling to the CLI port

Although Linux operating systems do not require installation of a device driver, certain parameters must be provided during driver loading to enable recognition of the P2000 G3 MSA System controller enclosures. To load the Linux device driver with the correct parameters, the following command is required:

```
modprobe usbserial vendor=0x210c product=0xa4a7 use_acm=1
```

Optionally, the information can be incorporated into the `/etc/modules.conf` file.

### Downloading a device driver for Windows computers

A Windows USB device driver download is provided for communicating directly with the controller's CLI port using a USB cable to connect the controller enclosure and the computer. If you use the MSA Device Discovery Tool you may not need the download. However, you can download it and install it for future use.

---

 **NOTE:** Access the download from your HP MSA products page at <http://www.hp.com/go/p2000>. Select **Models** — select your product — select **HP Support & Drivers**, then select **Download drivers and software**.

---

The USB device driver is also available from the *P2000 G3 Software Support/Documentation CD* that shipped with your product.

## Obtaining IP values

### Using the MSA Device Discovery Tool to discover controller's IP addresses

The MSA Device Discovery Tool provides the optimal approach for setting network port IP addresses on Windows or Linux platforms. For help with configuring your P2000 G3 MSA System products, see the *P2000 G3 Software Support/Documentation CD* that shipped with your product.

1. Locate the *P2000 G3 Software Support/Documentation CD* included with your P2000 G3 MSA System storage device.

2. Insert the *P2000 G3 Software Support/Documentation CD* into the CD drive on a Linux or Windows computer on the network that is connected to your controller enclosure.
3. Use Autorun or manually start the CD.  
The MSA Device Discovery Tool will run.
4. Follow the instructions to discover the IP addresses of the controller or controllers.  
Record these IP addresses so that you can specify them whenever you manage the controllers using SMU or the CLI.

Alternatively, you can set network port IP addresses using CLI on HP-UX, Windows, and Linux platforms.

## Setting network port IP addresses using DHCP

1. Look in the DHCP server's pool of leased addresses for two IP addresses assigned to "HP StorageWorks MSA Storage."
2. Use a ping broadcast to try to identify the device through the host's ARP table.  
If you do not have a DHCP server, you will need to ask your system administrator to allocate two IP addresses, and set them using the CLI during initial configuration (described below).

## Setting network port IP addresses using the CLI port and cable

If you did not use the MSA Device Discovery Tool to set network port IP values, set them manually using the CLI port and cable. If you have not done so already, you need to enable your system for using the CLI port.

---

 **NOTE:** For Linux systems, see [Preparing a Linux computer before cabling to the CLI port](#) on page 41. For Windows systems see [Downloading a device driver for Windows computers](#) on page 41.

---

Network ports on controller module A and controller module B are configured with the following default values:

- **Management Port IP Address:** 10.0.0.2 (controller A), 10.0.0.3 (controller B)
- **IP Subnet Mask:** 255.255.255.0
- **Gateway IP Address:** 10.0.0.1

If the default IP addresses are not compatible with your network, you must set an IP address for each network port using the CLI embedded in each controller module. The CLI enables you to access the system using the USB (universal serial bus) communication interface and terminal emulation software. The USB cable and CLI port support USB version 2.0.

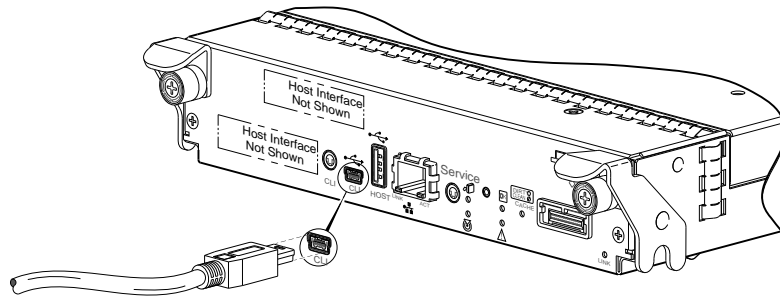
Use the CLI commands described in the steps below to set the IP address for the network port on each controller module. Once new IP addresses are set, you can change them as needed using SMU. Be sure to change the IP address via SMU before changing the network configuration.

---

 **NOTE:** Changing IP settings can cause management hosts to lose access to the storage system.

---

1. From your network administrator, obtain an IP address, subnet mask, and gateway address for controller A, and another for controller B.  
Record these IP addresses so that you can specify them whenever you manage the controllers using SMU or the CLI.
2. Use the provided USB cable to connect controller A to a USB port on a host computer. The USB mini 5 male connector plugs into the CLI port as shown in [Figure 14](#) (generic controller module is shown).



Connect USB cable to CLI port on controller faceplate

**Figure 14** Connecting a USB cable to the CLI port

3. Enable the CLI port for subsequent communication:
  - Linux customers should enter the command syntax provided in [Preparing a Linux computer before cabling to the CLI port](#) on page 41.
  - Windows customers should locate the downloaded device driver described in [Downloading a device driver for Windows computers](#) on page 41, and follow the instructions provided for proper installation.
4. Start and configure a terminal emulator, such as HyperTerminal or VT-100, using the display settings in [Table 5](#) on page 43 and the connection settings in [Table 6](#) on page 43 (also, see the note following this procedure).

**Table 5** Terminal emulator display settings

Parameter	Value
Terminal emulation mode	VT-100 or ANSI (for color support)
Font	Terminal
Translations	None
Columns	80

**Table 6** Terminal emulator connection settings

Parameter	Value
Connector	COM3 (for example) <sup>1,2</sup>
Baud rate	115,200
Data bits	8
Parity	None
Stop bits	1
Flow control	None

<sup>1</sup>Your server or laptop configuration determines which COM port is used for Disk Array USB Port.

<sup>2</sup>Verify the appropriate COM port for use with the CLI.

5. In the terminal emulator, connect to controller A.
6. Press Enter to display the CLI prompt (#).
 

The CLI displays the system version, MC version, and login prompt:

  - a. At the login prompt, enter the default user `manage`.
  - b. Enter the default password `!manage`.

If the default user or password — or both — have been changed for security reasons, enter the secure login credentials instead of the defaults shown above.

7. At the prompt, type the following command to set the values you obtained in Step 1 for each network port, first for controller A and then for controller B:

```
set network-parameters ip address netmask netmask gateway gateway controller a|b
```

where:

- *address* is the IP address of the controller
- *netmask* is the subnet mask
- *gateway* is the IP address of the subnet router
- a|b specifies the controller whose network parameters you are setting

For example:

```
# set network-parameters ip 192.168.0.10 netmask 255.255.255.0 gateway
192.168.0.1 controller a

# set network-parameters ip 192.168.0.11 netmask 255.255.255.0 gateway
192.168.0.1 controller b
```

8. Type the following command to verify the new IP addresses:

```
show network-parameters
```

Network parameters, including the IP address, subnet mask, and gateway address are displayed for each controller.

9. Use the ping command to verify network connectivity.

For example:

```
# ping 192.168.0.1 (gateway)
Info: Pinging 192.168.0.1 with 4 packets.
Success: Command completed successfully. - The remote computer responded with 4
packets.
```

10. In the host computer's command window, type the following command to verify connectivity, first for controller A and then for controller B:

```
ping controller-IP-address
```


**If you cannot your access your system for at least three minutes after changing the IP address**, your network might require you to restart the Management Controller(s) using the CLI. When you restart a Management Controller, communication with it is temporarily lost until it successfully restarts.

Type the following command to restart the management controller on both controllers:

```
restart mc both
```

11. When you are done using the CLI, exit the emulator.
12. Retain the new IP addresses to access and manage the controllers, using either SMU or the CLI.

---

 **NOTE:** Using HyperTerminal with the CLI on a **Microsoft Windows** host:

On a host computer connected to a controller module's mini-USB CLI port, incorrect command syntax in a HyperTerminal session can cause the CLI to hang. To avoid this problem, use correct syntax, use a different terminal emulator, or connect to the CLI using telnet rather than the mini-USB cable.

Be sure to close the HyperTerminal session before shutting down the controller or restarting its Management Controller. Otherwise, the host's CPU cycles may rise unacceptably.

---

---


## 6 Basic operation

Verify that you have completed the sequential “Installation Checklist” instructions in [Table 2](#) on page 23. Once you have successfully completed steps 1 through 8 therein, you can access the management interface using your web-browser.

### Accessing SMU

Upon completing the hardware installation, you can access the controller module’s web-based management interface, SMU (Storage Management Utility), to monitor and manage the storage system. Invoke your web browser, and enter the IP address of the controller module’s network port in the address field (obtained during completion of “Installation Checklist” step 8), then press **Enter**. To Sign In to SMU, use the default user name **manage** and password **!manage**. If the default user or password — or both — have been changed for security reasons, enter the secure login credentials instead of the defaults shown above. This brief Sign In discussion assumes proper web browser setup.


---

 **IMPORTANT:** For detailed information on accessing and using SMU, see the “Getting started” section in the web-posted HP P2000 G3 MSA System SMU Reference Guide.

---

The Getting Started section provides instructions for signing-in to SMU, introduces key concepts, addresses browser setup, and provides tips for using the main window and the help window.

---

 **TIP:** After signing in to SMU, you can use online help as an alternative to consulting the reference guide.

---

### Configuring and provisioning the storage system

Once you have familiarized yourself with SMU, use it to configure and provision the storage system. Refer to the following topics within the SMU reference guide or online help:

- Configuring the system
- Provisioning the system



---

# 7 Troubleshooting

## CLI port connection

P2000 G3 MSA System controllers feature a new CLI port employing a mini-USB Type B form factor. If you encounter problems communicating with the port after cabling your computer to the USB device, you may need to either download a device driver (Windows), or set appropriate parameters via an operating system command (Linux). See [Connecting to the controller CLI port](#) for more information.

## Fault isolation methodology

P2000 G3 MSA System controllers provide many ways to isolate faults within the system. This section presents the basic methodology used to locate faults and the associated FRUs (Field Replaceable Units).

The basic fault isolation steps are:

- Gather fault information, including using system LEDs.
- Determine where in the system the fault is occurring.
- Review event logs.
- If required, isolate the fault to a data path component or configuration.

### Gather fault information

When a fault occurs, it is important to gather as much information as possible. Doing so will help you determine the correct action needed to remedy the fault.

Begin by reviewing the reported fault. Is the fault related to an internal data path or an external data path? Is the fault related to a hardware component such as a disk drive module, controller module, or power supply? By isolating the fault to *one* of the components within the storage system, you will be able to determine the necessary action more rapidly.

### Determine where the fault is occurring

Once you have an understanding of the reported fault, review the enclosure LEDs. The enclosure LEDs are designed to alert users of any system faults, and might be what alerted the user to a fault in the first place.

When a fault occurs, the Fault ID status LED on an enclosure's right ear (see [Front panel components](#) on page 17) illuminates. Check the LEDs on the back of the enclosure to narrow the fault to a FRU, connection, or both. The LEDs also help you identify the location of a FRU reporting a fault.

Use SMU to verify any faults found while viewing the LEDs. SMU is also a good tool to use in determining where the fault is occurring if the LEDs cannot be viewed due to the location of the system. SMU provides you with a visual representation of the system and where the fault is occurring. It can also provide more detailed information about FRUs, data, and faults.

### Review the event logs

The event logs record all system events. It is very important to review the logs, not only to identify the fault, but also to search for events that might have caused the fault to occur. For example, a host could lose connectivity to a virtual disk if a user changes channel settings without taking the storage resources assigned to it into consideration. In addition, the type of fault can help you isolate the problem to hardware or software.

The Log Collector utility allows customers to gather log information for use during support calls. See the P2000 G3 Software Support/Documentation CD that ships with your product for details.

### Isolate the fault

Occasionally it might become necessary to isolate a fault. This is particularly true with data paths, due to the number of components comprising the data path. For example, if a host-side data error occurs, it could be caused by any of the components in the data path: controller module, cable, or data host.

## If the enclosure does not initialize

It may take up to two minutes for the enclosures to initialize. If the enclosure does not initialize:

- Perform a rescan.
- Power cycle the system.
- Make sure the power cord is properly connected, and check the power source that it is connected to.
- Check the event log for errors.

## Correcting enclosure IDs

When installing a system with drive enclosures attached, the enclosure IDs might not agree with the physical cabling order. This is because the controller might have been previously attached to some of the same enclosures during factory testing and it attempts to preserve the previous enclosure IDs if possible. To correct this condition, make sure that both controllers are up, and perform a rescan using SMU or the CLI. This will reorder the enclosures, but can take up to two minutes for the enclosure IDs to be corrected.

To perform a rescan using the CLI, type the following command:

```
rescan
```

To rescan using SMU:

1. Verify that both controllers are operating normally.
2. In the Configuration View panel, right-click the system and select **Tools > Rescan Disk Channels**.
3. Click **Rescan**.

## Diagnostic steps

This section describes possible reasons and actions to take when an LED indicates a fault condition. See [LED descriptions](#) on page 57 for descriptions of all LED statuses.

### Is the front panel Fault LED amber?

Answer	Possible reasons	Actions
No	System functioning properly.	No action required.
Yes	A fault condition exists.	<ul style="list-style-type: none"><li>• Check the LEDs on the back of the controller to narrow the fault to a FRU, connection, or both.</li><li>• Check the event log for specific information regarding the fault.</li></ul>
Yes	A fault occurred. If installing an I/O module FRU, the module has not gone online and likely failed its self-test.	<ul style="list-style-type: none"><li>• Check the event log for specific information regarding the fault.</li><li>• Isolate the fault.</li><li>• Contact an authorized service provider for assistance.</li><li>• Replace if necessary.</li><li>• If installing an I/O module FRU, try removing and reinstalling the new I/O module, and check the event log for errors.</li></ul>



## Is the controller back panel OK LED off?

Answer	Possible reasons	Actions
No	System functioning properly.	No action required.
Yes	<p>The controller module is not powered on.</p> <p>The controller module has failed.</p>	<ul style="list-style-type: none"> <li>• Check that the controller module is fully inserted and latched in place, and that the enclosure is powered on.</li> <li>• Check the event log for specific information regarding the failure.</li> </ul>

## Is the controller back panel Fault/Service Required LED amber?

Answer	Possible reasons	Actions
No	System functioning properly.	No action required.
Yes (blinking)	<p>One of the following errors occurred:</p> <ul style="list-style-type: none"> <li>• Hardware-controlled power-up error</li> <li>• Cache flush error</li> <li>• Cache self-refresh error</li> </ul>	<ul style="list-style-type: none"> <li>• Restart this controller from the other controller using SMU or the CLI.</li> <li>• Remove the controller and reinsert it.</li> <li>• Contact an authorized service provider for assistance.</li> <li>• Replace the controller.</li> </ul>

## Are both disk drive module LEDs off (Online/Activity and Fault/UID)?

Answer	Possible reasons	Actions
Yes	<ul style="list-style-type: none"> <li>• There is no power.</li> <li>• The disk is offline.</li> <li>• The disk is not configured.</li> </ul>	Check that the disk drive is fully inserted and latched in place, and that the enclosure is powered on.

## Is the disk drive module Fault/UID LED blinking amber?

Answer	Possible reasons	Actions
No, but the <b>Online/Activity LED is blinking.</b>	The disk drive is rebuilding.	<p>No action required.</p> <hr/> <p>△ <b>CAUTION:</b> Do not remove a drive that is rebuilding. Removing a drive might terminate the current operation and cause data loss.</p> <hr/>
Yes, and the <b>Online/Activity LED is off.</b>	The disk drive is offline. A predictive failure alert may have been received for this device.	<ul style="list-style-type: none"> <li>• Check the event log for specific information regarding the fault.</li> <li>• Isolate the fault.</li> <li>• Contact an authorized service provider for assistance.</li> </ul>
Yes, and the <b>Online/Activity LED is blinking.</b>	The disk drive is active, but a predictive failure alert may have been received for this device.	<ul style="list-style-type: none"> <li>• Check the event log for specific information regarding the fault.</li> <li>• Isolate the fault.</li> <li>• Contact an authorized service provider for assistance.</li> </ul>

## Is a connected host port's Host Link Status LED off?

Answer	Possible reasons	Actions
No	System functioning properly.	No action required. (see <a href="#">Link LED</a> note: page 60)
Yes	The link is down.	<ul style="list-style-type: none"> <li>• Check cable connections and reseal if necessary.</li> <li>• Inspect cables for damage.</li> <li>• Swap cables to determine if fault is caused by a defective cable. Replace cable if necessary.</li> <li>• Verify that the switch, if any, is operating properly. If possible, test with another port.</li> <li>• Verify that the HBA is fully seated, and that the PCI slot is powered on and operational.</li> <li>• In SMU, review event logs for indicators of a specific fault in a host data path component.</li> <li>• Contact an authorized service provider for assistance.</li> <li>• See <a href="#">Isolating a host-side connection fault</a> on page 52.</li> </ul>

## Is a connected port's Expansion Port Status LED off?

Answer	Possible reasons	Actions
No	System functioning properly.	No action required.
Yes	The link is down.	<ul style="list-style-type: none"> <li>• Check cable connections and reseal if necessary.</li> <li>• Inspect cable for damage.</li> <li>• Swap cables to determine if fault is caused by a defective cable. Replace cable if necessary.</li> <li>• In SMU, review event logs for indicators of a specific fault in a host data path component.</li> <li>• Contact an authorized service provider for assistance.</li> <li>• See <a href="#">Isolating a controller module expansion port connection fault</a> on page 53.</li> </ul>

## Is a connected port's Network Port Link Status LED off?

Answer	Possible reasons	Actions
No	System functioning properly.	No action required.
Yes	The link is down.	Use standard networking troubleshooting procedures to isolate faults on the network.

## Is the power supply's Input Power Source LED off?

Answer	Possible reasons	Actions
No	System functioning properly.	No action required.
Yes	The power supply is not receiving adequate power.	<ul style="list-style-type: none"><li>• Verify that the power cord is properly connected and check the power source it is connected to.</li><li>• Check that the power supply FRU is firmly locked into position.</li><li>• Check the event log for specific information regarding the fault.</li><li>• Isolate the fault.</li><li>• Contact an authorized service provider for assistance.</li></ul>


## Is the power supply's Voltage/Fan Fault/Service Required LED amber?

Answer	Possible reasons	Actions
No	System functioning properly.	No action required.
Yes	The power supply unit or a fan is operating at an unacceptable voltage/RPM level, or has failed.	<p>When isolating faults in the power supply, remember that the fans in both modules receive power through a common bus on the midplane, so if a power supply unit fails, the fans continue to operate normally.</p> <ul style="list-style-type: none"><li>• Check that the power supply FRU is firmly locked into position.</li><li>• Check that the power cable is connected to a power source.</li><li>• Check that the power cable is connected to the power supply module.</li></ul>

## Controller failure in a single-controller configuration

Cache memory is flushed to CompactFlash in the case of a controller failure or power loss. During the write to CompactFlash process, only the components needed to write the cache to the CompactFlash are powered by the super-capacitor. This process typically takes 60 seconds per 1 Gbyte of cache. After the cache is copied to CompactFlash, the remaining power left in the super-capacitor is used to refresh the cache memory. While the cache is being maintained by the super-capacitor, the Cache Status LED flashes at a rate of 1/10 second off and 9/10 second on.

---

 **IMPORTANT:** Transportable cache only applies to single-controller configurations. In dual controller configurations, there is no need to transport a failed controller's cache to a replacement controller because the cache is duplicated between the peer controllers.

---

## If the controller has failed or does not start, is the Cache Status LED on/blinking?

Answer	Actions
No, the Cache LED status is off, and the controller does not boot.	If valid data is thought to be in Flash, see <a href="#">Transporting cache</a> ; otherwise, replace the controller.
No, the Cache Status LED is off, and the controller boots.	The system is flushing data to disks. If the problem persists, replace the controller.
Yes, at a strobe 1:10 rate - 1 Hz, and the controller does not boot.	See <a href="#">Transporting cache</a> .
Yes, at a strobe 1:10 rate - 1 Hz, and the controller boots.	The system is flushing data to disks. If the problem persists, replace the controller.
Yes, at a blink 1:1 rate - 1 Hz, and the controller does not boot.	See <a href="#">Transporting cache</a> .
Yes, at a blink 1:1 rate - 1 Hz, and the controller boots.	The system is flushing data to disks. If the problem persists, replace the controller.

### Transporting cache

To preserve the existing data stored in the CompactFlash, you must transport the CompactFlash from the failed controller to a replacement controller using a procedure outlined in the *HP P2000 G3 MSA System controller replacement instructions*, shipped with the replacement controller. Failure to use this procedure will result in the loss of data stored in the cache module.

---

△ **CAUTION:** Remove the controller only after the copy process is complete, which is indicated by the Cache Status LED being off.

---

### Isolating a host-side connection fault

During normal operation, when a controller module host port is connected to a data host, the port's host link status LED and host link activity LED are green. If there is I/O activity, the host activity LED blinks green. If data hosts are having trouble accessing the storage system, and you cannot locate a specific fault or cannot access the event logs, use the following procedure. This procedure requires scheduled downtime.

---

📋 **IMPORTANT:** Do not perform more than one step at a time. Changing more than one variable at a time can complicate the troubleshooting process.

---

### Host-side connection troubleshooting featuring SAS host interface ports

The procedure below applies to P2000 G3 MSA controller enclosures configured with 6Gb SAS host interface ports.

1. Halt all I/O to the storage system.
2. Check the host activity LED.

If there is activity, halt all applications that access the storage system.

3. Reseat the cable and inspect for damage.

Is the host link status LED on?

- Yes – Monitor the status to ensure that there is no intermittent error present. If the fault occurs again, clean the connections to ensure that a dirty connector is not interfering with the data path.
- No – Proceed to the next step.

4. Move the cable to a port with a known good link status.

This step isolates the problem to the external data path (host cable and host-side devices) or to the controller module port.

Is the host link status LED on?

- Yes – You now know that the host cable and host-side devices are functioning properly. Return the cable to the original port. If the link status LED remains off, you have isolated the fault to the controller module's port. Replace the controller module.
- No – Proceed to the next step.

5. Verify that the switch, if any, is operating properly. If possible, test with another port.

6. Verify that the HBA is fully seated, and that the PCI slot is powered on and operational.

7. Replace the HBA with a known good HBA, or move the host side cable to a known good HBA.

Is the host link status LED on?

- Yes – You have isolated the fault to the HBA. Replace the HBA.
- No – It is likely that the controller module needs to be replaced.

8. Move the cable back to its original port.

Is the host link status LED on?


- No – The controller module's port has failed. Replace the controller module.
- Yes – Monitor the connection for a period of time. It may be an intermittent problem, which can occur with damaged cables and HBAs.

## Isolating a controller module expansion port connection fault

During normal operation, when a controller module's expansion port is connected to a drive enclosure, the expansion port status LED is green. If the connected port's expansion port LED is off, the link is down. Use the following procedure to isolate the fault.

This procedure requires scheduled downtime.

---

 **NOTE:** Do not perform more than one step at a time. Changing more than one variable at a time can complicate the troubleshooting process.

---

1. Halt all I/O to the storage system.

2. Check the host activity LED.

If there is activity, halt all applications that access the storage system.

3. Reseat the expansion cable, and inspect it for damage.

Is the expansion port status LED on?

- Yes – Monitor the status to ensure there is no intermittent error present. If the fault occurs again, clean the connections to ensure that a dirty connector is not interfering with the data path.
- No – Proceed to the next step.

4. Move the expansion cable to a port on the RAID enclosure with a known good link status.

This step isolates the problem to the expansion cable or to the controller module's expansion port.

Is the expansion port status LED on?

- Yes – You now know that the expansion cable is good. Return cable to the original port. If the expansion port status LED remains off, you have isolated the fault to the controller module's expansion port. Replace the controller module.
- No – Proceed to the next step.

5. Move the expansion cable back to the original port on the controller enclosure.

6. Move the expansion cable on the drive enclosure to a known good expansion port on the drive enclosure.

Is the expansion port status LED on?

- Yes – You have isolated the problem to the drive enclosure's port. Replace the expansion module.
- No – Proceed to the next step.

- Replace the cable with a known good cable, ensuring the cable is attached to the original ports used by the previous cable.

Is the host link status LED on?

- Yes – Replace the original cable. The fault has been isolated.
- No – It is likely that the controller module needs to be replaced.

## Resolving voltage and temperature warnings

- Check that all of the fans are working by making sure each power supply's Voltage/Fan Fault/Service Required LED is off or by using SMU to check for yellow yield icon hardware warnings. (In the Configuration View panel, right-click the enclosure and select **View > Overview**.)
- Make sure that all modules are fully seated in their slots and that their latches are locked.
- Make sure that no slots are left open for more than two minutes.

If you need to replace a module, leave the old module in place until you have the replacement or use a blank module to fill the slot. Leaving a slot open negatively affects the airflow and can cause the enclosure to overheat.

- Try replacing each power supply one at a time.
- Replace the controller modules one at a time.

## Sensor locations

The storage system monitors conditions at different points within each enclosure to alert you to problems. Power, cooling fan, temperature, and voltage sensors are located at key points in the enclosure. In each controller module and expansion module, the enclosure management processor (EMP) monitors the status of these sensors to perform SCSI enclosure services (SES) functions.

The following sections describe each element and its sensors.

## Power supply sensors

Each enclosure has two fully redundant power supplies with load-sharing capabilities. The power supply sensors described in the following table monitor the voltage, current, temperature, and fans in each power supply. If the power supply sensors report a voltage that is under or over the threshold, check the input voltage.

**Table 7** Power supply sensors

Description	Event/Fault ID LED condition
Power supply 1	Voltage, current, temperature, or fan fault
Power supply 2	Voltage, current, temperature, or fan fault

## Cooling fan sensors

Each power supply includes two fans. The normal range for fan speed is 4,000 to 6,000 RPM. When a fan's speed drops below 4,000 RPM, the EMP considers it a failure and posts an alarm in the storage system's event log. The following table lists the description, location, and alarm condition for each fan. If the fan speed remains under the 4,000 RPM threshold, the internal enclosure temperature may continue to rise. Replace the power supply reporting the fault.

**Table 8** Cooling fan sensor descriptions

Description	Location	Event/Fault ID LED condition
Fan 1	Power supply 1	< 4,000 RPM
Fan 2	Power supply 1	< 4,000 RPM
Fan 3	Power supply 2	< 4,000 RPM
Fan 4	Power supply 2	< 4,000 RPM

During a shutdown, the cooling fans do not shut off. This allows the enclosure to continue cooling.

## Temperature sensors

Extreme high and low temperatures can cause significant damage if they go unnoticed. Each controller module has six temperature sensors. Of these, if the CPU or FPGA (Field Programmable Gate Array) temperature reaches a shutdown value, the controller module is automatically shut down. Each power supply has one temperature sensor.

When a temperature fault is reported, it must be remedied as quickly as possible to avoid system damage. This can be done by warming or cooling the installation location.

**Table 9** Controller module temperature sensors

Description	Normal operating range	Warning operating range	Critical operating range	Shutdown values
CPU temperature	3–88°C	0–3°C, 88–90°C	> 90°C	0°C 100°C
FPGA temperature	3–97°C	0–3°C, 97–100°C	None	0°C 105°C
Onboard temperature 1	0–70°C	None	None	None
Onboard temperature 2	0–70°C	None	None	None
Onboard temperature 3 (Capacitor temperature)	0–70°C	None	None	None
CM temperature	5–50°C	≤ 5°C, ≥ 50°C	≤ 0°C, ≥ 55°C	None

When a power supply sensor goes out of range, the Fault/ID LED illuminates amber and an event is logged to the event log.

**Table 10** Power supply temperature sensors

Description	Normal operating range
Power Supply 1 temperature	–10–80°C
Power Supply 2 temperature	–10–80°C

## Power supply module voltage sensors

Power supply voltage sensors ensure that an enclosure's power supply voltage is within normal ranges. There are three voltage sensors per power supply.

**Table 11** Voltage sensor descriptions

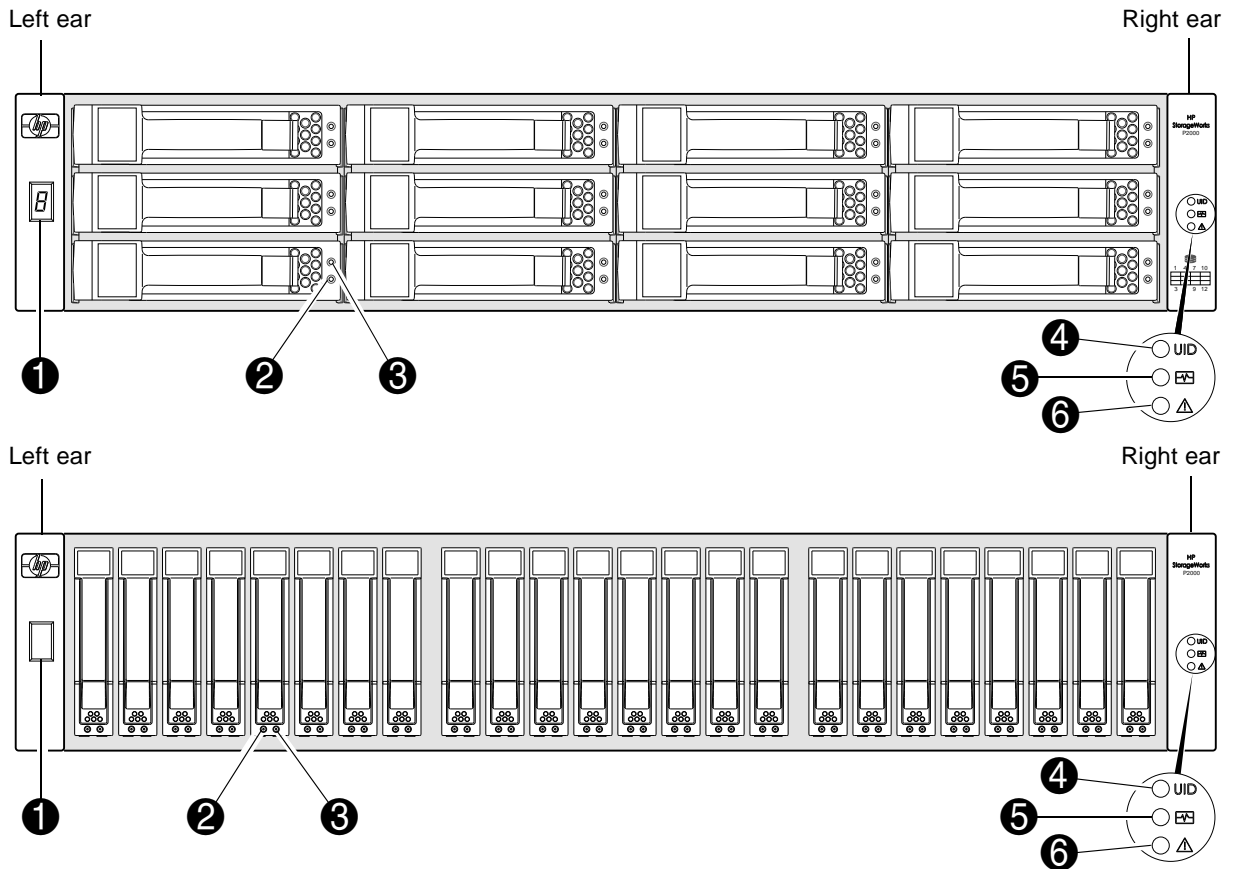
Sensor	Event/Fault LED condition
Power supply 1 voltage, 12V	< 11.00V > 13.00V
Power supply 1 voltage, 5V	< 4.00V > 6.00V
Power supply 1 voltage, 3.3V	< 3.00V > 3.80V





# A LED descriptions

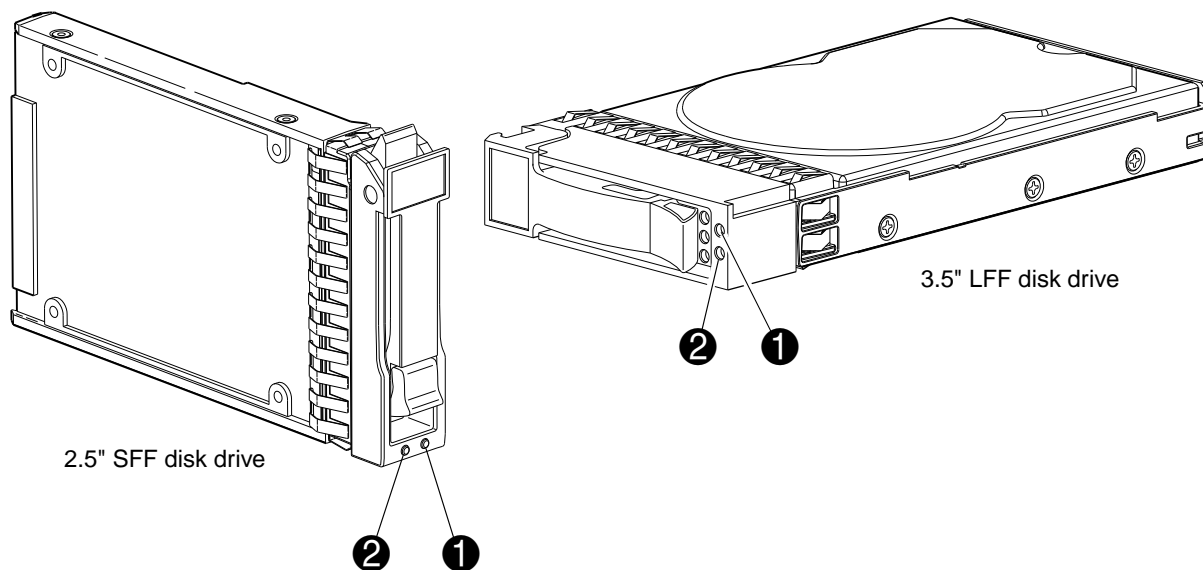
## Front panel LEDs



**Table 12** LEDs — HP P2000 G3 MSA Systems controller enclosure front panels

LED	Description	Definition
1	Enclosure ID	Green — On Enables you to correlate the enclosure with logical views presented by management software. Sequential enclosure ID numbering of controller enclosures begins with the integer 1. The enclosure ID for an attached drive enclosure is nonzero.
2	Disk drive Online/Activity	See <a href="#">Disk drive LEDs</a> on page 58.
3	Disk drive Fault/UID	See <a href="#">Disk drive LEDs</a> on page 58.
4	Unit Identification (UID)	Blue — Identified. Off — Identity LED off.
5	Heartbeat	Green — The enclosure is powered on with at least one power supply operating normally. Off — Both power supplies are off; the system is powered off.
6	Fault ID	Amber — Fault condition exists. The event has been identified, but the problem needs attention. Off — No fault condition exists.

## Disk drive LEDs



**Table 13** LEDs — Disk drive LEDs

LED	Description
1	Fault/UID (amber/blue)
2	Online/Activity (green)

**Table 14** LEDs — Disk drive combinations

Online/Activity (green)	Fault/UID (amber/blue)	Description
On	Off	Normal operation. The drive is online, but it is not currently active.
Blinking irregularly	Off	The drive is active and operating normally.
Off	Amber; blinking regularly (1 Hz)	Offline; the drive is not being accessed. A predictive failure alert may have been received for this device. Further investigation is required.
On	Amber; blinking regularly (1 Hz)	Online; possible I/O activity. A predictive failure alert may have been received for this device. Further investigation is required.
Blinking irregularly	Amber; blinking regularly (1 Hz)	The drive is active, but a predictive failure alert may have been received for this drive. Further investigation is required.
Off	Amber; solid <sup>1</sup>	Offline; no activity. A failure or critical fault condition has been identified for this drive.
Off	Blue; solid	Offline. The drive has been selected by a management application (SMU).
On or blinking	Blue; solid	The controller is driving I/O to the drive, and it has been selected by a management application (SMU).

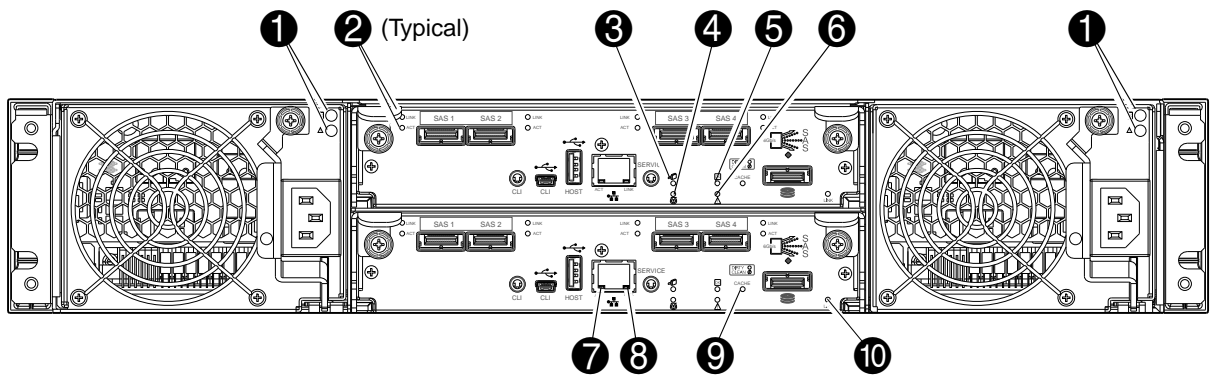
**Table 14** LEDs — Disk drive combinations

Online/Activity (green)	Fault/UID (amber/blue)	Description
Blinking regularly (1 Hz)	Off	<p>△ <b>CAUTION:</b> Do not remove the drive. Removing a drive may terminate the current operation and cause data loss. The drive is rebuilding.</p>
Off	Off	Either there is no power, the drive is offline, or the drive is not configured.

<sup>1</sup>This Fault/UID state can indicate that the disk is a leftover. The fault may involve metadata on the disk rather than the disk itself. See the Clearing disk metadata topic in the SMU reference guide or online help.

## Rear panel LEDs

### P2000 G3 SAS MSA System SFF and P2000 G3 SAS MSA System LFF




**Table 15** LEDs — HP P2000 G3 SAS MSA System LFF and SFF rear panel

LED	Description	Definition
1	Power supply LEDs	See <a href="#">Power supply LEDs</a> on page 63.
2	Host 6Gb SAS Link Status (ports 1-4)	Green — The port is connected and the link is up. Off — The port is empty or the link is down.
	Host 6Gb SAS Link Activity (ports 1-4)	Blinking — Link has I/O activity. Off — Link is idle.
3	OK to Remove	Off — The controller module is not prepared for removal. Blue — The controller module is prepared for removal.
4	Unit Locator	Off — Normal operation. Blinking white — Physically identifies the controller module.
5	FRU OK	Off — Controller module is not OK. Blinking green — System is booting. Green — Controller module is operating normally.
6	Fault/Service Required	Amber — A fault has been detected or a service action is required. Blinking amber — Hardware-controlled power-up or a cache flush or restore error.
7	Network Port Activity	Off — The Ethernet link has no I/O activity. Blinking green — The Ethernet link has I/O activity.
8	Network Port Link Status	Off — The Network port is not connected or the link is down. Green — The Network link is up.


**Table 15** LEDs — HP P2000 G3 SAS MSA System LFF and SFF rear panel

LED	Description	Definition
9	Cache Status	<p>Green — Cache is dirty (contains unwritten data) and operation is normal.</p> <p>Off — In a working controller, cache is clean (contains no unwritten data).</p> <p>Blinking green — A CompactFlash flush or cache self-refresh is in progress. Indicates cache activity (See also <a href="#">If the controller has failed or does not start, is the Cache Status LED on/blinking?</a> on page 52).</p> <p>If the LED is blinking evenly, a cache flush is in progress. When a controller module loses power and write cache is dirty (contains data that has not been written to disk), the super-capacitor pack provides backup power to flush (copy) data from write cache to CompactFlash memory. When cache flush is complete, the cache transitions into self-refresh mode.</p> <p>If the LED is blinking momentarily slowly, the cache is in a self-refresh mode. In self-refresh mode, if primary power is restored before the backup power is depleted (3–30 minutes, depending on various factors), the system boots, finds data preserved in cache, and writes it to disk. This means the system can be operational within 30 seconds, and before the typical host I/O time-out of 60 seconds, at which point system failure would cause host-application failure. If primary power is restored after the backup power is depleted, the system boots and restores data to cache from CompactFlash, which can take about 90 seconds.</p> <p>The cache flush and self-refresh mechanism is an important data protection feature; essentially four copies of user data are preserved: one in each controller's cache and one in each controller's CompactFlash.</p>
10	Expansion Port Status	<p>Off — The port is empty or the link is down.</p> <p>On — The port is connected and the link is up.</p>

---

 **IMPORTANT:** Early versions of the P2000 G3 MSA System controller modules show network port LED labels in reversed position: LINK is shown on the left and ACT is shown on the right. On such units, the LED labeled LINK reports ACT behavior and the LED labeled ACT reports LINK behavior.

---

 **NOTE:** Once a Link Status LED is lit, it remains so, even if the controller is shutdown via SMU or CLI.

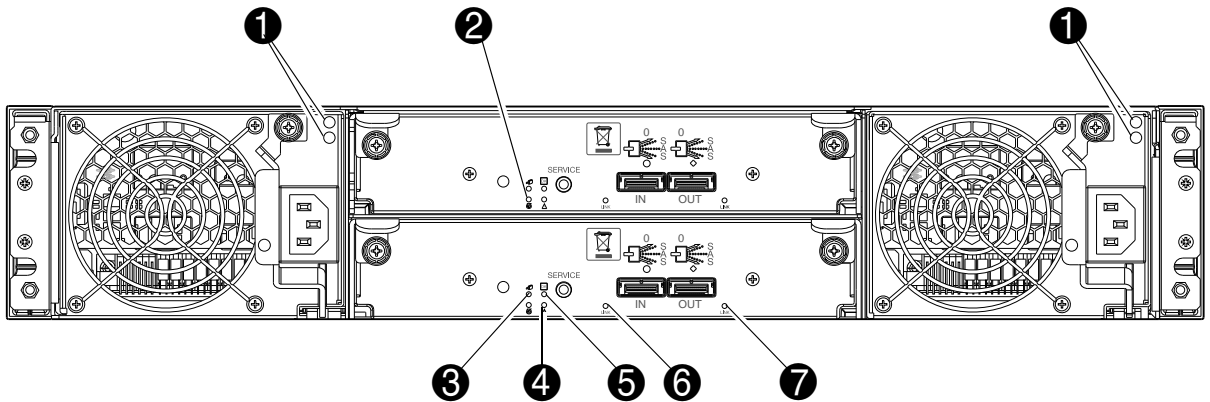
---

When a controller is shutdown or otherwise rendered inactive —its Link Status LED remains illuminated—falsely indicating that the controller can communicate with the host. Though a link exists between the host and the chip on the controller, the controller is not communicating with the chip. To reset the LED, the controller must be properly power-cycled (see [Accessing SMU](#) on page 45).

## D2700 6Gb drive enclosure

P2000 G3 MSA System controllers support D2700 6Gb drive enclosures. For information about P2000 G3 MSA System products, visit <http://www.hp.com/go/p2000>. Select **Related products**, select your drive enclosure, select **Support > HP Support & Drivers** from the right side of the page, select your product name, and select **Manuals**.

## P2000 6Gb 3.5" 12-drive enclosure



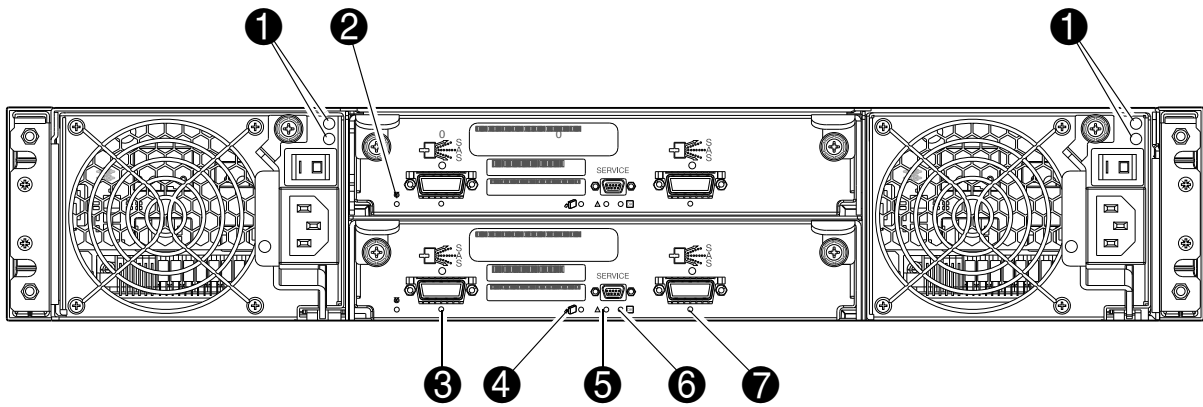
**Table 16** LEDs — HP P2000 6Gb rear panel

LED	Description	Definition
1	Power supply LEDs	See <a href="#">Power supply LEDs</a> on page 63.
2	Unit Locator	Off — Normal operation. Blinking white— Physically identifies the expansion module.
3	OK to Remove	Not implemented.
4	Fault/Service Required	Amber — A fault has been detected or a service action is required. Blinking amber — Hardware-controlled powerup or a cache flush or restore error.
5	FRU OK	Green — Expansion module is operating normally. Blinking green — System is booting. Off — Expansion module is not OK.
6	SAS In Port Status	Green — Port link is up and connected. Off — Port is empty or link is down.
7	SAS Out Port Status	Green — Port link is up and connected. Off — Port is empty or link is down.

## MSA70 3Gb drive enclosure

A P2000 G3 MSA System controller can also be attached to an MSA70 3Gb drive enclosure running firmware version 2.18 or later. For information about the MSA70 3Gb drive enclosure, including detailed steps to upgrade the firmware, see the *HP StorageWorks 70 Modular Smart Array Enclosure User Guide* located on the *MSA2000 G2 Software Support/Documentation CD* shipped with your product, or at <http://hp.com/support/manuals>.

## MSA2000 3Gb 3.5" 12-drive enclosure

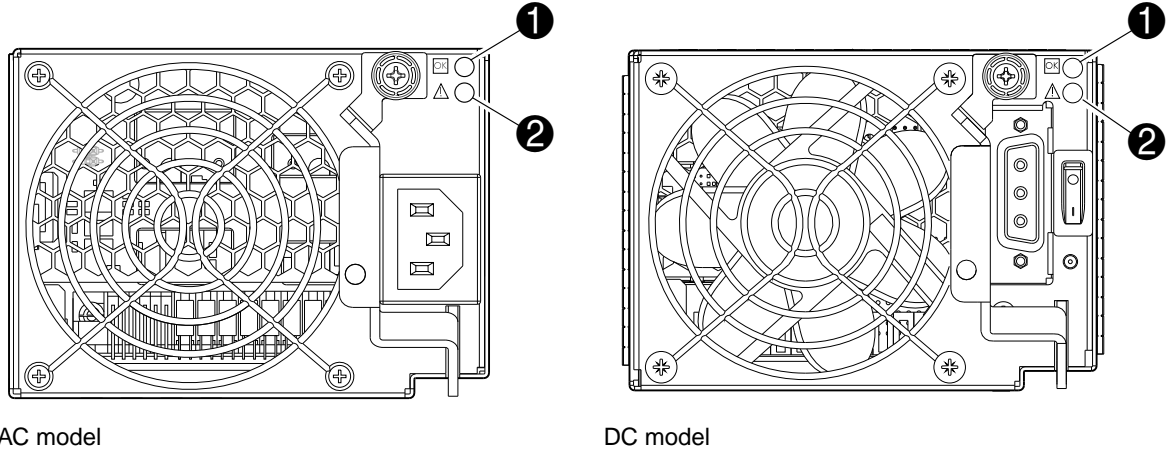


**Table 17** LEDs — HP MSA2000 3Gb rear panel

LED	Description	Definition
1	Power supply LEDs	See <a href="#">Power supply LEDs</a> on page 63.
2	Unit Locator	Off — Normal operation. Blinking white— Physically identifies the expansion module.
3	SAS In Port Status	Green — Port link is up and connected. Off — Port is empty or link is down.
4	OK to Remove	Not implemented.
5	Fault/Service Required	Amber — A fault has been detected or a service action is required. Blinking amber — Hardware-controlled powerup or a cache flush or restore error.
6	FRU OK	Green — Expansion module is operating normally. Blinking green — System is booting. Off — Expansion module is not OK.
7	SAS Out Port Status	Green — Port link is up and connected. Off — Port is empty or link is down.

## Power supply LEDs

Power redundancy is achieved through two independent load-sharing power supplies. In the event of a power supply failure, or the failure of the power source, the storage system can operate continuously on a single power supply. Greater redundancy can be achieved by connecting the power supplies to separate circuits. DC power supplies are equipped with a power switch. AC power supplies may or may not have a power switch (model shown below has no power switch). Whether a power supply has a power switch is significant to powering on/off.



**Table 18** LEDs — HP P2000 G3 MSA System power supply units — rear panel

LED	Description	Definition
1	Input Source Power Good	Green — Power is on and input voltage is normal. Off — Power is off or input voltage is below the minimum threshold.
2	Voltage/Fan Fault/Service Required	Amber — Output voltage is out of range or a fan is operating below the minimum required RPM. Off — Output voltage is normal.

**NOTE:** See [Powering on/powering off](#) on page 33 for information on power-cycling enclosures.





---

## B Environmental requirements and specifications

### Safety requirements

Install the system in accordance with the local safety codes and regulations at the facility site. Follow all cautions and instructions marked on the equipment. Also, refer to the documentation included with your product's ship kit.

### Site requirements and guidelines

The following sections provide requirements and guidelines that you must address when preparing your site for the installation.

When selecting an installation site for the system, choose a location not subject to excessive heat, direct sunlight, dust, or chemical exposure. These conditions greatly reduce the system's longevity and might void your warranty.

### Site wiring and AC power requirements

The following are required for all installations using AC power supplies:

- All AC mains and supply conductors to power distribution boxes for the rack-mounted system must be enclosed in a metal conduit or raceway when specified by local, national, or other applicable government codes and regulations.
- Ensure that the voltage and frequency of your power source match the voltage and frequency inscribed on the equipment's electrical rating label.
- To ensure redundancy, provide two separate power sources for the enclosures. These power sources must be independent of each other, and each must be controlled by a separate circuit breaker at the power distribution point.
- The system requires voltages within minimum fluctuation. The customer-supplied facilities' voltage must maintain a voltage with not more than  $\pm 5$  percent fluctuation. The customer facilities must also provide suitable surge protection.
- Site wiring must include an earth ground connection to the AC power source. The supply conductors and power distribution boxes (or equivalent metal enclosure) must be grounded at both ends.
- Power circuits and associated circuit breakers must provide sufficient power and overload protection. To prevent possible damage to the AC power distribution boxes and other components in the rack, use an external, independent power source that is isolated from large switching loads (such as air conditioning motors, elevator motors, and factory loads).

### Site wiring and DC power requirements

The following are required for all installations using DC power supplies:

- All DC mains and supply conductors to power distribution boxes for the rack-mounted system must comply with local, national, or other applicable government codes and regulations.
- Ensure that the voltage of your power source matches the voltage inscribed on the equipment's electrical label.
- To ensure redundancy, provide two separate power sources for the enclosures. These power sources must be independent of each other, and each must be controlled by a separate circuit breaker at the power distribution point.
- The system requires voltages within minimum fluctuation. The customer-supplied facilities' voltage must maintain a voltage within the range specified on the equipment's electrical rating label. The customer facilities must also provide suitable surge protection.
- Site wiring must include an earth ground connection to the DC power source. Grounding must comply with local, national, or other applicable government codes and regulations.
- Power circuits and associated circuit breakers must provide sufficient power and overload protection.

## Weight and placement guidelines

Refer to [Physical requirements](#) on page 67 for detailed size and weight specifications.

- The weight of an enclosure depends on the number and type of modules installed.
- Ideally, use two people to lift an enclosure. However, one person can safely lift an enclosure if its weight is reduced by removing the power supply modules and disk drive modules.
- Do not place enclosures in a vertical position. Always install and operate the enclosures in a horizontal orientation.
- When installing enclosures in a rack, make sure that any surfaces over which you might move the rack can support the weight. To prevent accidents when moving equipment, especially on sloped loading docks and up ramps to raised floors, ensure you have a sufficient number of helpers. Remove obstacles such as cables and other objects from the floor.
- To prevent the rack from tipping, and to minimize personnel injury in the event of a seismic occurrence, securely anchor the rack to a wall or other rigid structure that is attached to both the floor and to the ceiling of the room.

## Electrical guidelines

- These enclosures work with single-phase power systems having an earth ground connection. To reduce the risk of electric shock, do not plug an enclosure into any other type of power system. Contact your facilities manager or a qualified electrician if you are not sure what type of power is supplied to your building.
- Enclosures are shipped with a grounding-type (three-wire) power cord. To reduce the risk of electric shock, always plug the cord into a grounded power outlet.
- Do not use household extension cords with the enclosures. Not all power cords have the same current ratings. Household extension cords do not have overload protection and are not meant for use with computer systems.

## Ventilation requirements

Refer to [Environmental requirements](#) on page 68 for detailed environmental requirements.


- Do not block or cover ventilation openings at the front and rear of an enclosure. Never place an enclosure near a radiator or heating vent. Failure to follow these guidelines can cause overheating and affect the reliability and warranty of your enclosure.
- Leave a minimum of 6 inches (15 cm) at the front and back of each enclosure to ensure adequate airflow for cooling. No cooling clearance is required on the sides, top, or bottom of enclosures.
- Leave enough space in front and in back of an enclosure to allow access to enclosure components for servicing. Removing a component requires a clearance of at least 15 inches (37 cm) in front of and behind the enclosure.

## Cabling requirements

- Keep power and interface cables clear of foot traffic. Route cables in locations that protect the cables from damage.
- Route interface cables away from motors and other sources of magnetic or radio frequency interference.
- Stay within the cable length limitations.

## Management host requirements

A local management host with at least one serial port connection is recommended for the initial installation and configuration of a controller enclosure. After you configure one or both of the controller modules with an Internet Protocol (IP) address, you then use a remote management host on an Ethernet network to configure, manage, and monitor.

 **NOTE:** Connections to this device must be made with shielded cables – grounded at both ends – with metallic RFI/EMI connector hoods, in order to maintain compliance with FCC Rules and Regulations.

## Physical requirements

The floor space at the installation site must be strong enough to support the combined weight of the rack, controller enclosures, drive enclosures (expansion), and any additional equipment. The site also requires sufficient space for installation, operation, and servicing the enclosures, and sufficient ventilation to allow a free flow of air to all enclosures.

**Table 19** and **Table 20** list enclosure dimensions and weights. Weights are based on an enclosure having a full complement of disk drives, two controller or expansion modules, and two power supplies installed. “2U12” denotes the LFF enclosure and “2U24” denotes the SFF enclosure. The SFF is further delineated by the standard-depth 2U24 and the new reduced-depth (short) 2U24.

**Table 20** provides weight data for P2000 G3 controller enclosures and select drive enclosures. For information about other HP MSA drive enclosures that may be cabled to these systems (e.g., MSA70 or D2700), check Quickspecs, which can be found from your HP MSA products page <http://www.hp.com/go/msa>. Select your product. Quickspecs links are located on the right.

**Table 19** Rackmount enclosure dimensions

Specifications	Rackmount
2U Height (y-axis)	3.5 inches (8.9 cm)
Width (x-axis):	
<ul style="list-style-type: none"> <li>Chassis only</li> <li>Chassis with bezel ear caps</li> </ul>	17.6 inches (44.7 cm) 18.9 inches (47.9 cm)
Depth (z-axis):	
SFF standard-depth drive enclosure (2U24)	
<ul style="list-style-type: none"> <li>Back of chassis ear to controller latch</li> <li>Front of chassis ear to back of cable bend</li> </ul>	20.7 inches (52.6 cm) 23.6 inches (59.9 cm)
SFF reduced-depth drive enclosure (2U24)	
<ul style="list-style-type: none"> <li>Back of chassis ear to controller latch</li> <li>Front of chassis ear to back of cable bend</li> </ul>	19.9 inches (50.5 cm) 22.8 inches (57.9 cm)
LFF drive enclosure (2U12)	
<ul style="list-style-type: none"> <li>Back of chassis ear to controller latch</li> <li>Front of chassis ear to back of cable bend</li> </ul>	23.7 inches (60.2 cm) 26.4 inches (67.1 cm)

**Table 20** Rackmount enclosure weights

Specifications	Rackmount
P2000 G3 MSA SFF controller enclosure (standard)	21.4 lb (9.7 kg) [chassis]
<ul style="list-style-type: none"> <li>Chassis with FRUs (no disks)<sup>1,2</sup></li> <li>Chassis with FRUs (including disk)<sup>1,3</sup></li> </ul>	46.4 lb (21.0 kg) 58.4 lb (26.5 kg)
P2000 G3 MSA SFF controller enclosure (reduced)	19.0 lb (8.6 kg) [chassis]
<ul style="list-style-type: none"> <li>Chassis with FRUs (no disks)<sup>1,2</sup></li> <li>Chassis with FRUs (including disk)<sup>1,3</sup></li> </ul>	44.0 lb (19.9 kg) 56.0 lb (25.4 kg)
P2000 G3 MSA LFF controller enclosure	22.0 lb (9.9 kg) [chassis]
<ul style="list-style-type: none"> <li>Chassis with FRUs (no disks)<sup>1,2</sup></li> <li>Chassis with FRUs (including disks)<sup>1,3</sup></li> </ul>	47.0 lb (21.3 kg) 68.0 lb (30.8 kg)

**Table 20** Rackmount enclosure weights

Specifications	Rackmount
MSA2000 3.5" 12-drive enclosure (12 disks)	22.0 lb (9.9 kg) [chassis]
<ul style="list-style-type: none"> <li>Chassis with FRUs (no disks)<sup>1,2</sup></li> <li>Chassis with FRUs (including disks)<sup>1,3</sup></li> </ul>	47.0 lb (21.3 kg) 68.0 lb (30.8 kg)
P2000 6Gb 3.5" drive enclosure (12 disks)	22.0 lb (9.9 kg) [chassis]
<ul style="list-style-type: none"> <li>Chassis with FRUs (no disks)<sup>1,2</sup></li> <li>Chassis with FRUs (including disks)<sup>1,3</sup></li> </ul>	47.0 lb (21.3 kg) 68.0 lb (30.8 kg)

<sup>1</sup>Weights shown are nominal, and subject to variances.

<sup>2</sup>Weights may vary due to different power supplies, IOMs, and differing calibrations between scales.

<sup>3</sup>Weights may vary due to actual number and type of disk drives (SAS, SATA, SSD) installed.

## Environmental requirements

**Table 21** Operating environmental specifications

Specification	Range
Altitude	To 10,000 feet (3,000 meters)
Temperature*	41°F to 104°F (5°C to 40°C)
Humidity	10% to 90% RH up to 104°F (40°C) non-condensing
Shock	5.0 g, 11 ms, ½ sine pulses, X, Y, Z
Vibration	(Shaped spectrum) 5 Hz to 500 Hz, 0.114 G <sub>rms</sub> total X, Y, Z

\* Temperature is de-rated by 3.6°F (2°C) for every 3,281 feet (1 km) above sea level.

**Table 22** Non-operating environmental specifications

Specification	Range
Altitude	To 39,370 feet (12,000 meters)
Temperature	-40°F to 158°F (-40°C to 70°C)
Humidity	Up to 93% RH at 104°F (40°C) non-condensing
Shock	15.0 g, 11 ms, ½ sine pulses, X, Y, Z
Vibration	(Shaped spectrum) 2.8 Hz to 365.4 Hz, 0.852 G <sub>rms</sub> total (horizontal) 2.8 Hz to 365.4 Hz, 1.222 G <sub>rms</sub> total (vertical)

## Electrical requirements

### Site wiring and power requirements

Each enclosure has two power supply modules for redundancy. If full redundancy is required, use a separate power source for each module. The AC power supply unit in each power supply module is auto-ranging and is automatically configured to an input voltage range from 88–264 VAC with an input frequency of 47–63 Hz. The power supply modules meet standard voltage requirements for both U.S. and international operation. The power supply modules use standard industrial wiring with line-to-neutral or line-to-line power connections.

## Power cord requirements

Each enclosure equipped with AC power supply modules requires two AC power cords that are appropriate for use in a typical outlet in the destination country. Each power cord connects one of the power supply modules to an independent, external power source. To ensure power redundancy, connect the two suitable power cords to two separate circuits; for example, to one commercial circuit and one uninterruptible power source (UPS).



---

## C Electrostatic discharge

### Preventing electrostatic discharge

To prevent damaging the system, be aware of the precautions you need to follow when setting up the system or handling parts. A discharge of static electricity from a finger or other conductor may damage system boards or other static-sensitive devices. This type of damage may reduce the life expectancy of the device.

To prevent electrostatic damage:

- Avoid hand contact by transporting and storing products in static-safe containers.
- Keep electrostatic-sensitive parts in their containers until they arrive at static-protected workstations.
- Place parts in a static-protected area before removing them from their containers.
- Avoid touching pins, leads, or circuitry.
- Always be properly grounded when touching a static-sensitive component or assembly.

### Grounding methods to prevent electrostatic discharge

Several methods are used for grounding. Use one or more of the following methods when handling or installing electrostatic-sensitive parts:

- Use a wrist strap connected by a ground cord to a grounded workstation or computer chassis. Wrist straps are flexible straps with a minimum of 1 megohm ( $\pm$  10 percent) resistance in the ground cords. To provide proper ground, wear the strap snug against the skin.
- Use heel straps, toe straps or boot straps at standing workstations. Wear the straps on both feet when standing on conductive floors or dissipating floor mats.
- Use conductive field service tools.
- Use a portable field service kit with a folding static-dissipating work mat.

If you do not have any of the suggested equipment for proper grounding, have an authorized reseller install the part.

For more information on static electricity or assistance with product installation, contact an authorized reseller.





# Index

## Numerics

2U12

large form factor (LFF) enclosure 67

2U24

small form factor (SFF) enclosure 67

## A

accessing

CLI (command-line interface) 42

SMU (storage management utility) 45

web-posted documentation 11

audience 11

## C

cables

Ethernet 39

FCC compliance statement 39, 67

routing requirements 66

SAS 38

SAS expansion cable requirements 25

shielded 39, 67

USB for CLI 42

cabling

connecting controller and drive enclosures 24

direct attach configurations 38

cache

read ahead 20

self-refresh mode 60

write-through 20

clearance requirements

service 66

ventilation 66

command-line interface (CLI)

connecting USB cable to CLI port 43

using to set controller IP addresses 42

CompactFlash

transporting 21

components

controller module face plate

P2000 G3 SAS MSA System 18

P2000 G3 MSA Systems

supported drive enclosures

D2700 6Gb drive enclosure 19

MSA2000 3Gb drive enclosure 20

MSA70 3Gb drive enclosure 20

P2000 6Gb drive enclosure 20

P2000 G3 SAS MSA System

rear panel 19

AC PSU 19

CLI port (mini-USB) 19

DC power switch 19

DC PSU 19

host interface ports 19

network port 19

SAS expansion port 19

service port 19

configuring

direct attach configurations 38

connections

verify 33

console requirement 66

controller enclosures

connecting to data hosts 37

connecting to remote management hosts 39

conventions

document 12

## D

data hosts

defined 37

optional software 37

system requirements 37

DHCP

server 42

disk drive

slot numbering

LFF enclosure 18

SFF enclosure 18

document

conventions 12

prerequisite knowledge 11

related documentation 11

documentation, HP web site 11

## E

electromagnetic compatibility (EMC) 65

electrostatic discharge

grounding methods 71

precautions 71

enclosure

cabling 24

dimensions 67

IDs, correcting 48

initial configuration 41

input frequency requirement 68

input voltage requirement 68

installation checklist 23

site requirements 67

troubleshooting 48

web-browser based configuring and provisioning 45

weight 67

Ethernet cables

requirements 39

## F

faults

- isolating
  - expansion port connection fault [53](#)
  - host-side connection [52](#)
  - methodology [47](#)
- H**
- help, obtaining [13](#)
- host interface ports
  - SAS host interface protocol
  - SFF-8088 [37](#)
- HP
  - customer self-repair (CSR) [13](#)
  - product warranty [13](#)
  - related documentation [11](#)
  - Subscriber's choice web site [13](#)
  - technical support [13](#)
  - web sites [14](#)
- humidity non-operating range [68](#)
- humidity operating range [68](#)
- I**
- IDs, correcting for enclosure [48](#)
- installing enclosures
  - installation checklist [23](#)
- IP addresses
  - setting using CLI [42](#)
  - setting using DHCP [42](#)
- L**
- LEDs
  - disk drive [58](#)
    - Fault/UID [58](#)
    - Online/Activity [58](#)
  - enclosure front panel [57](#)
    - Enclosure ID [57](#)
    - Fault ID [57](#)
    - Heartbeat [57](#)
    - Unit Identification (UID) [57](#)
  - P2000 G3 MSA System
    - SAS rear panel
      - Cache Status [60](#)
      - Expansion Port Status [60](#)
      - Fault/Service Required [59](#)
      - FRU OK [59](#)
      - Host Link Activity [59](#)
      - Host Link Status [59](#)
      - Network Port Activity [59](#)
      - Network Port Link Status [59](#)
      - OK to Remove [59](#)
      - Power supply [59](#)
      - Unit Locator [59](#)
  - power supply unit
    - Input Source Power Good [63](#)
    - Voltage/Fan Fault/Service Required [63](#)
  - supported drive enclosures (expansion)
    - MSA2000 3Gb rear panel
      - Fault/Service Required [62](#)
      - FRU OK [62](#)
    - OK to Remove [62](#)
    - Power supply [62](#)
    - SAS In Port Status [62](#)
    - SAS Out Port Status [62](#)
    - Unit Locator [62](#)
- P2000 G3 6Gb rear panel
  - Fault/Service Required [61](#)
  - FRU OK [61](#)
  - OK to Remove [61](#)
  - Power supply [61](#)
  - SAS In Port Status [61](#)
  - SAS Out Port Status [61](#)
  - Unit Locator [61](#)
- local management host requirement [66](#)
- M**
- MPIO DSM, obtaining [37](#)
- N**
- non-operating ranges, environmental [68](#)
- O**
- operating ranges, environmental [68](#)
- P**
- P2000 Family SCSI Enclosure Services (SES) driver [37](#)
- physical requirements [67](#)
- power cord requirements [69](#)
- power cycle
  - power off [34](#), [35](#)
  - power on [33](#), [35](#)
- power supply
  - AC power requirements [65](#)
  - DC power requirements [65](#)
  - site wiring requirements [65](#)
- prerequisite knowledge [11](#)
- R**
- regulatory compliance
  - notices
    - shielded cables [39](#), [67](#)
  - related documentation [11](#)
- requirements
  - cabling [25](#)
  - clearance [66](#)
  - Ethernet cables [39](#)
  - host system [37](#)
  - physical [67](#)
  - ventilation [66](#)
- RFI/EMI connector hoods [39](#), [67](#)
- S**
- safety precautions [65](#)
- sensors
  - locating [54](#)
  - power supply [54](#)
  - temperature [55](#)
  - voltage [55](#)

- shock non-operating range [68](#)
- shock operating range [68](#)
- site planning
  - EMC [65](#)
  - local management host requirement [66](#)
  - physical requirements [67](#)
  - safety precautions [65](#)
- SMU
  - accessing web-based management interface [45](#)
  - defined [45](#)
  - getting started [45](#)
  - storage system configuring and provisioning [45](#)
- storage system setup
  - configuring [45](#)
  - provisioning [45](#)
- Subscriber's choice, HP [13](#)
- super-capacitor pack [21](#)

## T

- technical support, HP [13](#)
- temperature non-operating range [68](#)
- temperature operating range [68](#)
- troubleshooting [47](#)
  - controller failure, single controller configuration [51](#)
  - correcting enclosure IDs [48](#)
  - enclosure does not initialize [48](#)
  - expansion port connection fault [53](#)
  - using system LEDs [48](#)

## V

- ventilation requirements [66](#)
- vibration non-operating range [68](#)
- vibration operating range [68](#)

## W

- warnings
  - rack stability [13](#)
  - voltage and temperature [54](#)
- web sites
  - HP documentation [11](#)
  - HP Subscriber's choice [13](#)

