

# Aspire 3610 Series

## User's Guide

Copyright © 2005. Acer Incorporated.  
All Rights Reserved.

Aspire 3610 Series User's Guide  
Original Issue: July 2005

Changes may be made periodically to the information in this publication without obligation to notify any person of such revisions or changes. Such changes will be incorporated in new editions of this manual or supplementary documents and publications. This company makes no representations or warranties, either expressed or implied, with respect to the contents hereof and specifically disclaims the implied warranties of merchantability or fitness for a particular purpose.

Record the model number, serial number, purchase date and place of purchase information in the space provided below. The serial number and model number are recorded on the label affixed to your computer. All correspondence concerning your unit should include the serial number, model number and purchase information.

No part of this publication may be reproduced, stored in a retrieval system, or transmitted, in any form or by any means, electronically, mechanically, by photocopy, recording or otherwise, without the prior written permission of Acer Incorporated.

Aspire 3610 Series Notebook PC

Model number: \_\_\_\_\_

Serial number: \_\_\_\_\_

Date of purchase: \_\_\_\_\_

Place of purchase: \_\_\_\_\_

Acer and the Acer logo are registered trademarks of Acer Incorporated. Other companies' product names or trademarks are used herein for identification purposes only and belong to their respective companies.

# First things first

We would like to thank you for making the Aspire series of notebook PC your choice for meeting your mobile computing needs.

## Your guides

To help you use your Aspire, we have designed a set of guides:



First off, the **Just for Starters...** poster helps you get started with setting up your computer.



The printed **User's Guide** introduces you to the basic features and functions of your new computer. For more on how your computer can help you to be more productive, please refer to the **AcerSystem User's Guide**. This guide contains detailed information on such subjects as system utilities, data recovery, expansion options and troubleshooting. In addition it contains warranty information and the general regulations and safety notices for your notebook. It is available in Portable Document Format (PDF) and comes preloaded on your notebook. Follow these steps to access it:

- 1 Click on **Start, All Programs, AcerSystem**.
- 2 Click on **AcerSystem User's Guide**.

**Note:** Viewing the file requires Adobe Acrobat Reader. If Adobe Acrobat Reader is not installed on your computer, clicking on **AcerSystem User's Guide** will run the Acrobat Reader setup program first. Follow the instructions on the screen to complete the installation. For instructions on how to use Adobe Acrobat Reader, access the **Help and Support** menu.

## Basic care and tips for using your computer

### Turning your computer on and off

To turn on the computer, simply press and release the power button below the LCD screen beside the easy-launch buttons. See "**Front view**" on **page 1** for the location of the power button.

To turn the power off, do any of the following:

- Use the Windows shutdown command  
Click on **Start, Turn Off Computer**, then click on **Turn Off**.
- Use the power button  
You can also shut down the computer by closing the display cover, or by pressing the sleep hotkey **<Fn> + <F4>**.



.....

**Note:** If you cannot power off the computer normally, press and hold the power button for more than four seconds to shut down the computer. If you turn off the computer and want to turn it on again, wait at least two seconds before powering up.

## Taking care of your computer

Your computer will serve you well if you take care of it.

- Do not expose the computer to direct sunlight. Do not place it near sources of heat, such as a radiator.
- Do not expose the computer to temperatures below 0 °C (32 °F) or above 50 °C (122 °F).
- Do not subject the computer to magnetic fields.
- Do not expose the computer to rain or moisture.
- Do not spill water or any liquid on the computer.
- Do not subject the computer to heavy shock or vibration.
- Do not expose the computer to dust or dirt.
- Never place objects on top of the computer.
- Do not slam the computer display when you close it.
- Never place the computer on uneven surfaces.

## Taking care of your AC adapter

Here are some ways to take care of your AC adapter:

- Do not connect the adapter to any other device.
- Do not step on the power cord or place heavy objects on top of it. Carefully route the power cord and any cables away from foot traffic.
- When unplugging the power cord, do not pull on the cord itself but pull on the plug.
- The total ampere ratings of the equipment plugged in should not exceed the ampere rating of the cord if you are using an extension cord. Also, the total current rating of all equipment plugged into a single wall outlet should not exceed the fuse rating.

## Taking care of your battery pack

Here are some ways to take care of your battery pack:

- Use only batteries of the same kind as replacements. Turn the power off before removing or replacing batteries.
- Do not tamper with batteries. Keep them away from children.
- Dispose of used batteries according to local regulations. Recycle if possible.

## Cleaning and servicing

When cleaning the computer, follow these steps:

- 1 Turn off the computer and remove the battery pack.
- 2 Disconnect the AC adapter.
- 3 Use a soft, moist cloth. Do not use liquid or aerosol cleaners.

If either of the following occurs:

- the computer has been dropped or the body has been damaged;
- the computer does not operate normally

please refer to **"Frequently asked questions" on page 22**.

## Caution

Changes or modifications not expressly approved by the manufacturer could void the user's authority, which is granted by the Federal Communications Commission, to operate this computer.

## Operation conditions

This device complies with Part 15 of the FCC Rules. Operation is subject to the following two conditions: (1) This device may not cause harmful interference, and (2) This device must accept any interference received, including interference that may cause undesired operation.

Users are requested to follow the RF safety instructions for wireless option devices that are included in the user's manual of each RF option device.

An improper installation or unauthorized use may cause harmful interference to radio communications. Also, any tampering of the internal antenna will void the FCC certification and your warranty.

To prevent radio interference to the licensed service, this device is intended to be operated indoors, and installation outdoors is subject to licensing.

For more information about our products, services, and support information, please visit our website: <http://global.acer.com>.

# Contents

First things first	iii
Your guides	iii
Basic care and tips for using your computer	iii
Turning your computer on and off	iii
Taking care of your computer	iv
Taking care of your AC adapter	iv
Taking care of your battery pack	v
Cleaning and servicing	v
An Aspire tour	1
Front view	1
Closed front view	2
Left view	3
Right view	3
Rear view	4
Base view	5
Specifications	6
Indicators	8
Easy-launch buttons	9
Touchpad	10
Touchpad basics	10
Using the keyboard	12
Lock keys and embedded numeric keypad	12
Windows keys	13
Hotkeys	13
Special keys	15
Ejecting the optical (CD or DVD) drive tray	16
Using a computer security lock	16
Audio	17
Adjusting the volume	17
Using the system utilities	18
Acer eManager	18
Acer GridVista (dual-display compatible)	19
Launch Manager	20
Norton AntiVirus	21
Frequently asked questions	22
Requesting service	25
International Travelers Warranty (ITW)	25
Before you call	25

Acer Arcade	26
Arcade hotkeys	27
Finding and playing content	28
Settings	28
Arcade controls	28
Navigation controls	29
Player controls	29
Cinema	29
DVD settings	30
Album	31
Slideshow settings	32
Video	32
Playing a video file	32
Video authoring	33
Music	33
Burner	34
Copy — Back up your CD/DVD collection	34
Audio — Create your own greatest hits CDs	34
Data — Store files simply and easily	34
Video — Your world in pictures	34
Taking your notebook PC with you	36
Disconnecting from the desktop	36
Moving around	36
Preparing the computer	36
What to bring to meetings	37
Taking the computer home	37
Preparing the computer	37
What to take with you	37
Special considerations	38
Setting up a home office	38
Traveling with the computer	38
Preparing the computer	38
What to take with you	38
Special considerations	39
Traveling internationally with the computer	39
Preparing the computer	39
What to bring with you	39
Special considerations	39

Securing your computer	40
Using a computer security lock	40
Using passwords	40
Entering passwords	41
Setting passwords	41
Expanding through options	42
Connectivity options	42
Fax/data modem	42
Built-in network feature	43
Universal Serial Bus (USB)	43
PC Card slot	44
BIOS utility	45
Boot sequence	45
Enable disk-to-disk recovery	46
Password	46
Using software	46
Playing DVD movies	46
Power management	47
Acer eRecovery	47
Create backup	48
Restore from backup	48
Create factory default image CD	48
Re-install bundled software without CD	49
Change password	49
Troubleshooting	50
Troubleshooting tips	50
Error messages	50
Regulations and safety notices	52
ENERGY STAR guidelines compliance	52
FCC notice	52
Modem notices	53
Important safety instructions	56
Laser compliance statement	58
LCD pixel statement	58
Radio device regulatory notice	58
General	59
European Union (EU)	59
The FCC RF safety requirement	60



Canada — Low-power license-exempt radio communication devices (RSS-210)	61
Environmental Policy Declaration	62
Federal Communications Commission Declaration of Conformity	63
Declaration of Conformity for CE Marking	64
Index	65



# An Aspire tour

After setting up your computer as illustrated in the **Just for Starters...** poster, let us show you around your new Aspire computer.

## Front view

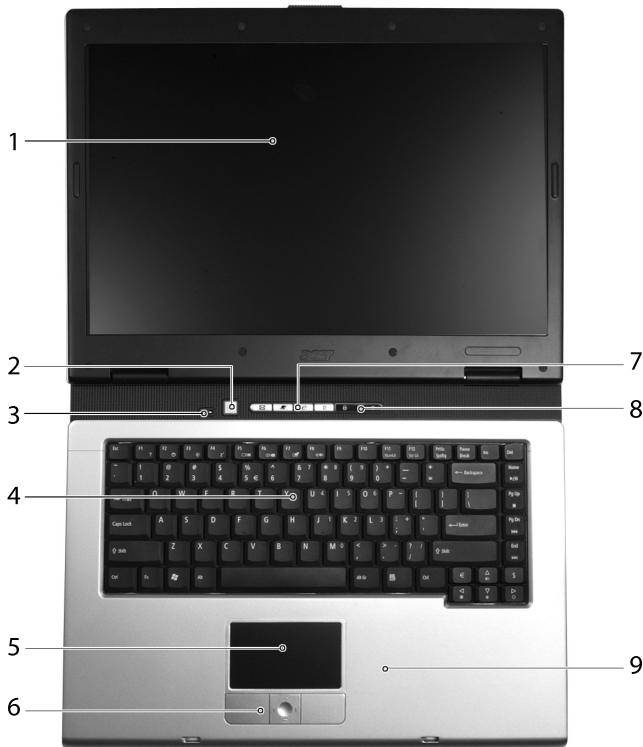





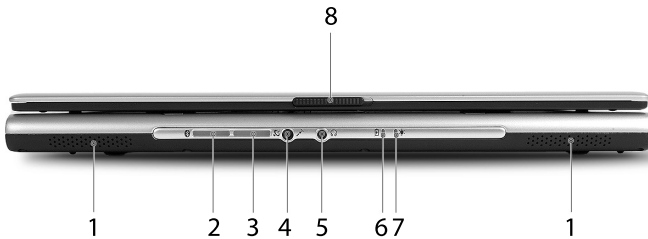

#	Item	Description
1	Display screen	Also called Liquid-Crystal Display (LCD), displays computer output.
2	Power button	Turns the computer on and off.
3	Microphone	Internal microphone for sound recording.
4	Keyboard	For entering data into your computer.

#	Item	Description
5	Touchpad	Touch-sensitive pointing device which functions like a computer mouse.
6	Click buttons (left, center and right)	The left and right buttons function like the left and right mouse buttons; the center button serves as a 4-way scroll button.
7	Easy-launch buttons	Buttons for launching frequently used programs. See " <b>Easy-launch buttons</b> " on page 9 for more details.
8	Status indicators	Light-Emitting Diodes (LEDs) that light up to show the status of the computer's functions and components.
9	Palmrest	Comfortable support area for your hands when you use the computer.

## Closed front view





#	Icon	Item	Description
1		Speakers	Left and right speakers deliver stereo audio output.
2		Bluetooth communication button/indicator	Press to enable/disable the Bluetooth function. Indicates the status of Bluetooth communication.
3		Wireless communication button/indicator	Press to enable/disable the wireless function. Indicates the status of WLAN communication.
4		Microphone/line-in jack	Accepts audio line-in devices (e.g., audio CD player, stereo walkman).
5		Headphones/speakers/line-out jack	Connects to audio line-out devices (e.g., speakers, headphones).
6		Battery indicator	Lights when the battery is being charged.

#	Icon	Item	Description
7		Power indicator	Lights when the computer is on.
8		Latch	Locks and releases the lid.

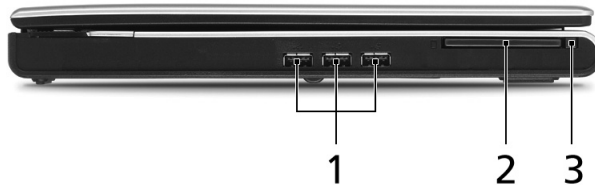
## Left view



#	Icon	Item	Description
1		Three USB 2.0 ports	Connect to USB 2.0 devices (e.g., USB mouse, USB camera).
2		PC Card slot	Accepts one Type II PC Card.
3		PC Card slot eject button	Ejects the PC Card from the slot.



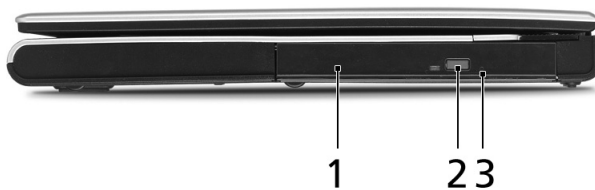



## Right view

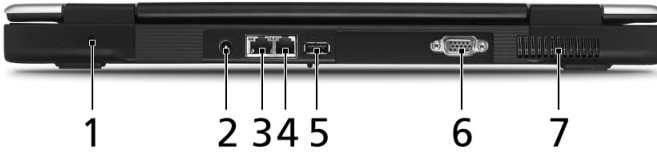

#	Item	Description
1	Optical drive	Internal optical drive; accepts CDs or DVDs depending on the optical drive type.
2	Optical drive eject button	Ejects the optical drive tray from the drive.
3	Emergency eject hole	Ejects the optical drive tray when the computer is turned off.

## Rear view



#	Icon	Item	Description
1		Kensington lock slot	Connects to a Kensington-compatible computer security lock.
2		DC-in jack	Connects to an AC adapter.
3		Ethernet (RJ-45) port	Connects to a Fast Ethernet network.
4		Modem (RJ-11) port	Connects to a phone line.
5		USB 2.0 port	Connects to USB 2.0 devices (e.g., USB mouse, USB camera).
6		External display (VGA) port	Connects to a display device (e.g., external monitor, LCD projector).
7		Ventilation slots	Enable the computer to stay cool, even after prolonged use.

## Base view

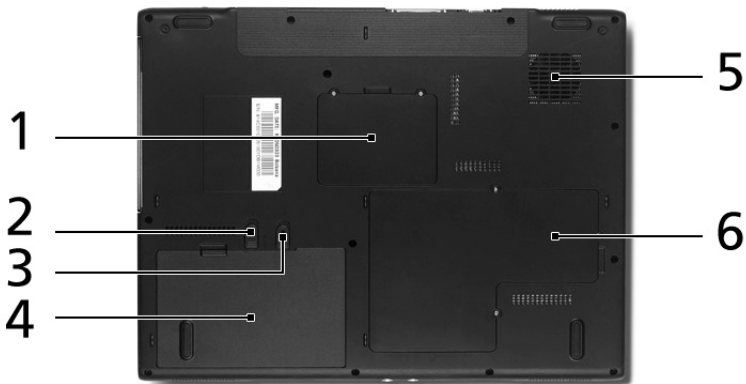

#	Item	Description
1	Memory bay	Houses the computer's main memory.
2	Battery lock	Locks the battery in place.
3	Battery release latch	Releases the battery for removal.
4	Battery bay	Houses the computer's battery pack.
5	Cooling fan	Helps keep the computer cool. <b>Note:</b> Do not cover or obstruct the opening of the fan.
6	Wireless LAN and hard disk bay	Houses the computer's WLAN and hard disk (secured with screws).

# Specifications

Operating system	Microsoft® Windows® XP Home Edition (Service Pack 2) Microsoft® Windows® XP Professional (Service Pack 2)
Platform	Processor: <ul style="list-style-type: none"> <li>• Intel® Celeron® M processor 360/370/380 (1 MB L2 cache, 1.40/1.50/1.60 GHz, 400 MHz FSB)</li> <li>• Intel® Pentium® M processor 725A (2 MB L2 cache, 1.60 GHz, 400 MHz FSB)</li> </ul> Chipset: Intel® 910GML
System memory	256/512 MB of DDR2 400 memory, upgradeable to 2 GB using two soDIMM modules
Display and graphics	15" XGA color TFT LCD, 1024 x 768 resolution 15.4" WXGA color TFT LCD, 1280 x 800 resolution 15.4" WXGA Acer CrystalBrite color TFT LCD, 1280 x 800 resolution 16.7 million colors Intel® GMA 900 graphics with up to 128 MB of shared memory, supporting Microsoft® DirectX® 9.0 Dual independent display support MPEG-2/DVD hardware-assisted capability
Storage subsystem	40/60/80 GB ATA/100 hard disk drive Optical drive options: <ul style="list-style-type: none"> <li>• DVD-Dual double-layer drive</li> <li>• DVD/CD-RW combo drive</li> </ul>
Dimensions and weight	363 (W) x 275 (D) x 24/32.9 (H) mm (14.29 x 10.83 x 0.94/1.3 inches) 2.74 kg (6.04 lbs.) for 15" LCD model 2.75 kg (6.06 lbs.) for 15.4" LCD model
Power subsystem	ACPI 2.0 power management standard: supports Standby and Hibernation power-saving modes 29.6 or 65 W Li-ion battery pack 2.5-hour rapid charge, 3.5-hour charge-in-use 65 W AC adapter
Input devices	88-/89-key keyboard Built-in touchpad with 4-way scroll button Four easy-launch buttons Two front-access buttons: WLAN LED-button and Bluetooth® LED-button
Audio	Audio system with two built-in speakers Sound Blaster Pro™ and MS-Sound compatible Built-in microphone



Communication	Modem: 56K ITU V.92 with PTT approval; Wake-on-Ring ready LAN: 10/100 Mbps Fast Ethernet; Wake-on-LAN ready WLAN (manufacturing option): integrated Acer InviLink™ 802.11b/g Wi-Fi® CERTIFIED™ solution; supporting Acer SignalUp technology WPAN (manufacturing option): integrated Bluetooth®
I/O interface	Four USB 2.0 ports Ethernet (RJ-45) port Modem (RJ-11) port External display (VGA) port Microphone/line-in jack Headphones/speakers/line-out jack PC Card slot (one Type II) DC-in jack for AC adapter
Security	Kensington lock slot BIOS user and supervisor passwords
Software	Acer eManager (Acer ePowerManagement/ePresentation/ eRecovery/eSettings) Acer GridVista 2.0 Acer Launch Manager Acer Arcade Adobe® Reader® Norton AntiVirus™ NTI CD-Maker™
Options and accessories	256/512 MB or 1 GB DDR2 533 soDIMM memory Li-ion battery pack 65 W AC adapter External USB floppy drive
Environment	Temperature: <ul style="list-style-type: none"> <li>• Operating: 5° C to 35° C</li> <li>• Non-operating: -20° C to 65° C</li> </ul> Humidity (non-condensing): <ul style="list-style-type: none"> <li>• Operating: 20% to 80%</li> <li>• Non-operating: 20% to 80%</li> </ul>
System compliance	Mobile PC 2002 ACPI 2.0 DMI 2.0 Cisco Compatible Extensions (CCX)
Warranty	One-year International Travelers Warranty (ITW)









**Note:** The specifications listed above are for reference only. The exact configuration of your PC depends on the model purchased.

# Indicators

The computer has three easy-to-read status indicators on the upper-right above the keyboard, and four on the front panel.



The power, battery and wireless communication status indicators are visible even when the LCD display is closed.

Icon	Function	Description
	Caps Lock	Lights up when Caps Lock is activated.
	Num Lock	Lights up when Num Lock is activated.
	Media activity	Indicates when the hard disk or optical drive is active.
	Bluetooth	Indicates the status of Bluetooth communication.
	Wireless LAN	Indicates the status of wireless LAN communication.
	Battery	Lights up when the battery is being charged.
	Power	Lights up when the computer is on.



1. **Charging:** The light shows amber when the battery is charging.
2. **Fully charged:** The light shows green when in AC mode.

## Easy-launch buttons

Located at the upper-left, above the keyboard are four buttons. These buttons are called easy-launch buttons. They are: mail, Web browser, Acer Empowering Key <e> and one user-programmable button.

Press <e> to run the Acer eManager. Please see **"Acer eManager"** on page 18. The mail and Web browser buttons are pre-set to email and Internet programs, but can be reset by users. To set the Web browser, mail and programmable buttons, run the Acer Launch Manager. See **"Launch Manager"** on page 20.



Easy-launch button	Default application
Mail	Email application (user-programmable)
Web browser	Internet browser (user-programmable)
e	Acer eManager (user-programmable)
P	User-programmable

# Touchpad

The built-in touchpad is a pointing device that senses movement on its surface. This means the cursor responds as you move your finger across the surface of the touchpad. The central location on the palmrest provides optimum comfort and support.



## Touchpad basics

The following items show you how to use the touchpad:



- Move your finger across the touchpad **(2)** to move the cursor.
- Press the left **(1)** and right **(4)** buttons located beneath the touchpad to perform selection and execution functions. These two buttons are similar to the left and right buttons on a mouse. Tapping on the touchpad is the same as clicking the left button.
- Use the 4-way scroll **(3)** button to scroll up or down and move left or right a page. This button mimics your cursor pressing on the right scroll bar of Windows applications.

Function	Left button (1)	Right button (4)	Main touchpad (2)	Center button (3)
Execute	Quickly click twice.		Tap twice (at the same speed as double-clicking a mouse button).	
Select	Click once.		Tap once.	
Drag	Click and hold, then use finger on the touchpad to drag the cursor.		Tap twice (at the same speed as double-clicking a mouse button); rest your finger on the touchpad on the second tap and drag the cursor.	
Access context menu		Click once.		
Scroll				Click and hold to move up/down/left/right.



**Note:** When using the touchpad, keep it — and your fingers — dry and clean. The touchpad is sensitive to finger movement; hence, the lighter the touch, the better the response. Tapping harder will not increase the touchpad's responsiveness.

# Using the keyboard

The keyboard has full-sized keys and an embedded numeric keypad, separate cursor, lock, Windows, function and special keys.

## Lock keys and embedded numeric keypad

The keyboard has three lock keys which you can toggle on and off.





Lock key	Description
Caps Lock	When Caps Lock is on, all alphabetic characters typed are in uppercase.
Num Lock <Fn> + <F11>	When Num Lock is on, the embedded keypad is in numeric mode. The keys function as a calculator (complete with the arithmetic operators +, -, *, and /). Use this mode when you need to do a lot of numeric data entry. A better solution would be to connect an external keypad.
Scroll Lock <Fn> + <F12>	When Scroll Lock is on, the screen moves one line up or down when you press the up or down arrow keys respectively. Scroll Lock does not work with some applications.

The embedded numeric keypad functions like a desktop numeric keypad. It is indicated by small characters located on the upper right corner of the keycaps. To simplify the keyboard legend, cursor-control key symbols are not printed on the keys.

Desired access	Num Lock on	Num Lock off
Number keys on embedded keypad	Type numbers in a normal manner.	
Cursor-control keys on embedded keypad	Hold <Shift> while using cursor-control keys.	Hold <Fn> while using cursor-control keys.
Main keyboard keys	Hold <Fn> while typing letters on embedded keypad.	Type the letters in a normal manner.

## Windows keys











The keyboard has two keys that perform Windows-specific functions.

Key	Description
 Windows key	<p>Pressed alone, this key has the same effect as clicking on the Windows Start button; it launches the Start menu. It can also be used with other keys to provide a variety of functions:</p> <ul style="list-style-type: none"> <li>&lt;Windows&gt; + &lt;Tab&gt;: Activates the next Taskbar button.</li> <li>&lt;Windows&gt; + &lt;E&gt;: Opens the My Computer window.</li> <li>&lt;Windows&gt; + &lt;F1&gt;: Opens Help and Support Center.</li> <li>&lt;Windows&gt; + &lt;F&gt;: Opens the Search Results window.</li> <li>&lt;Windows&gt; + &lt;R&gt;: Opens the Run dialog box.</li> <li>&lt;Windows&gt; + &lt;M&gt;: Minimizes all windows.</li> <li>&lt;Shift&gt; + &lt;Windows&gt; + &lt;M&gt;: Undoes the minimize all windows action.</li> </ul>
 Application key	<p>This key has the same effect as clicking the right mouse button; it opens the application's context menu.</p>

## Hotkeys

The computer employs hotkeys or key combinations to access most of the computer's controls like screen brightness, volume output and the BIOS utility. To activate hotkeys, press and hold the <Fn> key before pressing the other key in the hotkey combination.



Hotkey	Icon	Function	Description
<Fn> + <F1>	?	Hotkey help	Displays help on hotkeys.
<Fn> + <F2>		Acer eSettings	Launches Acer eSettings in Acer eManager. See " <b>Acer eManager</b> " on page 18.
<Fn> + <F3>		Acer ePowerManagement	Launches Acer ePowerManagement in Acer eManager. See " <b>Acer eManager</b> " on page 18.
<Fn> + <F4>	Z <sup>Z</sup>	Sleep	Puts the computer in Sleep mode.
<Fn> + <F5>		Display toggle	Switches display output between the display screen, external monitor (if connected) and both.
<Fn> + <F6>		Screen blank	Turns the display screen backlight off to save power. Press any key to return.
<Fn> + <F7>		Touchpad toggle	Turns the internal touchpad on and off.
<Fn> + <F8>		Speaker toggle	Turns the speakers on and off.
<Fn> + <↑>		Volume up	Increases the sound volume.
<Fn> + <↓>		Volume down	Decreases the sound volume.
<Fn> + <←>		Brightness up	Increases the screen brightness.
<Fn> + <⇐>		Brightness down	Decreases the screen brightness.



## Special keys

You can locate the Euro symbol and the US dollar sign at the upper-center and/or bottom-right of your keyboard.



### The Euro symbol

- 1 Open a text editor or word processor.
- 2 Either press < € > at the bottom-right of the keyboard, or hold <Alt Gr> and then press the <5> key at the upper-center of the keyboard.



.....

**Note:** Some fonts and software do not support the Euro symbol. Please refer to [www.microsoft.com/typography/faq/faq12.htm](http://www.microsoft.com/typography/faq/faq12.htm) for more information.

### The US dollar sign

- 1 Open a text editor or word processor.
- 2 Either press < \$ > at the bottom-right of the keyboard, or hold <Shift> and then press the <4> key at the upper-center of the keyboard.



.....

**Note:** This function varies according to the language settings.

## Ejecting the optical (CD or DVD) drive tray

To eject the optical drive tray when the computer is turned on, press the drive eject button.



When the power is off, you can eject the drive tray by using the emergency eject hole.

## Using a computer security lock

A security keylock notch, located on the chassis of the computer, lets you connect a Kensington-compatible computer security lock.



Wrap the computer security lock cable around an immovable object such as a table or handle of a locked drawer. Insert the lock into the notch and turn the key to secure the lock. Some keyless models are also available.

# Audio

The computer comes with 16-bit high-fidelity AC'97 stereo audio, and dual stereo speakers.



## Adjusting the volume

Adjusting the volume on the computer is as easy as pressing some buttons. See **"Hotkeys"** on **page 13** for more information on adjusting the speaker volume.

# Using the system utilities



**Note:** The system utilities work under Microsoft Windows XP only.

## Acer eManager

The innovative Acer eManager software is designed for easy access to frequently used functions. Press <e> to launch the Acer eManager user interface, which features four main settings: Acer ePowerManagement, Acer ePresentation, Acer eRecovery and Acer eSettings.



To set the <e> key, see "**Easy-launch buttons**" on page 9.



### **Acer ePowerManagement**

Provides a central location from which to control all your PC's power schemes and maximize battery life.



### **Acer ePresentation**

Simplifies resolution settings when connecting to a projector.



### **Acer eRecovery**

Creates backups and recovers system configurations reliably.



### **Acer eSettings**

Makes managing system settings and security easy.

For more information, open Acer eManager, click on the appropriate application and select the Help function.



**Note:** If your computer did not come with a Recovery CD or System CD, please use Acer eRecovery's "System backup to optical disk" feature to burn a backup image to CD or DVD. To ensure the best results when recovering your system using a CD or Acer eRecovery, detach all peripherals (except the external Acer ODD, if your computer has one).

## Acer GridVista (dual-display compatible)



**Note:** This feature is only available on certain models.

To enable the dual monitor feature of your notebook, first ensure that the second monitor is connected, then, select **Start, Control Panel, Display** and click on **Settings**. Select the secondary monitor (2) icon in the display box and then click the check box **Extend my Windows desktop onto this monitor**. Finally, click **Apply** to confirm the new settings and click **OK** to complete the process.

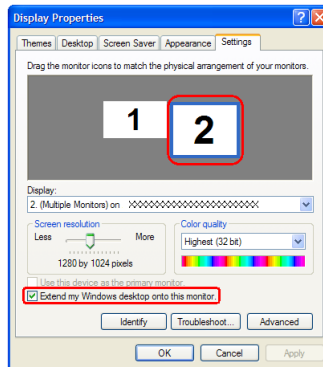

Acer GridVista is a handy utility that offers four pre-defined display settings so you can view multiple windows on the same screen. To access this function, please go to **Start, All Programs** and click on **Acer GridVista**. You may choose any one of the four display settings indicated below:



Double (vertical), Triple (primary at left), Triple (primary at right), or Quad

Acer GridVista is dual-display compatible, allowing two displays to be partitioned independently.

Acer GridVista is simple to set up:

- 1 Run Acer GridVista and select your preferred screen configuration for each display from the taskbar.
- 2 Drag and drop each window into the appropriate grid.
- 3 Enjoy the convenience of a well-organized desktop.

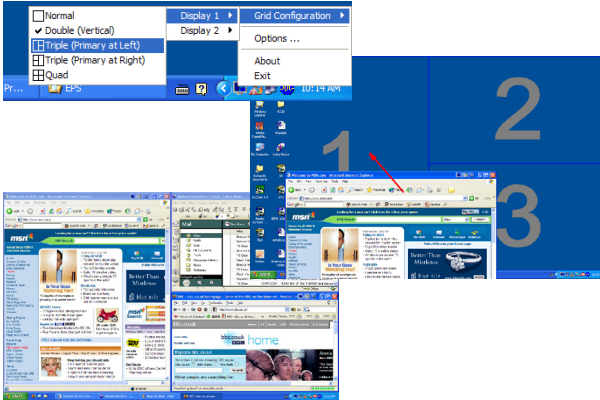

**Note:** Please ensure that the resolution setting of your second monitor is set to the manufacturer's recommended value.

## Launch Manager

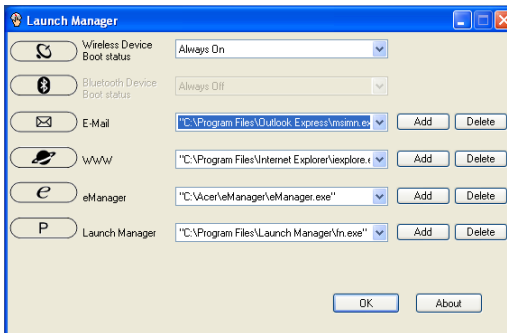

Launch Manager allows you to set the four easy-launch buttons located above the keyboard. **"Easy-launch buttons" on page 9** for the location of the easy-launch buttons.

You can access the Launch Manager by clicking on **Start, All Programs**, and then **Launch Manager** to start the application.

## Norton AntiVirus

Norton AntiVirus is an anti-virus software that finds and repairs infected files, and protects against viruses to keep your computer data safe and secure.

### How do I check for viruses?

A Full System Scan scans all files on your computer. To perform a system scan:

- 1 Start Norton AntiVirus.

Double click on the **Norton AntiVirus** Icon on the desktop or click on the **Start** menu in the Windows taskbar, highlight **Programs**, and select **Norton AntiVirus**.

- 2 In the Norton AntiVirus main window, click **Scan for Viruses**.

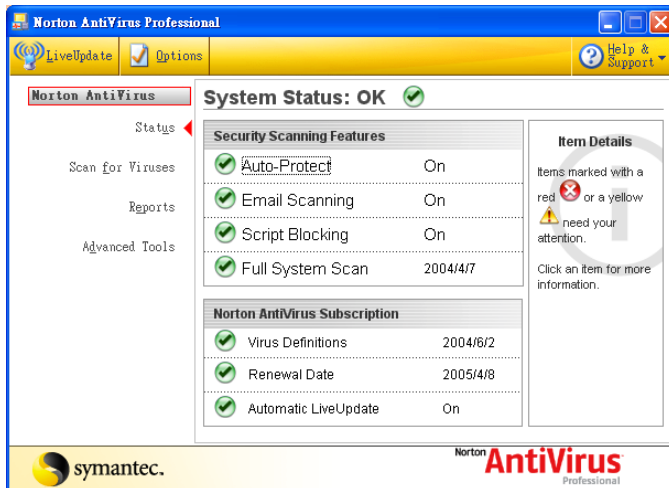

- 3 In the **Scan for Viruses** panel, click **Scan My Computer**.
- 4 Under **Actions**, click **Scan**.
- 5 When the scan is complete, a scan summary appears. Click **Finished**.

You can schedule customized virus scans that run unattended on specific dates and times or at periodic intervals. If you are using the computer when the scheduled scan begins, it runs in the background so that you do not have to stop working.

For more information refer to the Norton AntiVirus Help menu.

# Frequently asked questions

The following is a list of possible situations that may arise during the use of your computer. Easy solutions are provided for each one.

I pressed the power button, but the computer does not start or boot up.

Look at the power indicator:

- If it is not lit, no power is being supplied to the computer. Check the following:
  - If you are using on the battery, it may be low and unable to power the computer. Connect the AC adapter to recharge the battery pack.
  - Make sure that the AC adapter is properly plugged into the computer and to the power outlet.
- If it is lit, check the following:
  - Is a non-bootable (non-system) disk in the external USB floppy drive? Remove or replace it with a system disk and press **<Ctrl> + <Alt> + <Del>** to restart the system.

Nothing appears on the screen.

The computer's power management system automatically blanks the screen to save power. Press any key to turn the display back on.

If pressing a key does not turn the display back on, three things might be the cause:

- The brightness level might be too low. Press **<Fn> + <→>** (increase) to adjust the brightness level.
- The display device might be set to an external monitor. Press the display toggle hotkey **<Fn> + <F5>** to toggle the display back to the computer.
- If the Sleep indicator is lit, the computer is in Sleep mode. Press and release the power button to resume.

Image is not full-screen.

Each computer display has a different native resolution depending on the screen. If you set the resolution lower than this native resolution, the screen expands to fill the computer display. Right-click on your Windows desktop and select **Properties** to bring up the "Display Properties" dialog box. Then click on the **Settings** tab to make sure that the resolution is set to the appropriate resolution. Resolutions lower than the specified resolution are not full-screen on the computer or on an external monitor.



## No audio is heard from the computer.

Check the following:

- The volume may be muted. In Windows, look at the volume control (speaker) icon on the taskbar. If it is crossed-out, click on the icon and deselect the **Mute all** option.
- The volume level may be too low. In Windows, look at the volume control icon on the taskbar. You can also use the volume control buttons to adjust the volume. See "**Hotkeys**" on page 13 for more detail.
- If headphones, earphones or external speakers are connected to the line-out port on the computer, the internal speakers automatically turn off.

## I want to eject the optical drive tray without turning on the power.

There is a mechanical eject hole on the optical drive. Simply insert the tip of a pen or paperclip into the hole and push to eject the tray.

## The keyboard does not respond.

Try attaching an external keyboard to a USB port on the computer. If it works, contact your dealer or an authorized service center as the internal keyboard cable may be loose.

## The printer does not work.

Check the following:

- Make sure that the printer is connected to a power outlet and that it is turned on.
- Make sure that the printer cable is connected securely to the computer's USB port and the corresponding port on the printer.

## I want to set up my location to use the internal modem.

To properly use your communication software (e.g. HyperTerminal), you need to set up your location:

- 1 Click on **Start, Settings, Control Panel**.
- 2 Double-click on **Phone and Modem Options**.
- 3 Click on **Dialing Rules** and begin setting up your location.

Refer to the Windows manual.



**Note:** Please note, on first booting your notebook, that you can skip the Internet Connection setup, as it is not necessary to complete the installation of your Operating System. After the Operating System is set up, you can proceed with the Internet Connection setup.

I want to restore my computer to its original settings without recovery CDs.



**Note:** If your system is the multilingual version, the operating system and language you choose when you first turn on the system will be the only option for future recovery operations.

This recovery process helps you restore the C: drive with the original software content that is installed when you purchase your notebook. Follow the steps below to rebuild your C: drive. (Your C: drive will be reformatted and all data will be erased.) It is important to back up all data files before using this option.

Before performing a restore operation, please check the BIOS settings.

- 1 Check to see if **Acer disk-to-disk recovery** is enabled or not.
- 2 Make sure the **D2D Recovery** setting in **Main** is **Enabled**.
- 3 Exit the BIOS utility and save changes. The system will reboot.



**Note:** To activate the BIOS utility, press **<F2>** during POST.

To start the recovery process:

- 1 Restart the system.
- 2 While the Acer logo is showing, press **<Alt> + <F10>** at the same time to enter the recovery process.
- 3 Refer to the on-screen instructions to perform system recovery.



**Important!** This feature occupies 2 to 3 GB in a hidden partition on your hard disk.

## Requesting service

### International Travelers Warranty (ITW)

Your computer is backed by an International Travelers Warranty (ITW) that gives you security and peace of mind when traveling. Our worldwide network of service centers are there to give you a helping hand.

An ITW passport comes with your computer. This passport contains all you need to know about the ITW program. A list of available, authorized service centers is in this handy booklet. Read this passport thoroughly.

Always have your ITW passport on hand, especially when you travel, to receive the benefits from our support centers. Place your proof-of-purchase in the flap located inside the front cover of the ITW passport.

If the country you are traveling in does not have an Acer-authorized ITW service site, you can still get in contact with our offices worldwide. Please consult <http://global.acer.com>.

### Before you call

Please have the following information available when you call Acer for online service, and please be at your computer when you call. With your support, we can reduce the amount of time a call takes and help solve your problems efficiently.

If there are error messages or beeps reported by your computer, write them down as they appear on the screen (or the number and sequence in the case of beeps).

You are required to provide the following information:

Name: \_\_\_\_\_

Address: \_\_\_\_\_

Telephone number: \_\_\_\_\_

Machine and model type: \_\_\_\_\_

Serial number: \_\_\_\_\_

Date of purchase: \_\_\_\_\_

# Acer Arcade

Acer Arcade is an integrated player for music, photos, DVD movies and videos. To watch or listen, click a content button (e.g., Music, Video, etc.) on the Arcade home page.



- **Cinema** — Watch DVDs or VCDs
- **Album** — View photos stored on your hard disk or removable media
- **Video** — Watch and/or edit video clips
- **Music** — Listen to music files in a variety of formats
- **Burner** — Create CDs and/or DVDs to share or archive data
- **Settings** — Adjust Acer Arcade according to your preferences



.....

**Note:** While watching videos, DVDs or slideshows, your screensaver and power-saving features are unavailable. These functions are enabled when you listen to music.

## Arcade hotkeys

When running in the Windows environment, the key combinations listed below are available to control and fine-tune the features and settings of Acer Arcade.

Hotkey	Function
<Fn> + <F1>	Online help menu
<Fn> + <F3>	Acer ePowerManagement with battery information
<Fn> + <F5>	Display toggle
<Fn> + <F6>	Screen blank
<Fn> + <F8>	Speaker toggle
<Fn> + <↑>	Volume up; increases the speaker volume.
<Fn> + <↓>	Volume down; decreases the speaker volume
<Fn> + <→>	Brightness up; increases the screen brightness
<Fn> + <←>	Brightness down; decreases the screen brightness
<Fn> + <Home>	Play; press to start playing the audio track or video file. Press again to pause.
<Fn> + <Pg Up>	Stop; press to stop playing the audio track or video file.
<Fn> + <Pg Dn>	Backward; press to skip backward to the previous track or video file and start playing.
<Fn> + <End>	Forward; press to skip forward to the next track or video file.

## Finding and playing content

Clicking a button on the Arcade home page opens the corresponding feature's home page. The content pages have buttons on the left and a content browsing area on the right. If a button shows one of several choices, such as sort order, the current setting is shown by a brightly colored ball on the left side.

To pick content, click an item in the content area. When there is more than one CD or DVD drive, all drives will be shown. Pictures and videos are shown as files (with thumbnails) and organized into folders.

To browse a folder, click to open it. To go back up to the folder above it, click the **Up one level** button. If there is more content than will fit on a page, use the buttons at the lower right to scroll through the pages.

## Settings

There are settings in Acer Arcade that allow you to fine tune its performance to your machine and your personal preferences. The Settings page is reached by the **Advanced Settings** button on the Home page.

Use the "screen ratio" setting to choose between standard (4:3) or widescreen (16:9) display.

"Audio output" should be set to "Stereo" if you are listening to speakers, or "Virtual surround sound" if you are using headphones.



**Note:** If your speakers are not capable of outputting low frequency signals, it is recommended that you do not select this option in order to avoid damaging your speakers.

Click **About Acer Arcade** to open a page with version and copyright information.

Click **Restore to factory settings** to return the Acer Arcade settings to their default values.

## Arcade controls

When watching video clips, movies, or slideshows as full-screen visual content, two pop-up control panels are shown when you move the mouse. They automatically disappear after several seconds. The "Navigation controls" panel appears at the top and the "Player controls" panel appears at the bottom of the screen.

## Navigation controls

To return to the Arcade home page, click the **Home** button in the upper left corner of the window. To go up one folder level while searching for content, click **Up one level**. To return to a previous screen, click **Return**. The buttons in the upper right (minimize, maximize, and close) have standard PC behaviours.

To quit Arcade, click the **Close** button in the upper right corner of the window. You can also click **To PC**.

## Player controls

At the bottom of the window, the player controls — used for video, slideshows, movies and music — are shown. The group on the left provides standard playback controls (play, pause, stop, etc.). The group on the right controls volume (mute and volume up/down).



**Note:** When playing DVDs, there are additional controls added to the right of the volume controls. These are discussed in more detail in the Cinema section of this guide.

## Cinema

If your computer came with a DVD drive, you can play movies from DVDs and Video CDs (VCDs) with the Cinema function of Acer Arcade. This player has the features and controls of a typical DVD player.

When you insert a disk into the DVD drive, the movie begins playing automatically. To control the movie, the pop-up player control panel appears at the bottom of the window when you move the mouse.

If more than one optical drive contains a playable disk, click the **Cinema** button on the Home page to open the Cinema content page, then select the disk you'd like to watch from the list on the right.

When viewing DVDs, the following special controls are added to the pop-up panel:

- DVD Menu
- Subtitle
- Language
- Angle

The disk currently playing will be shown in the area above the list of drives. This page is also displayed when you press the **Stop** button during a movie. The buttons on the left side allow you to resume the movie from the point it was stopped, restart the movie from the beginning, jump to the DVD menu, eject the disk, or go to the "DVD Settings" page.

## DVD settings

There are two types of DVD settings: "Video" and "Language." Click the appropriate button to open its settings page.

### Video

The Video settings control the video output of DVDs/VCDs.

**Hardware acceleration** takes advantage of the special processing power of some graphics cards to reduce CPU loading when playing back DVDs and video files. If you have problems with video quality, try turning this option **Off**.

Select an output type:

- **4:3 Standard** or **16:9 Widescreen** according to your display preferences.
- The **Letterbox** option displays widescreen movie content in its original aspect ratio and adds black bars at the top and bottom of the screen.
- The **Pan & Scan** feature is for DVD titles with a widescreen aspect ratio.
- Acer CinemaVision is a nonlinear video stretching technology that produces minimal distortion in the center of the picture.
- **Stretch** stretches the video display to the size of the display screen.
- The "Color profile" option allows you to select from a list of color configurations to change the overall color of the video content during playback. "Original" uses the color scheme of the disk you are watching, while "Vivid," "Bright" and "Theater" add enhanced color to the video display.
- Acer ClearVision is a video enhancement technology that detects video content and dynamically adjusts the brightness/contrast/saturation levels so that you do not need to change the color settings if the movie you are watching contains scenes that are overly dark or too bright.
- Click **Restore to factory settings** to return the settings to their default values.

### Language

The "Language settings" control the audio and subtitle output of DVDs/VCDs.

"Subtitle" selects the default subtitle language for DVDs when available. The factory setting is "Off."

"Closed caption" turns on the closed captions on DVDs. This function displays captions encoded in the video signal that describe onscreen action and dialog for the hearing impaired. The factory setting is "Off."

"Audio" selects the default language for DVD titles.



# Album

Acer Arcade lets you view digital photos individually or as a slideshow, from any available drive on your computer. Click the **Album** button on the Arcade Home page to show the Album main page.



The content area on the right shows both individual pictures and folders. Click on a folder to open it.



To view a slideshow, open the folder containing the pictures you wish to view, then click **Play slideshow**. The slideshow is played full-screen. Use the pop-up control panel to control the slideshow.

To rotate a picture in full-screen, click **Rotate right** or **Rotate left**.

You can also view a single picture by **clicking** on it. This opens the picture full-screen.

## Slideshow settings

To change slideshow settings, click the **Settings** button on the Album page.

"Slide duration" determines how long each slide is shown before automatically advancing to the next picture in the slideshow.

"Transition effects" sets the style of transition used between pictures.

To add background music to a slideshow, set the "Play music during slideshow" option to "Yes." The Select Music page will ask you to choose music from your personal music library.

Click **Restore to factory settings** to return your settings to their default values.

## Video

To open the Video function, click **Video** on the Arcade Home page.



-----

**Note:** The Video feature is designed to play back MPEG1, MPEG2 (if a DVD drive is installed), AVI, WMV and ASF formats. If you want to watch a DVD or VCD, use the "Cinema" function.

Two options are shown on the Video page: "Video Play" or "Video Edit."

## Playing a video file

Click **Video Play** to watch video files. The Video page shows the video files in the content area on the right side. They are organized by folders and a thumbnail image shows the first frame of the video.

To play a video file, click on it. The video will play full-screen. The pop-up control panel will appear at the bottom of the screen when you move the mouse. To return to the Video page, click **Stop**.

## Video authoring

Click the **Video Authoring** button to open the PowerProducer program, which allows you to finalize your digital video productions and burn them to disk. Before you produce your movie using PowerProducer, first gather (or create) its component parts: video clips, photos, and background music. You may collect raw footage yourself with a camcorder or other recording device, or you may simply use files that you have on hand; including movies you have already created in a video editing program.

When your movie is ready for production, use PowerProducer, which offers basic video editing tools. PowerProducer's production functions include:

- burns CDs, DVDs, VCDs, SVCDs and editable DVDs
- erases rewritable disks that contain unwanted content
- copies disks
- defragments disks for appending video content
- burns DV content straight to DVD
- sets chapters within video content
- adds background music to videos and menus
- offers custom menu layouts for buttons, frames and backgrounds
- captures from DVD, firewire devices, analog capture cards, USB devices and files

For help with authoring video, refer to PowerProducer's online help system.

## Music

For convenient access to your music collection, click **Music** on the Arcade homepage to open the Music homepage.

Select the folder or CD that contains the music you want to listen to. Click **Play** to listen to the entire content from the beginning, or select the song that you want to hear from the list in the content area.

The songs in the folder are shown in the content area, while the left side has controls for "Play," "Random," and "Repeat all." The Visualize option allows you to watch computer generated visualizations while you listen to music. When playing music, the control panel at the bottom of the page makes it easy to adjust the volume and control playback.

To rip music from a CD, click **Rip CD**. In the page that opens, select the songs you would like to rip (or click **Select** or **Clear all**), then click **Rip now**.

## Burner

NTI CD/DVD-Maker simplifies today's digital lifestyle by providing an easy and complete solution for recording data, audio, photos or video. Now you can burn and share anything on CD/DVD — your data, music, photos or videos — faster and easier than ever before.

### Copy — Back up your CD/DVD collection

Make backup copies of (non-copy-protected) CDs and DVDs with just a few clicks of your mouse.

### Audio — Create your own greatest hits CDs

Create better sounding music in a snap. Burn your favorite songs to CD so you can listen to them on any CD player. Convert songs from your music collection to MP3 and other popular audio formats. Even create MP3 CDs with over 100 of your favorite songs and listen to them on your PC or MP3 CD player.

### Data — Store files simply and easily

Copy your computer's hard disk files for easy recovery in the event of a crash. Archiving your data on CD/DVD eliminates the need for extra hard disks.

### Video — Your world in pictures

Turn digital photos into a slideshow VCD with background music that can be played by most DVD players. Bring new life to your video clips and share any event with your friends and family for playback on most DVD players. You can even add customized menus to Video CDs and Super Video CDs.

For specific details about each of these options, consult the User's Guide or click the **Help** button to open NTI CD/DVD-Maker's help menu.

## File type compatibility

Mode	Supported	Not supported
Cinema	DVD, SVCD, VCD, MiniDVD	DTS, Linear PCM, TruSurroundXT, SRS, DVD audio
Video	ASF, WMV, AVI, MPEG1/2, DivX (requires CODEC)	DVD navigator, SVCD, M2V, MOV, Flash
Album	BMP, JPG, PNG	GIF, TIF, PSD, ICO
Music	MP3, WMA, WAV, CDA (audio CD)	DVD audio, SACD



.....

**Note:** Automatic media detection will only function under the main menu.

# Taking your notebook PC with you

This section gives you tips and hints to consider when moving around or traveling with your computer.

## Disconnecting from the desktop

Follow these steps to disconnect your computer from external accessories:

- 1 Save any open files.
- 2 Remove any media, floppy disks or compact disks from the drive(s).
- 3 Shut down the computer.
- 4 Close the display cover.
- 5 Disconnect the cord from the AC adapter.
- 6 Disconnect the keyboard, pointing device, printer, external monitor and other external devices.
- 7 Disconnect the Kensington lock if you are using one to secure the computer.

## Moving around

When you are just moving within short distances, for example, from your office desk to a meeting room.

## Preparing the computer

Before moving the computer, close and latch the display cover to place it in Sleep mode. You can now safely take the computer anywhere you go within the building. To bring the computer out of Sleep mode, open the display; then press and release the power button.

If you are taking the computer to a client's office or a different building, you may choose to shut down the computer:

Click on **Start**, **Turn Off Computer**, then click on **Turn Off** (Windows XP).

Or:

You can put the computer in Sleep mode by pressing **<Fn> + <F4>**. Then close and latch the display.

When you are ready to use the computer again, unlatch and open the display; then press and release the power button.



**Note:** If the Sleep indicator is off, the computer has entered Hibernation mode and is turned off. If the power indicator is off but the Sleep indicator is on, the computer has entered Sleep mode. In both cases, press and release the power button to turn the computer back on. Note that the computer may enter Hibernation mode after being in Sleep mode for a period of time.

## What to bring to meetings

If your meeting is relatively short, you probably do not need to bring anything with you other than your computer. If your meeting will be longer, or if your battery is not fully charged, you may want to bring the AC adapter with you to plug in your computer in the meeting room.

If the meeting room does not have an electrical outlet, reduce the drain on the battery by putting the computer in Sleep mode. Press **<Fn> + <F4>** or close the display cover whenever you are not actively using the computer. To resume, open the display (if closed), then press and release the power button.

## Taking the computer home

When you are moving from your office to your home or vice versa.

## Preparing the computer

After disconnecting the computer from your desktop, follow these steps to prepare the computer for the trip home:

- Check that you have removed all media and compact disks from the drive(s). Failure to remove the media can damage the drive head.
- Pack the computer in a protective case that can prevent the computer from sliding around and cushion it if it should fall.



**Caution:** Avoid packing items next to the top cover of the computer. Pressure against the top cover can damage the screen.

## What to take with you

Unless you have some items at home, take the following items with you:

- AC adapter and power cord
- The printed User's Guide

## Special considerations

Follow these guidelines to protect your computer while traveling to and from work:

- Minimize the effects of temperature changes by keeping the computer with you.
- If you need to stop for an extended period of time and cannot carry the computer with you, leave the computer in the trunk of the car to avoid exposing the computer to excessive heat.
- Changes in temperature and humidity can cause condensation. Allow the computer to return to room temperature, and inspect the screen for condensation before turning on the computer. If the temperature change is greater than 10 °C (18 °F), allow the computer to come to room temperature slowly. If possible, leave the computer for 30 minutes in an environment with a temperature between outside and room temperature.

## Setting up a home office

If you frequently work on your computer at home, you may want to purchase a second AC adapter for use at home. With a second AC adapter, you can avoid carrying the extra weight to and from home.

If you use your computer at home for significant periods of time, you might also want to add an external keyboard, monitor or mouse.

## Traveling with the computer

When you are moving within a larger distance, for instance, from your office building to a client's office building or traveling locally.

## Preparing the computer

Prepare the computer as if you were taking it home. Make sure that the battery in the computer is charged. Airport security may require you to turn on your computer when carrying it into the gate area.

## What to take with you

Take the following items with you:

- AC adapter
- Spare, fully-charged battery pack(s)
- Additional printer driver files if you plan to use another printer



## Special considerations

In addition to the guidelines for taking the computer home, follow these guidelines to protect your computer while traveling:

- Always take the computer as carry-on luggage.
- If possible, have the computer inspected by hand. Airport security X-ray machines are safe, but do not put the computer through a metal detector.
- Avoid exposing floppy disks to hand-held metal detectors.

## Traveling internationally with the computer

When you are moving from country to country.

### Preparing the computer

Prepare the computer as you would normally prepare it for traveling.

### What to bring with you

Bring the following items with you:

- AC adapter
- Power cords that are appropriate for the country to which you are traveling
- Spare, fully-charged battery packs
- Additional printer driver files if you plan to use another printer
- Proof of purchase, in case you need to show it to customs officials
- International Travelers Warranty passport

## Special considerations

Follow the same special considerations as when traveling with the computer. In addition, these tips are useful when traveling internationally:

- When traveling in another country, check that the local AC voltage and the AC adapter power cord specifications are compatible. If not, purchase a power cord that is compatible with the local AC voltage. Do not use converter kits sold for appliances to power the computer.
- If you are using the modem, check if the modem and connector is compatible with the telecommunications system of the country you are traveling in.

# Securing your computer

Your computer is a valuable investment that you need to take care of. Learn how to protect and take care of your computer.

Security features include hardware and software locks — a security notch and passwords.

## Using a computer security lock

A security keylock notch, located on the chassis of the computer, lets you connect a Kensington-compatible computer security lock.

Wrap a computer security lock cable around an immovable object such as a table or handle of a locked drawer. Insert the lock into the notch and turn the key to secure the lock. Some keyless models are also available.

## Using passwords

Passwords protect your computer from unauthorized access. Setting these passwords creates several different levels of protection for your computer and data:

- Supervisor Password prevents unauthorized entry into the BIOS utility. Once set, you must enter this password to gain access to the BIOS utility. See **"BIOS utility"** on page 45.
- User Password secures your computer against unauthorized use. Combine the use of this password with password checkpoints on boot-up and resume from Hibernation for maximum security.
- Password on Boot secures your computer against unauthorized use. Combine the use of this password with password checkpoints on boot-up and resume from Hibernation for maximum security.



**Important!** Do not forget your Supervisor Password! If you forget your password, please get in touch with your dealer or an authorized service center.

## Entering passwords

When a password is set, a password prompt appears in the center of the display screen.

- When the Supervisor Password is set, a prompt appears when you press <F2> to enter the BIOS utility at boot-up.
- Type the Supervisor Password and press <Enter> to access the BIOS utility. If you enter the password incorrectly, a warning message appears. Try again and press <Enter>.
- When the User Password is set and the password on boot parameter is enabled, a prompt appears at boot-up.
- Type the User Password and press <Enter> to use the computer. If you enter the password incorrectly, a warning message appears. Try again and press <Enter>.



.....

**Important!** You have three chances to enter a password. If you fail to enter the password correctly after three tries, the system halts. Press and hold the power button for four seconds to shut down the computer. Then turn on the computer again, and try again.

## Setting passwords

You can set passwords using the BIOS utility.

# Expanding through options

Your notebook PC offers you a complete mobile computing experience.

## Connectivity options

Ports allow you to connect peripheral devices to your computer as you would with a desktop PC. For instructions on how to connect different external devices to the computer, read the following section.

### Fax/data modem

Your computer has a built-in V.92 56 Kbps fax/data modem.



.....

**Warning! This modem port is not compatible with digital phone lines. Plugging this modem into a digital phone line will damage the modem.**

To use the fax/data modem port, connect a phone cable from the modem port to a telephone jack.

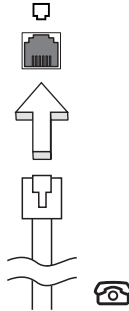

.....

**Warning! Please make sure that the cable you use is appropriate for the country in which you are working.**

## Built-in network feature

The built-in network feature allows you to connect your computer to an Ethernet-based network.

To use the network feature, connect an Ethernet cable from the Ethernet (RJ-45) port on the chassis of the computer to a network jack or hub on your network.

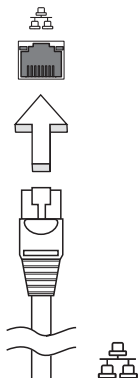

## Universal Serial Bus (USB)

The USB 2.0 port is a high-speed serial bus which allows you to connect USB peripherals without taking up precious system resources.

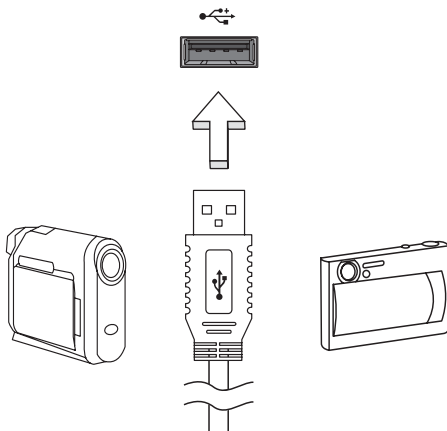

## PC Card slot

The Type II PC Card slot of the computer accepts PC Cards that enhance the usability and expandability of the computer. These cards should have a PC Card logo on them.

PC Cards (formerly PCMCIA) are add-on cards for portable computers, giving you expansion possibilities long afforded by desktop PCs. Popular PC Cards include flash, fax/data modem, wireless LAN and SCSI cards. CardBus improves on the 16-bit PC card technology by expanding the bandwidth to 32 bits.



**Note:** Refer to your card's manual for details on how to install and use the card, and its functions.

### Inserting a PC Card

Insert the card into the slot and make the proper connections (e.g., network cable), if necessary. See your card manual for details.

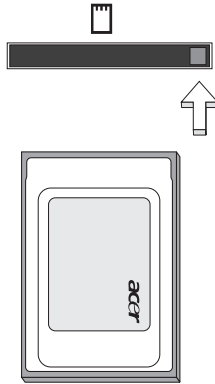

### Ejecting a PC Card

Before ejecting a PC Card:

- 1 Exit the application using the card.
- 2 Left-click on the PC Card icon on the taskbar and stop the card operation.
- 3 Press the slot eject button to pop out the eject button; then press it again to eject the card.

## Installing memory

Follow these steps to install memory:

- 1 Turn off the computer, unplug the AC adapter (if connected) and remove the battery pack. Then turn the computer over to access its base.
- 2 Remove the screws from the memory cover; then lift up and remove the memory cover.
- 3 **(a)** Insert the memory module diagonally into the slot, then **(b)** gently press it down until it clicks into place.

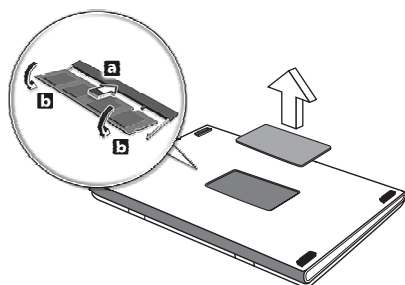

- 4 Replace the memory cover and secure it with the screw.
- 5 Reinstall the battery pack, and reconnect the AC adapter.
- 6 Turn on the computer.

The computer automatically detects and reconfigures the total memory size. Please consult a qualified technician or contact your local Acer dealer.

## BIOS utility

The BIOS utility is a hardware configuration program built into your computer's BIOS.

Your computer is already properly configured and optimized, and you do not need to run this utility. However, if you encounter configuration problems, you may need to run it.

To activate the BIOS utility, press <F2> during the POST; while the notebook PC logo is being displayed.

## Boot sequence

To set the boot sequence in the BIOS utility, activate the BIOS utility, then select **Boot** from the categories listed at the top of the screen.

## Enable disk-to-disk recovery

To enable disk-to-disk recovery (hard disk recovery), activate the BIOS utility, then select **Main** from the categories listed at the top of the screen. Find **D2D Recovery** at the bottom of the screen and use the <F5> and <F6> keys to set this value to **Enabled**.

## Password

To set a password on boot, activate the BIOS utility, then select **Security** from the categories listed at the top of the screen. Find **Password on boot:** and use the <F5> and <F6> keys to enable this feature.

## Using software

### Playing DVD movies

When the DVD drive module is installed in the optical drive bay, you can play DVD movies on your computer.

- 1 Eject the DVD tray and insert a DVD movie disk; then close the DVD tray.



**Important!** When you launch the DVD player for the first time, the program asks you to enter the region code. DVD disks are divided into 6 regions. Once your DVD drive is set to a region code, it will play DVD disks of that region only. You can set the region code a maximum of five times (including the first time), after which the last region code set will remain permanent. Recovering your hard disk does not reset the number of times the region code has been set. Refer to the table below for DVD movie region code information.

- 2 The DVD movie will automatically play after a few seconds.

Region code	Country or region
1	USA, Canada
2	Europe, Middle East, South Africa, Japan
3	Southeast Asia, Taiwan, South Korea
4	Latin America, Australia, New Zealand
5	Former USSR, parts of Africa, India
6	People's Republic of China





**Note:** To change the region code, insert a DVD movie of a different region into the DVD drive. Please refer to the online help for more information.

## Power management

This computer has a built-in power management unit that monitors system activity. System activity refers to any activity involving one or more of the following devices: keyboard, mouse, hard disk, peripherals connected to the computer, and video memory. If no activity is detected for a period of time (called an inactivity timeout), the computer stops some or all of these devices in order to conserve energy.

This computer employs a power management scheme that supports the advanced configuration and power interface (ACPI), which allows for maximum power conservation and maximum performance at the same time. Windows handles all power-saving chores for your computer.

## Acer eRecovery

Acer eRecovery is a tool to quickly backup and restore the system. You can create and save a backup of the current system configuration to hard disk, CD or DVD.

Acer eRecovery consists of the following functions:

- 1 Create backup
- 2 Restore from backup
- 3 Create factory default image CD
- 4 Re-install bundled software without CD
- 5 Change Acer eRecovery password

This chapter will guide you through each process.



**Note:** This feature is only available on certain models. For systems that do not have a built-in optical disk burner, plug in an external USB or IEEE 1394-compatible optical disk burner before entering Acer eRecovery for optical disk-related tasks.

## Create backup

You can create and save backup images to hard disk, CD or DVD.

- 1 Boot to Windows XP
- 2 Press **<Alt> + <F10>** to open the Acer eRecovery utility.
- 3 Enter the password to proceed. The default password is six zeros.
- 4 In the Acer eRecovery window, select **Recovery settings** and click **Next**.
- 5 In the Recovery settings window, select **Backup snapshot image** and click **Next**.
- 6 Select the backup method.
  - a Use **Backup to HDD** to store the backup disk image on drive D:.
  - b **Backup to optical device** to store the backup image on CD or DVD.
- 7 After choosing the backup method, click **Next**.

Follow the instructions on screen to complete the process.

## Restore from backup

You can restore backups previously created (as stated in the **Create backup** section) from hard disk, CD or DVD.

- 1 Boot to Windows XP.
- 2 Press **<Alt> + <F10>** to open the Acer eRecovery utility.
- 3 Enter the password to proceed. The default password is six zeros.
- 4 In the Acer eRecovery window, select **Recovery actions** and click **Next**.
- 5 Select the desired restore action and follow the onscreen instructions to complete the restore process.



-----

**Note:** The "Restore C:" item is enabled only if there is a user backup stored on the hard disk (D:\). Please refer to the **Create backup** section.

## Create factory default image CD

When the System CD and Recovery CD are not available, you can create them by using this feature.

- 1 Boot to Windows XP.
- 2 Press **<Alt> + <F10>** to open the Acer eRecovery utility.
- 3 Enter the password to proceed. The default password is six zeros.

- 4 In the Acer eRecovery window, select **Recovery settings** and click **Next**.
- 5 In the Recovery settings window, select **Burn image to disk** and click **Next**.
- 6 In the Burn image to disk window, select **01. Factory default image** and click **Next**.
- 7 Follow the instructions on screen to complete the process.

## Re-install bundled software without CD

Acer eRecovery stores pre-loaded software internally for easy driver and application re-installation.

- 1 Boot to Windows XP.
- 2 Press **<Alt> + <F10>** to open the Acer eRecovery utility.
- 3 Enter the password to proceed. The default password is six zeros.
- 4 In the Acer eRecovery window, select **Recovery actions** and click **Next**.
- 5 In the Recovery settings window, select **Reinstall applications/drivers** and click **Next**.
- 6 Select the desired driver/application and follow the instructions on screen to re-install.

At first launch, Acer eRecovery prepares all the needed software and may take few seconds to bring up the software content window.

## Change password

Acer eRecovery and Acer disk-to-disk recovery are protected by a password that can be changed by the user. Follow the steps below to change the password in Acer eRecovery.

- 1 Boot to Windows XP.
- 2 Press **<Alt> + <F10>** to open the Acer eRecovery utility.
- 3 Enter the password to proceed. The default password is six zeros.
- 4 In the Acer eRecovery window, select **Recovery settings** and click **Next**.
- 5 In the Recovery settings window, select **Password: Change Acer eRecovery password** and click **Next**.
- 6 Follow the instructions on screen to complete the process.



.....

**Note:** If the system crashes, and will not boot to Windows, you can run Acer disk-to-disk recovery to restore the factory default image under DOS mode.

# Troubleshooting

This chapter shows you how to deal with common system problems. Read it before calling a technician if a problem occurs. Solutions to more serious problems require opening up the computer. Do not attempt to open the computer yourself; contact your dealer or authorized service center for assistance.

## Troubleshooting tips

This notebook PC incorporates an advanced design that delivers onscreen error message reports to help you solve problems.

If the system reports an error message or an error symptom occurs, see "Error messages" below. If the problem cannot be resolved, contact your dealer. See "**Requesting service**" on page 25.

## Error messages

If you receive an error message, note the message and take the corrective action. The following table lists the error messages in alphabetical order together with the recommended course of action.

Error messages	Corrective action
CMOS battery bad	Contact your dealer or an authorized service center.
CMOS checksum error	Contact your dealer or an authorized service center.
Disk boot failure	Insert a system (bootable) disk into the floppy drive (A:), then press <Enter> to reboot.
Equipment configuration error	Press <F2> (during POST) to enter the BIOS utility, then press <b>Exit</b> in the BIOS utility to reboot.
Hard disk 0 error	Contact your dealer or an authorized service center.
Hard disk 0 extended type error	Contact your dealer or an authorized service center.
I/O parity error	Contact your dealer or an authorized service center.
Keyboard error or no keyboard connected	Contact your dealer or an authorized service center.
Keyboard interface error	Contact your dealer or an authorized service center.
Memory size mismatch	Press <F2> (during POST) to enter the BIOS utility, then press <b>Exit</b> in the BIOS utility to reboot.

If you still encounter problems after going through the corrective measures, please contact your dealer or an authorized service center for assistance. Some problems may be solved using the BIOS utility.

# Regulations and safety notices

## ENERGY STAR guidelines compliance

As an ENERGY STAR partner, Acer Inc. has determined that this product meets the ENERGY STAR guidelines for energy efficiency.

## FCC notice

This device has been tested and found to comply with the limits for a Class B digital device pursuant to Part 15 of the FCC rules. These limits are designed to provide reasonable protection against harmful interference in a residential installation. This device generates, uses, and can radiate radio frequency energy and, if not installed and used in accordance with the instructions, may cause harmful interference to radio communications.

However, there is no guarantee that interference will not occur in a particular installation. If this device does cause harmful interference to radio or television reception, which can be determined by turning the device off and on, the user is encouraged to try to correct the interference by one or more of the following measures:

- Reorient or relocate the receiving antenna.
- Increase the separation between the device and receiver.
- Connect the device into an outlet on a circuit different from that to which the receiver is connected.
- Consult the dealer or an experienced radio/television technician for help.

## Notice: Shielded cables

All connections to other computing devices must be made using shielded cables to maintain compliance with FCC regulations.

## Notice: Peripheral devices

Only peripherals (input/output devices, terminals, printers, etc.) certified to comply with the Class B limits may be attached to this equipment. Operation with non-certified peripherals is likely to result in interference to radio and TV reception.

## Caution

Changes or modifications not expressly approved by the manufacturer could void the user's authority, which is granted by the Federal Communications Commission, to operate this computer.

## Operation conditions

This device complies with Part 15 of the FCC Rules. Operation is subject to the following two conditions: (1) this device may not cause harmful interference, and (2) this device must accept any interference received, including interference that may cause undesired operation.

## Notice: Canadian users

This Class B digital apparatus complies with Canadian ICES-003.

## Remarque à l'intention des utilisateurs canadiens

Cet appareil numérique de la classe B est conforme à la norme NMB-003 du Canada.

## Declaration of Conformity for EU countries

Hereby, Acer, declares that this notebook PC series is in compliance with the essential requirements and other relevant provisions of Directive 1999/5/EC. (Please visit <http://global.acer.com/products/notebook/reg-nb/index.htm> for complete documents.)

Compliant with Russian regulatory certification



ME61

## Modem notices

### Notice for USA

This equipment complies with Part 68 of the FCC rules. Located on the modem is a label that contains, among other information, the FCC Registration Number and Ringer Equivalence Number (REN) for this equipment. Upon request, you must provide this information to your telephone company.

If your telephone equipment causes harm to the telephone network, the telephone company may discontinue your service temporarily. If possible, they will notify you in advance. But, if advance notice is not practical, you will be notified as soon as possible. You will also be informed of your right to file a complaint with the FCC.

Your telephone company may make changes in its facilities, equipment, operations, or procedures that could affect the proper functioning of your equipment. If they do, you will be notified in advance to give you an opportunity to maintain uninterrupted telephone service.

If this equipment should fail to operate properly, disconnect the equipment from the phone line to determine if it is causing the problem. If the problem is with the equipment, discontinue use and contact your dealer or vendor.



.....

**Caution:** To reduce the risk of fire, use only No. 26 AWG or larger UL Listed or CSA Certified Telecommunication Line Cord.

## TBR 21

This equipment has been approved [Council Decision 98/482/EC - "TBR 21"] for single terminal connection to the Public Switched Telephone Network (PSTN). However, due to differences between the individual PSTNs provided in different countries, the approval does not, of itself, give an unconditional assurance of successful operation on every PSTN termination point. In the event of problems, you should contact your equipment supplier in the first instance.

## List of applicable countries

EU member states as of May 2004 are: Belgium, Denmark, Germany, Greece, Spain, France, Ireland, Italy, Luxembourg, the Netherlands, Austria, Portugal, Finland, Sweden, United Kingdom Estonia, Latvia, Lithuania, Poland, Hungary, Czech Republic, Slovak Republic, Slovenia, Cyprus and Malta. Usage allowed in the countries of European Union, as well as Norway, Switzerland, Iceland and Liechtenstein. This device must be used in strict accordance with the regulations and constraints in the country of use. For further information, please contact local office in the country of use.

## Notice for Australia

For safety reasons, only connect headsets with a telecommunications compliance label. This includes customer equipment previously labelled permitted or certified.



## Notice for New Zealand

For modem with approval number PTC 211/03/008

- 1 The grant of a Telepermit for any item of terminal equipment indicates only that Telecom has accepted that the item complies with minimum conditions for connection to its network. It indicates no endorsement of the product by Telecom, nor does it provide any sort of warranty. Above all, it provides no assurance that any item will work correctly in all respects with another item of Telepermitted equipment of a different make or model, nor does it imply that any product is compatible with all of Telecom's network services.
- 2 This equipment is not capable, under all operating conditions, of correct operation at the higher speeds for which it is designed. Telecom will accept no responsibility should difficulties arise in such circumstances.
- 3 Some parameters required for compliance with Telecom's Telepermit requirements are dependent on the equipment (PC) associated with this device. The associated equipment shall be set to operate within the following limits for compliance with Telecom's Specifications:
  - a There shall be no more than 10 call attempts to the same number within any 30 minute period for any single manual call initiation, and
  - b The equipment shall go on-hook for a period of not less than 30 seconds between the end of one attempt and the beginning of the next call attempt.
- 4 Some parameters required for compliance with Telecom's Telepermit requirements are dependent on the equipment (PC) associated with this device. In order to operate within the limits for compliance with Telecom's specifications, the associated equipment shall be set to ensure that automatic calls to different numbers are spaced such that there is not less than 5 seconds between the end of one call attempt and the beginning of another.
- 5 This equipment shall not be set up to make automatic calls to Telecom's 111 Emergency Service.

For modem with approval number PTC 211/01/030

- 1 The grant of a Telepermit for any item of terminal equipment indicates only that Telecom has accepted that the item complies with minimum conditions for connection to its network. It indicates no endorsement of the product by Telecom, nor does it provide any sort of warranty. Above all, it provides no assurance that any item will work correctly in all respects with another item of Telepermitted equipment of a different make or model, nor does it imply that any product is compatible with all of Telecom's network services.
- 2 This equipment is not capable, under all operating conditions, of correct operation at the higher speeds for which it is designed. Telecom will accept no responsibility should difficulties arise in such circumstances.

- 3 This device is equipped with pulse dialing while the Telecom standard is DTMF tone dialing. There is no guarantee that Telecom lines will always continue to support pulse dialing.
- 4 Use of pulse dialing, when this equipment is connected to the same line as other equipment, may give rise to bell tinkle or noise and may also cause a false answer condition. Should such problems occur, the user should NOT contact the telecom Fault Service.
- 5 This equipment may not provide for the effective hand-over of a call to another device connected to the same line.
- 6 Under power failure conditions this appliance may not operate. Please ensure that a separate telephone, not dependent on local power, is available for emergency use.
- 7 Some parameters required for compliance with Telecom's Telepermit requirements are dependent on the equipment (PC) associated with this device. The associated equipment shall be set to operate within the following limits for compliance with Telecom's specifications, the associated equipment shall be set to ensure that calls are answered between 3 and 30 seconds of receipt of ringing.
- 8 This equipment shall not be set up to make automatic calls to Telecom's 111 Emergency Service.

## Important safety instructions

Read these instructions carefully. Save them for future reference.

- 1 Follow all warnings and instructions marked on the product.
- 2 Unplug this product from the wall outlet before cleaning. Do not use liquid cleaners or aerosol cleaners. Use a water-moistened cloth for cleaning.
- 3 Do not use this product near water.
- 4 Do not place this product on an unstable cart, stand or table. If the product falls, it could be seriously damaged.
- 5 Slots and openings are provided for ventilation; to ensure reliable operation of the product and to protect it from overheating. These openings must not be blocked or covered. The openings should never be blocked by placing the product on a bed, sofa, rug or other similar surface. This product should never be placed near or over a radiator or heat register, or in a built-in installation unless proper ventilation is provided.
- 6 This product should be operated from the type of power indicated on the marking label. If you are not sure of the type of power available, consult your dealer or local power company.
- 7 Do not allow anything to rest on the power cord. Do not locate this product where people will walk on the cord.

- 8 If an extension cord is used with this product, make sure that the total ampere rating of the equipment plugged into the extension cord does not exceed the extension cord ampere rating. Also, make sure that the total rating of all products plugged into the wall outlet does not exceed the fuse rating.
- 9 Never push objects of any kind into this product through cabinet slots as they may touch dangerous voltage points or short-out parts that could result in a fire or electric shock. Never spill liquid of any kind onto or into the product.
- 10 Do not attempt to service this product yourself, as opening or removing covers may expose you to dangerous voltage points or other risks. Refer all servicing to qualified service personnel.
- 11 Unplug this product from the wall outlet and refer servicing to qualified service personnel under the following conditions:
  - a When the power cord or plug is damaged or frayed.
  - b If liquid has been spilled into the product.
  - c If the product has been exposed to rain or water.
  - d If the product does not operate normally when the operating instructions are followed. Adjust only those controls that are covered by the operating instructions, since improper adjustment of other controls may result in damage and will often require extensive work by a qualified technician to restore the product to normal condition.
  - e If the product has been dropped or the case has been damaged.
  - f If the product exhibits a distinct change in performance, indicating a need for service.
- 12 The notebook PC series uses lithium batteries.  
Replace the battery with the same type as the product's battery we recommend in the product specification list. Use of another battery may present a risk of fire or explosion.
- 13 **Warning!** Batteries may explode if not handled properly. Do not disassemble or dispose of them in fire. Keep them away from children and dispose of used batteries promptly.
- 14 To avoid hazard of unexpected electrical shock, use the AC adapter only when the wall socket is properly grounded.
- 15 Use only the proper type of power supply cord set (provided in your accessories box) for this unit. It should be a detachable type: UL listed/CSA certified, type SPT-2, rated 7 A 125 V minimum, VDE approved or its equivalent. Maximum length is 4.6 meters (15 feet).
- 16 Always disconnect all telephone lines from the wall outlet before serving or disassembling this equipment.
- 17 Avoid using a telephone (other than a cordless type) during an electrical storm. There may be a remote risk of electric shock from lightning.

## Laser compliance statement

The CD or DVD drive used with this computer is a laser product.  
The CD or DVD drive's classification label (shown below) is located on the drive.

CLASS 1 LASER PRODUCT

CAUTION: INVISIBLE LASER RADIATION WHEN OPEN. AVOID EXPOSURE TO BEAM.

APPAREIL A LASER DE CLASSE 1 PRODUIT

LASERATTENTION: RADIATION DU FAISCEAU LASER INVISIBLE EN CAS D'OUVERTURE. EVITER TOUTE EXPOSITION AUX RAYONS.

LUOKAN 1 LASERLAITE LASER KLASSE 1

VORSICHT: UNSICHTBARE LASERSTRAHLUNG, WENN ABDECKUNG GEÖFFNET NICHT DEM STRAHL AUSSETZEN

PRODUCTO LÁSER DE LA CLASE I

ADVERTENCIA: RADIACIÓN LÁSER INVISIBLE AL SER ABIERTO. EVITE EXPONERSE A LOS RAYOS.

ADVARSEL: LASERSTRÅLING VEDÅBNING SE IKKE IND I STRÅLEN.

VARO! LAVATTAESSA OLET ALTTINA LASERSÄTEILYLLE.

VARNING: LASERSTRÅLNING NÅR DENNA DEL ÅR ÖPPNAD ÅLÅ TUIJOTA SÄTTEESENSTIRRA EJ IN I STRÅLEN

VARNING: LASERSTRÅLNING NAR DENNA DEL ÅR ÖPPNADSTIRRA EJ IN I STRÅLEN

ADVARSEL: LASERSTRÅLING NAR DEKSEL ÅPNESSTIRR IKKE INN I STRÅLEN

## LCD pixel statement

The LCD unit is produced with high-precision manufacturing techniques. Nevertheless, some pixels may occasionally misfire or appear as black or red dots. This has no effect on the recorded image and does not constitute a malfunction.

## Radio device regulatory notice



-----  
**Note:** Below regulatory information is for models with wireless LAN and/or Bluetooth only.

## General

This product complies with the radio frequency and safety standards of any country or region in which it has been approved for wireless use. Depending on configurations, this product may or may not contain wireless radio devices (such as wireless LAN and/or Bluetooth modules). Below information is for products with such devices.

## European Union (EU)

This device complies with the essential requirements of the European Council Directives listed below:

73/23/EEC Low Voltage Directive



- **EN 60950**

89/336/EEC Electromagnetic Compatibility (EMC) Directive

- **EN 55022**
- **EN 55024**
- **EN 61000-3-2/-3**

99/5/EC Radio & Telecommunications Terminal Equipment (R&TTE) Directive

- **Art.3.1a) EN 60950**
- **Art.3.1b) EN 301 489 -1/-17**
- **Art.3.2) EN 300 328-2**
- **Art.3.2) EN 301 893 \*applies to 5 GHz only**

   (for 5 GHz device)

## List of applicable countries

EU member states as of May 2004 are: Belgium, Denmark, Germany, Greece, Spain, France, Ireland, Italy, Luxembourg, the Netherlands, Austria, Portugal, Finland, Sweden, United Kingdom Estonia, Latvia, Lithuania, Poland, Hungary, Czech Republic, Slovak Republic, Slovenia, Cyprus and Malta. Usage allowed in the countries of European Union, as well as Norway, Switzerland, Iceland and Liechtenstein. This device must be used in strict accordance with the regulations and constraints in the country of use. For further information, please contact local office in the country of use.

## The FCC RF safety requirement

The radiated output power of the wireless LAN Mini PCI Card and Bluetooth card is far below the FCC radio frequency exposure limits. Nevertheless, the notebook PC series shall be used in such a manner that the potential for human contact during normal operation is minimized as follows:

- 1 Users are requested to follow the RF safety instructions on wireless option devices that are included in the user's manual of each RF option device.



**Caution:** To comply with FCC RF exposure compliance requirements, a separation distance of at least 20 cm (8 inches) must be maintained between the antenna for the integrated wireless LAN Mini PCI Card built in to the screen section and all persons.

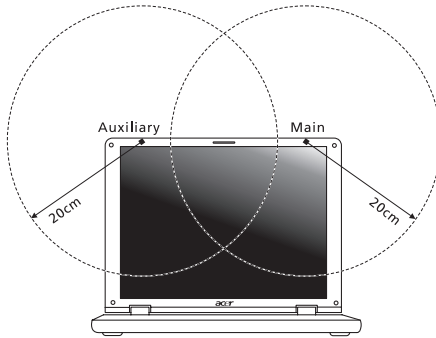

**Note:** The Acer wireless Mini PCI adapter implements a transmission diversity function. The function does not emit radio frequencies simultaneously from both antennas. One of the antennas is selected automatically or manually (by users) to ensure good quality radiocommunication.

- 2 This device is restricted to indoor use due to its operation in the 5.15 to 5.25 GHz frequency range. FCC requires this product to be used indoors for the frequency range 5.15 to 5.25 GHz to reduce the potential for harmful interference to co-channel Mobile Satellite systems.
- 3 High power radar are allocated as primary users of the 5.25 to 5.35 GHz and 5.65 to 5.85 GHz bands. These radar stations can cause interference with and/or damage this device.

- 4 An improper installation or unauthorized use may cause harmful interference to radio communications. Also any tampering of the internal antenna will void the FCC certification and your warranty.

## Canada — Low-power license-exempt radio communication devices (RSS-210)

- a Common information  
Operation is subject to the following two conditions:
    1. This device may not cause interference, and
    2. This device must accept any interference, including interference that may cause undesired operation of the device.
  - b Operation in 2.4 GHz band  
To prevent radio interference to the licensed service, this device is intended to be operated indoors and installation outdoors is subject to licensing.
  - c Operation in 5 GHz band
- The device for the band 5150-5250 MHz is only for indoor usage to reduce potential for harmful interference to co-channel Mobile Satellite systems.
  - High power radars are allocated as primary users (meaning they have priority) of 5250-5350 MHz and 5650-5850 MHz and these radars could cause interference and/or damage to LELAN (Licence-Exempt Local Area Network) devices.

## Exposure of humans to RF fields (RSS-102)

The notebook PC series employs low gain integral antennas that do not emit RF field in excess of Health Canada limits for the general population; consult Safety Code 6, obtainable from Health Canada's website at [www.hc-sc.gc.ca/rpb](http://www.hc-sc.gc.ca/rpb).

## Environmental Policy Declaration

To minimize pollution and ensure utmost protection of the global environment, all applicable environmental regulatory requirements were met during the manufacture of this device.

The manufacturing facilities and management meet the requirements of the ISO 14001 Environmental Management System (EMS).

Do not throw this electronic device into the trash when discarding. To reduce the environmental impact of WEEE (Waste Electrical and Electronic Equipment) and minimize the volume of WEEE entering landfills, please reuse and recycle. Refer to [www.acer.com](http://www.acer.com) for further information regarding Acer's environmental protection practices.

Environmental Labels:

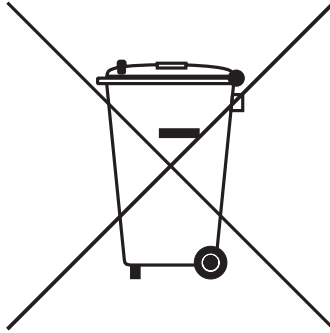

Do not throw this electronic device into the trash when discarding. To minimize pollution and ensure utmost protection of the global environment, please reuse and recycle.



USA

For electronic products containing an LCD/CRT monitor or display:

LAMP(S) INSIDE THIS PRODUCT CONTAIN MERCURY AND MUST BE RECYCLED OR DISPOSED OF ACCORDING TO LOCAL, STATE OR FEDERAL LAWS. FOR MORE INFORMATION, CONTACT THE ELECTRONIC INDUSTRIES ALLIANCE AT [WWW.EIAE.ORG](http://WWW.EIAE.ORG). FOR LAMP-SPECIFIC DISPOSAL INFORMATION, CHECK [WWW.LAMPRECYCLE.ORG](http://WWW.LAMPRECYCLE.ORG).



## Federal Communications Commission Declaration of Conformity

This device complies with Part 15 of the FCC Rules. Operation is subject to the following two conditions: (1) This device may not cause harmful interference, and (2) This device must accept any interference received, including interference that may cause undesired operation.

The following local manufacturer/importer is responsible for this declaration:

Product name:	Notebook PC
Model number:	MS2177
Machine type:	Aspire 361xxx
SKU number:	Aspire 361xxx ("x" = 0 - 9, a - z, or A - Z)
Name of responsible party:	Acer America Corporation
Address of responsible party:	2641 Orchard Parkway San Jose, CA 95134 USA
Contact person:	Mr. Young Kim
Tel:	408-922-2909
Fax:	408-922-2606

# Declaration of Conformity for CE Marking

Name of manufacturer: Beijing Acer Information Co., Ltd.  
 Address of manufacturer: Huade Building, No.18, ChuangYe Rd. ShangDi Zone, HaiDian District Beijing PRCE marking  
 Contact person: Mr. Easy Lai  
 Tel: 886-2-8691-3089  
 Fax: 886-2-8691-3000  
 E-mail: easy\_lai@acer.com.tw  
 Declares that product: Notebook PC  
 Trade name: Acer  
 Model number: MS2177  
 Machine type: Aspire 361xxx  
 SKU number: Aspire 361xxx ("x" = 0 - 9, a - z, or A - Z)

Is in compliance with the essential requirements and other relevant provisions of the following EC directives.

Reference no.	Title
89/336/EEC	Electromagnetic Compatibility (EMC directive)
73/23/EEC	Low Voltage Directive (LVD)
1999/5/EC	Radio & Telecommunications Terminal Equipment Directive (R&TTE)

The product specified above was tested conforming to the applicable Rules under the most accurate measurement standards possible, and all the necessary steps have been taken and are in force to assure that production units of the same product will continue to comply with these requirements.

*Easy Lai*  
 Easy Lai, Director  
 Qualification Center  
 Product Assurance

06/01/2005

Date

# Index

## A

- AC adapter
  - caring for iv
- audio 17
  - adjusting the volume 17
  - troubleshooting 23

## B

- battery pack
  - caring for v
- BIOS utility 45
- brightness
  - hotkeys 14

## C

- caps lock 12
  - on indicator 8
- care
  - AC adapter iv
  - battery pack v
  - computer iv
- CD-ROM
  - ejecting 16
  - ejecting manually 23
  - troubleshooting 23
- cleaning
  - computer v
- computer
  - caring for iv
  - cleaning v
  - disconnecting 36
  - features 1
  - indicators 8
  - keyboards 12
  - moving around 36
  - on indicator 8
  - security 40
  - setting up a home office 38
  - taking home 37
  - traveling internationally 39
  - traveling on local trips 38
  - troubleshooting 50
  - turning off iv
- connections
  - network 43

## D

- display
  - hotkeys 14
  - troubleshooting 22
- DVD 46
- DVD movies
  - playing 46

## E

- error messages 50
- Euro 15

## F

- FAQ. See frequently-asked questions
- frequently-asked questions 22
- front view 2

## H

- Hibernation mode
  - hotkey 14
- hotkeys 13

## I

- indicator lights 8

## K

- keyboard 12
  - embedded numeric keypad 12
  - hotkeys 13
  - lock keys 12
  - troubleshooting 23
  - Windows keys 13

## L

- LEDs 8
- left view 2

## M

- media access
  - on indicator 8
- memory
  - installing 45
- messages
  - error 50
- modem 42

## N

- network 43
- Notebook Manager
  - hotkey 14

num lock 12  
 on indicator 8  
 numeric keypad  
 embedded 12

## P

password 40  
 types 40  
 PC Card 44  
 ejecting 44  
 inserting 44  
 ports 42  
 printer  
 troubleshooting 23  
 problems 22  
 CD-ROM 23  
 display 22  
 keyboard 23  
 printer 23  
 startup 22  
 troubleshooting 50

## Q

questions  
 setting location for modem use  
 23

## S

safety  
 CD or DVD 58  
 FCC notice 52  
 general instructions 56  
 modem notices 53  
 scroll lock 12

security  
 keylock 16, 40  
 passwords 40

speakers  
 hotkey 14  
 troubleshooting 23  
 status indicators 8  
 support  
 information 25

## T

touchpad 10  
 hotkey 14  
 using 10– 11  
 travel  
 international flights 39  
 local trips 38  
 troubleshooting 50  
 tips 50

## U

universal serial bus 43

## V

view  
 front 3  
 left 3  
 rear 4  
 right 3  
 volume  
 adjusting 17

## W

Windows keys 13