



# **MPG Series**

## **OLED Monitor**

**MPG 322UR QD-OLED X24 (3DD3)**

User Guide

# Contents

Getting Started .....	3
Package Contents .....	3
Installing the Monitor Stand .....	4
Adjusting the Monitor .....	5
Monitor Overview .....	6
Connecting the Monitor to PC .....	9
OSD Setup.....	11
Navi Key.....	11
Hot Key .....	11
OSD Menus .....	12
AI Navigator.....	13
Gaming Features.....	15
Mode.....	18
Input Source.....	20
PIP/PBP.....	21
MSI OLED Care.....	22
General .....	24
Specifications .....	26
Preset Display Modes .....	28
Troubleshooting.....	32
Safety Instructions .....	33
TÜV Rheinland Certification .....	35
Regulatory Notices.....	36

## Revision

V1.0, 2026/03

# Getting Started

This chapter provides you with the information on hardware setup procedures. While connecting devices, be careful in holding the devices and use a grounded wrist strap to avoid static electricity.

## Package Contents

Monitor	MPG 322UR QD-OLED X24
Documentation	Quick Start Guide
Accessories	Stand
	Stand Base with Screw(s)
	Screw(s) for Wall Mount Bracket(s)
	Power Cord
Cables	USB Upstream Cable (for USB Type-B Upstream Port)
	USB Type-C Cable (Optional)
	DisplayPort Cable (Optional)
	Ultra High Speed HDMI™ Cable (Optional)



### **Important**

- Contact your place of purchase or local distributor if any of the items is damaged or missing.
- Package contents may vary by country and model.
- The included power cord is exclusively for this monitor and should not be used with other products.

## Installing the Monitor Stand

1. Leave the monitor in its protective packaging. Align the stand to the monitor groove. Push the stand towards the monitor groove until it locks in place.
2. Connect the base to the stand and tighten the base screw to secure the base.
3. Make sure the stand assembly is properly installed before setting the monitor upright.

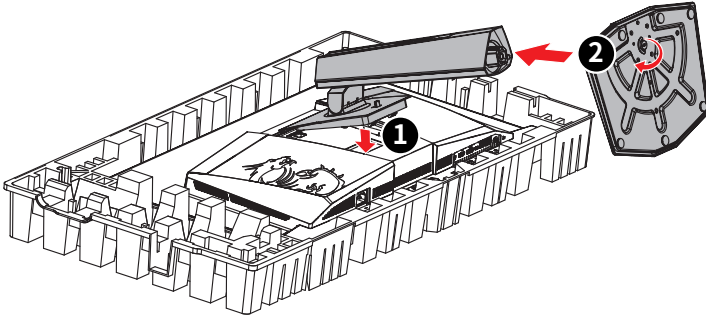

### **Important**

- Place the monitor on a soft, protected surface to avoid scratching the display panel.
- Do not use any sharp objects on the panel.
- The groove for installing the stand bracket can also be used for wall mount. Please contact your dealer for proper wall mount kit.

## Adjusting the Monitor

This monitor is designed to maximize your viewing comfort with its adjustment capabilities.



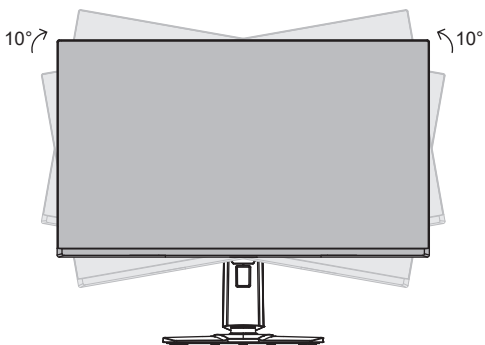
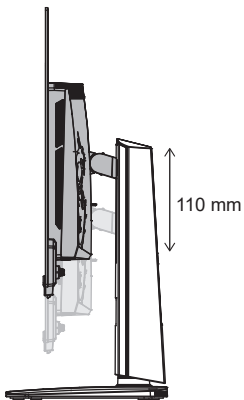
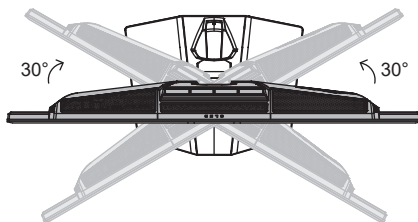
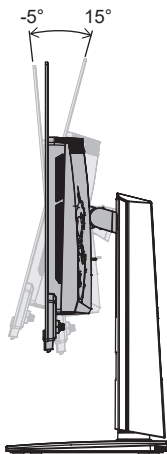

 **Important**

- Avoid touching the display panel when adjusting the monitor.
- Please slightly tilt the monitor backwards before pivoting it.

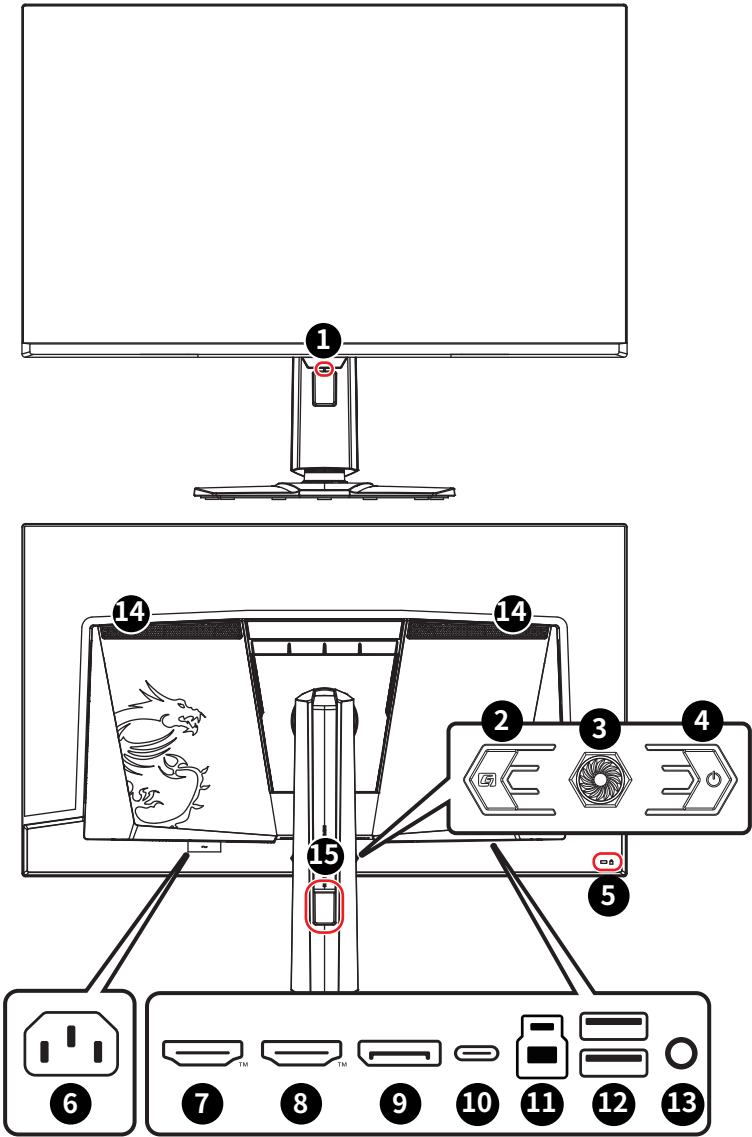

# Monitor Overview

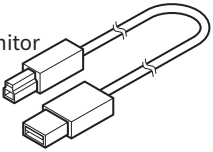

<p><b>1</b></p>	<p><b>Power LED</b></p> <p>Lit in white after the monitor is turned on. If no signal input, the LED will turn into orange. Lit in orange when the monitor is in Stand-by mode.</p>						
<p><b>2</b></p>	<p><b>Macro Key</b></p> <p>To activate the MSI Gaming Intelligence Application.</p>						
<p><b>3</b></p>	<p><b>Navi Key</b></p>						
<p><b>4</b></p>	<p><b>Power Button</b></p>						
<p><b>5</b></p>	<p><b>Kensington Lock</b></p>						
<p><b>6</b></p>	<p><b>Power Jack</b></p>						
<p><b>7</b></p>	<p><b>HDMI™ Connector</b>   <small>HIGH-DEFINITION MULTIMEDIA INTERFACE</small></p> <p>Supports HDMI™ CEC, 3840x2160@240Hz as specified in HDMI™ 2.1.</p> <p> <b>Important</b></p> <p><i>To ensure optimal performance and compatibility, please use only HDMI™ cables certified with the official HDMI™ logo when connecting this monitor. For more information, please visit <a href="https://www.hdmi.org/resource/cables">https://www.hdmi.org/resource/cables</a>.</i></p>						
<p><b>8</b></p>	<p><b>HDMI™ Connector</b>   <small>HIGH-DEFINITION MULTIMEDIA INTERFACE</small></p> <p>Supports 3840x2160@240Hz as specified in HDMI™ 2.1.</p> <p> <b>Important</b></p> <p><i>To ensure optimal performance and compatibility, please use only HDMI™ cables certified with the official HDMI™ logo when connecting this monitor. For more information, please visit <a href="https://www.hdmi.org/resource/cables">https://www.hdmi.org/resource/cables</a>.</i></p>						
<p><b>9</b></p>	<p><b>DisplayPort</b></p> <p>Supports 3840x2160@240Hz as specified in DisplayPort 2.1a (UHBR20).</p>						
<p><b>10</b></p>	<p><b>USB Type-C Port</b></p> <p>This port supports DisplayPort Alternate (DP Alt) Mode and up to 20V/4.9A (98W) power delivery.</p> <p> <b>Important</b></p> <p><i>Your USB-C signal source and cable must support DisplayPort Alternate Mode to enable video output to the monitor.</i></p> <table border="1" data-bbox="692 1174 891 1414"> <thead> <tr> <th>USB Type-C Power Delivery</th> </tr> </thead> <tbody> <tr> <td>5V / 3A (15W)</td> </tr> <tr> <td>9V / 3A (27W)</td> </tr> <tr> <td>12V / 3A (36W)</td> </tr> <tr> <td>15V / 3A (45W)</td> </tr> <tr> <td>20V / 4.9A (98W)</td> </tr> </tbody> </table>	USB Type-C Power Delivery	5V / 3A (15W)	9V / 3A (27W)	12V / 3A (36W)	15V / 3A (45W)	20V / 4.9A (98W)
USB Type-C Power Delivery							
5V / 3A (15W)							
9V / 3A (27W)							
12V / 3A (36W)							
15V / 3A (45W)							
20V / 4.9A (98W)							

<p><b>11</b></p>	<p><b>USB 5Gbps Type-B Upstream Port</b>  For USB Upstream Cable.</p> <p> <b>Important</b></p> <p><i>Check the package for USB Upstream Cable and connect it to the PC and monitor. Once this cable is connected, the USB Type-A Downstream Ports on the monitor will be ready for use.</i></p> <div data-bbox="654 175 931 359" style="text-align: right;">  <p>To Monitor</p> <p>To PC</p> </div>
<p><b>12</b></p>	<p><b>USB 5Gbps Type-A Port</b></p>
<p><b>13</b></p>	<p><b>Headphone Jack</b></p>
<p><b>14</b></p>	<p><b>Air Vents</b>  The air vents on the enclosure allow for proper airflow and help prevent overheating. Do not block the vents. Remove the protective film before use.</p>
<p><b>15</b></p>	<p><b>Cable Routing Hole</b></p>

# Connecting the Monitor to PC

1. Connect the monitor to your computer with the video cable.

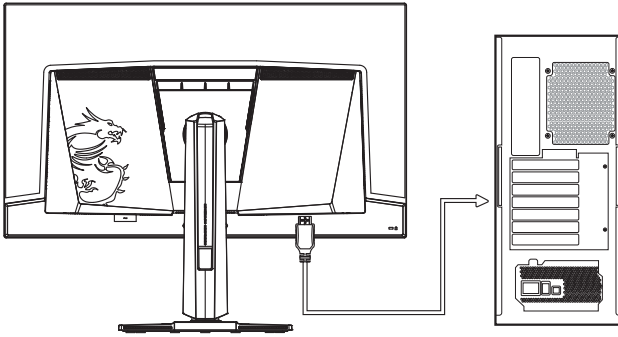

2. Plug in the monitor's power cable.

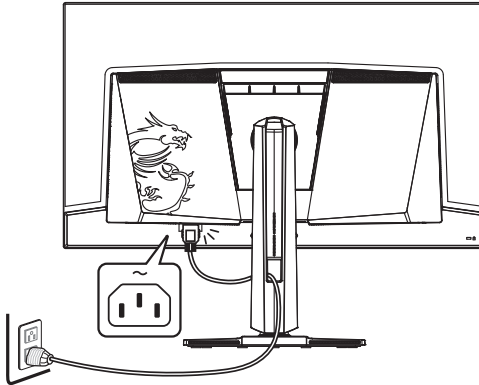

3. Turn on the monitor and your computer.

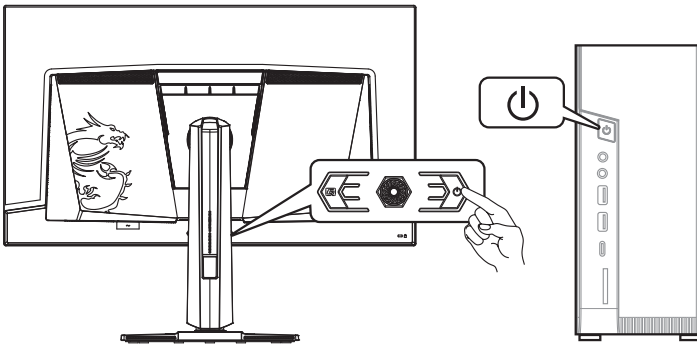

 **Important**

*Please remove the protective films from the display panel and air vents before use to optimize performance and prevent overheating.*

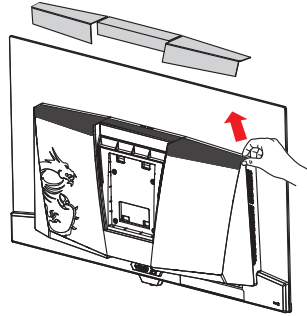
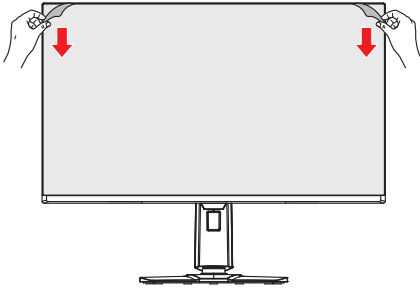

# OSD Setup

This chapter provides you with essential information on OSD Setup.



*All information is subject to change without prior notice.*

## Navi Key

The monitor comes with a Navi Key, a multi-directional control that helps navigate the On-Screen Display (OSD) menu.

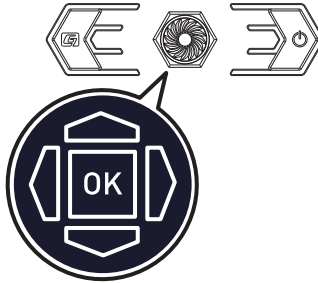

### Up/Down/Left/Right:

- selecting function menus and items
- adjusting function values
- entering into/exiting from function menus

### Press (OK):

- launching the On-Screen Display (OSD)
- entering submenus
- confirming a selection or setting

## Hot Key

- Users may enter into preset function menus by moving the Navi Key up, down, left or right when the OSD menu is inactive.
- Users may customize their own Hot Keys to enter into different function menus.

# OSD Menu

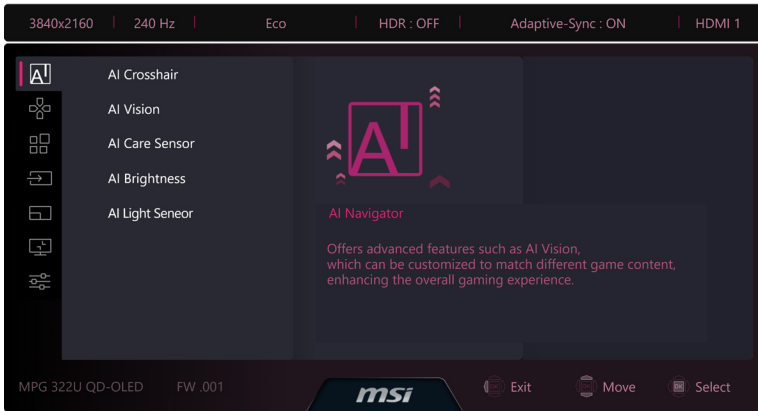

## **Important**

The following settings will be grayed out when HDR signals are received:

- Low Blue Light
- Brightness
- Contrast
- Color Temperature
- Optix Scope
- PIP/PBP
- AI Vision
- Adaptive Dim
- AI Brightness
- AI Light Sensor
- Black-White, sRGB, Adobe RGB, Display P3 Mode
- Six-Axis Color
- Gamma
- Saturation
- SDR Brightness

# AI Navigator

Feature	Available Settings	Description	
AI Crosshair	OFF	<ul style="list-style-type: none"> <li>Through AI algorithm, this function enhances the visibility of in-game crosshair.</li> <li>Users can select the color, size and position of the crosshair.</li> </ul>	
	ON		
	Icon		
	Icon Colors		Adaptive
			Customize
			R (0-255)
			G (0-255)
			B (0-255)
	Icon Size		x0.5
			x1.0
x1.5			
Position			
Position Reset			
AI Vision	OFF	<ul style="list-style-type: none"> <li>AI Vision enhances image quality by optimizing the contrast of images and background brightness.</li> </ul>	
	Level 1		
	Level 2		
	Level 3		
	Level 4		
	Level 5		

Feature	Available Settings	Description						
AI Care Sensor	OFF	<ul style="list-style-type: none"> <li>This feature enables AI-based human detection features.</li> </ul>						
	ON							
	Active Mode	System Mode	<ul style="list-style-type: none"> <li>When set to System Mode, WoA, LoL, and Adaptive Dim are controlled via the Microsoft Windows® operating system.</li> <li>When set to Monitor Mode, WoA, LoL, and Adaptive Dim are controlled via the monitor's OSD menu.</li> </ul>					
		Monitor Mode						
	Wake on Approach	OFF	<ul style="list-style-type: none"> <li>WoA (Wake on Approach) is grayed out when Active Mode is set to System Mode.</li> <li>When WoA is set to ON, the monitor automatically wakes upon detecting a nearby user.</li> </ul>					
		ON						
		Timer Setting	0-30	<ul style="list-style-type: none"> <li>Users can set a timer from 0 to 30 seconds.</li> <li>Setting to 0 activates the function immediately.</li> </ul>				
	Lock on Leave	OFF	<ul style="list-style-type: none"> <li>LoL (Lock on Leave) is grayed out when Active Mode is set to System Mode.</li> <li>When LoL is set to ON, the monitor automatically locks upon detecting that the user has left.</li> </ul>					
ON								
Timer Setting		10-120	<ul style="list-style-type: none"> <li>Users can set a timer from 10 to 120 seconds.</li> </ul>					
Adaptive Dim	OFF	<ul style="list-style-type: none"> <li>Adaptive Dim is grayed out when Active Mode is set to System Mode.</li> <li>When Adaptive Dim is set to ON, the monitor automatically dims the screen when it detects that the user has looked away.</li> <li>Activating Adaptive Dim will affect: <table border="1" data-bbox="575 933 926 997"> <thead> <tr> <th>Affected Function</th> <th>Function Status</th> </tr> </thead> <tbody> <tr> <td>» AI Brightness</td> <td>Set to OFF</td> </tr> </tbody> </table> </li> </ul>	Affected Function	Function Status	» AI Brightness	Set to OFF		
	Affected Function		Function Status					
» AI Brightness	Set to OFF							
ON								
AI Brightness	OFF	<ul style="list-style-type: none"> <li>Through the internal Light Sensor and AI (Artificial Intelligence) algorithm, this function detects the ambient light and automatically sets the monitor to optimal brightness for users.</li> <li>Customize allows users to adjust the auto brightness curve.</li> <li>Activating AI Brightness will affect: <table border="1" data-bbox="575 1193 926 1289"> <thead> <tr> <th>Affected Function</th> <th>Function Status</th> </tr> </thead> <tbody> <tr> <td>» Brightness</td> <td>Unable to select</td> </tr> <tr> <td>» Adaptive Dim</td> <td>Set to OFF</td> </tr> </tbody> </table> </li> </ul>	Affected Function	Function Status	» Brightness	Unable to select	» Adaptive Dim	Set to OFF
	Affected Function		Function Status					
	» Brightness		Unable to select					
» Adaptive Dim	Set to OFF							
Auto								
Customize	0-100							

Feature	Available Settings	Description							
AI Light Sensor	OFF	<ul style="list-style-type: none"> <li>Through the internal RGB Sensor and AI algorithm, this function detects the ambient color temperature and presents the best light effects synced to the environment.</li> <li>Activating AI Light Sensor will affect: <table border="1" data-bbox="572 296 921 475"> <thead> <tr> <th>Affected Function</th> <th>Function Status</th> </tr> </thead> <tbody> <tr> <td>» Low Blue Light</td> <td rowspan="4">Unable to select</td> </tr> <tr> <td>» Contrast</td> </tr> <tr> <td>» Color Temperature</td> </tr> <tr> <td>» sRGB, Adobe RGB, Display P3 Mode</td> </tr> </tbody> </table> </li> </ul>	Affected Function	Function Status	» Low Blue Light	Unable to select	» Contrast	» Color Temperature	» sRGB, Adobe RGB, Display P3 Mode
	Affected Function		Function Status						
» Low Blue Light	Unable to select								
» Contrast									
» Color Temperature									
» sRGB, Adobe RGB, Display P3 Mode									
ON									

## Gaming Features

Feature	Available Settings	Description					
KVM	Type B	HDMI™ 1	<ul style="list-style-type: none"> <li>The KVM function allows users to control multiple devices, such as a gaming PC, laptop, or console, using a single set of keyboard and mouse connected to the monitor's USB ports.</li> <li>Only one USB control path can be active at a time — choose either Type B or Type-C.</li> </ul>				
		HDMI™ 2					
		DP					
		Type C					
	Type C	HDMI™ 1					
		HDMI™ 2					
		DP					
		Type C					
SLMB	OFF	<ul style="list-style-type: none"> <li>SLMB works only at 180Hz &amp; 240Hz.</li> <li>Activating SLMB will affect: <table border="1" data-bbox="576 951 925 1015"> <thead> <tr> <th>Affected Function</th> <th>Function Status</th> </tr> </thead> <tbody> <tr> <td>» Adaptive-Sync</td> <td>Set to OFF</td> </tr> </tbody> </table> </li> </ul>	Affected Function	Function Status	» Adaptive-Sync	Set to OFF	
	Affected Function		Function Status				
» Adaptive-Sync	Set to OFF						
ON							
Optix Scope	OFF	<ul style="list-style-type: none"> <li>The center point will zoom in when Optix Scope is enabled.</li> <li>AI Crosshair and Optix Scope can be enabled at the same time.</li> <li>Activating Optix Scope will affect: <table border="1" data-bbox="576 1171 925 1264"> <thead> <tr> <th>Affected Function</th> <th>Function Status</th> </tr> </thead> <tbody> <tr> <td>» Adaptive-Sync</td> <td rowspan="2">Set to OFF</td> </tr> <tr> <td>» PIP/PBP</td> </tr> </tbody> </table> </li> </ul>	Affected Function	Function Status	» Adaptive-Sync	Set to OFF	» PIP/PBP
	Affected Function		Function Status				
	» Adaptive-Sync		Set to OFF				
	» PIP/PBP						
	ON						
Scope Ratio	x1.5						
	x2						
	x2.5						
x3							
SDR Brightness	Dynamic	<ul style="list-style-type: none"> <li>Users can switch the brightness curve for Standard Dynamic Range content.</li> <li>Dynamic: Brightness changes with the APL (Average Picture Level).</li> <li>Uniform: Brightness stays constant regardless of APL.</li> </ul>					
	Uniform						

Feature	Available Settings	Description										
Corner Uniformity	Level 1	<ul style="list-style-type: none"> <li>Corner Uniformity is the evenness of brightness from the center to corners.</li> </ul>										
	Level 2											
	Level 3											
	Level 4											
OLED Anti-Flicker PRO	OFF	<ul style="list-style-type: none"> <li>OLED Anti-Flicker PRO stabilizes the refresh rate within a defined range to reduce flicker for smoother viewing.</li> <li>This function is unavailable when Adaptive-Sync is turned off.</li> </ul>										
	Level 1											
	Level 2											
	Level 3											
DisplayHDR	True Black 500	<ul style="list-style-type: none"> <li>The DisplayHDR function enhances visuals with customizable settings for optimized brightness and contrast.</li> </ul>										
	Peak 1000 nits											
	EOTF Boost											
	Cust. (True Black 500)											
	Cust. (Peak 1000)											
	HDR Brightness											
DSC	OFF	<ul style="list-style-type: none"> <li>Users can toggle DSC (Display Stream Compression) on/off.</li> <li>For more DSC timing information, please check Preset Display Modes for DSC On/Off timing tables.</li> <li>Activating DSC will affect: <table border="1" data-bbox="575 818 926 938"> <thead> <tr> <th>Affected Function</th> <th>Function Status</th> </tr> </thead> <tbody> <tr> <td>» PIP/PBP</td> <td>Unable to select</td> </tr> <tr> <td>» Screen Size 16:10</td> <td>Set to OFF &amp; unable to select</td> </tr> </tbody> </table> </li> </ul>	Affected Function	Function Status	» PIP/PBP	Unable to select	» Screen Size 16:10	Set to OFF & unable to select				
	Affected Function		Function Status									
» PIP/PBP	Unable to select											
» Screen Size 16:10	Set to OFF & unable to select											
ON												
Adaptive-Sync	OFF	<ul style="list-style-type: none"> <li>Adaptive-Sync prevents screen tearing.</li> <li>Activating Adaptive-Sync will affect: <table border="1" data-bbox="575 1018 926 1174"> <thead> <tr> <th>Affected Function</th> <th>Function Status</th> </tr> </thead> <tbody> <tr> <td>» SLMB</td> <td></td> </tr> <tr> <td>» Optix Scope</td> <td>Set to OFF</td> </tr> <tr> <td>» PIP/PBP</td> <td></td> </tr> <tr> <td>» Screen Size 1:1</td> <td>Set to Auto</td> </tr> </tbody> </table> </li> </ul>	Affected Function	Function Status	» SLMB		» Optix Scope	Set to OFF	» PIP/PBP		» Screen Size 1:1	Set to Auto
	Affected Function		Function Status									
» SLMB												
» Optix Scope	Set to OFF											
» PIP/PBP												
» Screen Size 1:1	Set to Auto											
ON												

Feature	Available Settings	Description															
Timer	OFF	<ul style="list-style-type: none"> <li>After setting the time, press the OK Button to activate the timer.</li> <li>Users have to manually restore their preset Timer after any AC power loss and reconnection.</li> </ul>															
	ON																
	Time Adjust		15:00														
			30:00														
			45:00														
			60:00														
	Show On		Left Top														
			Right Top														
			Left Bottom														
			Right Bottom														
Customize																	
Refresh Rate	OFF	<ul style="list-style-type: none"> <li>Location is adjustable in OSD Menu. Press the OK Button to confirm and apply your Refresh Rate Location.</li> <li>This monitor follows and works at the Operating System's preset Screen Refresh Rate.</li> </ul>															
	ON																
	Show On		Left Top														
			Right Top														
			Left Bottom														
			Right Bottom														
			Customize														
Screen Size	Auto	<ul style="list-style-type: none"> <li>Users can adjust Screen Size in any mode, any resolution and any screen refresh rate.</li> <li>Activating Screen Size 1:1 will affect: <table border="1" data-bbox="575 906 926 1031"> <thead> <tr> <th>Affected Function</th> <th>Function Status</th> </tr> </thead> <tbody> <tr> <td>» Adaptive-Sync</td> <td rowspan="3">Set to OFF</td> </tr> <tr> <td>» PIP/PBP</td> </tr> <tr> <td>» Optix Scope</td> </tr> </tbody> </table> </li> <li>Activating Screen Size 16:10 will affect: <table border="1" data-bbox="575 1086 926 1179"> <thead> <tr> <th>Affected Function</th> <th>Function Status</th> </tr> </thead> <tbody> <tr> <td>» DSC</td> <td rowspan="2">Set to OFF</td> </tr> <tr> <td>» PIP/PBP</td> </tr> </tbody> </table> </li> <li>Activating Screen Size 24.5"/ 27" will affect: <table border="1" data-bbox="575 1233 926 1295"> <thead> <tr> <th>Affected Function</th> <th>Function Status</th> </tr> </thead> <tbody> <tr> <td>» PIP/PBP</td> <td>Set to OFF</td> </tr> </tbody> </table> </li> </ul> <p> <b>Important</b>  Screen Size 1:1 refers to displaying content at its original resolution. This option is disabled when the monitor is set to its native resolution.</p>	Affected Function	Function Status	» Adaptive-Sync	Set to OFF	» PIP/PBP	» Optix Scope	Affected Function	Function Status	» DSC	Set to OFF	» PIP/PBP	Affected Function	Function Status	» PIP/PBP	Set to OFF
	Affected Function		Function Status														
	» Adaptive-Sync		Set to OFF														
	» PIP/PBP																
	» Optix Scope																
	Affected Function		Function Status														
	» DSC		Set to OFF														
	» PIP/PBP																
Affected Function	Function Status																
» PIP/PBP	Set to OFF																
4:3 (Forced)																	
16:9 (Forced)																	
16:10 (Forced)																	
24.5" (by pixel)																	
27" (by pixel)																	
1:1 (by pixel)																	

# Mode

Mode	
» Eco	» RPG
» User	» Black-White
» Premium Color	» sRGB
» FPS	» Adobe RGB
» Racing	» Display P3
» RTS	

- Use Up or Down Button to select and preview mode effects.
- Press the OK Button to confirm and apply your mode type.
- The default setting “Eco” mode meets the requirements of TUV Rheinland’ s “Low Blue Light” standard.
- Activating FPS will affect:

Affected Function	Function Status
» Saturation	Unable to select

- Activating Black-White will affect:

Affected Function	Function Status
» Saturation	Unable to select
» Six-Axis Color	

- Activating sRGB, Adobe RGB, and Display P3 will affect:

Affected Function	Function Status
» AI Brightness	Set to OFF & unable to select
» AI Light Sensor	
» Contrast	Unable to select
» Color Temperature - Customize	
» Saturation	
» Six-Axis Color	
» Low Blue Light	

Feature	Available Settings	Description
Brightness	0-100	• Properly adjust Brightness according to the surrounding lighting.
Contrast	0-100	• Properly adjust Contrast to relax your eyes.
Sharpness	0-5	• Sharpness improves clarity and details of images.
Image Enhancement	OFF	• Image Enhancement enhances image edges to improve their acutance.
	Level 1	
	Level 2	
	Level 3	
	Level 4	
	Level 5	

Feature	Available Settings	Description
Color Temperature	5000K	<ul style="list-style-type: none"> <li>This feature adjusts the overall color tone of the display.</li> <li>Users can fine-tune Color Temperature in Customize mode for precise color calibration.</li> </ul>
	6500K	
	7500K	
	9300K	
	10000K	
	Customize	
	R (0-100)	
	G (0-100)	
B (0-100)		
Low Blue Light	OFF	<ul style="list-style-type: none"> <li>Low Blue Light protects your eyes against blue light. When enabled, Low Blue Light adjusts the screen color temperature to a more yellow glow.</li> <li>This monitor is a Low Blue Light monitor which will decrease the blue light emitted without adjusting the OSD settings.</li> </ul>
	ON	
Saturation	0-100	<ul style="list-style-type: none"> <li>Users can fine-tune the setting values to adjust display saturation.</li> </ul>
Six-Axis Color	R (0-100)	<ul style="list-style-type: none"> <li>This feature allows users to independently adjust the intensity and saturation of six primary and secondary colors.</li> </ul>
	G (0-100)	
	B (0-100)	
	C (0-100)	
	M (0-100)	
	Y (0-100)	
Gamma	Native	<ul style="list-style-type: none"> <li>This feature adjusts the midtone brightness of the display without affecting shadows and highlights.</li> <li>A higher gamma darkens midtones, while a lower gamma brightens them.</li> </ul>
	1.8	
	2.0	
	2.2	
	2.4	
	2.6	

## Input Source

Feature	Available Settings	Description
HDMI™ 1		<ul style="list-style-type: none"> <li>• Users can choose their preferred input source.</li> </ul>
HDMI™ 2		
DP		
Type C		
Type C PD Charge	OFF	<ul style="list-style-type: none"> <li>• This function enables users to charge their devices through a USB Type-C connector.</li> </ul>
	ON	
Auto Scan	OFF	<ul style="list-style-type: none"> <li>• Users can use the Navi Key to select Input Source at below status:               <ul style="list-style-type: none"> <li>• While “Auto Scan” is set to “OFF” with the monitor at power saving mode;</li> <li>• While “No Signal” message box is shown on the monitor.</li> </ul> </li> </ul>
	ON	

# PIP/PBP

Feature	Available Settings	Description														
PIP	OFF	<ul style="list-style-type: none"> <li>PIP (Picture in Picture) allows users to simultaneously display multiple video sources on one screen. One program is displayed on the full screen at the same time as one or more other programs are displayed in inset windows.</li> <li>PBP (Picture by Picture) is a similar feature that displays two input sources side-by-side on the screen.</li> <li>Display Swap allows users to switch between primary and secondary input sources.</li> <li>If there is only one signal input, the Display Swap and Audio Swap will be grayed out.</li> <li>Activating PIP/PBP will affect: <table border="1" data-bbox="575 544 926 911"> <thead> <tr> <th>Affected Function</th> <th>Function Status</th> </tr> </thead> <tbody> <tr> <td>» DisplayHDR</td> <td rowspan="2">Unable to select</td> </tr> <tr> <td>» DSC</td> </tr> <tr> <td>» Adaptive-Sync</td> <td rowspan="2">Set to OFF</td> </tr> <tr> <td>» Optix Scope</td> </tr> <tr> <td>» HDMI™ CEC</td> <td rowspan="2">Set to OFF &amp; unable to select</td> </tr> <tr> <td>» PBP Layout - Customize: AI Vision</td> </tr> <tr> <td>» PIP: Screen Size 1:1/ 16:10/ 24.5"/ 27"</td> <td rowspan="2">Set to Auto &amp; unable to select</td> </tr> <tr> <td>» PBP: Screen Size</td> </tr> </tbody> </table> </li> </ul>	Affected Function	Function Status	» DisplayHDR	Unable to select	» DSC	» Adaptive-Sync	Set to OFF	» Optix Scope	» HDMI™ CEC	Set to OFF & unable to select	» PBP Layout - Customize: AI Vision	» PIP: Screen Size 1:1/ 16:10/ 24.5"/ 27"	Set to Auto & unable to select	» PBP: Screen Size
	Affected Function		Function Status													
	» DisplayHDR		Unable to select													
	» DSC															
	» Adaptive-Sync		Set to OFF													
	» Optix Scope															
	» HDMI™ CEC		Set to OFF & unable to select													
	» PBP Layout - Customize: AI Vision															
	» PIP: Screen Size 1:1/ 16:10/ 24.5"/ 27"		Set to Auto & unable to select													
	» PBP: Screen Size															
	ON															
	Sub Input		HDMI™ 1													
			HDMI™ 2													
			DP													
Type C																
Sub Size	Small															
	Medium															
	Large															
Sub Ratio	Auto															
	Full Screen															
Show On	Left Top															
	Right Top															
	Left Bottom															
	Right Bottom															
	Customize															
Display Swap																
Audio Swap																
PBP	OFF															
	ON															
	PBP Layout		1:1													
			3:1													
			Customize													
	Sub Input		HDMI™ 1													
			HDMI™ 2													
			DP													
			Type C													
	Display Swap															
	Audio Swap															

# MSI OLED Care

Feature	Available Settings		Description
Pixel Shift	Slow		<ul style="list-style-type: none"> <li>Pixel Shift moves the pixels of your screen at regular intervals to reduce the possibility of screen burn-in or image retention.</li> </ul>
	Normal		
	Fast		
Panel Protect			<ul style="list-style-type: none"> <li>To maintain panel image quality, panel protect function will automatically activate when monitor using over 4 hours.</li> <li>This protect function may take several minutes to complete.</li> <li>The power indicator will blink orange color until process done.</li> <li>During process executing, please do not unplug the power cord from monitor.</li> <li>During process executing, press power button again to cancel this function.</li> </ul>
Protect Notice	Auto		<ul style="list-style-type: none"> <li>When set to Auto, Protect Notice will pop up when the panel exceeds 4 hours of cumulative usage.</li> <li>When set to Usage 24 hrs, Protect Notice will pop up when the panel exceeds 24 hours of cumulative usage.</li> <li>When Panel Protect is interrupted, Protect Notice will pop up upon next power-up.</li> </ul>
	Usage 24 hrs		
Static Screen Detection	OFF		<ul style="list-style-type: none"> <li>If Static Screen Detection is set to ON:                             <ul style="list-style-type: none"> <li>When detecting static visuals over long periods of time, the monitor reduces brightness to prevent screen burn-in.</li> <li>Once detecting moving visuals, the monitor restores its previous brightness setting.</li> </ul> </li> </ul>
	ON		
	Starting at	50 Sec	<ul style="list-style-type: none"> <li>Starting at detects the time a static image remains on the screen.</li> </ul>
		100 Sec	
	Time required	120 Sec	<ul style="list-style-type: none"> <li>Time required specifies the time for brightness reduction after detecting a static image for 50/100 seconds.</li> <li>The brightness reduction level depends on the setting of Reducing Level.</li> </ul>
		240 Sec	
Reducing Level	1-7	<ul style="list-style-type: none"> <li>Users can select a level for brightness reduction.</li> <li>Reducing effect depends on Brightness/ DisplayHDR setting.</li> </ul>	
Multi Logo Detection	OFF		<ul style="list-style-type: none"> <li>This function helps prevent image sticking phenomenon. When set to ON, brightness reduction of multi logo areas will kick in if logos are detected.</li> </ul>
	ON		
	Reducing Level	1-4	<ul style="list-style-type: none"> <li>Users can select a level for brightness reduction.</li> <li>Reducing effect depends on Brightness/ DisplayHDR setting.</li> </ul>

Feature	Available Settings	Description	
Multi Icon Detection	OFF	<ul style="list-style-type: none"> <li>This function helps prevent image sticking phenomenon. When set to ON, brightness reduction of multi icon areas will kick in if icons are detected.</li> </ul>	
	ON		
	Reducing Level	1-3	<ul style="list-style-type: none"> <li>Users can select a level for brightness reduction.</li> <li>Reducing effect depends on Brightness/ DisplayHDR setting.</li> </ul>
Taskbar Detection	OFF	<ul style="list-style-type: none"> <li>This function helps prevent image sticking phenomenon. When set to ON, brightness reduction of taskbar areas will kick in if taskbars are detected.</li> </ul>	
	ON		
	Reducing Level	1-4	<ul style="list-style-type: none"> <li>Users can select a level for brightness reduction.</li> <li>Reducing effect depends on Brightness/ DisplayHDR setting.</li> </ul>
Boundary Detection	OFF	<ul style="list-style-type: none"> <li>This function helps prevent image sticking phenomenon. When set to ON, brightness reduction of boundary areas will kick in if boundaries, such as letters &amp; pillars, are detected.</li> </ul>	
	ON		
	Reducing Level	1-4	<ul style="list-style-type: none"> <li>Users can select a level for brightness reduction.</li> <li>Reducing effect depends on Brightness/ DisplayHDR setting.</li> </ul>
V-Split Detection	OFF	<ul style="list-style-type: none"> <li>This function helps prevent image sticking phenomenon. When set to ON, brightness reduction along vertical boundaries during multitasking or split-screen gaming will kick in.</li> </ul>	
	ON		
	Reducing Level	1-4	<ul style="list-style-type: none"> <li>Users can select a level for brightness reduction.</li> <li>Reducing effect depends on Brightness/ DisplayHDR setting.</li> </ul>
Auto Dim Control	OFF	<ul style="list-style-type: none"> <li>This function prevents image sticking by gradually dimming the screen. When set to ON, it automatically reduces full-screen brightness when detecting static images.</li> </ul>	
	ON		
	Starting Speed	Slow	<ul style="list-style-type: none"> <li>Starting Speed defines how quickly Auto Dim Control detects a static image.</li> </ul>
		Fast	
	Reducing Speed	Slow	<ul style="list-style-type: none"> <li>Users can specify the speed for brightness reduction.</li> </ul>
Fast			
Reducing Level	1-6	<ul style="list-style-type: none"> <li>Users can select a level for brightness reduction.</li> <li>Reducing effect depends on Brightness/ DisplayHDR setting.</li> </ul>	
OLED Panel Info.		<ul style="list-style-type: none"> <li>This field shows the information of MSI OLED Care.</li> </ul>	

## General

Feature	Available Settings		Description
Language	繁體中文		<ul style="list-style-type: none"> <li>• Users have to press the OK Button to confirm and apply the Language setting.</li> <li>• Language is an independent setting. Users' own language setting will override the factory default. When users set Reset to Yes, Language will not be changed.</li> </ul>
	English		
	Français		
	Deutsch		
	Italiano		
	Español		
	한국어		
	日本語		
	Русский		
	Português		
	简体中文		
	Bahasa Indonesia		
	Türkçe		
(More languages coming soon)			
Power LED	OFF		<ul style="list-style-type: none"> <li>• Users can toggle the Power LED on/off.</li> <li>• During the Panel Protect process, the power LED indicator will blink orange until the process is complete.</li> </ul>
	ON		
Audio	Volume	0-100	<ul style="list-style-type: none"> <li>• Users can adjust Audio Volume in any mode.</li> </ul>
	Mute		
RGB LED	OFF		<ul style="list-style-type: none"> <li>• Users can turn the RGB LED on or off.</li> </ul>
	MSI - Mystic Light		
	RGB Brightness		
OSD Menu	OSD Position	Adjust	<ul style="list-style-type: none"> <li>• This feature adjusts the location of the OSD menu on the screen for user convenience.</li> </ul>
		Position Reset	
	OSD Transparency	0~5	<ul style="list-style-type: none"> <li>• Users can adjust OSD Transparency in any mode.</li> </ul>
	OSD Time Out	5~30	<ul style="list-style-type: none"> <li>• Users can adjust OSD Time Out in any mode.</li> </ul>
Ultra Low Power	OFF		<ul style="list-style-type: none"> <li>• This setting reduces power consumption for more energy-efficient operation.</li> </ul>
	ON		

Feature	Available Settings	Description	
HDMI™ CEC	OFF	<ul style="list-style-type: none"> <li>HDMI™ CEC (Consumer Electronics Control) supports Sony PlayStation®, Nintendo® Switch™, Xbox Series X S consoles and various audio-visual devices that are CEC-capable.</li> <li>If HDMI™ CEC is set to ON:               <ul style="list-style-type: none"> <li>The monitor will automatically power on when the CEC device is turned on.</li> <li>The CEC device will enter power saving mode when the monitor is turned off.</li> <li>When Sony PlayStation®, Nintendo® Switch™, or Xbox Series X S console is connected, Mode will be automatically set to the default mode and can be adjusted to users' preferred mode later.</li> </ul> </li> </ul>	
	ON		
Navi Key	Up Down Left Right	OFF	<ul style="list-style-type: none"> <li>All Navi Key items can be adjusted via OSD Menus.</li> </ul>
		Brightness	
		Mode	
		Input Source	
		AI Crosshair	
		AI Vision	
		Timer	
		Refresh Rate	
		PIP/PBP	
		Optix Scope	
		Info. On Screen	
Info. On Screen	OFF	<ul style="list-style-type: none"> <li>The information of the monitor status will be shown on the right side of the screen.</li> </ul>	
	ON		
Service Info.	FW Version	<ul style="list-style-type: none"> <li>View product service details, such as firmware version and serial number, in this setting.</li> </ul>	
	Serial Number		
Reset All	YES	<ul style="list-style-type: none"> <li>Users can Reset and restore settings to original OSD Default in any mode.</li> </ul>	
	NO		

# Specifications\*

Monitor	MPG 322UR QD-OLED X24
Size	31.5 inch
Curvature	Flat
Panel Type	QD-OLED
Resolution	3840x2160 (UHD)
Aspect Ratio	16:9
Brightness	<ul style="list-style-type: none"> <li>• Typical SDR: 300 nits</li> <li>• Peak HDR: 1000 nits</li> </ul>
Contrast Ratio	1500000 : 1
Refresh Rate (Maximum)	240Hz
Response Time	GTG: 0.03ms (Min.)
I/O	<ul style="list-style-type: none"> <li>• 1 x Headphone Jack</li> <li>• 1 x DisplayPort</li> <li>• 2 x HDMI™ Connector</li> <li>• 1 x USB Type-C Port</li> <li>• 1 x USB 5Gbps Type-B Upstream Port</li> <li>• 2 x USB 5Gbps Type-A Port</li> </ul>
View Angles	178°(H) , 178°(V)
DCI-P3** / sRGB	99% / 138%
Surface Treatment	Anti-Reflection
Display Colors	1.07B, 10 bits
Monitor Power Options	100-240V~, 50/60Hz, 3.7A
Power Consumption (Typical)	<ul style="list-style-type: none"> <li>• Power On &lt; 290W</li> <li>• Standby &lt; 0.5W</li> <li>• Power Off &lt; 0.3W</li> </ul>
Adjustment (Height)	0 ~ 110mm
Adjustment (Tilt)	-5° ~ 15°
Adjustment (Swivel)	-30° ~ 30°
Adjustment (Pivot)	-10° ~ 10°
Kensington Lock	Yes

Monitor		MPG 322UR QD-OLED X24
VESA Mounting		<ul style="list-style-type: none"> <li>• Plate Type: 100 x 100 mm</li> <li>• Screw Type: M4 x 10 mm <ul style="list-style-type: none"> <li>• Thread Diameter: 4 mm</li> <li>• Thread Pitch: 0.7 mm</li> <li>• Thread Length: 10 mm</li> </ul> </li> </ul>
Dimension (W x H x D)		717.3 x 477.1 x 241.9 mm
Weight	Net	9.4 kg
	Gross	14.8 kg
Operating Environment		<ul style="list-style-type: none"> <li>• Temperature: 0°C to 40°C</li> <li>• Humidity: 20% to 90%, non-condensing</li> <li>• Altitude: 0 ~ 5000m</li> </ul>
Storage Environment		<ul style="list-style-type: none"> <li>• Temperature: -20°C to 60°C</li> <li>• Humidity: 10% to 90%, non-condensing</li> </ul>

\* Some technical specifications of the device may be subject to change by the manufacturer. Please verify the specifications with the seller or the manufacturer's representative.

\*\* Based on CIE1976 test standards.

# Preset Display Modes

## Important

- All information is subject to change without prior notice.
- HDMI™ VRR (Variable Refresh Rate) synchronizes with Adaptive-Sync (ON/ OFF). For VRR ON/OFF status, please check Adaptive-Sync.
- To activate DSC-specific timing and frequency, ensure your graphics card supports DSC (Display Stream Compression).

## DSC ON, OLED Anti-Flicker PRO

Standard	Resolution		HDMI™	DP	USB-C	
QHD	2560x1440	@60Hz	V	V	V	
		@120Hz	V	V	V	
UHD	3840x2160	@60Hz	V	V	V	
		@120Hz		V	V	
		@180Hz	V	V	V	
		@240Hz	V	V	V	
Video Timing Resolution	720P		V	V	V	
	1080P	@60Hz	V	V	V	
		@120Hz	V	V	V	
	2160P	@30Hz	V			
		@60Hz	V			
		@120Hz	V			
	HDMI™ VRR			V		
	OLED Anti-Flicker PRO Block 0, Block 1 AMD VSDB Range	OFF	48-240Hz			
		Level 1	60-240Hz			
		Level 2	100-240Hz			
Level 3		120-240Hz				

## DSC OFF, OLED Anti-Flicker PRO

Standard	Resolution		HDMI™	DP	USB-C	
QHD	2560x1440	@60Hz	V	V	V	
		@120Hz	V	V	V	
UHD	3840x2160	@60Hz	V	V	V	
		@120Hz		V	V	
		@165Hz	V (8 bits)			
		@180Hz		V	V	
		@240Hz		V	V	
Video Timing Resolution	720P		V	V	V	
	1080P	@60Hz	V	V	V	
		@120Hz	V	V	V	
	2160P	@30Hz	V			
		@60Hz	V			
		@120Hz	V			
	HDMI™ VRR		V			
	OLED Anti-Flicker PRO Block 0, Block 1 AMD VSDB Range	OFF	48-165Hz	48-240Hz		
		Level 1	60-165Hz	60-240Hz		
		Level 2	100-165Hz	100-240Hz		
Level 3		120-165Hz	120-240Hz			

## Screen Size 24.5", DSC ON, OLED Anti-Flicker PRO

Standard	Resolution		HDMI™	DP	USB-C
24.5"	2992x1680	@60Hz	V	V	V
		@120Hz	V	V	V
		@240Hz	V (10 bits)	V (10 bits)	V (10 bits)
	HDMI™ VRR		V		
OLED Anti-Flicker PRO Block 0, Block 1 AMD VSDB Range	OFF	48-240Hz			
	Level 1	60-240Hz			
	Level 2	100-240Hz			
	Level 3	120-240Hz			

### Screen Size 24.5", DSC OFF, OLED Anti-Flicker PRO

Standard	Resolution		HDMI™	DP	USB-C	
24.5"	2992x1680	@60Hz	V	V	V	
		@120Hz	V	V	V	
		@165Hz	V (10 bits)			
		@240Hz		V (10 bits)	V (10 bits)	
	HDMI™ VRR			V		
	OLED Anti-Flicker PRO Block 0, Block 1 AMD VSDB Range	OFF		48-165Hz	48-240Hz	
		Level 1		60-165Hz	60-240Hz	
		Level 2		100-165Hz	100-240Hz	
		Level 3		120-165Hz	120-240Hz	

### Screen Size 27", DSC ON, OLED Anti-Flicker PRO

Standard	Resolution		HDMI™	DP	USB-C	
27"	3296x1852	@60Hz	V	V	V	
		@120Hz	V	V	V	
		@240Hz	V (10 bits)	V (10 bits)	V (10 bits)	
		HDMI™ VRR			V	
	OLED Anti-Flicker PRO Block 0, Block 1 AMD VSDB Range	OFF		48-240Hz		
		Level 1		60-240Hz		
		Level 2		100-240Hz		
		Level 3		120-240Hz		

### Screen Size 27", DSC OFF, OLED Anti-Flicker PRO

Standard	Resolution		HDMI™	DP	USB-C	
27"	3296x1852	@60Hz	V	V	V	
		@120Hz	V	V	V	
		@165Hz	V (10 bits)			
		@240Hz		V (10 bits)	V (10 bits)	
	HDMI™ VRR			V		
	OLED Anti-Flicker PRO Block 0, Block 1 AMD VSDB Range	OFF		48-165Hz	48-240Hz	
		Level 1		60-165Hz	60-240Hz	
		Level 2		100-165Hz	100-240Hz	
		Level 3		120-165Hz	120-240Hz	

### PIP Mode (Not Support HDR)

Standard	Resolution		HDMI™	DP	USB-C
QHD	2560x1440	@60Hz	V	V	V
		@120Hz	V	V	V
UHD	3840x2160	@60Hz	V	V	V
		@120Hz	V	V	V
Video Timing Resolution	720P		V	V	V
	1080P	@60Hz	V	V	V
		@120Hz	V	V	V
	2160P	@30Hz	V	V	
		@50Hz	V	V	
		@60Hz	V	V	

### PBP Mode (Not Support HDR)

Standard	Resolution		HDMI™	DP	USB-C
Video Timing Resolution	720P		V	V	V
PBP 1:1/Customize	1920x2160	@60Hz	V	V	V
PBP 3:1	960x2160	@60Hz	V	V	V
	2880x2160	@60Hz	V	V	V

### Screen Size 16:10 (Not Support HDR)

Standard	Resolution		HDMI™	DP	USB-C
QHD+	2560x1600	@60Hz	V	V	V
		@120Hz	V	V	V

# Troubleshooting

## **The power LED is off.**

- Press the monitor power button again.
- Check if the monitor power cable is properly connected.

## **No image.**

- Check if the computer graphics card is properly installed.
- Check if the computer and monitor are connected to electrical outlets and are turned on.
- Check if the monitor signal cable is properly connected.
- The computer may be in Standby mode. Press any key to activate the monitor.

## **The screen image is not properly sized or centered.**

- Refer to Preset Display Modes to set the computer to a setting suitable for the monitor to display.

## **No Plug & Play.**

- Check if the monitor power cable is properly connected.
- Check if the monitor signal cable is properly connected.
- Check if the computer and graphics card are Plug & Play compatible.

## **The icons, font or screen are fuzzy, blurry or have color problems.**

- Avoid using any video extension cables.
- Adjust brightness and contrast.
- Adjust RGB color or tune color temperature.
- Check if the monitor signal cable is properly connected.
- Check for bent pins on the signal cable connector.

## **The monitor starts flickering or shows waves.**

- Change the refresh rate to match the capabilities of your monitor.
- Update your graphics card drivers.
- Keep the monitor away from electrical devices that may cause electromagnetic interference (EMI).

# Safety Instructions

- Read the safety instructions carefully and thoroughly.
- All cautions and warnings on the device or User Guide should be noted.
- Refer servicing to qualified personnel only.

## Power

- Make sure that the power voltage is within its safety range and has been adjusted properly to the value of 100~240V before connecting the device to the power outlet.
- If the power cord comes with a 3-pin plug, do not disable the protective earth pin from the plug. The device must be connected to an earthed mains socket-outlet.
- Please confirm the power distribution system in the installation site shall provide the circuit breaker rated 120/240V, 20A (maximum).
- Always disconnect the power cord or switch the wall socket off if the device would be left unused for a certain time to achieve zero energy consumption.
- Place the power cord in a way that people are unlikely to step on it. Do not place anything on the power cord.
- If this device comes with an adapter, use only the MSI provided AC adapter approved for use with this device.

## Environment

- To reduce the possibility of heat-related injuries or of overheating the device, do not place the device on a soft, unsteady surface or obstruct its air ventilators.
- Use this device only on a hard, flat and steady surface.
- To prevent the device from tipping over, secure the device to a desk, wall or fixed object with an anti-tip fastener that helps to properly support the device and keep it safe in place.
- To prevent fire or shock hazard, keep this device away from humidity and high temperature.
- Do not leave the device in an unconditioned environment with a storage temperature above 60°C or below -20°C, which may damage the device.
- The maximum operating temperature is around 40°C.
- When cleaning the device, be sure to remove the power plug. Use a piece of soft cloth rather than industrial chemical to clean the device. Never pour any liquid into the opening; that could damage the device or cause electric shock.
- Always keep strong magnetic or electrical objects away from the device.

- If any of the following situations arises, get the device checked by service personnel:
  - The power cord or plug is damaged.
  - Liquid has penetrated into the device.
  - The device has been exposed to moisture.
  - The device does not work well or you can not get it working according to the User Guide.
  - The device has dropped and damaged.
  - The device has obvious sign of breakage.

# TÜV Rheinland Certification

## TÜV Rheinland Low Blue Light Certification

Blue light has been shown to cause eye fatigue and discomfort. MSI now offers monitors with TÜV Rheinland Low Blue Light certification to ensure users' eye comfort and well-being. Please follow the instructions below to reduce the symptoms from extended exposure to the screen and blue light.



Low Blue Light  
(Hardware  
Solution)  
Flicker Free  
[www.tuv.com](http://www.tuv.com)

- Place the screen 20 – 28 inches (50 – 70 cm) away from your eyes and a little below eye level.
- Consciously blinking the eyes every now and then will help to reduce eye strain after extended screen time.
- Take breaks for 20 minutes every 2 hours.
- Look away from the screen and gaze at a distant object for at least 20 seconds during breaks.
- Make stretches to relieve body fatigue or pain during breaks.

## TÜV Rheinland Flicker Free Certification

- TÜV Rheinland has tested this product to ascertain whether the display produces visible and invisible flicker for the human eye and therefore strains the eyes of users.
- TÜV Rheinland has defined a catalogue of tests, which sets out minimum standards at various frequency ranges. The test catalogue is based on internationally applicable standards or standards common within the industry and exceeds these requirements.
- The product has been tested in the laboratory according to these criteria.
- The keyword “Flicker Free” confirms that the device has no visible and invisible flicker defined in this standard within the range of 0 - 3000 Hz under various brightness settings.
- The display will not support Flicker Free when Anti Motion Blur/MPRT is enabled. (The availability of Anti Motion Blur/MPRT varies by products.)

# Regulatory Notices

## CE Conformity

This product has been tested and found to comply with the harmonized standards for Information Technology Equipment published under Directives of Official Journal of the European Union.



## FCC-B Radio Frequency Interference Statement

This equipment has been tested and found to comply with the limits for a Class B digital device, pursuant to Part 15 of the FCC Rules. These limits are designed to provide reasonable protection against harmful interference in a residential installation. This equipment generates, uses and can radiate radio frequency energy and, if not installed and used in accordance with the instruction manual, may cause harmful interference to radio communications. However, there is no guarantee that interference will not occur in a particular installation. If this equipment does cause harmful interference to radio or television reception, which can be determined by turning the equipment off and on, the user is encouraged to try to correct the interference by one or more of the measures listed below:



- Reorient or relocate the receiving antenna.
- Increase the separation between the equipment and receiver.
- Connect the equipment into an outlet on a circuit different from that to which the receiver is connected.
- Consult the dealer or an experienced radio/television technician for help.

### Notice 1

The changes or modifications not expressly approved by the party responsible for compliance could void the user's authority to operate the equipment.

### Notice 2

Shielded interface cables and AC power cord, if any, must be used in order to comply with the emission limits.

This device complies with Part 15 of the FCC Rules. Operation is subject to the following two conditions:

1. This device may not cause harmful interference, and
2. This device must accept any interference received, including interference that may cause undesired operation.

### MSI Computer Corp.

901 Canada Court, City of Industry, CA 91748, USA

(626) 913-0828

[www.msi.com](http://www.msi.com)

## WEEE Statement

**European Union:** This symbol on the product indicates that this product cannot be discarded as municipal waste. Instead, it is your responsibility to dispose of your waste electrical and electronic equipment by handing it over to a designated collection point for recycling. For more information about where you can drop off your waste equipment for recycling, please contact your local city office, your household waste disposal service or the shop where you purchased the product.



## Chemical Substances Information

In compliance with chemical substances regulations, such as the EU REACH Regulation (Regulation EC No. 1907/2006 of the European Parliament and the Council), MSI provides the information of chemical substances in products at:  
<https://csr.msi.com/global/index>

## RoHS Statement

### Japan JIS C 0950 Material Declaration

A Japanese regulatory requirement, defined by specification JIS C 0950, mandates that manufacturers provide material declarations for certain categories of electronic products offered for sale after July 1, 2006.  
<https://csr.msi.com/global/Japan-JIS-C-0950-Material-Declarations>

### India RoHS

This product complies with the “India E-waste (Management and Handling) Rule 2016” and prohibits use of lead, mercury, hexavalent chromium, polybrominated biphenyls or polybrominated diphenyl ethers in concentrations exceeding 0.1 weight % and 0.01 weight % for cadmium, except for the exemptions set in Schedule 2 of the Rule.

### Turkey EEE Regulation

Conforms to the EEE Regulations of the Republic Of Turkey.

### Ukraine Restriction of Hazardous Substances

The equipment complies with requirements of the Technical Regulation, approved by the Resolution of Cabinet of Ministry of Ukraine as of 10 March 2017, № 139, in terms of restrictions for the use of certain dangerous substances in electrical and electronic equipment.

### Vietnam RoHS

As from December 1, 2012, all products manufactured by MSI comply with Circular 30/2011/TT-BCT temporarily regulating the permitted limits for a number of hazardous substances in electronic and electric products.

## Bangladesh RoHS Statement

This product shipped to Bangladesh complies with the RoHS requirements set forth in the Hazardous Waste (E-waste) Management Rules, 2021 by Government of Bangladesh.

For more information, please refer to: <https://csr.msi.com/global/bangladesh-rohs-statement>

## Bangladesh E-waste Management Reminder

Please manage, dismantle, dispose of, or recycle e-waste properly as per the Environmental Protection Rules, 1997 to avoid the harm that may be caused to the environment and ecosystem, public interest and public health.

## Material Declaration under India's Plastic Waste Management Rules:

INDOMSI COMPUTERS PRIVATE LIMITED

Regn. No.: IM-06-000-06-AAHCI0478A-25

Thickness  $\geq$  50 microns

## Green Product Features

- Reduced energy consumption during use and stand-by
- Limited use of substances harmful to the environment and health
- Easily dismantled and recycled
- Reduced use of natural resources by encouraging recycling
- Extended product lifetime through easy upgrades
- Reduced solid waste production through take-back policy

## Environmental Policy

- The product has been designed to enable proper reuse of parts and recycling and should not be thrown away at its end of life.
- Users should contact the local authorized point of collection for recycling and disposing of their end-of-life products.
- Visit the MSI website <[https://csr.msi.com/global/pevn\\_ewaste](https://csr.msi.com/global/pevn_ewaste)> and locate a nearby distributor for further recycling information.
- Please visit <<https://us.msi.com/page/recycling>> for information regarding the recycling of your product in the US.



## Warning!

Overuse of screens is likely to affect eyesight.

## Recommendations:

1. Take a 10-minute break for every 30 minutes of screen time.
2. Children under 2 years of age should have no screen time. For children aged 2 years and over, screen time should be limited to less than one hour per day.

## Copyright and Trademarks Notice



Copyright © Micro-Star Int'l Co., Ltd. All rights reserved. The MSI logo used is a registered trademark of Micro-Star Int'l Co., Ltd. All other marks and names mentioned may be trademarks of their respective owners. No warranty as to accuracy or completeness is expressed or implied. MSI reserves the right to make changes to this document without prior notice.



The terms HDMI™, HDMI™ High-Definition Multimedia Interface, HDMI™ Trade dress and the HDMI™ Logos are trademarks or registered trademarks of HDMI™ Licensing Administrator, Inc.

## Technical Support

If a problem arises with your product and no solution can be obtained from the user's manual, please contact your place of purchase or local distributor. Alternatively, please visit <https://www.msi.com/support/> for further guidance.