

Getac

ZX10 Series

USER MANUAL

Rugged Mobile Computing Solution

July 2025

Trademarks

Comes with the Google™ app and Google Chrome™

Google, Android and Gboard are trademarks of Google LLC.

The Bluetooth word mark and logos are owned by the Bluetooth SIG, Inc.

All other brand and product names are trademarks or registered trademarks of their respective companies.

Disclaimer

Specifications and manuals are subject to change without notice. Getac assumes no liability for damage incurred directly or indirectly from errors, omissions, or discrepancies between the device and the manuals.

Notes

Depending on the specific model you purchased, the color and look of your model may not exactly match the graphics shown in this document.

The screenshots and other presentations shown in this document are for reference only. They may differ from the actual screens and presentations generated by the actual product.

Your device is based on Android™ 15 operating system, with additions by Getac.

For the latest version of the manual, please visit the Getac website at www.getac.com.

Table of Contents

Chapter 1	Getting Started.....	1
	Identifying Hardware Components	1
	Front Components.....	1
	Back Components	4
	Right-Side Components.....	5
	Left-Side Components	5
	Top Components.....	6
	Bottom Components	6
	Getting Your Device Ready for Use	7
	Installing the Nano-SIM Card (Select Models Only)	7
	Installing the Battery Pack	7
	Using the Stylus Tether (Optional)	8
	Connecting to External Power and Charging the Battery..	9
	Performing the Initial Startup	10
Chapter 2	Operating Basics.....	11
	Waking Up and Shutting Down.....	11
	Waking Up	11
	Shutting Down.....	11
	Navigating on the Screen	12
	Touch Mode	13
	Using the Dual Mode Display (Select Models Only)	13
	Home Screen	14
	Using Applications	15
	Navigation Buttons	15
	Status Bar.....	15
	Quick Settings and Notifications Panel	16
	Entering Information.....	17
	Quick QR Code Scanning (Select Models Only).....	18

Chapter 3	Getting Connected	19
	Wireless Connections	19
	Using WWAN (Select Models Only)	19
	Using Wi-Fi Networks	20
	Using the Bluetooth Function.....	20
	External Connections	21
	Connections via USB Type-C.....	21
	Connections via USB Type-A	22
	Connecting an Audio Device	22
	Using a microSD Card.....	23
	Using a Smart Card (Select Models Only).....	24
Chapter 4	Getac Applications	25
	Getac Camera	25
	Taking Photos	26
	Recording Videos.....	27
	Control Buttons.....	28
	Camera Settings.....	29
	GetacIME.....	32
	Using the Text Scanner.....	32
	Using the Barcode Scanner	34
	GetacIME Settings.....	36
	DisplayLink Presenter.....	38
Chapter 5	Managing Your Device	39
	Managing Power.....	39
	Battery Protection Mechanism	39
	Low Battery Signals and Actions	40
	Installing or Replacing the Battery Pack	40
	Power-Saving Tips.....	43
	Battery Guidelines	43
	Customizing Your Device	44
	Settings.....	44
	Getac Settings	44
Chapter 6	Care and Maintenance	50
	Restart or Hard Reboot.....	50
	Restart	50
	Hard Reboot.....	50
	Update Center	51
	Updating the OS	51
	Updating Getac Apps	53
	Update Center Settings.....	53

Update Center Scan	54
Caring for Your Device	55
Appendix A Specifications	56
Appendix B Regulatory Information.....	58
Safety Precautions.....	58
About Charging	58
About the Charger	58
About the Battery.....	59
Heat Related Concerns	60
North America	61
USA	61
Canada.....	63
User Notification of Take-back Service	64
Europe Marking and Compliance Notices.....	66
Statements of Compliance	66
Restriction of Hazardous Substances (RoHS) Directive	68
About USB Power Delivery.....	68
RF Exposure Information (SAR).....	69
ENERGY STAR	69

Chapter 1

Getting Started

This chapter introduces you to the external components of your device and guides you through the process of setting up your device for use.

CAUTION: Safety instructions are provided in related sections throughout the *User Manual*. Please read the manual and any accompanying document(s) before starting to use the product.

Identifying Hardware Components

Front Components

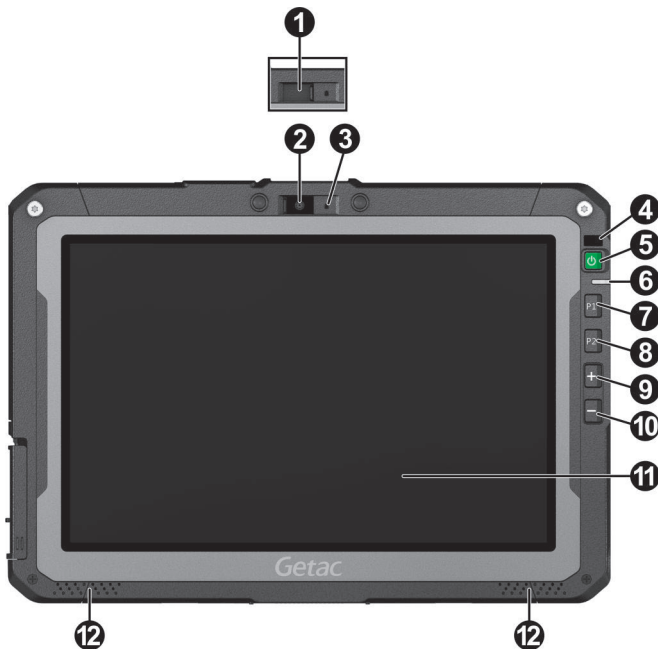



Ref	Component	Description	
①	Camera cover (optional)	Covers the camera lens. Slide the cover to open or close it. The cover provides privacy protection.	
②	Camera lens (optional)	Allows you to use the camera function. The front lens supports 8 MP with fixed focus.	
③	Microphone	Receives sound and voice.	
④	Light sensor	Senses the ambient light for automatic adjustments of the display backlight.	
⑤	Power button	Short press	Goes into or wakes up from sleep mode.
		Long press	Starts up the device from the power off state. NOTE: In high temperatures, the device may take a longer time to start up or undergo automatic restart(s) during the process.
			Opens a menu with Power off option when the device power is on.
			A press longer than 8 seconds brings different results. (See "Restart or Hard Reboot" in Chapter 6 for information.)
⑥	Battery Charge indicator	Lights amber when the battery is being charged.	
		Lights green when battery charging is completed.	
		Blinks green when the battery is being discharged intentionally due to the battery protection mechanism.	
		Blinks amber when charging is in an abnormal state. Replace the battery in case this happens.	

Ref	Component	Description
⑦	P1 button	Increases the LCD brightness (default setting).
⑧	P2 button	Decreases the LCD brightness (default setting).
⑨	Plus button	Increases the sound volume (default setting). The type of sound adjusted depends on the current operation.
⑩	Minus button	Decreases the sound volume (default setting). The type of sound adjusted depends on the current operation.
⑪	Touchscreen	Displays and receives information for the device.
⑫	Speaker	Plays music, sounds and voices.
⑬	Handle (optional)	Provides a convenient way to carry the device. NOTE: When carrying the device around, always use the handle.
		When placing the device on a table top for work, rotate the handle backwards to serve as a stand.

NOTE:

- The hardware buttons (except the power button) can be re-defined using **Getac Settings**.
- The response time of LCDs can be affected by low temperatures. The display has a slower response time in low temperature environments. This does not mean the LCD is defective. The LCD will resume normal response time after returning to room temperature.

Back Components

NOTE: If you have the high-capacity battery model, the battery pack looks different from the one shown here.

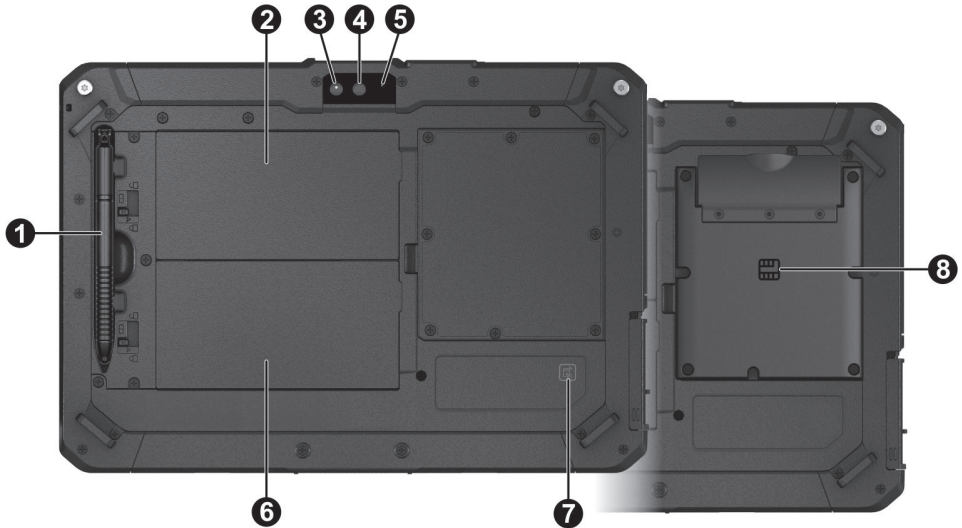

Ref	Component	Description
❶	Stylus (optional)	Serves as the input device by tapping on the touchscreen to make selections and enter information.
❷	Battery pack	Supplies power to your device when external power is not connected.
❸	Camera lens (optional)	Allows you to use the camera function. The rear lens supports 16 MP with auto focus.
❹	Flash LED	Provides extra light in certain applications.
❺	Microphone	Receives sound and voice.
❻	Additional battery pack (optional)	Provides additional battery power to your device (as Battery 2).

Ref	Component	Description
⑦	NFC antenna (optional)	Reads data from or writes data to NFC tags. NOTE: When not using an NFC card, do not leave it within or near the antenna area.
⑧	Smart card reader (optional)	Accepts a smart card for additional security feature.

Right-Side Components



Ref	Component	Description
①	Kensington lock	Locks the device to a stationary object for security.

Left-Side Components

Using the small bar on the protective cover as a point to apply force, slide the cover to open it.

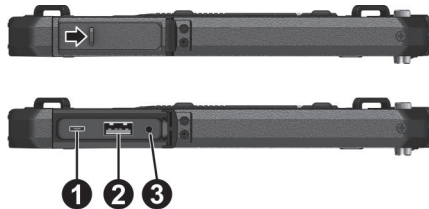

Ref	Component	Description
①	USB 3.2 Gen 1 Type-C connector	Connects a USB device that supports USB Type-C connection.
②	USB 2.0 connector	Connects a USB peripheral device.
③	Combo audio connector	Connects a set of headphones or external speakers with amplifier. Supports a headset microphone with 4-pole TRRS 3.5mm jack.

Top Components



Ref	Component	Description
①	Barcode scanner lens (optional)	Scans barcodes. NOTE: The maximum operating temperature for the barcode scanner is 50 °C (122 °F).

Bottom Components

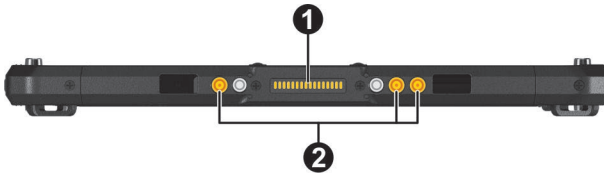

Ref	Component	Description
①	Docking connector	Connects to the office or vehicle dock (purchased separately).
②	Tri antenna passthrough (optional)	Connects the external antenna for GPS/WWAN/WLAN (from left to right). The connection can be either direct (Device mode) or through the docking station (Dock mode). NOTE: By default, all antennas are enabled for Dock mode. If the antenna(s) is connected directly, you have to change the settings in Getac Settings → Device → Antenna . (See “Getac Settings” in Chapter 5 for setup information.)

Getting Your Device Ready for Use

Installing the Nano-SIM Card (Select Models Only)

Noting the orientation, insert the nano-SIM card all the way into the slot.



NOTE: To remove the nano-SIM card, just push in the card to release it and then pull it out.

Installing the Battery Pack

NOTE: If you have the high-capacity battery model, the battery pack looks different from the one shown here. The removal/installation method is the same.

1. With the battery pack correctly oriented, attach its connector side to the battery bay at an angle (1) and then press down the other side (2).

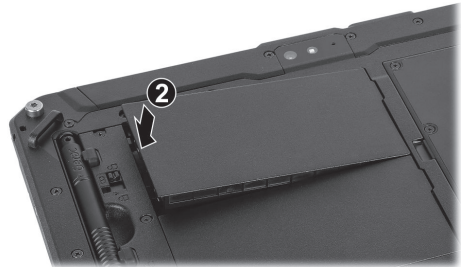

- Slide the battery latch toward the locked position (🔒), not revealing the underneath red part.



Correct



Incorrect (revealing red part)

CAUTION: To ensure sealing capability and IP66 protection performance, always keep the battery latch locked unless you need to unlock it for a specific purpose.

Using the Stylus Tether (Optional)

A stylus and tether can be purchased from Getac.

- Thread one of the tether's loops through the hole of the stylus (❶). Then, insert the other loop through the first loop (❷) and pull the tether tight.

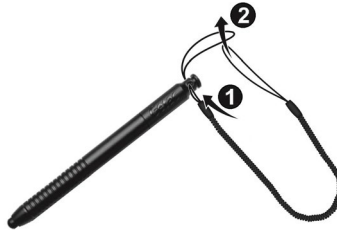

- Insert the other loop to the tether hole on the device (❶). Then, insert the stylus through the loop (❷) and pull it tight.

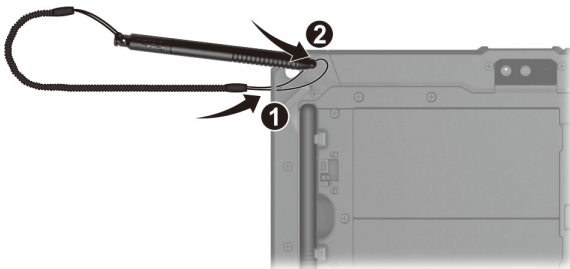

If your model has the handle, attach the tether to the D-ring on the handle.

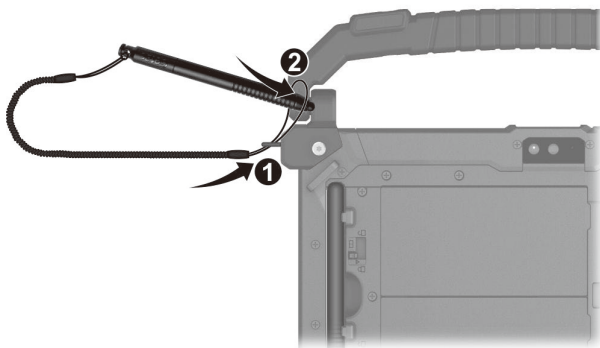

Connecting to External Power and Charging the Battery

NOTE:

- The battery pack is shipped to you in power saving mode that protects it from charging/discharging. It will get out of the mode to be ready for use when you install the battery pack and connect external power to the device for the very first time. External power can be connected by way of the USB Type-C connector or docking connector.
- Charging will not start if the battery's temperature is outside the allowed range, which is between 2 °C (35.6 °F) and 50 °C (122 °F). Once the battery's temperature meets the requirements, charging automatically resumes.

1. Have the USB-C power adapter (or called charger) ready.

You should use the appropriate wattage/voltage USB-C power adapter for your model.

Recommended specifications: 25 W (or above)

Depending on your purchase, your model may come with the power adapter.

NOTE: In case the voltage of your power source is below the recommended specifications, the battery will only be charged during device power-off state.

2. Open the protective cover on the left side of the device.

3. Connect the power adapter. (The power adapter shown here as the example is the one available from Getac.)

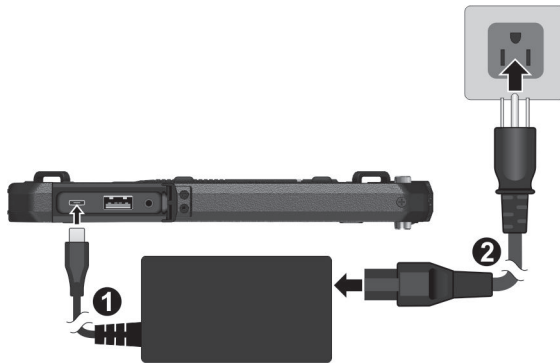

NOTE: The power cord type varies with countries.

4. The Battery Charge indicator glows in amber when charging is in progress. Do not disconnect your device from AC power until the battery is fully charged, as indicated by the amber indicator turning into green. This will take a couple of hours.

Performing the Initial Startup

NOTE: You must use external power when starting up the device for the very first time.

When turning on your device for the very first time, you will be guided through a setup process.

1. Make sure that your device is connected to external power.
2. To turn on the device, press and hold the power button for at least 3 seconds until the screen lights up.

The device powers up and displays the initial screen.

3. Follow the on-screen instructions to complete the initial setup process.

After the setup is completed, the Home screen appears. You can now use your device.

Chapter 2

Operating Basics

This chapter familiarizes you with the basic operations of your device.

CAUTION:

- Do not expose your skin to the device when operating it in a very hot or cold environment.
- The device can get uncomfortably warm when you use it in high temperatures. As a safety precaution in such a circumstance, do not place the device on your lap or touch it with your bare hands for extended periods of time. Prolonged body contact can cause discomfort and potentially a burn.
- When the device is placed flat on a table top for work, the back surface can get hot after long working hours. Take precautions if you need to carry the device around while it is hot to the touch. Depending on your model, a carrying handle or strap may be available as an option. You can use the handle or strap to carry the device.

NOTE: The instructions in this chapter are based on the default settings of the device.

Waking Up and Shutting Down

Waking Up

Your device sleeps after a period of inactivity. To wake up, press the power button and, at the lock screen, swipe up to unlock.

Shutting Down

Press and hold the power button until a menu pops up. Tap **Power off**.

NOTE: If the device somehow cannot display the power off menu, you can force the device to power off by pressing and holding the power button for more than 8 seconds.

Navigating on the Screen

Use your finger or the stylus (purchased separately) to navigate and select objects on the screen. Here are some common terms that you should know when using the touchscreen:

- **Tap**
Touch the screen once with the finger (or stylus) to open an item or select an object.
- **Tap and hold**
Touch and hold the finger (or stylus) on an item to see a list of actions available for that item.
- **Drag**
Hold the finger (or stylus) on an item and, without lifting the finger (or stylus), move across the screen until you reach the target position.
- **Swipe or slide**
Move the finger (or stylus) across the screen, without pausing when you first touch it (so you don't "drag" instead). For example, you slide the screen up or down to scroll a list.
- **Pinch**
In some applications (such as Maps and Photos), you can zoom in and out by placing two fingers on the screen at once and pinching them together (to zoom out) or spreading them apart (to zoom in).

NOTE:

- An optical film has been attached to the screen before shipment. The film is a consumable, which will be worn out by possible scratches. You can purchase a new one when replacement is required.
- When the touchscreen does not seem to respond, put the device to sleep and then wake it. The screen should function again.

Touch Mode

You can change the touch mode to suit your scenario. To quickly switch the mode, tap one of the widgets on the Home screen.



Enables simultaneous use with Getac stylus or finger touch.

Has a higher sensitivity to allow use with gloves (referring to warm gloves or work gloves, not referring to touchscreen-capable gloves).

Select this mode when liquids, such as raindrops, are falling on the screen and should be rejected as input. Works best with fingertips.

Using the Dual Mode Display (Select Models Only)

Dual mode display (if your model has the feature) incorporates both touchscreen and digitizer functions.

The display is set to Touchscreen mode by default. Touchscreen mode provides all the functionalities that an ordinary touchscreen has. When the device receives signals from the digitizer pen, the display automatically switches to Digitizer mode.

You can move the cursor by bringing the digitizer pen close to the screen, without actually touching the screen's surface. The digitizer pen has a shortcut button that functions as the right-click of a mouse.



NOTE: If you want the display to exclude Touchscreen mode and work in Digitizer mode only, you can adjust the settings in **Getac Settings** → **Touchscreen**. (See "Getac Settings" in Chapter 5 for setup information.)

Home Screen

The Home screen is your starting point to access all the features on your device. You can have it display application icons, widgets, shortcuts, and other features that you want. The default Home screen already contains some app icons and widgets.

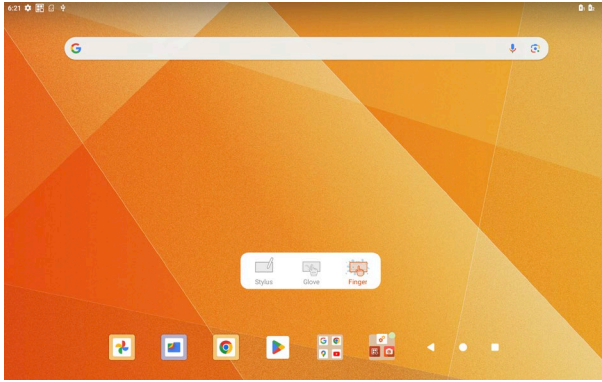

To return to the Home screen at any time, tap the Home icon  at the bottom of the screen.

You can add app icons, shortcuts, widgets, and other items to any part of the Home screen where there's free space.

Using Applications

Swipe up from the bottom of the Home screen to open the All Apps screen. The screen holds icons for all of the apps on your device. Tap an icon to open the app.

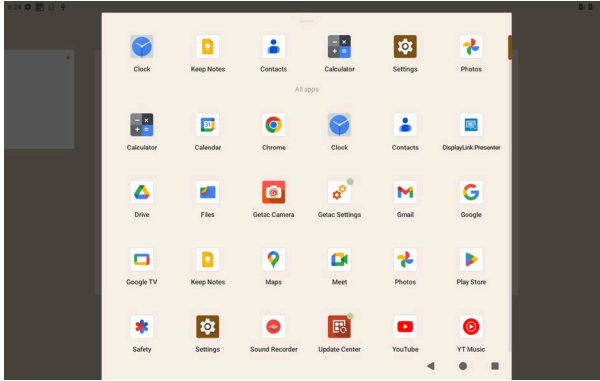

Navigation Buttons

The navigation buttons at the bottom of the screen provides buttons for navigation purposes and frequently-used tasks.

Button	Name	Description
◀	Back	To go back to the previous screen.
○	Home	To open the Home screen.
□	Recent	To open the Recent Apps screen. From here, you can switch to or close a recently used app.

Status Bar

The Status Bar appears at the top of almost every screen. It displays icons indicating the current status (on the right) and icons indicating that you've received notifications (on the left), along with the current time.

Quick Settings and Notifications Panel

You can open Quick Settings and Notifications Panel by swiping down from the top of the screen.

Quick Settings allow you to quickly change common settings such as screen brightness, Wi-Fi, Bluetooth, Airplane mode, and others.

Notifications Panel provides timely reminders for events, tasks, and alerts.

*Quick Settings:
Swipe left to see more setting items.*

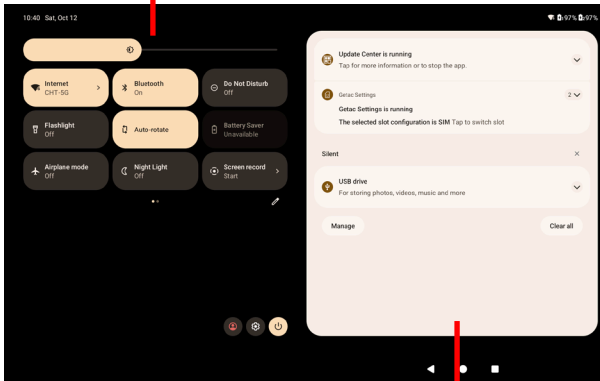

*Notifications Panel:
You can interact with your
list of notifications.*

Swipe up to close Quick Settings and Notifications Panel.

Entering Information

You enter text, numbers, and symbols using the virtual keyboard (or called on-screen keyboard). Some applications open the keyboard automatically. In others, the keyboard opens when you tap an input field.

NOTE: If the virtual keyboard does not open, go to **Settings → System → Languages & input → Physical keyboard** and enable **Use on-screen keyboard**.

Your device has two virtual keyboards (Gboard and GetacIME).

- **Gboard:** This is the default Google™ keyboard.

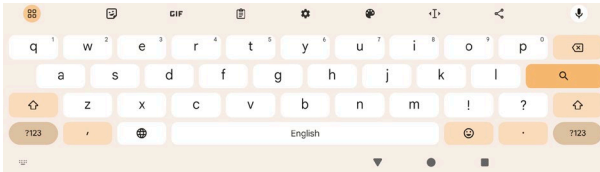

- **GetacIME:** This is a virtual keyboard developed by Getac. It incorporates a text scanner and barcode scanner into the English keyboard. (See “GetacIME” in Chapter 4 for detailed information on using the keyboard.)



You can change to a different input method by tapping  at the bottom corner of the screen. Or, when the “Getac Input method” item has been enabled in **Getac Settings**, you can switch between Gboard and GetacIME using the floating buttons as shown below.

Switch to QWERTY keyboard



Switch to Barcode Scanner



Switch to Text Scanner



Switch to Gboard



Quick QR Code Scanning (Select Models Only)

If your model has the barcode scanner lens, you can quickly scan a QR code to access a website.

Note that you have to define a hardware button as “Trigger” via the **Getac Settings** app first. (See “Getac Settings” in Chapter 5 for setup information.)

1. Go to the Home screen.
2. Press the **Trigger** button (i.e., the hardware button that has been defined as such).
3. Aim the scan beam at the barcode. Adjust the lens’ distance from the barcode, shorter for a smaller barcode and farther for a larger one.

NOTE:

- The scan beam will light up with a slight delay because it is initiated from the power off state each time.
- The scan beam projected from the lens varies with models. The below illustration serves as an example only.



4. Upon a successful scan, the device beeps and the decoded barcode data is entered in the Google Search bar.

The scan beam also turns off after timeout.

NOTE: You can turn off the beep sound and change the timeout duration in **Getac Settings**. (See “Getac Settings” in Chapter 5.)

Chapter 3

Getting Connected

This chapter tells you how you can get your device connected through a variety of ways.

Wireless Connections

Using WWAN (Select Models Only)

NOTE:

- Your model only supports data transmission. Voice transmission is not supported.
- For instructions on installing the nano-SIM card, see “Installing the Nano-SIM Card (Select Models Only)” in Chapter 1.

Select models support dual SIM: physical SIM (4G LTE or 5G) as SIM 1 and eSIM as SIM 2.

Mobile network is enabled by default. The icons in the status bar indicate which kind of data network you’re connected to and the network signal strength.

To check or modify settings, go to **Settings** → **Network & internet**. Tap the **Settings** icon next to the mobile network name.

To check the specific WWAN module information, go to **Getac Settings** and check the items under **WWAN**.

Using Dual SIM

Only one SIM can be activated at a time. You can switch between SIM 1 and SIM 2 according to your needs. (Go to **Getac Settings** → **Select slot**.)

Using Wi-Fi Networks

Turning On/Off the Wi-Fi Radio

Open **Quick Settings** and tap the Wi-Fi icon.

When the Wi-Fi radio is turned on, the icon  appears in the status bar. If your device finds a network that you connected to previously, it connects to it.

Connecting to a Wi-Fi Network

1. Open **Quick Settings**. Tap and hold the Wi-Fi icon.
- or -
Go to **Settings** → **Network & internet** → **Internet**.
2. Your device scans for available Wi-Fi networks and displays the names in the screen.
3. On the list of discovered networks, tap the one you want to connect to.
4. If the network is secured, you're prompted to enter a password or other credentials.

If the network is open, you are prompted to confirm that you want to connect to that network by tapping **Connect**.

Using the Bluetooth Function

NOTE: Getac does not guarantee the product's compatibilities with the Bluetooth headsets/devices from all manufacturers.

Turning On/Off the Bluetooth Radio

Open **Quick Settings** and tap the Bluetooth icon.

Pairing with a Bluetooth Device

The first time you use a new Bluetooth device with your device, you must "pair" them, so that they know how to connect securely to each other. After that, you can simply connect to a paired device.

1. Open **Quick Settings**. Tap and hold the Bluetooth icon.
- or -
Go to **Settings** → **Connected devices**.

2. Tap **Pair new device**.

Your device scans for and displays the IDs of all available Bluetooth devices in range.

3. On the list of discovered devices, tap the ID of the device you want to pair with.
4. The devices pair with each other. If you're prompted to enter a passcode, try entering 0000 or 1234 (the most common passcodes), or consult the documentation that came with the device to learn its passcode.

If the pairing is successful, your device connects to the device. The icon  appears in the status bar.

External Connections

Connections via USB Type-C

Your device has a USB Type-C connector. "USB Type-C" (or simply "USB-C") is a physical USB connector format that features small size and free orientation. This connector supports:

- **USB 3.2 Gen 1** (data transfer rate up to 5 Gbps)
You can connect your device to a computer with the USB cable, to transfer files between your device and the computer. Use the USB cable (available to you as an option) to connect the device to a USB connector on your computer.



NOTE: With a proper adapter, you can still connect a USB peripheral that has a Type-A connector to this Type-C connector. However, Getac does not guarantee the compatibility with all USB peripherals via the adapter.

- **DisplayPort over USB-C**
You can connect a display monitor that supports DisplayPort.

- **USB Power Delivery**

You should use the appropriate wattage/voltage USB-C power adapter for your specific model.

USB-C power adapter specifications: 25 W (or above)

NOTE: If you connect the USB-C power adapter to the device with no battery pack installed, the device cannot start up.

Connections via USB Type-A

Your device has a USB 2.0 Type-A host connector for connecting USB peripheral devices, such as a USB drive.



Connecting an Audio Device

The audio combo connector is the “4-pole TRRS 3.5mm” type so you can connect a compatible headset microphone.

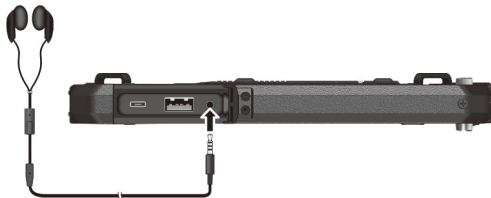

SAFETY WARNING: 

To prevent possible hearing damage, do not listen at high volume levels for long periods.

Using a microSD Card

Inserting a microSD card

1. The microSD card slot is located in the lower battery bay. To access the microSD card slot, remove the battery bay cover or the additional battery pack (if existing). (See steps 2 and 3 of “Replacing the Battery Pack” in Chapter 5 for instructions.)
2. Noting the orientation, insert the microSD card into the microSD card slot.



3. Replace the cover or battery pack. (See steps 4 and 5 of “Replacing the Battery Pack” in Chapter 5 for instructions.)

Remove a microSD card

You can safely remove the microSD card from your device any time the device is shut down. If you need to remove the card while the device is on, unmount the card first to prevent corrupting or damaging the card.

To unmount:

1. Go to **Settings** → **Storage** and then tap the **Eject** icon next to your microSD card.
2. Remove the battery bay cover or the additional battery pack.
3. Press the edge of the card to release it and then pull the card out of the slot.
4. Replace the cover or battery pack.

Using a Smart Card (Select Models Only)

To insert a smart card:

1. Locate the smart card reader. Open the cover.
2. With the embedded computer chip facing front and near the slot, slide the smart card into the slot.

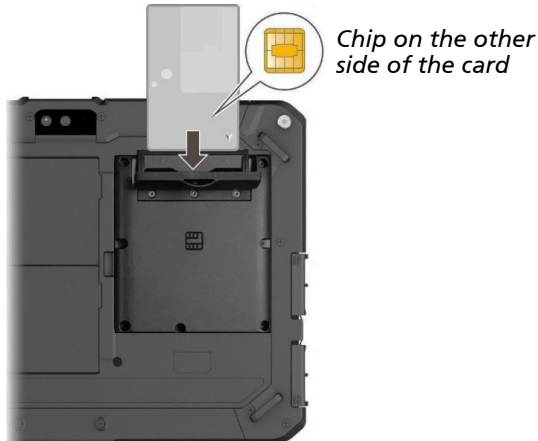

3. Close the cover.

To remove a smart card:

1. Make sure that the third-party smart card software is not accessing the smart card.
2. Open the cover.
3. Press the edge of the card to release it and then pull the card out of the slot.
4. Close the cover.

Chapter 4

Getac Applications

In addition to Android preinstalled apps from Google, several apps are added to your device by Getac. This chapter describes these Getac apps.

NOTE:

- For instructions on using the preinstalled apps from Google, check Google official website for online help.
- You can use Update Center to update Getac apps to the latest version. (See “Updating Getac Apps” in Chapter 6 for information.)

Getac Camera

Use the **Getac Camera** app to take photos and record videos.

To open the app, use any of the below methods:

- Tap the **Getac Camera** app icon  , which can be found the Getac folder and the All Apps screen.
- Quickly press the power button twice (if the “Quickly open camera” function is enabled).

NOTE: The “Quickly open camera” function is enabled by default. If you want to disable the function, go to **Settings** → **System** → **Gestures**.

Taking Photos

1. Open the Getac Camera app.

If you are in Video mode, tap  to switch to Camera mode.



2. **To focus on a specific area:** Tap the area in the preview window. A green focus frame appears.

To zoom in or out: Use the pinch gesture on the preview window or move the knob along the slider at the bottom corner of the screen.

For other immediate controls, use the control buttons. (See "Control Buttons" for detailed information.)

For overall settings, tap . (See "Camera Settings".)

3. To take the photo, tap .

4. The photo you just took is displayed as a thumbnail at the corner. You can tap the thumbnail to view the photo.

The photo will be saved as a JPG file in the predefined folder.

Recording Videos

1. Open the Getac Camera app.

If you are in Camera mode, tap  to switch to Video mode.

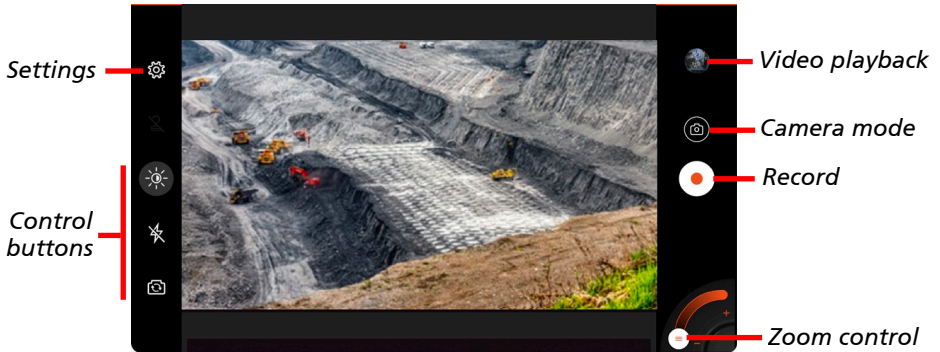

2. **To focus on a specific area:** Tap the area in the preview window. A green focus frame appears.



To zoom in or out: Use the pinch gesture on the preview window or move the knob along the slider at the bottom corner of the screen.

For other immediate controls, use the control buttons. (See "Control Buttons" for detailed information.)

For overall settings, tap . (See "Camera Settings".)

3. To start recording the video, tap .

The elapsed time shows at the bottom.

4. During the recording, you can pause and resume by tapping  and .







If you want to capture a still image while recording, tap .









- To stop recording, tap .
- An image from your most recent video is displayed as a thumbnail at the corner. You can tap the thumbnail to view the video.

The video will be saved as a MP4 file in the predefined folder.

Control Buttons

Any setting change remains valid until you change it again.

Button	Description
 Photo Stamp	<p>To enable or disable photo stamp which can include date, time, location, and text. The icon indicates the current status.</p> <p> - On</p> <p> - Off (default)</p> <p>When you first enable photo stamp, you will be guided to the settings menu.</p> <p>NOTE: Not supported in Video mode.</p>
	<p>To expand subitems for exposure and white balance settings.</p>
 White Balance	<p>To select a white balance mode according to the current light source.</p> <p>When you tap an icon, the mode name will briefly appear on the screen. Available modes are Auto (default), Incandescent, Fluorescent, Warm fluorescent, Daylight, Cloudy daylight, Shade, and Twilight.</p>
 Exposure Value	<p>To select an exposure value from the available choices.</p>

Button	Description
 Flash (for Camera mode)	To select a flash mode for photo taking. Tap to cycle through the choices. The icon indicates the current status.  - Automatic (default)  - On  - Off
 Flash (for Video mode)	To turn on or off the flashlight for video recording. The icon indicates the current status.  - Off (default)  - On
 Camera Switch	To switch between the front and back camera lens.

Camera Settings

While in Getac Camera, tap  at the top left corner to open the settings menu.

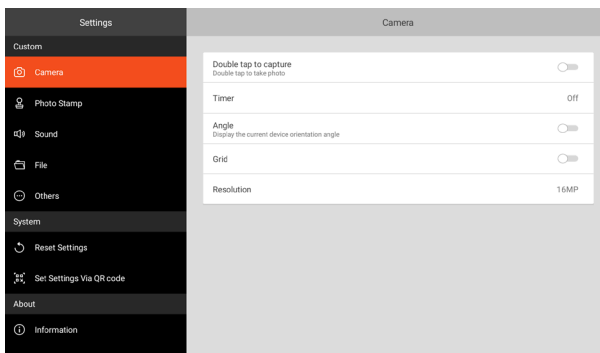

Item	Description
------	-------------

Camera

Double tap to capture	To set if you can take the photo by double tapping where you want to focus in the preview window.
Timer	To set the countdown timer for taking the photo.
Angle	To set if the device orientation angle is displayed in the preview window.
Grid	To enable or disable the 3x3 grid feature. This feature helps you achieve better balance in the composition of a photo. What you do is place your points of interest in the intersections or along the grid lines.
Resolution	To set the camera photo resolution. Available choices depend on the current camera lens in use.

Photo Stamp

Date	To select the date format or to select None when you don't want the photo stamp to include the date.
Time	To select the time format or to select None when you don't want the photo stamp to include the time.
GPS	To enable or disable the adding of geographical information (if available) in the photo stamp.
Text	To add text in the photo stamp. Tap Custom text and type the text in the input field. Otherwise, select None .

Sound

Shutter sound	To enable or disable the shutter sound played upon photo taking.
Timer beep	To enable or disable the beep sound for the timer.

File

File name	To add character(s) before the photo/video filename. Enter the character(s) in the input field and tap OK .
File information	To set if the information embedded into the image file includes one or both of the following items.

Item	Description
	<ul style="list-style-type: none"> • Location data (Geotagging) • Compass direction

Others

Force maximum brightness	To keep the display brightness at the highest level (overriding the system settings) while in the Getac Camera main screen.
Keep display on	To keep the display on (overriding the system settings) while in the Getac Camera main screen.
JPEG Image quality	To set the amount of JPEG compression. A lower percentage means a lower quality.
File path	To specify the location for storing the photos/videos. Options are: <ul style="list-style-type: none"> • Internal Storage • SD card

Reset Settings

Reset settings to default	To reset all Getac Camera settings to the default values.
----------------------------------	---





Set Settings Via QR code

Import settings	To import Getac Camera settings from another device by scanning the QR code on that device. This is convenient when you want to copy the settings from another device.
Export settings	The QR code in this screen contains the current Getac Camera settings. When Getac Camera on another device scans the QR code, the settings will be copied to that device. The SAVE button allows you to save the QR code as a PNG file named GetacQR-Camera in the DCIM folder of your device. The SHARE button allows you to share the QR code image with others through an available sharing option.

GetacIME

GetacIME (Input Method Editor) is a virtual keyboard that features:

- QWERTY keyboard
- Text scanner
- Barcode scanner

To switch to the GetacIME keyboard, tap  at the bottom corner of the screen and select **GetacIME**. Or, if the “Getac Input method” item has been enabled in **Getac Settings**, you can switch to GetacIME by tapping one of the floating buttons   .

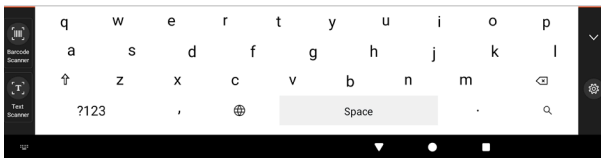

NOTE: When you use Text Scanner or Barcode Scanner for the very first time, you will be asked to allow permissions for the app. Tap **ALLOW** when asked.

Using the Text Scanner

NOTE: The Text Scanner supports Roman alphabet including letters, numerals, punctuation marks, and symbols.

Text Scanner is a text recognition tool. It can detect text from images captured by the rear camera.

To input text using this tool:

1. Place the insertion point (or called cursor) where you want the data to be entered.

- Switch to the GetaclIME keyboard. Tap **Text Scanner**  on the left side of the keyboard.

You can also use the floating button  (if enabled) to access the function.

- The scan preview window appears. Turn on the torch if needed.

While in landscape view, you can expand/reduce the preview window and move the reduced window left/right.

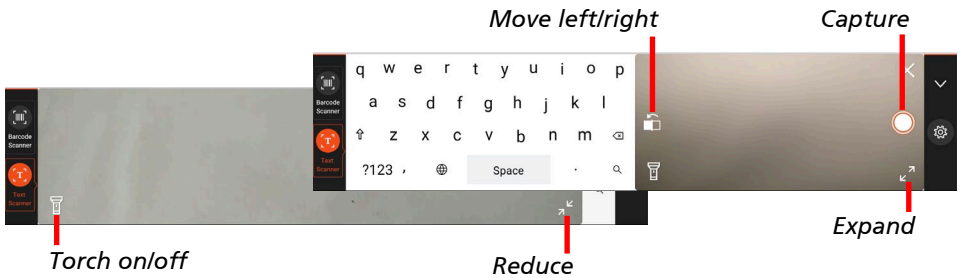

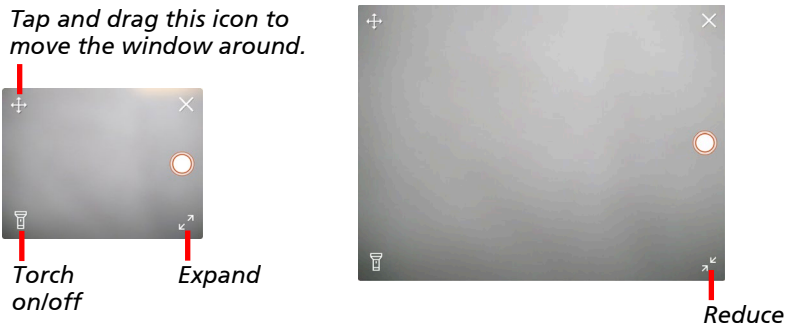

If you access the function by using the floating button, the scan preview window pops up. You can expand/reduce the preview window and move the window around.

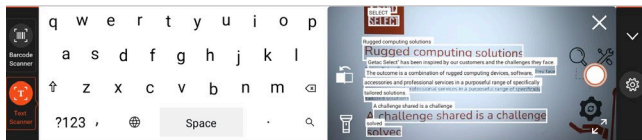

- Aim the rear camera lens at the target.

Each unit of the recognized text will be surrounded by a white border with the result displayed at the top left side of the white border.



5. Use one of the two methods to select the one you want to enter.
 - **Method 1:** Tap the unit that contains the text string you want.
 - **Method 2:** Tap the **Capture** button  to freeze the current preview window. Tap the unit that contains the text string you want.
6. If you have frozen the preview window, tap **←** to go back to live scan.
7. When finished using the tool, tap **X** to close the preview window.

Using the Barcode Scanner

NOTE:

- Most common 1D and 2D symbologies are supported.
- Make sure your target barcode type has been enabled in **Getac Settings**. Depending on the type, you have to set up the “Symbologies” or “OCR” setting item under the “Barcode” category. (See “Getac Settings” in Chapter 5 for information.)

Barcode Scanner is a barcode scanning and decoding tool. It can scan barcodes with either the rear camera or the barcode scanner lens (select models only).

1. Place the insertion point (or called cursor) where you want the data to be entered.
2. Switch to the GetacIME keyboard. Tap **Barcode Scanner**  on the left side of the keyboard.

You can also use the floating button  (if enabled) to access the function.

3. If your model comes with the barcode scanner, you can choose between **Barcode** and **Camera**.

Using Barcode Scanner:

Tap the **Capture** button  on the screen or press the **P** button on your

device. Aim the scan beam at the barcode. Upon a successful scan, the scan beam turns off.

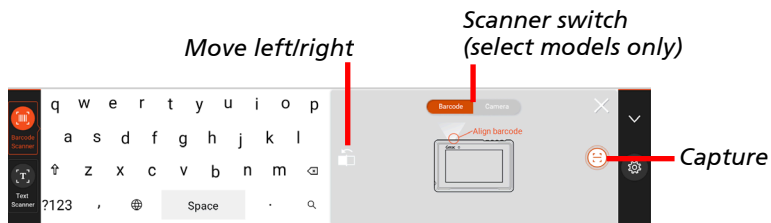

- or -

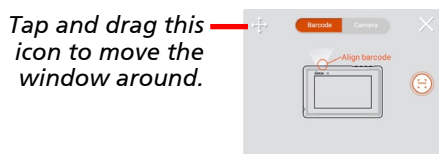

4. Steps 4 to 7 are instructions for the camera scanner.

Using Camera Scanner:

Several buttons are available in the preview window. (See step 3 in "Using the Text Scanner" for more instructions.)

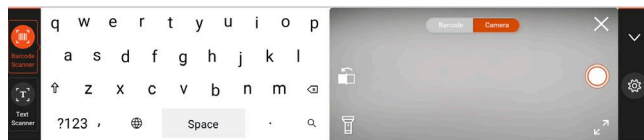

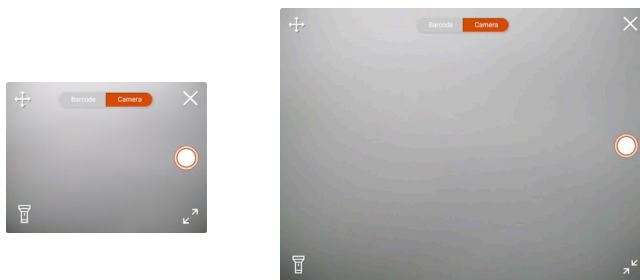

- or -



5. Aim the rear camera lens at the target.

Each scanned barcode will be surrounded by a white border with the result displayed at the top left side of the white border.



6. Use one of the two methods to select the one you want to enter.
 - **Method 1:** Tap the unit that contains the decoded barcode data you want.
 - **Method 2:** Tap the **Capture** button  to freeze the current preview window. Tap the unit that contains the decoded barcode data you want.
7. If you have frozen the preview window, tap  to go back to live scan.
8. When finished using the tool, tap **X** to close the preview window.

GetacIME Settings

When GetacIME is open, tap  to access its settings menu.

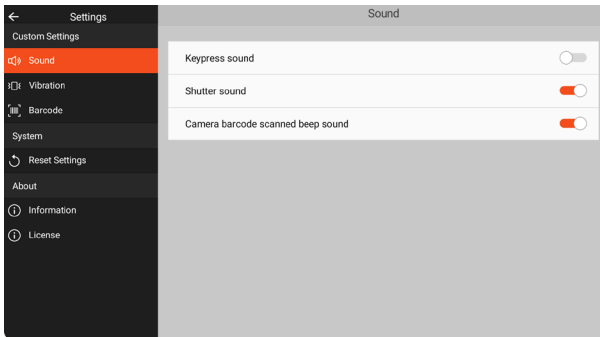

Item	Description
Sound	
Keypress sound	To enable or disable the typing sound whenever a key is pressed.

Item	Description
Shutter sound	To enable or disable the shutter sound played upon barcode/text capturing with the rear camera.
Camera barcode scanned beep sound	To enable or disable the beep sound upon a successful barcode scan with the camera scanner.

Vibration

Keypress vibrate	To enable or disable device vibration whenever a key is pressed.
Barcode scanned vibration	To enable or disable device vibration upon a successful barcode scan with the camera scanner.

Barcode

Barcode prefix/suffix	To add character(s) before/after each decoded data string. Besides alphanumeric characters, you can enter character code(s) such as <code>\n</code> , <code>\t</code> , <code>\b</code> , and <code>\r</code> . Tap Custom Text , enter the character(s) in the input field, and tap OK .
Encoding type	To specify the codepage for mapping the character codes to characters. When the data received does not display with the proper characters, it may be because the barcode being scanned was created using a codepage that is different from the one the app is expecting. If this is the case, select the codepage with which the barcodes were created. The data characters should then appear properly.

Reset Settings

Reset settings to default	To reset the settings to default values.
----------------------------------	--

DisplayLink Presenter

This app is for using a HDMI display through the Office Dock (an option). There is no need to manually start the app. Whenever the device detects a HDMI connection, a reminder window from DisplayLink Presenter will pop up. Follow the onscreen instructions to mirror the Android screen to the HDMI display.

Chapter 5

Managing Your Device

This chapter tells you how to manage power and customize your device.

Managing Power

Your device supports up to two battery packs (Battery 1 and Battery 2). If your device has two battery packs, they are charged and discharged in parallel.

The operating time of a fully charged battery depends on how you are using the device. Some functions, such as using multimedia or operating a microSD card, may consume the battery power considerably.



CAUTION: A battery pack can be removed only when it is not being charged/discharged or if you are hot-swapping the battery pack.

NOTE: The battery level may automatically lessen due to the self-discharge process, even when the battery is fully charged.

Battery Protection Mechanism

The battery has a self-protection mechanism which limits the maximum charge of the battery to an appropriate level in particular situations.

The battery protection mode will be automatically activated once the battery is found to be in a situation that requires protection. You will receive a notification in the Notifications Panel and see the corresponding icon in the Status Bar. The protection mode will be suspended when the battery is not in the situation any more.

Status Icon	Description
	<p>When charging for an extended period of time, battery protection mode has been activated, and the battery level will be maintained at 75% or higher.</p>
	<p>According to device temperature, battery protection mode has been activated, and the battery level will be maintained at an appropriate capacity.</p>

NOTE: This automatic battery protection is not equivalent to “Battery Charging Mode” in **Getac Settings**. When the battery is in an automatic protection mode as described above, the mode has priority over the Battery Charging Mode. When the battery is out of the automatic protection mode, the Battery Charging Mode takes effect. (See “Getac Settings” later in this chapter for information on Battery Charging Mode.)

Low Battery Signals and Actions

The battery status (charging or discharging) and level (as a percentage of fully charged) are displayed at the top of the screen. To check the battery information, go to **Settings** → **Battery**.

You should save your data and recharge the battery immediately upon a warning of low power; otherwise your device will turn off automatically. You need to connect the device to external power for charging before you can use it again.

CAUTION: When you recharge the battery upon a warning of low power, you should charge for at least 30 minutes. If you unplug the power adapter soon, you may not have sufficient battery power for your operation.

Installing or Replacing the Battery Pack

CAUTION:

- There is danger of explosion if the battery is incorrectly replaced. Replace the battery only with the device manufacturer’s battery packs. Discard used batteries according to the dealer’s instructions.
- Do not attempt to disassemble the battery pack.
- A battery pack can get hot due to long working hours. Do not touch a hot battery pack with bare hands. After removing a battery pack, put it in a well-ventilated area.

NOTE:

- You can hot swap one battery pack while the other one is supplying the power. The appropriate temperature range for hot swapping the battery pack is between -21°C (-5.8°F) and 45°C (113°F).
- Removing both battery packs (which is discouraged in normal circumstances) will cause the RTC (real-time clock) to reset to the factory default settings. The date and time values will be correct when the device next connects to the network; or you can also manually set the values.
- If you have the high-capacity battery model, the battery pack looks different from the one shown here. The removal/installation method is the same.

Installing the Additional Battery Pack

If you have purchased an additional battery pack and are installing it in the lower battery bay for the very first time, you have to remove the battery bay cover from the battery bay. Follow the same methods as described in steps 2 and 3 in the next subsection to remove the battery bay cover.

Follow the same methods as described in steps 4 and 5 in the next subsection to install the battery pack.

Replacing the Battery Pack

1. Skip this step if you are hot swapping the battery pack.

Turn off the device and disconnect the power adapter. After turning off the device, allow a cool-down time of at least 5 minutes before removing the battery pack.

2. Locate the battery pack you want to remove. Slide the battery latch toward the right (❶) and then upwards (❷) to release the battery pack.

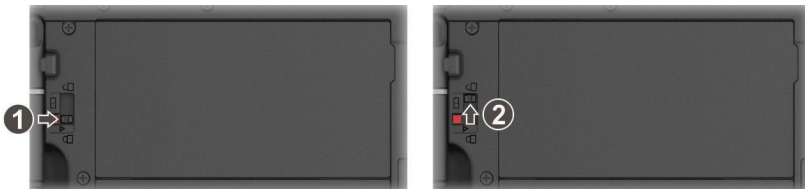

3. Remove the battery pack from its bay.

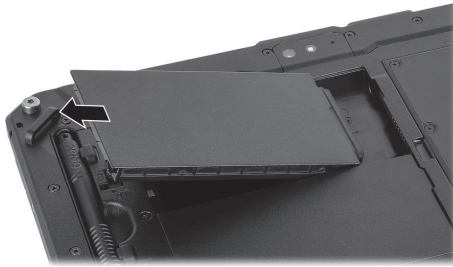

(Battery 1 as the example)

4. Fit another battery pack into place. With the battery pack correctly oriented, attach its connector side to the battery bay at an angle (❶) and then press down the other side (❷).

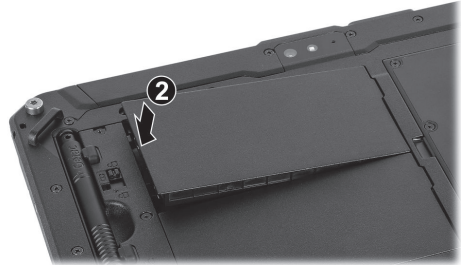

(Battery 1 as the example)

5. Slide the battery latch toward the locked position (🔒), not revealing the underneath red part.



Correct

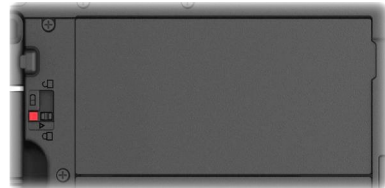

Incorrect (revealing red part)

CAUTION: To ensure sealing capability and IP66 protection performance, always keep the battery latch locked unless you need to unlock it for a specific purpose.

Power-Saving Tips

You can extend your battery's life between charges by turning off features that you don't need. You can also monitor how apps and system resources consume battery power.

- Enable Battery Saver. Set a shorter screen timeout.
- Decrease the LCD brightness to the lowest comfortable level.
- Lower the volume.
- Turn off the wireless radio if you are not using the wireless module.
- If you don't need it, turn off automatic syncing for all apps.
- Avoid power-consuming apps. To check which apps consume the most battery power, go to **Settings** → **Battery**.

Battery Guidelines

For optimal performance of the battery, take note of the following:

- During charging, do not disconnect the power adapter before the battery has been fully charged; otherwise you will get a prematurely charged battery.
- There is no need to fully discharge the battery before charging. You can charge the battery before it is discharged.
- As a battery protection, store the device where the temperature is appropriate. Avoid high temperatures.
- If you will not use the product for a long period of time, be sure to fully charge the battery at least once every two weeks. Over discharge of the battery can affect the charging performance.

Customizing Your Device

NOTE:

- Make sure that you fully understand the function of a certain item before any adjustment.
- Some setting items are available only for specific models or apps you have in your device.

Settings

The **Settings** app contains most of the tools for customizing and configuring the Android device.

To open Settings, use any of the below methods:

- Open **Quick Settings** and tap the **Settings** icon .
- Open the All Apps screen and tap **Settings**.

For information on standard Android settings, check Google official website for online help.

Getac Settings

Use **Getac Settings** to configure functions specific to your device. Tap the

Getac Settings app icon , which can be found in the default Home screen, the Getac folder, and the All Apps screen.

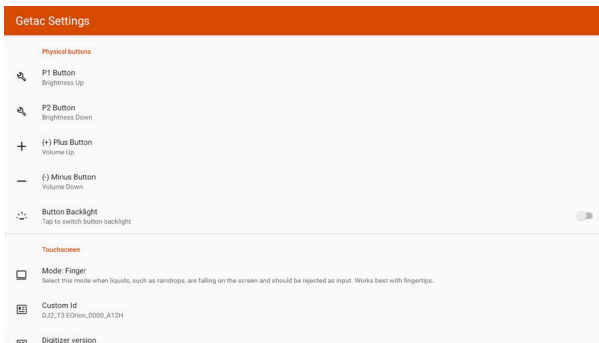

The following table describes the configurable items.

Item	Description
------	-------------

Physical buttons

P1 button	To assign a function or app to a hardware button on your device. Tap a button name and select from the available options.
P2 button	
(+) Plus Button	
(-) Minus Button	
Button Backlight	To switch the button backlight on or off.

NOTE: For information on the option **Touchscreen On/Off**, see “Mode-Advanced” on the next page.

Global Navigation Satellite System

GNSS receiver	<p>To enable or disable the below systems.</p> <ul style="list-style-type: none"> ● GLONASS ● SBAS <p>To clear all GPS data in memory and restart the GPS positioning, tap Cold start. The on/off switch will turn back to the off position when you exit this setting screen.</p>
---------------	---

Touchscreen

Mode	<p>To select the touchscreen mode. Options are:</p> <ul style="list-style-type: none"> ● Finger: This is the default setting. This mode works best with fingertip. Select this when liquids (such as raindrops) are falling on the screen and should be rejected as input. Use your finger in this mode. ● Stylus: Select this if you are using the stylus. This mode responds to finger touches as well. ● Glove: Select this mode if you are using the touchscreen while wearing thick gloves (referring to warm gloves or work gloves, not referring to touchscreen-capable gloves). In this mode, the touchscreen sensitivity will be enhanced in order to pick up lighter touches. <p>If you want to use only the digitizer pen (select models only) or a connected mouse, you can select Advanced for further setup as described below.</p>
------	--

Item	Description
Mode – Advanced	<p>The touchscreen on/off setting is for the scenario when the digitizer pen or a mouse is present.</p> <ul style="list-style-type: none"> ● On: The Touchscreen mode will be in use, meaning the touchscreen will work in the ordinary way, not excluding any specific input. ● Off: The touchscreen will only accept the digitizer pen or a connected mouse. This setting remains valid until you restart the system. The Touchscreen mode will be on again whenever the device starts up. <hr/> <p>Physical Button (-) Minus Button: Setting this switch to On allows you to use the Minus (-) button on your device for the purpose of turning on/off the Touchscreen mode.</p> <p>NOTE: Another way to assign this function to a hardware button is through the “Physical buttons” setting (the first setting category in Getac Settings). In this way, you can specify the function to any of the four buttons.</p>

Barcode

Turn off barcode scanner	<p>To set an inactivity timeout after which the barcode scanner turns off its power. The barcode scanner will turn on again when next accessed. If you want to keep the barcode scanner always on, select Never.</p>
Barcode beeper	<p>To enable or disable the beep sound upon a successful barcode scan.</p>
Symbologies	<p>To enable or disable the detection of symbologies. In the popup window, tap the checkbox of each target item to enable or disable it. A check mark indicates the item is enabled.</p>
OCR	<p>To enable or disable the detection of an OCR font. If you want to scan an OCR font, select the font in the popup window.</p>
Prefix/Suffix Word(s)	<p>To add character(s) before/after each decoded data string. Besides alphanumeric characters, you can enter character code(s) such as <code>\n</code>, <code>\t</code>, <code>\b</code>, and <code>\r</code>. Enter the character(s) in the input field, and tap OK.</p>

Item	Description
Dock	
Audio	<p>To specify which audio output to use when docked.</p> <ul style="list-style-type: none"> ● Aux output: The sound will be output to the speakers connected to the device’s combo audio connector. ● HDMI: The sound will be output to the HDMI display if an HDMI display is connected to the dock. <p>NOTE: To use the HDMI display as the audio output, make sure your HDMI display has speakers.</p>
Lid closing detection	<p>To enable lid closing detection when the Keyboard Dock is attached. If enabled, the system (while powered on) will enter Suspend mode after you close the “ZX10 and Keyboard Dock” set.</p>
Battery	
Information	<p>To display battery-related information.</p>
Charging mode	<p>To select the charging mode. Options are:</p> <ul style="list-style-type: none"> ● Standard mode: The battery will be fully charged. ● Balanced mode: This mode helps prolong battery life by charging only up to 80% of its total capacity. It is highly recommended if you are using AC power most of the time. ● Temperature protection mode: The battery will be charged to a certain capacity according to the ambient temperature. Select this mode if the device is operating on battery power for long periods of time in a high temperature environment.
WWAN	
Select slot	<p>To select the SIM (SIM or eSIM) you want to use. When changing the selection, you will be asked to restart the device.</p>
eSIM provision	<p>To perform eSIM provisioning if eSIM is selected in the previous item.</p>

Item	Description
	Tap the plus button. Enter the required data in the popup window; or, you can scan a QR code for the purpose. The data or QR code is provided by your mobile carrier or service provider.
Assist	
Getac Input method	To determine if the floating buttons of the virtual keyboard display on the screen. The floating button works as a shortcut to switch between Gboard and GetacIME.
Device	
Antenna	To specify which antenna(s) to enable for Device or Dock mode. "Device mode" means the antenna(s) is connected directly to the device. "Dock mode" means the device is docked. GPS, WLAN, and WWAN antennas can be enabled individually in each mode.
Device performance	To enable or disable the CPU boost feature. You may want to boost CPU performance for heavy-duty applications. NOTE: Enabling this feature may increase power consumption.
This device will automatically start up when plugged into a power source.	To determine if the device will automatically start up when connected to external power.
User data erase	To perform data erase in one of the following ways. <ul style="list-style-type: none"> ● Quick erase: This erases all data on the storage and returns the device to its factory reset state. ● Secure erase: This permanently erases all data on the storage and returns the device to its original state. The action takes longer and data cannot be recovered afterwards.

Besides configuring settings for specific components, you can also view device information in Getac Settings, such as sensor status, certain hardware and firmware information, etc.

Chapter 6

Care and Maintenance

This chapter provides various care and maintenance information.

Restart or Hard Reboot

Restart

To restart the device, press and hold the power button until a menu pops up. Then tap **Restart**.

If the device somehow cannot display the power off menu, you can force the device to power off by pressing and holding the power button for more than 8 seconds. Then start up the device by pressing and holding the power button for at least 3 seconds.

Hard Reboot

In case the device is completely unresponsive, you can perform a hard reboot to solve the problem. Press and hold the power button for at least 12 seconds. The device will power off. Start up the device by pressing and holding the power button for at least 3 seconds.

NOTE: Hard reboot can be performed when the power is either on or off.

Update Center

Use **Update Center** to check and update the OS (Operating System) and Getac apps. You can have the updates downloaded automatically or download them manually.

To open the app, tap the **Update Center** app icon  , which can be found in the Getac folder and the All Apps screen. When opening the app for the very first time, you will be asked to allow the installation. Tap the on/off switch to turn it on and then tap ← to continue.

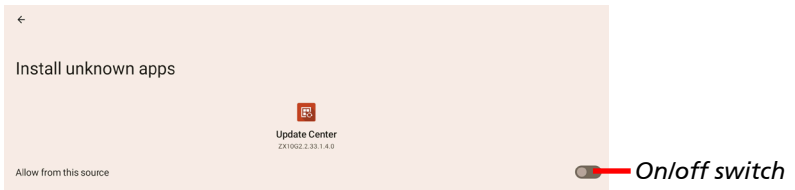

NOTE:

- If your device is not connected to the Internet, you will be prompted to connect.
- To avoid interruptions or failures during updating, have your device connected to external power (recommended) and do not shut down the device.

Updating the OS

After opening Update Center, tap **OS image**. The information you see depends on the current status of your device.

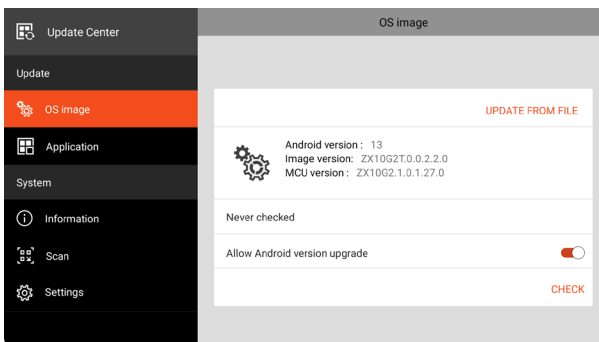

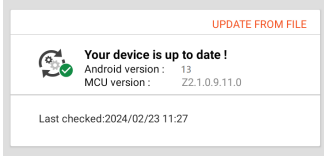

You will see this screen if the OS is up to date.

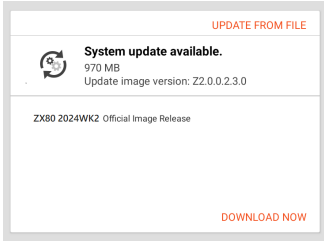

You will see this screen if an update is found available at the server.

Tap **DOWNLOAD NOW**. After the download is completed, a window pops up to inform you. Tap **UPDATE** in the popup window.

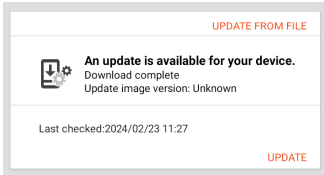

You will see this screen if you did not perform the update after an update has been downloaded.

Tap **UPDATE**.

NOTE: Alternatively, you can update the OS using a file you have obtained. Tap **UPDATE FROM FILE** and select the location where the file is stored.

When the update is completed, you will be prompted to restart the device.

Android Version Upgrade



If this switch is set to **On**, you can upgrade your device to a newer Android version when it is available.

If set to **Off**, your device will receive updates for the current Android version only.

Updating Getac Apps

After opening Update Center, tap **Application**. The information you see depends on the current status of your device.

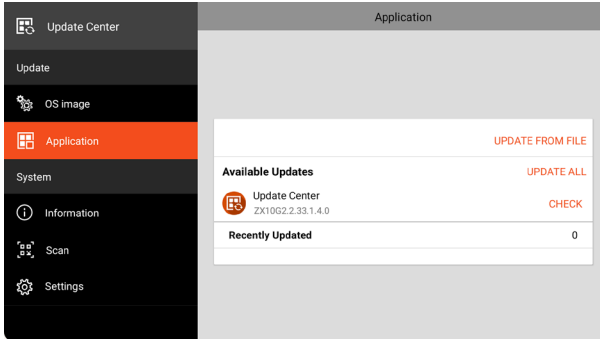

If an update is found available after a check (either manually or automatically), you will see the **UPDATE** button for the app.

Tap **UPDATE** to update the individual app one by one. Or tap **UPDATE ALL** to update all at one time.

NOTE: Alternatively, you can update the app using a file you have obtained. Tap **UPDATE FROM FILE** and select the location where the file is stored.

Update Center Settings

While in Update Center, tap **Settings** to enable/disable notifications and automatic download.

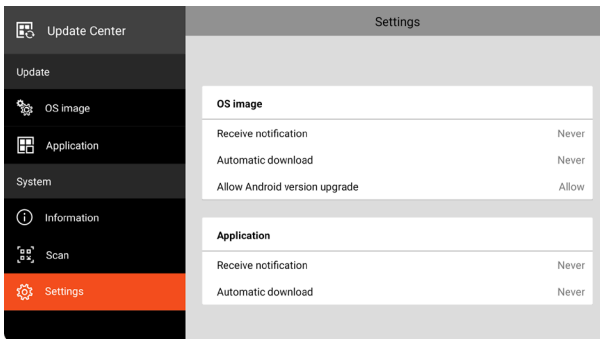

Item	Description
Receive notification	<p>To determine if you will receive the notification of an OS or Getac app update.</p> <ul style="list-style-type: none"> • Never: You will not be notified. • Major updates only: You will be notified only if the update is a major one. • All updates: You will be notified of any available update. <p>You can tap the notification in the Notifications Panel to act on the notification.</p>
Automatic download	<p>To determine how automatic download works.</p> <ul style="list-style-type: none"> • Never: Automatic download is disabled. • When Wi-Fi is available: Whenever the device is connected to Wi-Fi, the device tries to check for updates and download if there is any. • Always: Whenever there is an update, downloading will always be performed. Note that this will affect the mobile data usage for models supporting mobile networks.
Allow Android version upgrade	<p>To determine if your device will be upgraded to a newer Android version when it is available.</p> <ul style="list-style-type: none"> • Allow: A version upgrade can be performed. • Disallow: Your device will receive updates for the current Android version only. You will not be notified of a new Android version.

Update Center Scan

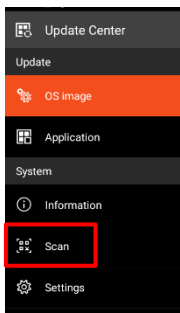

The "Scan" feature is available for specific customers only. With a QR code provided by Getac, updates can be performed by scanning the QR code.

Caring for Your Device

Taking good care of your device will ensure trouble-free operation and reduce the risk of damage to your device.

- Keep your device away from excessive moisture and extreme temperatures.
- Avoid exposing your device to direct sunlight or strong ultraviolet light for extended periods of time.
- Do not place anything on top of your device or drop objects on your device.
- Do not drop your device or subject it to severe shock.
- Do not subject your device to sudden and severe temperature changes. This could cause moisture condensation inside the unit, which could damage your device. In the event of moisture condensation, allow your device to dry out completely before use.
- To avoid damaging the screen, do not tap it with any sharp object.
- Never clean your device with its power on. Use a soft, lint-free cloth to wipe the screen and the exterior of your device.
- Do not use paper towels to clean the screen.
- Never attempt to disassemble, repair or make any modifications to your device. Disassembly, modification or any attempt at repair could cause damage to your device and even bodily injury or property damage and will void the warranty.
- Do not store or carry flammable liquids, gases or explosive materials in the same compartment as your device, its parts or accessories.

Appendix A

Specifications

NOTE: Specifications are subject to change without any prior notice.

Parts		Specifications
CPU		Qualcomm® QCS 6490, Octa-core, 1.95 GHz, maximum 2.7 GHz, 2 MB cache
Video	Controller	UMA, Qualcomm® Adreno™ GPU 643
	Display Panel	10.1-inch (16:10) TFT LCD, WUXGA 1920 x 1200, sunlight readable, 1000 nits standard brightness, protection film
Touchscreen		Capacitive multi-touch screen – 10 points Optional: dual mode display
Audio	Controller	Qualcomm® SoundWire
	Speaker	Integrated x 2
	Microphone	Integrated x 2
Memory		8 GB LPDDR5
Storage		128/256 GB
I/O ports		USB 2.0 Type-A, USB 3.2 Gen 1 Type-C, combo audio (4-pole TRRS 3.5mm type), Docking, tri antenna passthrough (optional), microSD
Wireless LAN + Bluetooth		Wi-Fi 802.11 a/b/g/n/ac/ax + Bluetooth 5.2 combo
WWAN (optional)		4G LTE or 5G, nano-SIM and eSIM
GNSS (optional)		Discrete
Barcode scanner (optional)		1D and 2D
NFC reader/writer (optional)		Protocols supported: ISO 15693, ISO 14443 A/B, MIFARE, ISO 15693, ISO18000, and FeliCa™/Emulation
Camera (optional)		Front: CMOS, 8 MP Rear: CMOS, 16 MP, autofocus, flash light, video capture

Parts		Specifications
Battery pack		Standard: Lithium-ion Polymer type, 1 cell, 3.88 V, typical 4990 mAh, minimum 4870 mAh
		High capacity: Lithium-ion Polymer type, 2 cells, 3.88 V, typical 9980 mAh, minimum 9470 mAh
Dimension		275 x 192 x 17.9 mm (10.8 x 7.56 x 0.7 inches) (standard models)
Weight		Models with one battery pack: ≥ 906 g (1.99 lb)
		Models with two battery packs: ≥ 982 g (2.16 lb)
Environmental	Temperature*	Operating: -29 °C to 63 °C (-20 °F to 145 °F) Storage: -51 °C to 71 °C (-60 °F to 160 °F)
	Humidity	95% relative humidity, non-condensing
	Drop**	1.8 m (6 ft) drop resistant

Table Notes:

* When using the device with AC power, a low temperature down to -29 °C (-20 °F) and the temperature range for MIL-STD-810 are supported. When using the device with only battery power in a temperature down to -21 °C (-6 °F) (for standard battery packs) or -29 °C (-20 °F) (for high-capacity battery packs), it is advised that the system be booted in a warm environment, if possible, before being taken into an extreme cold environment for work.

** Drop test results vary with different device configurations and also vary if optional accessories are attached.

Appendix B

Regulatory Information

This appendix provides regulatory statements and safety notices on your device.

NOTE: Marking labels located on the exterior of your device indicate the regulations that your model complies with. Please check the marking labels on your device and refer to the corresponding statements in this chapter. Some notices apply to specific models only.

Safety Precautions

- Prolonged listening of music in maximum volume can damage the ears.

About Charging

- Use only an appropriate charger for your device. Use of an incorrect type will result in malfunction and/or danger. You can purchase the charger (or called power adapter) from Getac.
- Use a specified cradle approved by the manufacturer.

About the Charger

- If a ground/earth pin attachment plug on the AC power cord is provided, always plug the cord into a grounded/earthed outlet. Do not disable ground/earth pin of the plug/cord.
- Do not use the charger in a high moisture environment. Never touch the charger when your hands or feet are wet.

- Allow adequate ventilation around the charger when using it to operate the device or charge the battery. Do not cover the charger with paper or other objects that will reduce cooling. Do not use the charger while it is inside a carrying case.
- Connect the charger to a proper power source. The voltage and grounding requirements are found on the product case and/or packaging.
- Do not use the charger if the cord becomes damaged.
- Do not attempt to service the unit. There are no serviceable parts inside. Replace the unit if it is damaged or exposed to excess moisture.

About the Battery

Risk of explosion if battery is replaced by an incorrect type. Dispose of used batteries according to the instructions.

If the battery is mishandled, it may cause fire, smoke or an explosion and the battery's functionality will be seriously damaged. The safety instructions listed below must be followed.

Danger

- Do not charge/discharge or place the battery in high-temperature (more than 80 °C / 176 °F) locations, such as near a fire, heater, in a car in direct sunlight, etc.
- Do not use unauthorized chargers.
- Do not force a reverse-charge or a reverse-connection.
- Keep the system and battery away from an extremely low air pressure environment as it may result in an explosion or the leakage of flammable liquid or gas.

Warning

- Keep the battery away from infants.
- Stop using the battery if there are noticeable abnormalities such as abnormal smell, heat, deformities, or discoloration.
- Stop charging if the charging process cannot be finished.
- In case of a leaking battery, keep the battery away from flames and do not touch it.

Caution

- Do not use the battery where static electricity (more than 100V) exists that might damage the protection circuit of the battery.
- When children are using the system, parents or adults must ensure that they are using the system and battery correctly.
- Keep the battery away from flammable materials during charging and discharging.

Heat Related Concerns

Your device may become very warm during normal use. It complies with the user-accessible surface temperature limits defined by the International Standards for Safety. Still, sustained contact with warm surfaces for long periods of time may cause discomfort or injury. To reduce potential heat-related concerns, follow these guidelines:

- Keep your device and its power adapter in a well-ventilated area when in use or charging. Allow for adequate air circulation under and around the device.
- Use common sense to avoid situations where your skin is in contact with your device or its power adapter when it's operating or connected to a power source. For example, don't sleep with your device or its power adapter, or place it under a blanket or pillow, and avoid contact between your body and your device when the power adapter is connected to a power source. Take special care if you have a physical condition that affects your ability to detect heat against the body.
- If your device is used for long periods, its surface can become very warm. While the temperature may not feel hot to the touch, if you maintain physical contact with the device for a long time, for example if you rest the device on your lap, your skin might suffer a low-heat injury.
- If your device is on your lap and gets uncomfortably warm, remove it from your lap and place it on a stable work surface.
- Never place your device or power adapter on furniture or any other surface that might be marred by exposure to heat since the base of your device and the surface of the power adapter may increase in temperature during normal use.

North America

USA



Company name	Getac Inc.
Address	15495 Sand Canyon Rd., Suite 350 Irvine, CA 92618 USA
Phone	+1-949-681-2900

Federal Communications Commission Radio Frequency Interference Statement

NOTE:

This equipment has been tested and found to comply with the limits for a Class B digital device pursuant to Part 15 of the FCC Rules. These limits are designed to provide reasonable protection against harmful interference in a residential installation. This equipment generates, uses, and can radiate radio frequency energy and, if not installed and used in accordance with the instructions, may cause harmful interference to radio communications. However, there is no guarantee that interference will not occur in a particular installation. If this equipment does cause harmful interference to radio or television reception, which can be determined by turning the equipment off and on, the user is encouraged to try to correct the interference by one or more of the following measures:

- Reorient or relocate the receiving antenna.
- Increase the separation between the equipment and receiver.
- Connect the equipment into an outlet on a circuit different from that to which the receiver is connected.
- Consult the dealer or an experienced radio/TV technician for help.

Any changes or modifications not expressly approved by the manufacturer could void the user's authority to operate the equipment.

Please note:

The use of a non-shielded interface cable with this equipment is prohibited.

This device complies with Part 15 of the FCC Rules. Operation is subject to the following two conditions:

- (1) This device may not cause harmful interference.
- (2) This device must accept any interference received, including interference that may cause undesired operation.

ANSI Warning

Equipment approved for ANSI/UL121201 and CSA C22.2 No. 213, Nonincendive Electrical Equipment for use in Class I, Division 2, Group A, B, C, and D.
Ambient temperature: -29°C to 60°C

EXPLOSION HAZARD WARNINGS:

- External connections/hubs through the connectors as mentioned (combo audio connector, USB 3.2 Gen 1 Type-C connector, USB 2.0 connector, DC-in jack, docking connector, and tri antenna passthrough connector) are **NOT** to be used in a hazardous location. When used with a docking station (such as the office dock, keyboard dock, or vehicle dock), the docking/undocking of the equipment must be conducted outside the hazardous area. Docking/undocking in a hazardous area is prohibited.
- The tablet is to be only powered from the battery pack while in hazardous locations. Power adapter is **NOT** certified to use in hazardous locations and **NOT** to be used in hazardous locations.
- The battery must only be changed in an area known to be non-hazardous.
- **DO NOT** disconnect equipment unless power has been switched off or the area is known to be non-hazardous.
- **DO NOT** remove or replace a user-removable item (such as the battery pack, SIM card, memory card, smart card, etc.) while the circuit is live unless the area is free of ignitable concentrations.
- Replace the battery with battery model BP1S1P4990B-1 or BP1S2P4990B-1, manufactured by Getac Technology Corporation only. Use of another battery may present a risk of fire or explosion.

California Proposition 65

For California USA:

Proposition 65, a California law, requires warnings to be provided to California consumers when they might be exposed to chemical(s) identified by Proposition 65 as causing cancer and birth defects or other reproductive harm.

Almost all electronic products contain 1 or more of the chemicals listed under Proposition 65. This does not mean the products pose a significant risk of exposure. As the consumers have the right to know about the products they purchase, we are giving this warning on our packaging and user manual to keep our consumers well informed.

 **WARNING**

This product can expose you to chemicals including lead, TBBPA or formaldehyde, which are known to the State of California to cause cancer and birth defects or other reproductive harm. For more information go to www.P65Warnings.ca.gov

Canada

Canadian ICES-003

CAN ICES-3(B)/NMB-3(B)

This device contains licence-exempt transmitter(s)/receiver(s) that comply with Innovation, Science and Economic Development Canada's licence-exempt RSS(s). Operation is subject to the following two conditions: (1) This device may not cause interference. (2) This device must accept any interference, including interference that may cause undesired operation of the device.

L'émetteur/récepteur exempt de licence contenu dans le présent appareil est conforme aux CNR d'Innovation, Sciences et Développement économique Canada applicables aux appareils radio exempts de licence. L'exploitation est autorisée aux deux conditions suivantes : 1) L'appareil ne doit pas produire de brouillage; 2) L'appareil doit accepter tout brouillage radioélectrique subi, même si le brouillage est susceptible d'en compromettre le fonctionnement.

The device could automatically discontinue transmission in case of absence of information to transmit, or operational failure. Note that this is not intended to prohibit transmission of control or signaling information or the use of repetitive codes where required by the technology.

L'appareil peut interrompre automatiquement la transmission en cas d'absence d'informations à transmettre ou de panne opérationnelle. Notez que ceci n'est pas destiné à interdire la transmission d'informations de contrôle ou de signalisation ou l'utilisation de codes répétitifs lorsque cela est requis par la technologie.

The device for operation in the band 5150–5250 MHz is only for indoor use to reduce the potential for harmful interference to co-channel mobile satellite systems.

l'appareil fonctionnant dans la bande 5150-5250 MHz est réservé à une utilisation en intérieur afin de réduire les risques de brouillage préjudiciable pour les systèmes mobiles par satellite dans le même canal.

User Notification of Take-back Service

To customers in United States and Canada:

Getac believes in providing our customers with easy-to-use solutions to recycle your Getac-brand products for free. Getac understands the customers will likely be recycling multiple items at once and as such. Getac wants to make the recycling process for these larger shipments as streamlined as possible. Getac works with recycling vendors with the highest standards for protecting our environment, ensuring worker safety, and complying with global environmental laws. Our commitment to recycling our old equipment grows out of our work to protect the environment in many ways. For more information, see the Getac Web site at <https://www.getac.com/us/environmental-certifications/>.

Please see the product type below for information on Getac product, battery and packaging recycling in USA and Canada.

- **For Product Recycling:**

If you have a Getac produce that needs to go to a recycling house, Getac can help you. Just contact us at (866) 394 – 3822 or by email at **GUSA.RecycleProgram@getac.com** to obtain a prepaid shipping label at no charge to you, pack up your equipment in a box of your choice and send it off.

- **For Battery Recycling:**

The batteries used to power your portable Getac products contain hazardous materials. While they pose no risk to you during normal use, they should never be disposed with other wastes. Getac provides a free take-back service for recycling your batteries from Getac products. To recycle the battery, please contact us at (866) 394 – 3822 or by email at **GUSA.RecycleProgram@getac.com**.

- **For Packaging Recycling:**

Getac has chosen the packaging materials used to transport our products carefully, to balance the requirements of shipping the product to you safely while minimizing the amount of material used. Our packaging for notebooks and tablets is recyclable and manufactured using elemental chlorine-free processes. They contain 90 percent (by weight) recycled content. Your packaging materials can be recycled at your local recycling center. Or, if you would like Getac to recycle your packaging, please contact us at (866) 394 – 3822 and we will make arrangements for you.

If you have the above for recycling, please visit our website

<https://www.getac.com/us/environmental-certifications/>

Europe Marking and Compliance Notices



Company name	Getac Technology GmbH.
Address	Kanzlerstrasse 4 40472 Dusseldorf, Germany
Phone	+49 (0) 211-984819-0



Company name	Getac UK Ltd.
Address	Getac House, Stafford Park 12, Telford, Shropshire, TF3 3BJ, UK
Phone	+44 (0) 1952-207-222

Statements of Compliance

English

Getac hereby declares that this product complies with the EU Directive 2014/53/EU. The full text of the EU declaration of conformity is available at: <https://support.getac.com/Portal/Page/809>

Deutsch

Getac erklärt hiermit, dass Gerät mit den grundlegenden Anforderungen und anderen relevanten Bestimmungen der Richtlinie 2014/53/EU übereinstimmt. Der gesamte Text der EU Konformitätserklärung ist verfügbar unter: <https://support.getac.com/Portal/Page/846>

Español

Por la presente, Getac declara que el producto cumple con la Directiva de la UE 2014/53/UE. El texto completo de la declaración UE de conformidad se encuentra a continuación. <https://support.getac.com/Portal/Page/866>

Français

Getac déclare par la présente que cet appareil est conforme aux critères essentiels et autres clauses pertinentes de la directive 2014/53/EU. La déclaration de conformité de l'UE peut être téléchargée à partir du site internet suivant : <https://support.getac.com/Portal/Page/879>

Italiano

Getac con la presente dichiara che questo dispositivo è conforme ai requisiti essenziali e alle altre disposizioni pertinenti con la direttiva 2014/53/EU. Il testo completo della dichiarazione di conformità UE è disponibile all'indirizzo: <https://support.getac.com/Portal/Page/892>

Notices

Max power:

WLAN 2.4G: 19.89 dBm

WLAN 5G: 21.24 dBm

WLAN 6G: 18.78 dBm

BT: 8.9 dBm

NFC: -42.67 dBuA/m@10m

Digitizer: -45.21 dBuA/m@10m

WWAN LTE: 24 dBm



WWAN 5G-NR: 27 dBm

The device is restricted to indoor use only when operating in the 5150 to 5350 MHz frequency range.

	BE	BG	CZ	DK	DE	EE
	IE	EL	ES	FR	HR	IT
	CY	LV	LT	LU	HU	MT
	NL	AT	PL	PT	RO	SI
	SK	FI	SE	NO	IS	LI
	CH	TR	UK (NI)			

Restriction or Requirement in the UK: 5150 to 5350 MHz indoor-use only.

	UK
--	----

 	Waste Electrical and Electronic Equipment (WEEE) This symbol means that according to local laws and regulations your product shall be disposed of separately from household waste. When this product reaches its end of life, take it to a collection point designated by local authorities. Proper recycling of your product will protect human health and the environment.
--	--



Battery Directive — Information for Users

In the European Union, this label indicates that the batteries in this product should be collected separately and not be disposed of with household waste. Substances in batteries can have a potential impact on health and environment and you have a role in recycling waste batteries thus contributing to the protection, preservation, and improvement of the quality of the environment.

Restriction of Hazardous Substances (RoHS) Directive

EU RoHS

Getac products meet the requirements of Directive 2011/65/EU on the restriction of the use of certain hazardous substances in electrical and electronic equipment. For more information about RoHS, go to:

<https://www.getac.com/us/environment/>

About USB Power Delivery

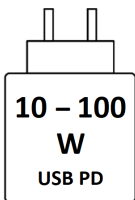

Wattage for charging:

Minimum 10 W
Maximum 100 W

RF Exposure Information (SAR)

This device has been tested and meets applicable limits for Radio Frequency (RF) exposure.

Specific Absorption Rate (SAR) refers to the rate at which the body absorbs RF energy. SAR limits are 1.6 Watts per kilogram (over a volume containing a mass of 1 gram of tissue) in countries that follow the United States FCC limit and 2.0 W/kg (averaged over 10 grams of tissue) in countries that follow the Council of the European Union limit. Tests for SAR are conducted using standard operating positions with the device transmitting at its highest certified power level in all tested frequency bands.

ENERGY STAR



ENERGY STAR® is a government program that offers businesses and consumers energy-efficient solutions, making it easy to save money while protecting the environment for future generations.

Please reference ENERGY STAR® related information from <http://www.energystar.gov>.

As an ENERGY STAR® Partner, Getac Technology Corporation has determined that this product meets the ENERGY STAR® guidelines for energy efficiency.

All Getac products with ENERGY STAR® logo comply with the ENERGY STAR® standard, and the power management feature is enabled by default. Getac's ENERGY STAR® qualified products are listed on the EPA website. <https://www.energystar.gov/products>

NOTE: ZX10 complies with ENERGY STAR® only if it is used with the power adapter supplied by Getac for ZX10.