



Advanced User Guide



Eaton 9PX G2

9PX6KG2-L

9PX8KG2-L

9PX11KG2-L

9PXEBM192RTG2-L

MBP6K208G2

MBP6KIECG2

MBP11K208G2

Table of Content

1	Special symbols.....	4
2	Introduction	5
2.1	Environmental protection.....	5
2.2	Benefits	6
3	Presentation	7
3.1	Weights and dimensions	7
3.2	UPS Rear panel	8
3.3	EBM Rear panel.....	9
3.4	MBP Rear Panels and description.....	9
3.5	Optional accessories	11
4	Installation	12
4.1	Inspecting the equipment.....	12
4.2	Recommended positions	16
4.3	EBM connection	25
4.4	UPS connection	28
4.5	Connection with MBP	33
4.6	Register warranty	44
5	Interfaces and communication	45
5.1	Control panel	45
5.2	LCD description	46
5.3	Display functions	47
5.4	User settings	49
5.5	Communication ports	52
5.6	UPS remote control functions	53
5.7	Eaton Intelligent Power Software suite.....	56
5.8	BMS.....	56
5.9	Cybersecurity	56
6	Operation.....	56
6.1	Start-up and normal operation.....	56
6.2	Starting the UPS on battery	57
6.3	Starting the UPS with HotSwap MBP.....	57

6.4	UPS shutdown	58
6.5	Operating modes	58
6.6	Configuring battery settings	59
6.7	Setting high efficiency mode	59
6.8	Return of AC input power	60
6.9	Battery wiring connection detection	60
6.10	Transportation mode	60
7	UPS maintenance	60
7.1	Equipment care	60
7.2	Storing the equipment	60
7.3	Battery State Of Health (SOH)	61
7.4	When to replace Lithium batteries	61
7.5	Replacing Lithium batteries	62
7.6	Lithium Battery Settings Reset	65
7.7	UPS replacement with HotSwap MBP	65
7.8	UPS maintenance with HotSwap MBP	68
7.9	Recycling the used equipment	68
8	Troubleshooting	70
8.1	Typical alarms and faults	70
8.2	Silencing the alarm	72
8.3	Service and support	72
9	Specification and technical characteristics	72
9.1	UPS Model list	72
9.2	Extended Battery Module model list	73
9.3	Electrical input	73
9.4	Electrical input connections	73
9.5	Electrical output	73
9.6	Electrical output connections	74
9.7	Electrical output Power	74
9.8	Battery	74
9.9	Battery backup time	75
9.10	Environmental and safety	76
10	Glossary	77

1 Special symbols

The following are examples of symbols used on the UPS or accessories to alert you to important information:



DANGER: Dangerous voltage levels are present within the UPS. The UPS has its own internal power source (the battery). Consequently, the power outlets may be energized even if the UPS is disconnected from the AC power source.



CAUTION: Batteries present a risk of energy or electrical shock or burn from high short circuit current. Observe proper precaution. Batteries may contain HIGH VOLTAGE and CORROSIVE, TOXIC and EXPLOSIVE substances.

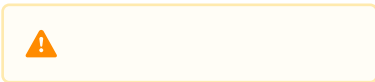

Important instructions that must always be followed.



Information, advice, help.



Read the documentation provided.



Disconnect input plug.



Before maintenance, first shut down the UPS then disconnect the AC power source, internal and external batteries then discharge capacitors by pressing the ON button and wait 5 minutes.



This equipment should only be used in a dry indoor environment.



Operating range of temperature.



Operating range of humidity.



The UPS and their batteries must be kept in a ventilated place.



USB Communication Port



Alternating Current (AC)



Direct Current (DC)

2 Introduction

Thank you for selecting an Eaton 9PX Gen2 product to protect your electrical equipment.

The Eaton 9PX Gen2 range has been designed with the utmost care. We recommend that you take the time to read this advanced user guide to take full advantage of the many features of your UPS (Uninterruptible Power System).

Before installing your Eaton 9PX Gen2 , please read the information and safety instructions provided. Follow the instructions in the quick start guide and if necessary, refer to this advanced user guide.

To discover the entire range of Eaton products, we invite you to visit our web site at eaton.com or contact your Eaton local representative.

WARNING:

- This is a category C2 UPS product. In a residential environment, this product may cause radio interference, in which case the user may be required to take additional measures.
- Disconnection and overcurrent protection devices shall be provided by others for permanently connected AC input (Normal AC/Bypass AC) /output circuits

NOTE: This equipment has been tested and found to comply with the limits for a Class A digital device, pursuant to Part 15 of the FCC Rules. These limits are designed to provide reasonable protection against harmful interference when the equipment is operated in a commercial environment . This equipment generates, uses, and can radiate radio frequency energy and, if not installed and used in accordance with the instruction manual, may cause harmful interference to radio communications. Operation of this equipment in a residential area is likely to cause harmful interference in which case the user will be required to correct the interference at his own expense.

UPS employing batteries with HB case are intended not for use in a computer room as defined in the standard for the Protection of Information Technology Equipment, ANSI/NFPA 75.

Supplier's Declaration of Conformity of Federal Communications Commission Statement

This device complies with Part 15 of the FCC Rules. Operation is subject to the following two conditions:

- (1) this device may not cause harmful interference, and
- (2) this device must accept any interference received, including interference that may cause undesired operation.

For questions regarding this FCC SDoC declaration, contact Eaton Corporation by telephone or through the Internet.

Eaton Corporation Cheryle Chavarria

Regulatory Manager

10000 Woodward Avenue, Woodridge, Illinois 60517, USA

Cherylechavarria@eaton.com

1.773.896.1462

2.1 Environmental protection

Eaton has implemented an environmental-protection policy. Products are developed according to an eco-design approach.

Substances

This product contains no CFC, HCFC or asbestos. This product is compliant with regulations on the restriction of the use of substances in electrical and electronic equipment.

Packaging

To improve waste treatment and facilitate recycling, separate the various packing components. Follow local regulations for the disposal of packing materials.

- Packing materials are recyclable and bear the appropriate identification symbol .
- The cardboard we use comprises over 50% of recycled cardboard.
- Plastic bags are made of polyethylene.

Materials	Abbreviations	Number in the symbols 
Polyethylene terephthalate	PET	01

Materials	Abbreviations	Number in the symbols 
High-density polyethylene	HDPE	02
Polyvinyl chloride	PVC	03
Low-density polyethylene	LDPE	04
Polypropylene	PP	05
Polystyrene	PS	06

End of life

Eaton will process products at the end of their service life in compliance with local regulations. Eaton works with companies in charge of collecting and eliminating our products at the end of their service life.

Product

The product is made from materials that can be recycled. Dismantling and destruction must take place in compliance with all local regulations concerning waste. At the end of its service life, the product must be transported to a processing center for electrical and electronic waste. eaton.com/recycling

Battery

The product contains lithium batteries that must be processed according to applicable local regulations concerning batteries. The battery may be removed to comply with regulations and in view of correct disposal.

2.2 Benefits

The Eaton 9PX Gen2 uninterruptible power system (UPS) protects your sensitive electronic equipment from the most common power problems, including power outages, voltage sags, impulsive transients, line noise, and long-term under and over voltage conditions, frequency variations, switching transients, and harmonic distortion.

Power outages can occur when you least expect it, and power quality can be erratic. These power problems have the potential to corrupt critical data, destroy unsaved work sessions, and damage hardware - causing hours of lost productivity and expensive repairs.

With the Eaton 9PX Gen2, you can safely eliminate the effects of power disturbances and guard the integrity of your equipment. Providing outstanding performance and reliability, Eaton 9PX Gen2's unique benefits include:

- Backed by worldwide agency approvals.
- Remote firmware upgrade capability.
- Serial RS-232 communication by USB or DB9 port.
- Relay output contacts.
- Optional connectivity cards with enhanced communication capabilities.
- Extended runtime with up to ten Extended Battery Modules
- Constant mode battery charger with a integrated battery management system (BMS) for temperature regulation and life cycle monitoring.
- True online double-conversion technology with high power density, utility frequency independence, and generator compatibility.
- Remote power off (RPO).
- Remote on/off (ROO).
- Implementing Lithium battery to reduce maintenance cost.

3 Presentation

3.1 Weights and dimensions

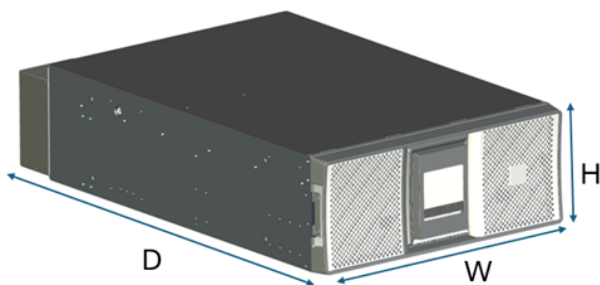

Description	Type	Weights (lb / kg)	Dimensions (inch / mm) D x W x H
9PX6KG2-L	UPS	77.6 / 35.2	26.9x17.3x5.1 / 684x440x130
9PX8KG2-L 9PX11KG2-L	UPS	132.3 / 60	28.5x17.3x6.9 / 724x440x174
9PXEBM192RTG2-L	EBM	77.2 / 35	24.9x17.2x3.6 / 633x438x85.3
MBP6K208G2	MBP	6.6 / 3.0	4.9x7.0x5.1 / 125x177x130
MBP6KIECG2	MBP	5.3 / 2.4	4.9x5.1x9.4 / 125x130x239
MBP11K208G2	MBP	10.1 / 4.6	11.2x5.1x5.1 / 285x130x130

3.2 UPS Rear panel

9PX6KG2-L

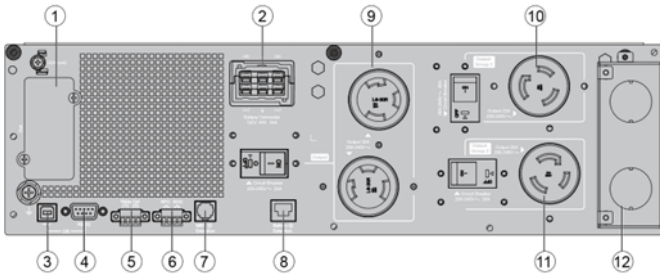

9PX8KG2-L ; 9PX11KG2-L

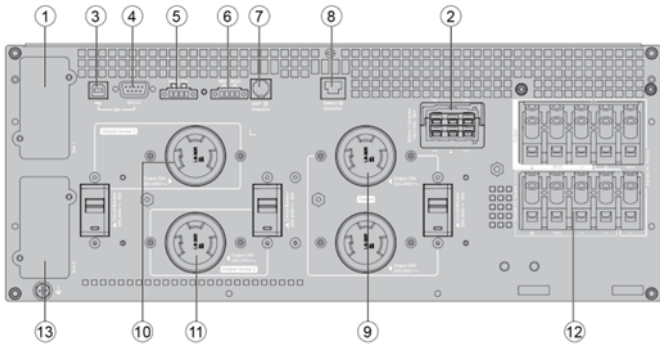

- ① Network Management Card
- ② Battery connector
- ③ USB communication port
- ④ RS232 communication port
- ⑤ Relay output contact
- ⑥ Connectors for ROO (Remote On/Off) and RPO (Remote Power Off) control
- ⑦ Connector for HotSwap MBP detection
- ⑧ Connectors for automatic recognition of an additional battery module
- ⑨ Primary group: outlets for connection of critical equipment
- ⑩ Group 1: programmable outlets for connection of equipment
- ⑪ Group 2: programmable outlets for connection of equipment
- ⑫ Input/Output terminal blocks (6000VA equipped with power cord)
- ⑬ Slot for optional communication card (8000VA and 11000VA only)

3.3 EBM Rear panel

9PXEBM192RTG2-L

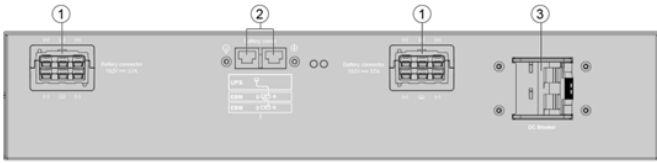

- ① Connectors for battery modules (to the UPS or to the other battery modules).
- ② Connectors for automatic recognition of battery modules
- ③ Circuit Breaker

3.4 MBP Rear Panels and description

The HotSwap MBP has a manual Bypass rotary switch with two positions:

- **UPS** => the load is supplied by the UPS
- **Bypass** => the load is supplied directly by the AC power source

2 lights indicate the Hotswap MBP power status:

- **"UPS supply"** green light: when active, the UPS output is available, the Bypass switch can be safely turned to UPS position
- **"Bypass mode"** red light: when active, indicates that the Hotswap MBP is on "Bypass mode" (Bypass switch turned to Bypass position)

Normal AC source switch:

Allow to safely switch off the AC source of the UPS, for UPS maintenance / replacing

MBP status detection:

A signal cable, with RJ11 connector to plug to the UPS, allows the communication to the UPS to manage the MBP status, and the indication on UPS display panel of both following status:

- MBP connection to UPS
- Bypass switch position

MBP6K208G2

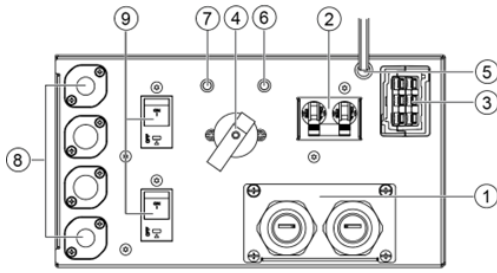

- ① Input/Output terminal blocks
- ② Normal AC source switch
- ③ Input/Output connector to UPS
- ④ Manual Bypass switch
- ⑤ MBP-Detection connector to the UPS
- ⑥ "Bypass" mode red light
- ⑦ UPS supply green light

MBP6KIECG2

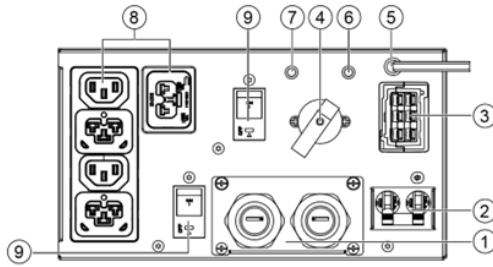

- ⑧ Sockets:
 MBP6K208G2: 2 x L6-20P + 2 x L6-30P
 MBP6KIECG2: 1 x C39 + 1 gang of 2 x C39 & 2x C13
 MBP11K208G2: 4 x L6-30P
- ⑨ Breakers:
 MBP6K208G2: 2 x 20A
 MBP6KIECG2: 2 x 20A
 MBP11K208G2: 4 x 30A

MBP11K208G2

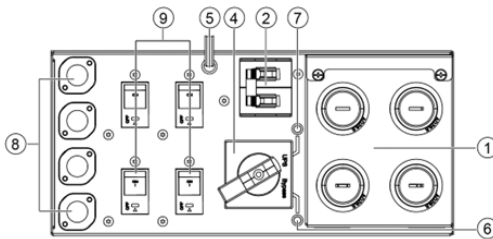

3.5 Optional accessories

Catalog Nb	Description	Compatible with
Network-M3 (Network-M2 - Phased out)	Gigabit Network Card M3 (SNMP v1/v3; IP v4/v6, Ethernet 10/100/1000BaseT)	all
INDGW-M3 (INDGW-M2 - Phased out)	Eaton Industrial Gateway Card (Modbus TCP / RTU)	all
Relay-MS	Eaton Relay card (RS232 or 5x Relay output)	all
INDRELAY-MS	Eaton Industrial relay card (5x relay outputs with dry contacts for remote alarm information)	all
EMPDT1H1C2	Environmental Monitoring Probe Gen2 (temperature, humidity and two dry-contact status data points)	Network-M3 (Network-M2) INDGW-M3
9RK	Rail kit 9PX/SX - 4 Post	All
BINTSYS	Battery Integration System	All
RK2PC	2 Post Rail Kit	All
9PX6KLC-10	Eaton 9PX L6-30 Line Cord 10ft	9PX6KG2-L
MBP6K208G2	Eaton 9PX 6K Maintenance bypass G2	9PX6KG2-L
MBP6KIECG2	Eaton 9PX 6K IEC Maintenance bypass G2	9PX6KG2-L
MBP11K208G2	Eaton 9PX 11K Maintenance bypass G2	9PX8KG2-L, 9PX11KG2-L
9PXTFMR5G2	Eaton 9PX Stepdown Transformer 5kW G2	All
9PXTFMR11G2	Eaton 9PX Stepdown Transformer 10kW G2	9PX8KG2-L, 9PX11KG2-L
9PXPPDM1G2	Eaton 9PX PPDM1 G2	9PX6KG2-L
9PXPPDM2G2	Eaton 9PX PPDM2 G2	9PX6KG2-L
EBMCBL192RT-L	Eaton 9PX G2 192V Standard EBM Cable (2m cable)	All
9PXEBM192RTG2-L	Eaton 9PX Li-Ion EBM 192V RT2U G2	All

4 Installation

Installation must be performed by authorized service personnel only.

4.1 Inspecting the equipment

If any equipment has been damaged during shipment, keep the shipping cartons and packing materials for the carrier or place of purchase and file a claim for shipping damage. If you discover damage after acceptance, file a claim for concealed damage.

To file a claim for shipping damage or concealed damage:

1. File with the carrier within 15 days of receipt of the equipment
2. Send a copy of the damage claim within 15 days to your service representative

i Check the battery recharge date on the shipping carton label. If the date has passed and the batteries were never recharged, do not use the UPS. Contact your local service representative.

UPS package content

Verify that the following additional items are included with the UPS:

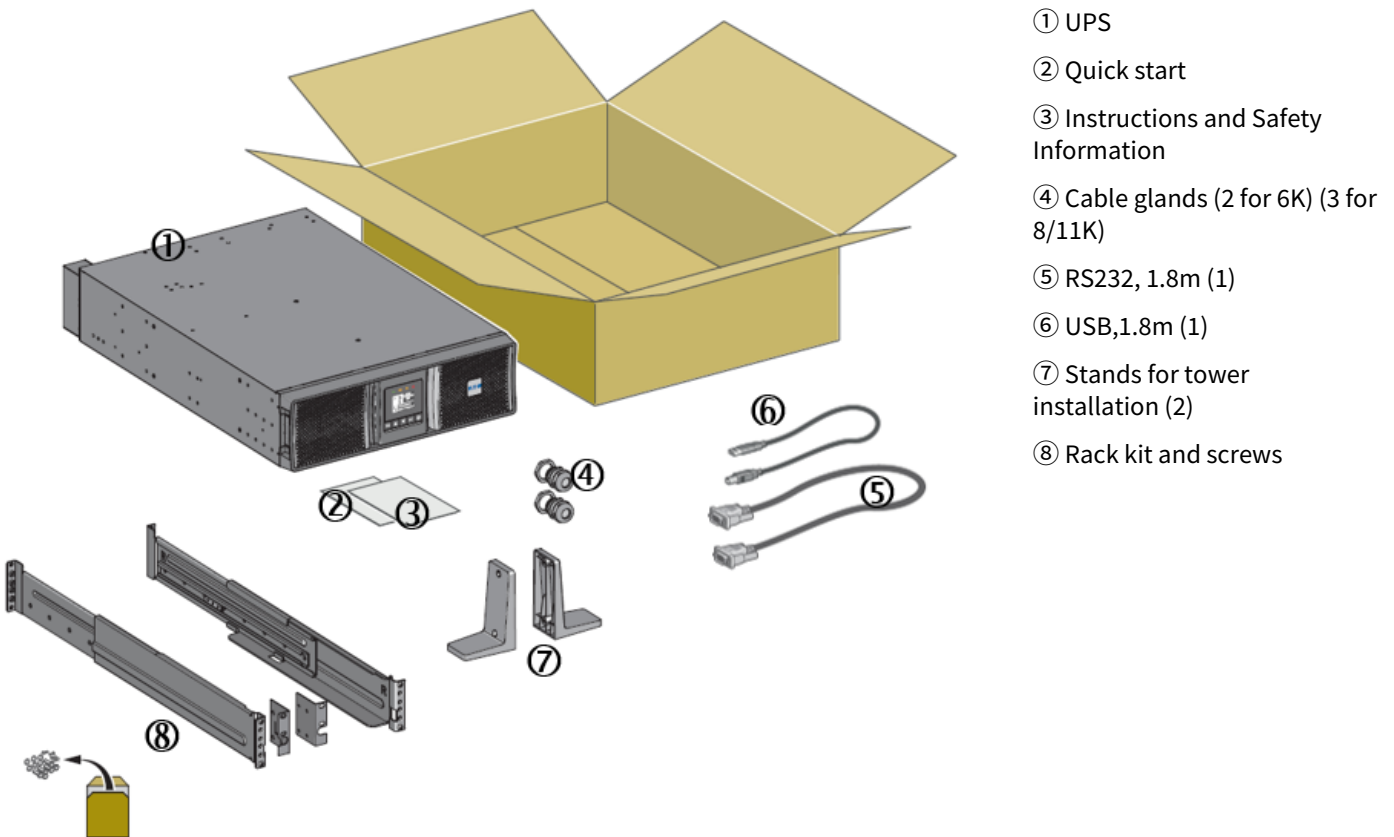

- ① UPS
- ② Quick start
- ③ Instructions and Safety Information
- ④ Cable glands (2 for 6K) (3 for 8/11K)
- ⑤ RS232, 1.8m (1)
- ⑥ USB, 1.8m (1)
- ⑦ Stands for tower installation (2)
- ⑧ Rack kit and screws

Unpacking the UPS

Unpacking without removing the batteries

The UPS is wrapped in a paper tray lifting system. It is prevented from slipping by the cardboard (blue circles) pasted on the paper tray. The UPS can be lifted by two people using the 2 “handles” per side (red circles).

Take care to carry the product horizontally.

i The UPS is heavy, wear appropriate safety equipment.

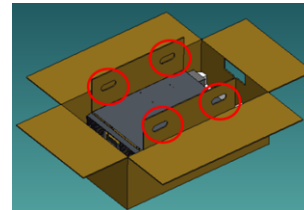
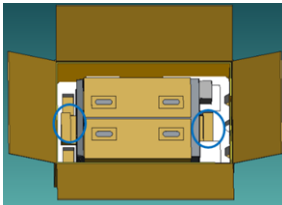

Removing the batteries before unpacking

The carton box is designed to give access to front panel without removing the UPS from the carton. Follow the steps below to get access to front panel and to remove the battery packs

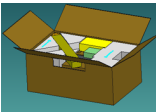
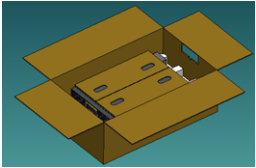
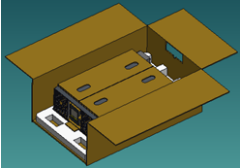
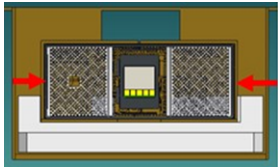
1. Open the carton box	2. Remove the rail kit and foam top of the product	3. Remove the cardboard board inside the carton, use knife to remove the carton cover front of the product	4. Remove the front panel and battery pack in the product.
			

After having removed the battery pack, the product frame could be handled out by one person:

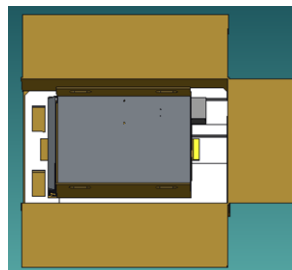

EBM package content

If you ordered an optional Extended Battery Module (EBM), verify that the following additional items are included with the EBM:

EBM 192V Lithium G2

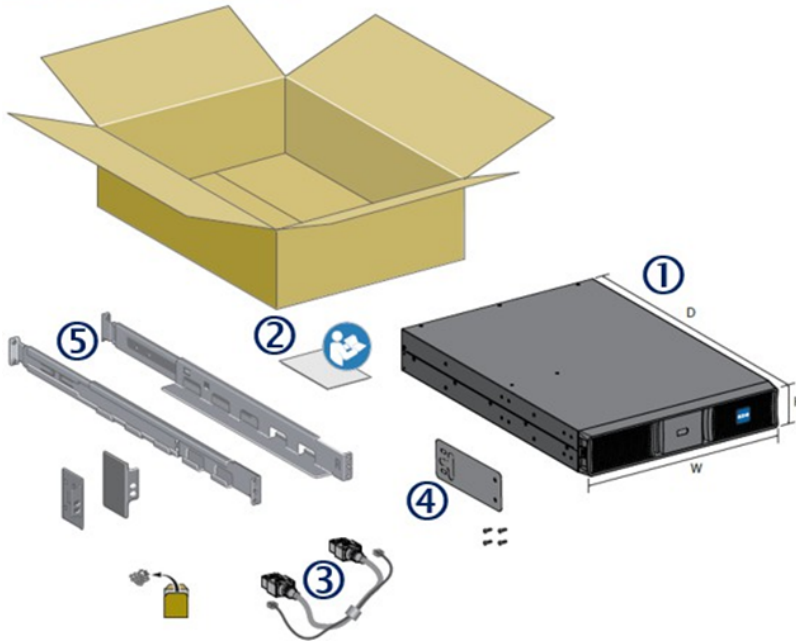

- ① EBM 192V Lithium
- ② Quick start
- ③ Battery power cable, attached with battery detection cable
- ④ Stabilizer bracket (4 screws included)
- ⑤ Rack kit and screws

MBP package content

If you ordered an optional Maintenance ByPass (MBP), verify that the following additional items are included with the MBP:

MBP6K208G2 / MBP6KIECG2

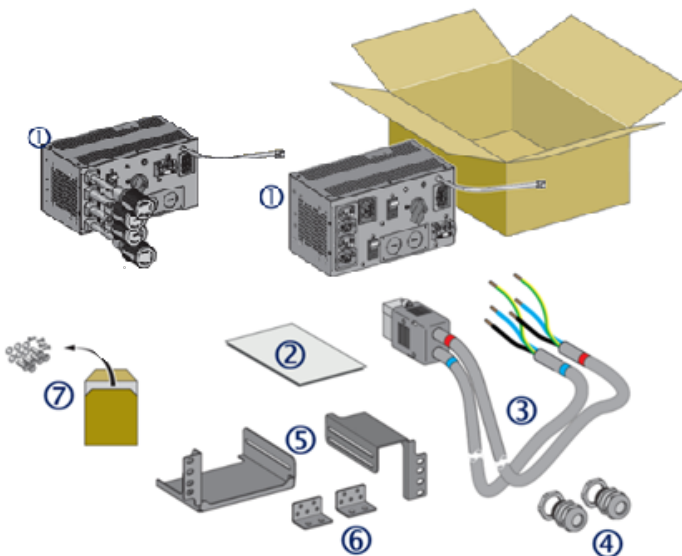

- ① MBP
- ② Quick start
- ③ MBP Cord set (For 6k MBP only)
- ④ Cable glands
- ⑤ Ears for rack mounting
- ⑥ MBP fixation ears
- ⑦ Kraft envelop with screws
- ⑧(2) conduits with internal wires for UPS Input/Output connection (for 11k MBP only)

MBP11K208G2

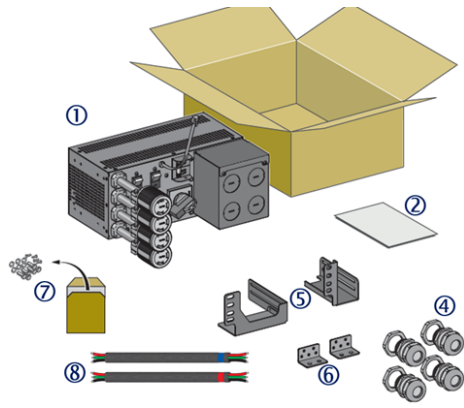

4.2 Recommended positions

Installation in tower position

 If you ordered other UPS accessories, refer to specific user manuals to check the tower installation with the UPS.

To install the UPS:

- Place the UPS on a flat, stable surface in its final location.
- Always keep 6" or 150 mm of free space behind the UPS rear panel 6" or for ventilation.
- If installing additional cabinets, place them next to the UPS in their final location.

Before installing the UPS in tower position, you can rotate the LCD. Follow steps to adjust the orientation of the LCD panel and of the logo.

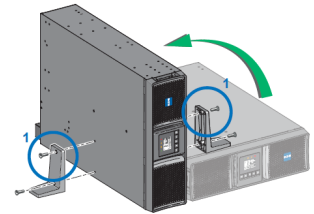
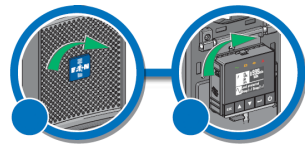
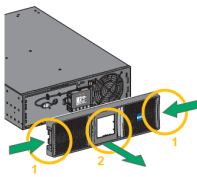

Installation in rack position

Follow steps below for module mounting on the rails. As UPS is heavy, it is advised to remove the batteries before mounting the UPS on the rack.

 The rails and necessary hardware are supplied by Eaton.

- ① Screw the rail on the back of the rack.
- ② Screw the rail on the front of the rack using the two holes at the bottom.
- ③ Screw the ears plate to the UPS.
- ④ Place the UPS on the rails and screw the ears plate to the top hole of the rail.

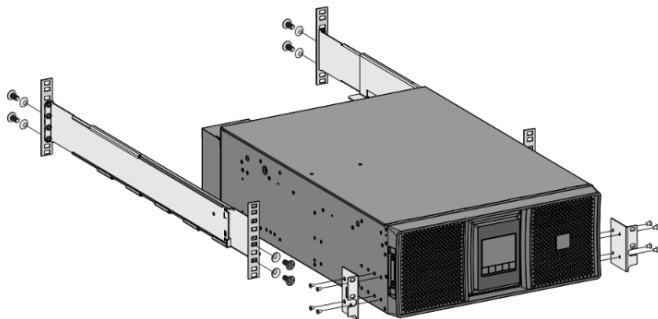
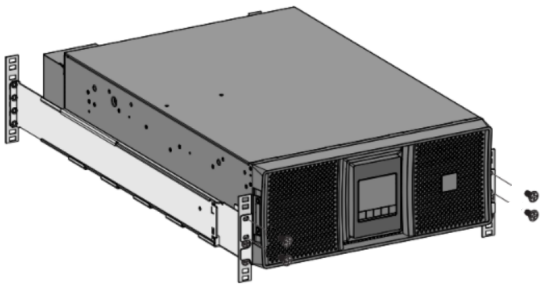

6000VA UPS: Installation in rack position by removing the battery

Follow steps 1 to 18

Steps 1 to 7 : Remove the battery

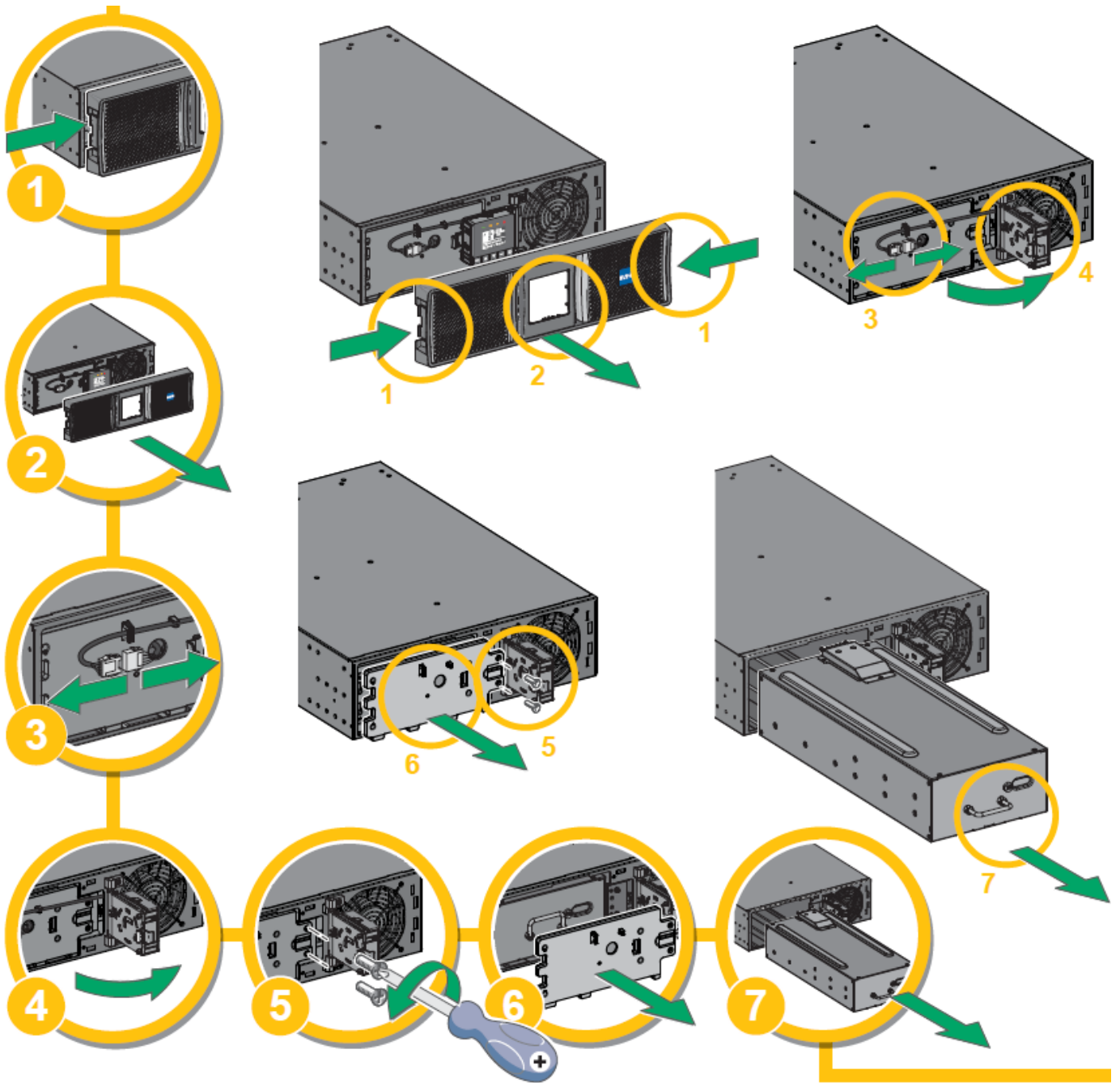

Steps 8 to 11 : Install the Rack Kit and Fix the UPS cabinet (w/o battery)

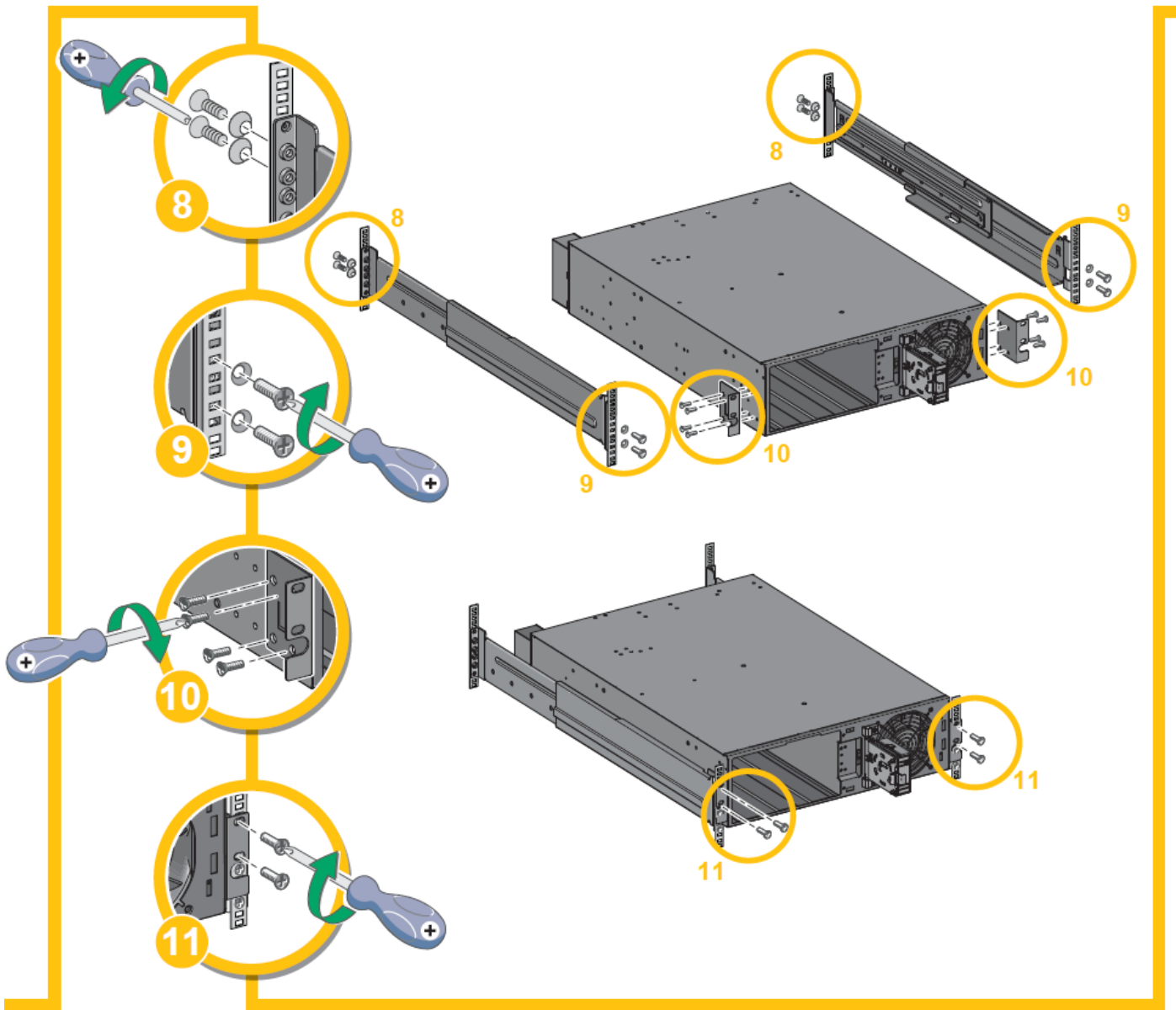

Steps 12 to 18 : Replace the battery and the front panel

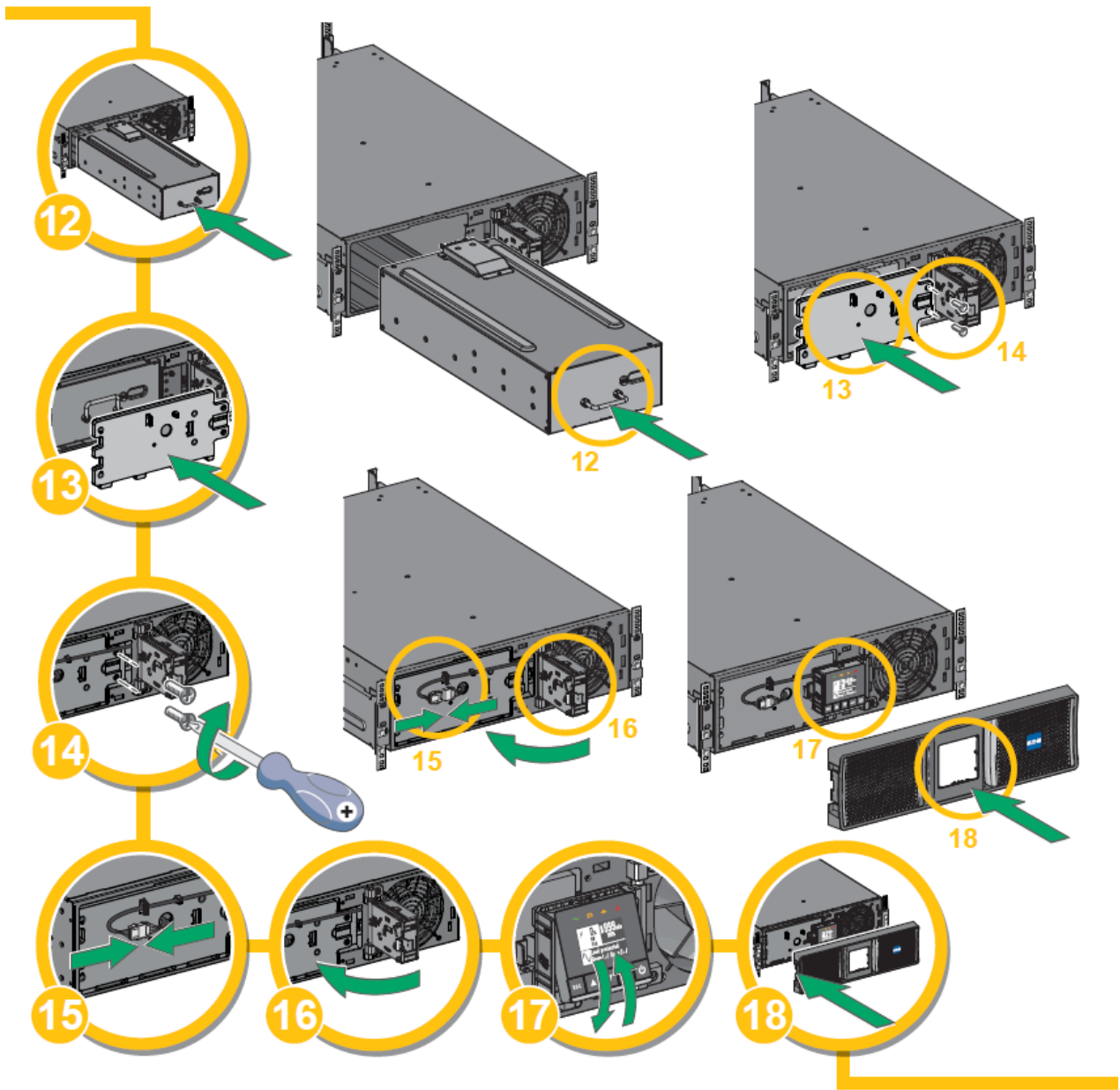

8000VA and 11000VA UPS: Installation in rack position by removing the battery

Follow steps 1 to 18

Steps 1 to 8 : Remove the battery

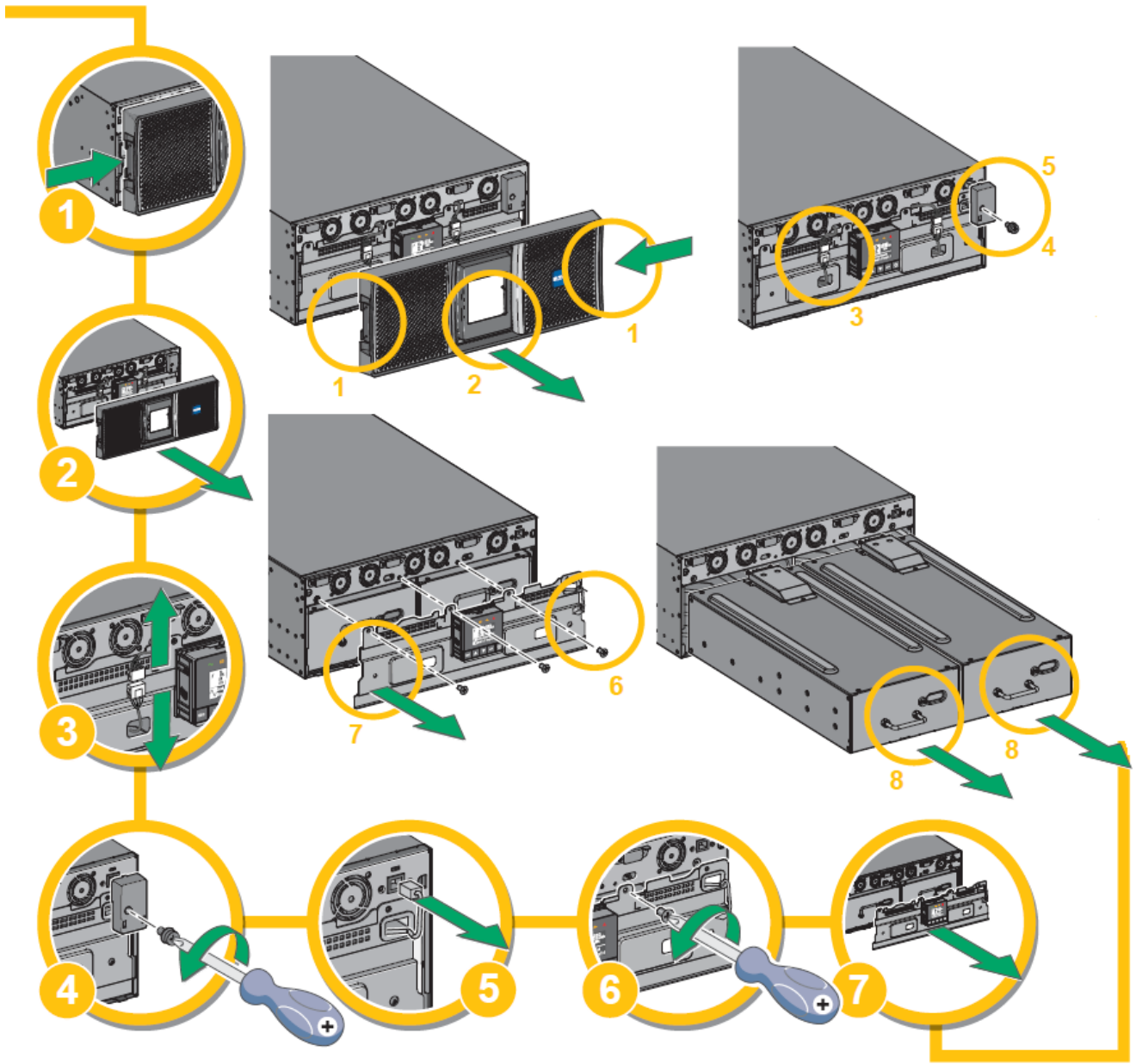

Steps 9 to 12 : Install the Rack Kit and Fix the UPS cabinet (w/o battery)

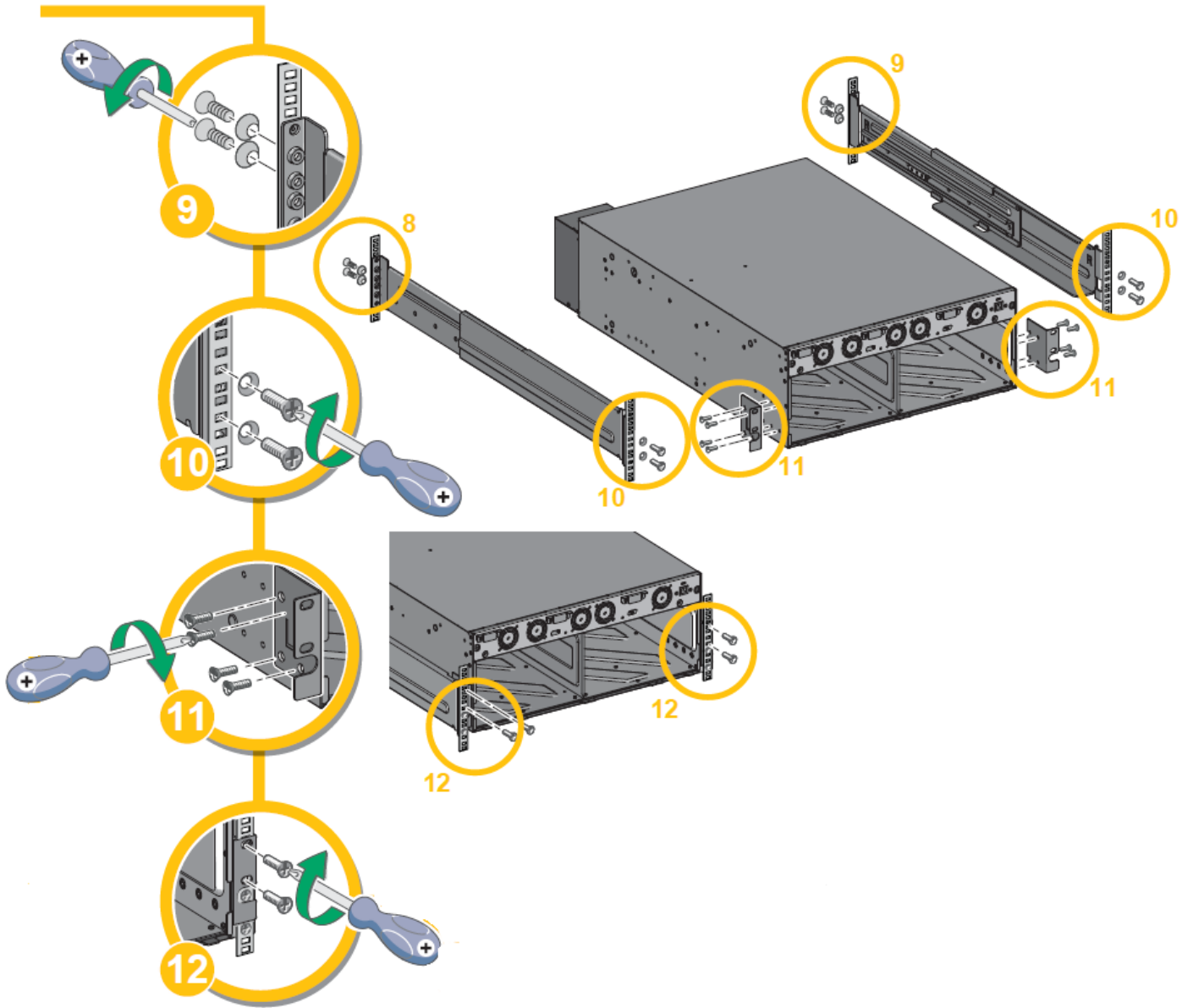

Steps 13 to 20 : Replace the battery and the front panel

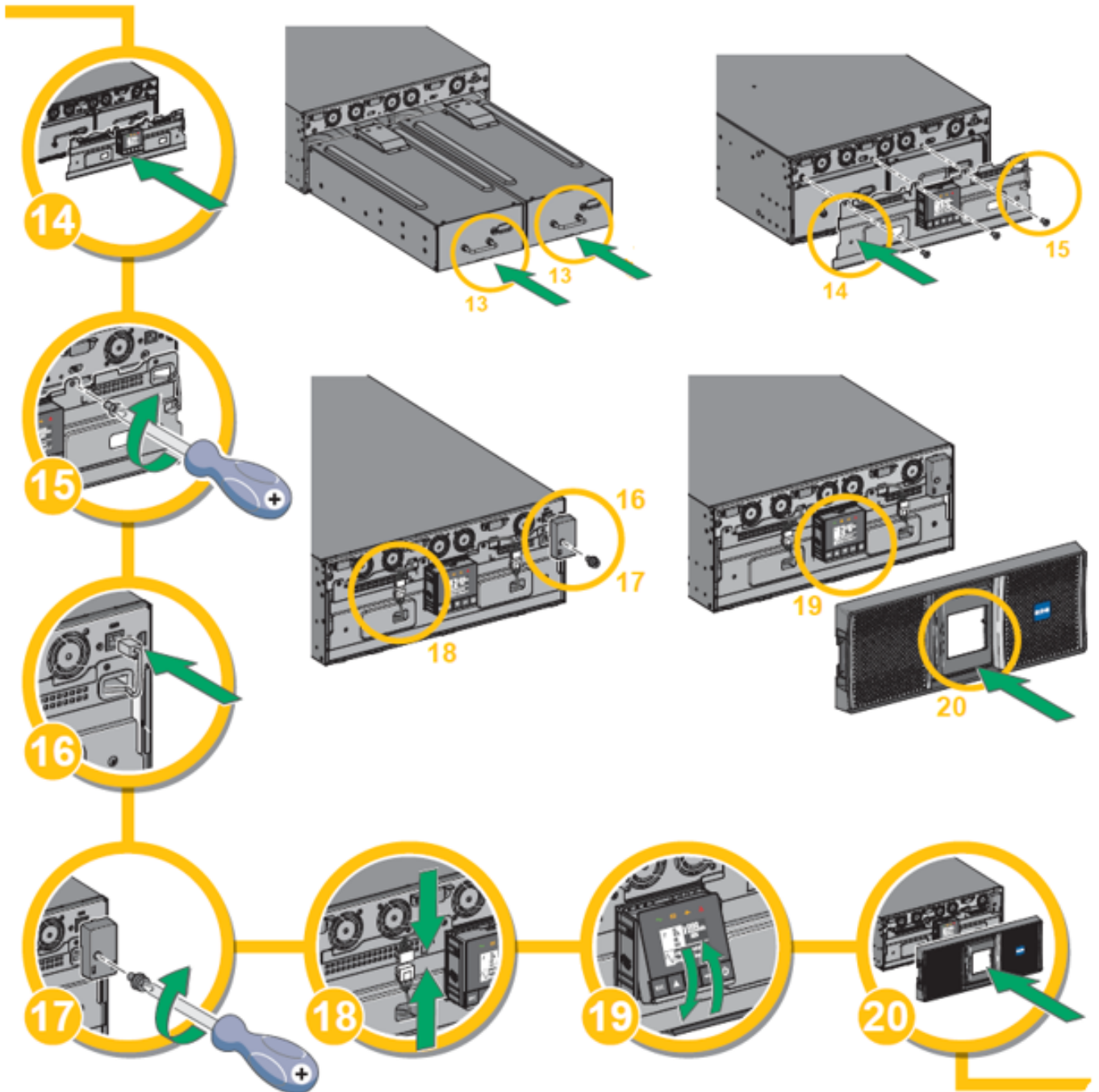

5000VA and 6000VA UPS: Installation in rack position by removing the battery

Follow steps 1 to 16

Steps 1 to 6 : Remove the battery

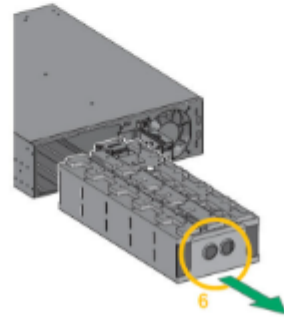
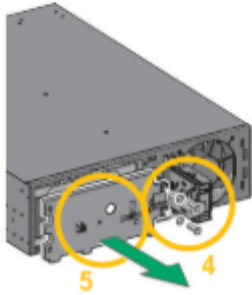
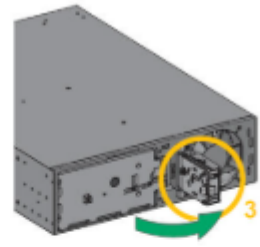
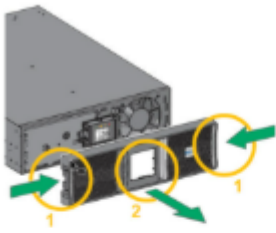

Steps 7 to 10 : Install the Rack Kit and Fix the UPS cabinet (w/o battery)

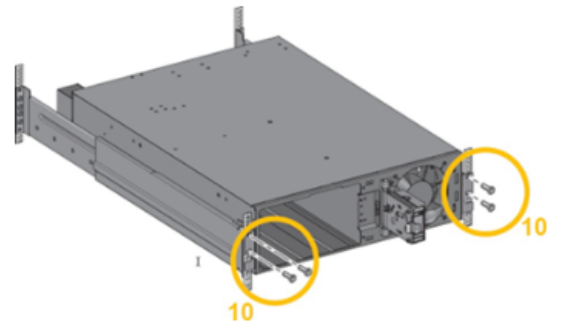
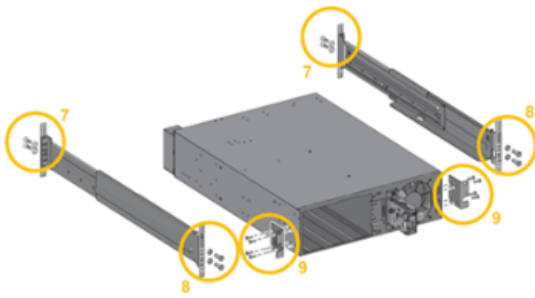

Steps 11 to 16 : Replace the battery and the front panel

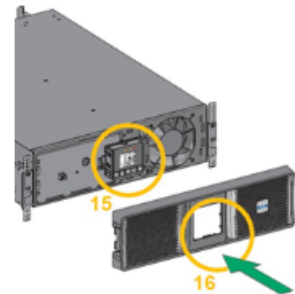
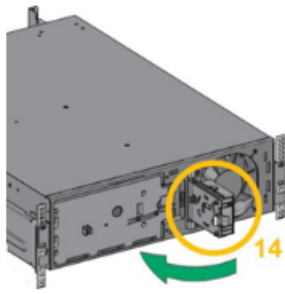
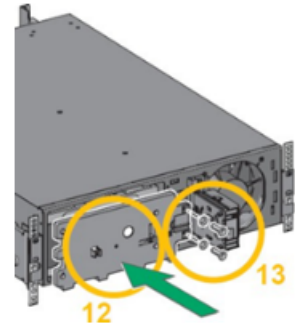
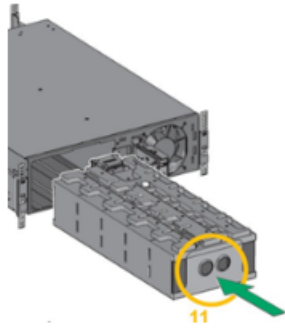

8000VA and 11000VA UPS: Installation in rack position by removing the battery

Step 1 to 7 : Remove the batteries

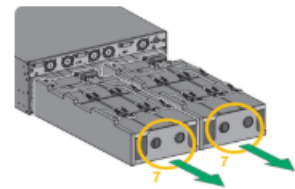
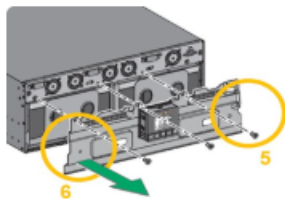
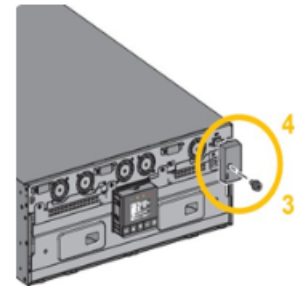
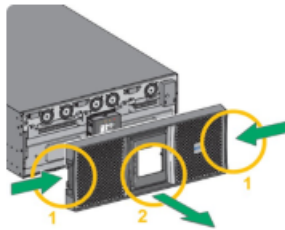

Steps 8 to 11 : Install the Rack Kit and Fix the UPS cabinet (w/o battery)

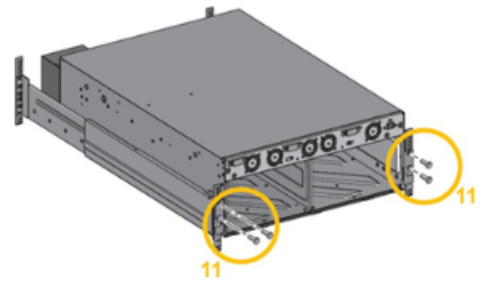
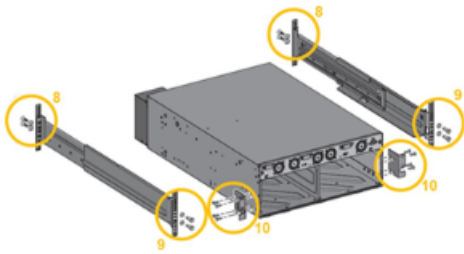

Steps 12 to 18 : Replace the battery and the front panel

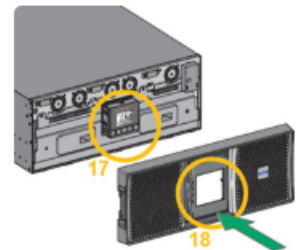
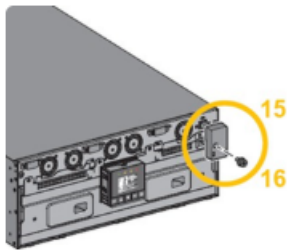
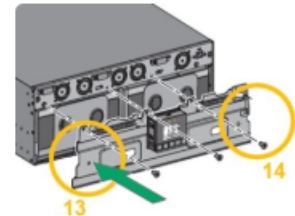
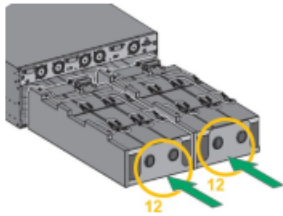

4.3 EBM connection

Tower installation

i Extended runtime with up to 10 Extended Battery Modules (EBMs) per UPS

⚠ When 11KVA UPS is used with more than 3 EBMs (between 3 and 10), additional bonding wires (Min 10AWG or 6mm² cross-sectional area) are required, see illustration below:

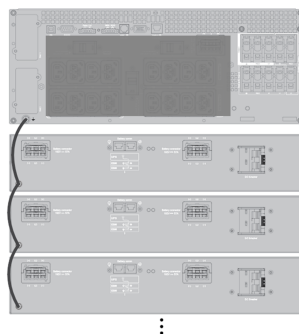

⚠️ A small amount of arcing may occur when connecting an EBM to the UPS. This is normal and will not harm personnel. Insert the EBM cable into the UPS battery connector quickly and firmly.

1. Attach the UPS and the EBMs to each other using the supplied mounting plate.
2. Connect the EBMs power cable and the attached battery detection cable as shown in the picture.

Eaton 9PX G2 192V 2m EBM Extension Cable must be used between UPS and first EBM only.

When 8KVA UPS is used with maintain bypass (MBP) and more than 9 EBMs (between 9 and 10), additional bonding wires (Min 10AWG or 6mm² cross-sectional area) are required. See illustration above.

When 11KVA UPS is used with more than 3 EBMs (between 3 and 10), additional bonding wires (Min 10AWG or 6mm² cross-sectional area) are required. See illustration above.

3. Verify that the EBM connections are tight and that adequate bend radius and strain relief exist for each cable.
4. Switch On the EBM breaker

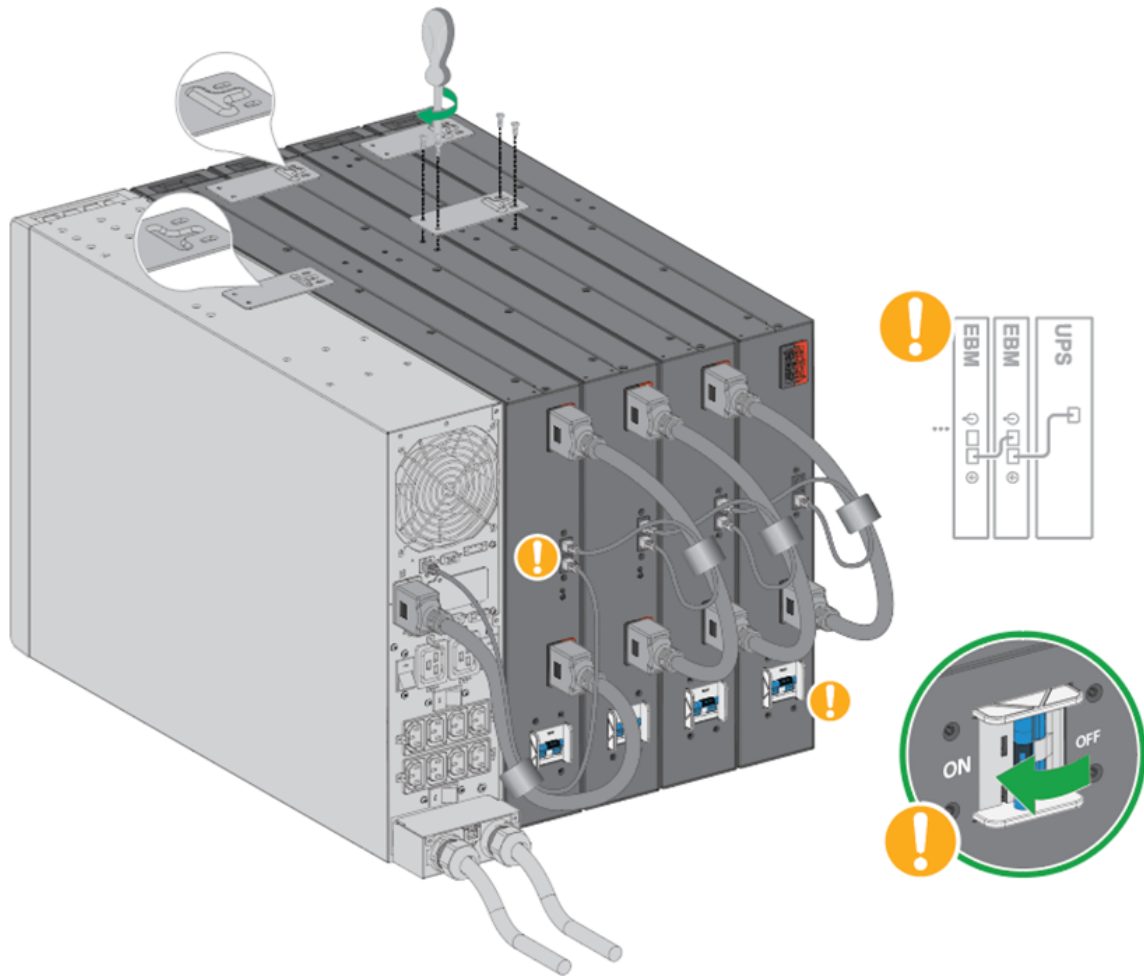

Rack installation

⚠ A small amount of arcing may occur when connecting an EBM to the UPS. This is normal and will not harm personnel. Insert the EBM cable into the UPS battery connector quickly and firmly.

i To increase stability, it is preferable to place the EBM below the UPS.

Rail Kit Installation

1. Screw the rail on the back of the rack.
2. Screw the rail on the front of the rack using the two holes at the bottom.
3. Screw the ears plate to the UPS.
4. Place the UPS on the rails and screw the ears plate to the top hole of the rail.

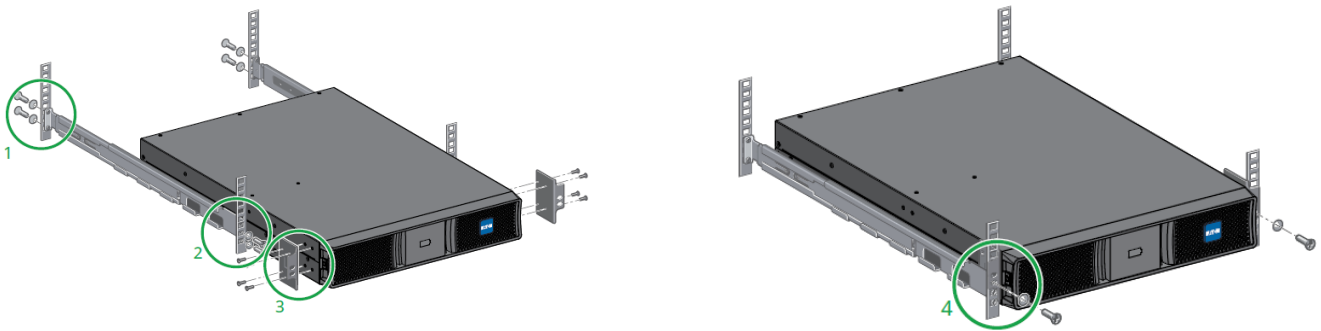

192V Lithium EBM connection to 9PX G2 Lithium UPS

1. Attach the UPS and the EBMs to each other using the supplied mounting plate.
2. Connect the EBMs power cable and the attached battery detection cable as shown in the picture.
3. Verify that the EBM connections are tight and that adequate bend radius and strain relief exist for each cable
4. Switch On the EBM breaker

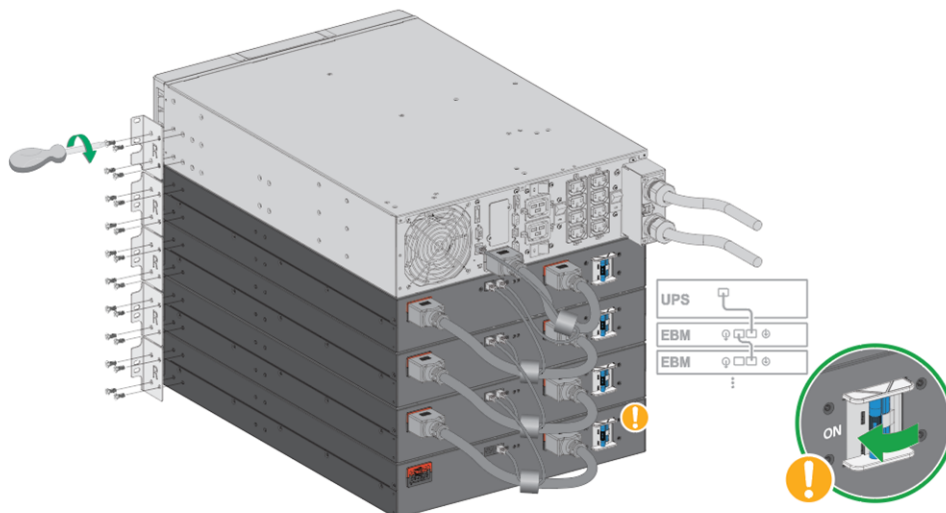

Verify that the EBM connections are tight and that adequate bend radius and strain relief exist for each cable.

4.4 UPS connection

Hardwired connection

Hardwired connection requires a minimum electrical knowledge, only person who understands following instruction details can install the UPS. Do not proceed if you don't technically understand the following instructions.

UPS connection without HotSwap MBP module

- ⚠ Check that the indications on the name plate located on the back of the UPS correspond to the AC-power source and the true electrical consumption of the total load.

Manually trip the Input circuit breaker of your installation.

- ⚠ Caution: switch off utility power to the distribution point where the UPS will be connected. Be absolutely sure there is no power.

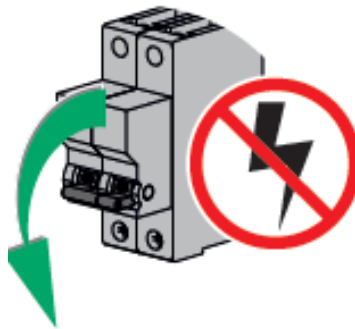

- ℹ Note: For 6000VA only. The UPS is already equipped with a L6-30P input cord.

Directly connect the L6-30P cord to the power outlet

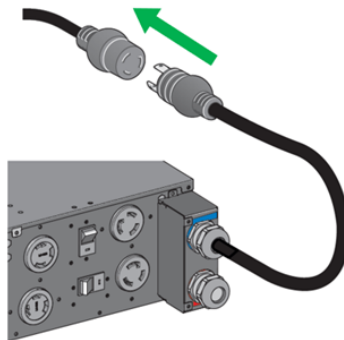

i Note: For 6000VA, the user can also choose to remove the I/O box to connect the UPS through the terminal block, following the below steps:

6000VA

Unscrew the I/O box

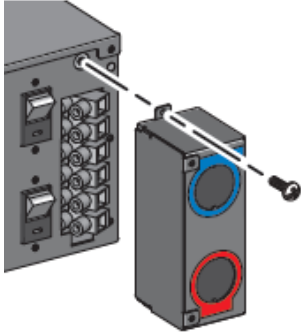

8000VA and 11000VA

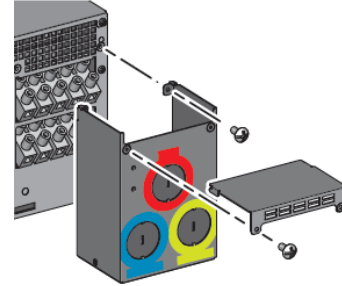

6000VA

Remove the blue circular cover (Input) and screw the cable gland.

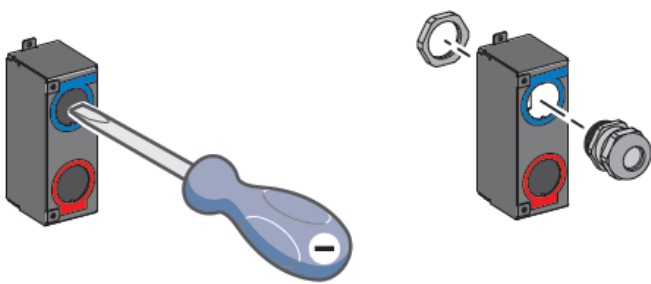

8000VA and 11000VA

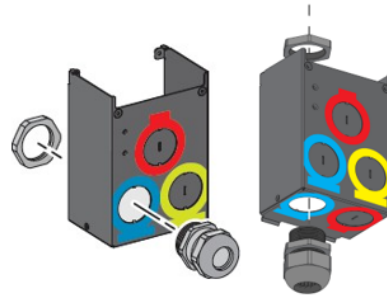

Strip the copper supply cable keeping the Earth cable longer for safety purposes

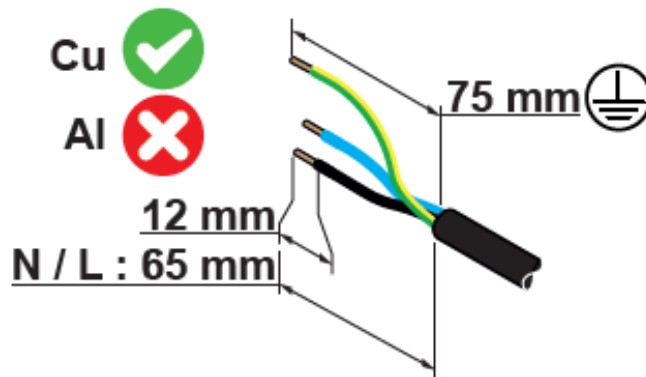

6000VA

Insert the supply cable in the I/O box

8000VA and 11000VA

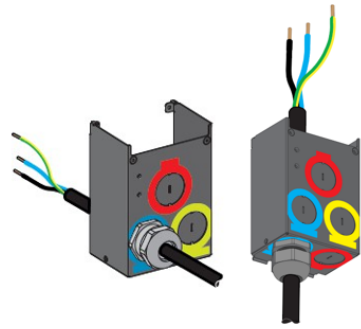
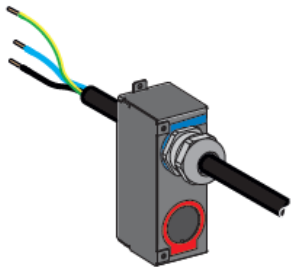

⚠ High leakage current: Earth connection essential before connecting supply

Recommended protective devices and cable cross-sections

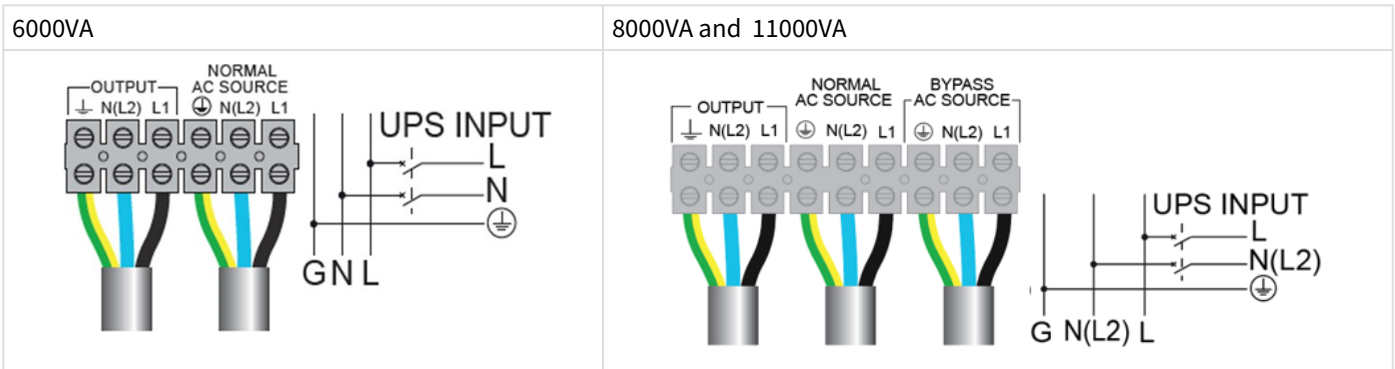

⚠ CAUTION, for 8000VA and 11000VA : there is a risk of voltage backfeed. Before working on this circuit, isolate the UPS, then check for Hazardous Voltage between all terminals including the protective earth. A suitable 2 poles AC contactor at the UPS input may be implemented as an external backfeed protection.

Recommended upstream protection

⚠ The upstream circuit breaker for Normal AC/Bypass AC must be easily accessible. The unit can be disconnected from AC power source by opening this circuit breaker.

UPS power rating	Upstream circuit breaker (CB)
6000VA (default installation, with L6-30P)	D curve 2 poles – 30A for cULs, 32A for others
6000VA (Hardwired connection)	D curve 2 poles – 40A*
8000VA	D curve 2 poles – 50A
11000VA	D curve 2 poles – 80A * ²

* If hardwired, it is required to use a 40A breaker and to change the connection mode in the user settings menu.

²If the UPS load is less than 90%, or without EBM, the UPS will limit the charger current to 4A. In this case, you could select the 70A (in US/CSA)/ 63A(others) upstream circuit breaker. (these conditions are not certificated)

Do not use 30 mA RCD/ELCB breaker upstream the UPS.

Recommended cable cross-sections for standard installation

UPS power rating	Maximum wire size	Minimum input wire size			Minimum output wire size			Min Tightening torque
		L1	N(L2)	⊕	L1	N(L2)	⊕	
6kVA(with L6-30P input)	6 AWG / 16mm ²	NA, Standard configuration L6-30P			10AWG / 6mm ²			10.6 lb-in
6kVA(with Hardwire input)		8AWG / 6mm ² *			8AWG / 6mm ²			
8kVA	4 AWG / 25mm ²	6AWG / 10mm ² *			8AWG / 10mm ²			22 lb-in
11kVA		4AWG / 10mm ² *			6AWG / 10mm ²			

⚠ *High leakage current, use additional PE conductor of the same cross-section area as the original PE conductor.

i For Supply connections, use wires suitable for at least 90°C copper or equivalent AWG used in US/CSA, mm² used in other countries.

Screw the electric cables, starting by the earth wire

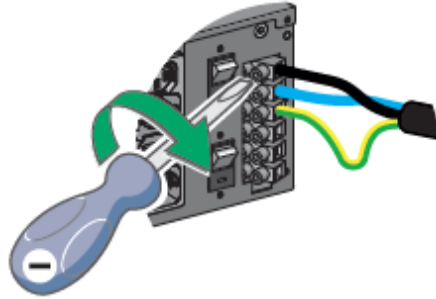

6000VA

8000VA and 11000VA

Screw the I/O box and tighten the cable gland

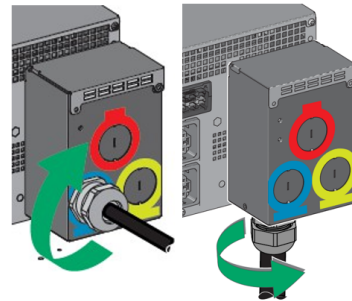
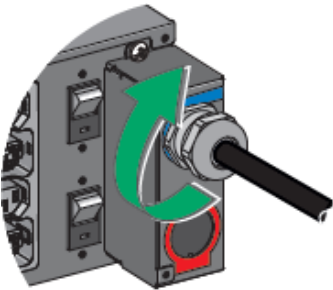
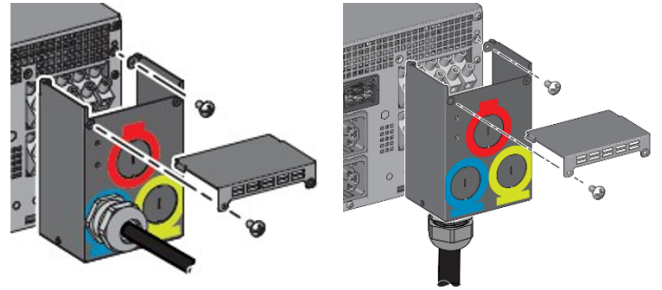
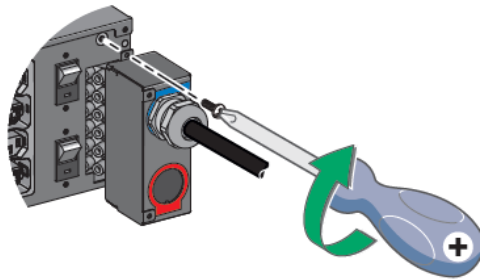

Connect the output cables, switch on the breaker and start the UPS

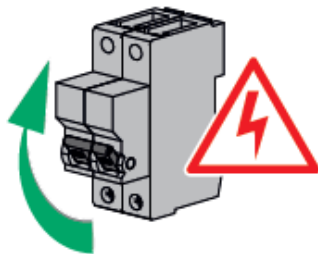
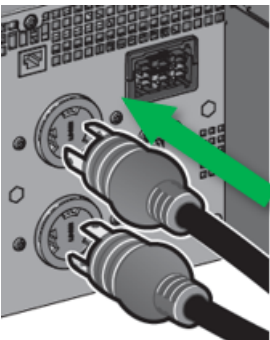

4.5 Connection with MBP

The Eaton® HotSwap MBP G2 module makes it possible to service or even replace the UPS without affecting the connected loads (HotSwap function).

You can safely eliminate the effects of UPS maintenance and guard the integrity of your equipment.

Providing outstanding reliability, the Eaton HotSwap MBP G2 unique benefits include:

- Easy and fast connection to UPS due to Input/Output and signal “all in one” patented connector (Hotswap MBP6k)
- “Make before break” feature to allow full servicing (electrical power continuity) when switching from UPS position to Bypass (and vice versa)
- Communication feature with UPS*: detection of MBP connection and switch position (Normal or Bypass) (* works only with some approved EATON UPS - contact your Eaton reseller for more information)
- Load connection by both terminal blocks and NEMA outlets
- Adjustable 19” rack kit and tower installation kit provided
- Backed by worldwide agency approvals

For the MBP used with 8000VA and 11000VA UPS, depending on the configuration, there are two different assemblies, identified with letters **A** (UPS only) and **B** (UPS+EBM)

Follow the steps below to install the MBP in rack position

i In the configuration "UPS + EBM", the MBP must be installed in the rack, not at the back of the UPS or EBM.

1. Screw the ears on each MBP side.

MBP6K208G2 used with 6000VA UPS

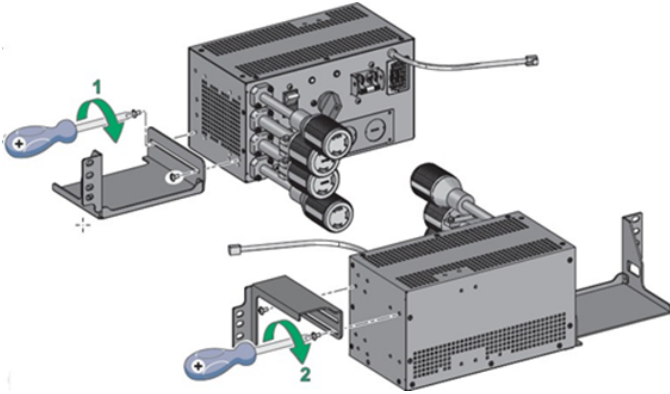

MBP6KIECG2 used with 6000VA IEC UPS

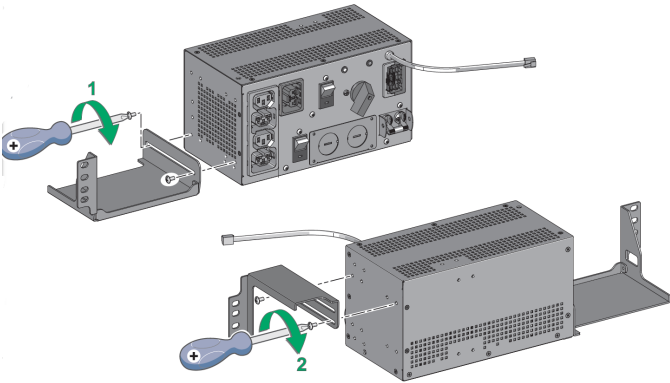

MBP6K208G2 used with 6000VA UPS

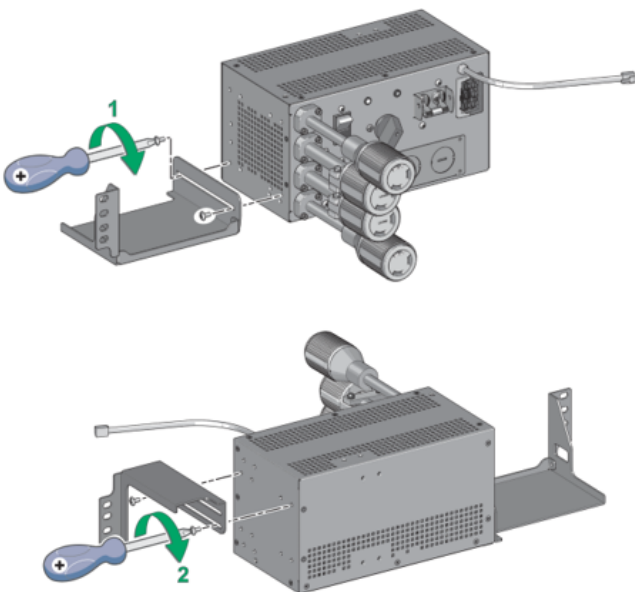

MBP11K208G2 used with 8000VA and 11000VA UPS

MBP6KIECG2 used with 6000VA UPS

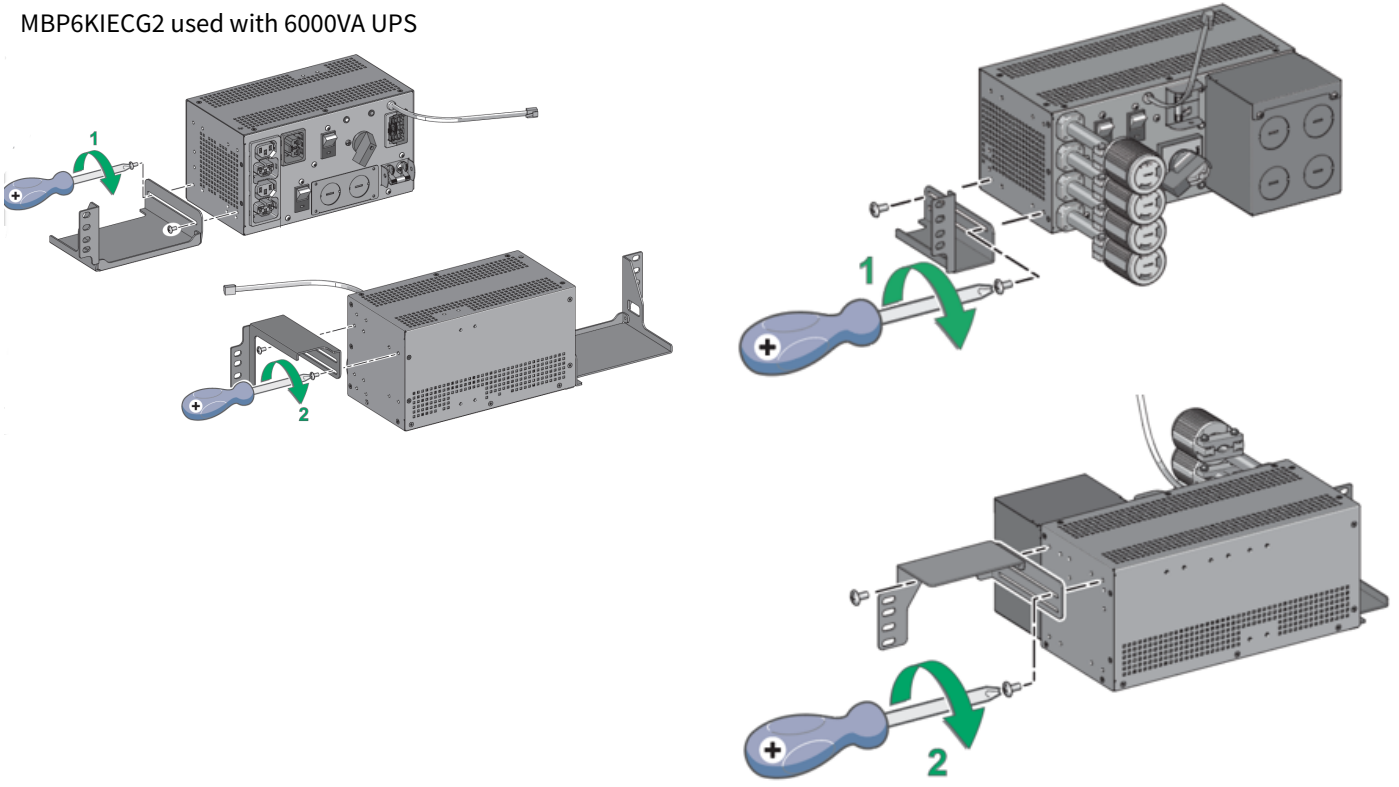

2. Mount the MBP with its ears on the UPS rack.

MBP6K208G2 used with 6000VA UPS

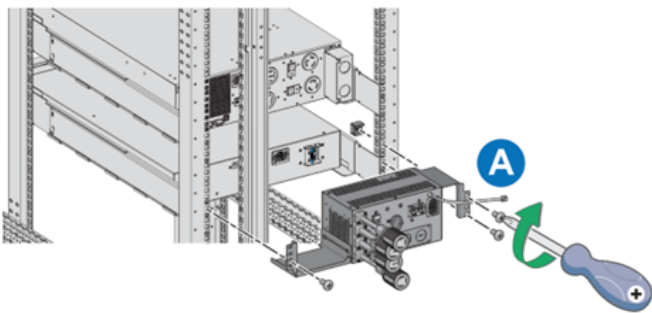

MBP6KIECG2 used with 6000VA IEC UPS

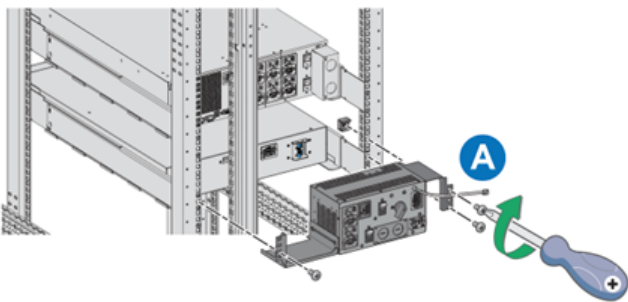

MBP11K208G2 used with 8000VA and 11000VA UPS

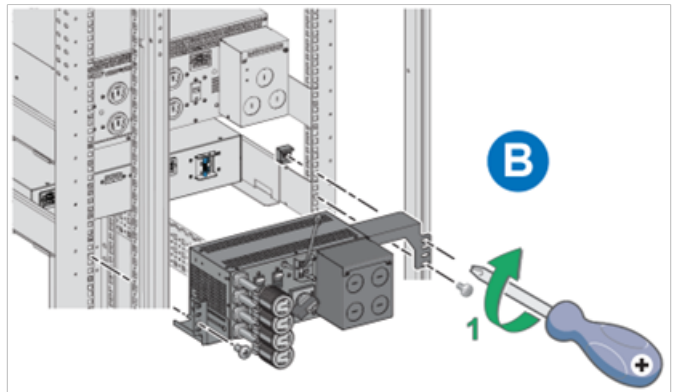
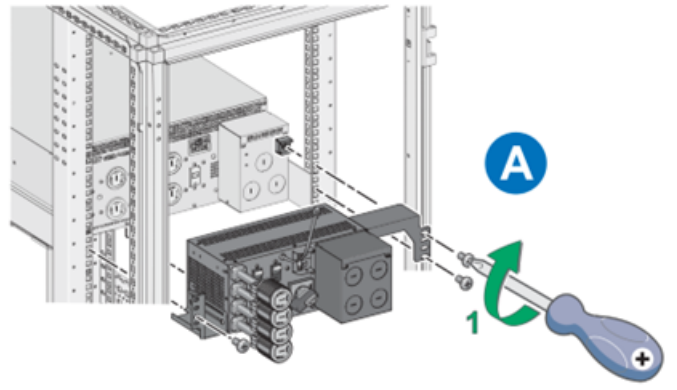

Follow the steps below to install the MBP in tower position

Depending on the configuration, there are four different assemblies, identified with letters A, B, C and D.

The different ways to mount the MBP with the UPS or the "UPS+EBM" are identified by the A, B, C & D letters.

Final assembly position

MBP6K208G2 used with 6000VA UPS

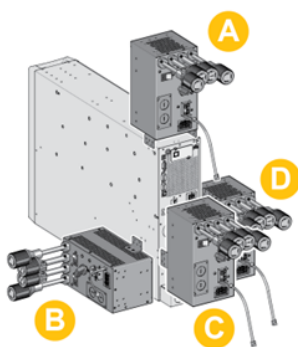

MBP6KIG2 used with 6000VA UPS

MBP11K208G2 used with 8000VA and 11000VA UPS

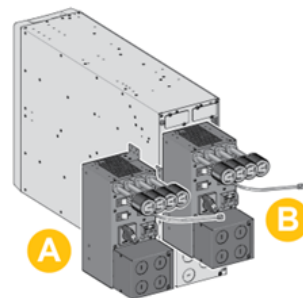

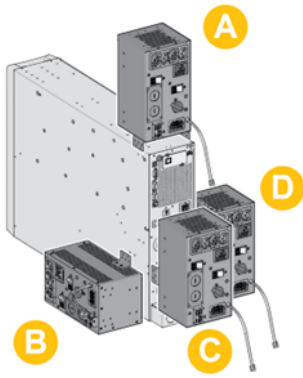

MBP6K208G2 used with 6000VA UPS + 192V EBM

MBP11K208G2 used with 8000VA and 11000VA UPS + 192V EBM

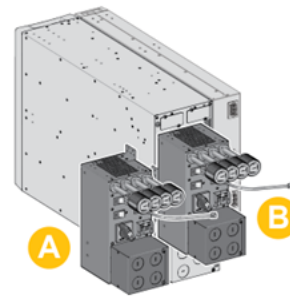
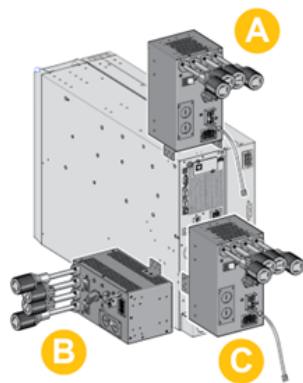

MBP6KIEC used with 6000VA UPS + 192V EBM

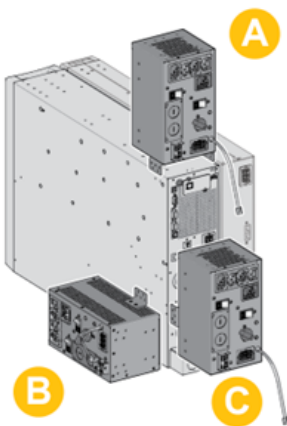

1. Screw the ears on each MBP side.

MBP6K208G2 used with 3000VA, 5000VA and 6000VA UPS

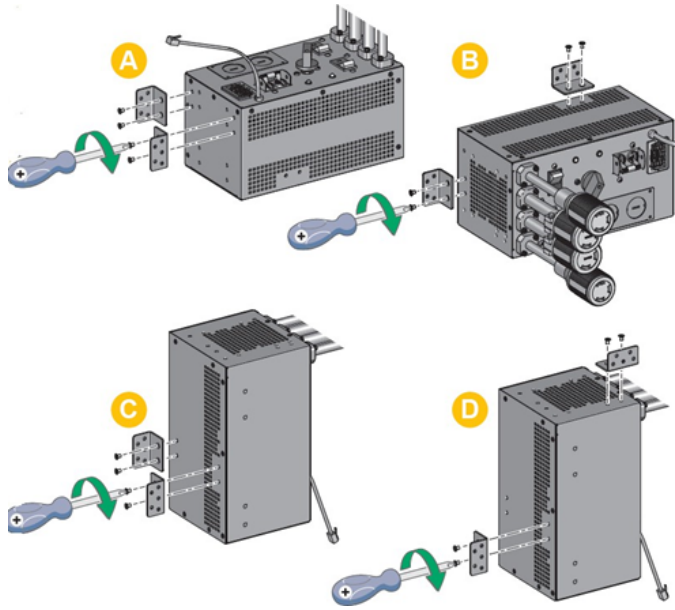

MBP11K208G2 used with 8000VA and 11000VA UPS

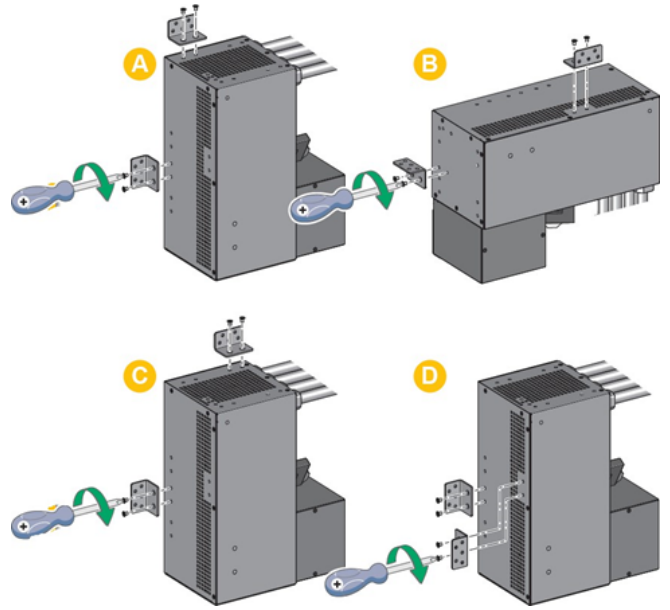

MBP6KIECG2 used with 6000VA IEC UPS

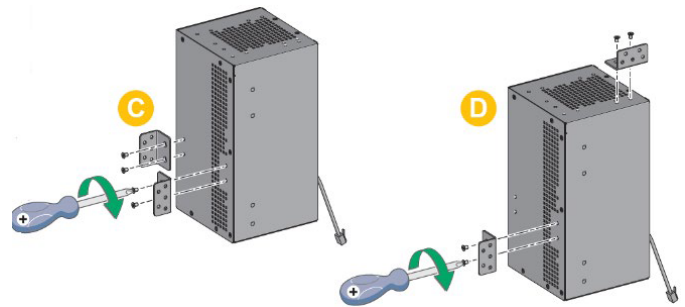
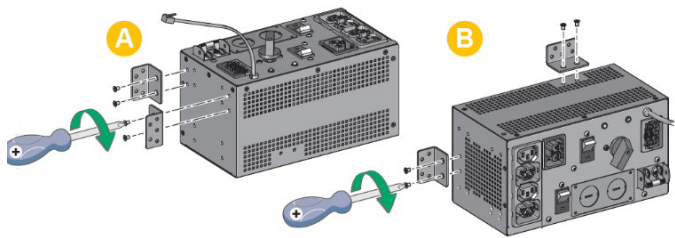

2. Mount the MBP with its ears on the UPS or EBM

MBP6K208G2 used with 6000VA UPS

MBP11K208G2 used with 8000VA and 11000VA UPS

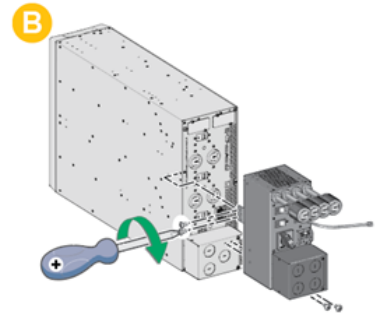
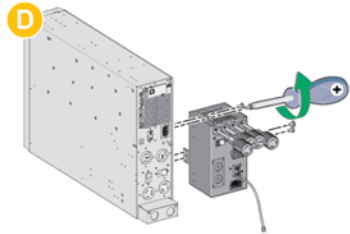
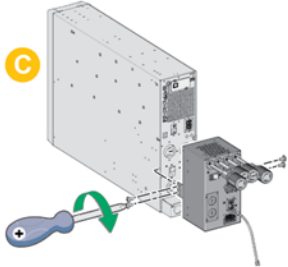
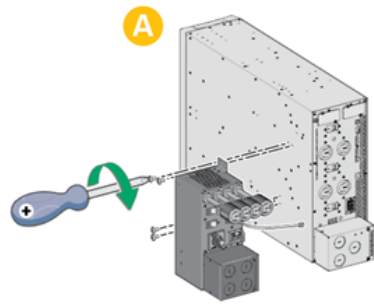
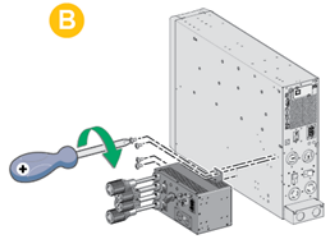
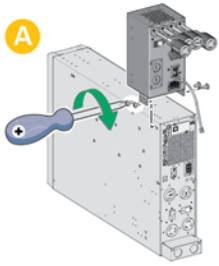

MBP6KIECG2 used with 6000VA IEC UPS

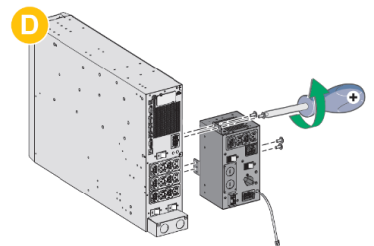
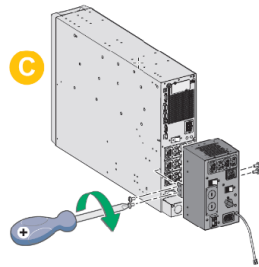
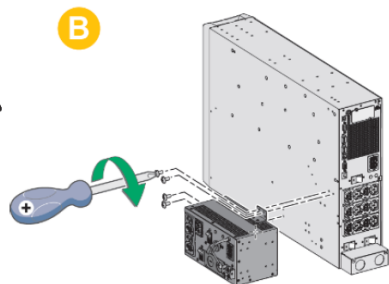
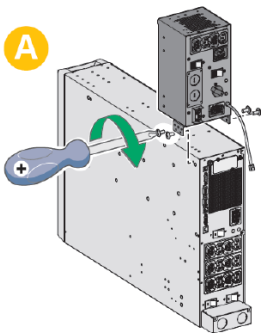

MBP electrical connection



⚠ Caution: Manually trip the input circuit breaker of your installation before connecting the supply cables.

Access to the terminal block, remove the circular covers and screw the cable glands.

i Note: For 3-6kVA UPS, it is possible to take the L6-30P input cable from the UPS and use it on the MBP input instead of hardwiring the MBP to utility power.

MBP 6k

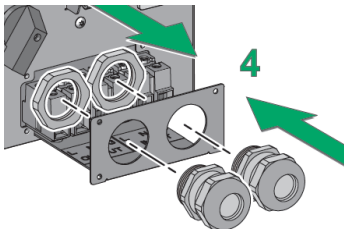
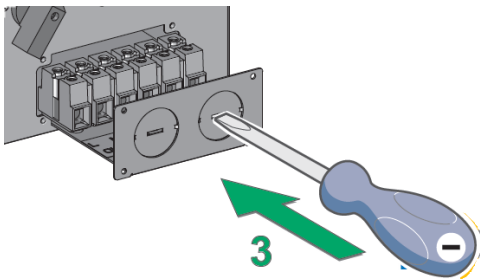
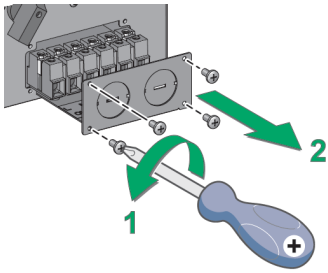

MBP 11k

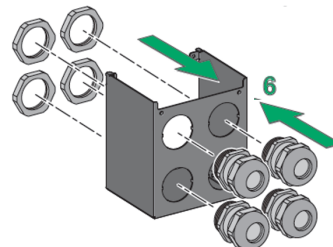
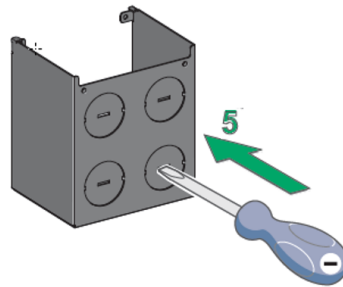
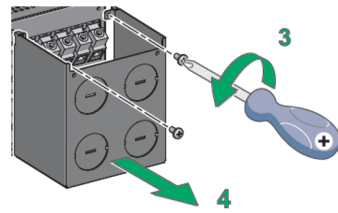
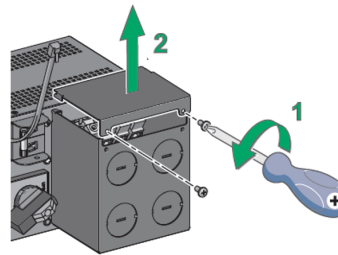

Close the I/O box terminal

MBP 6k

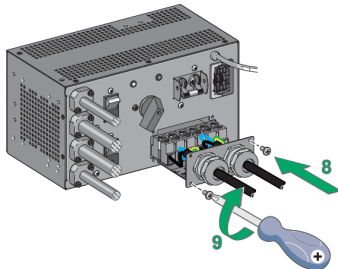

MBP 11k

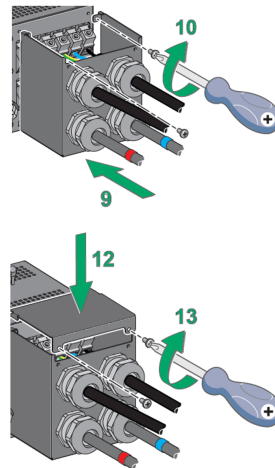

⚠ Follow below instructions for upstream protection and cable cross section.

⚠ Use copper cable only, and not aluminum.

⚠ The upstream circuit breaker for Normal AC/Bypass AC must be easily accessible. The unit can be disconnected from AC power source by opening this circuit breaker.

Recommended upstream protection

MBP Rating	MBP rating at 208V	Upstream circuit breaker (CB)
6000VA	5400VA/4800W with 6kVA UPS	D curve 2 poles – 30A
11000VA (Standard installation)	8000VA/8000W with 8KVA UPS 11000VA/11000W with 11KVA UPS	D curve 2 poles – 50A Dcurve2poles-80A ^{*1}

^{*1} If the UPS load is less than 90%; Or the total battery Ah less than 20Ah, the UPS will limit the charger current to 4A (0.2*20 = 4A), in this case, you could select the 70A (in US and CSA) / 63A(others) upstream circuit breaker. (these conditions are not certified)

Do not use 30 mA RCD/ELCB breaker upstream the UPS.

Recommended cable cross-sections for standard installation

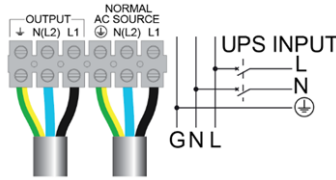

MBP and UPS	Minimum input wire size			Minimum output wire size			Min Tightening torque	Maximum cable size
	L1	N(L2)	⊕	L1	N(L2)	⊕		
9PX6KG2-L* ² + MBP6K208G2 or MBP6KIECG2	10AWG / 6 mm ² *			10AWG / 6 mm ²			16 lb-in	6AWG / 16 mm ²
9PX8KG2-L + MBP11K208G2	6AWG / 10 mm ² *			8AWG / 10mm ²			22 lb-in	4AWG / 25 mm ²
9PX11KG2-L + MBP11K208G2	4AWG / 10 mm ² *			6AWG / 10 mm ²				

AWG used in US/CSA, mm² used in others.
 For Supply connections, use wires suitable for at least 90°C copper or equivalent.

Note:

- * **⚠ High leakage current**, use additional PE conductor of the same cross-section area as the original PE conductor.
- *² When 6K UPS used with MBP, the UPS cannot select the Hardwired method in the user settings menu, the power rating could just be 5400VA/4800W

⚠ Strip the copper supply cable keeping the Earth cable longer for safety purpose.

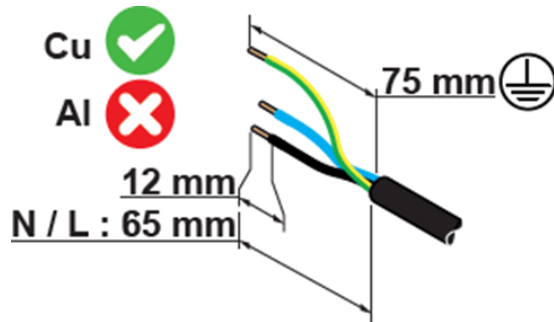

Insert the cables

MBP 6k

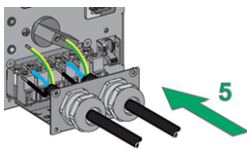

MBP 11k

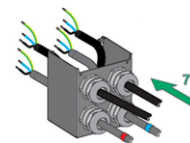

Tighten well the cable glands

MBP 6k

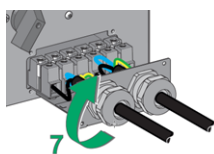

MBP 11k

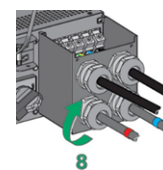

Close the I/O box terminal

MBP 6k

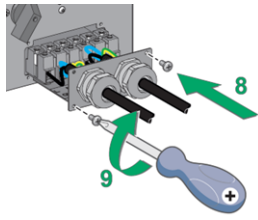

MBP 11k

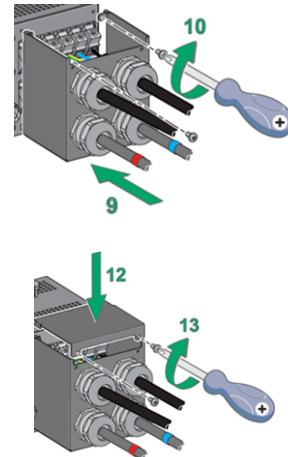

Connection between MPB and UPS

⚠ For the electrical connection on the UPS side, follow the steps described in the chapter "Hardwired connection"

Connect the MBP cord set (For 6k MBP only)

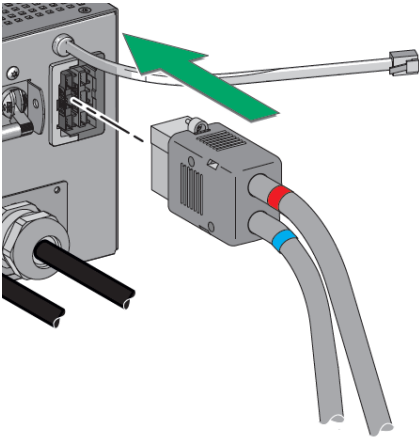

Connect the MBP detection cable to the UPS

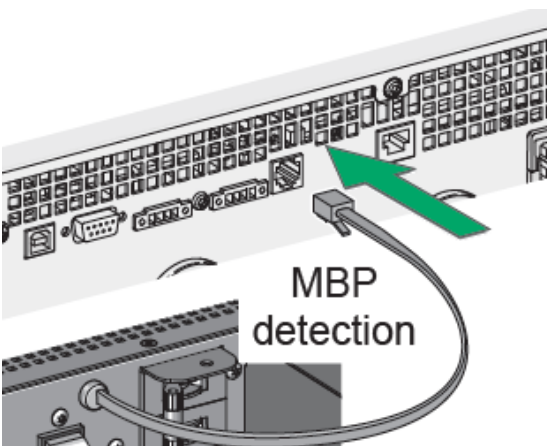

Power up your installation

Switch on the input circuit breaker of your installation. The installation is powered up and can be used.

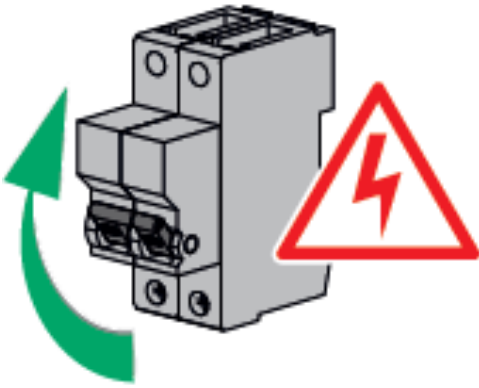

HotSwap MBP module test

Set Manual Bypass switch to Bypass position and check that the load is still supplied.

Set Manual Bypass switch back to Normal position.

4.6 Register warranty

Register warranty at <https://content.eaton.com/product-registration>.

5 Interfaces and communication

5.1 Control panel

The screen provides useful information about the UPS itself, load status, events, measurements and settings.

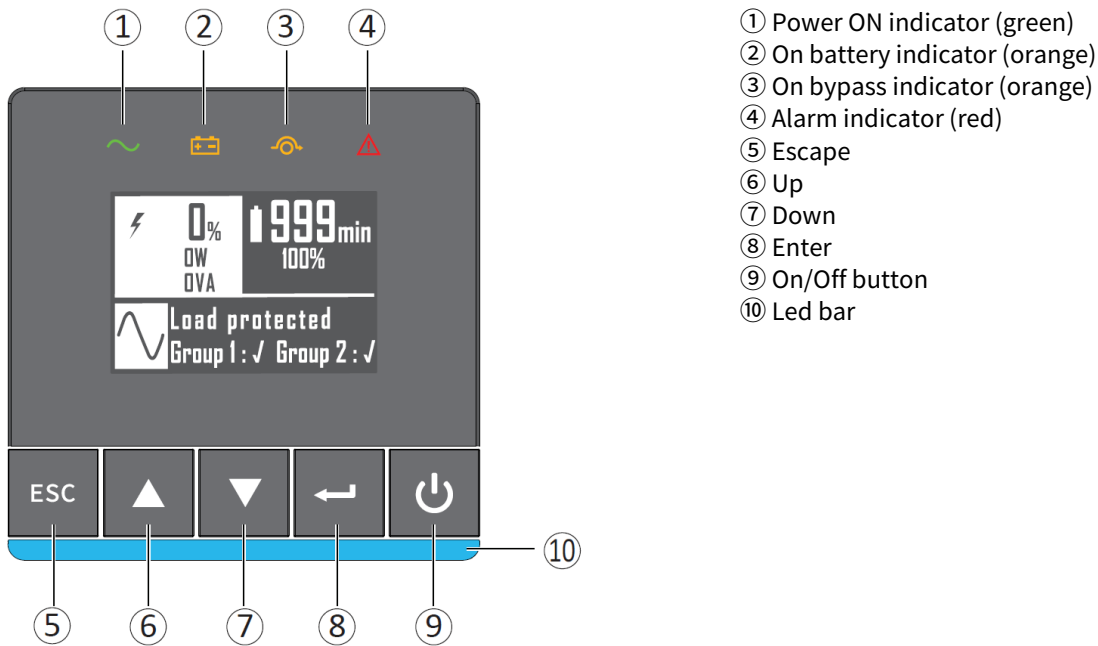





- ① Power ON indicator (green)
- ② On battery indicator (orange)
- ③ On bypass indicator (orange)
- ④ Alarm indicator (red)
- ⑤ Escape
- ⑥ Up
- ⑦ Down
- ⑧ Enter
- ⑨ On/Off button
- ⑩ Led bar

Led indicator

The following table shows the indicator status and description:

The LED bar ⑩ has been implemented to provide a quick visual reference of UPS status "at-a-glance".

Indicator	Status	Description
 Green	On	The UPS is "ON" and the load is protected.
 Orange	On	The UPS is in battery mode and the load is protected.
 Orange	On	The UPS is in bypass mode.
 Red	On	The UPS has an active alarm or fault. See troubleshooting page for additional information.
Led bar	Static blue	The UPS is "ON" and the load is protected.
	Flashing blue	The UPS is on battery or the battery service age warning is reached.
	Static red	The UPS has an active alarm or fault.
	Static orange	The Load is powered by automatic bypass (load not protected).
	Flashing orange	The Load is powered by manual bypass (load not protected).

5.2 LCD description

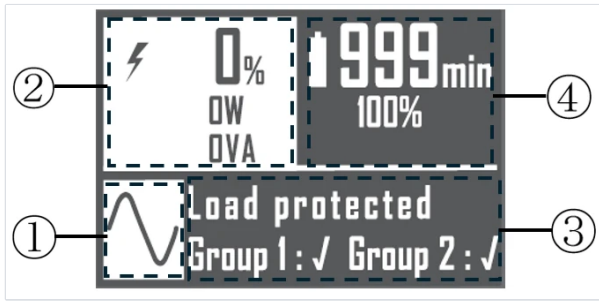







- ① Operation status
- ② Load/equipment status
- ③ Load group information
- ④ Battery status

By default, or after 5 minutes of inactivity, the LCD displays the screen saver. The backlight LCD automatically dims after 5 minutes of inactivity. Press any button to restore the screen.

i Note: If other indicator appears, see troubleshooting page for additional information.

The following table describes the status information provided by the UPS:

Operation status	Possible cause	Action
Standby mode 	The UPS is OFF, waiting for start-up command from user	Equipment is not powered until  button is pressed during start up and the green "normal mode" LED indicator is illuminated.
Normal mode 	The UPS is operating normally.	The UPS is powering and protecting the equipment.
On Battery  One beep every 10 seconds	A utility failure has occurred and the UPS is operating in Battery mode.	The UPS is powering the equipment with battery power. Prepare your equipment for shutdown.
End of backup time  1 beep every 3 seconds Single beep	The UPS is in Battery mode and the battery is running low.	This warning is approximate, and the actual time to shutdown may vary significantly. Depending on the UPS Load, the "Battery Low" warning may occur before the battery reaches 20% capacity remaining.
High Efficiency mode 	The UPS is operating in High Efficiency mode.	The UPS is powering and protecting the equipment.
Bypass mode 	An overload or a fault has occurred, or a command has been received, and the UPS is on Bypass mode.	Equipment is powered but not protected by the UPS.

5.3 Display functions

Press the Enter (↵) button to activate the menu options. Use the two middle buttons (▲ and ▼) to scroll through the menu structure. Press the Enter (↵) button to select an option. Press the (ESC) button to cancel or return to the previous menu.

Menu map for display functions

Measurements

Submenu	Display information or Menu function
/	Load [Total Load/Load (Primary)/Load (Group 1)/Load (Group 2)] : W, A, VA, pF [Input/Output] : V, f [Efficiency] : % [Battery Info] : %, min, V, number of EBM, Battery Age, Replacement Part No . [Average power usage] : Total Wh , Primary, Group 1, Group 2 [Cumulative power] : Total KWh, Since Primary, Since Group 1, Since Group 2

BMS information

Submenu	Display information or Menu function
Inner Bat 1 Inner Bat 2(Only for 8k/11k) EBM1 EBM2 ...	BMS Model: [BMS firmware], [Serial number / Assembly date]
	BMS Meter: [BMS output], [SOC / SOH / Cycles / Capacity]
	BMS log: [BMS log1], [BMS log2], [BMS log3] : BMS log: [Fault ID code]. [Max battery cell voltage] [Min battery cell voltage]. [Max battery cell temp.] [Min battery cell temp.]. [Total battery pack voltage] [charge current]. [SOC] [SOH].

Note:

Please refer to the picture below for the relationship between the battery number and the actual battery position. Example for 11k :

In the internal batteries:

- Left side: Internal Battery 1; Right side: Internal Battery 2,
- If the system detects only one internal battery, it will be identified as Internal Battery 1.

In the EBM, the electrical connection closest to the UPS is EBM1, followed by EBM2, and so on.

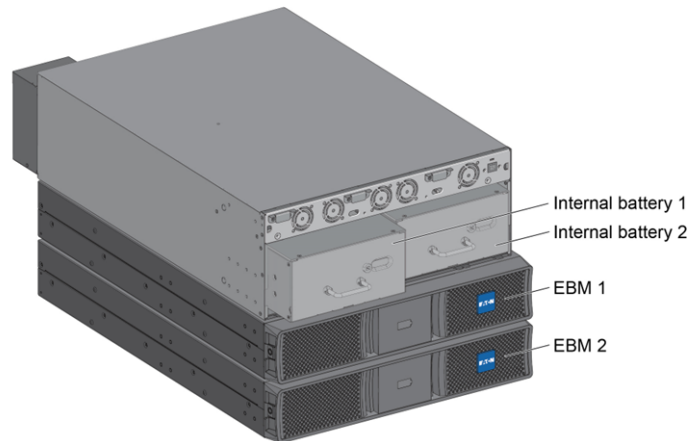

Control

Submenu	Display information or Menu function
Go to Bypass	The user has the possibility to force the Ups to go to Bypass mode, only if the Ups mode is in Online or in battery mode.
Go back normal	After force to bypass mode, the user has the possibility to force the Ups to go back to Line mode.

Load Segments	Group 1: ON / OFF Group 2: ON / OFF These commands overrule user settings for load segments.
Start battery test	Starts a manual battery test
Change battery	Disable charger, Replace battery, Update settings
Connectivity test	Dry contacts test, Relay card test, Line failure test, Battery low test
Functions reset	Reset fault state : Clear active fault
	Reset power usage: Clears average power usage measurement
	BMS Auto Setup : UPS will start detecting the EBM quantities only when the UPS is powered on for the first time. If the quantity of EBMs is reduced, UPS will report BMS comm. loss. If the quantity is increased, UPS cannot actively identify it. In that time, the user can select "BMS auto setup" to manually refresh the battery quantity.
	Wakeup BMS : Manually wakeup signal to wake up Li-ion battery.
	Set Transportation mode : Manually send a "go to transportation mode" command to Li-ion battery.
	Reset battery life
	NMC Card reset : Manually reset the NMC card.
	Restore factory settings : Returns all settings to original values

Settings

Submenu	Display information or Menu function
Local settings	Sets product general parameters, see User settings
Input / output settings	Sets input and output parameters
ON / OFF settings	Sets ON / OFF conditions
Battery settings	Sets battery configuration
Communication settings	Sets communication parameters

Event log

Submenu	Display information or Menu function
View Alarms	Displays the alarms stored
View Events	Displays the events stored
View All	Displays the faults, alarms and events stored
Reset All	Clears the faults, alarms and events stored

Fault log

Submenu	Display information or Menu function
Fault list	Displays the faults stored
Reset fault list	Clears faults

Identification

Submenu	Display information or Menu function
/	Type / Model / Part Number / Serial Number / UPS Firmware / NMC Firmware / IPV4 Address / IPV6 Address / Com card MAC Address / Detected accessories

Registration

Submenu	Display information or Menu function
/	Links to Eaton registration website

5.4 User settings

The following table displays the options that can be changed by the user.

Local settings

Submenu	Available settings	Default settings
Language	[English] [Français] [Deutsch] [Español] [Português] [Italiano] [Polish] [Simplified Chinese] [Japanese] Menus, status, notices and alarms, UPS fault, Event Log data and settings are in all supported languages.	[English] Automatic message for user configuration when UPS is powered for the first time.
Date / time	Format: [International] [US]	[US]
LCD	Modify LCD screen brightness and contrast to be adapted to room light conditions.	[0]
Audible alarm	[Enabled] [Disabled on battery] [Always disabled] Enable or disable the buzzer if an alarm occurs.	[Enabled]
	Level: [High] [Low]	[High]
Protected access	[Enabled] [Disabled] Allow the user to protect Control and Settings menus. To reset the password contact Eaton support.	[Disabled]

In/Out settings

Submenu	Available settings	Default settings
Output voltage	[200 V] [208 V] [220 V] [230 V] [240 V]	[208 V]
Output frequency	Mode: [Normal] [Converter] The output frequency will be autosensing in normal mode. Frequency can be changed in [Converter] mode.	[Normal] If select [Converter]: [60Hz]
Output Mode	Mode: [Industrial] [IT] [Custom] Overload: [Inv>Stop] [Inv>BP] [Inv>BP>Inv] Short-circuit: [Inv>Stop] [Inv>BP][Inv>BP>Inv]	[IT] [Inv>BP>Inv] [Inv>Stop]
Input V hysteresis	Sets input voltage hysteresis from [1] to [10V]	[10V]
High efficiency	[Enabled]: [Yes] [No] Power the output from Bypass for high efficiency	[No]
Bypass settings	[Volt low]	Output voltage * 0.8
	[Volt high]	Output voltage * 1.15
	[Qualify] : [Always] [In Spec]	[In spec]
	[Hz synch]	[5%]
	[Unsynch] : [Half cycle] [full cycle]	[Half cycle]
Load segments	[Auto start delay]	UPS:[No delay]; Group1:[3s]; Group2:[6s]
	[Auto shutdown delay]	UPS:[Disabled]; Group1: [Disabled]; Group2: [Disabled]
Overload prealarm	[10%] ... [102%] Load % when overload alarm occurs	[102%]
Power Limit	[Enabled]: [Yes] [No] Disabled/ Enabled UPS power limit mode on 5K/6K/ 8K/11K. If Enabled, nominal power change to 4000VA/4000watt	[No]

Dust Proofing	[Enabled]: [Yes] [No] If set to Enabled, a 40% derating will be applied to allow functioning with a dust filter.	[No]
Redundancy mode	[Unitary UPS] [Hot Standby]	[Unitary UPS]
Input wiring (for 6K models)	[L6-30P] [Hardwired] Available on AMER 6K models. It can be changed to be compatible with actual input wiring. If set to [L6-30P], nominal power will be derated	[L6-30P]

ON/OFF settings

Submenu	Available settings	Default settings
Start/Restart	[Cold start] [Auto restart] [Auto start] [Start on bypass]	[ON] [ON] [OFF] [OFF]
Forced reboot	[Enabled] : [Yes] [No] [Timer] [10s] ... [180s] When mains recovers during a shutdown sequence: If set to Enabled, shutdown sequence will complete and wait 10 seconds prior to restart, If set to Disabled, shutdown sequence will not complete, UPS stays on.	[Yes] [10s]
Energy saving (W,%, delay)	[Enabled] : [Yes] [No] [Time] [0min] ... [15min] [Level] [10W] ... [Nominal Power] If Enabled, UPS will shutdown after defined duration of backup time, if load is less than set value.	[No] [5min] [100W]
Sleep Mode	[Enabled] : [Yes] [No] [Timer] [10min] ... [120min] If Disabled, LCD and communication will turn OFF immediately after UPS is OFF. If Enabled, LCD and communication stay ON for the set time period after UPS is OFF (default 90 min)..	[Yes] [90min]
Site Wiring Fault	[Enabled] : [Yes] [No] Prevents the UPS from starting if the phase and neutral wires are swapped.	[No]
Power Off alert	[Enabled] : [Yes] [No] If enabled, activates a confirmation screen that requires user confirmation after pressing the power button, before UPS shutdown occurs. Remote shutdown, ROO, RPO, Input signals will never request user confirmation, even if the setting is enabled	[Yes]
Bypass standby	[Enabled] : [Yes] [No]	[No]
Fast AC return	[Enabled] [Yes] [No]	[No]

Battery settings

Submenu	Available settings	Default settings
Auto battery test	[No test] [Daily] [Weekly] [Monthly]	[No test]
Battery age warning	[Disabled][Preventive][Predictive] If Preventive, the UPS displays a battery replacement reminder through the front LCD and any installed network communication card after the indicated timeframe [6-120] months has elapsed .	[Predictive] Refer to Battery State Of Health (SOH) section
Low battery warning	[Capacity] [10]... [100%] [Runtime] [0min] ... [60min] The alarm triggers when the set percentage of battery capacity or remaining back-up time is reached.	[10%] [3min]

Restart batt. Level	[0%] ... [100%] Automatic restart will occur only when the set percentage of battery charge is reached, and "Auto Restart" is enabled and set to ON. A setting of 0% allows immediate automatic restart when utility returns after a UPS shutdown due to an extended power outage.	[0%]
---------------------	---	------

Comm settings

Submenu	Available settings	Default settings
Input signals [ROO] [RPO] [DB9-4] Sets Input signals parameters (function, delay, operation) through external contact connectors or RS232 port.	ROO port: <ul style="list-style-type: none"> [Function]: [No] [ROO] [RPO] [Building alarm][Forced bypass] [On generator] [Remote shutdown] [Delay]: [0s] ... [999s] [Active]: [Open] [Closed] 	ROO port: [No] [0s] [Closed]
	RPO port: <ul style="list-style-type: none"> [Function]: [No] [ROO] [RPO] [Building alarm][Forced bypass] [On generator] [Remote shutdown] [Delay]: [0s] ... [999s] [Active]: [Open] [Closed] 	RPO port: [No] [0s] [Open]
	DB9-4 port: <ul style="list-style-type: none"> [Function]: [No] [ROO] [RPO] [Building alarm][Forced bypass] [On generator] [Remote shutdown] [Delay]: [0s] ... [999s] [Active]: [Low] [High] 	DB9-4 port: [No] [0s] [High]
Outputs signals [Relay1][Relay2][DB9-1] [DB9-7] [DB9-8] Sets events or fault that will actuate Output signal parameters through external contact connector or RS232 port	[Relay1] [Relay2]: [Function]: [On bat] [Low bat] [Bat fault] [Bypass] [UPS OK] [Load protected] [Load powered] [General alarm] [OVL pre-alarm] [Batt Disconn] [Active]: [Closed] [Open]	[Relay1]: [Bypass] [Closed] [Relay2]: [Bat fault] [Closed]
	[DB9-1] [DB9-7] [DB9-8] : [Function]: [On bat] [Low bat] [Bat fault] [Bypass] [UPS OK] [Load protected] [Load powered] [General alarm] [OVL pre-alarm] [Batt Disconn] [Active]: [High] [Low]	[DB9-1]: [Low bat] [High] [DB9-7]: [UPS OK] [High] [DB9-8]: [Onbat] [High]
Remote command	[Yes] [No] If yes, shutdown or restart commands from software are authorized.	[Yes]
Shutdown commands [Send CMD] [Output OFF] [OFF delay] [Restart] Sets events or fault that will actuate Output signal parameters through external contact connector or RS232 port	[Send CMD]: [Yes] [No]	[No]
	[Output OFF]: [No] [UPS] [Group 1] [Group 2] [Group 1 + 2]	[No]
	[OFF delay]: [0s] ... [65534s] For a proper server shutdown please make sure that the Output OFF delay is long enough	[0s]
	[Restart]: [Yes] [No]	[Yes]
On battery notice delay	[0s] ... [99s] Sets delay before providing an on battery notice to software.	[0s]
General alarm	[On battery] [Battery fault] [Overload pre-alarm] [Internal fault] [Ambient temp.] [Fan lock] [Bypass overload] [Current limit] [Short circuit] [Inverter overload] [Power overload] [Low battery] [On Bypass] [UPS OK] [Load protected] [Load powered] [Ext Charg. on] Defines which event or fault will generate a general alarm through Output signal screen.	[Internal fault]
Set Comm Card 1/Card2 IPv4	[DHCP] : [Yes] [No] [IP Adress] [Subnet mask] [Gateway] The UPS does not display the IPv4 settings menu by default, you can activate it by a communication command.	[Yes] XXX.XXX.XXX.XXX

5.5 Communication ports

Communication cards

Communication cards allow the UPS to communicate in a variety of networking environments and with different types of devices. The Eaton 9PX Gen2 models have one available communication bay for the following connectivity cards:

- **Gigabit Network card (Network-M3):** provides a Gigabit Ethernet connection and enables secure UPS monitoring over HTTPS web browser interface, SNMP v1/v3 protocol and email alarms. In addition, up to 3 Environmental Monitoring Probes can be attached to obtain humidity, temperature, smoke alarm, and security information.
- **Industrial Gateway card (INDGW-M3):** Provides Modbus RTU and Modbus TCP communication support in addition to the same secure UPS monitoring, management and sensor capability as the Gigabit Network card.
- **Relay-MS card:** provides isolated dry contact (Form-C) relay outputs for UPS status: Utility failure, Battery low, UPS alarm/OK, or on Bypass.
- **INDRELAY-MS:** The Industrial relay Card-MS (INDRELAY-MS) provides a simple way to remotely input UPS information to an alarm system, PLC or a computer system via dry contacts. It offers five isolated dry contact outputs and one isolated dry contact input.

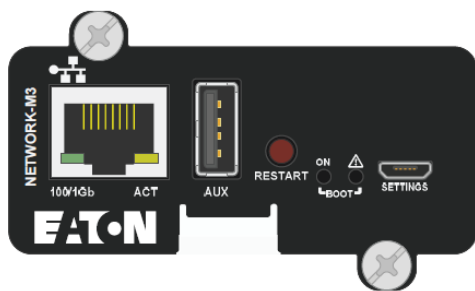

NETWORK-M3 Card

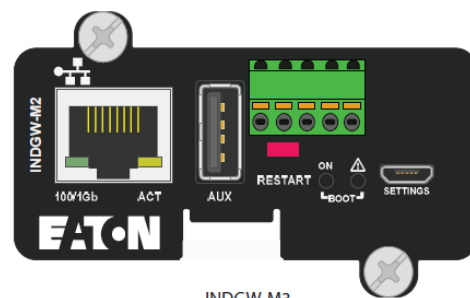

INDGW-M3

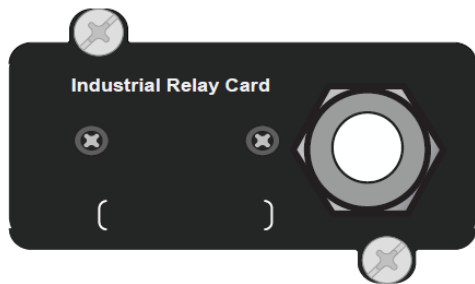

INDRELAY-MS



Relay-MS Card

Characteristics of the contact RS232 communication port

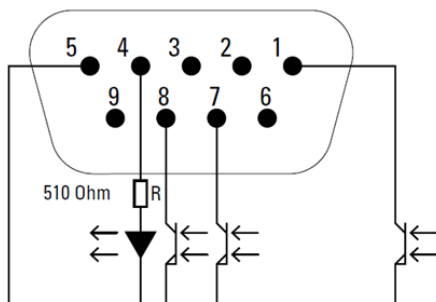

Contact characteristics (optocoupler):

- Voltage: 48 V DC max
- Current: 25 mA max
- Power: 1.2 W

Pin	Signal	Direction	Function
1	Bat low	Output	Low Battery Output
2	TxD	Output	Transmit to external device
3	RxD	Input	Receive from external device
4	I/P SIG	Input	-
5	GNDS	-	Signal common tied to chassis
6	NC		Not Connected
7	UPS OK	Output	UPS OK
8	BAT mode	Output	UPS on battery mode
9	Not used	-	Not used

Connection of RS232/USB communication port

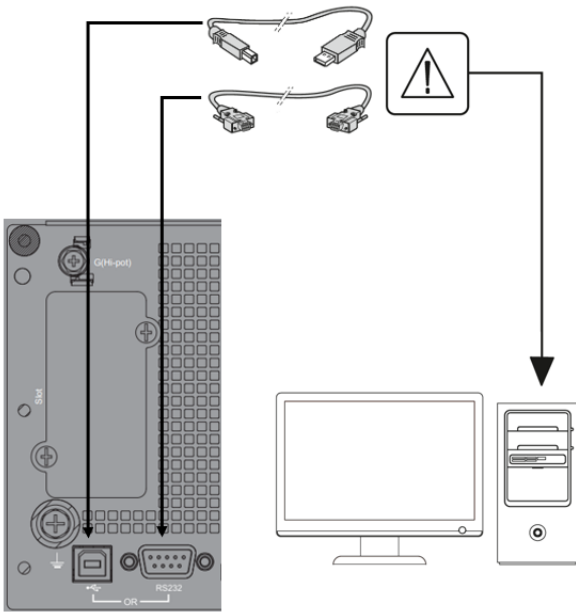

1. Connect the RS232 (DB9) or USB communication cable to the serial or USB port on the computer equipment.
2. Connect the other end of the communication cable to the USB or RS232 (DB9) communication port on the UPS

i The UPS can now communicate with Eaton power management software.

You can improve the remote monitoring and power management of the UPS by adding a communication card compatible with the product.

Installation of the communication cards

6000 VA

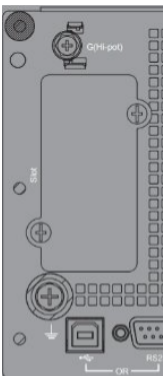

8000 / 11000 VA

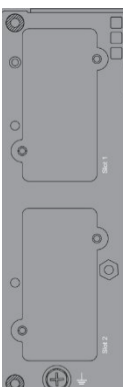

The UPS is delivered with a Network-M3 card already mounted in the slot 1.

If you need to change the card or to add a second communication card (for 8000VA and 11000VA only, a second slot is available), follow the below instructions:

It is not necessary to shutdown the UPS before installing a communication card.

1. Remove the slot cover secured by screws.
2. Insert the communication card in the slot.
3. **Secure the card cover with the two screws to connect the comm card to the ground.**

5.6 UPS remote control functions

Programmable signal inputs

The Eaton 9PX Gen2 incorporates several programmable signal inputs: one Remote Power Off (RPO) input terminal, one Remote On/Off (ROO) input terminal, one RS-232 input (pin-4).

Signal inputs can be configured (see Settings > Comm settings > Signal Input) to have one of the following functions.

⚠ Signal inputs have no function by default; please choose a function through the LCD (Settings > Com settings > Input signals).

Function	Description
No	No function. (Please choose a function if you want to use input signal.)
RPO	Remote Power off (RPO) is used to shutdown the UPS remotely.
ROO	Remote On/Off allows remote action of a button or other interface to switch On/Off the UPS. (Cold start is prohibited while using the ROO function.)
Forced Bypass	If feeding the load the unit goes to bypass operation and stays there regardless of the bypass state until the input is inactivated.
Building alarm	Active input generates an alarm “building alarm”.
On generator On generator	Active input disables synchronization and disable bypass output.
Shutdown commands	Active input turns UPS output (or outlet groups) off after a user defined shutdown delay but keeps on charging batteries according to a selected charging scheme; inactive input does not abort shutdown countdown. Depending on the “Restart” parameter (see Settings > Comm Settings > Shutdown commands) the unit may startup automatically.

Remote Power Off (RPO)

RPO is used to shutdown the UPS remotely when the contact is open. This feature can be used for shutting down the load and the UPS by thermal relay, for example, in the event of room over temperature. When RPO is activated, the UPS turns off the output and shuts down all power converters immediately (except for logic power). The UPS remains "ON" to alarm the fault.

The RPO circuit is a safety extra low voltage (SELV) circuit. This circuit must be separated from any hazardous voltage circuits by reinforced insulation.

- The RPO must not be connected to any utility connected circuits. Reinforced insulation to the utility is required. The RPO switch must be a dedicated latching-type switch not tied into any other circuit. The RPO signal must remain active for at least 250 ms for proper operation.
- To ensure the UPS stops supplying power to the load during any mode of operation, the input power must be disconnected from the UPS when the Remote Power Off function is activated.

i Leave the RPO connector installed in the RPO port on the UPS even if the RPO function is not needed.

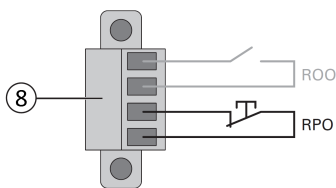

RPO	Comments
Connector type	Terminal, 14 AWG Maximum wires
Terminal rating	60 V DC/30 V AC 20 mA max

Contact open: shut down of UPS.

To return to normal operation, deactivate the external remote shut down contact and restart the UPS from the front panel.

Remote control connection and test

⚠ This connector must only be connected to SELV (Safety Extra-Low Voltage) circuits.

1. Check the UPS is shut down and the electrical supply network disconnected.
2. Remove RPO connector from the UPS by removing the screws.
3. Connect a normally closed volt-free contact between the two pins of connector.
4. Plug the RPO connector into the back of the UPS and fix the screws.

5. Connect and restart the UPS according to the previously described procedures.
6. Activate the external remote shut down contact to test the function.

i Always test the RPO function before applying your critical load to avoid accidental load loss.

Remote On/Off (ROO)

- Remote On/Off allows remote action of button to switch On/Off the UPS.
- When contact changes from open to closed, the UPS is switched-on (or stays On).
- When contact changes from closed to open, the UPS is switched-off (or stays Off).
- On/Off control via button has priority over the remote control.

i The ROO function is only active after the first use of the "Remote OFF" function.

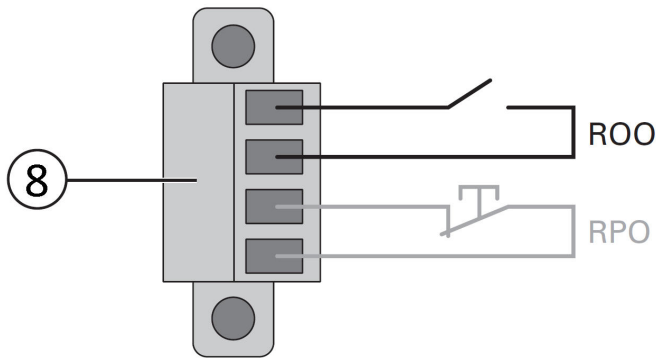

ROO	Comments
Connector type	Terminal, 14 AWG Maximum wires
Terminal rating	60 V DC/30 V AC 20 mA max

Programmable signal outputs

The Eaton 9PX Gen2 incorporates several programmable signal outputs: one relay output and two optocoupler outputs (DB9 pins 1 and 8). Signal outputs can be configured (see Settings > Comm settings > Output Signals) to report the following information:

Signal	Default assignment	Description
On battery (On Bat)	DB9-Pin 8	UPS is in battery mode
Low battery (Low Bat)	DB9-Pin 1	UPS is in battery mode and has reached the low battery alarm threshold
Battery fault	OUT (Relay2)	Battery fault
UPS OK	DB9-Pin 7	Load is powered with no alarm (from inverter or bypass)
Load protected	-	UPS is on inverter, with no alarm and ready to go to battery
Load powered	-	Load is powered (from inverter or bypass)
General alarm	-	Choose events that will trigger this alarm through the LCD (Settings > Comm settings > General alarm). For more information on possible events please look at User settings
OVL pre-alarm	-	Overload pre-alarm
Bat disconn	-	Battery is disconnected
Bypass	Relay (Relay1)	UPS is operating in Bypass mode

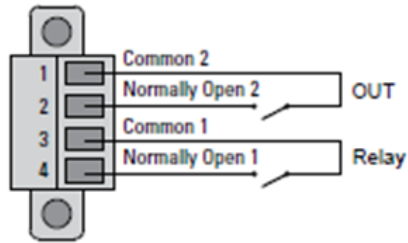

5.7 Eaton Intelligent Power Software suite

Eaton Intelligent Power Software suite is available from eaton.com/downloads.

Eaton Software suite provides up-to-date graphics of UPS power and system data and power flow.

It also gives you a complete record of critical power events, and it notifies you of important UPS or power information. If there is a power outage and the UPS battery power becomes low, Eaton Software suite can automatically shut down your computer system to protect your data before the UPS shutdown occurs.

5.8 BMS

The BMS (Battery Management System) continuously monitors battery health, temperature, and charge/discharge cycles to ensure safe and efficient operation. It provides automatic addressing and communication with the UPS for predictive maintenance and life-cycle management, helping extend battery life and prevent faults.

5.9 Cybersecurity

Eaton is committed to minimizing the Cybersecurity risk in its products and employs cybersecurity best practices and the latest cybersecurity technologies in its products and solutions, making them more secure, reliable and competitive for our customers. Eaton also offers Cybersecurity Best Practices whitepapers to its customers, referenced at www.eaton.com/cybersecurity.

6 Operation

6.1 Start-up and normal operation

 Check that the indications on the name plate located on the back of the UPS meets to the AC power source and the true electrical consumption of the total load.

Battery charge





The UPS charges the battery as soon as it is connected to the AC outlet, whether the ON/OFF button is pressed or not. It is recommended that the UPS be permanently connected to the AC power supply to ensure the best possible autonomy. When used for the first time, the battery will provide its maximum autonomy after it has been charged for eight hours.

To start the UPS

 On the first startup of the UPS, you will need to configure the output voltage and time of the UPS.

Verify that the UPS power cord is plugged in.

The UPS front panel display illuminates and shows Eaton logo.

1. Verify that the UPS status screen shows .
2. Press the  button on the UPS front panel for at least a few seconds.
3. Check the UPS front panel LED for active alarms or notices. Resolve any active alarms before continuing; if the  indicator is on, do not proceed until all alarms are clear (see "[Troubleshooting](#)" section). Check the UPS status from the front panel to view the active alarms. Correct the alarms and restart if necessary.
4. Verify that the  indicator illuminates solid, indicating that the UPS is operating normally and any loads are powered and protected. The UPS should be in Normal mode.

AC-power disturbance

If AC power is disturbed or fails, the UPS continues to operate on battery power. UPS power button flashes green. In battery mode, the audio alarm beeps every five seconds, then every two seconds when the end of battery backup time is near.



If the power outage lasts longer than the battery backup time, the UPS shuts down and automatically restarts when power is restored. Following a complete discharge, at least 48 hours are recommended to recharge the battery back to full backup time.

To extended battery runtime for critical devices, it is possible to program sequenced shutdown (also known as load shedding) of less-critical loads connected to Group 1 or Group 2 outlets during extended power outages.

6.2 Starting the UPS on battery

i Before using this feature, the UPS must have been powered by utility power with output enabled at least once. Battery start can be disabled. See the "Cold start" setting in "ON/OFF Settings".

To start the UPS on battery:

1. When the UPS is disconnected from the AC power source, press the  button on the UPS front panel. The UPS transfers from Standby mode to Battery mode. The indicator  illuminates solid. The indicator  blinks and the buzzer snoozes. The UPS supplies power to your equipment
2. Check the UPS front panel display for active alarms or notices besides the "Battery mode" and related notifications that indicates missing utility power. Resolve any active alarms before continuing. See "Troubleshooting". Check the UPS status from the front panel to view the active alarms. Correct the alarms and restart if necessary.

6.3 Starting the UPS with HotSwap MBP

! Verify that the total equipment ratings do not exceed the UPS capacity to prevent an overload alarm.

1. Check that the UPS is correctly connected to the HotSwap MBP.

! **If the UPS is equipped with outlets**, those outlets can no longer be used (loads can only be connected to the MBP outlets or the MBP Output terminal blocks)

2. Verify that the MBP terminal blocks are connected to the AC source.
3. Check that the MBP manual Bypass switch is to the "**Bypass**" position.



4. Set the upstream circuit breaker (not provided) to the "I" (On) position to switch on the utility power.
5. Verify that the "**Bypass mode**" red light of the MBP goes On, indicating that the load is now powered by the AC source.
6. Set the Normal AC source switch of the MBP to the "I" (On) position.
7. Verify that the UPS is correctly powered (UPS display panel illuminates).
8. Press the UPS "**ON**" button to start the UPS.
9. Put the UPS in "**Bypass mode**" ("**Control -> Go to bypass**").

10. Verify that the UPS is on Bypass mode by checking UPS display panel.
11. Verify that the **"UPS mode" green light** of the MBP goes On, indicating that the UPS output power is available on the MBP.

Important: do not continue to next step if the **"UPS mode" green light** of the MBP is still Off (the load will be lost).

12. Set the MBP manual Bypass switch to the **"UPS" position**: the **"Bypass mode" red light** of the MBP goes Off, indicating that the load is now powered by the UPS.

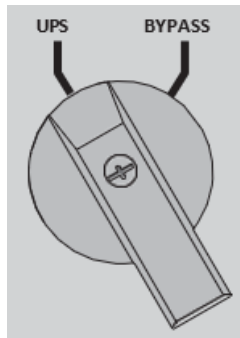

13. Put the UPS in **"Normal mode"**. ("Control -> Go back normal")
14. Check that the UPS is in normal mode by checking UPS display panel. The load is now protected by the UPS.

6.4 UPS shutdown

To shut down the UPS:

Press the  button on the front panel for two seconds.

confirmation message will appear. When confirmed, the UPS starts to beep and shows a status of "UPS shutting OFF...". The UPS then transfers to Standby mode, and the  indicator turns off.

UPS starts to beep and indicator is blinking. The UPS then transfers to Standby mode, and the indicator turns off.

6.5 Operating modes

The Eaton 9PX Gen2 front panel indicates the UPS status through the UPS indicators located above the LCD screen .

Normal mode

When the green  symbol is illuminated, the UPS is providing protected AC power output. The LED bar is illuminated in static blue. The UPS monitors and charges the batteries as needed and provides power protection to your equipment.

Optional High Efficiency and Energy Saving settings minimize heat contribution to the rack environment. See user settings.

Battery mode

When the UPS is operating during a power outage, the alarm beeps once every ten seconds and the indicator  illuminates solid.

The LED bar is flashing blue.

The necessary energy is provided by the battery.

When the utility power returns, the UPS transfers to Normal mode operation while the battery recharges.

If battery capacity becomes low while in Battery mode, the audible alarm beeps faster.

This warning is approximate, and the actual time to shutdown may vary significantly; shutdown all applications on connected equipment due to imminent UPS shutdown.

When utility power is restored after the UPS shuts down, the UPS automatically restarts.

Low-battery warning

- The  indicator illuminates solid.
- The audio alarm beeps every three seconds.

- The LED bar illuminates red

The remaining battery power is low. Shut down all applications on the connected equipment because automatic UPS shutdown is imminent.

End of battery backup time

- LCD displays "End of backup time".
- All the LEDs go OFF.
- The audible alarm stops.

Bypass mode

In the event of a UPS overload or internal failure, the UPS transfers your equipment to utility power. Battery mode is not available and your equipment is not protected; however, the utility power continues to be passively filtered by the UPS. The by-pass indicator illuminates in orange.

Depending on overload conditions, the UPS remains in Bypass mode for at least five seconds and will stay in this mode if three transfers to Bypass occur within 20 minutes.

The UPS transfers to Bypass mode when:

- the user activates Bypass mode through the front panel,
- the UPS detects an internal failure,
- the UPS has an overtemperature condition,
- the UPS has an overload condition listed.

The UPS shuts down after a specified delay for overload conditions listed.

6.6 Configuring battery settings

Automatic battery test

Automatic battery tests are disabled by default as battery is monitored by the BMS . The tests frequency can be modified to "Monthly" .

During the test, the UPS transfers to Battery mode and discharges the batteries for 10 seconds under load.

Battery mode is not displayed, and battery low alarm is not activated during a battery test.

The battery test may be postponed due to bad conditions or failed if battery is not ok.

Low battery warning

During discharge, the low battery alarm is activated if the remaining runtime goes below 3 minutes or less than the setting capacity threshold (10% by default or set to 20% by default by the Network Management card NM3).

This threshold can be modified.

External battery setting

The maximum number of Extended Battery Module is 10 .

6.7 Setting high efficiency mode

In High Efficiency mode, the UPS operates normally on Bypass and transfers to Online (or Battery) mode in less than ten ms when utility fails. Transfers to High Efficiency mode will be active after five minutes of Bypass voltage monitoring: if Bypass quality is not in tolerance, then the UPS will remain in Online mode.

 Eaton recommends to use the HE mode only to protect IT equipment.

To set the High Efficiency mode:

1. Select Settings, In/Out settings, and High Efficiency mode.
2. Select Enabled and Enter to confirm.
3. The UPS transfers to High Efficiency mode after five minutes.

6.8 Return of AC input power

Following an outage, the UPS restarts automatically when AC input power returns (unless the restart function has been disabled) and the load is supplied again.

6.9 Battery wiring connection detection

This feature is designed to detect whether the battery power cable or DC breaker is properly connected. The detection can be performed automatically every hour or initiated manually by the user.

If the “Battery Bad wiring” alarm is displayed, verify that the battery power cable and the DC breaker are correctly connected. After restoring the battery cable or DC breaker, the warning can be cleared automatically or manually with BMS auto setup.

If an alarm persists for an extended period, the battery will enter in forced sleep mode to conserve power.

To restore operation:

1. Wake up the BMS using the LCD panel. Navigation: *Control – Functions reset – Wakeup BMS.*
2. Perform manual addressing after the BMS is active. Navigation: *Control – Functions reset – BMS Auto Setup.*

6.10 Transportation mode

This feature is designed to extend the battery storage time.

Batteries are shipped in transportation mode by default. The battery is in deep sleeping and cannot discharge externally. Once the UPS connects to the mains and establishes communication with the battery, it will exit transport mode after 3 minutes.

Users can set the battery to transport mode via the LCD menu. Navigation: *Control – Functions reset – Set transportation mode.*

After the UPS shuts down for a period, the BMS will enter transport Mode. The typical duration is approximately 12 minutes.

7 UPS maintenance

7.1 Equipment care

Keep the area around the equipment clean and dust free.

Thanks to the lithium batteries, the product's lifespan does not require preventive maintenance. Therefore, there are no serviceable parts.

For full battery life, keep the equipment at an ambient temperature of 25 °C (77 °F).

The batteries are rated for a 8-10 years service life. The length of service life varies, depending on the frequency of usage and ambient temperature .

If the UPS requires any type of transportation, verify that the UPS is turned off.

Batteries used beyond expected service life will often have severely reduced runtimes.

Batteries runtime will be reduced at low temperature (below 10 °C).

7.2 Storing the equipment

If you store the equipment for a long period, recharge the battery every 6 months by connecting the UPS to utility power. The internal batteries charge to 90% capacity in less than 3 hours. However, Eaton recommends that the batteries charge for 48 hours after long-term storage.

Check the battery recharge date on the shipping carton label. If the date has passed and the batteries were never recharged, do not use them. Contact your service representative.

7.3 Battery State Of Health (SOH)

Overview

The **State of Health (SOH)** is a key metric used to assess the condition of lithium batteries over time. It reflects the battery's ability to deliver performance and runtime compared to its original specifications. SOH is expressed as a percentage, where 100% represents a new battery operating at full nominal capacity.

As the battery ages or undergoes repeated charge/discharge cycles, its SOH decreases. This reduction impacts the **runtime** of the system. To assist users in monitoring battery health, the system displays one of three pop-up messages based on the current SOH level.

Pop-up message logic

SOH Level	Status	Description
>= 90%	Healthy	Battery is performing optimally. Full runtime and performance are available.
70% – 89%	Normal	Battery is functioning within acceptable limits. Runtime may be slightly reduced.
<= 70% (low)	Warning	Battery performance and runtime are significantly lower than nominal. However, the UPS remains operational.

Important Notes

- **Even in the Warning state**, the UPS can still be used safely. The system will continue to operate, but users should expect **shorter runtimes** and **reduced peak performance**.
- The SOH status is monitored continuously by the **Battery Management System (BMS)**, which helps detect degradation early and supports proactive maintenance planning.
- Users are encouraged to contact Eaton support when SOH drops below 70%, especially in critical applications where full runtime is required.
- Pop up message is given for a single battery pack or EBM. To find out which battery pack/EBM is affected by the message, you need to check the BMS information menu.

User Guidance

- **Healthy (SOH > 90%)**: No action needed. System is operating at full capacity.
- **Normal (SOH 70–89%)**: Monitor performance.
- **Warning (SOH < 70%)**: Continue using the UPS if needed, but prepare for replacement to avoid unexpected downtime.

7.4 When to replace Lithium batteries

Eaton 9PX G2 Lithium 5P Gen2 Lithium batteries have an expected life span of 8-10 years.

 Contact your service representative before ordering new batteries.

Preventive Mode

After x years of operation (defined by the user, refer to “Battery settings” menu), the UPS will provide a battery replacement notification. You should take proactive steps to ensure you replace your batteries for optimal operation and reliability.

Predictive Mode (BMS Monitoring)

This is default mode for Lithium UPS. Based on real UPS usage condition, the battery health is monitored by the BMS. When SOH is <70%, "Battery Status" will change from "Normal" to "Warning".

Note: You can refer to chapter “Battery State Of Health” for more information about SOH.

Before ordering new batteries, you are advised to contact Eaton support to take appropriate action to help you keeping the UPS operating at its best performance.

Battery reference can be accessed through the LCD (Measurement > Battery).

UPS internal battery reference is

6K: EBP-1806-L

8K/11K: EBP-1806-L*2

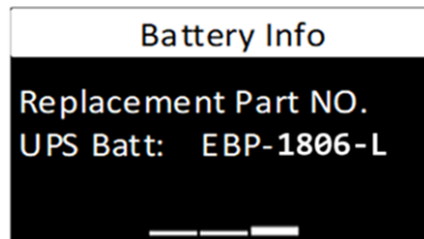

If the UPS is used with EBM, "Change EBM" is displayed on the LCD:

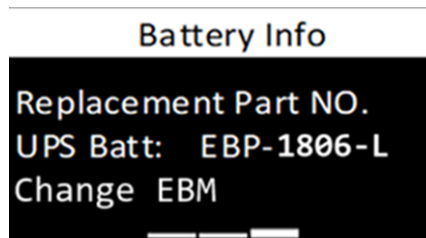



7.5 Replacing Lithium batteries

General instructions

For battery replacement, follow instructions provided on Eaton webpage: www.eaton.com/UPSservices.

- Internal battery pack can be replaced by **skilled person** with sufficient knowledge of batteries without turning off the UPS or disconnecting the load. UPS must operate in internal or external bypass mode.
- Internal battery pack can be replaced by **ordinary person** with sufficient knowledge of batteries when UPS is turned OFF and disconnected from the mains.

  A Phillips head screwdriver is needed to perform this procedure - **Do not unscrew another kind of screw.**

 Hazardous Voltage is present in the battery pack even not connected - **Do not open the battery pack.**

 The internal battery pack is heavy - **Handling with care or appropriate tools**

Consider all warnings, cautions, and notes before replacing batteries.

- Replace with the same type and number of batteries or battery packs. Contact your service representative to order new batteries.
- Batteries can present a risk of electrical shock or burn from high short circuit current.
- Do not wear any metal objects including watches and rings.
- Do not lay tools or metal parts on top of batteries.
- Proper disposal of batteries is required. Refer to your local codes for disposal requirements.
- Do not dispose of batteries in a fire. When exposed to flame, batteries may explode.
- Do not open or mutilate the battery or batteries.
- Determine if the battery is inadvertently grounded. If inadvertently grounded, remove source from ground. Contact with any part of a grounded battery can result in electrical shock.
The likelihood of such shock can be reduced if such grounds are removed during installation and maintenance (applicable to equipment and remote battery supplies not having a grounded supply circuit).
- ELECTRIC ENERGY HAZARD. Do not attempt to alter any battery wiring or connectors. Attempting to alter wiring can cause injury.
- Failed batteries can reach temperatures that exceed the burn thresholds for touchable surfaces.

 If UPS is not switch OFF, it is mandatory to activate the "Bypass mode" before performing the following steps. ("Control -> Go to bypass").

Follow the steps below to replace the batteries of your equipment

6000 VA

8000 / 11000 VA

Pull off the front panel.

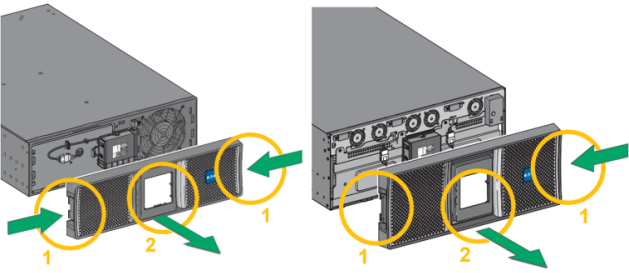

Remove the protection cover in front of the battery

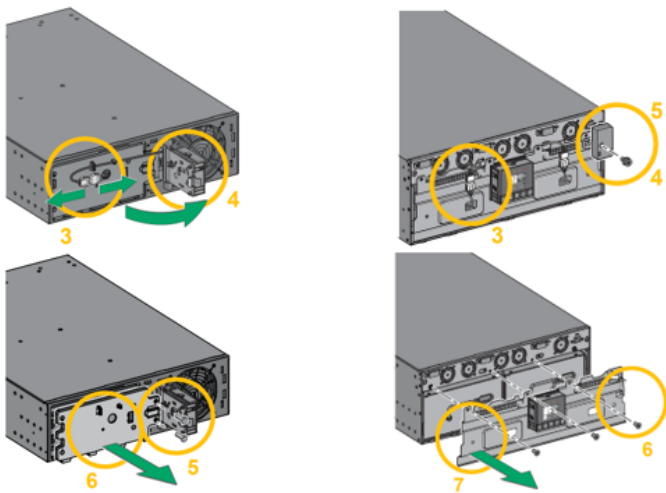

Remove the battery pack.

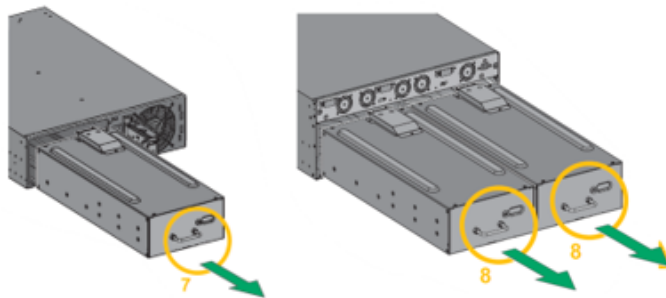

Put the new battery pack into the UPS. Push the battery pack firmly to ensure a proper connection.

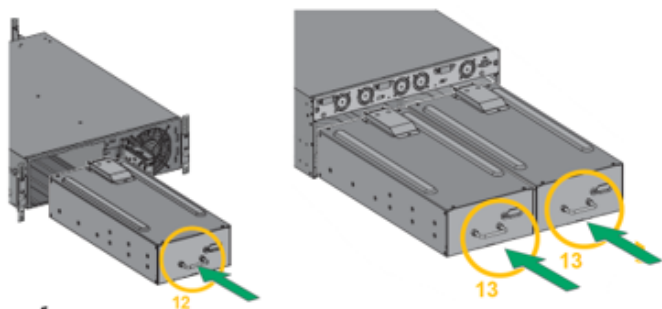

Screw back the metal protection cover.

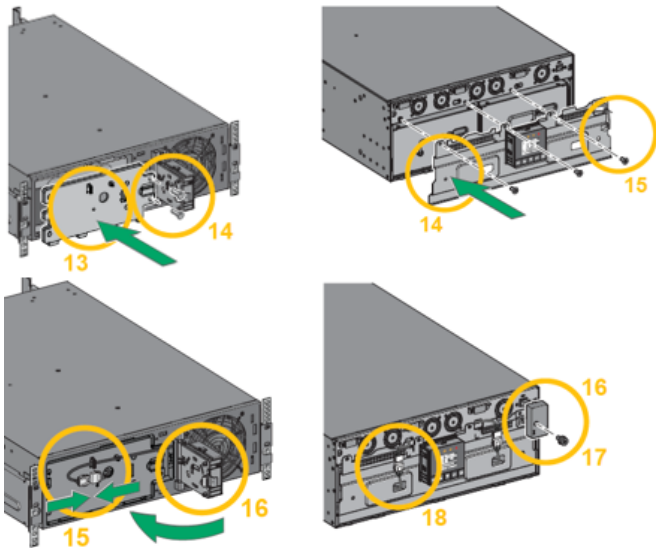

Setting and final check of the battery replacement

1. If not automatically detected, set the new battery in settings.
2. Charge the batteries for 48 hours.
3. Start a battery test following the screen instructions.

Once the batteries have been replaced, click next, it displays this pop up message



Click next. It Updates the settings



For information, when “Update settings” it:

1. Reset LCM battery life warning (preventive mode) to 96 months,
2. Reset battery parameter if necessary
3. Clear battery fault/alarms
4. Re-enable charger.

In the “Control Menu” select “Function reset”, then press “BMS Auto Setup”.
The following message box is displayed, click on “Yes”:

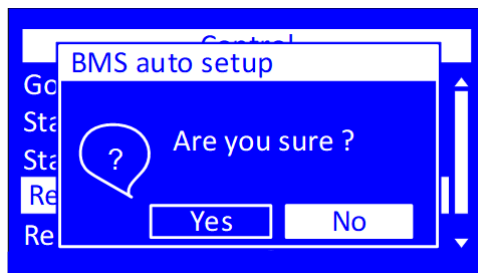

Press the On-button or in control menu, “Go back normal”

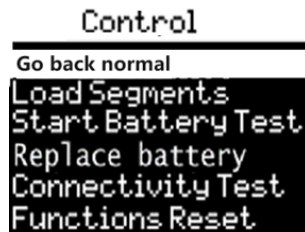

Once come back to Online mode successfully, test new batteries

To test new batteries :

1. Press ENTER to activate the menu options.
2. Select Control then Start battery test. The UPS starts a battery test if :
 - the batteries are enough charged, at least 10% SOC,
 - load is at least 10% of the rated capacity,
 - the UPS is in Normal mode with no active alarms,
 - BMS status is normal, without protection or fault,
 - no overload,
 - output load is stable.

During the battery test, the front panel displays "Battery test in progress" and the percentage of the test completed.

When the test is completed, the following screen should be displayed :



7.6 Lithium Battery Settings Reset

After replacement of the internal UPS Lithium batteries and extended battery modules the “BMS auto setup” and “Reset battery life” setting will need to be reset in the “Control” menu of the display.

1. Press the xxx button on the main display.
2. Press the xxx button to display the “Control” option. Press xxx.
3. Press the xxx button to display the “BMS auto setup” or “Reset battery life” option of the control menu. Press the xxx button and use the xxx to select “Yes”. Press the button xxx to reset.

7.7 UPS replacement with HotSwap MBP

 Go to maintenance Bypass operation (please follow the MANDATORY steps below)

MBP6K208G2 and MBP6KIECG2:

1. Put the UPS in “**Bypass mode**” (“Control -> Go to bypass”)



2. Verify that the UPS is on Bypass mode by checking UPS display panel
3. Set the MBP manual Bypass switch to “Bypass” position. The “Bypass mode” red light of the MBP goes On, indicating that the load is supplied directly by AC source

4. Switch the Normal AC source switch of the MBP to the "0" position and wait 30 seconds
5. UPS stops, the UPS can now be disconnected, as described below:

- First disconnect the I/O cord Set from the MBP:

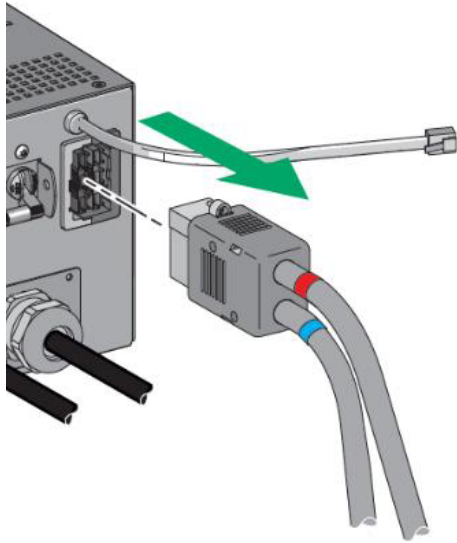

- ⚠ After opening the UPS I/O terminal blocks cover, check if hazardous voltage is no longer present on UPS terminal blocks by using a Voltage Absence Tester.

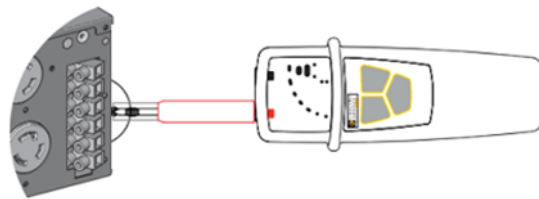

- Disconnect the 2 power cables of the MBP I/O cord Set, and the MBP detection cable.
- Replace the UPS.

⚠ Hazardous voltage and lost load risk: do not manipulate the MBP manual Bypass switch without UPS connected via the I/O cord Set.

MBP11K208G2:

1. Put the UPS in **"Bypass mode"** (**"Control -> Go to bypass"**)



2. Verify that the UPS is on Bypass mode by checking UPS display panel
 3. Set the MBP manual Bypass switch to **"Bypass"** position. The **"Bypass mode" red light** of the **MBP** goes On, indicating that the load is supplied directly by AC source
 4. Switch the Normal AC source switch of the MBP to the "0" position and wait 30 seconds
 5. UPS stops, the UPS can now be disconnected, as described below:
- First lock the Normal AC source switch of the MBP to the "0" position (the switch protection frame is able to fit a cable tie or a metallic locker).

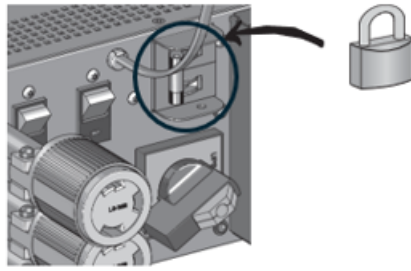

- ⚠ After opening the I/O terminal blocks cover of UPS, check if hazardous voltage is no longer present on UPS terminal blocks by using a Voltage Absence Tester.

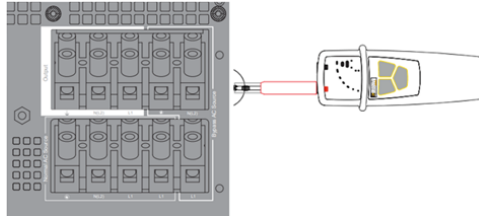

- Disconnect the MBP conduits, and the MBP detection cable.
- On both MBP conduits just disconnected from the UPS, link the internal wires together (line 1 and line 2 wires linked to ground wire).

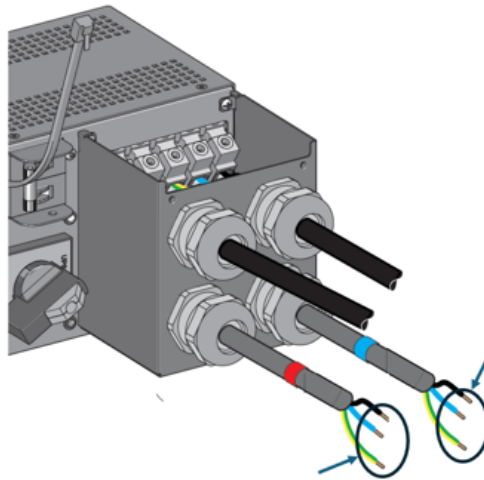

- Replace the UPS

- ⚠ Hazardous voltage and lost load risk: do not manipulate the MBP manual Bypass switch without UPS connected to the MBP power conduits.

Return to normal operation:

1. Check that the new UPS is correctly connected to the MBP, as described below:

MBP6K208G2 and MBP6KIECG2:

- ⚠ After opening the UPS I/O terminal blocks cover, connect to UPS the 2 power cables, and the MBP detection cable, of the MBP I/O cord Set
- Connect the I/O cord Set connector to the MBP.

MBP11K208:

- First check that the Normal AC source switch of the MBP is still locked to the "0" position
 - Remove the previously installed safety wires links on both MBP conduits
 - After opening the UPS I/O terminal blocks cover, connect to UPS the MBP conduits, and the MBP detection cable
 - Unlock the Normal AC source switch of the MBP
2. Set the Normal AC source switch of the MBP to the "I" (On) position.
 3. Verify that the UPS is correctly powered (UPS display panel illuminates)
 4. Press the UPS **"ON"** button to start the UPS

5. Put the UPS in "**Bypass mode**" ("Control → Go to bypass)
6. Verify that the UPS is on Bypass mode by checking UPS display panel
7. Verify that the "**UPS mode**" **green light** of the MBP goes On, indicating that the UPS output power is available on the MBP.

⚠ Important: do not continue to next step if the "UPS mode" green light of the MBP is still Off (the load will be lost)

8. Set the **MBP** manual Bypass switch to the "**UPS**" **position:** the "**Bypass mode**" **red light** of the MBP goes Off, indicating that the load is now powered by the UPS:
9. Put the UPS in "**normal mode**" (refer to the UPS User Manual)

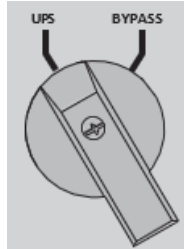

10. Check that the UPS is in Online mode by checking UPS display panel the load is now protected by the UPS

7.8 UPS maintenance with HotSwap MBP

⚠ Go to maintenance Bypass operation (please follow the MANDATORY steps below)



1. Put the UPS in "**Bypass mode**" ("Control → Go to bypass"),
2. Verify that the UPS is on Bypass mode by checking UPS display panel,
3. Set the MBP manual Bypass switch to "**Bypass**" **position.** The "**Bypass mode**" **red light** of the MBP goes On, indicating that the load is supplied directly by AC source,
4. Proceed to maintenance operations on UPS.

Return to normal operation:

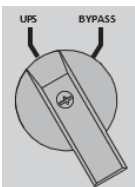

1. Verify that the UPS is on Bypass mode by checking UPS display panel,
2. Verify that the "**UPS mode**" **green light** of the MBP is On, indicating that the UPS output power is available on the MBP,

⚠ Caution: do not continue to next step if the "UPS mode" green light of the MBP is Off (the load will be lost)

3. Set the MBP manual Bypass switch to the "**UPS**" **position:** the "**Bypass mode**" **red light** of the MBP goes Off, indicating that the load is now powered by the UPS,
4. Put the UPS in "**normal mode**"
5. Check that the UPS is in Online mode by checking UPS display panel the load is now protected by the UPS

7.9 Recycling the used equipment

Contact your local recycling or waste center for information on proper disposal of the used equipment. [eaton.com/recycling](https://www.eaton.com/recycling).



Do not dispose of the battery or batteries in a fire, they may explode. Proper disposal of batteries is required, refer to your local codes for disposal requirements.

Do not open or mutilate the battery or batteries, released electrolyte is harmful to the skin and eyes. It may be toxic.



Li-ion

This symbol indicates that you should not discard the UPS or the UPS batteries in the trash. This product contains sealed, Lithium-Ion batteries and must be disposed of properly. For more information, contact your local recycling/reuse or hazardous waste center.



Do not discard waste electrical or electronic equipment (WEEE) in the trash. For proper disposal, contact your local recycling/reuse or hazardous waste center.

8 Troubleshooting

The Eaton 9PX Gen2 is designed for reliable, autonomous operation while providing you with notifications and alerts whenever a potential operational or performance issue occurs.

Usually the alarms shown by the product do not mean that the output power is affected. Instead, they are preventive alarms intended to alert the user.

- Some alarms may be announced by a beep in a regular way. Example = "Battery low".
- Faults are announced by a continuous beep and red LED.







Use the following troubleshooting chart to determine the UPS alarm condition.

8.1 Typical alarms and faults

To check the Event log or Fault log:

1. Press any button on the front panel display to activate the menu options.
2. Press the down button to select Event log or Fault log.
3. Scroll through the listed events or faults.

The following table describes typical conditions:

Conditions	Possible cause	Action
Battery mode  LED is On 1 beep every 10 seconds	A utility failure has occurred and the UPS is in battery mode.	The UPS is powering the equipment with battery power. Prepare your equipment for shutdown.
Battery low  LED is On 1 beep every 3 seconds	The UPS is in Battery mode and the battery is running low.	This warning is approximate, and the actual time to shutdown may vary significantly. Depending on the UPS load and number of Extended Battery Modules (EBMs), the "Battery Low" warning may occur before the batteries reach 20% capacity.
No battery  LED is On Beep continuous	The batteries are disconnected or all battery communication is lost.	Verify that all batteries are properly connected. If the condition persists, contact your service representative.
Battery fault  LED is On Beep continuous	The battery test is failed due to bad or disconnected batteries.	Verify that all batteries are properly connected. If the condition persists, contact your service representative.
The UPS does not provide the expected backup time.	The batteries need charging or service.	Apply utility power for 48 hours to charge the batteries. If the condition persists, contact your service representative.
Bypass mode  LED is on.	An overload or a fault has occurred, or a command has been received and the UPS is in Bypass mode.	Equipment is powered but not protected by the UPS. Check for one of the following alarms: overtemperature, overload or UPS failure.
Power Overload  LED is On	Power requirements exceed the UPS capacity (greater than 100% of nominal; see "User Settings" for specific output overload ranges).	Remove some of the equipment from the UPS. The UPS continues to operate, but may shut down if the load increases. The alarm resets when the condition becomes inactive.
UPS overtemperature  LED is On Beep continuous	The UPS internal temperature is too high or a fan has failed. At the warning level, the UPS generates the alarm but remains in the current operating state. If the temperature rises another 10°C, the UPS shuts down.	Clear vents and remove any heat sources. Allow the UPS to cool. Ensure the airflow around the UPS is not restricted. Restart the UPS. If the condition continues to persist, contact your service representative.
The UPS does not start	The input source is not connected correctly.	Check the input and battery connections.
	The Remote Power Off (RPO) switch is active or the RPO connector is missing.	If the UPS Status menu displays the "Remote Power Off" notice, deactivate the RPO input.

Input bad wiring/ Output bad wiring  LED is On Beep continuous	Input/Output cables are not connected to the correct terminal blocks.	Connect correctly the Input/Output cables.
MBP disconnected	The HotSwap MBP is no more connected to the UPS.	If the HotSwap MBP is connected to the UPS, check that the detection connector is correctly plugged.
Lost Password	/	Contact your service representative to reset the password.
BMS com lost  LED is On. Beep continuous	At least one battery has its communication cable disconnected or is unable to communicate.	Check whether the battery communication cable is ok. If the condition continues to persist, contact your service representative.
Bat. Bad wiring  LED is On. Beep continuous	Battery power wire disconnect or DC breaker on EBM is open.	Check the battery power cables, and DC breakers on the EBM. If the condition continues to persist, contact your service representative. If the condition continues to persist, contact your service representative.
Inner bat lost  LED is On. Beep continuous	For 8K and 11K models, the UPS is designed with two internal battery packs. If only one internal battery is installed, the UPS will report a “Inner bat lost” fault after power on and cannot work on battery mode normally.	Check whether the battery communication cables and power cables of the 8k/11k models are properly connected, and verify that the battery output voltage is normal. If the condition continues to persist, contact your service representative.
Bat short circuit	At least one battery has experienced a short circuit.	Check whether UPS charger and DCDC work normally. Charging the battery for 1min could recover from this warning. If the condition continues to persist, contact your service representative.
Bat health low	At least one battery has a low SOH (State of Health).	Refer to the chapter 7.3 “Battery State Of Health (SOH)”
Bat temp low	At least one battery has a low temperature fault.	Increase the ambient temperature, or move the system to a warmer location. If the condition continues to persist, contact your service representative.
Bat n bad wiring	BMS power wire disconnect or DC breaker on BMS is open.	Check the battery power cables. If the condition continues to persist, contact your service representative.
Bat n com lost	The battery communication cable disconnected or is unable to communicate.	Check the battery communication cables. If the condition continues to persist, contact your service representative.
Bat n MOSFET failure	The battery MOSFET is abnormal.	Contact your service representative
Bat n need replace	The battery SOH is low.	Replace the old battery with a new one. Contact your service representative.
Bat n chrg I over	The battery charging current is too high.	If the condition continues to persist, contact your service representative.
Bat n dischrg I over	The battery discharging current is too high.	If the condition continues to persist, contact your service representative.
Bat n temp too high	The battery temperature is too high.	Lower the ambient temperature, or move the system to a cooler location. If the condition continues to persist, contact your service representative.
Bat n volt too high	The battery voltage is too high.	Contact your service representative.
Bat n volt too low	The battery voltage is too low.	Charge the battery. If the condition continues to persist, contact your service representative.

8.2 Silencing the alarm

Press the ESC (Escape) button on the front panel display to silence the alarm. Check the alarm condition and perform the applicable action to resolve the condition. If the alarm status changes, the alarm beeps again, overriding the previous alarm silencing.

8.3 Service and support

If you have any question or problem with the UPS, call Eaton or your local service representative in your country / region. Please have the following information ready when you call for service:

- Model or catalog number
- Serial number
- Firmware version number
- Date of failure or problem
- Symptoms of failure or problem
- Customer return address and contact information

If repair is required, you will be given a Returned Material Authorization (RMA) number. This number must appear on the outside of the package and on the Bill Of Lading (if applicable). Use the original packaging or request packaging from the Help Desk or distributor. Units damaged in shipment as a result of improper packaging are not covered by warranty. A replacement or repair unit will be shipped freight prepaid for all warrantied units.

i For critical applications, immediate replacement may be available. Call the Help Desk for the dealer or distributor nearest you.

For US and Canada you can contact post-sales service support at: 1-(800)-356-5737.

9 Specification and technical characteristics

9.1 UPS Model list

Description	Catalog Number	Power rating (208V)	Configuration
Eaton 9PX Li-Ion 6000 RT4U G2	9PX6KG2-L	4800W/5400VA (L6-30P) 6000W/6000VA (Hardwired)	Rack / Tower
Eaton 9PX Li-Ion 8000 RT4U G2	9PX8KG2-L	7600W/8000VA	Rack / Tower
Eaton 9PX Li-Ion 11000 RT4U G2	9PX11KG2-L	11000W/11000VA	Rack / Tower

Note: Power rating is given at 208V

Function block Diagram of 5~6K models

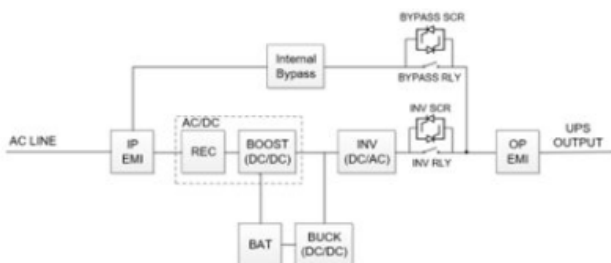

Function block Diagram of 8~11K models

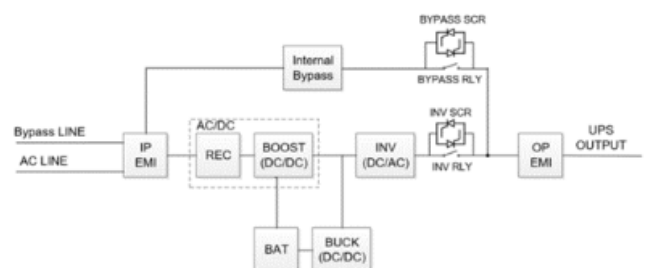

9.2 Extended Battery Module model list

Model	Catalog Number	Configuration	Battery voltage	Use with
Eaton 9PX Li-Ion EBM 192V RT2U G2	9PXEBM192RTG2-L	Rack / Tower	192Vdc	9PX6KG2-L, 9PX8KG2-L, 9PX11KG2-L

9.3 Electrical input

Default frequency	60Hz
Nominal frequency	50/60Hz
Frequency range	40-70Hz
Protective class	Protective class I

Catalog Number	Default input (Voltage/Current)	Input nominal voltages	Input voltage window
9PX6KG2-L	208V/26.22A	200V, 208V , 220V, 230V, 240V	at 100% load: 176-276V at ≤40% load: 100-276V
9PX8KG2-L	208V/41.78A		
9PX11KG2-L	208V/65.72A		

9.4 Electrical input connections

Catalog Number	Input connection	Input cable
9PX6KG2-L	Hardwired or L6-30P	L6-30P
9PX8KG2-L 9PX11KG2-L	Hardwired	Not provided

9.5 Electrical output

All models	Normal mode	High Efficiency mode	Battery mode
Voltage regulation	±1%		±1%
Efficiency	6000 VA: Up to 96.7% 8000/ 11000 VA: Up to 97.2%	6000 VA: Up to 98.9% 8000/ 11000 VA: Up to 99.5%	6000 VA: Up to 95% 8000/ 11000 VA: Up to 96.1%
Frequency regulation	Sync with line ±5% of nominal line frequency (outside this range: ±0.5% of auto-selected nominal frequency)		±0.5% of auto-selected nominal frequency
Nominal output	200/208/220/230/240V		
Nominal Frequency	50Hz or 60Hz, autosensing or configurable as a frequency converter		
Output overload	[102-125%] 10 mins [125-150%] 30 sec >150% 0.5s		[102-130%] 5mins >130% 100ms
Short circuit current limitation	Depends on the external fuse or breaker in the upstream of UPS 6000 VA: 90A 8000 VA: 120A 11000 VA: 150A < 5 cycles		
Voltage waveform	Sine wave		
Harmonic distortion	< 1% THDV on linear load < 5% THDV on non-linear load		
Power Factor	Up to 1		
Load crest ratio	3:1		

All models	Normal mode	High Efficiency mode	Battery mode
Transfer Time	Normal mode <-> Battery Mode: 0ms Normal mode <-> Bypass Mode: 0ms Normal mode -> High Efficiency Mode: 0ms High Efficiency Mode -> Battery Mode: 10ms maximum		

9.6 Electrical output connections

Catalog Number	Output connection	Output cable
9PX6KG2-L	Hardwired (2) L6-30R Primary Group (1) L6-20R Group 1 (1) L6-20R Group 2	Not provided
9PX8KG2-L 9PX11KG2-L	Hardwired (2) L6-30R Primary group (1) L6-30R Group 1 (1) L6-30R Group 2	Not provided

9.7 Electrical output Power

Model	Rated Output Voltage / Maximum Current		VA / Watts	Power Factor
9PX6KG2-L (Input wiring: L6-30P)	200	26.0	5200VA/4600W	PF=0.9
	208	26.0	5400VA/4800W	PF=0.9
	220	25.9	5700VA/5100W	PF=0.9
	230	26.1	6000VA/5300W	PF=0.9
	240	25.0	6000VA/5400W	PF=0.9
9PX6KG2-L (Input wiring: Hardwired)	200	30.0	6000VA/6000W	PF=1.0
	208	28.8	6000VA/6000W	PF=1.0
	220	27.3	6000VA/6000W	PF=1.0
	230	26.1	6000VA/6000W	PF=1.0
	240	25.0	6000VA/6000W	PF=1.0
9PX8KG2-L	200	40.0	8000VA/7200W	PF=0.9
	208	38.5	8000VA/7600W	PF=0.95
	220	36.4	8000VA/8000W	PF=1.0
	230	34.8	8000VA/8000W	PF=1.0
	240	33.3	8000VA/8000W	PF=1.0
9PX11KG2-L	200	50.0	10000VA/10000W	PF=1.0
	208	52.9	11000VA/11000W	PF=1.0
	220	50.0	11000VA/11000W	PF=1.0
	230	47.8	11000VA/11000W	PF=1.0
	240	45.8	11000VA/11000W	PF=1.0

9.8 Battery

	Internal batteries	EBM
Specifications	6000VA: 192Vdc - 2x60x3.2V, 6Ah 8000/11000VA: 192Vdc - 4x60x3.2V, 12Ah	9PXEbm192RTG2-L: 192Vdc - 4x60x3.2V, 12Ah
Type	Lithium Iron Phosphate (LFP) battery module with minimum 8-10 year float service life at 25°C (77°F).	

Monitoring	Integrated battery management system (BMS) for temperature regulation, cell voltage, pack current and life cycle monitoring.
EBM battery cable length	350mm/13.8in

9.9 Battery backup time

The following backup time values are given at 240V.

The battery backup time of 9PX6KG2-L (Input wiring: Hardwired)

Internal battery + EBM quantity	Output Power (W)	5%	10%	20%	30%	40%	50%	60%	70%	80%	90%	100%
Internal	6000	112.3	64.4	34.6	23.6	17.9	14.4	12.0	10.3	9.0	8.0	7.2
Internal +1*EBM	6000	385.1	220.8	118.6	80.9	61.3	49.3	41.1	35.3	30.8	27.4	24.7
Internal +2*EBM	6000	641.8	368.0	197.6	134.8	102.1	82.1	68.5	58.8	51.4	45.6	41.2
Internal +3*EBM	6000	898.5	515.2	276.7	188.7	143.0	114.9	95.9	82.3	71.9	63.8	57.6
Internal +4*EBM	6000	1155.2	662.4	355.7	242.6	183.8	147.8	123.3	105.8	92.5	82.1	74.1
Internal +5*EBM	6000	1411.9	809.6	434.8	296.5	224.7	180.6	150.7	129.3	113.0	100.3	90.6
Internal +6*EBM	6000	1668.6	956.9	513.8	350.4	265.5	213.4	178.1	152.8	133.6	118.6	107.0
Internal +7*EBM	6000	1925.4	1104.1	592.9	404.4	306.3	246.3	205.5	176.3	154.1	136.8	123.5
Internal +8*EBM	6000	2182.1	1251.3	671.9	458.3	347.2	279.1	232.9	199.9	174.7	155.0	140.0
Internal +9*EBM	6000	2438.8	1398.5	751.0	512.2	388.0	311.9	260.3	223.4	195.2	173.3	156.4
Internal +10*EBM	6000	2695.5	1545.7	830.0	566.1	428.9	344.8	287.7	246.9	215.8	191.5	172.9

The battery backup time of 9PX8KG2-L (mins)

Internal battery + EBM quantity	Output Power (W)	5%	10%	20%	30%	40%	50%	60%	70%	80%	90%	100%
Internal	8000	188.6	103.7	53.5	36.3	27.4	22	18.3	15.7	13.7	12.2	10.9
Internal +1*EBM	8000	431.1	237	122.2	83	62.6	50.2	41.9	35.9	31.4	27.9	25
Internal +2*EBM	8000	646.6	355.6	183.3	124.4	93.9	75.3	62.8	53.8	47.1	41.8	37.5
Internal +3*EBM	8000	862.2	474.1	244.5	165.9	125.2	100.4	83.7	71.7	62.8	55.7	50
Internal +4*EBM	8000	1077.7	592.6	305.6	207.4	156.5	125.5	104.7	89.7	78.4	69.6	62.5
Internal +5*EBM	8000	1293.3	711.1	366.7	248.9	187.7	150.6	125.6	107.6	94.1	83.6	75
Internal +6*EBM	8000	1508.8	829.6	427.8	290.3	219	175.7	146.5	125.5	109.8	97.5	87.5
Internal +7*EBM	8000	1724.4	948.1	488.9	331.8	250.3	200.8	167.5	143.5	125.5	111.4	100
Internal +8*EBM	8000	1939.9	1066.7	550	373.3	281.6	225.9	188.4	161.4	141.2	125.4	112.5
Internal +9*EBM	8000	2155.5	1185.2	611.2	414.8	312.9	251	209.4	179.3	156.9	139.3	125
Internal +10*EBM	8000	2371	1303.7	672.3	456.3	344.2	276.1	230.3	197.3	172.6	153.2	137.5

The battery backup time of 9PX11KG2-L (mins)

Internal battery + EBM quantity	Output Power (W)	5%	10%	20%	30%	40%	50%	60%	70%	80%	90%	100%
Internal	11000	143.7	76	39.5	26.5	20	16	13.3	11.4	9.9	8.8	7.9
Internal +1*EBM	11000	328.6	173.8	90.3	60.6	45.6	36.5	30.4	26	22.7	20.1	18
Internal +2*EBM	11000	492.8	260.7	135.5	91	68.4	54.7	45.6	39	34.1	30.2	27.1

Internal +3*EBM	11000	657.1	347.7	180.6	121.3	91.2	73	60.8	52	45.4	40.2	36.1
Internal +4*EBM	11000	821.4	434.6	225.8	151.6	114.1	91.2	76	65.1	56.8	50.3	45.1
Internal +5*EBM	11000	985.7	521.5	270.9	181.9	136.9	109.5	91.2	78.1	68.1	60.3	54.1
Internal +6*EBM	11000	1150	608.4	316.1	212.3	159.7	127.7	106.4	91.1	79.5	70.4	63.2
Internal +7*EBM	11000	1314.2	695.3	361.2	242.6	182.5	146	121.6	104.1	90.8	80.5	72.2
Internal +8*EBM	11000	1478.5	782.2	406.4	272.9	205.3	164.2	136.8	117.1	102.2	90.5	81.2
Internal +9*EBM	11000	1642.8	869.1	451.5	303.2	228.1	182.4	152	130.1	113.5	100.6	90.2
Internal +10*EBM	11000	1807.1	956.1	496.7	333.6	250.9	200.7	167.2	143.1	124.9	110.6	99.3

9.10 Environmental and safety

Standards	IEC/EN 62040-1 Safety IEC/EN 62040-2 Electromagnetic Compatibility EMC IEC/EN 62040-3 Performance FCC part 15 Class A UL 1778 ENERGY STAR Program Requirements for Uninterruptible Power Supplies (UPSs) Version 2.0 CSA-C22.2 No. 107.3	
EMC (Emissions)	CISPR32 Class A FCC part 15 Class A IEC/EN 62040-2 C2 IEC/EN 61000-3-2 or IEC/EN 61000-3-12 Harmonicas IEC/EN 61000-3-3 or IEC/EN 61000-3-11 Flickers	
EMC (Immunity)	IEC 61000-2-2, (Low Frequency): 10V, 140-360Hz IEC 61000-4-2, (ESD): 8 kV Contact Discharge / 15 kV Air Discharge IEC 61000-4-3, (Radiated field): 10 V/m IEC 61000-4-4, (EFT): 4 kV Power Port / 2 kV Network Port IEC 61000-4-5, (Surges): 2 kV Differential Mode / 4 kV Common Mode / 1 kV Network Port IEC 61000-4-6, (Electromagnetic field): 10 V IEC 61000-4-8, (Conducted magnetic field): 30 A/m IEC 61000-4-11, (Voltage Dips) Class 2 IEC 61000-4-12, (Ring Wave): 2 kV Differential Mode / 2kV Common Mode	
UPS enclosure IP rating	IP20	
Earthing system	This UPS can be connected to TN, TT, IT electrical supply system, same system is supplied to the load.	
Overvoltage Category	Category II	
Pollution degree	PD2	
Operating temperature	0 to 40 °C (32 to 104 °F)	
Operating altitude	Up to 3,000 meters (9,842ft) above sea level (without derating).	
Relative humidity	0 to 95 % (without condensation)	
Storage temperature	0°C to 40°C (32°F to 104°F) with battery -25°C to 55°C (-13 °F to 131 °F) without battery	
Transit altitude	Up to 10,000 meters (32,808 ft) above sea level	
Transit temperature	-25°C to 55°C (-13 °F to 131 °F)	
Audible noise	Line mode (load <66%, T<30°C) : 11000 /8000 VA < 38 dB 6000 VA < 38 dB	Batt. Mode : 11000 /8000 VA < 59 dB 6000 VA < 49 dB

10 Glossary

SOH	State Of Health. Overall condition of the battery compared to when it was new.
SOC	State Of Charge. Percentage of usable energy remaining in the lithium battery.
CC	Constant Current.
CV	Constant Voltage.
Backup time	Time during which the load can be supplied by the UPS operating on battery power.
Low-battery warning	This is a battery-voltage level indicating that battery power is low and that the user must take action before the UPS shuts down.
Load	Devices or equipment connected to the UPS output.
Normal mode (double conversion)	The normal UPS operating mode in which the AC source supplies the UPS which, in turn, provides AC power to the connected loads. (after electronic double conversion).
Normal AC source	Normal source of power for the UPS.
OVL	Overload. When the load exceeds 100% of the maximum load of the UPS.
UPS	Uninterruptible Power System.
Relay contacts	Contacts supplying information to the user in the form of signals.
Bypass AC source	Source supplying the bypass line. The equipment can be transferred to the bypass line if an overload occurs on the UPS output, for maintenance or in the event of a malfunction.
EBM	Extended Battery Module
Frequency converter	Operating mode used to convert the AC power frequency between the UPS input and output (50Hz -> 60Hz or 60Hz -> 50Hz).
HE Mode	Operating mode by which the load is supplied directly by the AC source if it is within the tolerances defined by the user. This mode reduces the consumption of electrical power.