

Dell Pro Max 16

MC16250

Owner's Manual

Notes, cautions, and warnings

 **NOTE:** A NOTE indicates important information that helps you make better use of your product.

 **CAUTION:** A CAUTION indicates either potential damage to hardware or loss of data and tells you how to avoid the problem.

 **WARNING:** A WARNING indicates a potential for property damage, personal injury, or death.

Chapter 1: Views of Dell Pro Max 16 MC16250	8
Right	8
Left	9
Top	10
Front	11
Bottom	12
Locate the Service Tag or Express Service Code label of your computer	12
Battery-status light	13
Chapter 2: Set up your Dell Pro Max 16 MC16250	14
Chapter 3: Specifications of Dell Pro Max 16 MC16250	16
Dimensions and weight	16
Processor	16
Chipset	17
Operating system	17
Memory	17
External ports and slots	18
Internal slots	19
Ethernet	19
Wireless module	19
WWAN module	20
Audio	21
Storage	21
Media-card reader	22
Keyboard	22
Keyboard shortcuts of Dell Pro Max 16 MC16250	23
Camera	25
Touchpad	25
Power adapter	26
Power adapter requirements of Dell Pro Max 16 MC16250	27
Battery	27
Power requirements (for computers shipped with 4-cell, 64 Wh battery)	28
Power requirements (for computers shipped with 6-cell, 96 Wh battery)	29
Display	29
Fingerprint reader (optional)	30
Sensors	31
GPU—Integrated	31
GPU—Discrete	31
Multiple display support matrix	31
Hardware security	32
Smart-card reader	32
Contactless smart-card reader	32
Contacted smart-card reader	35

Operating and storage environment.....	36
ComfortView Plus.....	36

Chapter 4: Working inside your computer..... 38

Safety instructions.....	38
Before working inside your computer.....	38
Safety precautions.....	39
Electrostatic discharge—ESD protection.....	39
ESD Field Service kit	40
Transporting sensitive components.....	41
After working inside your computer.....	41
BitLocker.....	41
Recommended tools.....	42
Screw list.....	42
Major components of Dell Pro Max 16 MC16250.....	43

Chapter 5: Removing and installing Customer Replaceable Units (CRUs)..... 46

Base cover.....	46
Removing the base cover.....	46
Installing the base cover.....	49
Battery.....	51
Rechargeable Li-ion battery precautions.....	51
Removing the battery	52
Installing the battery	53
Battery cable.....	53
Disconnecting the battery cable	53
Connecting the battery cable	54
Memory module.....	55
Removing the memory module	55
Installing the memory module	56
Solid-state drive.....	57
Removing the M.2 2230 solid state drive.....	57
Installing the M.2 2230 solid state drive.....	58
Removing the M.2 2280 solid state drive.....	59
Installing the M.2 2280 solid state drive.....	60
Wireless card.....	61
Removing the wireless card	61
Installing the wireless card	62
WWAN module.....	64
Removing the WWAN module	64
Installing the WWAN module	65
Speakers.....	68
Removing the speakers	68
Installing the speakers	69
Right/Processor fan.....	70
Removing the right/processor fan	70
Installing the right/processor fan	71
Left/Video fan.....	72
Removing the left/video fan	72

Installing the left/video fan	73
Chapter 6: Removing and installing Field Replaceable Units (FRUs).....	75
Heat sink.....	75
Removing the heat sink - for computers shipped with integrated graphics card	75
Installing the heat sink - for computers shipped with integrated graphics card	76
Removing the heat sink - for computers shipped with discrete graphics card.....	77
Installing the heat sink - for computers shipped with discrete graphics card	78
GPU filler.....	79
Removing the GPU filler.....	79
Installing the GPU filler.....	80
Graphics card.....	81
Removing the GPU.....	81
Installing the GPU.....	82
Battery frame.....	83
Removing the battery frame.....	83
Installing the battery frame.....	84
USH board.....	86
Removing the USH board.....	86
Installing the USH board.....	87
Smart-card reader.....	88
Removing the smart-card reader.....	88
Installing the smart-card reader.....	89
Display assembly.....	90
Removing the display assembly	90
Installing the display assembly	92
Display bezel.....	96
Removing the display bezel	96
Installing the display bezel	101
Display panel.....	102
Removing the display panel	102
Installing the display panel	105
Display hinges.....	107
Removing the display hinges	107
Installing the display hinges	109
Display cable.....	110
Removing the display cable	110
Installing the display cable	111
Camera.....	113
Removing the camera	113
Installing the camera	113
Display back-cover and antenna assembly.....	114
Removing the display back-cover and antenna assembly	114
Installing the display back-cover and antenna assembly	115
System board.....	117
Removing the system board - for computers shipped with integrated graphics card	117
Installing the system board - for computers shipped with integrated graphics card	119
Removing the system board - for computers shipped with discrete graphics card.....	122
Installing the system board - for computers shipped with discrete graphics card	125
USB Type-C module.....	128

Removing the USB Type-C module.....	128
Installing the USB Type-C module	129
Power button.....	131
Removing the power button	131
Installing the power button	132
Keyboard.....	133
Removing the keyboard.....	133
Installing the keyboard	136
Palm-rest assembly.....	138
Removing the palm-rest assembly	138
Installing the palm-rest assembly	139
Chapter 7: Software.....	141
Operating system.....	141
Drivers and downloads.....	141
Chapter 8: BIOS Setup.....	142
Entering BIOS Setup program.....	142
Navigation keys.....	142
F12 One Time Boot menu.....	142
View Advanced Setup options.....	143
View Service options.....	143
System Setup options.....	143
Updating the BIOS.....	162
Updating the BIOS in Windows.....	162
Updating the BIOS in Linux and Ubuntu.....	162
Updating the BIOS using the USB drive in Windows.....	162
Updating the BIOS from the One-Time boot menu.....	163
System and setup password.....	163
Assigning a System Setup password.....	163
Deleting or changing an existing system password or setup password.....	164
Clearing system and setup passwords.....	164
Chapter 9: Troubleshooting.....	165
Handling swollen rechargeable Li-ion batteries.....	165
Dell SupportAssist Pre-boot System Performance Check diagnostics.....	165
Running the SupportAssist Pre-Boot System Performance Check.....	166
Built-in self-test (BIST).....	166
Motherboard Built-In Self-Test (M-BIST).....	166
Logic Built-in Self-test (L-BIST).....	167
LCD Built-in Self-Test (LCD-BIST).....	167
System-diagnostic lights.....	167
Recovering the operating system.....	168
Real-Time Clock (RTC Reset).....	169
Backup media and recovery options.....	169
Network power cycle.....	169
Drain flea power (perform hard reset).....	169
Chapter 10: Getting help and contacting Dell.....	171

Chapter 11: Revision history..... 172

Views of Dell Pro Max 16 MC16250

Right



Figure 1. Right view

1. nano-SIM card slot (optional)

Insert a nano-SIM card to connect to a mobile broadband network.

NOTE: Availability of the nano-SIM card slot depends on the region and configuration ordered.

2. Global headset port

Connect headphones or a headset (headphone and microphone combo).

3. USB 3.2 Gen 1 (5 Gbps) port with PowerShare

Connect devices such as external storage devices and printers.

Provides data transfer speeds up to 5 Gbps. PowerShare enables you to charge your USB devices even when your computer is turned off.

NOTE: If your computer is turned off or in a hibernation state, you must connect the power adapter to charge your devices using the PowerShare port. You must enable this feature in the BIOS setup program.

NOTE: Certain USB devices may not charge when the computer is turned off or in a sleep state. In such cases, turn on the computer to charge the device.

4. RJ45 ethernet port (1 Gbps)

Connect an RJ45 ethernet cable from a router or a broadband modem for network or Internet access, with a transfer rate of 10/100/1000 Mbps (maximum 1 Gbps).

5. Security-cable slot (wedge-shaped)

Connect a security cable to prevent unauthorized movement of your computer.

Left

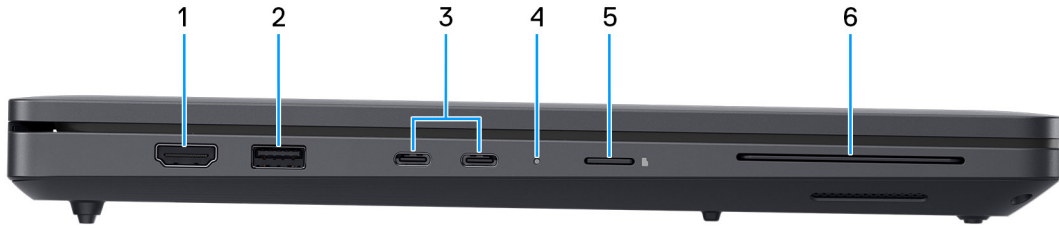

Figure 2. Left view

1. HDMI 2.1 port

Connect to a TV, external display, or another HDMI-in enabled device. Provides video and audio output.

2. USB 3.2 Gen 1 (5 Gbps) port

Connect devices such as external storage devices and printers. Provides data transfer speeds up to 5 Gbps.

3. Two Thunderbolt 4 (40 Gbps) ports with Power Delivery and DisplayPort

Supports USB4, DisplayPort 2.1, Thunderbolt 4 and also enables you to connect to an external display using a display adapter. Provides data transfer rates of up to 40 Gbps for USB4 and Thunderbolt 4.

NOTE: The power adapter is to be connected to one of these Thunderbolt 4 ports.

NOTE: You can connect a Dell Docking Station to the Thunderbolt 4 ports. For more information, search in the Knowledge Base Resource at [Dell Support Site](#).

NOTE: A USB Type-C to DisplayPort adapter (sold separately) is required to connect a DisplayPort device.

NOTE: USB4 is backward compatible with USB 3.2, USB 2.0, and Thunderbolt 3.

NOTE: Thunderbolt 4 supports two 4K displays or one 8K display.

4. Power and battery-status light

Indicates the power state and battery state of the computer.

Solid white—Power adapter is connected and the battery is charging.

Solid amber—Computer is running on battery and the battery charge is low or critical.

Off—Power adapter is disconnected or the battery is fully charged.

NOTE: On certain computer models, the power and battery-status light are also used for diagnostics. For more information, see the *Troubleshooting* section in this document.

5. microSD-card slot

Reads from and writes to the microSD-card.

6. Smart-card reader slot (optional)

Reads information from a smart card with a built-in-chip.

Top



Figure 3. Top view

1. Power button with optional fingerprint reader

Press to turn on the computer if it is turned off, in sleep state, or in hibernate state.

When the computer is turned on, press the power button to put the computer into sleep state; press and hold the power button for ten seconds to force shut-down the computer.

If the power button has a fingerprint reader, place your finger on the power button to log in.

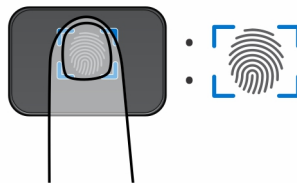

Figure 4. Active area of the fingerprint reader

NOTE: The highlighted area indicates the actual active fingerprint reader area, and the image is for illustration purposes only.

NOTE: You can customize power-button behavior in Windows. For more information, see [Manuals at Dell Support Site](#).

2. Precision touchpad

Move your finger on the touchpad to move the mouse pointer. Tap to left-click and two fingers tap to right-click.

Front

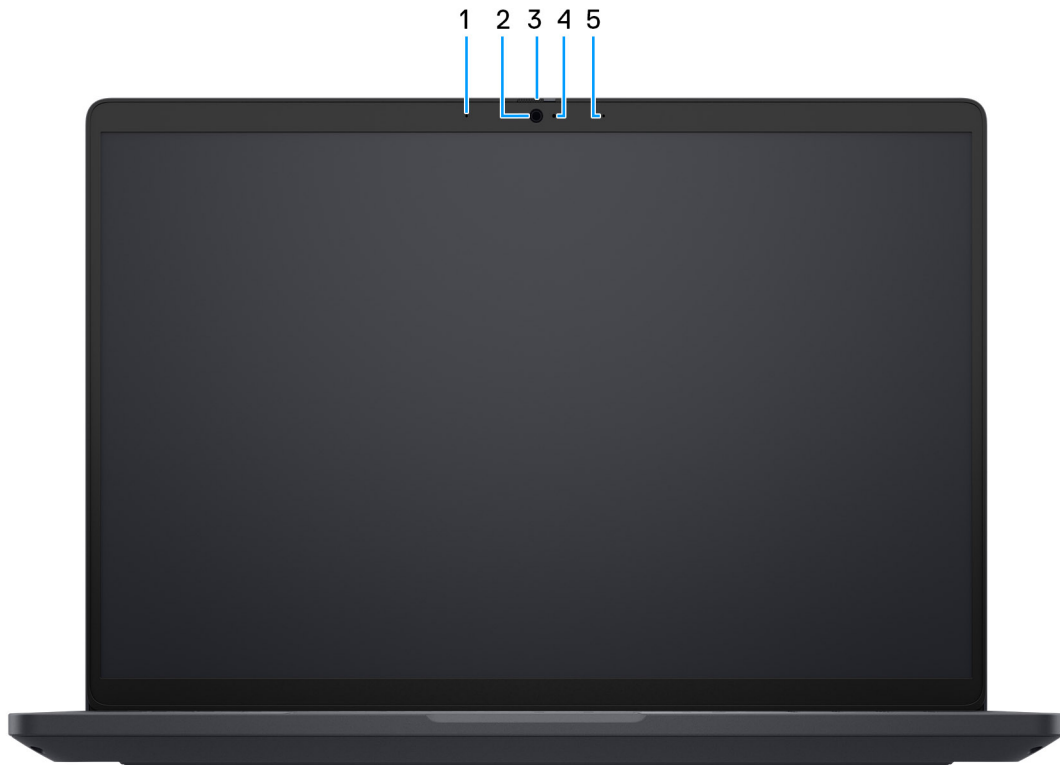

Figure 5. Front view

1. Left microphone

Provides digital sound input for audio recording and voice calls.

2. Camera

A camera enables you to video chat, capture photos, and record videos.

3. Privacy shutter

Slide the privacy shutter to cover the camera lens and protect your privacy when the camera is not in use.

4. Camera-status light

Turns on when the camera is in use.

5. Right microphone

Provides digital sound input for audio recording and voice calls.

Bottom

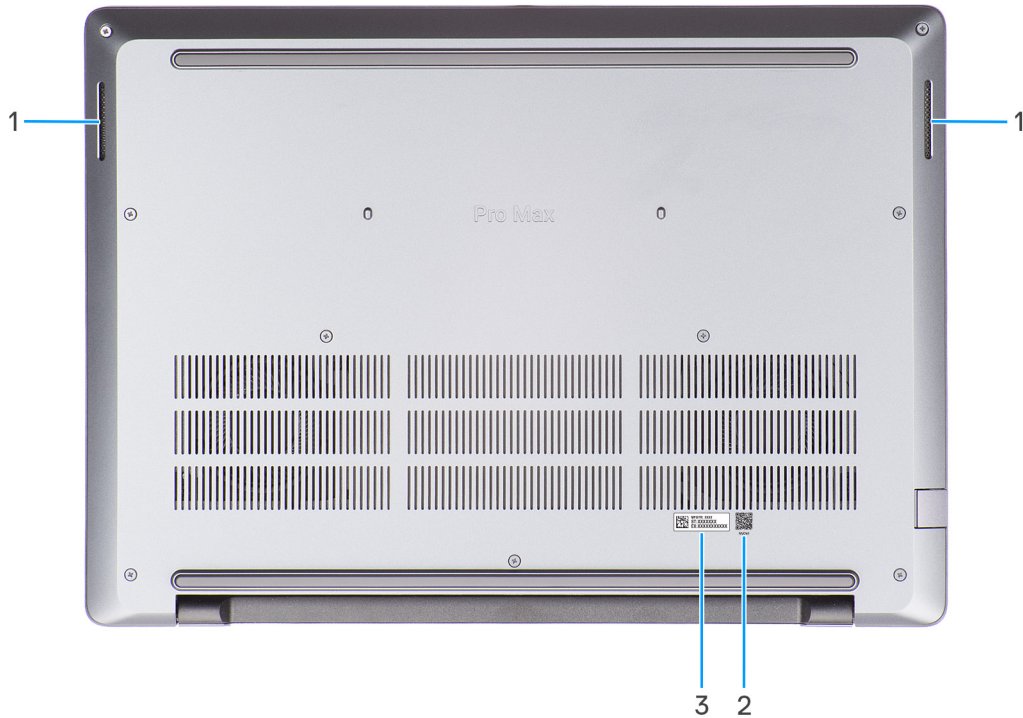

Figure 6. Bottom view

1. Speakers

Provide audio output.

2. MyDell QR code

MyDell is your hub for content that is personalized for your Dell Pro Max 16 MC16250, including videos, articles, manuals, and access to support.

3. Service Tag/Express Service Code label

The Service Tag is a unique alphanumeric identifier that enables Dell service technicians to identify the hardware components in your computer and access warranty information. The Express Service Code is a numeric version of the Service Tag.

Locate the Service Tag or Express Service Code label of your computer

The Service Tag is a unique alphanumeric identifier that allows Dell service technicians to identify the hardware components in your computer and access warranty information. The Express Service Code is a numeric version of the Service Tag.

For more information about how to find the Service Tag of your computer, search in the Knowledge Base Resource at the [Dell Support Site](#).

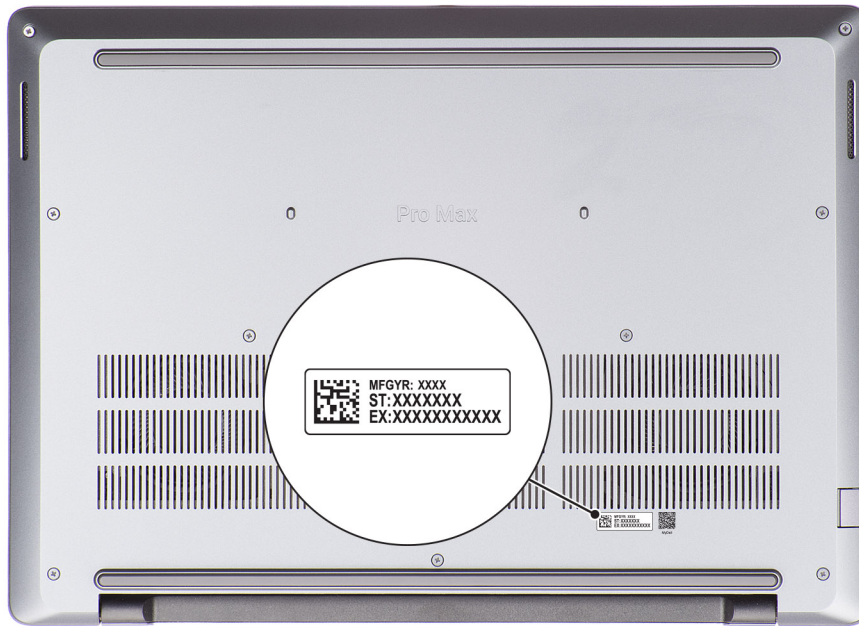

Figure 7. Service Tag/Express Service Code location

Battery-status light

The following table lists the battery-status light of your Dell Pro Max 16 MC16250.

Table 1. Battery-status light behavior

Power source	LED behavior	System power state	Battery charge level
AC adapter	Off	S0 or S5	100%
AC adapter	Solid white	S0 or S5	< 100%
Battery	Off	S0 or S5	11-100%
Battery	Solid amber	S0 or S5	< 10%

- S0 (ON): The computer is turned on.
- S3 (Sleep): Screen is off and computer is in sleep mode.
- S4 (Hibernate): The computer consumes the least power in the Hibernate state than in the ON or OFF state. The computer is almost in the OFF state. The context data is written to a storage device, allowing you to resume from where you left after the computer is turned on.
- S5 (OFF): The computer is in a shutdown state.

Set up your Dell Pro Max 16 MC16250

About this task

NOTE: The images in this document may differ from your computer depending on the configuration you ordered.

Steps

1. Connect the power adapter to one of the Thunderbolt 4 ports and press the power button.



Figure 8. Connect the power adapter and press the power button

NOTE: The battery may go into power-saving mode during shipment to conserve charge on the battery. Ensure that the power adapter is connected to your computer when it is turned on for the first time.

2. Finish the operating system setup.

For Ubuntu:

Follow the on-screen instructions to complete the setup. For more information about installing and configuring Ubuntu, search in the Knowledge Base Resource at [Dell Support Site](#).

For Windows:

Follow the on-screen instructions to complete the setup. When setting up, it is recommended that you:





- Connect to a network for Windows updates.

NOTE: If connecting to a secured wireless network, enter the password for the wireless network access when prompted.

- If connected to the Internet, sign-in with an existing Microsoft account or create a new account.
- On the **Support and Protection** screen, enter your contact details.

3. Locate and use Dell apps from the Windows Start menu—Recommended.

Table 2. Locate Dell apps

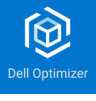
Resources	Description
	<p>Dell Product Registration Register your computer with Dell.</p>
	<p>Dell Help & Support Access help and support for your computer.</p>
	<p>SupportAssist SupportAssist keeps your computer running at its best by optimizing settings, detecting issue, and removing viruses. It also notifies when updates are available for your computer. SupportAssist proactively checks the health of your computer hardware and software. When an issue is detected, the necessary system state information is sent to Dell to begin troubleshooting. SupportAssist is preinstalled on most of the Dell devices running the Windows operating system. For more information, see Support Assist documentation at Dell Support Site.</p> <p>NOTE: In SupportAssist, click the warranty expiry date to renew or upgrade your warranty.</p>
	<p>Dell Update Updates your computer with critical fixes and latest device drivers as they become available. For more information about using Dell Update, see the product guides and third-party license documents at Dell Support Site.</p>
	<p>Dell Optimizer Dell Optimizer is an AI-based software application that allows you to customize your computer settings for power and battery, and more.</p> <p>For Dell Pro Max 16 MC16250 with Dell Optimizer, you can:</p> <ul style="list-style-type: none"> • Tune the performance, power consumption, cooling, and fan noise with selectable thermal modes. • Download and redeem the apps that are purchased with your computer. <p>For more information about configuring and using these features, search for <i>Dell Optimizer</i> at Dell Support Site.</p>

Specifications of Dell Pro Max 16 MC16250

Dimensions and weight

The following table lists the height, width, depth, and weight of your Dell Pro Max 16 MC16250.

Table 3. Dimensions and weight

Description	Values
Height:	
Front height	15.08 mm (0.59 in.)
Rear height	19.08 mm (0.75 in.)
Width	358 mm (14.09 in.)
Depth	256 mm (10.08 in.)
Weight  NOTE: The weight of your computer depends on the configuration that you ordered.	Minimum: 2.10 kg (4.65 lb)

Processor

The following table lists the details of the processors that are supported by your Dell Pro Max 16 MC16250.

Table 4. Processor

Description	Option one	Option two	Option three	Option four
Processor type	Intel Core Ultra 5 235H vPro	Intel Core Ultra 7 255H	Intel Core Ultra 7 265H vPro	Intel Core Ultra 9 285H vPro
Processor wattage	45 W	45 W	45 W	45 W
Processor total core count	14	16	16	16
Performance-cores	4	6	6	6
Efficient-cores	10	10	10	10
Processor total thread count  NOTE: Intel Hyper-Threading Technology is only available on Performance-cores.	14	16	16	16
Processor speed	Up to 5.00 GHz	Up to 5.10 GHz	Up to 5.30 GHz	Up to 5.40 GHz

Table 4. Processor (continued)

Description	Option one	Option two	Option three	Option four
Performance-cores frequency				
Processor base frequency	2.40 GHz	2.00 GHz	2.20 GHz	2.90 GHz
Maximum turbo frequency	5.00 GHz	5.10 GHz	5.30 GHz	5.40 GHz
Efficient-cores frequency				
Processor base frequency	1.80 GHz	1.50 GHz	1.70 GHz	2.70 GHz
Maximum turbo frequency	4.40 GHz	4.40 GHz	4.50 GHz	4.50 GHz
Processor cache	18 MB	24 MB	24 MB	24 MB
Integrated graphics	Intel Graphics	Intel Graphics	Intel Graphics	Intel Graphics

Chipset

The following table lists the details of the chipset that is supported by your Dell Pro Max 16 MC16250.

Table 5. Chipset

Description	Values
Chipset	Integrated with the processor
Processor	Intel Core Ultra 5/7/9 non-vPro/vPro processors
DRAM bus width	64-bit
Flash EPROM	Up to 64 MB
PCIe bus	Up to Gen5

Operating system

Your Dell Pro Max 16 MC16250 supports the following operating systems:

- Windows 11 Home
- Windows 11 Pro
- Ubuntu Linux 22.04 LTS, 64-bit

Memory

The following table lists the memory specifications that are supported by your Dell Pro Max 16 MC16250.

Table 6. Memory specifications

Description	Values
Memory slots	Two SoDIMM/CSoDIMM slots
Memory type	DDR5

Table 6. Memory specifications (continued)

Description	Values
Memory speed	<ul style="list-style-type: none"> • 5600 MT/s • 6400 MT/s
Maximum memory configuration	64 GB
Minimum memory configuration	16 GB
Memory size per slot	8 GB, 16 GB or 32 GB
Memory configurations supported	<ul style="list-style-type: none"> • 16 GB: 2 x 8 GB, DDR5, 5600 MT/s, SoDIMM, dual-channel • 32 GB: 2 x 16 GB, DDR5, 5600 MT/s, SoDIMM, dual-channel • 32 GB: 2 x 16 GB, DDR5, 6400 MT/s, CSoDIMM, dual-channel • 64 GB: 2 x 32 GB, DDR5, 6400 MT/s, CSoDIMM, dual-channel

External ports and slots

The following table lists the external ports and slots on your Dell Pro Max 16 MC16250.

Table 7. External ports and slots

Description	Values
Network port	One RJ45 ethernet port (1 Gbps)
USB ports	<ul style="list-style-type: none"> • Two Thunderbolt 4 (40 Gbps) ports with Power Delivery and DisplayPort • One USB 3.2 Gen 1 (5 Gbps) port with PowerShare • One USB 3.2 Gen 1 (5 Gbps) port
Audio port	One global headset port
Video port(s)	<ul style="list-style-type: none"> • Two Thunderbolt 4 (40 Gbps) ports with Power Delivery and DisplayPort • One HDMI 2.1 port
Media-card reader	<ul style="list-style-type: none"> • One microSD-card slot • One optional smart-card reader slot
Power-adaptor port	Supported via two Thunderbolt 4 (40 Gbps) ports with Power Delivery and DisplayPort
Security-cable slot	One wedge-shaped lock slot
SIM-card slot	One optional nano-SIM card slot

Internal slots

The following table lists the internal slots of your Dell Pro Max 16 MC16250.

Table 8. Internal slots

Description	Values
M.2	<ul style="list-style-type: none"> Two M.2 Key-M (2230/2280) slot for solid-state drive One M.2 2230 Key-E slot for Wi-Fi and Bluetooth combo card One M.2 3042 slot for WWAN card <p>NOTE: To learn more about the features of different types of M.2 cards, search Dell Support Site.</p>

Ethernet

The following table lists the wired ethernet Local Area Network (LAN) specifications of your Dell Pro Max 16 MC16250.

Table 9. Ethernet specifications

Description	Values
Model	<ul style="list-style-type: none"> Intel I219-LM for vPro configurations Intel I219-V for non-vPro configurations
Transfer rate	10/100/1000 Mbps

Wireless module

The following table lists the Wireless Local Area Network (WLAN) modules that are supported on your Dell Pro Max 16 MC16250.

Table 10. Wireless module specifications

Description	Option one	Option two
Model number	Intel Wi-Fi 6E AX211	Intel Wi-Fi 7 BE201
Transfer rate	Up to 2400 Mbps	Up to 5760 Mbps
Frequency bands supported	2.4 GHz/5 GHz/6 GHz	2.4 GHz/5 GHz/6 GHz
Wireless standards	<ul style="list-style-type: none"> Wi-Fi 802.11 a/b/g Wi-Fi 4 (WiFi 802.11n) Wi-Fi 5 (WiFi 802.11ac) Wi-Fi 6E (WiFi 802.11ax) 	<ul style="list-style-type: none"> Wi-Fi 802.11 a/b/g Wi-Fi 4 (WiFi 802.11n) Wi-Fi 5 (WiFi 802.11ac) Wi-Fi 6E (WiFi 802.11ax) Wi-Fi 7 (WiFi 802.11be)
Encryption	<ul style="list-style-type: none"> 64-bit/128-bit WEP AES-CCMP TKIP 	<ul style="list-style-type: none"> 64-bit/128-bit WEP AES-CCMP TKIP
Bluetooth wireless card	Bluetooth 5.3	Bluetooth 5.4
NOTE: The functionality of the Bluetooth wireless card may vary based on the operating system.		

WWAN module

The following table lists the Wireless Wide Area Network (WWAN) module that is supported in your Dell Pro Max 16 MC16250.

- NOTE:** The WWAN module is available only on certain configurations and in certain regions.
- NOTE:** Availability of the eSIM feature on this module may vary depending on your region and the support that is offered by your mobile carrier.
- NOTE:** For instructions on how to setup SIM or eSIM connections on your computer, see the *SIM/eSIM Setup Guide for Windows* available with your product documentation at [Dell Support Site](#).

Table 11. WWAN module specifications

Description	Values
Model number	MediaTek T700 (DW5933e)
Form factor	M.2 3052 Key-B
Host interface	PCIe Gen3
Network standard	<ul style="list-style-type: none"> • NR FR1(Sub6) FDD/TDD • LTE FDD/TDD • WCDMA/HSPA+ • GPS/GLONASS/Galileo/BDS/QZSS
Transfer data rate	<ul style="list-style-type: none"> • SA: Download 4.67 Gbps/Upload 1.25 Gbps • NSA: Download 3.74 Gbps/Upload 835 Mbps • LTE: Download 1.6 Gbps (CAT19)/Upload 211 Mbps • UMTS: Download 384 kbps/Upload 384 kbps • DC-HSPA+: Download 42 Mbps (CAT24)/Upload 11.5 Mbps (CAT7)
Operating frequency bands	<ul style="list-style-type: none"> • NR (n1, n2, n3, n5, n7, n8, n20, n25, n28, n30, n38, n40, n41, n48, n66, n71, n77, n78, n79) • LTE (B1, B2, B3, B4, B5, B7, B8, B12, B13, B14, B17, B18, B19, B20, B25, B26, B28, B29, B30, B32, B34, B38, B39, B40, B41, B42, B43, B46, B48, B66, B71) • WCDMA/HSPA+ (1, 2, 4, 5, 8)
Power supply	DC 3.135 V to 4.40 V, typical 3.30 V
SIM card	Supported through external SIM slot
eSIM with dual SIM (DSSA)	Supported NOTE: Availability of eSIM functionality embedded on this module is dependent on your region and specific carrier requirements.
Antenna diversity	Supported
Radio on/off	Supported
Wake On Wireless WAN	Supported
Operating temperature	<ul style="list-style-type: none"> • Normal operating temperature: -10°C to 55°C • Extended operating temperature: -40°C to 85°C • Storage temperature: -60°C to 100°C

Table 11. WWAN module specifications (continued)

Description	Values
Antenna connector	<ul style="list-style-type: none"> • One WWAN TX0 and PRX connector • One WWAN DRX combined GPS connector • One WWAN MIMO PRX connector • One WWAN TX1 and MIMO DRX connector
<p>NOTE: For instructions to find your computer's International Mobile Equipment Identity (IMEI) number, search Dell Support Site.</p>	

Audio

The following table lists the audio specifications of your Dell Pro Max 16 MC16250.

Table 12. Audio specifications

Description	Values
Audio controller	Realtek ALC3329
Stereo conversion	Supported with Waves MaxxAudio Pro
Internal audio interface	Soundwire interface
External audio interface	One global headset port
Number of speakers	Two
Internal-speaker amplifier	Supported via Realtek ALC1708
External volume controls	Keyboard shortcut controls
Speaker output:	
Average	2 W x 2 = 4 W
Peak	2.5 W x 2 = 5 W
Microphone	Dual-array digital microphones

Storage

This section lists the storage options on your Dell Pro Max 16 MC16250.

Your Dell Pro Max 16 MC16250 supports the following storage configurations -

Table 13. Storage matrix

Storage	Slot	
	SSD2 (Primary M.2 PCIe for boot function)	SSD1 (Secondary M.2 PCIe)
One M.2 2230/2280 solid state drive	M.2 2230/2280 solid state drive	Not applicable
One M.2 2230/2280 solid state drive and	M.2 2230/2280 solid state drive	M.2 2230 solid state drive only

Table 13. Storage matrix (continued)

Storage	Slot	
	SSD2 (Primary M.2 PCIe for boot function)	SSD1 (Secondary M.2 PCIe)
One M.2 2230 solid state drive i NOTE: For computers shipped with a WWAN card installed, only M.2 2230 solid state drive can be installed in slot SSD1 (secondary slot).		
One M.2 2230/2280 solid state drive and One M.2 2230/2280 solid state drive i NOTE: For computers shipped without a WWAN card installed, either M.2 2230 or M.2 2280 solid state drive can be installed in slot SSD1 (secondary slot).	M.2 2230/2280 solid state drive	M.2 2230/2280 solid state drive

Table 14. Storage specifications

Storage type	Interface type	Capacity
M.2 2230 solid state drive	Gen 4 x4 PCIe NVMe	256 GB or 512 GB
M.2 2280 solid state drive, Self-Encrypting	Gen 4 x4 PCIe NVMe	1 TB or 2 TB

Media-card reader

The following table provides the specification of media cards that are supported by your Dell Pro Max 16 MC16250.

Table 15. Media-card reader specifications

Description	Values
Media-card slot type	microSD 4.0 card
Media-cards supported	<ul style="list-style-type: none"> microSecure Digital (mSD) microSecure Digital High Capacity (mSDHC) microSecure Digital Extended Capacity (mSDXC)
i NOTE: The maximum capacity of the media-card reader varies depending on the standard of the media card that is inserted in your computer.	

Keyboard

The following table lists the keyboard specifications of your Dell Pro Max 16 MC16250.

Table 16. Keyboard specifications

Description	Values
Keyboard type	<ul style="list-style-type: none"> Magnetite, Standard AI hotkey backlit keyboard Magnetite, Standard AI hotkey non-backlit keyboard
Keyboard layout	QWERTY

Table 16. Keyboard specifications (continued)

Description	Values
Number of keys	<ul style="list-style-type: none"> • United States and Canada: 99 keys • United Kingdom: 100 keys • Japan: 103 keys
Key pitch	X = 18.05 mm key pitch Y = 18.05 mm key pitch
Keyboard shortcuts	Some keys on your keyboard have two symbols on them. These keys can be used to type alternate characters or to perform secondary functions. <ul style="list-style-type: none"> • To type the alternate character, press Shift and the desired key. • To perform secondary functions, press Fn and the desired key. <p>NOTE: You can define the primary behavior of the function keys (F1–F12) by changing Function Key Behavior in the BIOS Setup program.</p> <p>NOTE: If Copilot in Windows is not available on your computer, pressing the Copilot key launches Windows search. For more information about Copilot in Windows, see the Knowledge Base Resource at the Dell Support site.</p>

Keyboard shortcuts of Dell Pro Max 16 MC16250

NOTE: Keyboard characters may differ depending on the keyboard language configuration. Keys that are used for shortcuts remain the same across all language configurations.

Some keys on your keyboard have two symbols on them. These keys can be used to type alternate characters or to perform secondary functions. The symbol that is shown on the lower part of the key refers to the character that is typed out when the key is pressed. If you press shift and the key, the symbol that is shown on the upper part of the key is typed out. For example, if you press **2**, 2 is typed out; if you press **Shift + 2**, @ is typed out.

The keys F1-F12 at the top row of the keyboard are function keys for multimedia control, as indicated by the icon on the key. Press the function key to enable the task represented by the icon. For example, pressing F1 mutes the audio (see the table below).

However, if the function keys F1-F12 are needed for specific software applications, multimedia functionality can be disabled by pressing **Fn + Esc**. Later, multimedia control can be invoked by pressing **Fn** and the respective function key. For example, mute audio by pressing **Fn + F1**.

NOTE: You can also define the primary behavior of the function keys (F1–F12) by changing **Function Key Behavior** in the BIOS setup program.

Table 17. Function key primary behavior

Function key	Primary behavior
F1	Mute or unmute audio
F2	Decrease volume
F3	Increase volume
F4	Microphone Mute
F5	Keyboard Illumination/Backlight
F6	Decrease brightness

Table 17. Function key primary behavior (continued)

Function key	Primary behavior
F7	Increase brightness
F8	Switch to external display
F10	Print screen
F11	Home
F12	End

The **Fn** key is also used with selected keys on the keyboard to invoke secondary functions.

Table 18. Secondary behavior

Function key	Secondary behavior
Fn + F1	Operating system and application-specific F1 behavior
Fn + F2	Operating system and application-specific F2 behavior
Fn + F3	Operating system and application-specific F3 behavior
Fn + F4	Operating system and application-specific F4 behavior
Fn + F5	Operating system and application-specific F5 behavior
Fn + F6	Operating system and application-specific F6 behavior
Fn + F7	Operating system and application-specific F6 behavior
Fn + F8	Operating system and application-specific F8 behavior
Fn + F9	Operating system and application-specific F9 behavior
Fn + F10	Operating system and application-specific F10 behavior
Fn + F11	Operating system and application-specific F11 behavior
Fn + F12	Operating system and application-specific F12 behavior
Fn + Ctrl	Open the application menu
Fn + Esc	Toggle between multimedia and function key behavior
Fn + PgUp	Scroll up the document or page
Fn + PgDn	Scroll down the document or page
Fn + Home	Move to the beginning of the document
Fn + End	Move to the end of the document
Copilot	<p>Launch Copilot in Windows</p> <p>NOTE: If Copilot in Windows is not available on your computer, the Copilot key launches Recall. If both Recall and Copilot in Windows are not available on your computer, the Copilot key launches Windows Search. For more information about Copilot in Windows and Recall, search in the Knowledge Base Resource at the Dell Support Site.</p>

Camera

The following table lists the camera specifications of your Dell Pro Max 16 MC16250.

Table 19. Camera specifications

Description		Option one	Option two	Option three
Number of cameras		One	Two	Two
Camera type		FHD RGB camera	FHD RGB and IR camera	8M MIPI RGB and IR camera
Camera location		Front camera	Front camera	Front camera
Camera sensor type		CMOS sensor technology	CMOS sensor technology	CMOS sensor technology
Camera resolution:				
	Still image	2.07 megapixel	2.07 megapixel	8.0 megapixel
	Video	1920 x 1080 (FHD) at 30 fps	1920 x 1080 (FHD) at 30 fps	2560 x 1440 at 30 fps i NOTE: The default resolution for video is set at 1080p. For more information about changing the camera resolution, search for information about changing the camera resolution in Windows 11 at the Microsoft Support Site .
Infrared camera resolution:				
	Still image	N/A	0.23 megapixel	0.23 megapixel
	Video	N/A	640 x 360 at 15 fps	640 x 360 at 15 fps
Diagonal viewing angle:				
	Camera	80.20 degrees	80.20 degrees	88.10 degrees
	Infrared camera	N/A	86.60 degrees	86.60 degrees

Touchpad

The following table lists the touchpad specifications of your Dell Pro Max 16 MC16250.

Table 20. Touchpad specifications

Description		Values
Touchpad resolution:		
	Horizontal	>= 300 dpi
	Vertical	>= 300 dpi
Touchpad dimensions:		

Table 20. Touchpad specifications (continued)

Description		Values
	Horizontal	125 mm (4.92 in.)
	Vertical	88 mm (3.46 in.)
Touchpad gestures		For more information about the touchpad gestures that are available on: <ul style="list-style-type: none"> • Windows, search Microsoft Support Site. • Ubuntu, search Ubuntu Support Site.

Power adapter

The following table lists the power adapter specifications of your Dell Pro Max 16 MC16250.

Table 21. Power-adapter specifications

Description	Option one	Option two
Type	100 W AC adapter, USB Type-C	130 W AC adapter, USB Type-C
Power-adapter dimensions:		
Height	26.50 mm (1.04 in.)	22 mm (0.87 in.)
Width	60 mm (2.36 in.)	66 mm (2.60 in.)
Depth	122 mm (4.80 in.)	143 mm (5.63 in.)
Input voltage	100 VAC - 240 VAC	100 VAC - 240 VAC
Input frequency	50 Hz - 60 Hz	50 Hz - 60 Hz
Input current (maximum)	1.70 A	1.80 A
Output current (continuous)	<ul style="list-style-type: none"> • 20 V/5 A • 15 V/3 A • 9 V/3 A • 5 V/3 A 	<ul style="list-style-type: none"> • 20 V/6.50 A • 5 V/1 A
Rated output voltage	<ul style="list-style-type: none"> • 20 VDC • 15 VDC • 9 VDC • 5 VDC 	<ul style="list-style-type: none"> • 20 VDC • 5 VDC
Temperature range:		
Operating	0°C to 40°C (32°F to 104°F)	0°C to 40°C (32°F to 104°F)
Storage	-40°C to 70°C (-40°F to 158°F)	-40°C to 70°C (-40°F to 158°F)
 CAUTION: Operating and storage temperature ranges may differ among components, so operating or storing the device outside these ranges may impact the performance of specific components.		

Power adapter requirements of Dell Pro Max 16 MC16250

NOTE: If you did not purchase the Dell-branded power adapter that is recommended for your computer, ensure that the power adapter you use meets the following requirements.

The following table lists the power adapter requirements for your Dell Pro Max 16 MC16250.

Table 22. Power adapter requirements

Description	Value
Power that is required from a power adapter to achieve optimal performance	100 W
Power that charges the computer at a slower speed NOTE: A warning message may appear informing you about the use of a lower-powered adapter and slower charging speed.	Less than 100 W
Minimum power that is required from a power adapter to operate the computer and charge the battery NOTE: A warning message appears informing you about the use of a lower-powered adapter and slower charging speed.	45 W
USB Power Delivery (PD) fast charging	Supported
ExpressCharge mode	Supported NOTE: Ensure that the computer with a 64 Wh battery is connected to a 100 W power adapter for this feature to be supported. NOTE: Ensure that the computer with a 96 Wh battery is connected to a 130 W power adapter for this feature to be supported. NOTE: ExpressCharge mode must also be enabled in the BIOS Setup screen. Select Power > Battery Configuration > ExpressCharge , then press Enter .

Battery

The following table lists the battery specifications of your Dell Pro Max 16 MC16250.

Table 23. Battery specifications

Description	Option one	Option two	Option three	Option four
Battery type	4-cell, 64 Wh, Lithium Ion Polymer, Standard Life, ExpressCharge, ExpressCharge Boost	4-cell, 64 Wh, Lithium Ion Polymer, Long Cycle Life, ExpressCharge, ExpressCharge Boost	6-cell, 96 Wh, Lithium Ion Polymer, Standard Life, ExpressCharge, ExpressCharge Boost	6-cell, 96 Wh, Lithium Ion Polymer, Long Cycle Life, ExpressCharge, ExpressCharge Boost
Battery voltage	15.60 VDC	15.60 VDC	11.70 VDC	11.70 VDC
Battery weight (maximum)	0.255 kg (0.56 lb)	0.255 kg (0.56 lb)	0.351 kg (0.77 lb)	0.351 kg (0.77 lb)
Battery dimensions:				
	Height	7.71 mm (0.30 in.)	7.71 mm (0.30 in.)	7.71 mm (0.30 in.)
	Width	294.90 mm (11.61 in.)	294.90 mm (11.61 in.)	294.90 mm (11.61 in.)

Table 23. Battery specifications (continued)

Description		Option one	Option two	Option three	Option four
	Depth	77.50 mm (3.05 in.)	77.50 mm (3.05 in.)	77.50 mm (3.05 in.)	77.50 mm (3.05 in.)
Temperature range:					
	Operating	<ul style="list-style-type: none"> Charge: 0°C to 50°C (32°F to 122°F) Discharge: 0°C to 60°C (32°F to 140°F) 	<ul style="list-style-type: none"> Charge: 0°C to 50°C (32°F to 122°F) Discharge: 0°C to 60°C (32°F to 140°F) 	<ul style="list-style-type: none"> Charge: 0°C to 50°C (32°F to 122°F) Discharge: 0°C to 60°C (32°F to 140°F) 	<ul style="list-style-type: none"> Charge: 0°C to 50°C (32°F to 122°F) Discharge: 0°C to 60°C (32°F to 140°F)
	Storage	-20°C to 65°C (-4°F to 149°F)	-20°C to 65°C (-4°F to 149°F)	-20°C to 65°C (-4°F to 149°F)	-20°C to 65°C (-4°F to 149°F)
Battery operating time		Varies depending on operating conditions and can significantly reduce under certain power-intensive conditions.	Varies depending on operating conditions and can significantly reduce under certain power-intensive conditions.	Varies depending on operating conditions and can significantly reduce under certain power-intensive conditions.	Varies depending on operating conditions and can significantly reduce under certain power-intensive conditions.
Battery charging time (approximate)		<ul style="list-style-type: none"> ExpressCharge Boost - From 0% to 35% in almost 20 minutes ExpressCharge - 2 hours Standard charge - 3 hours 	<ul style="list-style-type: none"> ExpressCharge Boost - From 0% to 35% in almost 20 minutes ExpressCharge - 2 hours Standard charge - 3 hours 	<ul style="list-style-type: none"> ExpressCharge Boost - From 0% to 35% in almost 20 minutes ExpressCharge - 2 hours Standard charge - 3 hours 	<ul style="list-style-type: none"> ExpressCharge Boost - From 0% to 35% in almost 20 minutes ExpressCharge - 2 hours Standard charge - 3 hours
Coin-cell battery		Not supported	Not supported	Not supported	Not supported
<p>⚠ CAUTION: Operating and storage temperature ranges may differ among components, so operating or storing the device outside these ranges may impact the performance of specific components.</p> <p>⚠ CAUTION: Dell Technologies recommends that you charge the battery regularly for optimal power consumption.</p>					

Power requirements (for computers shipped with 4-cell, 64 Wh battery)

i NOTE: The information in this section is applicable to the European Union (EU) countries.

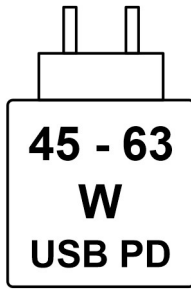

Figure 9. Pictogram for 64 Wh battery

The power that is delivered by the charger must be between a minimum of 45 Watts that is required by the radio equipment, and a maximum of 63 Watts in order to achieve the maximum charging speed.

This computer supports USB Power Delivery (PD) fast charging.

Power requirements (for computers shipped with 6-cell, 96 Wh battery)

NOTE: The information in this section is applicable to the European Union (EU) countries.

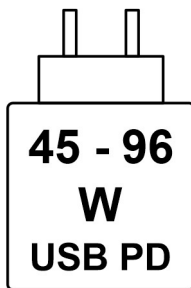

Figure 10. Pictogram for 96 Wh battery

The power that is delivered by the charger must be between a minimum of 45 Watts that is required by the radio equipment, and a maximum of 96 Watts in order to achieve the maximum charging speed.

This computer supports USB Power Delivery (PD) fast charging.

Display

The following table lists the display specifications of your Dell Pro Max 16 MC16250.

Table 24. Display specifications

Description		Option one	Option two	Option three
Display type		16" Full High Definition Plus (FHD+)	16" Full High Definition Plus (FHD+)	16" Quad High Definition Plus (QHD+), ComfortView Plus
Touch options		Not supported	Supported	Not supported
Display-panel technology		Wide-Viewing Angle (WVA)	Wide-Viewing Angle (WVA)	Wide-viewing Angle (WVA)
Display-panel dimensions (active area):				
	Height	215.42 mm (8.48 in.)	215.42 mm (8.48 in.)	215.42 mm (8.48 in.)

Table 24. Display specifications (continued)

Description		Option one	Option two	Option three
	Width	344.68 mm (13.57 in.)	344.68 mm (13.57 in.)	344.68 mm (13.57 in.)
	Diagonal	406.46 mm (16.00 in.)	406.46 mm (16.00 in.)	406.46 mm (16.00 in.)
Display-panel native resolution		1920 x 1200	1920 x 1200	2560 x 1600
Luminance (typical)		300 nits	300 nits	300 nits
Megapixels		2.3	2.3	4.1
Color gamut		45% NTSC	45% NTSC	100% sRGB
Pixels Per Inch (PPI)		142	142	189
Contrast ratio (typical)		1000:1	1000:1	1000:1
Response time (maximum)		35 ms	35 ms	35 ms
Refresh rate		60 Hz	60 Hz	120 Hz
Horizontal view angle		<ul style="list-style-type: none"> Minimum: 80 +/- degrees Typical: 85 +/- degrees 	<ul style="list-style-type: none"> Minimum: 80 +/- degrees Typical: 85 +/- degrees 	<ul style="list-style-type: none"> Minimum: 80 +/- degrees Typical: 85 +/- degrees
Vertical view angle		<ul style="list-style-type: none"> Minimum: 80 +/- degrees Typical: 85 +/- degrees 	<ul style="list-style-type: none"> Minimum: 80 +/- degrees Typical: 85 +/- degrees 	<ul style="list-style-type: none"> Minimum: 80 +/- degrees Typical: 85 +/- degrees
Pixel pitch		0.18 x 0.18	0.18 x 0.18	0.13 x 0.13
Power consumption (maximum)		4.45 W	5.60 W	4.80 W
Anti-glare vs glossy finish		Anti-glare	Anti-glare	Anti-glare

Fingerprint reader (optional)

The following table lists the specifications of the optional fingerprint reader of your Dell Pro Max 16 MC16250.

 **NOTE:** The fingerprint reader is on the power button.

Table 25. Fingerprint reader specifications

Description	Values
Sensor technology	Capacitive sensing
Sensor resolution	500 dpi
Sensor pixel size	108 x 88 pixels

Sensors

The following table lists the sensors of your Dell Pro Max 16 MC16250.

Table 26. Sensor

Sensor support
Accelerometer (for positional sensing)
Hall Effect Sensor

GPU—Integrated

The following table lists the specifications of the integrated Graphics Processing Unit (GPU) supported by your Dell Pro Max 16 MC16250.

Table 27. GPU—Integrated

Controller	Memory size	Processor
Intel Arc/Arc Pro Graphics	Shared system memory	Intel Core Ultra 5/7/9 non-vPro/vPro processors

GPU—Discrete

The following table lists the specifications of the discrete Graphics Processing Unit (GPU) supported by your Dell Pro Max 16 MC16250.

Table 28. GPU—Discrete

Controller	Memory size	Memory type
NVIDIA RTX Pro 500 Blackwell	6 GB	GDDR7
NVIDIA RTX Pro 1000 Blackwell	8 GB	GDDR7
NVIDIA RTX Pro 2000 Blackwell	8 GB	GDDR7

Multiple display support matrix

The following table lists the multiple display support matrix for your Dell Pro Max 16 MC16250.

Table 29. Multiple display support matrix

Graphics Card	Direct Graphics Controller Direct Output Mode	Supported external displays with computer internal display on	Supported external displays with computer internal display off
Intel Graphics	Not supported	3	4
NVIDIA Graphics	Not supported	3	4

Hardware security

The following table lists the hardware security of your Dell Pro Max 16 MC16250.

Table 30. Hardware security

Hardware security
One wedge-shaped lock slot
Windows Hello - Fingerprint Reader (optional)
Trusted Platform Module (TPM) 2.0 discrete
FIPS 140-2 certification for TPM
TCG Certification for TPM (Trusted Computing Group)
Finger Print Reader in Power Button available with and without ControlVault 3 Plus
ControlVault 3 Plus Advanced Authentication with FIPS 140-3 Level 3 Certification
Contacted Smart Card and ControlVault 3 Plus
Contactless Smart Card, NFC, and ControlVault 3 Plus
SED SSD NVMe, SSD per SDL

Smart-card reader

Contactless smart-card reader

This section lists the contactless smart-card reader specifications of your Dell Pro Max 16 MC16250.

Table 31. Contactless smart-card reader specifications

Title	Description	Dell ControlVault 3 Plus Contactless smart-card reader with NFC
Felica Card Support	Reader and software capable of supporting Felica contactless cards	Yes
Prox (Proximity) (125kHz) Card support	Reader and software capable of supporting Prox /Proximity/125 kHz contactless cards	No
ISO 14443 Type A Card Support	Reader and software capable of supporting ISO 14443 Type A contactless cards	Yes
ISO 14443 Type B Card Support	Reader and software capable of supporting ISO 14443 Type B contactless cards	Yes
ISO/IEC 21481	Reader and software capable of supporting ISO/IEC 21481 compliant contactless cards and tokens	Yes
ISO/IEC 18092	Reader and software capable of supporting ISO/IEC 21481 compliant contactless cards and tokens	Yes
ISO 15693 Card Support	Reader and software capable of supporting ISO15693 contactless cards	Yes
NFC Tag Support	Supports reading and processing of NFC compliant tag information	Yes

Table 31. Contactless smart-card reader specifications (continued)

Title	Description	Dell ControlVault 3 Plus Contactless smart-card reader with NFC
NFC Reader Mode	Support for NFC Forum Defined Reader mode	Yes
NFC Writer Mode	Support for NFC Forum Defined Writer mode	Yes
NFC Peer-to-Peer Mode	Support for NFC Forum Defined Peer to Peer mode	Yes
NFC Proximity OS Interface	Enumerates NFP (Near Field Proximity) device for operating system to utilize	Yes
PC/SC operating system interface	Personal Computer/Smart Card specification for integration of hardware readers into personal computer environments	Yes
CCID driver compliance	Common driver support for Integrated Circuit Card Interface Device for operating system level drivers	Yes
Dell ControlVault support	The device connects to Dell ControlVault for usage and processing	Yes

 **NOTE:** 125 Khz proximity cards are not supported.

Table 32. Supported cards

Manufacturer	Card
HID	jCOP readertest3 A card (14443a)
	1430 1L
	DESFire D8H
	DESFIRE 4K Standard - 1450NGGNN
	iClass 16K/16 - 2002PGGMN
	iClass SR 16K/16 - 2002HPGGMN
	iCLASS 2K tag
	iCLASS GP - 2003 PGGMN
	iClass Clamshell - 2080PMSMV
	iClass Prox 16K/16 - 2022BGGMNN
	Mifare M1P 1430 NGGNN
	iclass Prox 2020BGGMNM
	DesFire D8P 1456CSGMN
	iCLASS MIFARE Px GM49Y 2623BNPGGBNAB
	iCLASS MIFARE Px 8M1L
	iClass SEOS JW 5006PGGMN
	Crescendo iCLASS Px G8H
	iCLASS Seos IY
	SEOS JMC4 J1Y 5806VNG1NNN4
	SEOS Key FOB 5266PNNA

Table 32. Supported cards (continued)

Manufacturer	Card
	SEOS Clamshell 5656PMSAV
	SEOS + Prox 5106RGGMNN
	SEOS + DESFire 5906PNG1ANN7
	SEOS iClass 5006PGGMN7
	Seos Essential + Prox 551PPGGANN
	iCLASS 2K 2000PGGMN
	iCLASS 2K 3000PGGMN
	MIFARE DESFire 3700CPGGAN
	iCLASS DP
	DESFire 1Y
NXP/Mifare	Mifare DESFire 8K White PVC card
	Mifare Classic 1K White PVC card
	NXP Mifare Classic S50 ISO card
	Mifare DESFire 2K
	Mifare Plus S 2K/4K
	Mifare Plus X 4K
G&D	idOnDemand - SCE3.2 144K
	SCE6.0 FIPS 80K Dual + 1K Mifare
	SCE6.0 nonFIPS 80K Dual + 1K Mifare
	SCE6.0 FIPS 144K Dual + 1K Mifare
	SCE6.0 nonFIPS 144K Dual + 1K Mifare
	SCE7.0 FIPS 144K
Oberthur	idOnDemand - OCS5.2 80K
	ID-One Cosmo 64 RSA D V5.4 T = 0 card
	ID-One Cosmo 128K V5.5 card
	TOP DL GX4 144K card
	Felica RC-S962
	Felica RC-S965
	Felica RC-S966
	C910 PKI
	PIV1
	PIV programmed cards
	uTrust
	Oyster (London) MIFARE DESFire
	T-Money (Korea)
	Octopus Card (Hong Kong)
	SUIICA (Japan)

Table 33. Qualified NFC tags

NFC tag	Supported
Tap and do - NFC Forum Type 1 Tag - Topaz 512 (BCM920203)	Yes
Tap and do - NFC Forum Type 1 Tag - Topaz 512 (BCM20203T512)	Yes
Tap and do - NFC Forum Type 1 Tag - Topaz (BCM20203T96)	Yes
Tap and do - NFC Forum Type 2 Tag - Mifare UltraLight	Yes
Tap and do - NFC Forum Type 2 Tag - Mifare UltraLight C	Yes
Tap and do - NFC Forum Type 2 Tag - NTAG203	Yes
Tap and do - NFC Forum Type 3 Tag - FeliCa Lite RC-S965	Yes
Tap and do - NFC Forum Type 3 Tag - FeliCa RC-S962	Yes
Tap and do - NFC Forum Type 4 Tag - Mifare DESFire EV1Card 2K	Yes
Tap and do - NFC Forum Type 4 Tag - Mifare DESFire EV1Card 4K	Yes
Tap and do - NFC Forum Type 4 Tag - Mifare DESFire EV1Card 8K	Yes
Tap and do - ISO 15693 - Tag-it Plus	Yes
HID I-code ISO card	Yes

Contacted smart-card reader

The following table lists the contacted smart-card reader specifications of your Dell Pro Max 16 MC16250.

Table 34. Contacted smart-card reader specifications

Title	Description	Dell ControlVault 3 smart-card reader
ISO 7816 -3 Class A Card Support	Reader capable of reading 5V powered smart mcard	Yes
ISO 7816 -3 Class B Card Support	Reader capable of reading 3V powered smart card	Yes
ISO 7816 -3 Class C Card support	Reader capable of reading 1.8V powered smart card	Yes
ISO 7816-1 Compliant	Specification for the reader	Yes
ISO 7816 -2 Compliant	Specification for smart card device physical characteristics (size, location of connection points, etc.)	Yes
T=0 support	Cards support character level transmission	Yes
T=1 support	Cards support block level transmission	Yes
EMVCo Compliant	Compliant with EMVCo (for electronic payment standards) smart card standards as posted to www.emvco.com	Yes
EMVCo Certified	Formally certified based on EMVCO smart card standards	Yes

Table 34. Contacted smart-card reader specifications (continued)

Title	Description	Dell ControlVault 3 smart-card reader
PC/SC OS interface	Personal Computer/Smart Card specification for integration of hardware readers into personal computer environments	Yes
CCID driver compliance	Common driver support for Integrated Circuit Card Interface Device for OS level drivers.	Yes
Windows Certified	Device certified by WHCK	Yes
FIPS 201 (PIV/HSPD-12) Compliant via GSA	Device compliant with FIPS 201/PIV/HSPD-12 requirements	Yes
FIDO2 compliance	Dell ControlVault 3 Smart-card reader is compliant with the FIDO SPEC	Yes

Operating and storage environment

This table lists the operating and storage specifications of your Dell Pro Max 16 MC16250.

Airborne contaminant level: G1 as defined by ISA-S71.04-1985

Table 35. Computer environment

Description	Operating	Storage
Temperature range	0°C to 35°C (32°F to 95°F)	-40°C to 65°C (-40°F to 149°F)
Relative humidity (maximum)	10% to 90% (non-condensing)	0% to 95% (non-condensing)
Vibration (maximum)*	0.66 GRMS	1.30 GRMS
Shock (maximum)	110 G†	160 G†
Altitude range	-15.2 m to 3048 m (-49.87 ft to 10,000 ft)	-15.2 m to 10,668 m (-49.87 ft to 35,000 ft)
 CAUTION: Operating and storage temperature ranges may differ among components, so operating or storing the device outside these ranges may impact the performance of specific components.		

* Measured using a random vibration spectrum that simulates the user environment.

† Measured using a 2 ms half-sine pulse.

ComfortView Plus

 **WARNING: Prolonged exposure to blue light from the display may lead to long-term effects such as eye strain, eye fatigue, or damage to the eyes.**

Blue light is a color in the light spectrum which has a short wavelength and high energy. Chronic exposure to blue light, particularly from digital sources may disrupt sleep patterns and cause long-term effects such as eye strain, eye fatigue, or damage to the eyes.

The display on this computer is designed to minimize blue light and complies with TÜV Rheinland's requirement for low blue light displays.

Low blue light mode is enabled at the factory, so no further configuration is necessary.











To reduce the risk of eye strain, it is also recommended that you:

- Position the display at a comfortable viewing distance between 20 and 28 inches (50 cm and 70 cm) from your eyes.
- Blink frequently to moisten your eyes, wet your eyes with water, or apply suitable eye drops.
- Take an extended break for 20 minutes every two hours.
- Look away from your display, and gaze at a distant object at 20 ft (609.60 cm) away for at least 20 seconds during each break.

Working inside your computer

Safety instructions

Use the following safety guidelines to protect your computer from potential damage and to ensure your personal safety. Unless otherwise noted, each procedure in this document assumes that you have read the safety information that shipped with your computer.

-  **WARNING:** Before working inside your computer, read the safety information that is shipped with your computer. For more safety best practices, see [Dell Regulatory Compliance Home Page](#).
-  **WARNING:** Disconnect your computer from all power sources before opening the computer cover or panels. After you finish working inside the computer, replace all covers, panels, and screws before connecting your computer to an electrical outlet.
-  **WARNING:** For laptops, discharge the battery completely before removing it. Disconnect the AC power adapter from the computer and operate the computer solely on battery power—the battery is fully discharged when the computer no longer turns on when the power button is pressed.
-  **CAUTION:** To avoid damaging the computer, ensure that the work surface is flat, dry, and clean.
-  **CAUTION:** You should only perform troubleshooting and repairs as authorized or directed by the Dell technical support team. Damage due to servicing that is not authorized by Dell is not covered by your warranty.
-  **CAUTION:** Before touching anything inside your computer, ground yourself by touching an unpainted metal surface, such as the metal at the back of the computer. While you work, periodically touch an unpainted metal surface to dissipate static electricity which could harm internal components.
-  **CAUTION:** To avoid damaging the components and cards, handle them by their edges, and avoid touching the pins and the contacts.
-  **CAUTION:** When you disconnect a cable, pull it by its connector or its pull tab, not the cable itself. Some cables have connectors with locking tabs or thumbscrews that you must disengage before disconnecting the cable. When disconnecting cables, keep them evenly aligned to avoid bending the connector pins. When connecting cables, ensure that the connector on the cable is correctly oriented and aligned with the port.
-  **CAUTION:** Press and eject any installed card from the media-card reader.
-  **CAUTION:** Exercise caution when handling rechargeable Li-ion batteries in laptops. Swollen batteries should not be used and should be replaced and disposed properly.

Before working inside your computer

About this task

 **NOTE:** The images in this document may differ from your computer depending on the configuration you ordered.

Steps

1. Save and close all open files and exit all open applications.
2. Shut down your computer. For Windows operating system, click **Start** >  **Power** > **Shut down**.

 **NOTE:** If you are using a different operating system, see the documentation of your operating system for instructions.

3. Turn off all the attached peripherals.
4. Disconnect your computer from the electrical outlet.
5. Disconnect all attached network devices and peripherals, such as keyboard, mouse, and monitor from your computer.
6. Remove any media card and optical drive from your computer, if applicable.
7. To clean the air vents, use a soft brush and move vertically.

 **NOTE:** Do not remove the base cover or use any blower to clean the vents.

8. Enter the Service Mode.

Service Mode

Service Mode is used to cut off power without disconnecting the battery cable from the system board before conducting repairs in the computer.

 **CAUTION:** If you are unable to turn on the computer to put it into Service Mode, disconnect the battery cable. To disconnect the battery cable, follow the steps in [Removing the battery](#).

 **NOTE:** Ensure that your computer is shut down and the power adapter is disconnected.

- a. Press and hold the B key and the power button for 3 seconds, or until the Dell logo appears on the screen.
- b. If the **Owner Tag** is set, it is displayed on the screen. Press any key to continue.

 **NOTE:** If the **Owner Tag** information is not already set, the computer automatically skips this step and proceeds to enter Service Mode.

- c. If the power adapter is still connected, a message appears on the screen prompting you to disconnect it. Disconnect the power adapter, then press any key to continue.
- d. When the **System Ready For Service** message appears on the screen, press any key to proceed. The computer emits three short beeps and shuts down immediately. The computer shuts down and enters the Service Mode.

Safety precautions

This section details the primary steps to be followed before disassembling any device or component.

Observe the following safety precautions before any installation or break-fix procedures involving disassembly or reassembly:

- Turn off the computer and all attached peripherals.
- Disconnect the computer from AC power.
- Disconnect all network cables and peripherals from the computer.
- Use an ESD field service kit when working inside your computer to avoid electrostatic discharge (ESD) damage.
- Place the removed component on an anti-static mat after removing it from the computer.
- Press and hold the power button for 15 seconds to discharge the residual power in the system board.

Bonding

Bonding is a method for connecting two or more grounding conductors to the same electrical potential. This is done by using a field service electrostatic discharge (ESD) kit. When connecting a bonding wire, ensure that it is connected to bare metal and never to a painted or nonmetal surface. Ensure that the wrist strap is secure and in full contact with your skin. Remove all jewelry, watches, bracelets, or rings before grounding yourself and the equipment.

Electrostatic discharge—ESD protection

ESD is a major concern when you handle electronic components, especially sensitive components such as expansion cards, processors, memory modules, and system boards. A slight charge can damage circuits in ways that may not be obvious, such as intermittent problems or a shortened product life span. As the industry pushes for lower power requirements and increased density, ESD protection is an increasing concern.

Two recognized types of ESD damage are catastrophic and intermittent failures.

- **Catastrophic** – Catastrophic failures represent approximately 20 percent of ESD-related failures. The damage causes an immediate and complete loss of device functionality. An example of catastrophic failure is a memory module that has

received a static shock and immediately generates a "No POST/No Video" symptom with a beep code that is emitted for missing or nonfunctional memory.

- **Intermittent** – Intermittent failures represent approximately 80 percent of ESD-related failures. The high rate of intermittent failures means that most of the time when damage occurs, it is not immediately recognizable. The memory module receives a static shock, but the tracing is merely weakened and does not immediately produce outward symptoms that are related to the damage. The weakened trace may take weeks or months to melt, and in the meantime may cause degradation of memory integrity, intermittent memory errors, and so on.

Intermittent failures that are also called latent or "walking wounded" are difficult to detect and troubleshoot.

Perform the following steps to prevent ESD damage:

- Use a wired ESD wrist strap that is properly grounded. Wireless anti-static straps do not provide adequate protection. Touching the chassis before handling parts does not ensure adequate ESD protection on parts with increased sensitivity to ESD damage.
- Handle all static-sensitive components in a static-safe area. If possible, use anti-static floor pads and workbench pads.
- When unpacking a static-sensitive component from its shipping carton, do not remove the component from the anti-static packing material until you are ready to install the component. Before unwrapping the anti-static packaging, use the anti-static wrist strap to discharge the static electricity from your body.

i NOTE: You can protect against ESD and discharge static electricity from your body by touching a metal-grounded object before you interact with anything electronic, for example, an unpainted metal surface on your computer's I/O panel. When connecting a peripheral (including handheld digital assistants) to your computer, you should always ground both yourself and the peripheral before connecting it to the computer. In addition, as you work inside the computer, periodically touch a metal-grounded object to remove any static charge that your body may have accumulated.

For more information about the wrist strap and ESD wrist strap tester, see [Components of an ESD Field Service Kit](#).

- Before transporting a static-sensitive component, place it in an anti-static container or packaging.

ESD Field Service kit

The unmonitored field service kit is the most commonly used service kit. Each Field Service kit includes three main components: anti-static mat, wrist strap, and bonding wire.

⚠ CAUTION: It is critical to keep ESD-sensitive devices away from internal parts that are insulated and often highly charged, such as plastic heat sink casings.

Working environment

Before the ESD Field Service kit is deployed, conduct an evaluation of the site to ensure proper setup and readiness. For example, deploying the kit for a server environment is different than for a desktop or laptop environment. Servers are typically installed in a rack within a data center; desktops or laptops are typically placed on office desks or cubicles. Always look for a large open flat work area that is free of clutter and large enough to deploy the ESD kit with additional space to accommodate the type of computer that is being repaired. The workspace should also be free of insulators that can cause an ESD event. On the work area, insulators such as styrofoam and other plastics should always be moved at least 12 inches or 30 centimeters away from sensitive parts before physically handling any hardware components.

ESD packaging

All ESD-sensitive devices must be shipped and received in static-safe packaging. Metal, static-shielded bags are preferred. However, you should always return the damaged component using the same ESD bag and packaging that the new part arrived in. The ESD bag should be folded over and taped shut and all the same foam packing material should be used in the original box that the new part arrived in. ESD-sensitive devices should be removed from packaging only at an ESD-protected work surface, and parts should never be placed on top of the ESD bag because only the inside of the bag is shielded. Always place parts in your hand, on the anti-static mat, in the computer, or inside an ESD bag.

Components of an ESD Field Service kit

The components of an ESD Field Service kit are:

- **Anti-Static Mat** – The anti-static mat is dissipative and parts can be placed on it during service procedures. When using an anti-static mat, your wrist strap should be snug and the bonding wire should be connected to the anti-static mat and to any bare metal on the computer being worked on. Once deployed properly, service parts can be removed from the ESD bag and placed directly on the anti-static mat. ESD-sensitive items are safe in your hand, on the anti-static mat, in the computer, or inside an ESD bag.
- **Wrist Strap and Bonding Wire** – If an anti-static mat is not being used, the wrist strap and bonding wire should be connected directly between your wrist and an exposed metal part of the hardware. If you are using an anti-static mat, connect the wrist strap and bonding wire to the anti-static mat to ensure protection for any hardware placed on the mat. The physical connection of the wrist strap and bonding wire between your skin, the anti-static mat, and the hardware is known as bonding. Use only Field Service kits with a wrist strap, anti-static mat, and bonding wire. Never use wireless wrist straps. Always be cautious that the internal wires of a wrist strap are prone to damage from normal wear and tear, and must be checked regularly with a wrist strap tester in order to avoid accidental ESD hardware damage. It is recommended to test the wrist strap and bonding wire at least once per week.
- **ESD Wrist Strap Tester** – The wires inside an ESD strap are prone to damage over time. When using an unmonitored ESD kit, it is recommended to test the wrist strap regularly—ideally before each service session, and at a minimum, once per week. The most reliable method for testing is with a wrist strap tester. To perform the test, connect the bonding wire of the wrist strap to the tester while wearing the strap. Press the test button to initiate the check. A green LED indicates a successful test, while a red LED and audible alarm signal a failure.

NOTE: It is recommended to always use the traditional wired ESD grounding wrist strap and protective anti-static mat when servicing Dell products. In addition, it is critical to keep sensitive parts separate from all insulator parts while servicing the computer.

Transporting sensitive components

When transporting ESD sensitive components such as replacement parts or parts to be returned to Dell, it is critical to place these parts in anti-static bags for safe transport.

After working inside your computer

About this task

CAUTION: Leaving stray or loose screws inside your computer may severely damage your computer.

Steps

1. Replace all screws and ensure that no stray screws remain inside your computer.
2. Connect any external devices, peripherals, or cables you removed before working on your computer.
3. Replace any media cards, disks, or any other parts that you removed before working on your computer.
4. Connect your computer to their electrical outlets.

NOTE: To exit service mode, ensure to connect the AC adapter to the power-adaptor port on your computer.

5. Press the power button to turn on the computer.

BitLocker

When updating the BIOS on a computer with BitLocker enabled, consider the following precautions.

CAUTION: If BitLocker is not suspended before updating the BIOS, the BitLocker key will not be recognized the next time that you reboot the computer. You are prompted to enter the recovery key to progress, and the computer displays a prompt for the recovery key on each reboot. If the recovery key is not known, this can result in data loss or an operating system reinstall. For more information, see Knowledge Article: [updating the BIOS on Dell computers with BitLocker enabled](#).

The installation of the following components triggers BitLocker:

- Hard disk drive or solid state drive
- System board

Recommended tools

The procedures in this document may require the following tools:

- Phillips screwdriver #0
- Flat-headed screwdriver (maximum width: 4 mm)
- Plastic scribe

Screw list

NOTE: When removing screws from a component, it is recommended to note the screw type and the quantity of screws, and then place them in a screw storage box. This is to ensure that the correct number of screws and correct screw type is restored when the component is replaced.

NOTE: Some computers have magnetic surfaces. Ensure that the screws are not left attached to such surfaces when replacing a component.

NOTE: Screw color may vary depending on the configuration ordered.

Table 36. Screw list



























Component	Screw type	Quantity	Screw image
Base cover	Captive screw NOTE: Screws are part of the base cover.	9	
Battery	M2x4	8	
Solid state drive	M2x4	1	
Wireless-card bracket	M2x3	1	
WWAN-module shield	M2x3	2	
WWAN-module bracket	M2x3	1	
Darwin-cable bracket	M2x3	1	
Speakers	M1.6x3	4	
Right/Processor fan	M2x4	2	
Left/Video fan	M2x4	2	
Heat sink	Captive screw NOTE: Screws are part of the heat sink.	4	
GPU filler	M2x3	2	

Table 36. Screw list (continued)

Component	Screw type	Quantity	Screw image
Battery frame	M2x3	10	
USH board	M2x2	2	
Smart-card reader	M2x2	3	
Display-cable bracket	M2x3	3	
Display assembly	M2.5x5	6	
Display panel	M2x3	4	
Display hinges	M2.5x3.5	6	
Fingerprint-reader bracket	M2x3	1	
System board	M2x4	2	
	M2x3	3 or 4	
USB Type-C module	M2x5	3	
Power button	M2x2	2	
Keyboard	M2x2.2	20	
Keyboard bracket	M2x2.2	9	

Major components of Dell Pro Max 16 MC16250

The following image shows the major components of Dell Pro Max 16 MC16250.

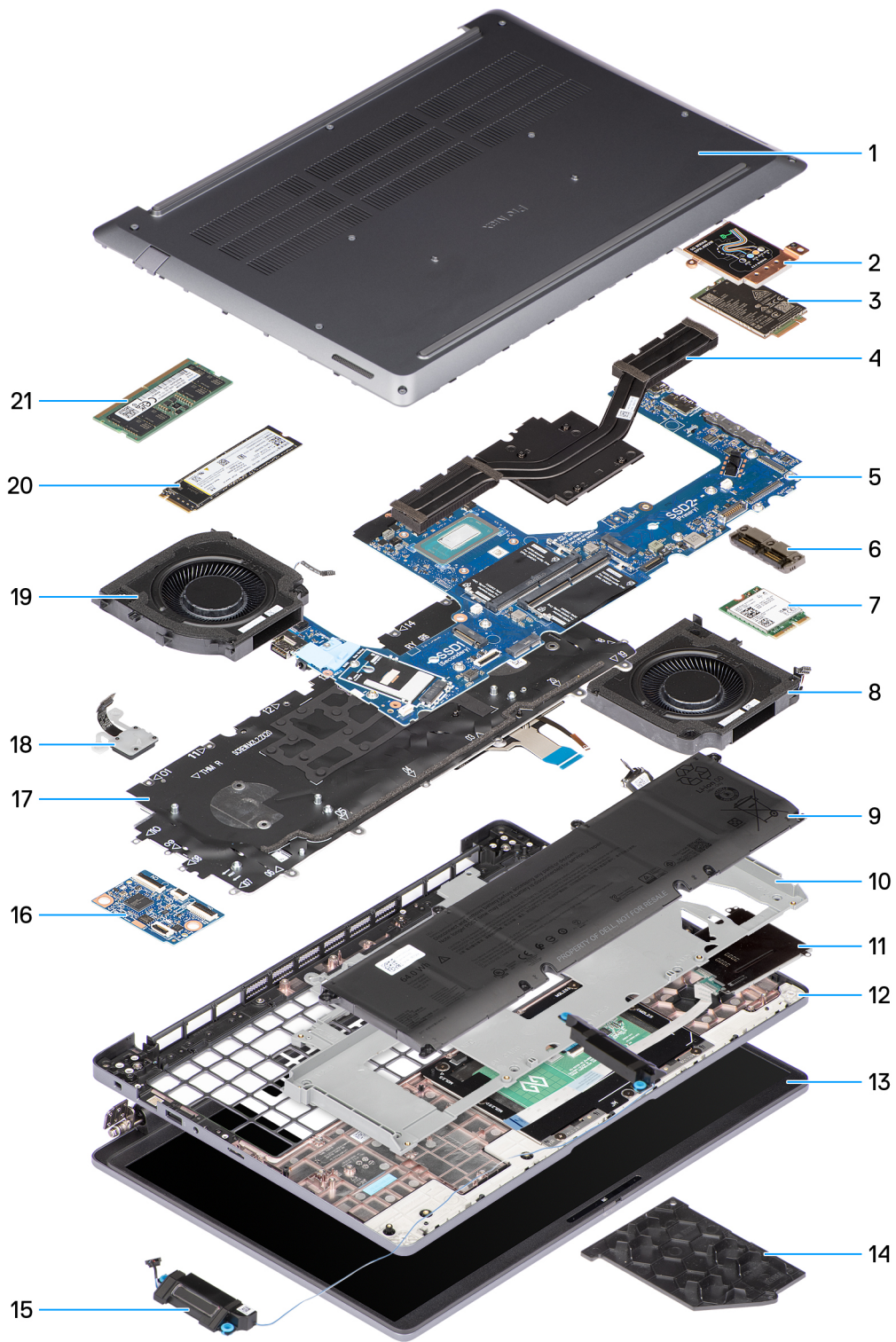



Figure 11. Major components of your Dell Pro Max 16 MC16250

1. Base cover
2. WWAN-module shield
3. WWAN module
4. Heat sink
5. System board
6. USB Type-C module
7. Wireless card

8. Left/Video fan
9. Battery
10. Battery frame
11. Palm-rest assembly
12. Display assembly
13. GPU filler
14. Speakers
15. USH board
16. Keyboard assembly
17. Power button with optional fingerprint reader
18. Right/Processor fan
19. Solid state drive
20. Memory module

 **NOTE:** Dell Technologies provides a list of components and their part numbers for the original system configuration purchased. These parts are available according to warranty coverages purchased by the customer. Contact your Dell sales representative for purchase options.

Removing and installing Customer Replaceable Units (CRUs)

The replaceable components in this chapter are Customer Replaceable Units (CRUs).

 **CAUTION:** Customers can replace only the Customer Replaceable Units (CRUs) following the safety precautions and replacement procedures.

 **NOTE:** The images in this document may differ from your computer depending on the configuration you ordered.

Base cover

Removing the base cover

Prerequisites

1. Follow the procedure in [Before working inside your computer](#).

 **CAUTION:** Ensure that your computer is in Service Mode. If the computer does not turn on, does not enter Service Mode, or does not support Service Mode, proceed to disconnect the battery cable.

About this task

The following images indicate the location of the base cover and provide a visual representation of the removal procedure.



9x

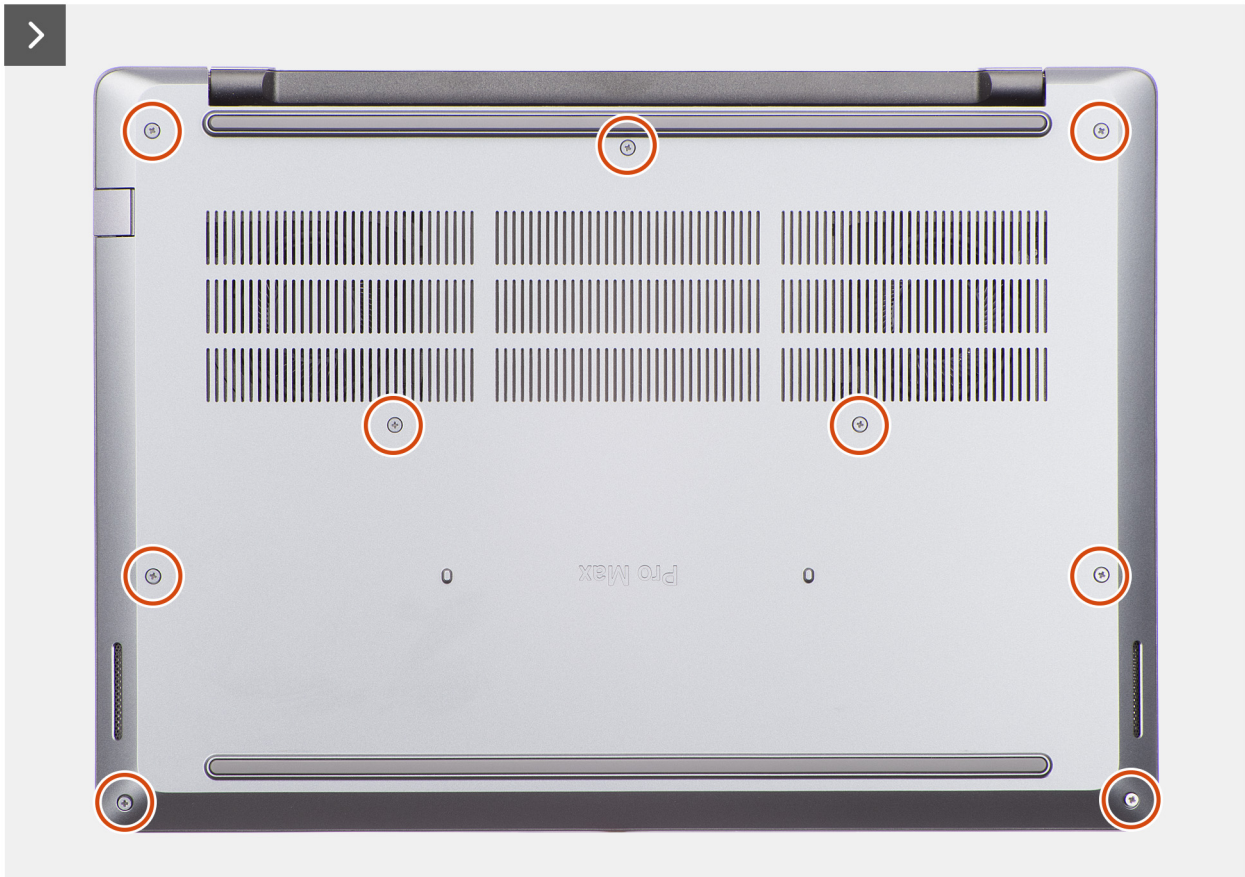

Figure 12. Removing the base cover

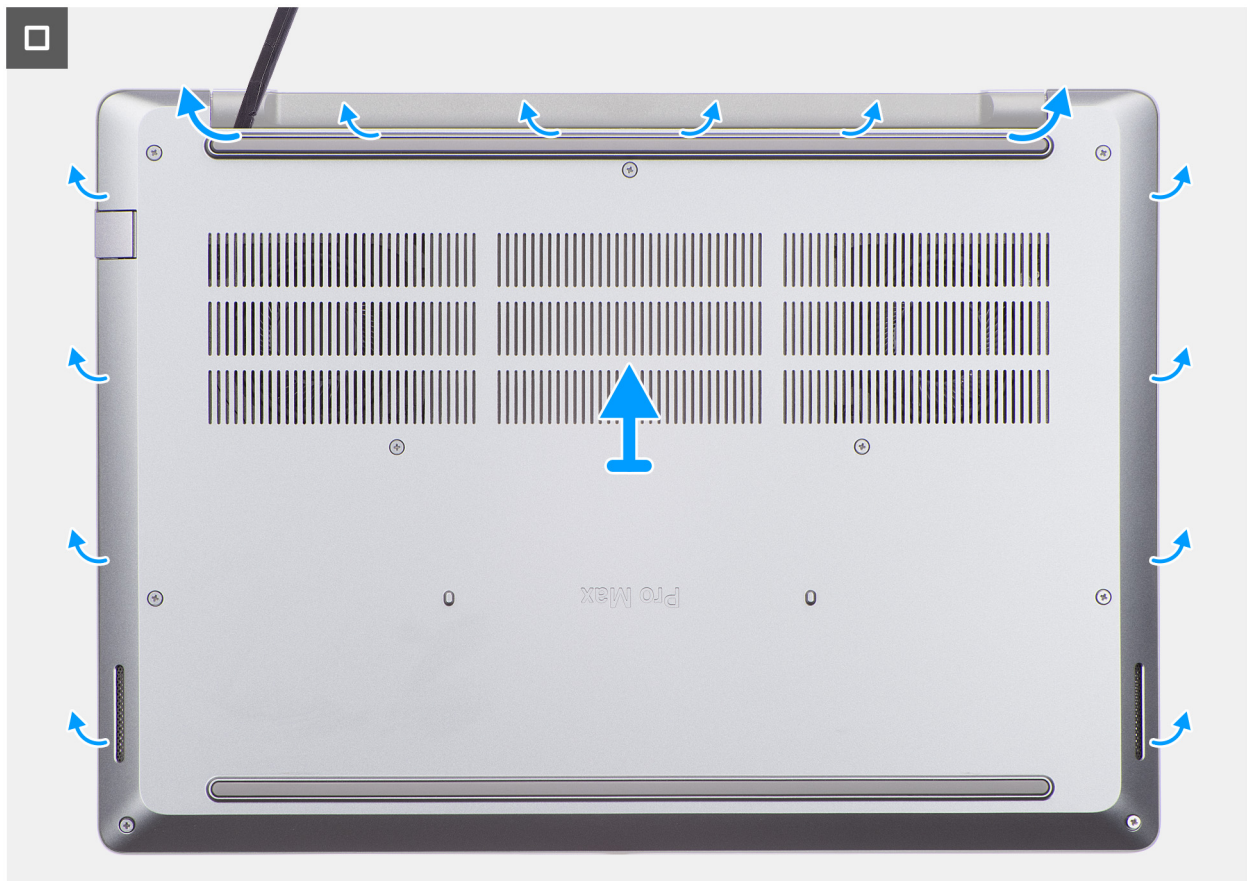

Figure 13. Removing the base cover

Steps

1. Loosen the nine captive screws that secure the base cover to the palm-rest assembly.
2. Using a plastic scribe, pry open the base cover starting from the recesses, which are located at the top edge of the base cover, near the hinges.

CAUTION: Do not slide the scribe along the edges of the base cover as it may damage the latches inside the base cover. Instead, insert the scribe at regular intervals and pry open the base cover.

3. Pry open the top of the base cover followed by the left, right, and bottom to release the base cover.
4. Lift the base cover off the palm-rest assembly.

NOTE: Ensure that your computer is in Service Mode. If your computer is unable to enter Service Mode, then disconnect the battery cable from the system board.

5. Disconnect the battery cable from the battery cable connector (BATT1) on the system board.



Figure 14. Removing the battery cable

6. Press and hold the power button for five seconds to ground the computer and drain the flea power.

Installing the base cover

Prerequisites

If you are replacing a component, remove the existing component before performing the installation procedure.

About this task

The following images indicate the location of the base cover and provide a visual representation of the installation procedure.



9x

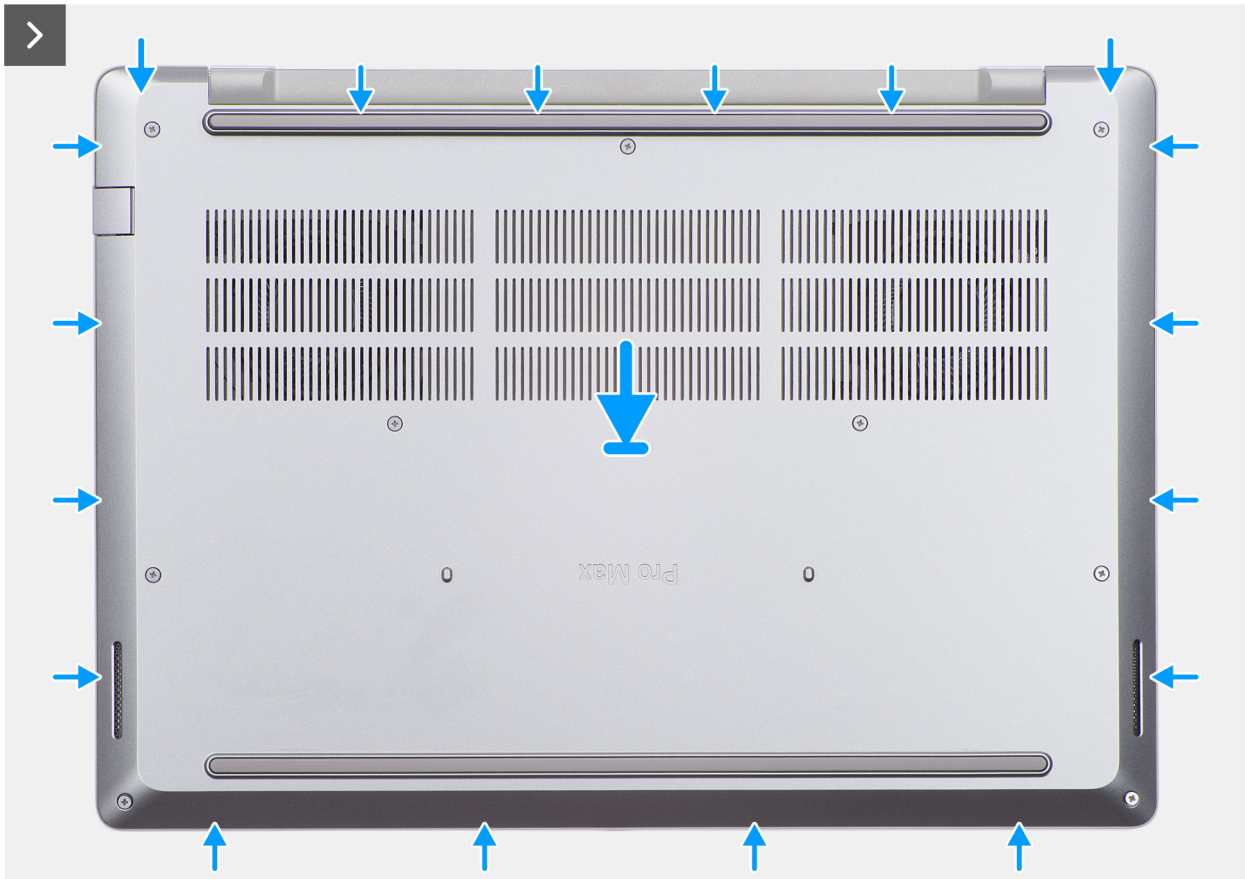

Figure 15. Installing the base cover

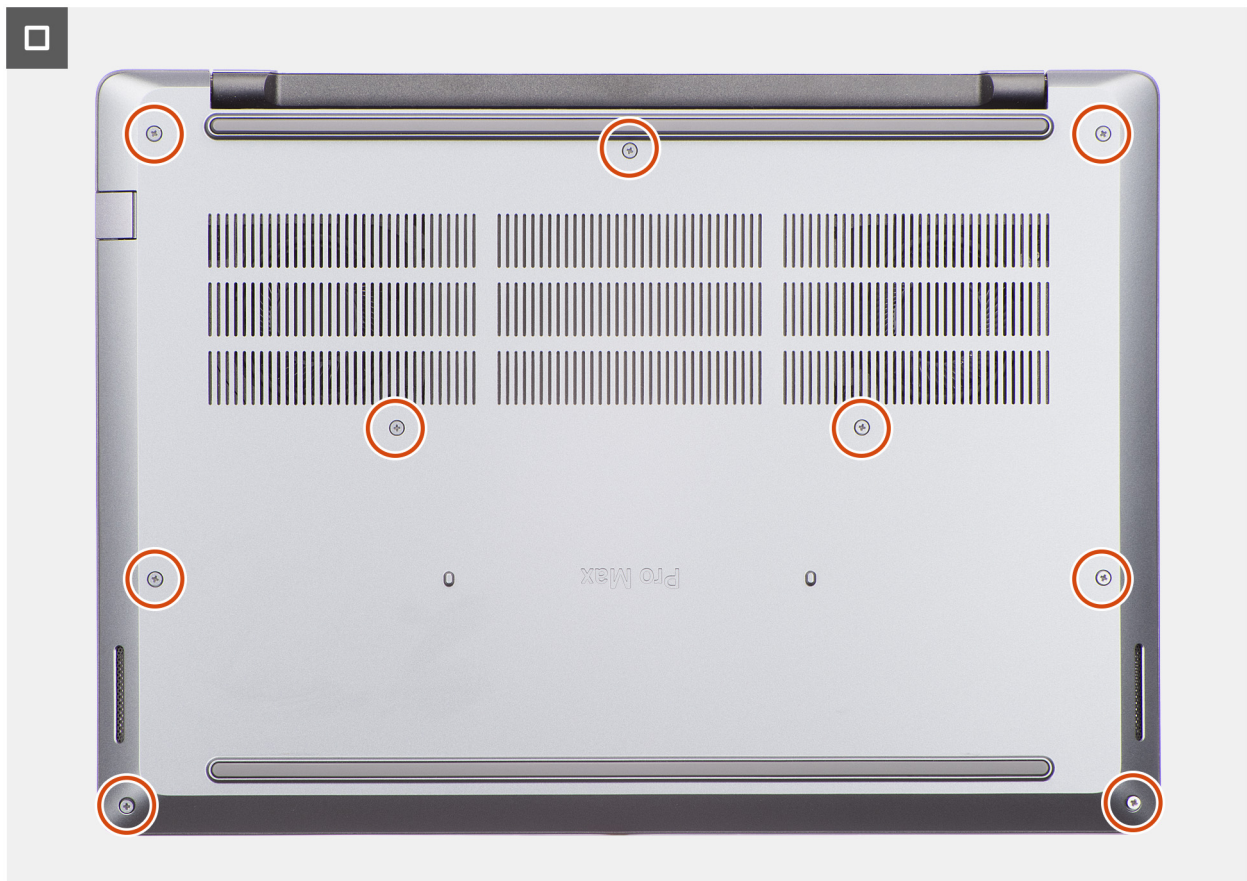

Figure 16. Installing the base cover

Steps

1. Connect the battery cable to the connector (BATT1) on the system board.
i **NOTE:** This step applies only to computers that are not in Service Mode.
2. Place the base cover on the palm-rest assembly.
3. Align the screw holes on the base cover with the screw holes on the palm-rest assembly, and then snap the base cover into place.
4. Tighten the nine captive screws to secure the base cover to the palm-rest assembly.

Next steps

1. Follow the procedure in [After working inside your computer](#).

Battery

Rechargeable Li-ion battery precautions

WARNING:

- Exercise caution when handling rechargeable Li-ion batteries.
- Discharge the battery completely before removing it. Disconnect the AC power adapter from the computer and operate the computer solely on battery power—the battery is fully discharged when the computer no longer turns on when the power button is pressed.
- Do not crush, drop, mutilate, or penetrate the battery with foreign objects.
- Do not expose the battery to high temperatures, or disassemble battery packs and cells.

- Do not apply pressure to the surface of the battery.
- Do not bend the battery.
- Do not use tools of any kind to pry on or against the battery.
- To prevent accidental puncture or damage to the battery and other components, ensure that no screws are lost or misplaced during the servicing of the computer.
- Always purchase genuine batteries from [Dell Site](#) or authorized Dell partners and resellers.
- Swollen batteries should not be used and should be replaced and disposed properly. For guidelines on how to handle and replace swollen rechargeable Li-ion batteries, see [Handling swollen rechargeable Li-ion batteries](#).

Removing the battery

Prerequisites

1. Follow the procedure in [Before working inside your computer](#).
2. Remove the [base cover](#).

About this task

CAUTION: Removing the battery resets the BIOS setup settings to default. It is recommended that you note the BIOS setup settings before removing the battery.

The following image indicates the location of the battery and provides a visual representation of the removal procedure.

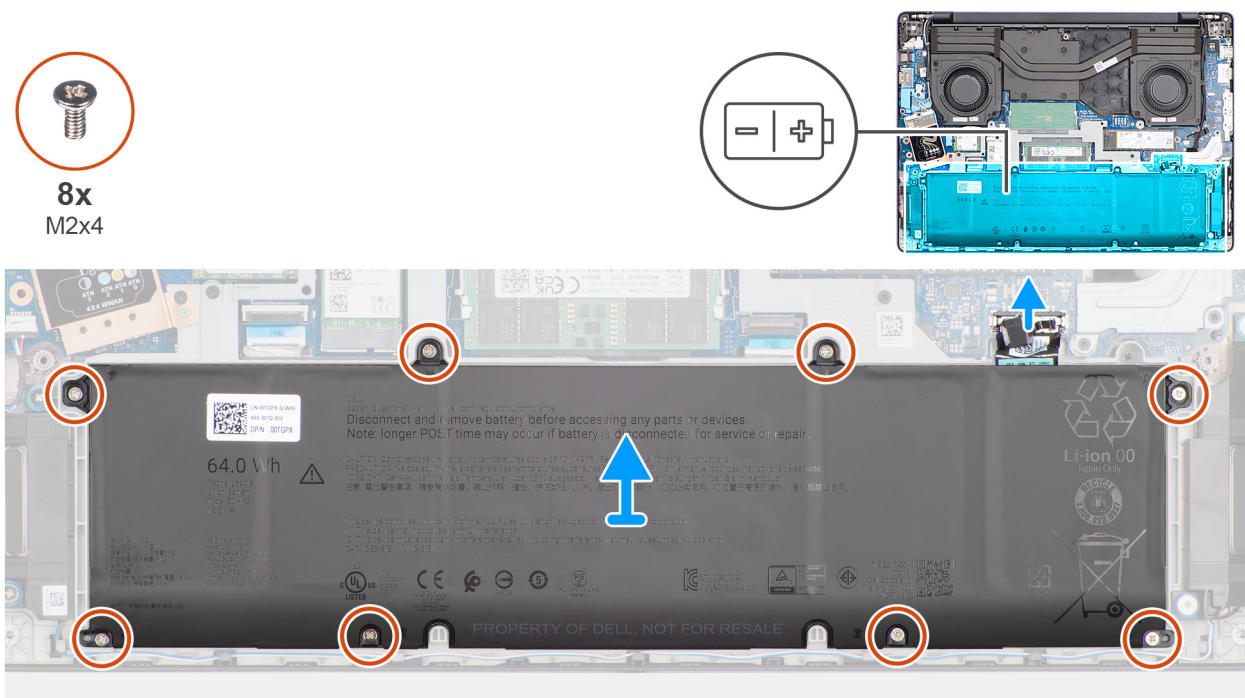

Figure 17. Removing the battery

Steps

1. Disconnect the battery cable from the connector (BATT1) on the system board.
2. Remove the eight screws (M2x4) that secure the battery to the battery frame.
3. Lift the battery, along with the battery cable, off the palm-rest assembly.

Installing the battery

Prerequisites

If you are replacing a component, remove the existing component before performing the installation procedure.

About this task

The following image indicates the location of the battery and provides a visual representation of the installation procedure.

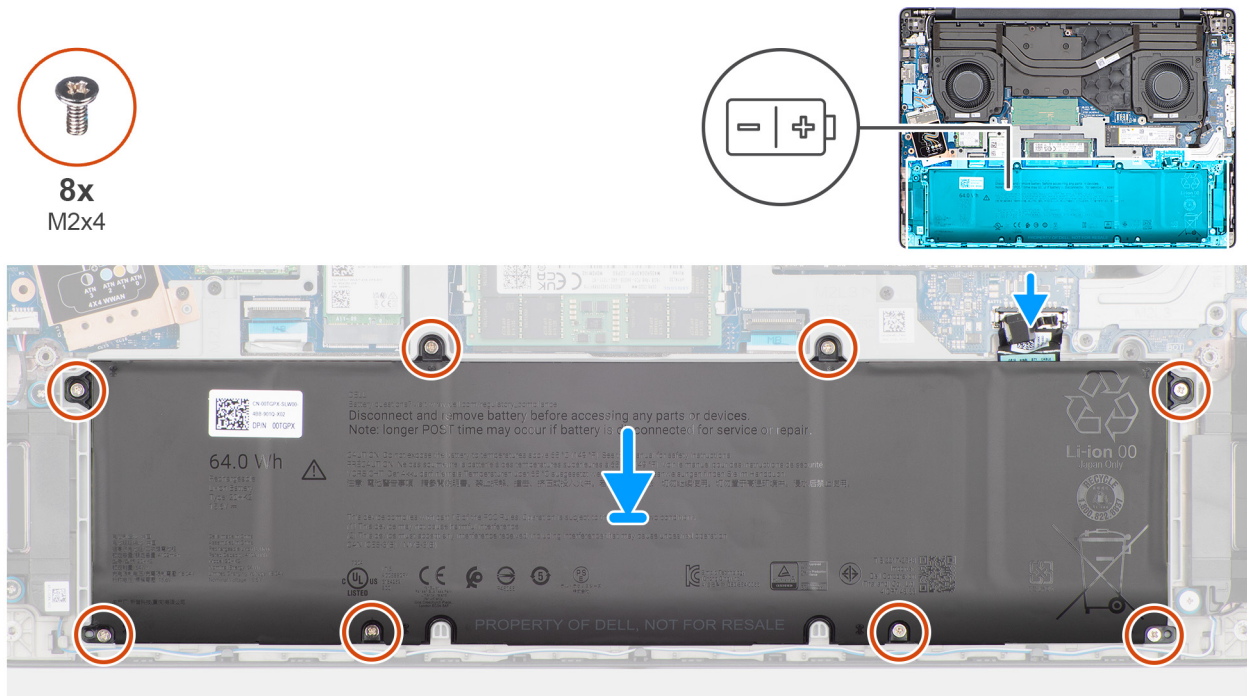

Figure 18. Installing the battery

Steps

1. Place the battery, along with the battery cable, in the battery frame on the palm-rest assembly.
2. Align the screw holes on the battery with the screw holes on the battery frame.
3. Replace the eight screws (M2x4) to secure the battery to the battery frame.
4. Connect the battery cable to the connector (BATT1) on the system board.

Next steps

1. Install the [base cover](#).
2. Follow the procedure in [After working inside your computer](#).

Battery cable

Disconnecting the battery cable

Prerequisites

1. Follow the procedure in [Before working inside your computer](#).
2. Remove the [base cover](#).
3. Remove the [battery](#).

About this task

The following image indicates the location of the battery cable and provides a visual representation of the removal procedure.

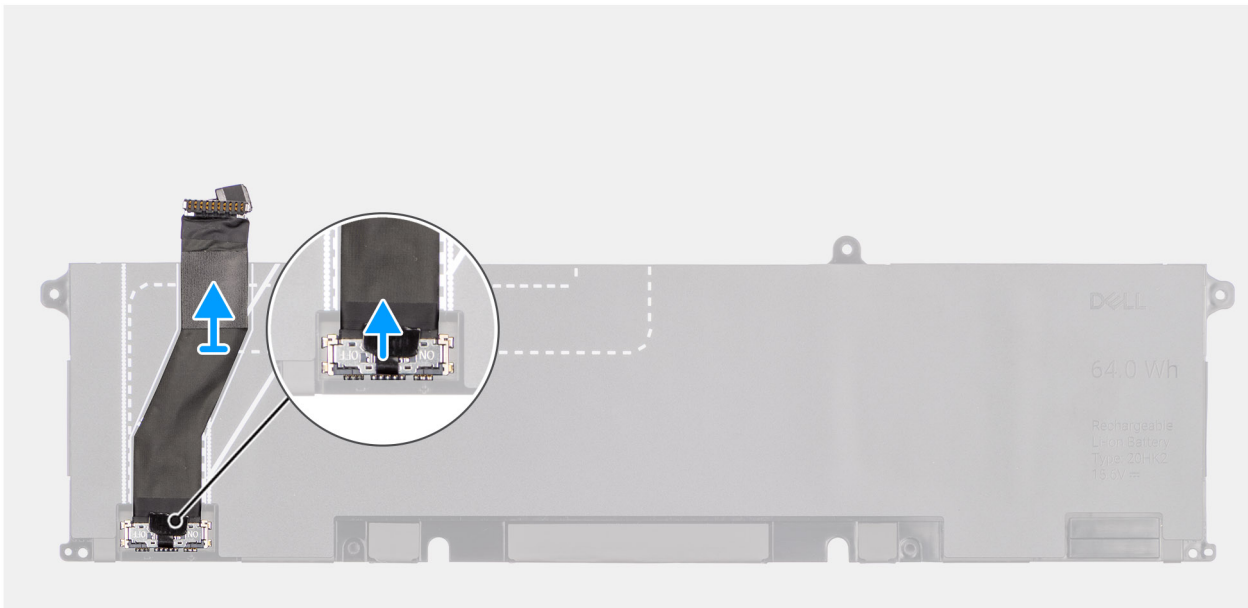

Figure 19. Disconnecting the battery cable

Steps

1. Peel back the battery cable from the battery.
2. Disconnect the battery cable from the connector on the battery.

Connecting the battery cable

Prerequisites

If you are replacing a component, remove the existing component before performing the installation procedure.

About this task

The following image indicates the location of the battery cable and provides a visual representation of the installation procedure.

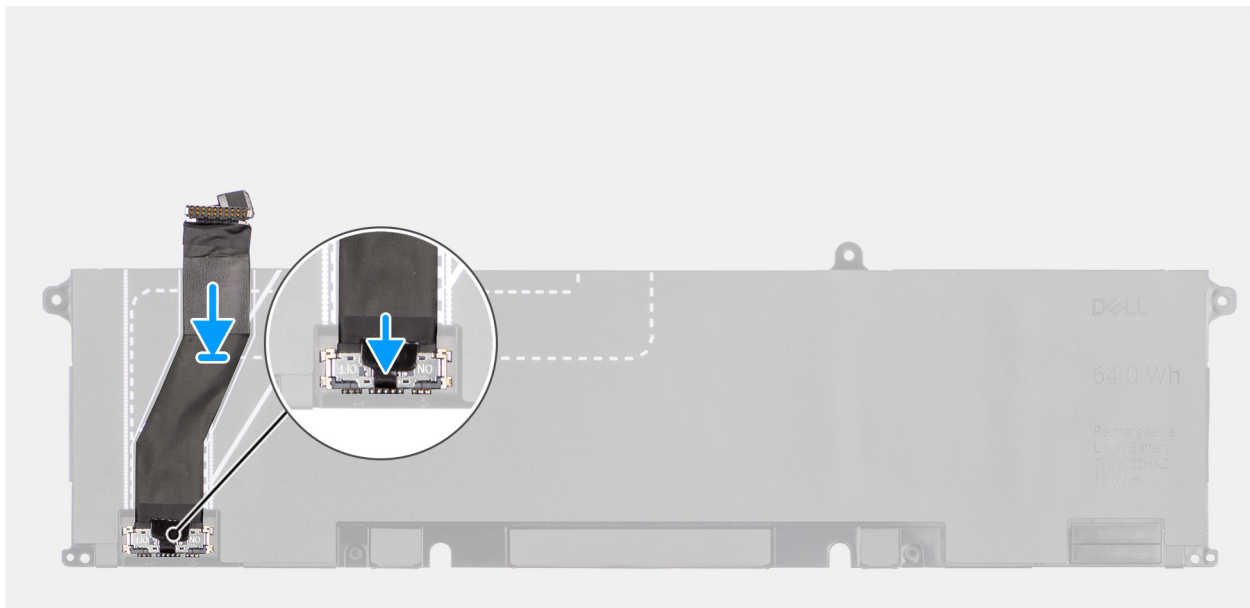

Figure 20. Connecting the battery cable

Steps

1. Connect the battery cable to the connector on the battery.

NOTE: The connector on the battery cable has a switch that enables power supply to the computer. When connecting the battery cable to the battery, ensure that the switch on the connector is turned on.

2. Adhere the battery cable to the battery.

Next steps

1. Install the [battery](#).
2. Install the [base cover](#).
3. Follow the procedure in [After working inside your computer](#).

Memory module

Removing the memory module

Prerequisites

1. Follow the procedure in [Before working inside your computer](#).
2. Remove the [base cover](#).

About this task

The following images indicate the location of the memory module and provide a visual representation of the removal procedure.

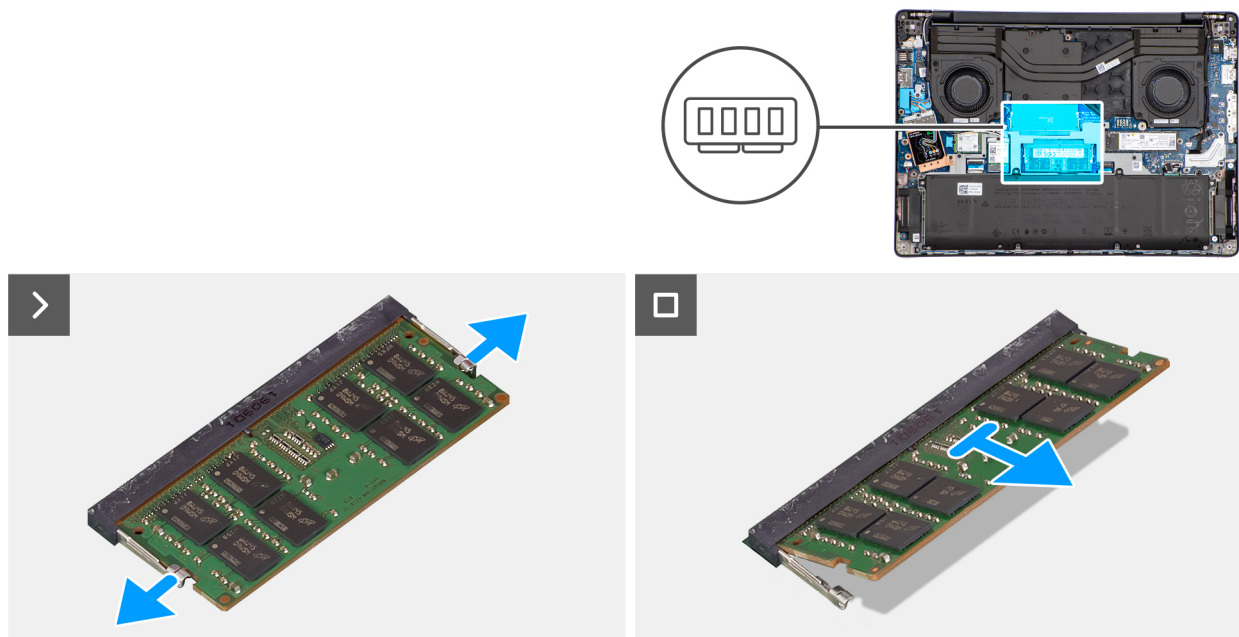

Figure 21. Removing the memory module

Steps

1. Gently pull the memory-module retention clips away from the memory module until the memory module pops-up.
2. Hold the memory module and remove it from the memory-module slot (DIMM1 or DIMM2, whichever is applicable) on the system board.

CAUTION: To prevent damage to the memory module, hold the memory module by the edges. Do not touch the components or metallic contacts on the memory module as electrostatic discharge (ESD) can inflict severe damage on the components. To read more about ESD protection, see [ESD protection](#).

3. Repeat steps 1 and 2 for the second memory module, if installed.

Installing the memory module

Prerequisites

If you are replacing a component, remove the existing component before performing the installation procedure.

About this task

The following images indicate the location of the memory module and provide a visual representation of the installation procedure.

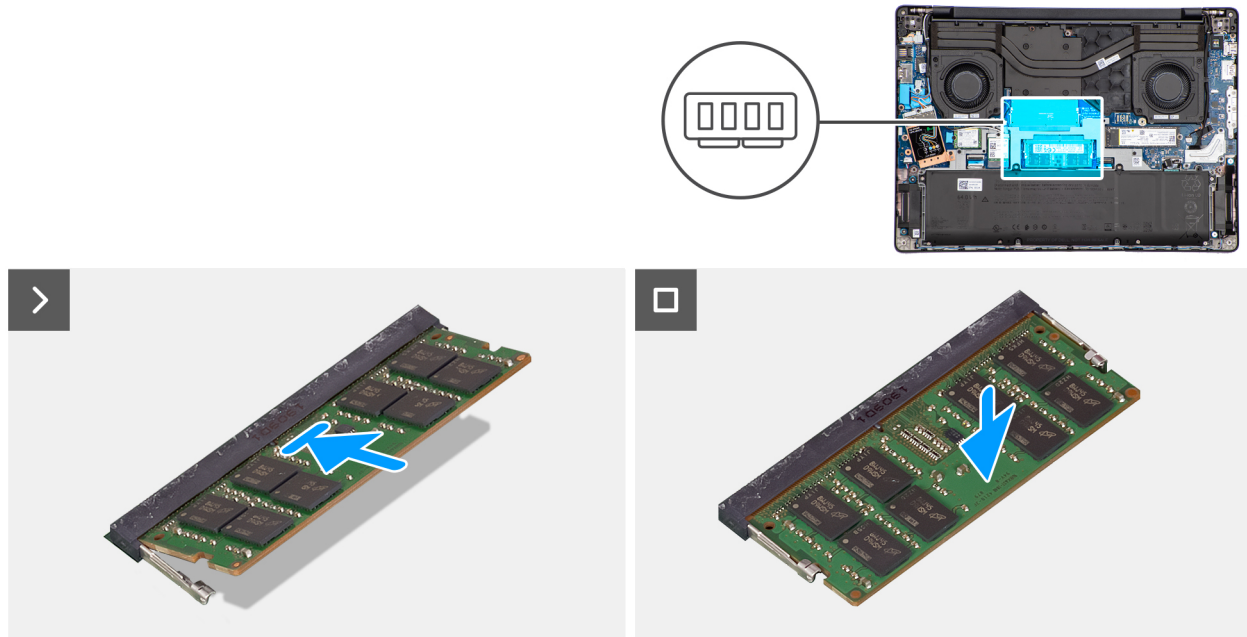

Figure 22. Installing the memory module

Steps

1. Align the notch on the memory module with the tab on the memory-module slot (DIMM1 or DIMM2, whichever is applicable) on the system board.
2. Slide the memory module firmly into the memory-module slot at an angle.
3. Press down on the memory module until the securing clips firmly click into place.

CAUTION: To prevent damage to the memory module, hold the memory module by the edges. Do not touch the components or metallic contacts on the memory module as electrostatic discharge (ESD) can inflict severe damage on the components. To read more about ESD protection, see [ESD protection](#).

NOTE: If you do not hear the click, remove the memory module and reinstall it.

4. Repeat steps 1 to 3 to install the second memory module, if applicable.

Next steps

1. Install the [base cover](#).
2. Follow the procedure in [After working inside your computer](#).

Solid-state drive

Removing the M.2 2230 solid state drive

Prerequisites

1. Follow the procedure in [Before working inside your computer](#).
2. Remove the [base cover](#).

About this task

The following images indicate the location of the M.2 2230 solid state drive (SSD) and provide a visual representation of the removal procedure.

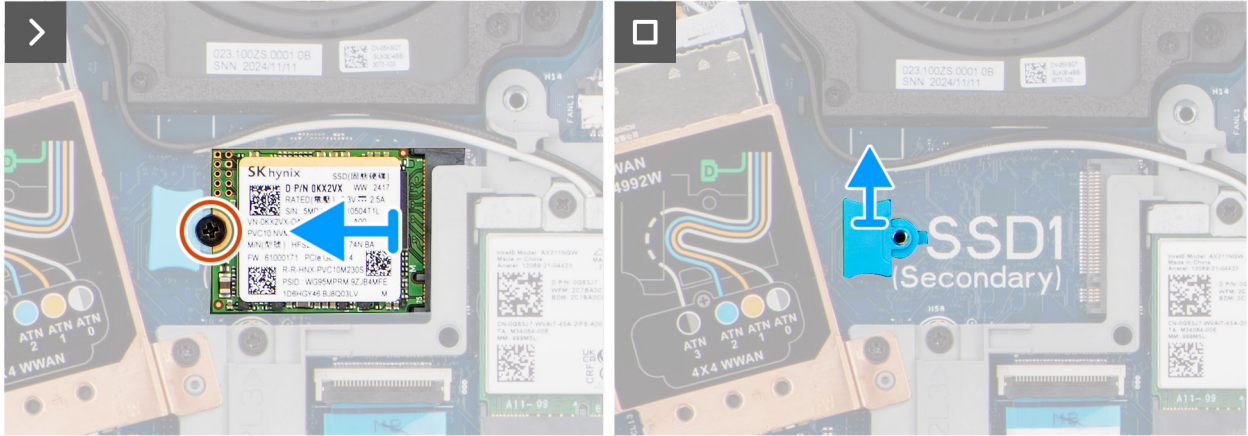
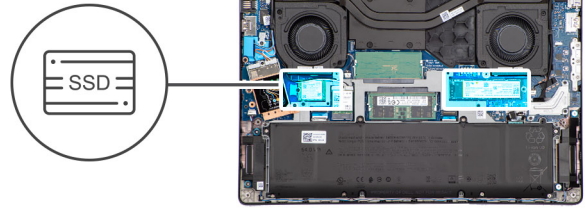



Figure 23. Removing the M.2 2230 solid state drive

Steps

1. Remove the screw (M2x4) that secures the M.2 2230 solid state drive to the palm-rest assembly.
2. Remove the M.2 2230 solid state drive from the M.2 card slot (SSD1 or SSD2, whichever is applicable) on the system board.
3. Remove the M.2.2230 SSD holder from the system board.

 **NOTE:** This step applies only if you are replacing a M.2 2230 solid state drive with a M.2 2280 solid state drive.

Installing the M.2 2230 solid state drive

Prerequisites

If you are replacing a component, remove the existing component before performing the installation procedure.

About this task

The following images indicate the location of the M.2 2230 solid state drive (SSD) and provide a visual representation of the installation procedure.



1x
M2x4

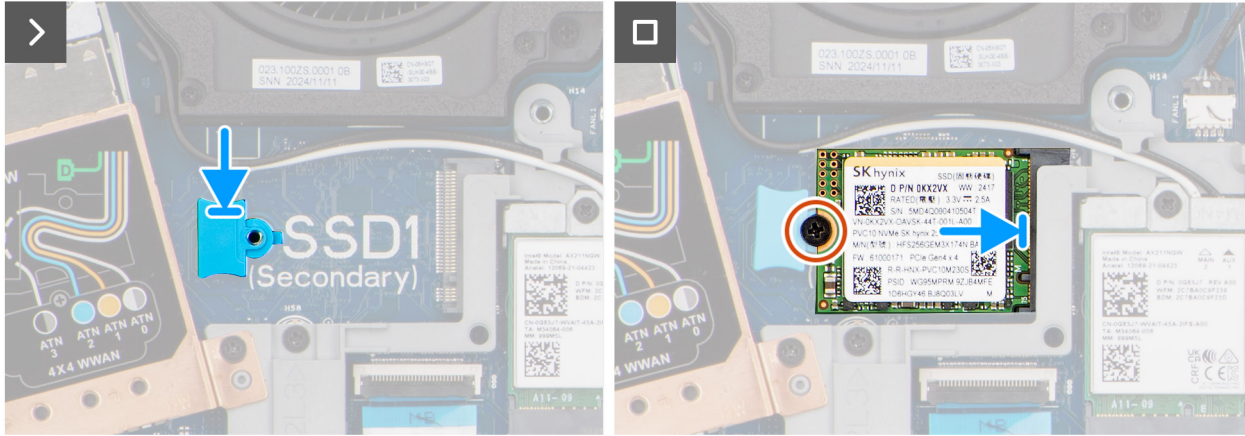
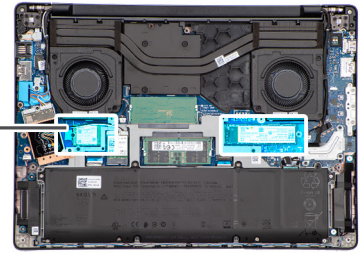

Figure 24. Installing the M.2 2230 solid state drive

Steps

1. Align and place the M.2230 SSD holder in its slot on the system board.

i **NOTE:** This step applies only if you are replacing a M.2 2280 solid state drive with a M.2 2230 solid state drive.

2. Align the notch on the M.2 2230 solid state drive to the tab on the M.2 card slot (SSD1 or SSD2, whichever is applicable) on the system board.
3. Slide the M.2 2230 solid state drive at an angle into the M.2 card slot on the system board.
4. Replace the screw (M2x4) to secure the M.2 2230 solid state drive to the palm-rest assembly.

Next steps

1. Install the [base cover](#).
2. Follow the procedure in [After working inside your computer](#).

Removing the M.2 2280 solid state drive

Prerequisites

1. Follow the procedure in [Before working inside your computer](#).
2. Remove the [base cover](#).

About this task

The following image indicates the location of the M.2 2280 solid state drive (SSD) and provides a visual representation of the removal procedure.

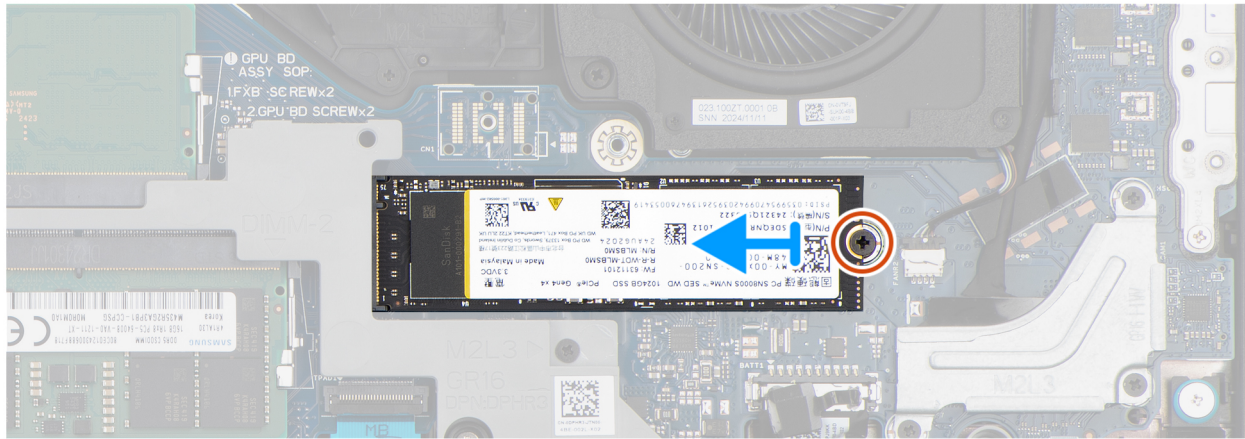
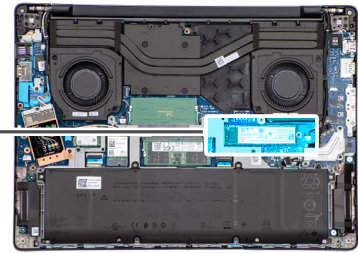



Figure 25. Removing the M.2 2280 solid state drive

Steps

1. Remove the screw (M2x4) that secures the M.2 2280 solid state drive to the system board.
2. Remove the M.2 2280 solid state drive from the M.2 card slot (SSD1 or SSD2, whichever is applicable) on the system board.

 **NOTE:** For computers shipped with a WWAN module installed, the M.2 2280 solid state drive can only be installed in SSD2 slot (primary slot).

Installing the M.2 2280 solid state drive

Prerequisites

If you are replacing a component, remove the existing component before performing the installation procedure.

About this task

The following image indicates the location of the M.2 2280 solid state drive (SSD) and provides a visual representation of the installation procedure.

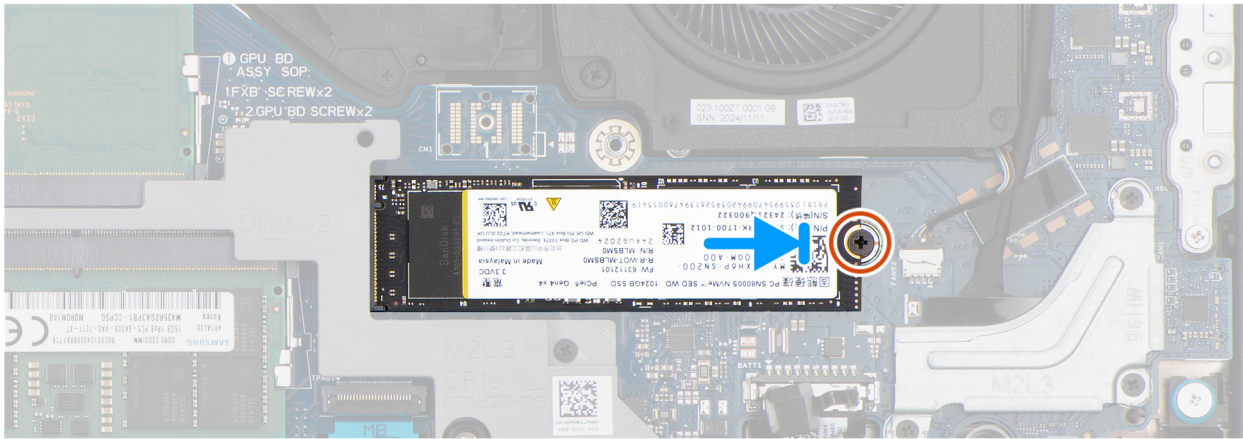
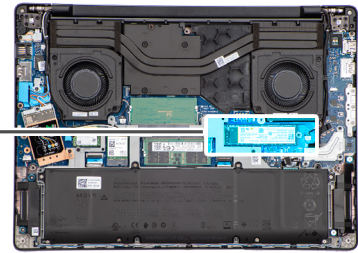

Figure 26. Installing the M.2 2280 solid state drive

Steps

1. Align the notch on the M.2 2280 solid state drive to the tab on the M.2 card slot (SSD1 or SSD2, whichever is applicable) on the system board.
 - i NOTE:** For computers shipped with a WWAN module installed, the M.2 2280 solid state drive can only be installed in SSD2 slot (primary slot).
2. Slide the M.2 2280 solid state drive at an angle into the M.2 card slot on the system board.
3. Replace the screw (M2x4) to secure the M.2 2280 solid state drive to the system board.

Next steps

1. Install the [base cover](#).
2. Follow the procedure in [After working inside your computer](#).

Wireless card

Removing the wireless card

Prerequisites

1. Follow the procedure in [Before working inside your computer](#).
2. Remove the [base cover](#).

About this task

The following images indicate the location of the wireless card and provide a visual representation of the removal procedure.



1x
M2x3

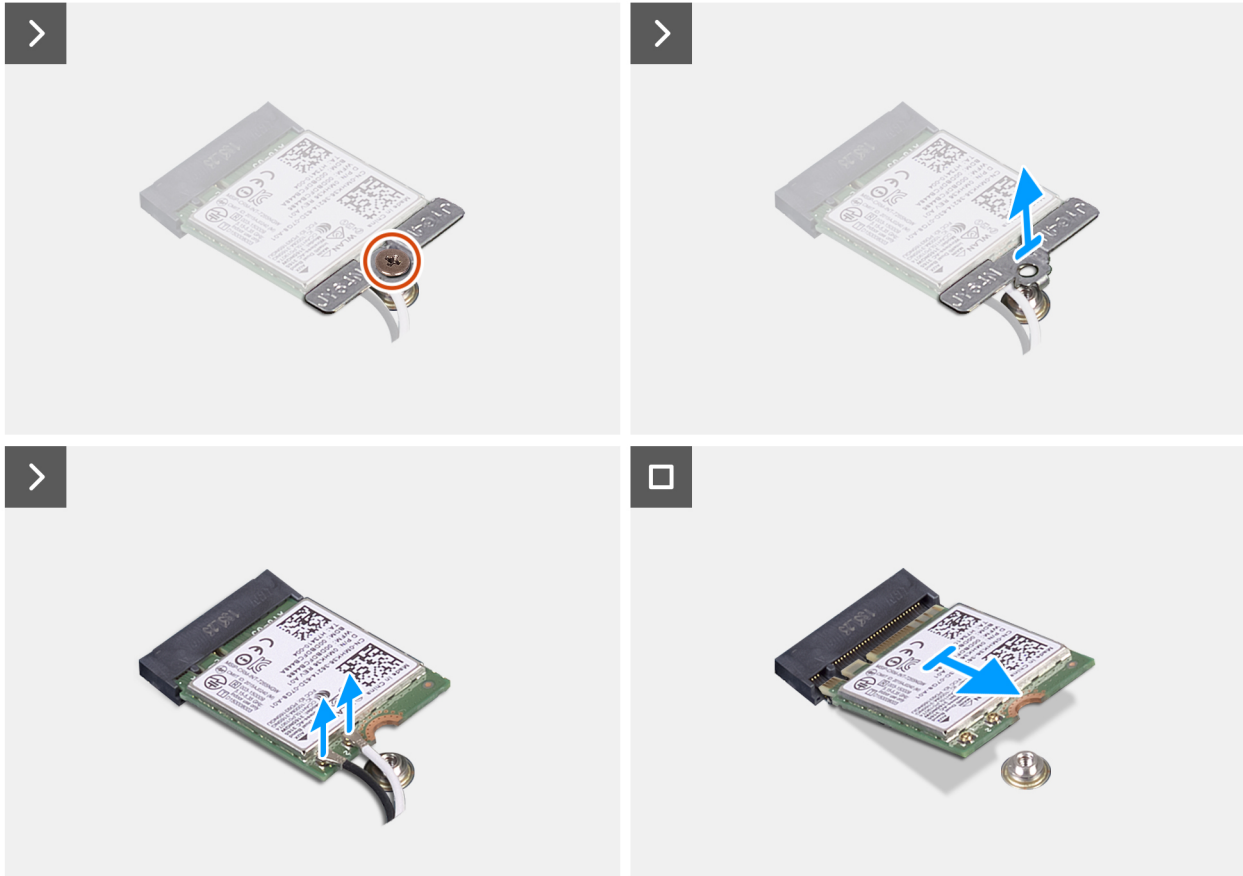
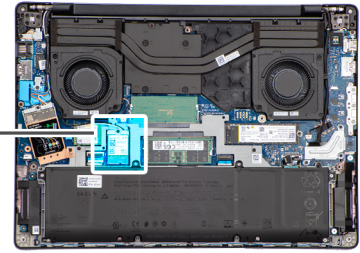

Figure 27. Removing the wireless card

Steps

1. Remove the screw (M2x3) that secures the wireless-card bracket to the system board.
2. Lift the wireless-card bracket off the wireless card.
3. Disconnect the wireless-antenna cables from the connectors on the wireless card.
4. Slide and remove the wireless card from the wireless-card slot (WLAN1) on the system board.

Installing the wireless card

Prerequisites

If you are replacing a component, remove the existing component before performing the installation procedure.

About this task

The following images indicate the location of the wireless card and provide a visual representation of the installation procedure.



1x
M2x3

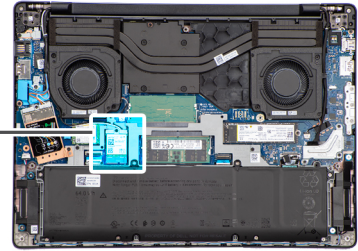

Figure 28. Installing the wireless card

Steps

1. Align the notch on the wireless card to the tab on the wireless-card slot (WLAN1) on the system board.
2. Slide the wireless card at an angle into the wireless-card slot on the system board.
3. Connect the wireless-antenna cables to the connectors on the wireless card.

The following table provides the antenna-cable color scheme for the wireless card supported by your computer.

Table 37. Antenna-cable color scheme

Connector on the wireless card	Antenna-cable color	Silkscreen marking	
Main	White	MAIN	△ (white triangle)
Auxiliary	Black	AUX	▲ (black triangle)

4. Place the wireless-card bracket on the wireless card.
5. Align the screw hole on the wireless-card bracket with the screw hole on the system board.
6. Replace the screw (M2x3) to secure the wireless-card bracket and the wireless card to the system board.

Next steps

1. Install the [base cover](#).
2. Follow the procedure in [After working inside your computer](#).

WWAN module

Removing the WWAN module

 **NOTE:** This procedure applies only to computers shipped with a WWAN module installed.

Prerequisites

1. Follow the procedure in [Before working inside your computer](#).
2. Remove the [base cover](#).

About this task

The following images indicate the location of the WWAN module and provide a visual representation of the removal procedure.

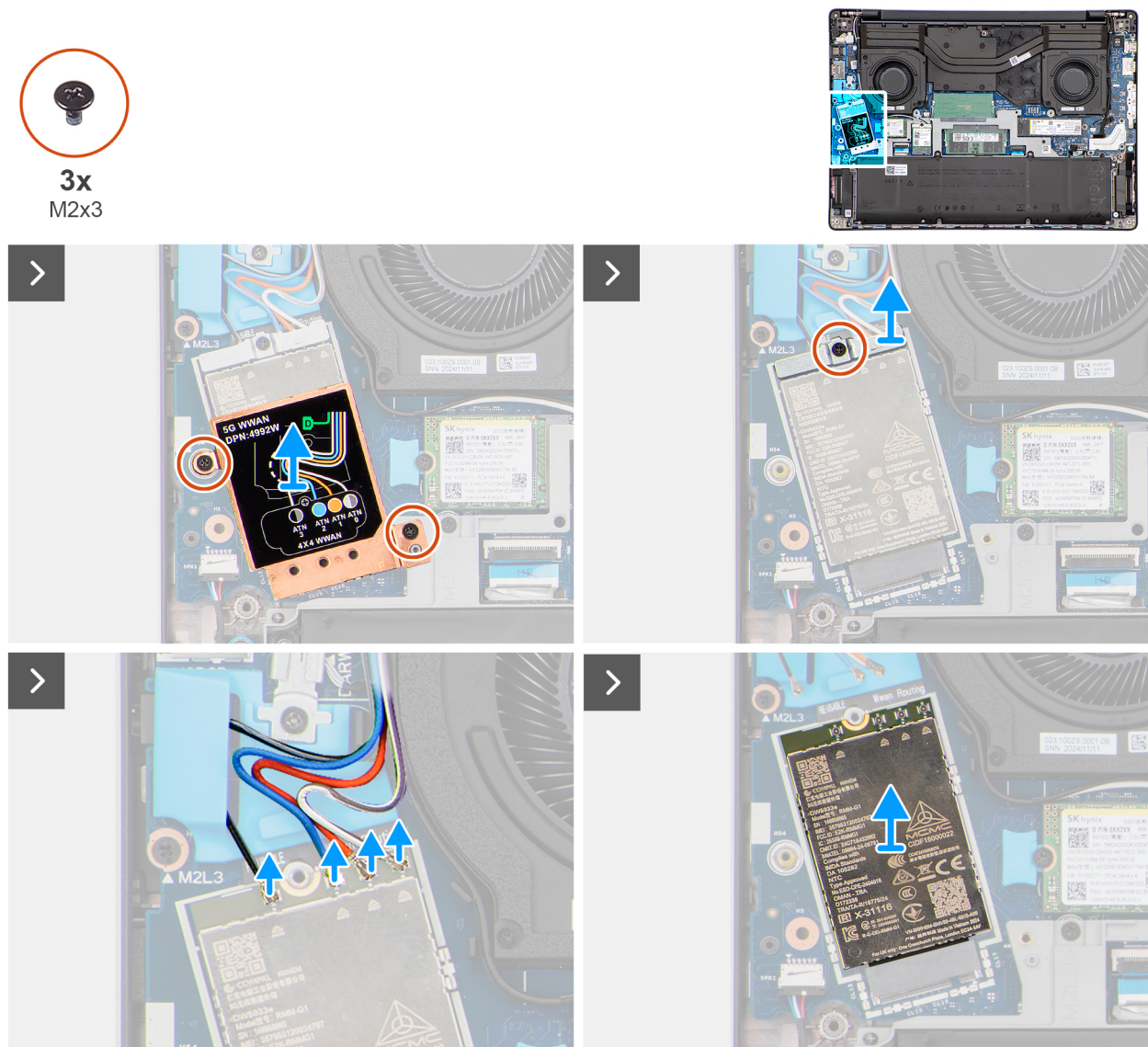

Figure 29. Removing the WWAN module

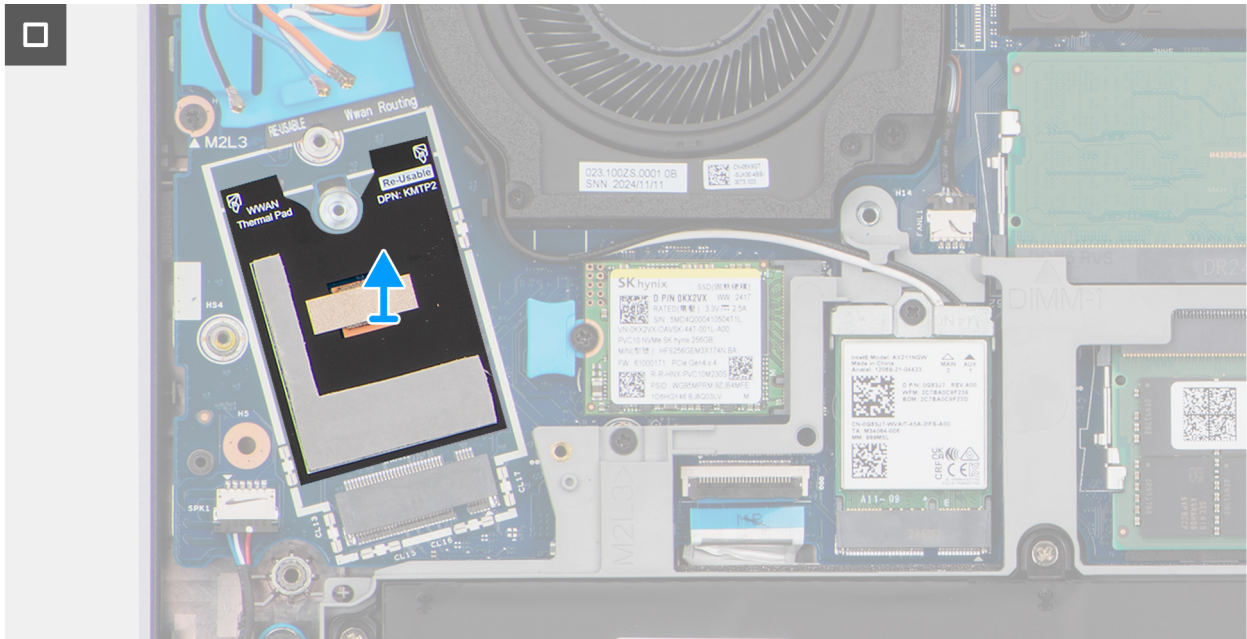

Figure 30. Removing the WWAN module

Steps

1. Remove the two screws (M2x3) that secure the WWAN-module shield to the system board.
2. Lift the WWAN-module shield off the WWAN module.
3. Remove the screw (M2x3) that secures the WWAN-module bracket to the system board.
4. Lift the WWAN-module bracket off the WWAN module.
5. Disconnect the WWAN-antenna cables from the connectors on the WWAN module.
6. Slide and remove the WWAN module from the WWAN-module slot (WWAN1) on the system board.

NOTE: There is a reusable Mylar sheet with thermal pads beneath the WWAN module. When replacing the system board, this Mylar sheet should be transferred to the new replacement system board.

Installing the WWAN module

NOTE: This procedure applies only to computers shipped with a WWAN module installed.

Prerequisites

If you are replacing a component, remove the existing component before performing the installation procedure.

About this task

The following images indicate the location of the WWAN module and provide a visual representation of the installation procedure.



3x
M2x3

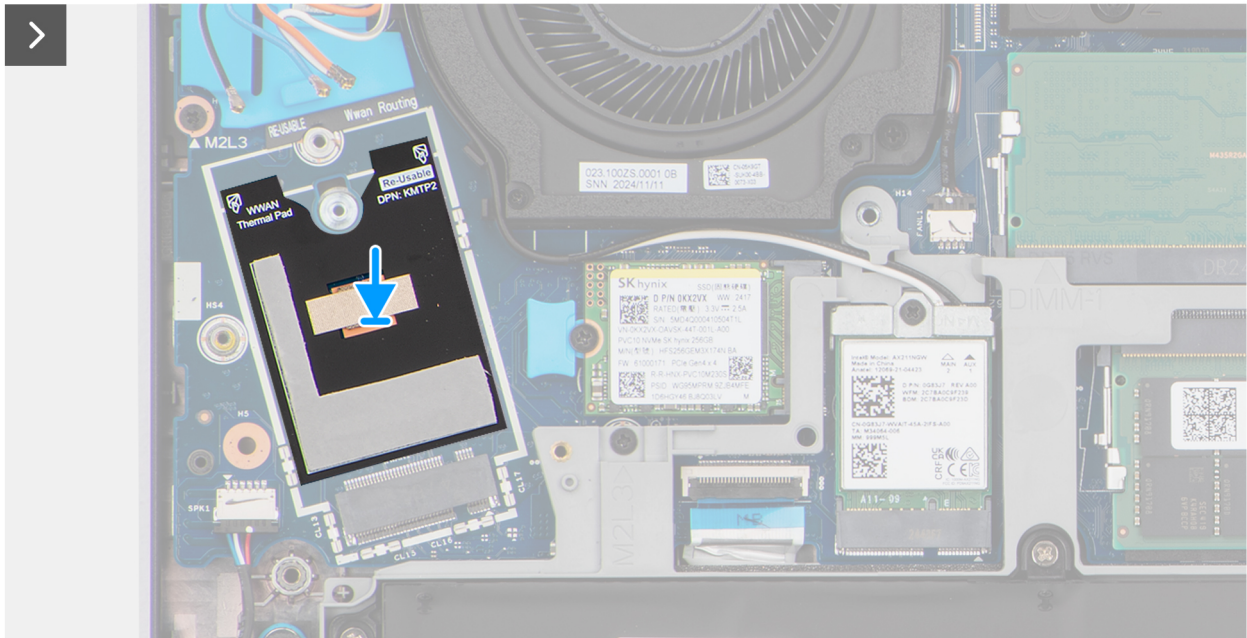
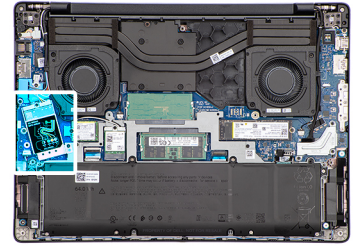

Figure 31. Installing the WWAN module



Figure 32. Installing the WWAN module

Steps

1. Ensure that the reusable Mylar sheet with thermal pads is placed beneath the WWAN module.
 - NOTE:** When replacing the system board, this Mylar sheet should be transferred to the new replacement system board.
2. Align the notch on the WWAN module to the tab on the WWAN-module slot (WWAN1) on the system board.
3. Slide the WWAN module at an angle into the WWAN-module slot on the system board.
4. Connect the WWAN-antenna cables to the connectors on the WWAN module. For information about the cable connection, see the information that is printed on the WWAN-module shield.
5. Place the WWAN-module bracket on the WWAN module.
6. Align the screw hole on the WWAN-module bracket with the screw hole on the system board.
7. Replace the screw (M2x3) to secure the WWAN-module bracket and the WWAN module to the system board.
8. Align and place the WWAN-module shield on the WWAN module.
9. Replace the two screws (M2x3) to secure the WWAN-module shield to the system board.

Next steps

1. Install the [base cover](#).
2. Follow the procedure in [After working inside your computer](#).

Speakers

Removing the speakers

Prerequisites

1. Follow the procedure in [Before working inside your computer](#).
2. Remove the [base cover](#).

About this task

The following images indicate the location of the speakers and provide a visual representation of the removal procedure.

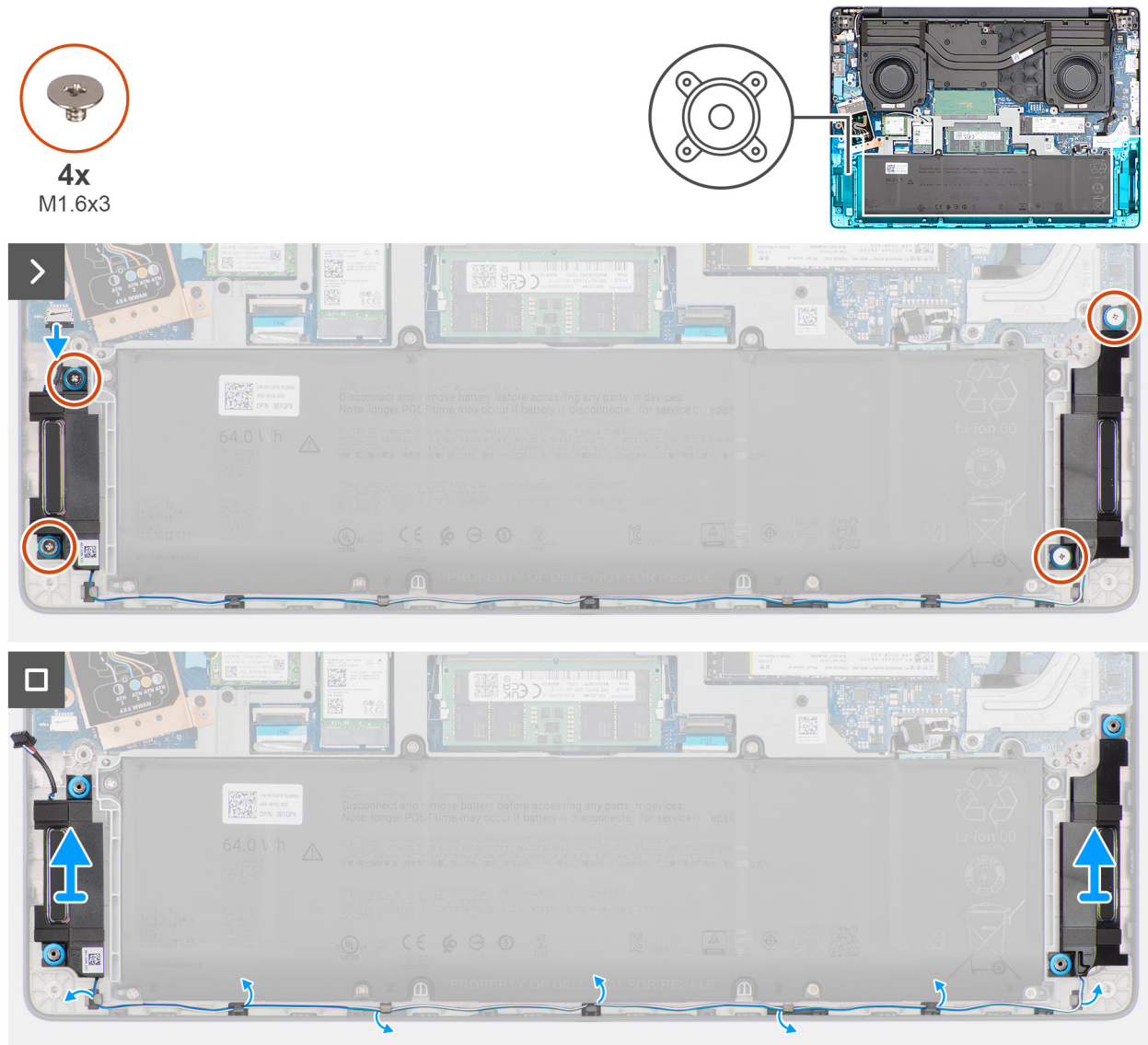

Figure 33. Removing the speakers

Steps

1. Disconnect the speaker cable from the connector (SPK1) on the system board.
2. Remove the four screws (M1.6x3) that secure the speakers to the palm-rest assembly.
3. Carefully remove the speaker cable from the routing guides on the palm-rest assembly.
4. Lift the speakers, along with the cable, off the palm-rest assembly.

Installing the speakers

Prerequisites

If you are replacing a component, remove the existing component before performing the installation procedure.

About this task

NOTE: If the rubber grommets are pushed out when removing the speakers, push them back in before replacing the speakers.

The following images indicate the location of the speakers and provide a visual representation of the installation procedure.

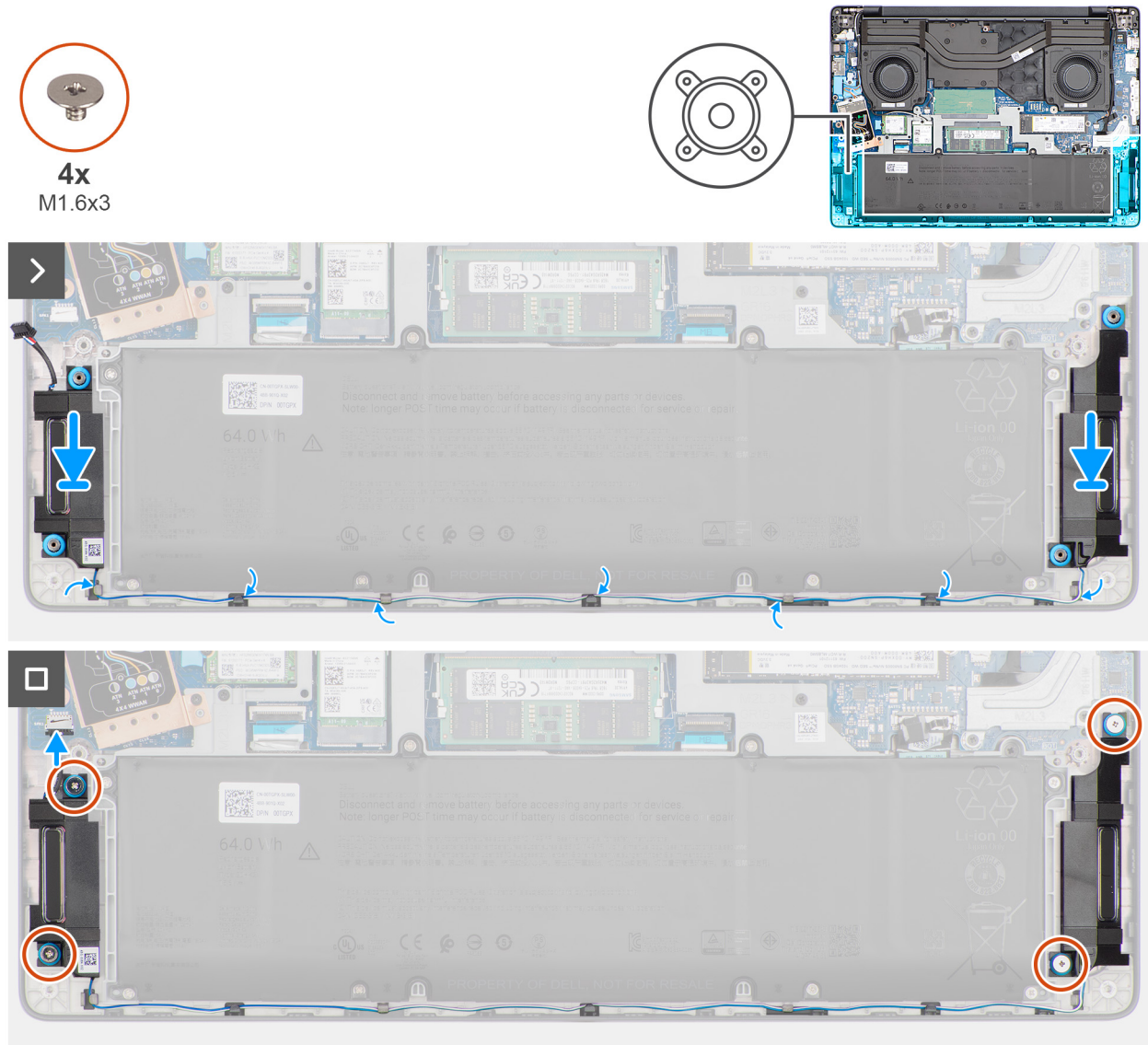

Figure 34. Installing the speakers

Steps

1. Using the alignment posts and rubber grommets, place the speakers in the slots on the palm-rest assembly.

NOTE: Ensure that the rubber grommets on the speakers are threaded through the alignment posts. Ensure that the four rubber grommets are seated into the slot and installed on the speakers properly.

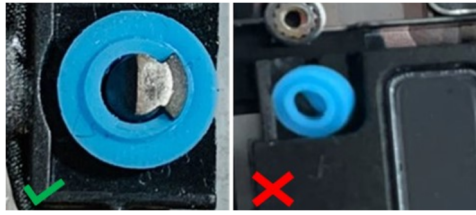

Figure 35. Installing the speakers

2. Route the speaker cable through the routing guides on the palm-rest assembly.
3. Replace the four screws (M1.6x3) to secure the speakers to the palm-rest assembly.
4. Connect the speaker cable to the connector (SPK1) on the system board.

Next steps

1. Install the [base cover](#).
2. Follow the procedure in [After working inside your computer](#).

Right/Processor fan

Removing the right/processor fan

Prerequisites

1. Follow the procedure in [Before working inside your computer](#).
2. Remove the [base cover](#).
3. Remove the [wireless card](#).
4. Remove the [WWAN module](#), if available.

About this task

The following images indicate the location of the right/processor fan and provide a visual representation of the removal procedure.

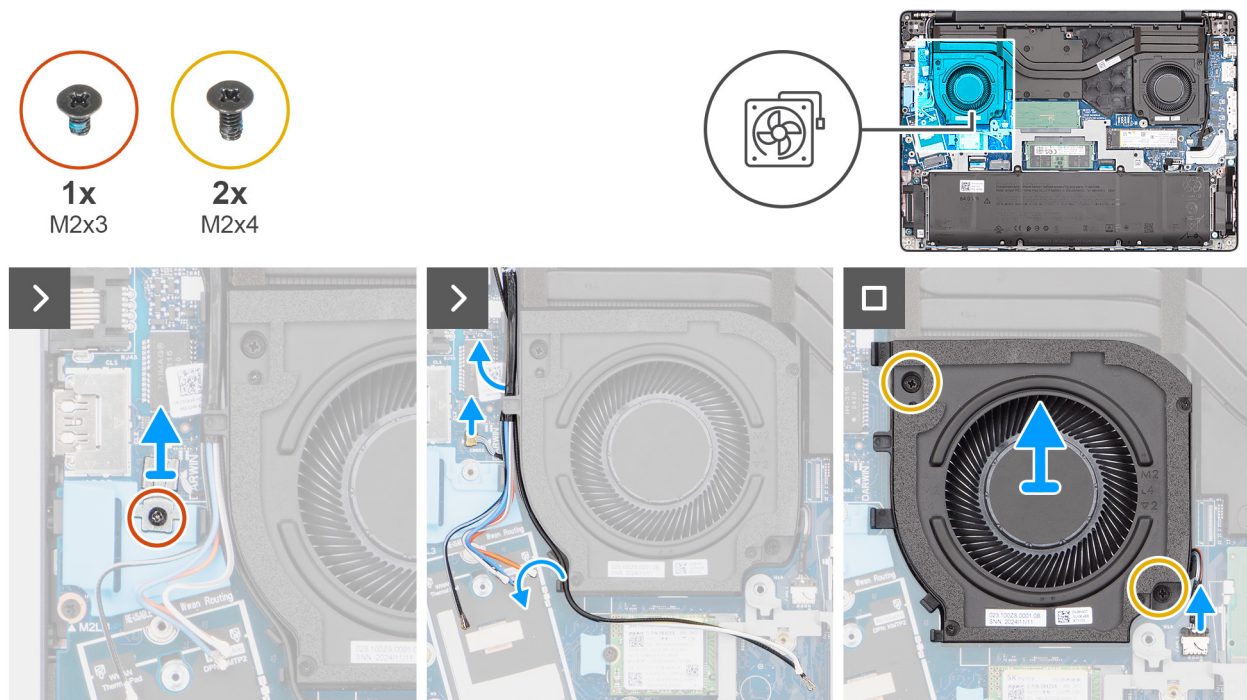

Figure 36. Removing the right/processor fan

Steps

1. **NOTE:** Steps 1 to 3 apply only to computers shipped with a WWAN module installed.

Remove the screw (M2x3) that secures the Darwin-cable bracket to the system board.

2. Lift the Darwin-cable bracket off the system board.
3. Disconnect the Darwin-antenna cable from the connector (DARWIN) on the system board.
4. Remove the wireless-antenna cables and WWAN-antenna cables, if available, from the routing guides on the fan.
5. Disconnect the fan cable from the connector (FANL1) on the system board.
6. Remove the two screws (M2x4) that secure the fan to the palm-rest assembly.
7. Lift the right/processor fan off the palm-rest assembly.

Installing the right/processor fan

Prerequisites

If you are replacing a component, remove the existing component before performing the installation procedure.

About this task

The following images indicate the location of the right/processor fan and provide a visual representation of the installation procedure.

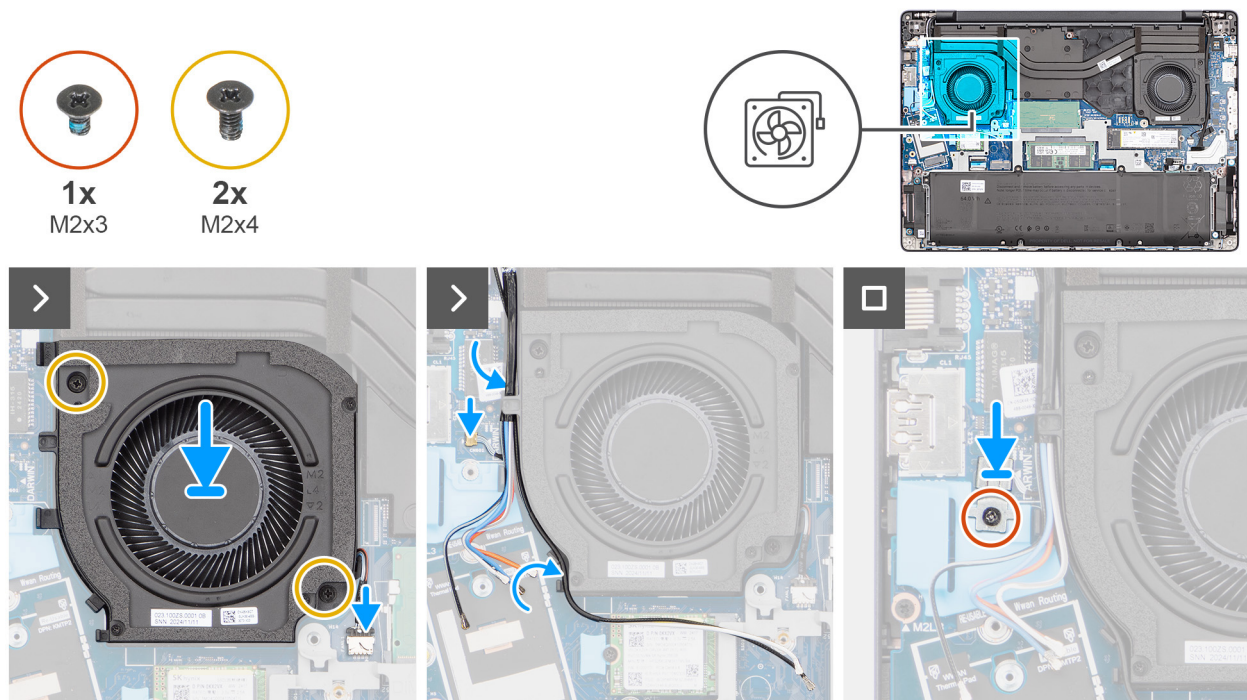

Figure 37. Installing the right/processor fan

Steps

1. Place the right/processor fan in the slot on the palm-rest assembly.
2. Align the screw holes on the fan with the screw holes on the palm-rest assembly.
3. Replace the two screws (M2x4) to secure the fan to the palm-rest assembly.
4. Connect the fan cable to the connector (FANL1) on the system board.
5. Route the wireless-antenna cables and WWAN-antenna cables, if available, through the routing guides on the fan.
6. **i** **NOTE:** Steps 6 to 8 apply only to computers shipped with a WWAN module installed.

Connect the Darwin-antenna cable to the connector (DARWIN) on the system board.

7. Align and place the Darwin-cable bracket over the Darwin-antenna cable on the system board.
8. Replace the screw (M2x3) to secure the Darwin-cable bracket to the system board.

Next steps

1. Install the [WWAN module](#), if available.
2. Install the [wireless card](#).
3. Install the [base cover](#).
4. Follow the procedure in [After working inside your computer](#).

Left/Video fan

Removing the left/video fan

Prerequisites

1. Follow the procedure in [Before working inside your computer](#).
2. Remove the [base cover](#).

About this task

The following images indicate the location of the left/video fan and provide a visual representation of the removal procedure.

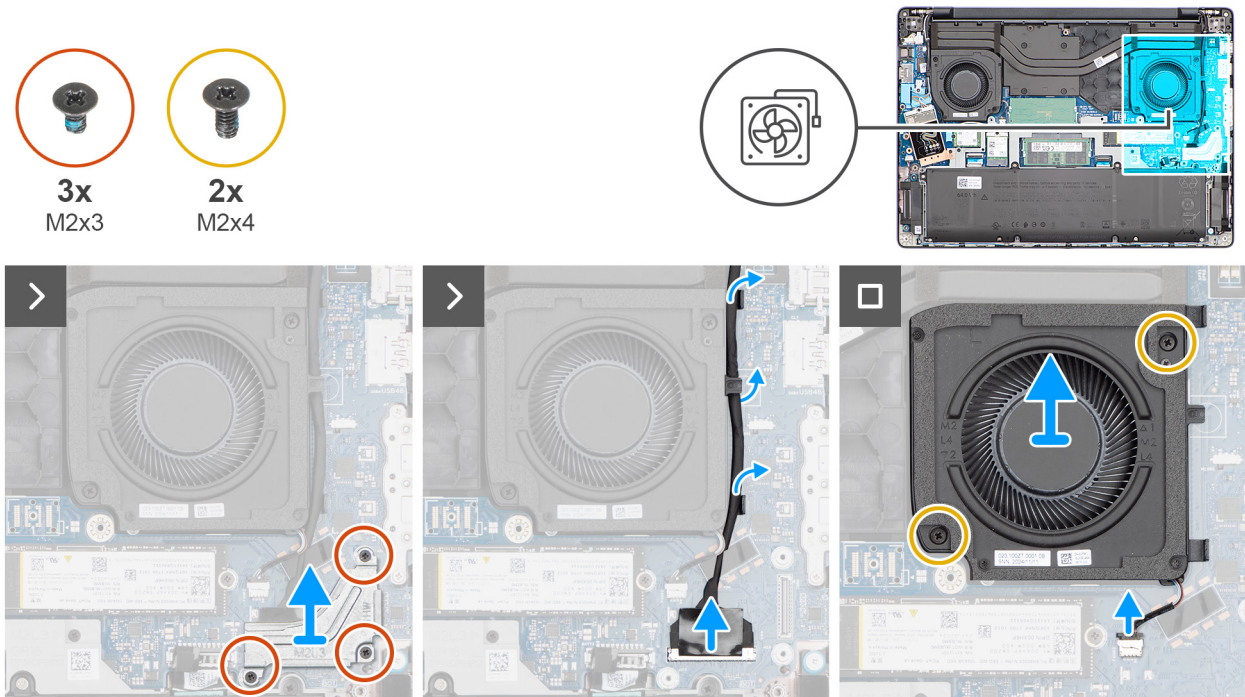

Figure 38. Removing the left/video fan

Steps

1. Remove the three screws (M2x3) that secure the display-cable bracket to the system board.
2. Lift the display-cable bracket off the system board.
3. Disconnect the display cable from the connector (LCD1) on the system board.
4. Disconnect the IR-camera cable from the connector (CAM1) on the system board.
i **NOTE:** This step applies only to computers shipped with an IR camera installed.
5. Remove the display cable and the IR-camera cable, if available, from the routing guides on the fan.
6. Disconnect the fan cable from the connector (FANR2) on the system board.
7. Remove the two screws (M2x4) that secure the fan to the palm-rest assembly.
8. Lift the left/video fan off the palm-rest assembly.

Installing the left/video fan

Prerequisites

If you are replacing a component, remove the existing component before performing the installation procedure.

About this task

The following images indicate the location of the left/video fan and provide a visual representation of the installation procedure.

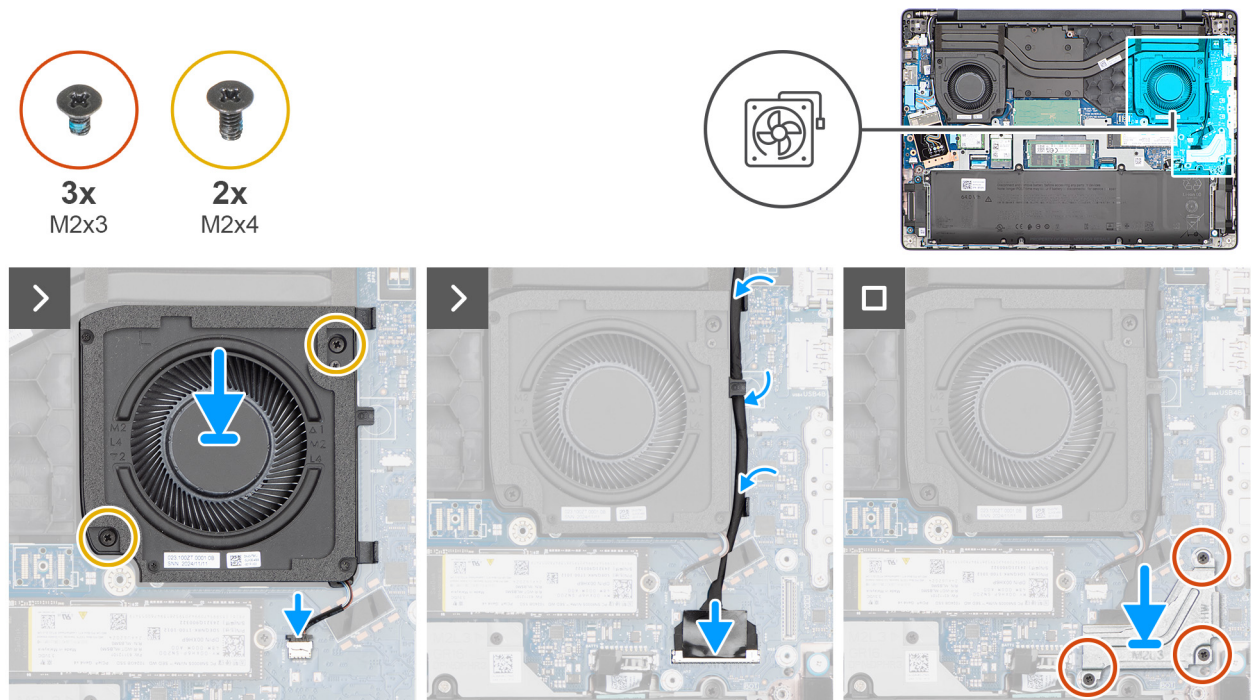

Figure 39. Installing the left/video fan

Steps

1. Place the left/video fan in the slot on the palm-rest assembly.
2. Align the screw holes on the fan with the screw holes on the palm-rest assembly.
3. Replace the two screws (M2x4) to secure the fan to the palm-rest assembly.
4. Connect the fan cable to the connector (FANR2) on the system board.
5. Route the display cable and the IR-camera cable, if available, through the routing guides on the fan.
6. Connect the display cable to the connector (LCD1) on the system board.
7. Connect the IR-camera cable to the connector (CAM1) on the system board.

NOTE: This step applies only to computers shipped with an IR camera installed.

8. Align and place the display-cable bracket over the display cable and the IR-camera cable, if available, on the system board.
9. Replace the three screws (M2x3) to secure the display-cable bracket to the system board.

Next steps

1. Install the [base cover](#).
2. Follow the procedure in [After working inside your computer](#).

Removing and installing Field Replaceable Units (FRUs)

The replaceable components in this chapter are Field Replaceable Units (FRUs).

CAUTION: The information in this section is intended for authorized service technicians only.

CAUTION: To avoid any potential damage to the component or loss of data, ensure that an authorized service technician replaces the Field Replaceable Units (FRUs).

CAUTION: Dell Technologies recommends that these procedures be performed by trained technical repair specialists.

CAUTION: Your warranty does not cover damages that may occur during FRU repairs that are not authorized by Dell Technologies.

NOTE: The images in this document may differ from your computer depending on the configuration you ordered.

Heat sink

Removing the heat sink - for computers shipped with integrated graphics card

CAUTION: The information in this removal section is intended for authorized service technicians only.

Prerequisites

1. Follow the procedure in [Before working inside your computer](#).
2. Remove the [base cover](#).

About this task

NOTE: The heat sink may become hot during normal operation. Allow sufficient time for the heat sink to cool before you touch it.

NOTE: For optimal cooling of the processor, do not touch the heat-transfer areas on the heat sink. The oils in your skin can reduce the heat-transfer capability of the thermal grease.

The following image indicates the location of the heat sink and provides a visual representation of the removal procedure.

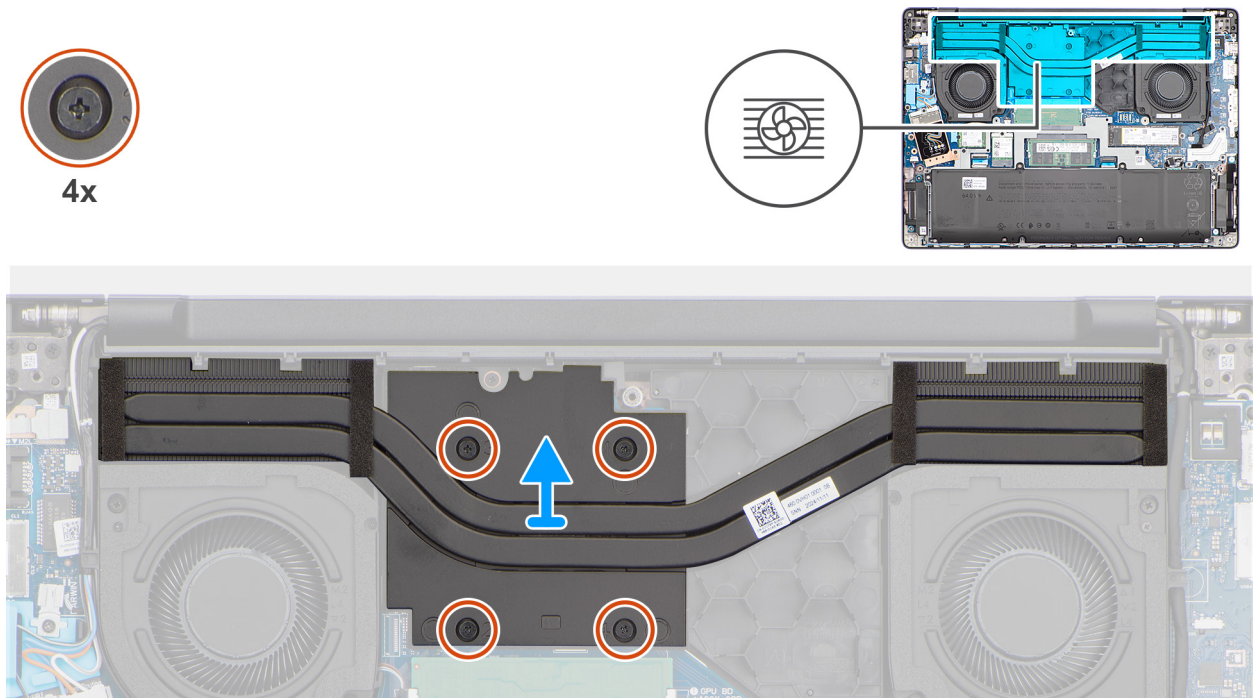

Figure 40. Removing the heat sink

Steps

1. In reverse sequential order (4 > 3 > 2 > 1), loosen the four captive screws that secure the heat sink to the system board. The screw numbers are etched on the heat sink.
2. Lift the heat sink off the system board.

Installing the heat sink - for computers shipped with integrated graphics card

CAUTION: The information in this installation section is intended for authorized service technicians only.

Prerequisites

If you are replacing a component, remove the existing component before performing the installation procedure.

About this task

NOTE: If either the system board or the heat sink is replaced, use the thermal grease that is provided in the kit to ensure that thermal conductivity is achieved.

The following image indicates the location of the heat sink and provides a visual representation of the installation procedure.

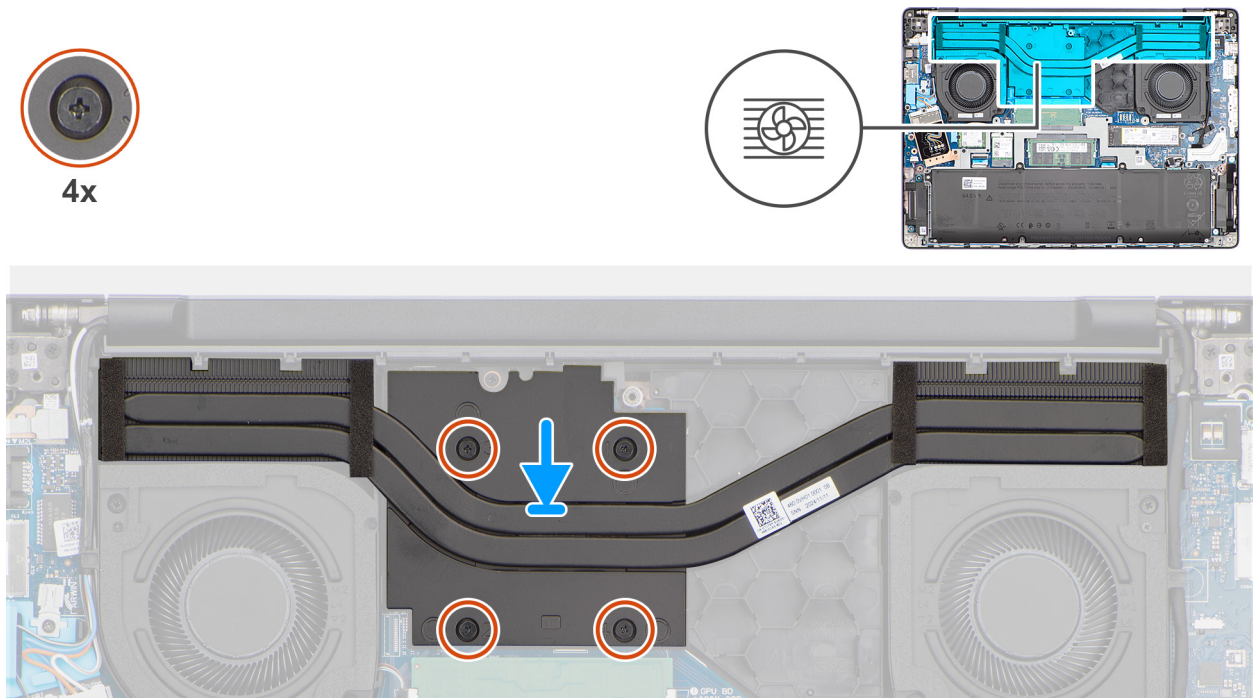

Figure 41. Installing the heat sink

Steps

1. Place the heat sink in the slot on the system board.
2. Align the screw holes on the heat sink with the screw holes on the system board.
3. In sequential order (1 > 2 > 3 > 4), tighten the four captive screws to secure the heat sink to the system board. The screw numbers are etched on the heat sink.

Next steps

1. Install the [base cover](#).
2. Follow the procedure in [After working inside your computer](#).

Removing the heat sink - for computers shipped with discrete graphics card

CAUTION: The information in this removal section is intended for authorized service technicians only.

Prerequisites

1. Follow the procedure in [Before working inside your computer](#).
2. Remove the [base cover](#).

About this task

NOTE: The heat sink may become hot during normal operation. Allow sufficient time for the heat sink to cool before you touch it.

NOTE: For optimal cooling of the processor, do not touch the heat-transfer areas on the heat sink. The oils in your skin can reduce the heat-transfer capability of the thermal grease.

The following image indicates the location of the heat sink and provides a visual representation of the removal procedure.

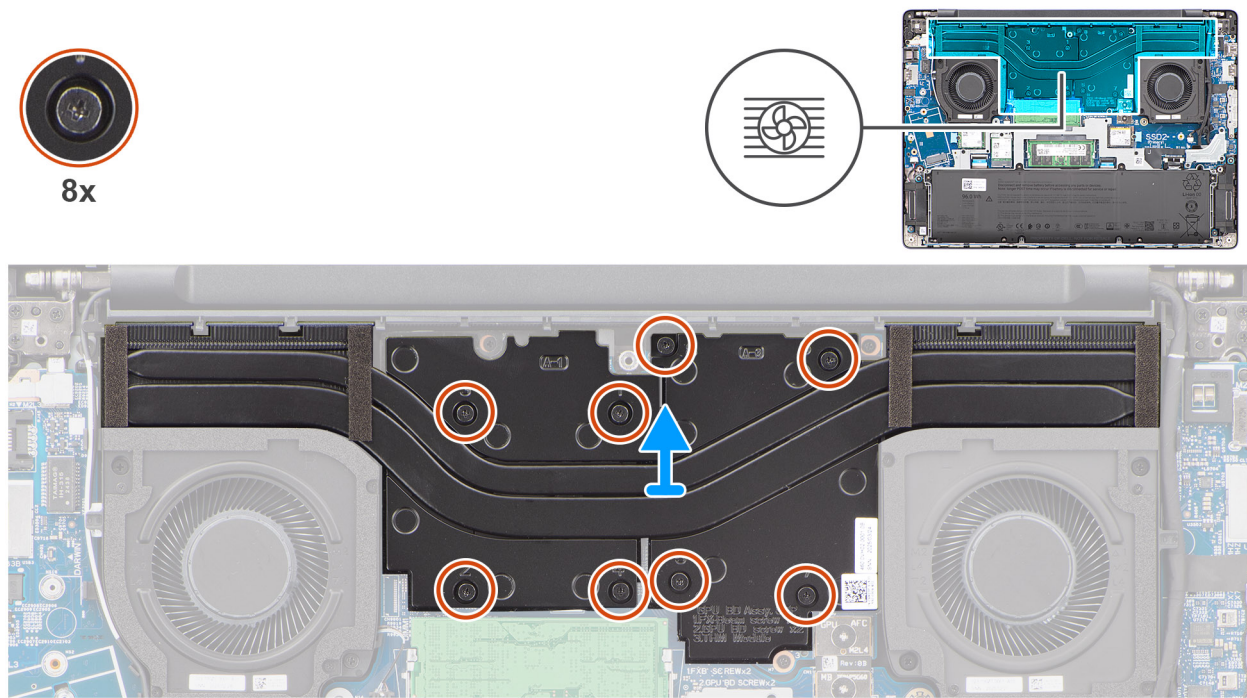

Figure 42. Removing the heat sink

Steps

1. In reverse sequential order (8 > 7 > 6 > 5 > 4 > 3 > 2 > 1) , loosen the eight captive screws that secure the heat sink to the system board. The screw numbers are etched on the heat sink.
2. Lift the heat sink off the system board.

Installing the heat sink - for computers shipped with discrete graphics card

CAUTION: The information in this installation section is intended for authorized service technicians only.

Prerequisites

If you are replacing a component, remove the existing component before performing the installation procedure.

About this task

NOTE: If either the system board or the heat sink is replaced, use the thermal grease that is provided in the kit to ensure that thermal conductivity is achieved.

The following image indicates the location of the heat sink and provides a visual representation of the installation procedure.

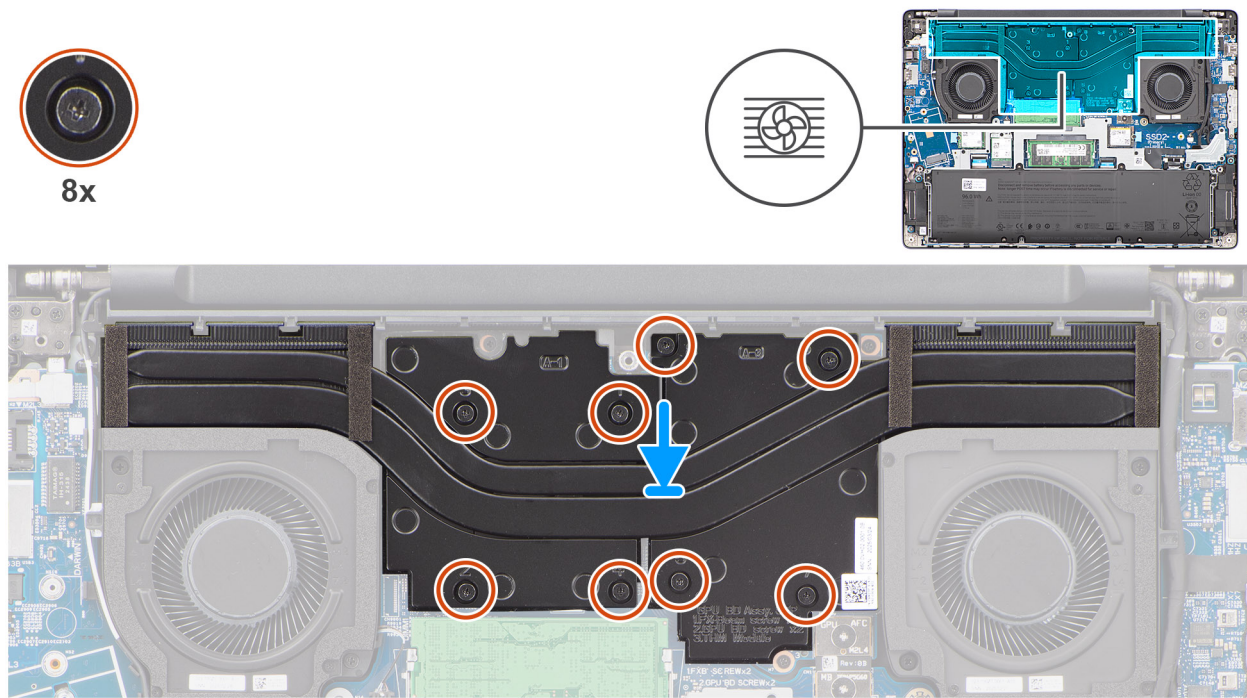

Figure 43. Installing the heat sink

Steps

1. Place the heat sink in the slot on the system board.
2. Align the screw holes on the heat sink with the screw holes on the system board.
3. In sequential order (1 > 2 > 3 > 4 > 5 > 6 > 7 > 8), tighten the eight captive screws to secure the heat sink to the system board. The screw numbers are etched on the heat sink.

Next steps

1. Install the [base cover](#).
2. Follow the procedure in [After working inside your computer](#).

GPU filler

Removing the GPU filler

CAUTION: The information in this removal section is intended for authorized service technicians only.

Prerequisites

1. Follow the procedure in [Before working inside your computer](#).
2. Remove the [base cover](#).
3. Remove the [heat sink](#).

About this task

The following images indicate the location of the GPU filler board and provide a visual representation of the removal procedure.



2x
M2x3

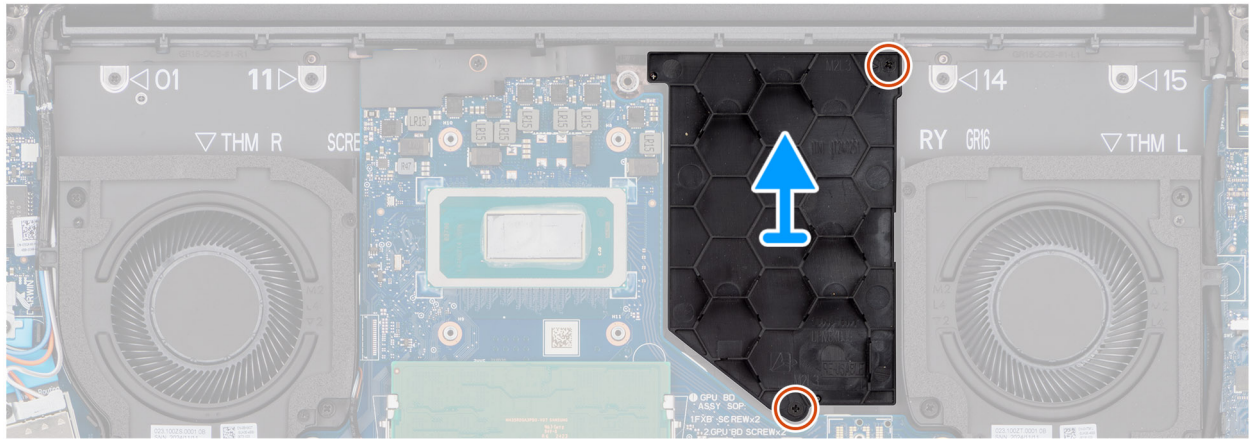

Figure 44. Removing the GPU filler

Steps

1. Remove the two screws (M2x3) that secure the GPU filler to the palm-rest assembly.
2. Lift the GPU filler off the palm-rest assembly.

Installing the GPU filler

CAUTION: The information in this installation section is intended for authorized service technicians only.

Prerequisites

If you are replacing a component, remove the existing component before performing the installation procedure.

About this task

The following images indicate the location of the GPU filler and provide a visual representation of the installation procedure.



2x
M2x3

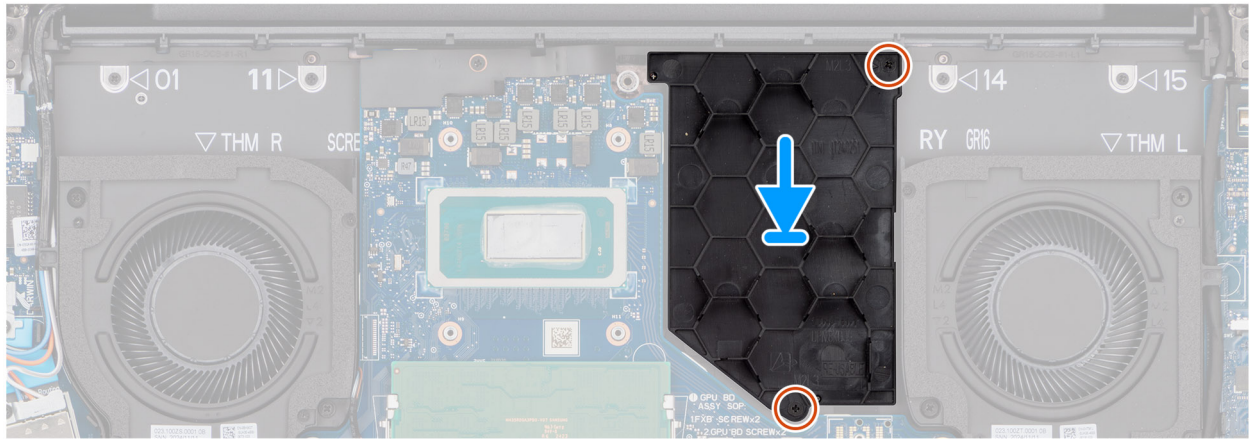

Figure 45. Installing the GPU filler

Steps

1. Align and place the GPU filler in the slot on the palm-rest assembly.
2. Replace the two screws (M2x3) to secure the GPU filler to the palm-rest assembly.

Next steps

1. Install the [heat sink](#).
2. Install the [base cover](#).
3. Follow the procedure in [After working inside your computer](#).

Graphics card

Removing the GPU

CAUTION: The information in this removal section is intended for authorized service technicians only.

Prerequisites

1. Follow the procedure in [Before working inside your computer](#).
2. Remove the [base cover](#).
3. Remove the [heat sink](#).

About this task

The following images indicate the location of the GPU and provide a visual representation of the removal procedure.

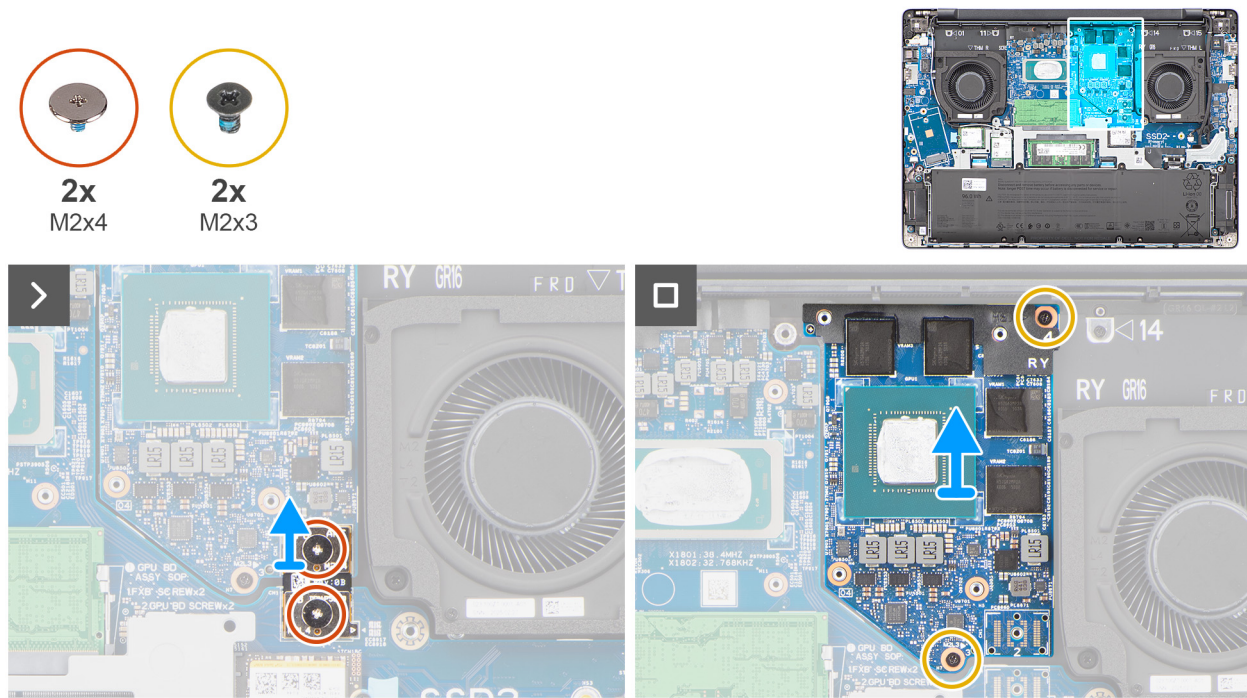

Figure 46. Removing the GPU

Steps

1. Remove the two screws (M2x4) and two screws (M2x3) that secure the GPU to the palm-rest assembly.
2. Disconnect and remove the F-beam connector.
3. Lift the GPU off the palm-rest assembly.

Installing the GPU

CAUTION: The information in this installation section is intended for authorized service technicians only.

Prerequisites

If you are replacing a component, remove the existing component before performing the installation procedure.

About this task

The following images indicate the location of the GPU and provide a visual representation of the installation procedure.

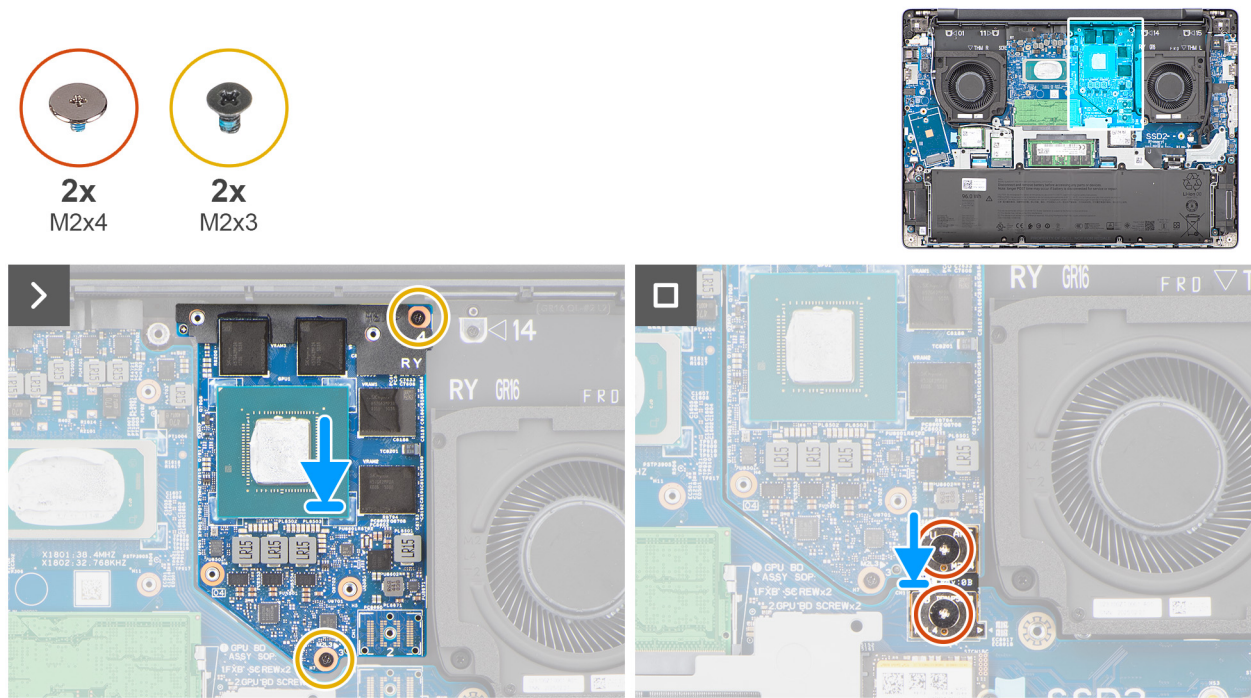

Figure 47. Installing the GPU

Steps

1. Align and place the GPU in the slot on the palm-rest assembly.
2. Replace the F-beam connector.
3. Replace the two screws (M2x4) and two screws (M2x3) to secure the GPU to the palm-rest assembly.

Next steps

1. Install the [heat sink](#).
2. Install the [base cover](#).
3. Follow the procedure in [After working inside your computer](#).

Battery frame

Removing the battery frame

⚠ CAUTION: The information in this removal section is intended for authorized service technicians only.

Prerequisites

1. Follow the procedure in [Before working inside your computer](#).
2. Remove the [base cover](#).
3. Remove the [battery](#).
4. Remove the [wireless card](#).

About this task

The following images indicate the location of the battery frame and provide a visual representation of the removal procedure.



12x
M2x3

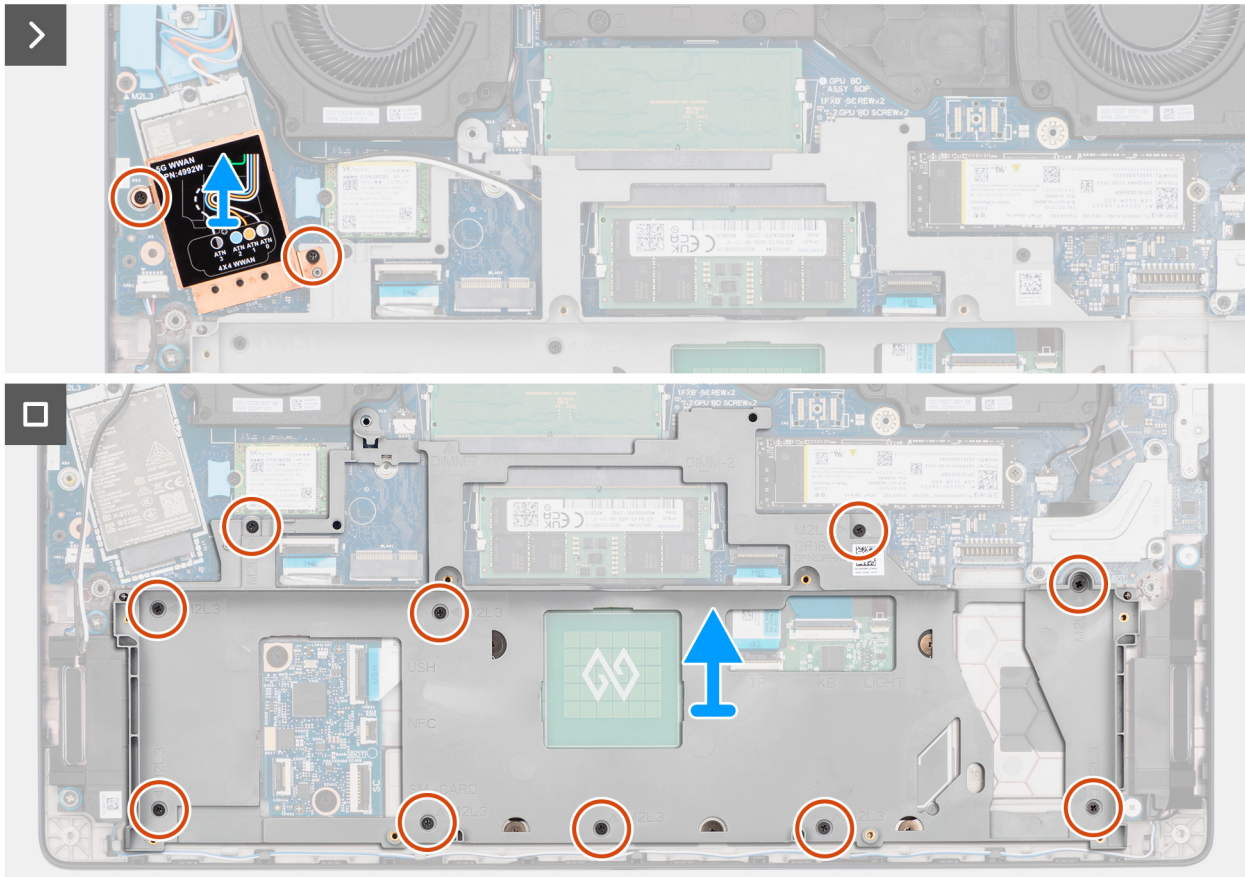
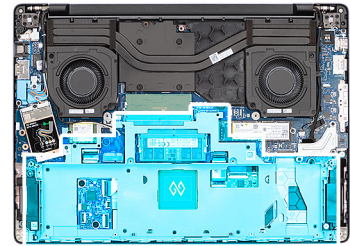



Figure 48. Removing the battery frame

Steps

1.  **NOTE:** Steps 1 and 2 apply only to computers shipped with a WWAN module installed.

Remove the two screws (M2x3) that secure the WWAN-module shield to the system board.

2. Lift the WWAN-module shield off the system board.

 **NOTE:** Only the WWAN-module shield is to be removed. The WWAN module is not required to be removed for the removal of the battery frame.

3. Remove the ten screws (M2x3) that secure the battery frame to the palm-rest assembly.
4. Lift the battery frame off the palm-rest assembly.

Installing the battery frame

 **CAUTION:** The information in this installation section is intended for authorized service technicians only.

Prerequisites

If you are replacing a component, remove the existing component before performing the installation procedure.

About this task

The following images indicate the location of the battery frame and provide a visual representation of the installation procedure.

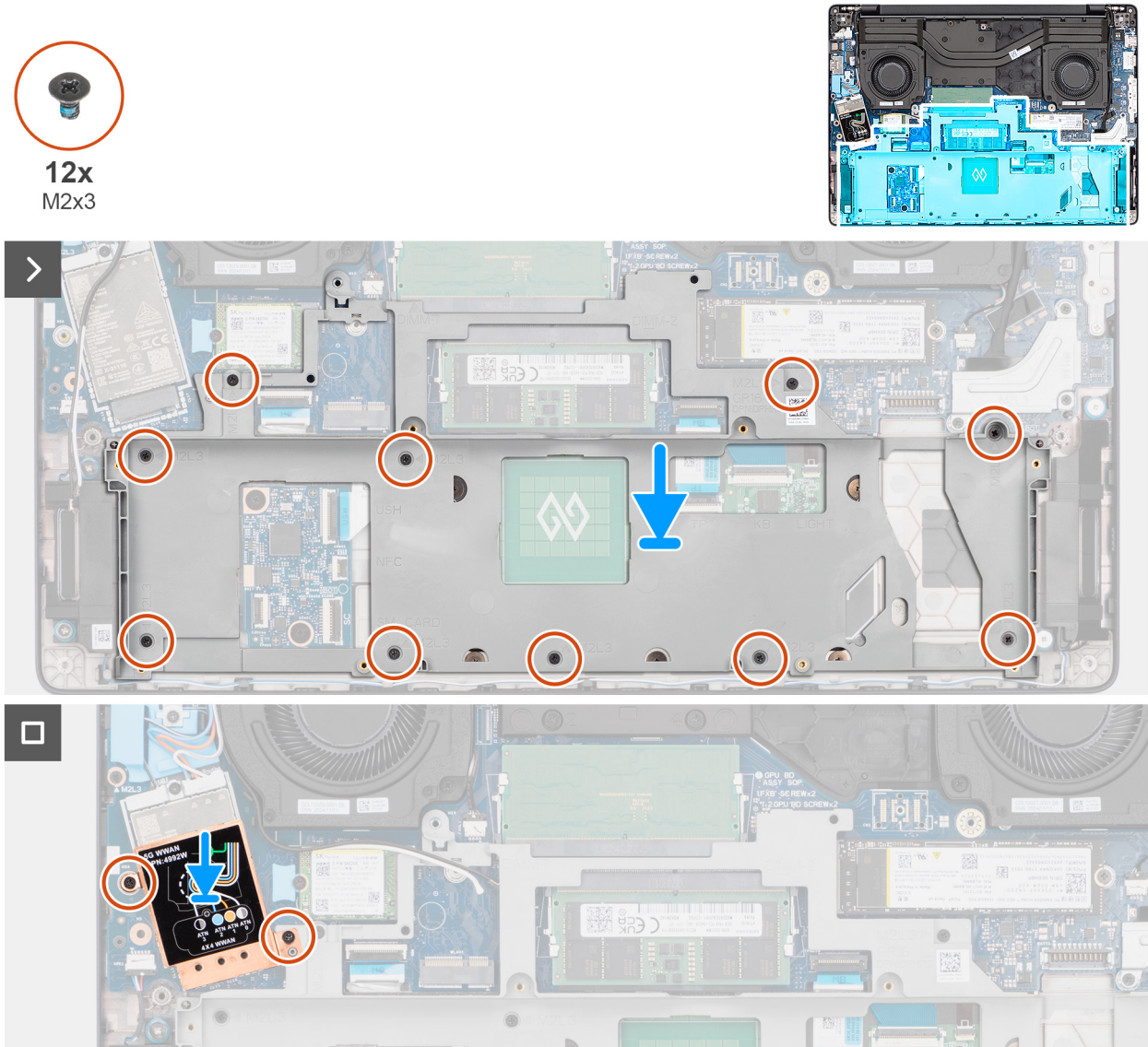



Figure 49. Installing the battery frame

Steps

1. Align and place the battery frame in the slot on the palm-rest assembly.
2. Replace the ten screws (M2x3) to secure the battery frame to the palm-rest assembly.
3.  **NOTE:** Steps 3 and 4 apply only to computers shipped with a WWAN module installed.

Align and place the WWAN-module shield on the solid state drive.

4. Replace the two screws (M2x3) to secure the WWAN-module shield to the system board.

Next steps

1. Install the [wireless card](#).
2. Install the [battery](#).

3. Install the [base cover](#).
4. Follow the procedure in [After working inside your computer](#).

USH board

Removing the USH board

CAUTION: The information in this removal section is intended for authorized service technicians only.

Prerequisites

1. Follow the procedure in [Before working inside your computer](#).
2. Remove the [base cover](#).
3. Remove the [battery](#).
4. Remove the [wireless card](#).
5. Remove the [battery frame](#).

About this task

The following images indicate the location of the USH board and provide a visual representation of the removal procedure.

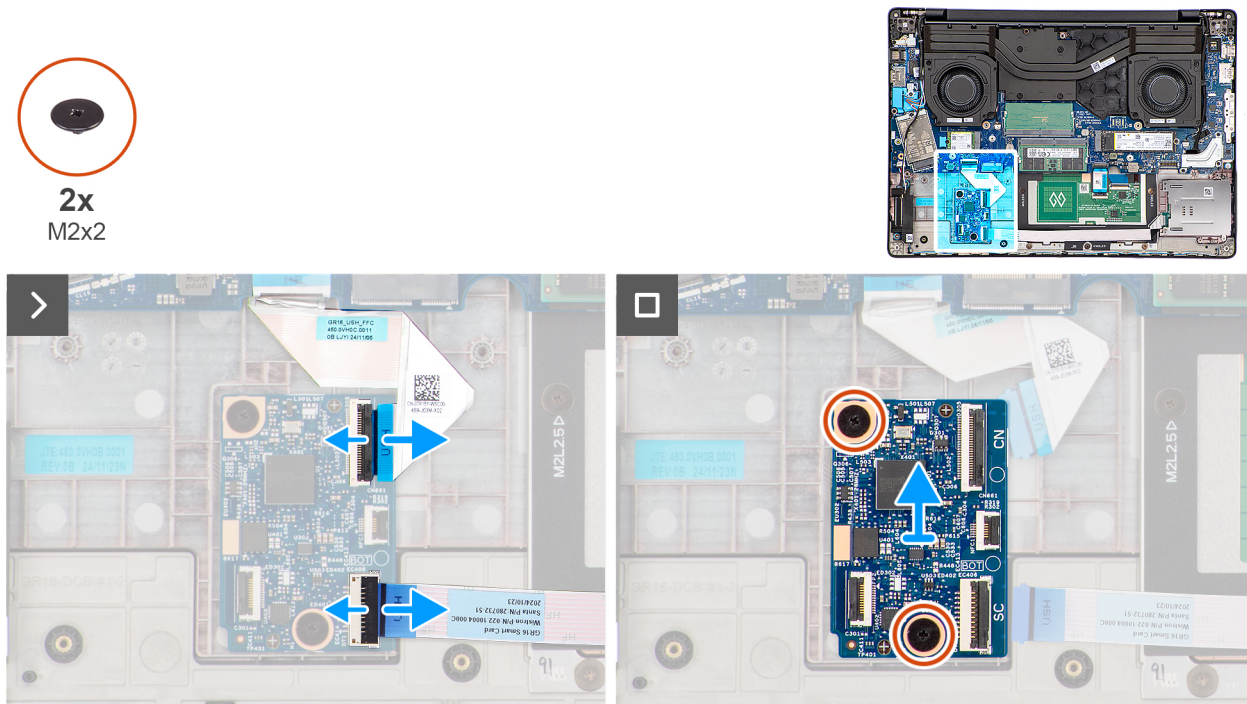

Figure 50. Removing the USH board

Steps

1. Disconnect the USH-board cable from the connector (CN) on the USH board.
2. Disconnect the smart-card reader cable from the connector (SC) on the USH board.
 - NOTE:** This step applies only to computers shipped with a smart-card reader installed.
3. Disconnect the NFC-sensor cable from the connector (NFC1) on the USH board.
 - NOTE:** This step applies only to computers shipped with an NFC sensor installed.
4. Remove the two screws (M2x2) that secure the USH board to the palm-rest assembly.

5. Lift the USH board off the palm-rest assembly.

Installing the USH board

CAUTION: The information in this installation section is intended for authorized service technicians only.

Prerequisites

If you are replacing a component, remove the existing component before performing the installation procedure.

About this task

The following images indicate the location of the USH board and provide a visual representation of the installation procedure.

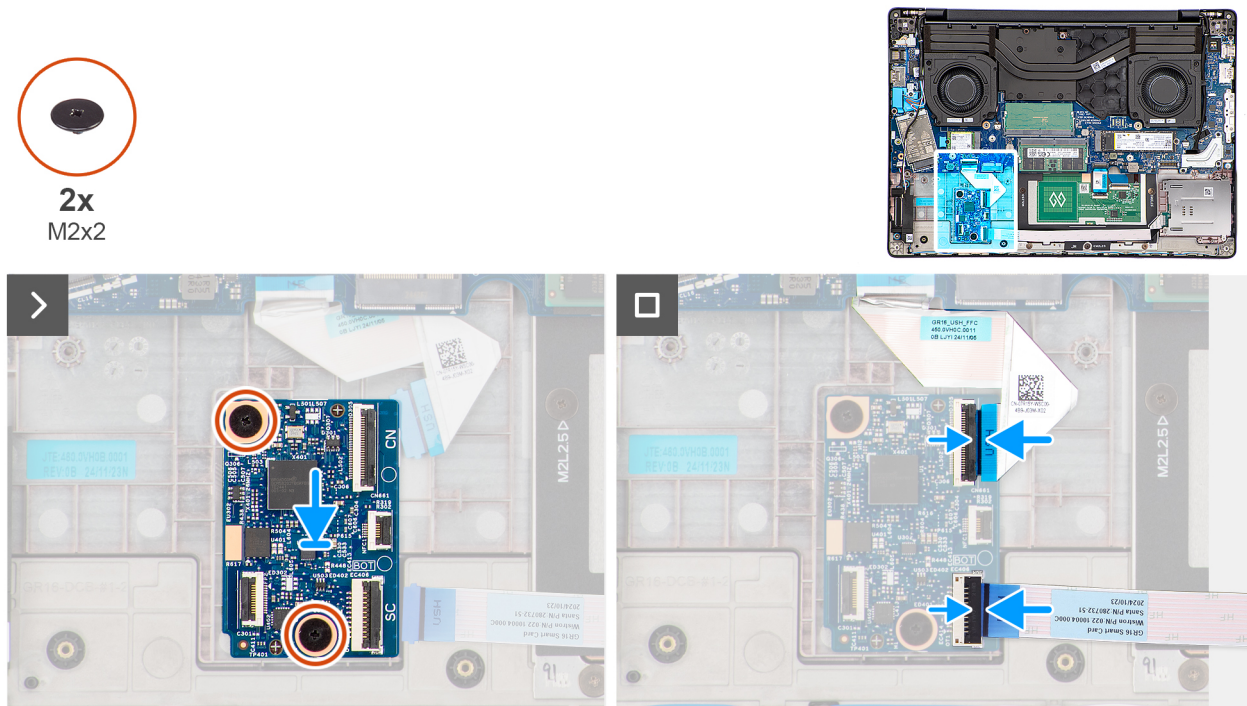

Figure 51. Installing the USH board

Steps

1. Align and place the USH board in the slot on the palm-rest assembly.
2. Replace the two screws (M2x2) to secure the USH board to the palm-rest assembly.
3. Connect the USH-board cable to the connector (CN) on the USH board.
4. Connect the smart-card reader cable to the connector (SC) on the USH board.

NOTE: This step applies only to computers shipped with a smart-card reader installed.

5. Connect the NFC-sensor cable to the connector (NFC1) on the USH board.

NOTE: This step applies only to computers shipped with an NFC sensor installed.

Next steps

1. Install the [battery frame](#).
2. Install the [wireless card](#).
3. Install the [battery](#).
4. Install the [base cover](#).
5. Follow the procedure in [After working inside your computer](#).

Smart-card reader

Removing the smart-card reader

CAUTION: The information in this removal section is intended for authorized service technicians only.

NOTE: This procedure applies only to computers shipped with an NFC sensor or smart-card reader installed.

Prerequisites

1. Follow the procedure in [Before working inside your computer](#).
2. Remove the [base cover](#).
3. Remove the [battery](#).
4. Remove the [wireless card](#).
5. Remove the [speakers](#).
6. Remove the [battery frame](#).

About this task

The following images indicate the location of the smart-card reader and provide a visual representation of the removal procedure.

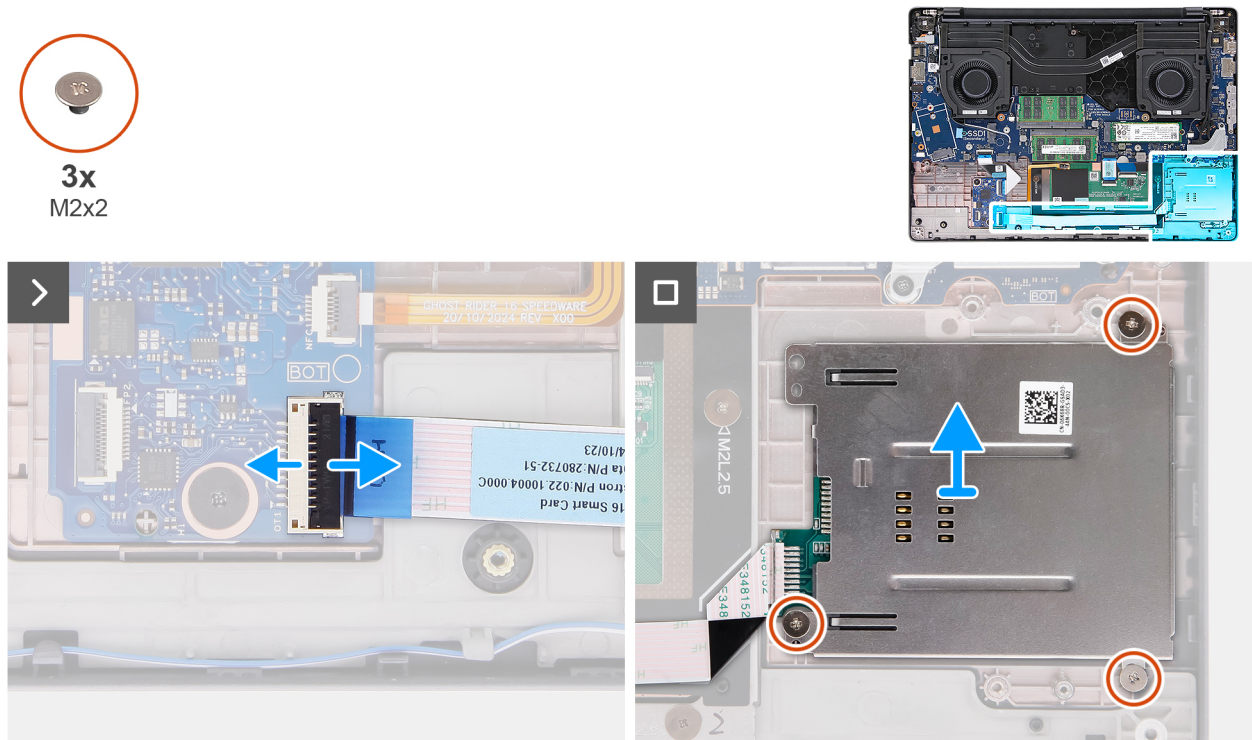

Figure 52. Removing the smart-card reader

Steps

1. Disconnect the NFC sensor or smart-card reader cable, whichever is applicable, from the connector (SC) on the USH board.
2. Remove the three screws (M2x2) that secure the smart-card reader to the palm-rest assembly.
3. Lift the smart-card reader off the palm-rest assembly.

Installing the smart-card reader

CAUTION: The information in this installation section is intended for authorized service technicians only.

NOTE: This procedure applies only to computers shipped with an NFC sensor or smart-card reader installed.

Prerequisites

If you are replacing a component, remove the existing component before performing the installation procedure.

About this task

The following images indicate the location of the smart-card reader and provide a visual representation of the installation procedure.

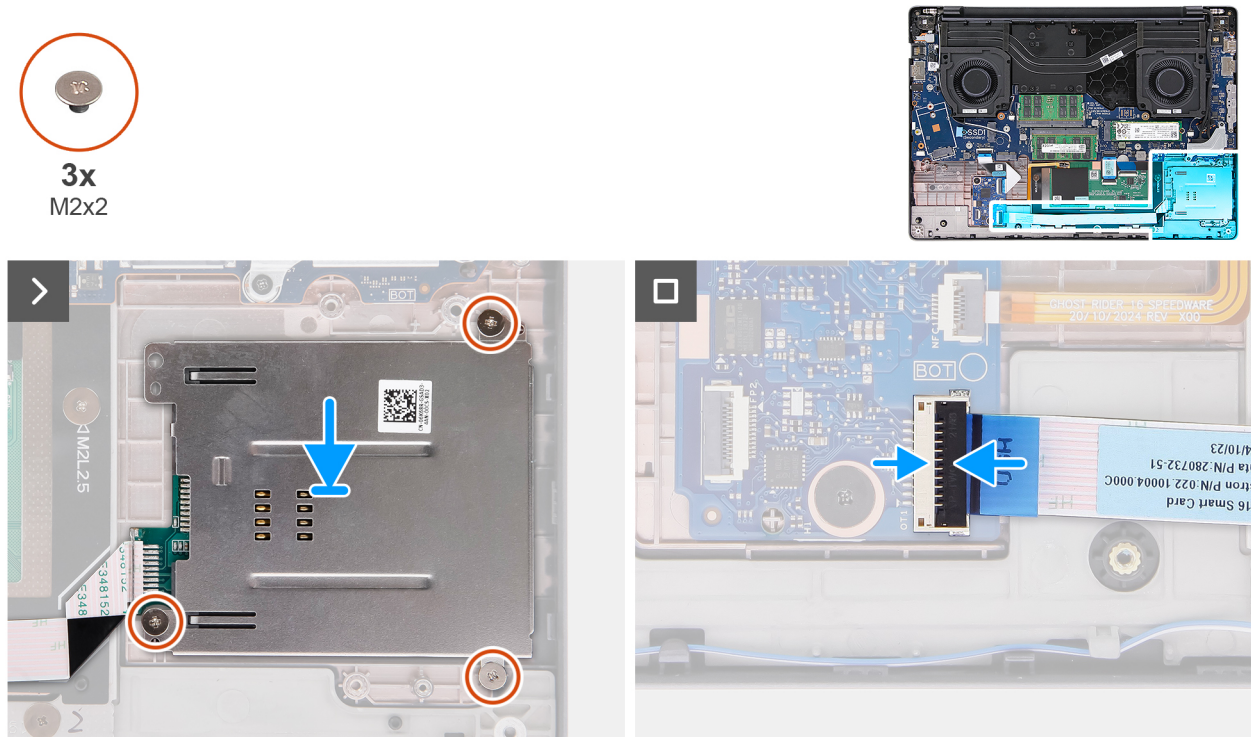

Figure 53. Installing the smart-card reader

Steps

1. Align and place the smart-card reader in the slot on the palm-rest assembly.
2. Replace the three screws (M2x2) to secure the smart-card reader to the palm-rest assembly.
3. Connect the NFC sensor or smart-card reader cable, whichever is applicable, to the connector (SC) on the USH board.

Next steps

1. Install the [battery frame](#).
2. Install the [speakers](#).
3. Install the [wireless card](#).
4. Install the [battery](#).
5. Install the [base cover](#).
6. Follow the procedure in [After working inside your computer](#).

Display assembly

Removing the display assembly

CAUTION: The information in this removal section is intended for authorized service technicians only.

CAUTION: The maximum operating angle for the display-panel hinge is 135 degrees.

Prerequisites

1. Follow the procedure in [Before working inside your computer](#).
2. Remove the [base cover](#).
3. Remove the [wireless card](#).
4. Remove the [WWAN module](#), if available.

About this task

The following images indicate the location of the display assembly and provide a visual representation of the removal procedure.

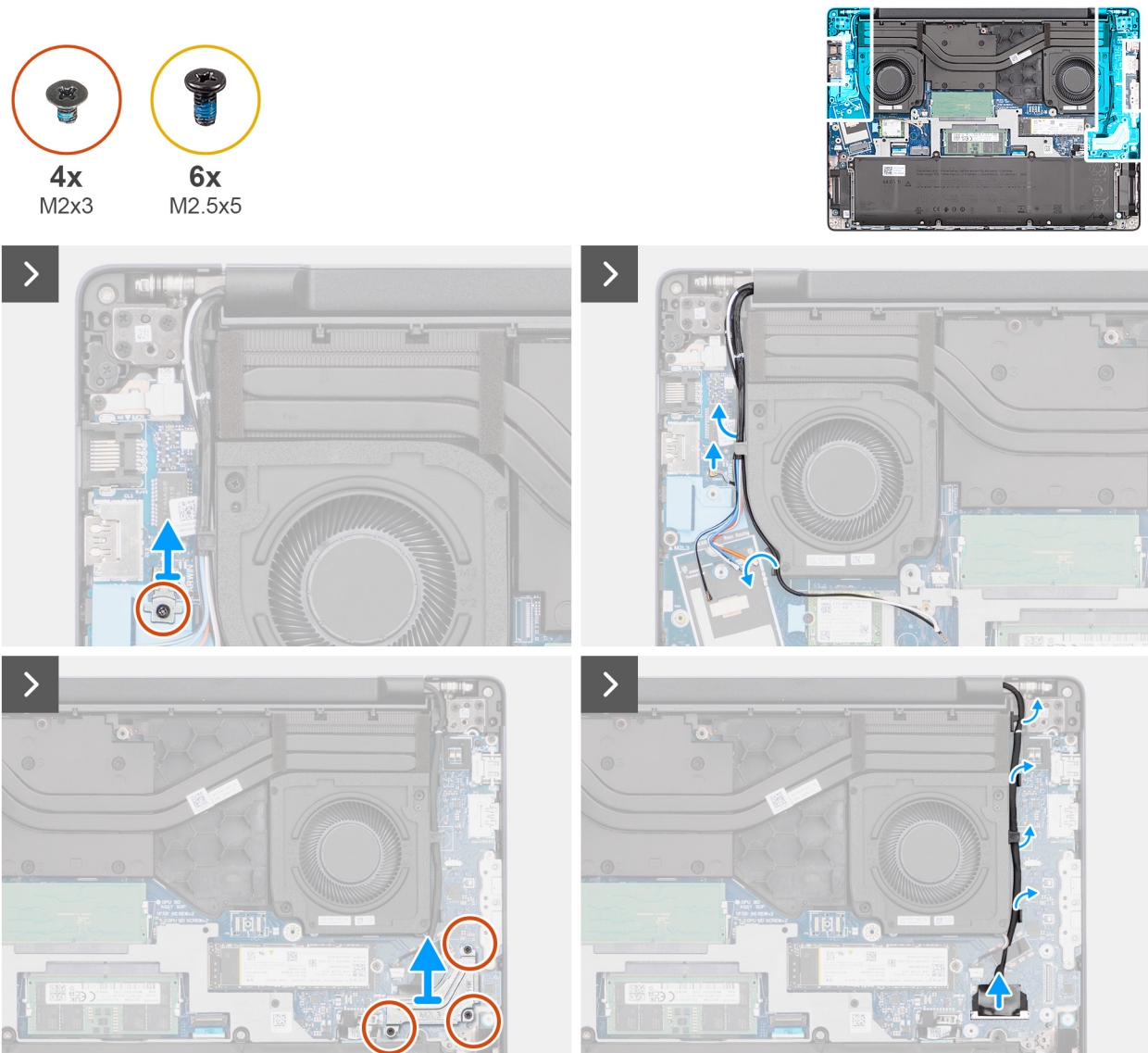

Figure 54. Removing the display assembly

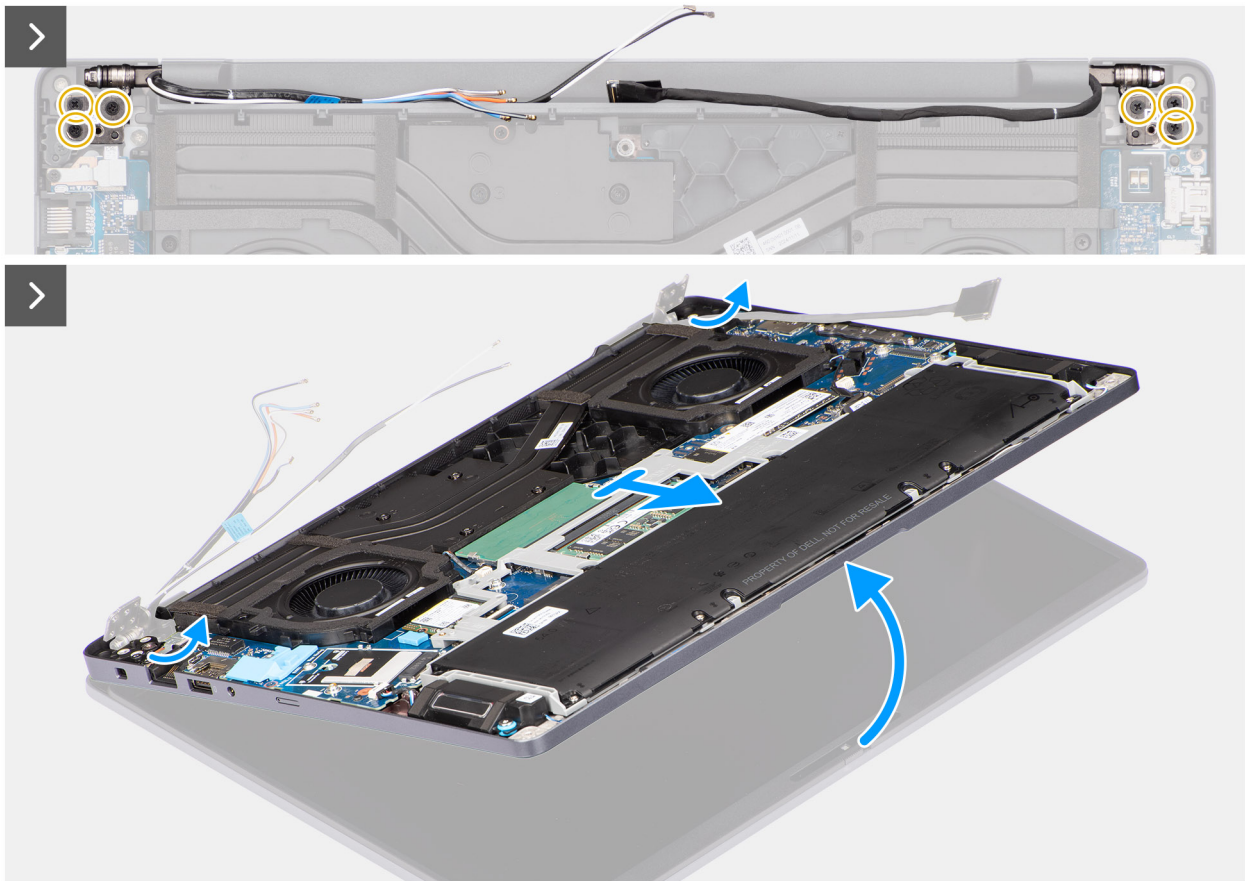

Figure 55. Removing the display assembly



Figure 56. Display assembly

Steps

1. ⓘ **NOTE:** Steps 1 to 3 apply only to computers shipped with a WWAN module installed.

Remove the screw (M2x3) that secures the Darwin-cable bracket to the system board.

2. Lift the Darwin-cable bracket off the system board.
3. Disconnect the Darwin-antenna cable from the connector (DARWIN) on the system board.
4. Remove the wireless-antenna cables and WWAN-antenna cables, if available, from the routing guides on the right/processor fan.
5. Remove the three screws (M2x3) that secure the display-cable bracket to the system board.
6. Lift the display-cable bracket off the system board.
7. Disconnect the display cable from the connector (LCD1) on the system board.
8. Disconnect the IR-camera cable from the connector (CAM1) on the system board.

 **NOTE:** This step applies only to computers shipped with an IR camera installed.

9. Remove the display cable and the IR-camera cable, if available, from the routing guides on the left/video fan.
10. Remove the six screws (M2.5x5) that secure the display hinges to the palm-rest assembly.
11. Using a plastic scribe, lift the left and right hinges to an angle of 90 degrees from the palm-rest assembly.
12. Lift the palm-rest assembly at an angle to free it from the hinges and remove it from the display assembly.

 **CAUTION:** To avoid damaging the display, do not slide the palm-rest assembly over the display assembly.

Installing the display assembly

 **CAUTION:** The information in this installation section is intended for authorized service technicians only.

 **CAUTION:** The maximum operating angle for the display-panel hinge is 135 degrees.

Prerequisites

If you are replacing a component, remove the existing component before performing the installation procedure.

About this task

 **NOTE:** Ensure that the display hinges are opened to the maximum before replacing the display assembly on the palm-rest assembly.

The following images indicate the location of the display assembly and provide a visual representation of the installation procedure.



4x
M2x3



6x
M2.5x5

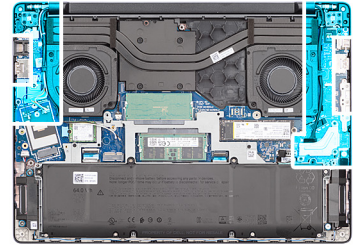

Figure 57. Installing the display assembly

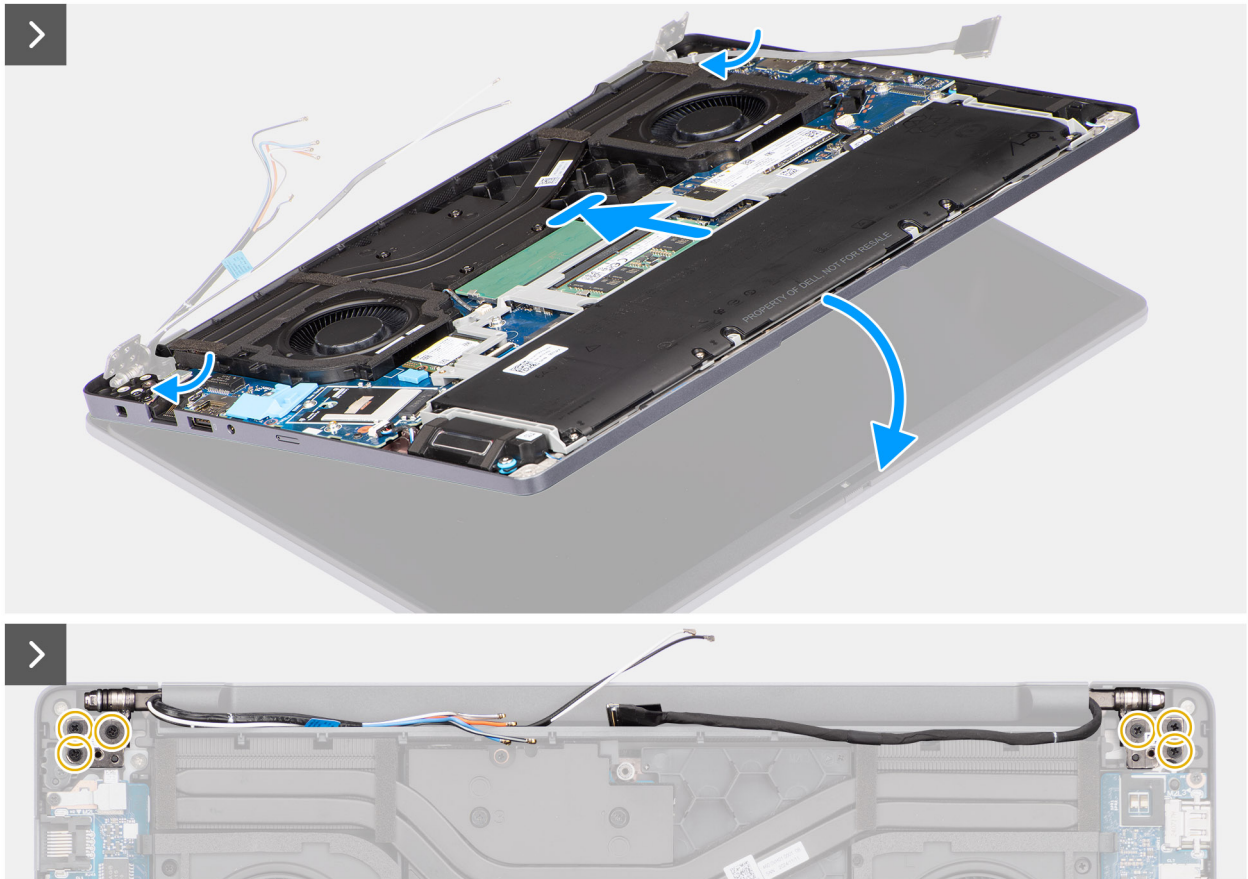

Figure 58. Installing the display assembly

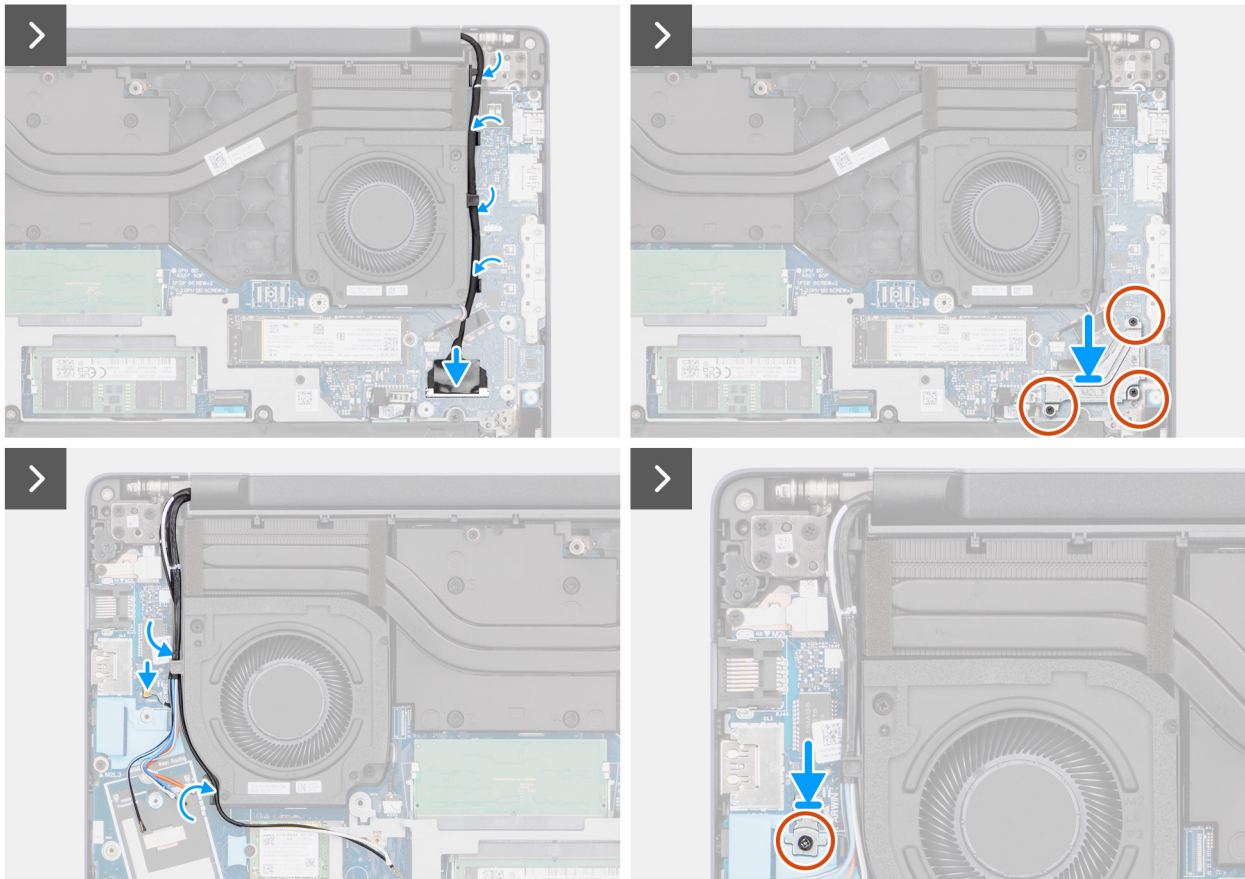

Figure 59. Installing the display assembly

Steps

1. Place the display assembly on a clean and flat surface.
 2. Hold the palm-rest assembly at an angle and slide the palm-rest assembly under the display hinges.
 - ⚠ **CAUTION: To avoid damaging the display, do not slide the palm-rest assembly over the display assembly.**
 3. Close the display hinges to align the screw holes on the display hinges with the screw holes on the palm-rest assembly.
 4. Replace the six screws (M2.5x5) to secure the display hinges to the palm-rest assembly.
 5. Route the display cable and the IR-camera cable, if available, through the routing guides on the left/video fan.
 6. Connect the display cable to the connector (LCD1) on the system board.
 7. Connect the IR-camera cable to the connector (CAM1) on the system board.
 - i **NOTE:** This step applies only to computers shipped with an IR camera installed.
 8. Align and place the display-cable bracket over the display cable and the IR-camera cable, if available, on the system board.
 9. Replace the three screws (M2x3) to secure the display-cable bracket to the system board.
 10. Route the wireless-antenna cables and WWAN-antenna cables, if available, through the routing guides on the right/processor fan.
 - i **NOTE:** Steps 11 to 13 apply only to computers shipped with a WWAN module installed.
- Connect the Darwin-antenna cable to the connector (DARWIN) on the system board.
12. Align and place the Darwin-cable bracket over the Darwin-antenna cable on the system board.
 13. Replace the screw (M2x3) to secure the Darwin-cable bracket to the system board.

Next steps

1. Install the [WWAN module](#), if available.

2. Install the [wireless card](#).
3. Install the [base cover](#).
4. Follow the procedure in [After working inside your computer](#).

Display bezel

Removing the display bezel

 **CAUTION:** The information in this removal section is intended for authorized service technicians only.

Prerequisites

1. Follow the procedure in [Before working inside your computer](#).
2. Remove the [base cover](#).
3. Remove the [wireless card](#).
4. Remove the [WWAN module](#), if available.
5. Remove the [display assembly](#).

About this task

 **NOTE:** The display-hinge caps are a part of the display bezel.

The following image indicates the location of the display bezel and provides a visual representation of the removal procedure.



Figure 60. Removing the display bezel

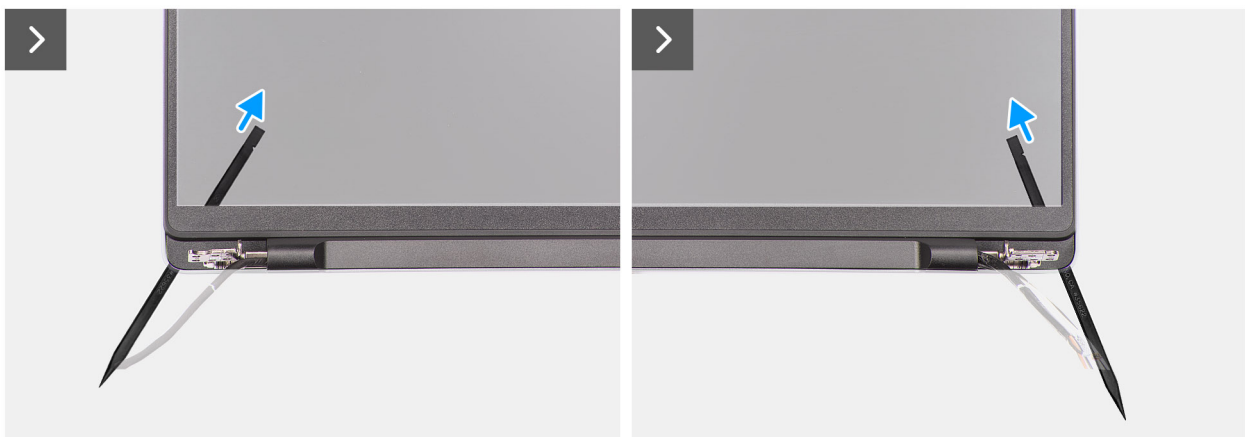

Figure 61. Removing the display bezel

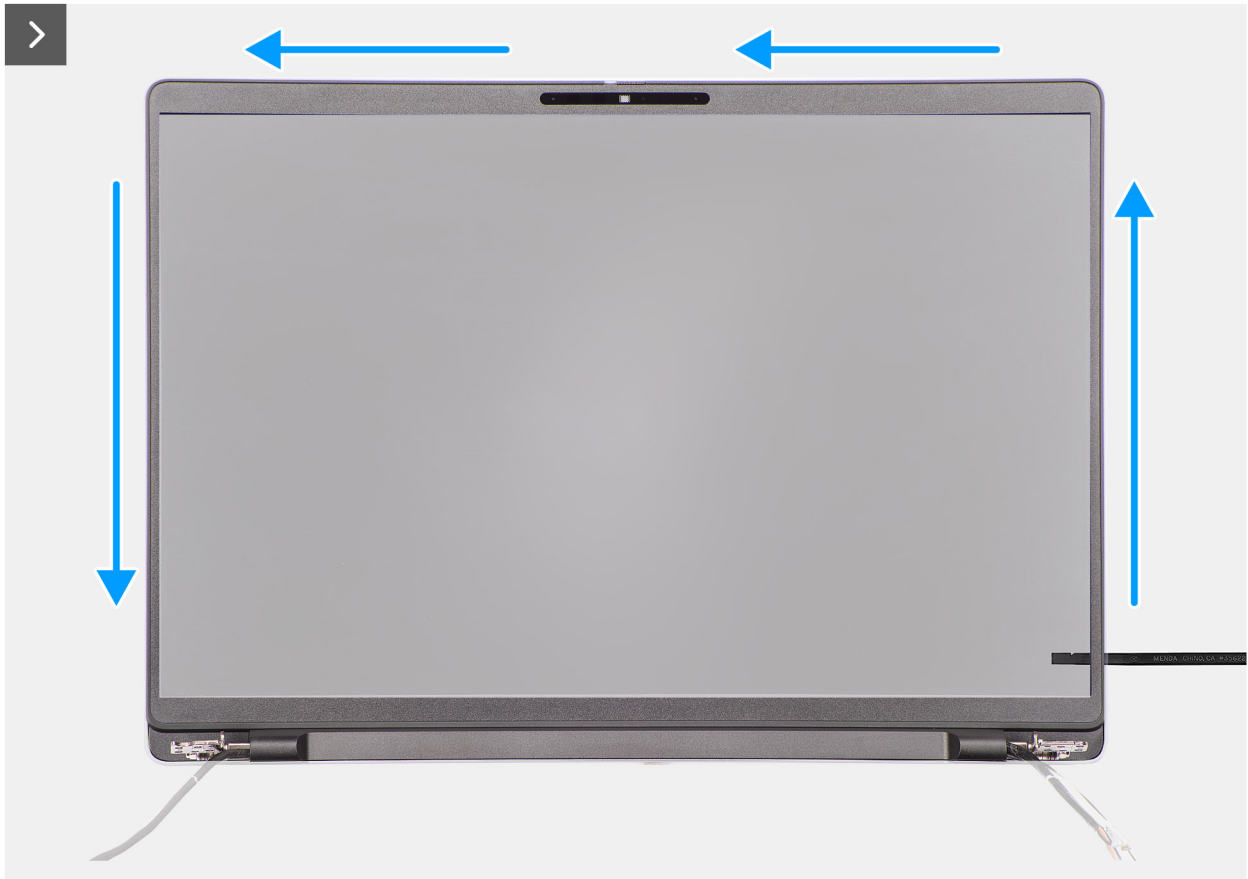

Figure 62. Removing the display bezel

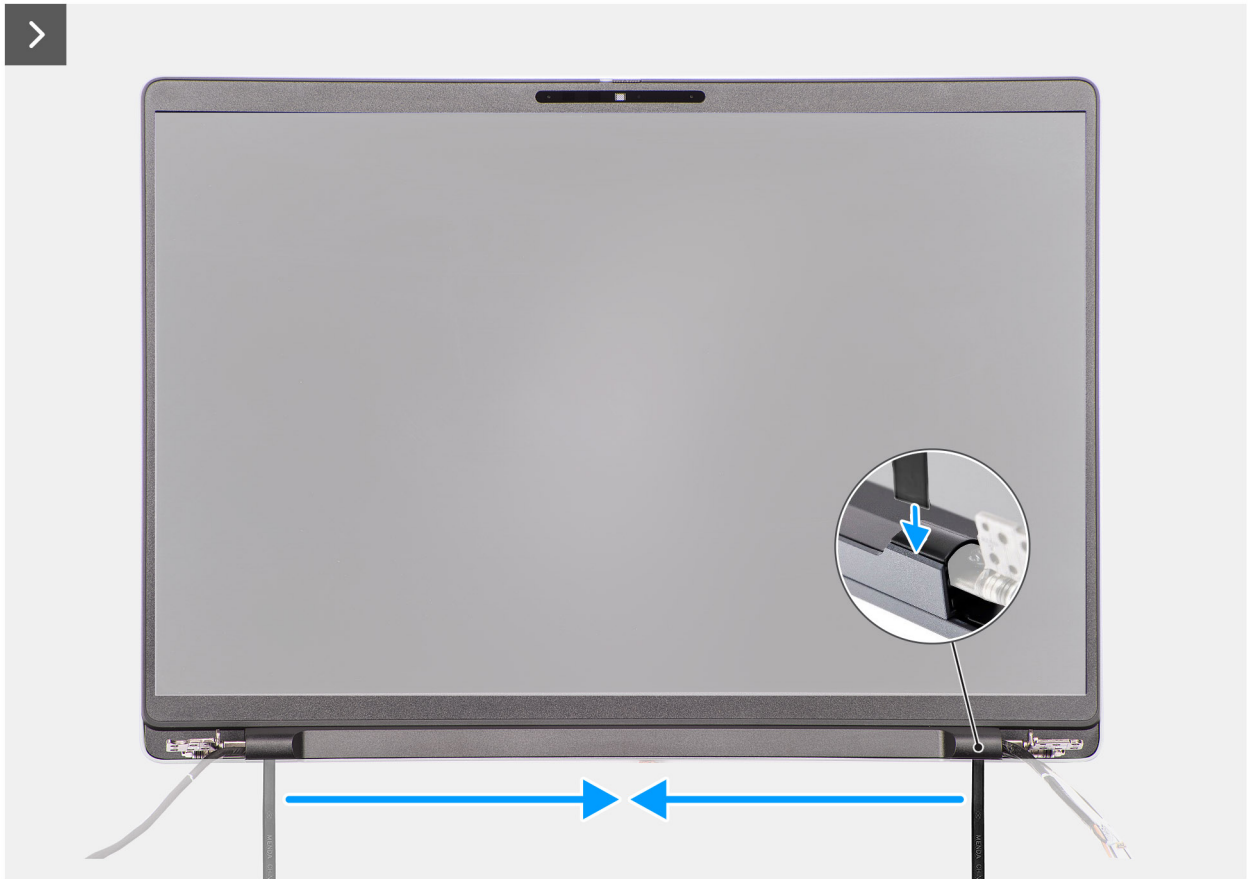

Figure 63. Removing the display bezel

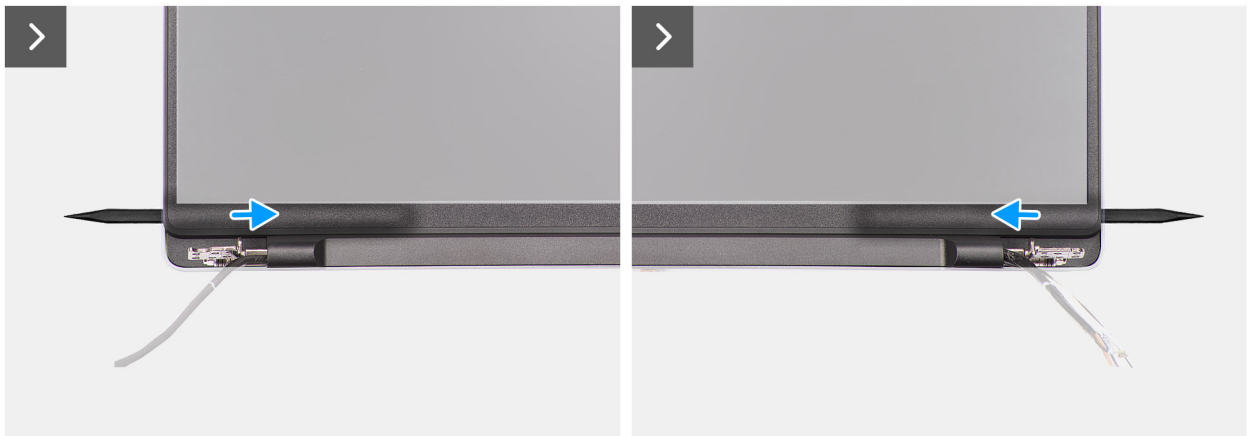

Figure 64. Removing the display bezel

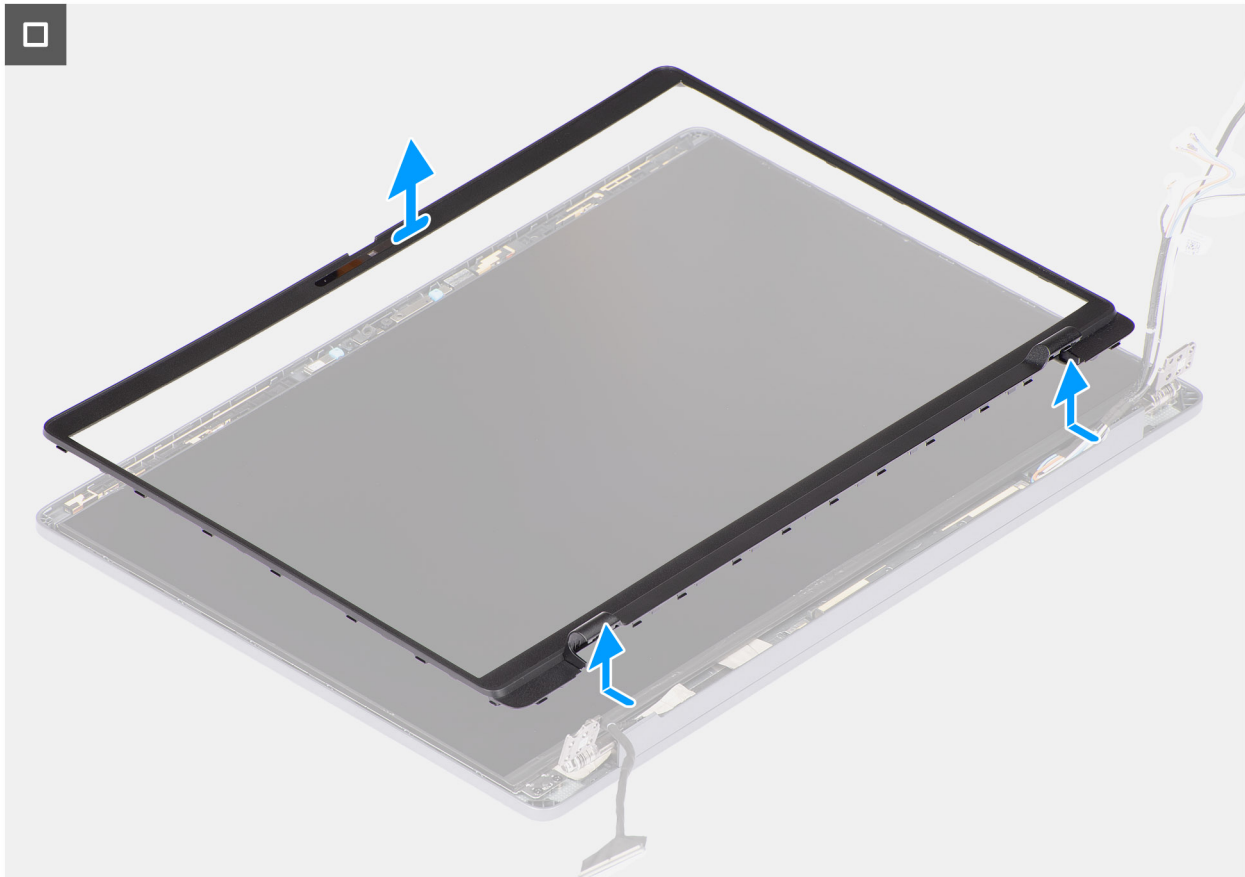

Figure 65. Removing the display bezel

Steps

1. Place the display assembly on a clean, flat surface and gently open the display hinges to at least 90 degrees.
2. At an angle, insert a flat-head slotted screwdriver (maximum width: 4 mm) into the slots on the bottom edge of the display bezel, near the display hinges. Then gently pry open the display bezel at both ends, near the hinges.

NOTE: The display bezel may get damaged during this step. If this happens, replace the display bezel with a new one.

3. **CAUTION: Do not use the flat-head slotted screwdriver to pry open the rest of the display bezel. Instead, use a plastic scribe to continue prying along the display bezel.**

CAUTION: When inserting the plastic scribe under the display bezel, ensure that it is parallel to the display panel. Pressing it down can damage the display panel.

Carefully insert a plastic scribe into the openings near the right display hinge, parallel to the display panel, to release the display bezel from the display.

4. Repeat step 4 near the left display hinge to release the display bezel from the display.
5. Keeping the plastic scribe parallel to the display panel, pry open the left, right, and top edges of the display bezel and carefully release it from the latches and adhesive on the display assembly.
6. Carefully insert the plastic scribe into the display-hinge cap at an angle of 90 degrees and pry open the display-hinge cap.
7. Keeping the plastic scribe at an angle of 90 degrees to the display panel, continue prying the bottom edge of the display bezel by sliding the scribe across the bottom edge and release it from the latches and adhesive on the display assembly.
8. Keeping the plastic scribe parallel to the right display hinge, insert the plastic scribe into the display bezel from the right edge. Then, carefully release the bezel, above the right display hinge, from the latches and adhesive on the display panel.
9. Repeat step 8 to release the display bezel above the left display hinge.
10. Lift the bezel to an angle of 15 degrees and gently pry along the middle part of the bottom edge and release the bezel from the latches and adhesive on the display panel.

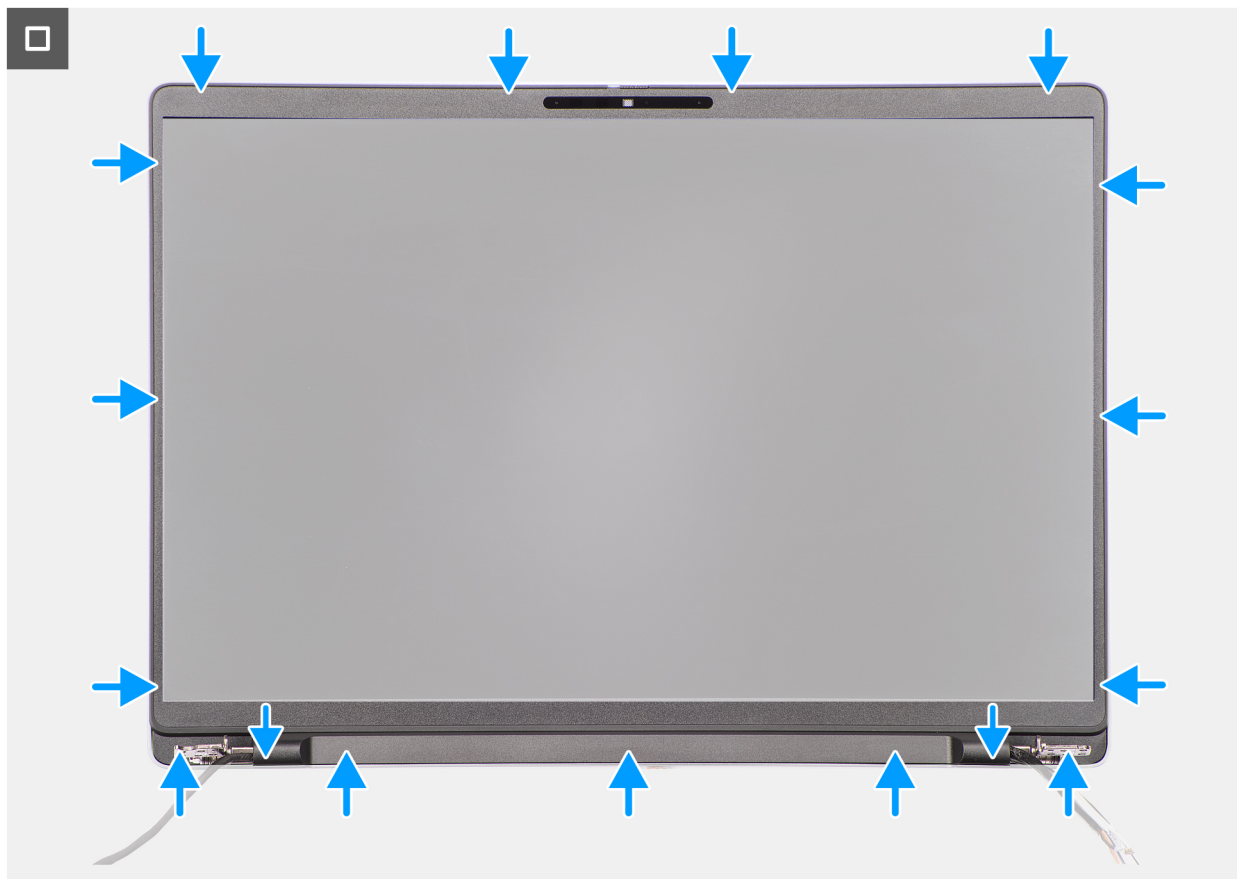

Figure 67. Installing the display bezel

Steps

1. Place the display assembly on a clean and flat surface.
2. Align and place the display bezel on the display assembly.
3. Route the display cable and wireless-antenna cables through the respective display-hinge caps.
4. Press the display-hinge caps down on the display hinges, until they click in place.
5. Starting from the bottom corner, press the display bezel and work around the entire bezel until it snaps onto the display assembly.

Next steps

1. Install the [display assembly](#).
2. Install the [WWAN module](#), if available.
3. Install the [wireless card](#).
4. Install the [base cover](#).
5. Follow the procedure in [After working inside your computer](#).

Display panel

Removing the display panel

CAUTION: The information in this removal section is intended for authorized service technicians only.

Prerequisites

1. Follow the procedure in [Before working inside your computer](#).

2. Remove the [base cover](#).
3. Remove the [wireless card](#).
4. Remove the [WWAN module](#), if available.
5. Remove the [display assembly](#).
6. Remove the [display bezel](#).

About this task

 **NOTE:** The display panel is assembled with the display-panel brackets as a single service part.

The following images indicate the location of the display panel and provide a visual representation of the removal procedure.



4x
M2x3

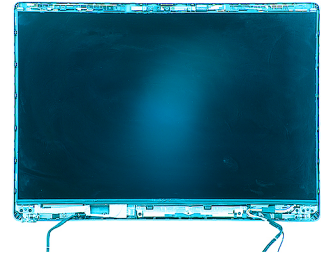

Figure 68. Removing the display panel



Figure 69. Removing the display panel

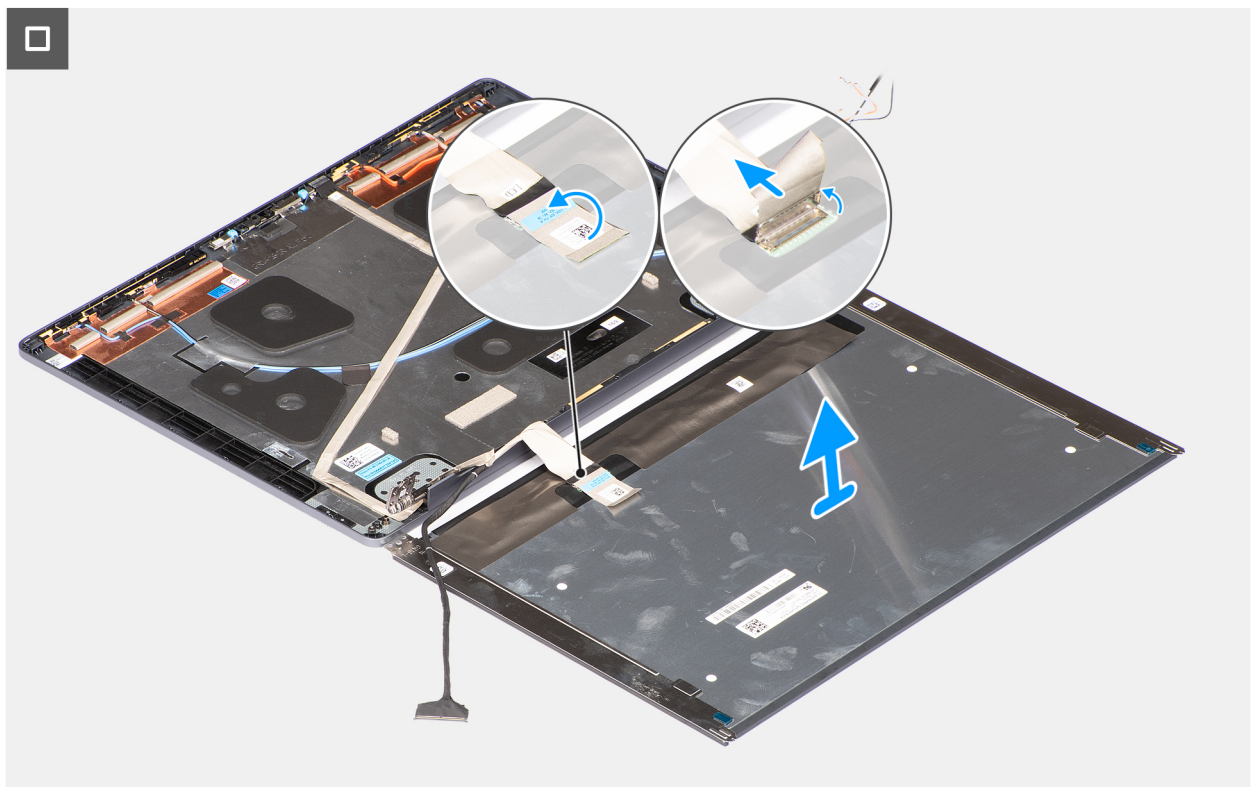

Figure 70. Removing the display panel

Steps

1. Remove the four screws (M2x3) that secure the display-panel brackets to the display back-cover and antenna assembly.
2. Holding the display-panel brackets at the top, gently flip the display panel assembly forward. Then, peel back the tape that secures the display cable to the connector on the rear of the display panel.

NOTE: To prevent damage, ensure that the display panel has a clean and smooth surface to rest on.

3. Disconnect the display cable from the connector on the display panel and remove the display panel.

CAUTION: The display panel is assembled with the display-panel brackets as a single service part. Do not pull the two pieces of elastic tape and separate the brackets from the panel.



Figure 71. Display panel

Installing the display panel

CAUTION: The information in this installation section is intended for authorized service technicians only.

Prerequisites

If you are replacing a component, remove the existing component before performing the installation procedure.

About this task

NOTE: The display panel is assembled with the display-panel brackets as a single service part.

The following images indicate the location of the display panel and provide a visual representation of the installation procedure.



4x
M2x3

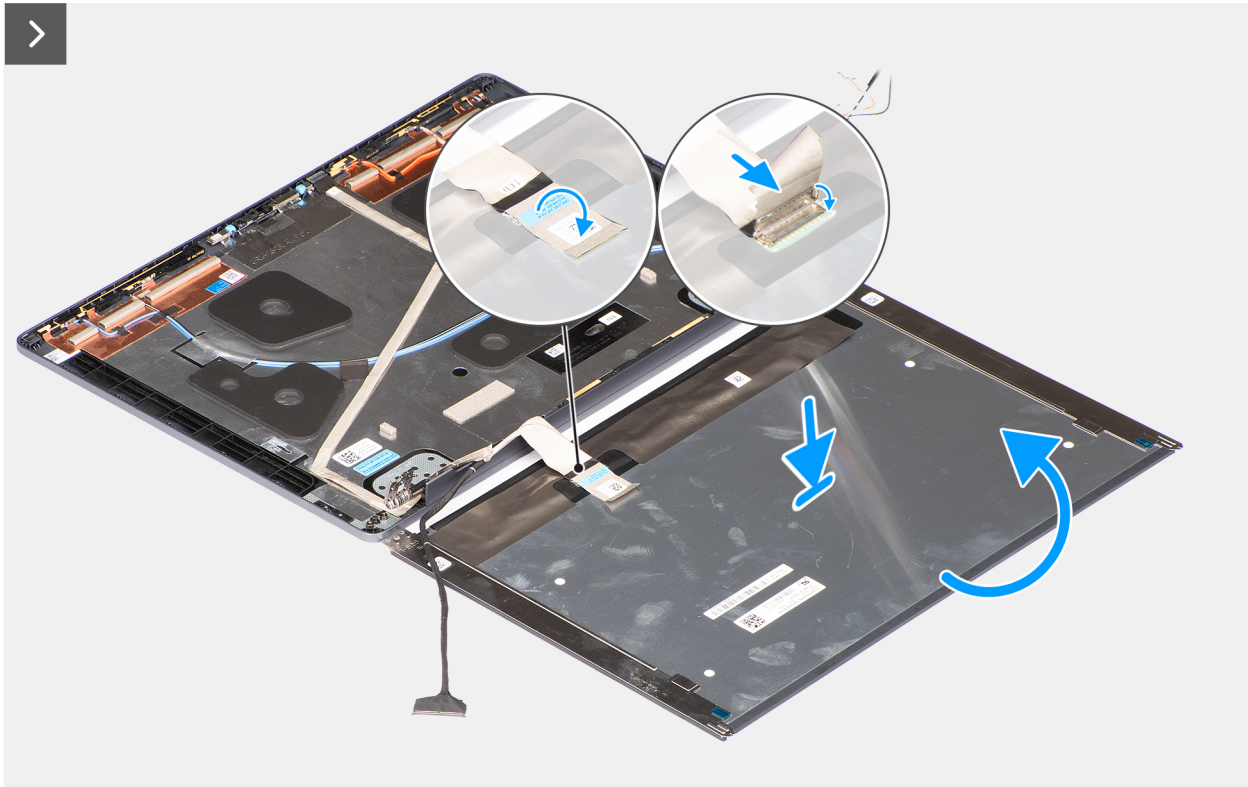
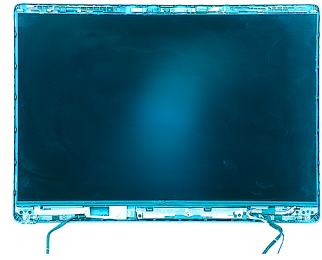

Figure 72. Installing the display panel



Figure 73. Installing the display panel

Steps

1. Place the display panel and display assembly on a clean and flat surface.
2. Connect the display cable to the connector on the display panel.
3. Adhere the tape to secure the display cable to the connector on the display panel.
4. Gently turn the display panel over and place the display panel in the slot on the display back cover.
5. Replace the four screws (M2x3) to secure the display-panel brackets to the display back-cover and antenna assembly.

Next steps

1. Install the [display bezel](#).
2. Install the [display assembly](#).
3. Install the [WWAN module](#), if available.
4. Install the [wireless card](#).
5. Install the [base cover](#).
6. Follow the procedure in [After working inside your computer](#).

Display hinges

Removing the display hinges

CAUTION: The information in this removal section is intended for authorized service technicians only.

Prerequisites

1. Follow the procedure in [Before working inside your computer](#).

2. Remove the [base cover](#).
3. Remove the [wireless card](#).
4. Remove the [WWAN module](#), if available.
5. Remove the [display assembly](#).
6. Remove the [display bezel](#).
7. Remove the [display panel](#).

About this task

The following images indicate the location of the display hinges and provide a visual representation of the removal procedure.

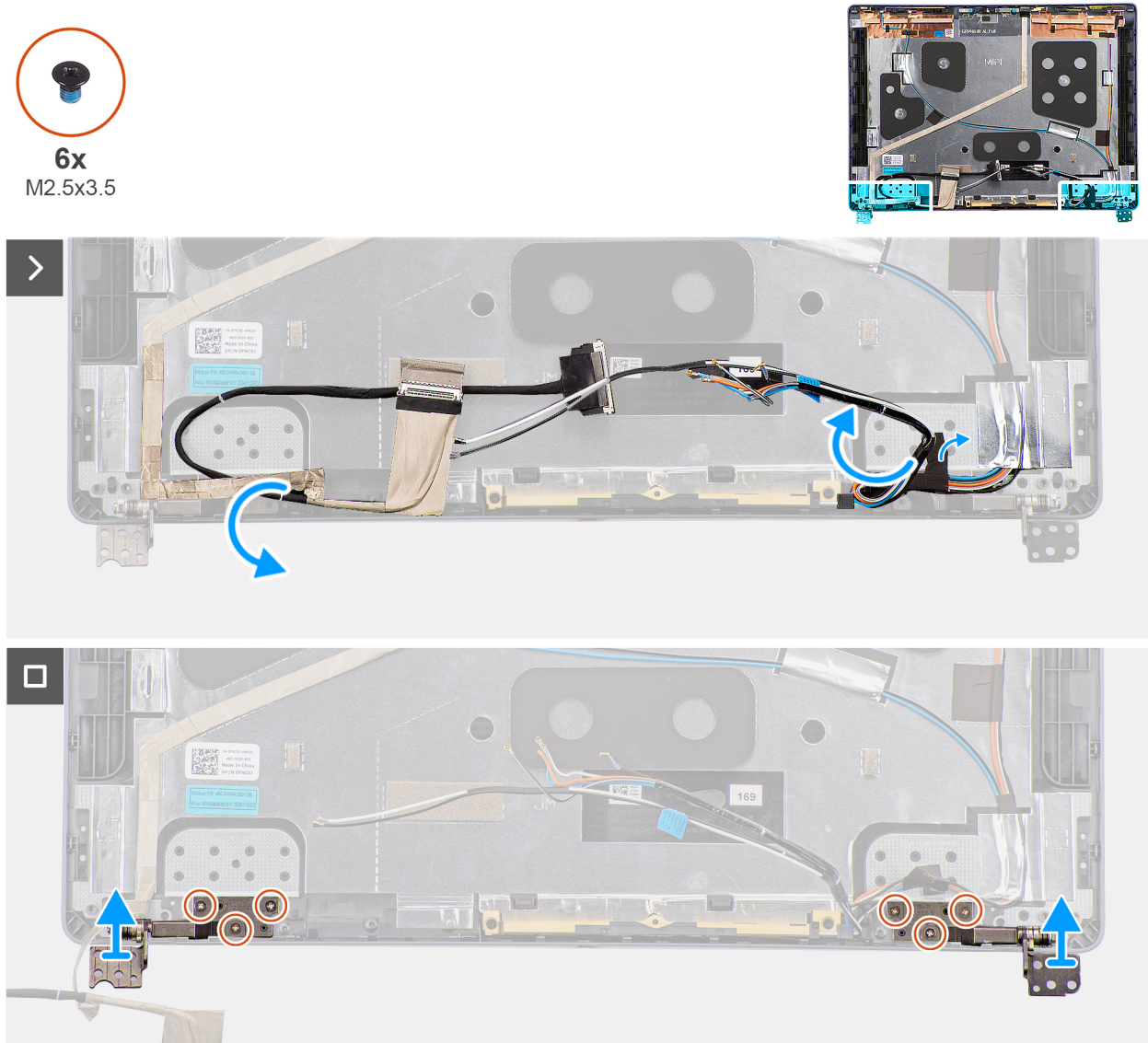

Figure 74. Removing the display hinges

Steps

1. Gently peel back the display cable to access the left display hinge on the display back cover.
2. Gently peel back the tapes that secure the wireless-antenna cables and WWAN-antenna cables, if available, to the display back cover.
3. Remove the three screws (M2.5x3.5) that secure the right display hinge to the display back cover.
4. Lift and remove the right display hinge from the display back-cover and antenna assembly.
5. Repeat steps 3 and 4 to remove the left display hinge from the display back-cover and antenna assembly.

Installing the display hinges

CAUTION: The information in this installation section is intended for authorized service technicians only.

Prerequisites

If you are replacing a component, remove the existing component before performing the installation procedure.

About this task

The following images indicate the location of the display hinges and provide a visual representation of the installation procedure.

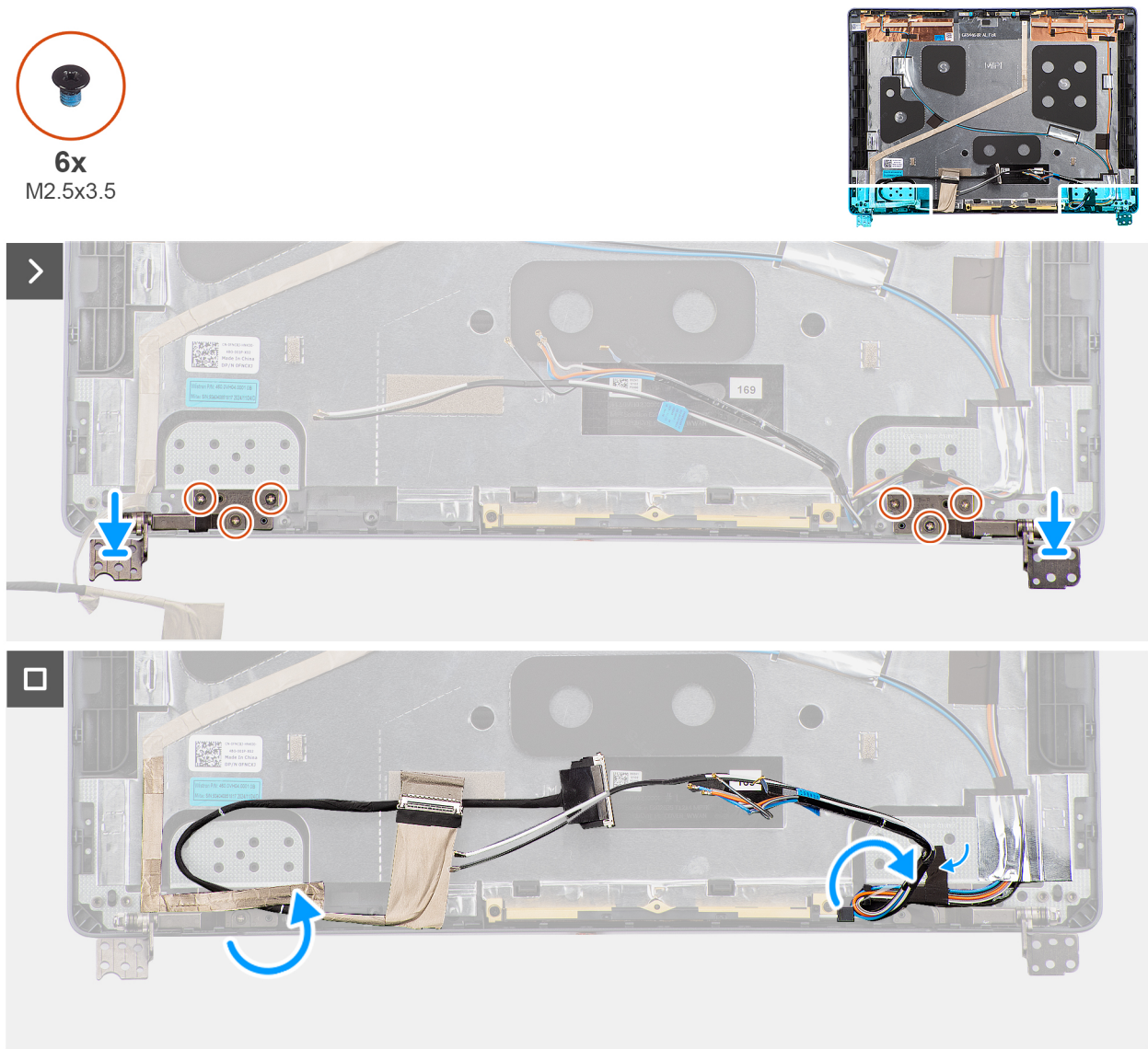

Figure 75. Installing the display hinges

Steps

1. Align and place the right display hinge on the display back-cover and antenna assembly.
2. Replace the three screws (M2.5x3.5) to secure the right display hinge to the display back cover.
3. Repeat steps 1 and 2 to secure the left display hinge to the display back cover.
4. Adhere the tapes to secure the wireless-antenna cables and WWAN-antenna cables, if available, to the display back-cover and antenna assembly.
5. Adhere the display cable and secure it to the display back-cover and antenna assembly.

Next steps

1. Install the [display panel](#).
2. Install the [display bezel](#).
3. Install the [display assembly](#).
4. Install the [WWAN module](#), if available.
5. Install the [wireless card](#).
6. Install the [base cover](#).
7. Follow the procedure in [After working inside your computer](#).

Display cable

Removing the display cable

 **CAUTION:** The information in this removal section is intended for authorized service technicians only.

Prerequisites

1. Follow the procedure in [Before working inside your computer](#).
2. Remove the [base cover](#).
3. Remove the [wireless card](#).
4. Remove the [WWAN module](#), if available.
5. Remove the [display assembly](#).
6. Remove the [display bezel](#).
7. Remove the [display panel](#).

About this task

The following image indicates the location of the display cable and provides a visual representation of the removal procedure.

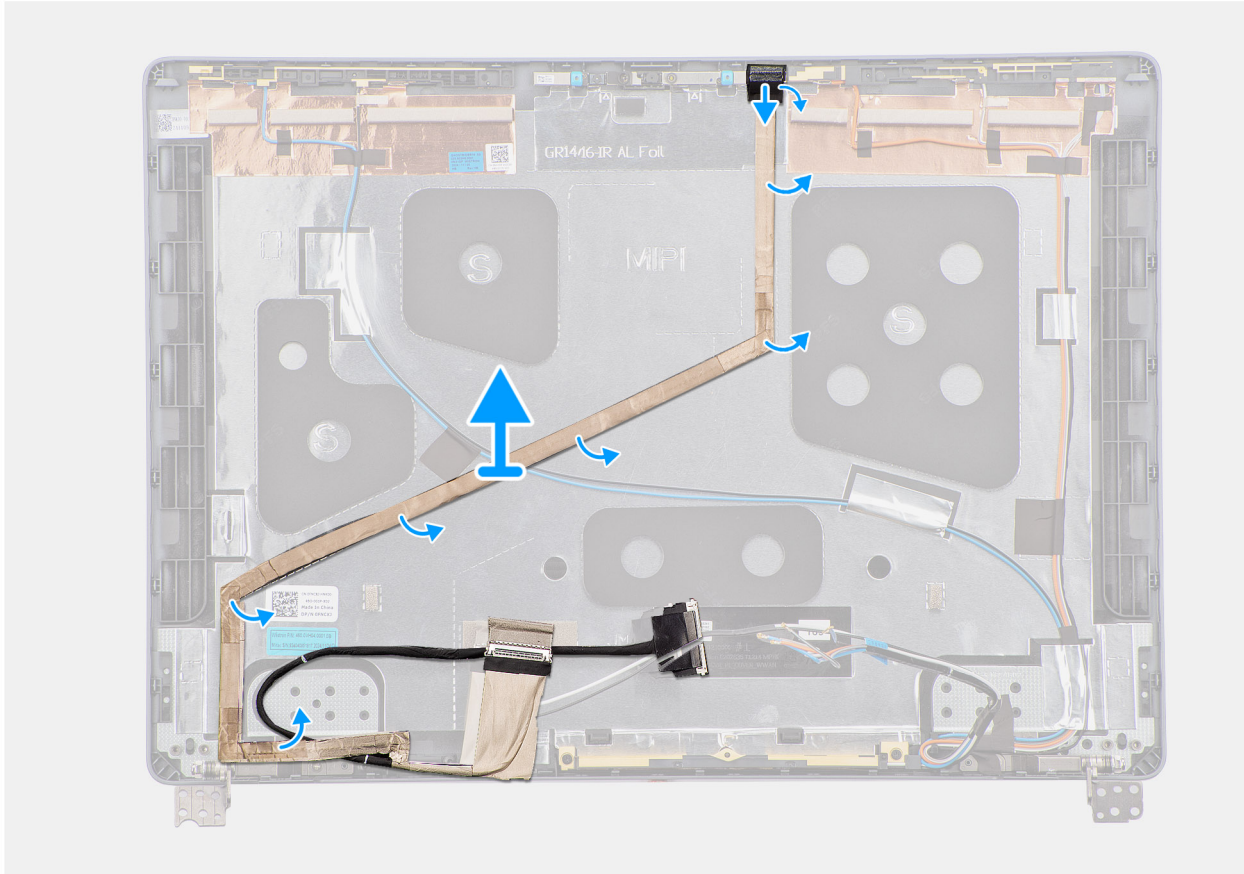
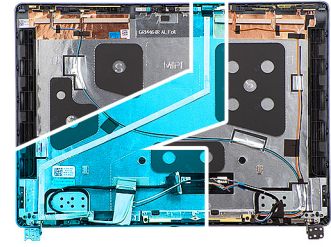

Figure 76. Removing the display cable

Steps

1. Disconnect the display cable from the connector on the camera module.
2. Carefully peel back and remove the display cable from the display back-cover and antenna assembly.

Installing the display cable

CAUTION: The information in this installation section is intended for authorized service technicians only.

Prerequisites

If you are replacing a component, remove the existing component before performing the installation procedure.

About this task

The following image indicates the location of the display cable and provides a visual representation of the installation procedure.

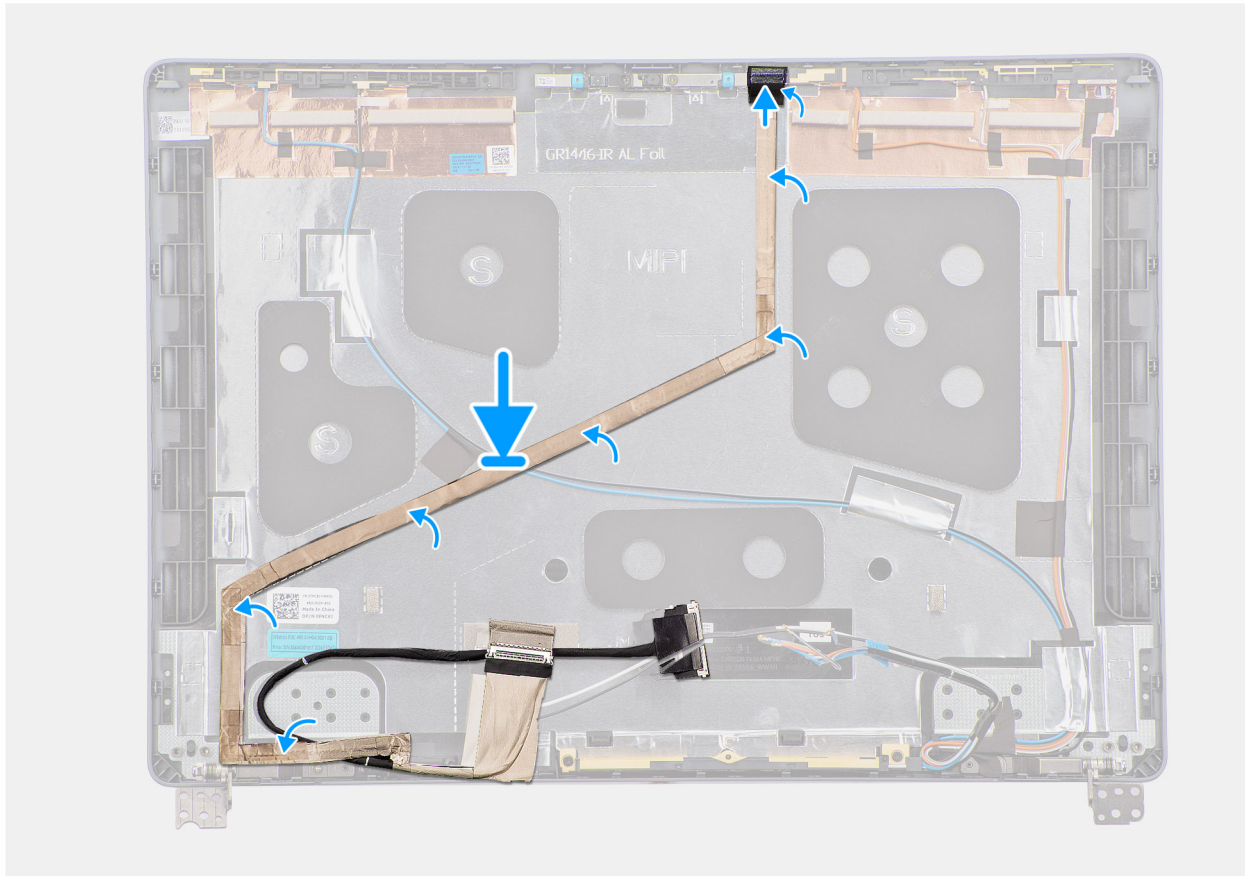
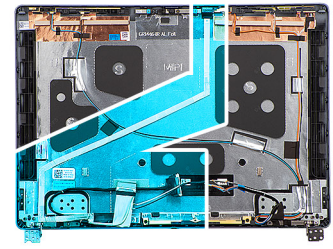

Figure 77. Installing the display cable

Steps

1. Adhere the display cable to the display back-cover and antenna assembly.
2. Connect the display cable to the connector on the camera module.

Next steps

1. Install the [display panel](#).
2. Install the [display bezel](#).
3. Install the [display assembly](#).
4. Install the [WWAN module](#), if available.
5. Install the [wireless card](#).
6. Install the [base cover](#).
7. Follow the procedure in [After working inside your computer](#).

Camera

Removing the camera

CAUTION: The information in this removal section is intended for authorized service technicians only.

Prerequisites

1. Follow the procedure in [Before working inside your computer](#).
2. Remove the [base cover](#).
3. Remove the [wireless card](#).
4. Remove the [WWAN module](#), if available.
5. Remove the [display assembly](#).
6. Remove the [display bezel](#).
7. Remove the [display panel](#).

About this task

NOTE: The camera module is removed with the foil as a single service part.

The following images indicate the location of the camera module and provide a visual representation of the removal procedure.

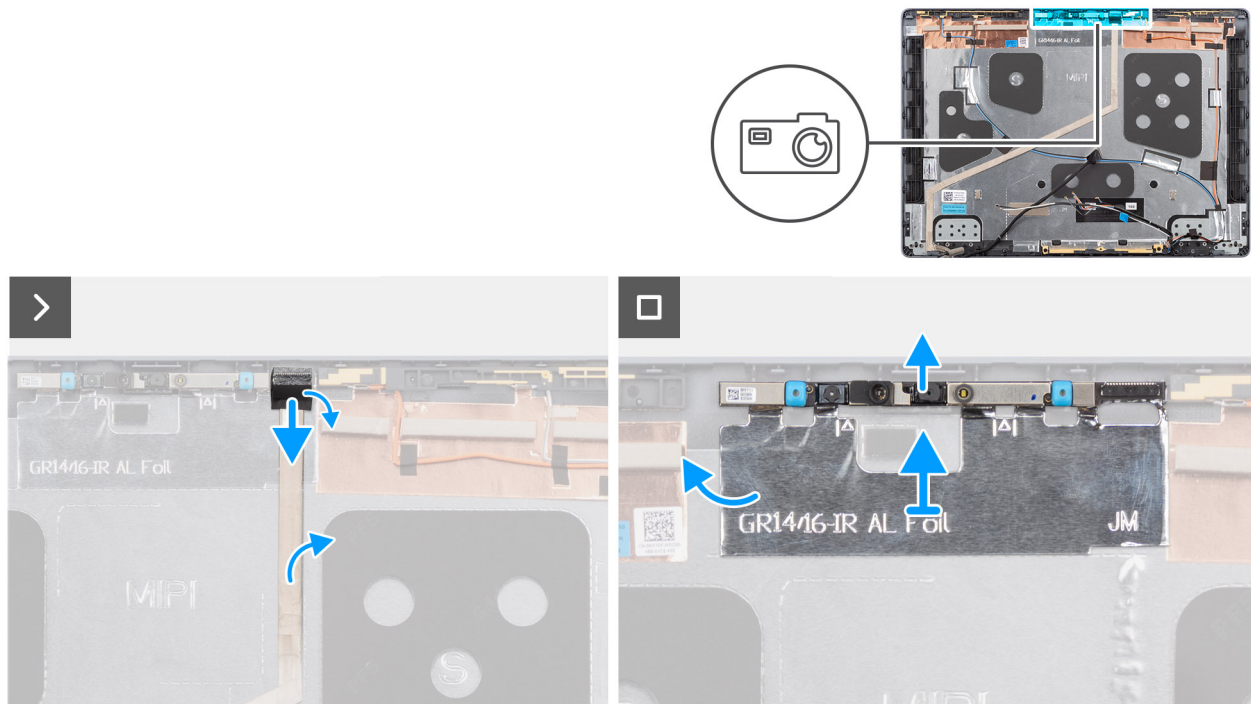

Figure 78. Removing the camera

Steps

1. Disconnect the display cable from the connector on the camera module.
2. Gently peel back the copper or aluminum foil, whichever is applicable, from the display back-cover and antenna assembly.
3. Remove the camera module, along with the foil, from the display assembly.

Installing the camera

CAUTION: The information in this installation section is intended for authorized service technicians only.

Prerequisites

If you are replacing a component, remove the existing component before performing the installation procedure.

About this task

NOTE: The camera module is installed with the foil as a single service part.

The following images indicate the location of the camera module and provide a visual representation of the installation procedure.

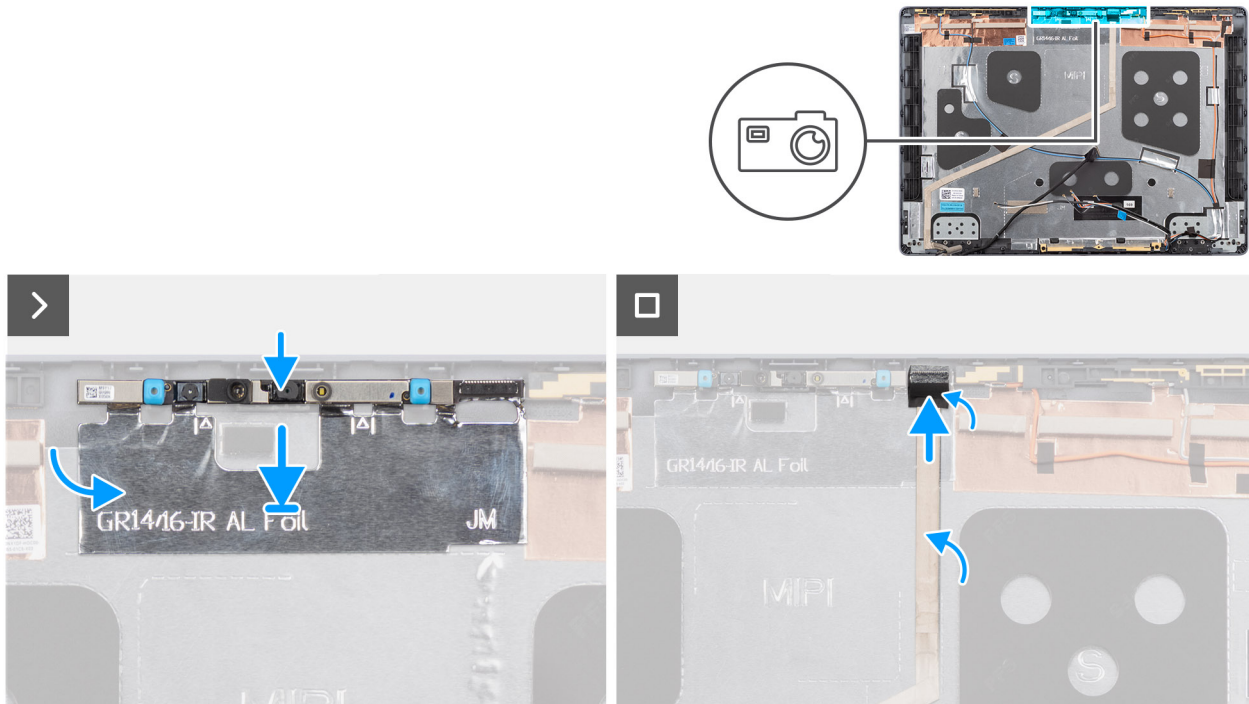

Figure 79. Installing the camera

Steps

1. Align and place the camera module in the alignment post on the display back-cover and antenna assembly.
2. Adhere the copper or aluminum foil, whichever is applicable, to the display back-cover and antenna assembly.
3. Connect the display cable to the connector on the camera module.

Next steps

1. Install the [display panel](#).
2. Install the [display bezel](#).
3. Install the [display assembly](#).
4. Install the [WWAN module](#), if available.
5. Install the [wireless card](#).
6. Install the [base cover](#).
7. Follow the procedure in [After working inside your computer](#).

Display back-cover and antenna assembly

Removing the display back-cover and antenna assembly

CAUTION: The information in this removal section is intended for authorized service technicians only.

Prerequisites

1. Follow the procedure in [Before working inside your computer](#).
2. Remove the [base cover](#).
3. Remove the [wireless card](#).
4. Remove the [WWAN module](#), if available.
5. Remove the [display assembly](#).
6. Remove the [display bezel](#).
7. Remove the [display panel](#).
8. Remove the [display hinges](#).
9. Remove the [display cable](#).
10. Remove the [camera](#).

About this task

NOTE: The display back-cover and antenna assembly cannot be further disassembled once all the **Prerequisites** are completed. If the wireless antennas are malfunctioning and are required to be replaced, replace the entire display back-cover and antenna assembly.

The image below shows the display back-cover and antenna assembly after the **Prerequisites** have been performed.

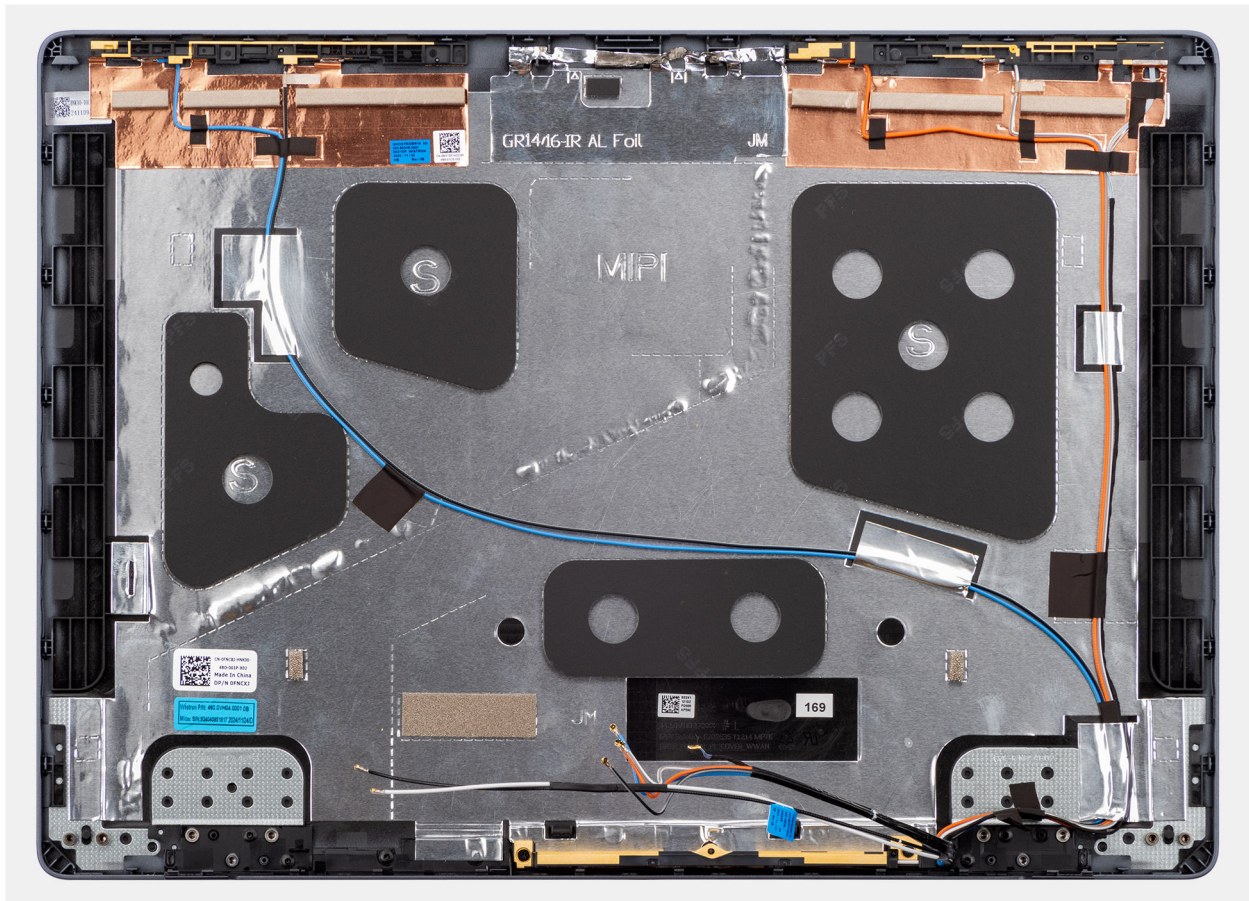

Figure 80. Display back-cover and antenna assembly

Steps

After performing the **Prerequisites**, you are left with the display back-cover and antenna assembly.

Installing the display back-cover and antenna assembly

CAUTION: The information in this installation section is intended for authorized service technicians only.

Prerequisites

If you are replacing a component, remove the existing component before performing the installation procedure.

About this task

The image below shows the display back-cover and antenna assembly.

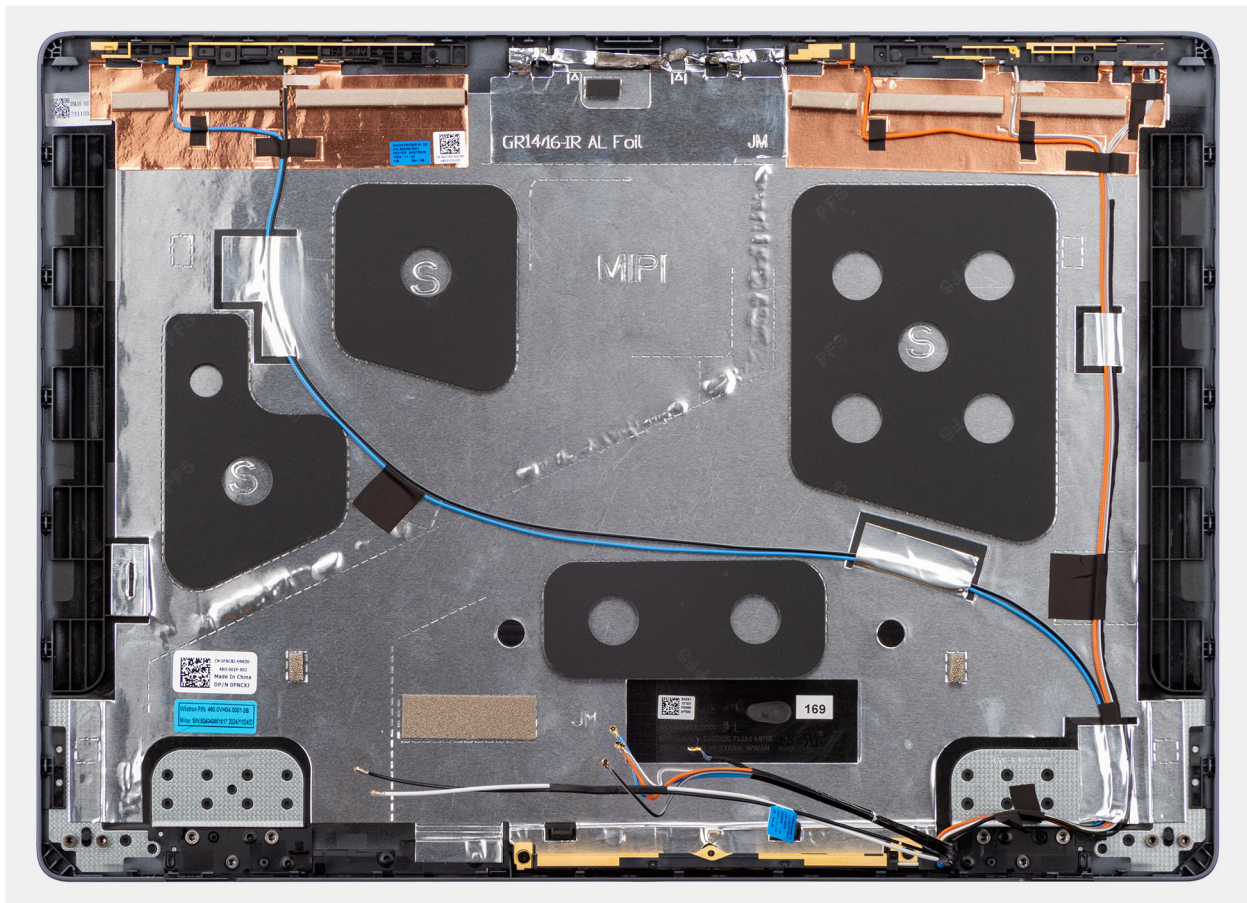

Figure 81. Display back-cover and antenna assembly

Steps

Place the display back-cover and antenna assembly on a flat surface and perform the **Next steps** to install the display back-cover and antenna assembly.

Next steps

1. Install the [camera](#).
2. Install the [display cable](#).
3. Install the [display hinges](#).
4. Install the [display panel](#).
5. Install the [display bezel](#).
6. Install the [display assembly](#).
7. Install the [WWAN module](#), if available.
8. Install the [wireless card](#).
9. Install the [base cover](#).
10. Follow the procedure in [After working inside your computer](#).

System board

Removing the system board - for computers shipped with integrated graphics card

CAUTION: The information in this removal section is intended for authorized service technicians only.

Prerequisites

1. Follow the procedure in [Before working inside your computer](#).
2. Remove the [base cover](#).
3. Remove the [battery](#).
4. Remove the [memory module](#).
5. Remove the [M.2 2230 solid state drive](#) or [M.2 2280 solid state drive](#), whichever is applicable.
6. Remove the [wireless card](#).
7. Remove the [WWAN module](#), if available.
8. Remove the [right/processor fan](#).
9. Remove the [left/video fan](#).
10. Remove the [heat sink](#).

NOTE: If you are removing the system board to replace/access other parts, you may remove the system board with the heat sink attached to it in order to simplify the procedure and preserve the thermal bond between the system board and heat sink.

11. Remove the [battery frame](#).

About this task

The following image indicates the connectors on your system board.

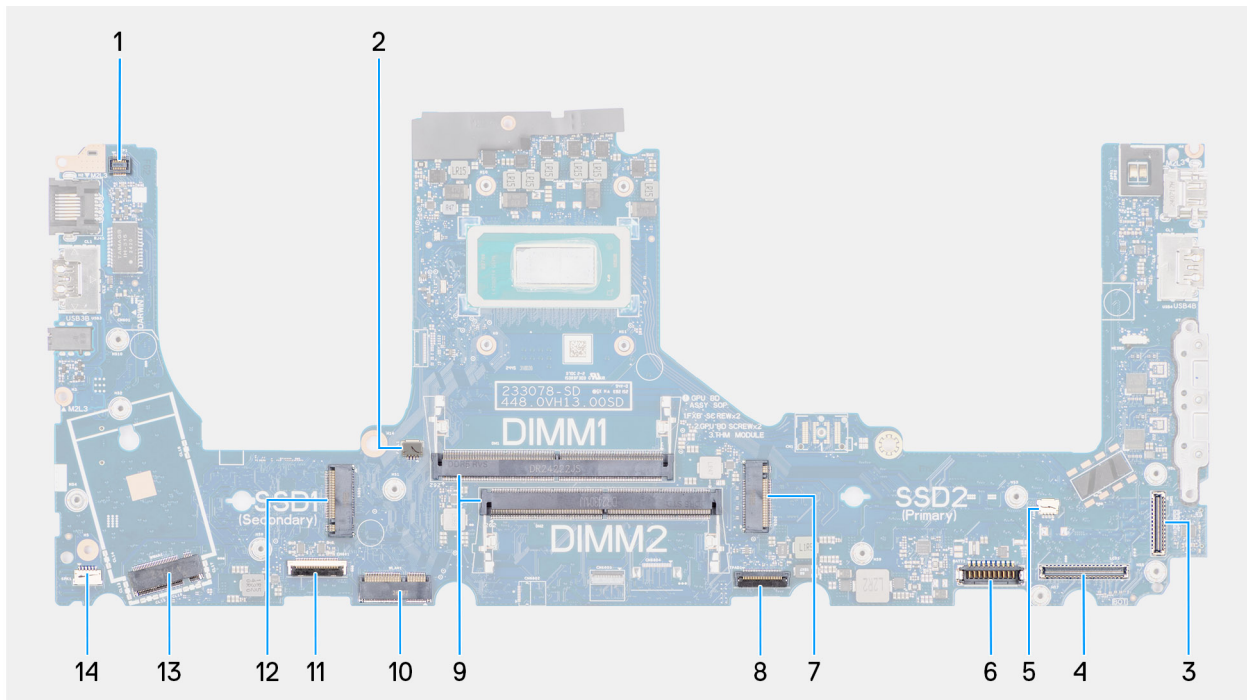

Figure 82. System board connectors

1. Fingerprint-reader cable connector (FP1)
2. Right/Processor-fan cable connector (FANL1)

3. IR-camera cable connector (CAM1)
4. Display-cable connector (LCD1)
5. Left/Video-fan cable connector (FANR2)
6. Battery-cable connector (BATT1)
7. Primary M.2 solid state drive connector (SSD2)
8. Touchpad-cable connector (TPAD1)
9. Memory-module connectors (DIMM1 and DIMM2)
10. Wireless-card connector (WLAN1)
11. USH-board cable connector (CN661)
12. Secondary M.2 solid state drive connector (SSD1)
13. WWAN-module connector (WWAN1)
14. Speaker-cable connector (SPK1)

The following images indicate the location of the system board and provide a visual representation of the removal procedure.

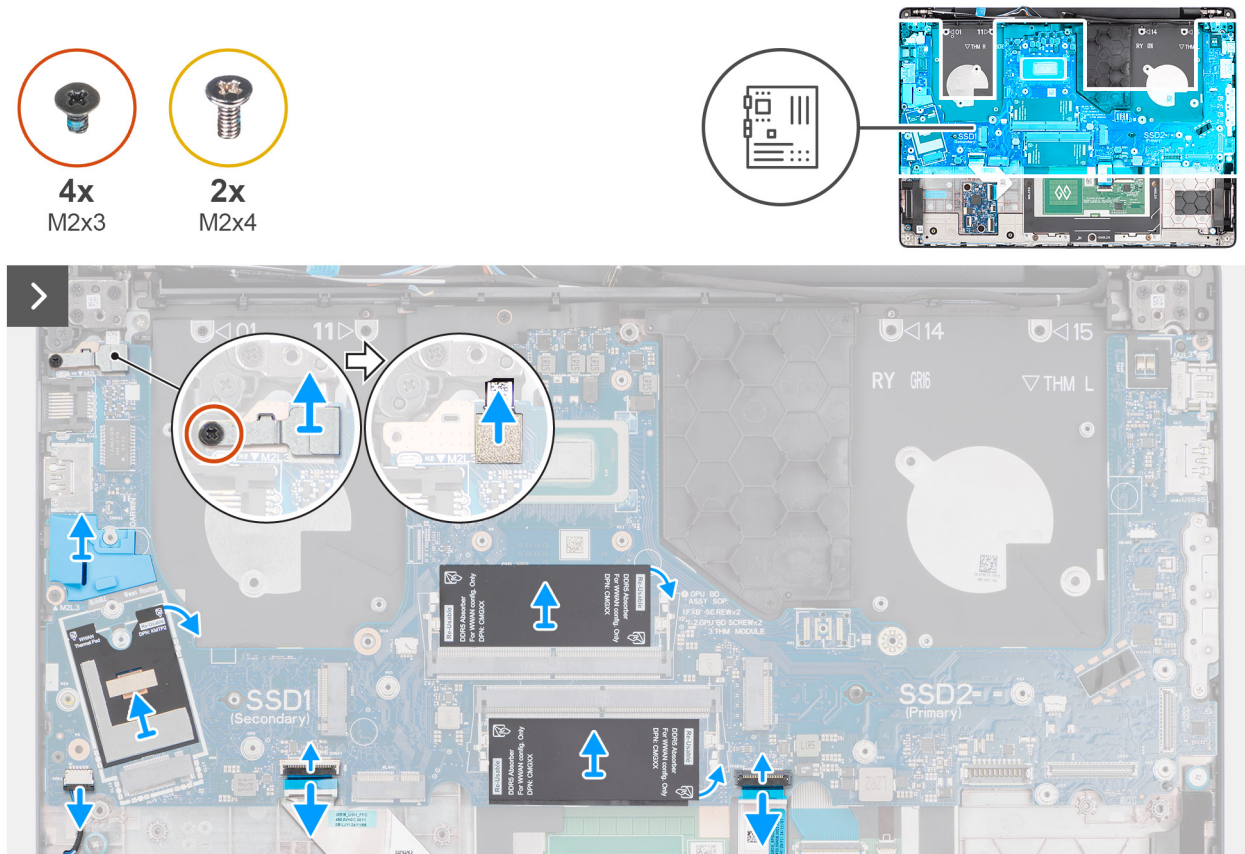

Figure 83. Removing the system board

Steps

1. Remove the reusable Mylar sheet with thermal pads from the system board and transfer it to the new replacement system board.
2. Remove the screw (M2x3) that secures the fingerprint-reader bracket to the palm-rest assembly.
 - i** **NOTE:** Steps 1 to 3 apply only to computers shipped with a fingerprint reader installed.
3. Lift the fingerprint-reader bracket off the system board.
4. Disconnect the fingerprint-reader cable from the connector (FP1) on the system board.
5. Disconnect the following cables from the system board:
 - a. Speaker cable (SPK1)
 - b. Touchpad cable (TPAD1)
 - c. USH-board cable (CN661)

- For computers shipped without a fingerprint reader, remove the four screws (M2x3) and the two screws (M2x4) that secure the system board to the palm-rest assembly.
For computers shipped with a fingerprint reader, remove the three screws (M2x3) and the two screws (M2x4) that secure the system board to the palm-rest assembly.

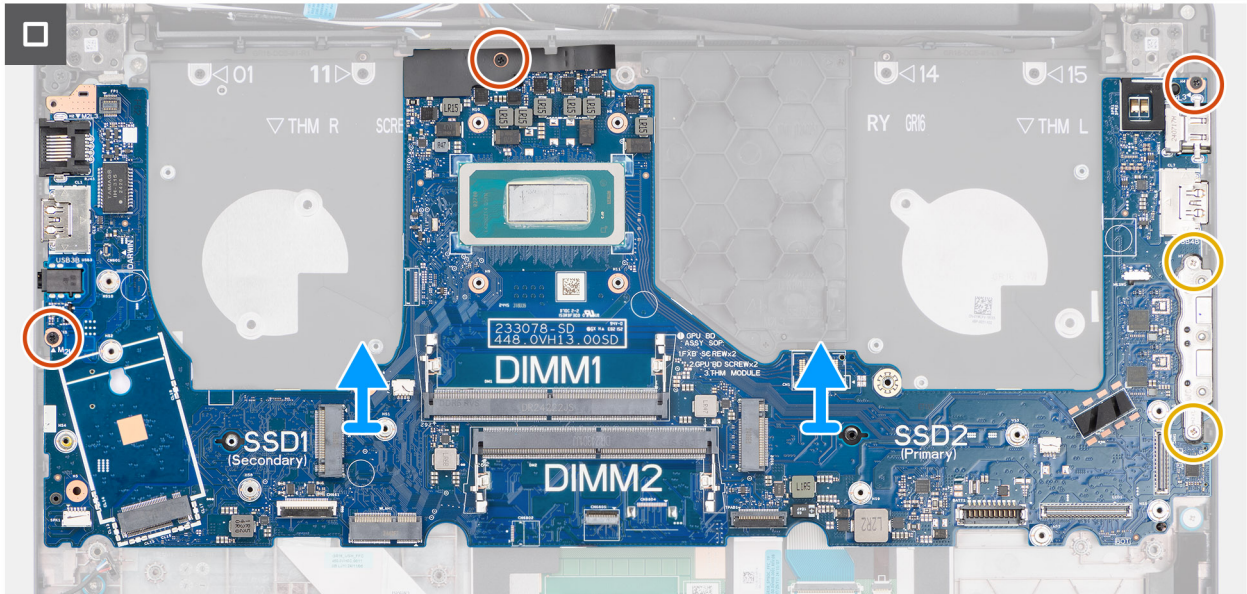

Figure 84. Removing the system board

- Carefully lift and remove the system board at angle, from the palm-rest assembly, to clear the ports from the port slots.

Installing the system board - for computers shipped with integrated graphics card

CAUTION: The information in this installation section is intended for authorized service technicians only.

Prerequisites

If you are replacing a component, remove the existing component before performing the installation procedure.

About this task

The following image indicates the connectors on your system board.

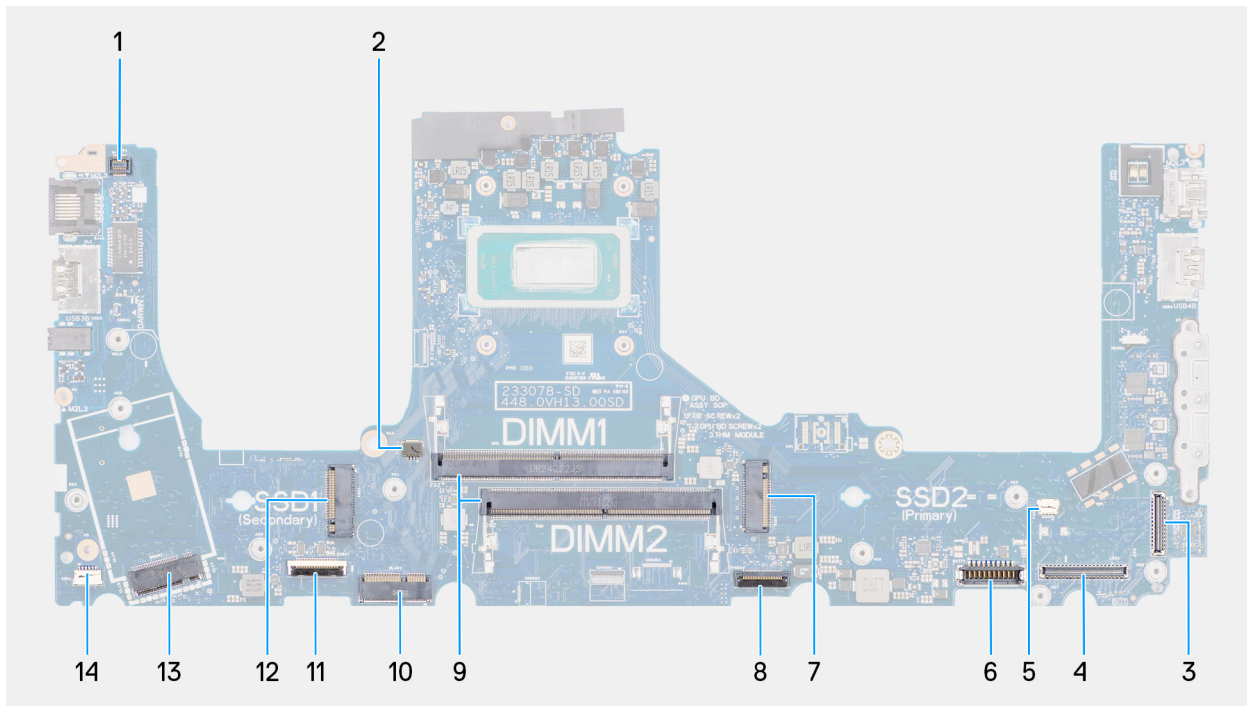

Figure 85. System board connectors

1. Fingerprint-reader cable connector (FP1)
2. Right/Processor-fan cable connector (FANL1)
3. IR-camera cable connector (CAM1)
4. Display-cable connector (LCD1)
5. Left/Video-fan cable connector (FANR2)
6. Battery-cable connector (BATT1)
7. Primary M.2 solid state drive connector (SSD2)
8. Touchpad-cable connector (TPAD1)
9. Memory-module connectors (DIMM1 and DIMM2)
10. Wireless-card connector (WLAN1)
11. USH-board cable connector (CN661)
12. Secondary M.2 solid state drive connector (SSD1)
13. WWAN-module connector (WWAN1)
14. Speaker-cable connector (SPK1)

The following images indicate the location of the system board and provide a visual representation of the installation procedure.

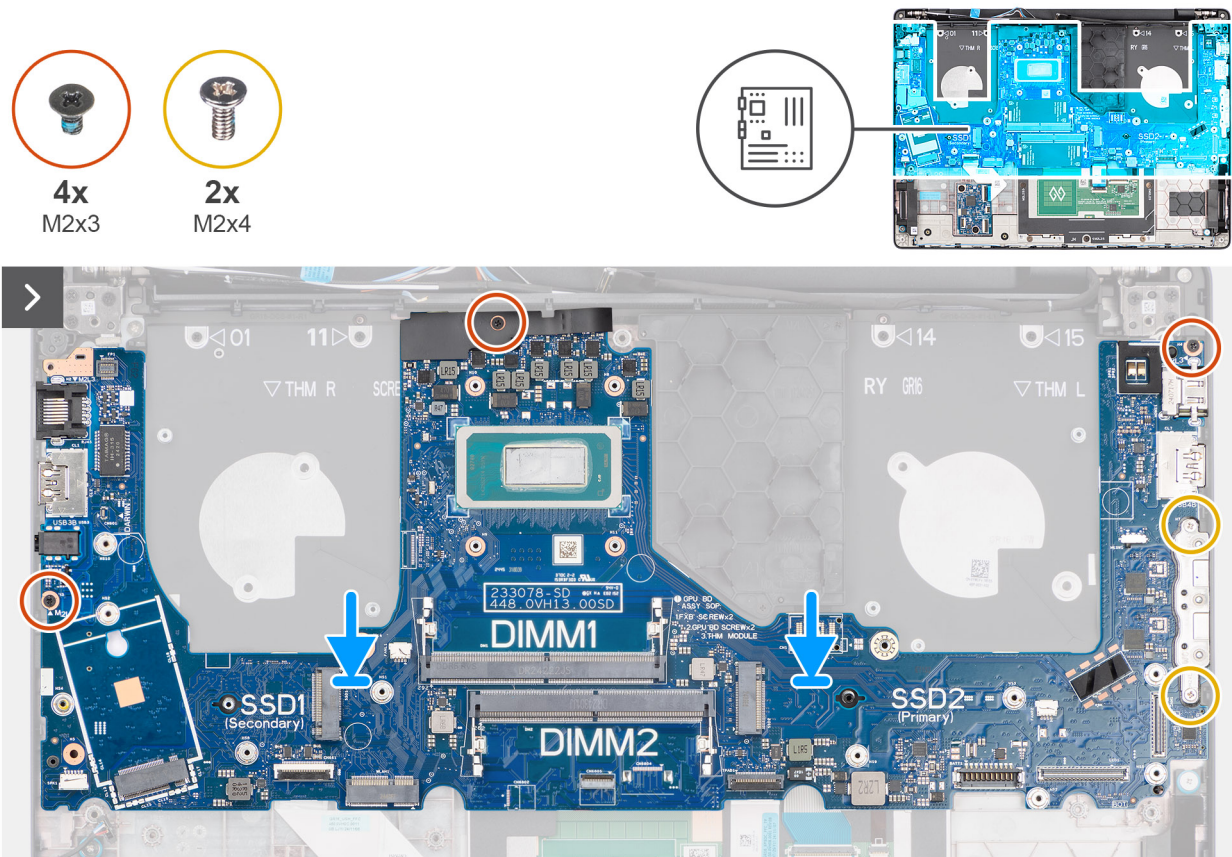

Figure 86. Installing the system board

Steps

1. Align the ports on the system board to the port slots and place the system board on the palm-rest assembly.
2. Align the screw holes on the system board with the screw holes on the palm-rest assembly.
3. For computers shipped with a fingerprint reader, replace the three screws (M2x3) and the two screws (M2x4) to secure the system board to the palm-rest assembly.
 For computers shipped without a fingerprint reader, replace the four screws (M2x3) and the two screws (M2x4) to secure the system board to the palm-rest assembly.
4. Connect the following cables to the system board:
 - a. Speaker cable (SPK1)
 - b. Touchpad cable (TPAD1)
 - c. USH-board cable (CN661)

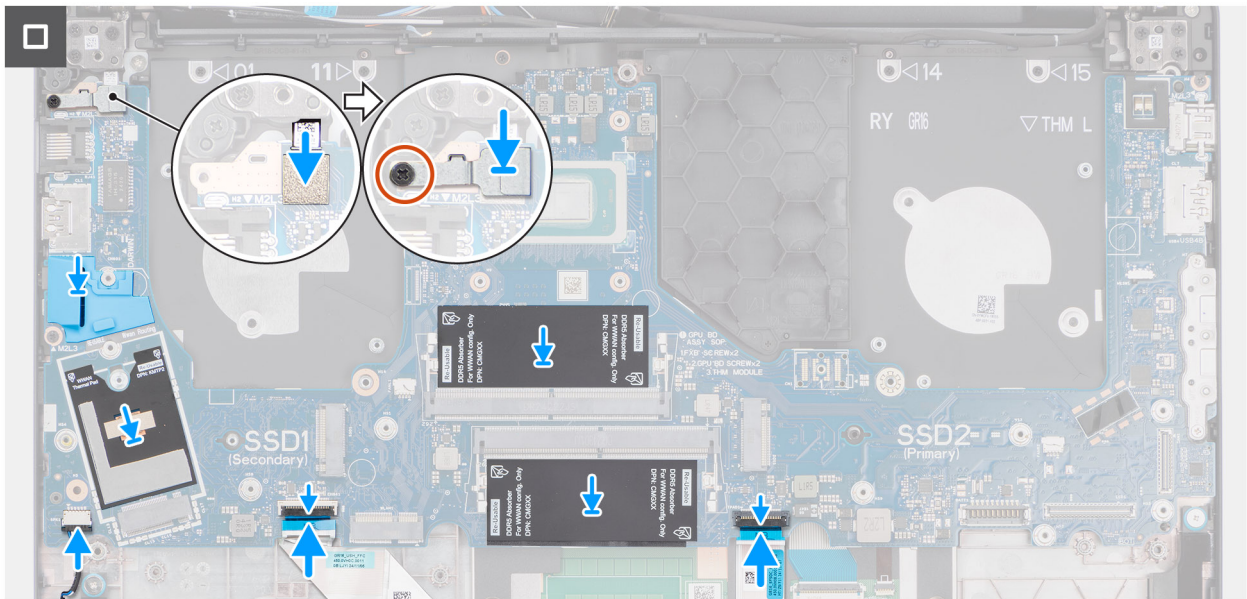

Figure 87. Installing the system board

5. Connect the fingerprint-reader cable to the connector (FP1) on the system board.

NOTE: Steps 6 to 8 apply only to computers shipped with a fingerprint reader installed.

6. Align and place the fingerprint-reader bracket over the fingerprint-reader connector on the system board.
7. Replace the screw (M2x3) to secure the fingerprint-reader bracket to the palm-rest assembly.
8. Ensure that the reusable Mylar sheet with thermal pads is placed on the system board.

NOTE: When replacing the system board, this Mylar sheet should be transferred to the new replacement system board.

Next steps

1. Install the [battery frame](#).
2. Install the [heat sink](#).
3. Install the [left/video fan](#).
4. Install the [right/processor fan](#).
5. Install the [WWAN module](#), if available.
6. Install the [wireless card](#).
7. Install the [M.2 2230 solid state drive](#) or [M.2 2280 solid state drive](#), whichever is applicable.
8. Install the [memory module](#).
9. Install the [battery](#).
10. Install the [base cover](#).
11. Follow the procedure in [After working inside your computer](#).

Removing the system board - for computers shipped with discrete graphics card

CAUTION: The information in this removal section is intended for authorized service technicians only.

Prerequisites

1. Follow the procedure in [Before working inside your computer](#).
2. Remove the [base cover](#).
3. Remove the [battery](#).
4. Remove the [memory module](#).

5. Remove the [M.2 2230 solid-state drive](#) or [M.2 2280 solid-state drive](#), whichever is applicable.
6. Remove the [wireless card](#).
7. Remove the [WWAN module](#), if available.
8. Remove the [right/processor fan](#).
9. Remove the [left/video fan](#).
10. Remove the [heat sink](#).

NOTE: If you are removing the system board to replace/access other parts, you may remove the system board with the heat sink attached to it in order to simplify the procedure and preserve the thermal bond between the system board and heat sink.

11. Remove the [battery frame](#).

About this task

The following image indicates the connectors on your system board.

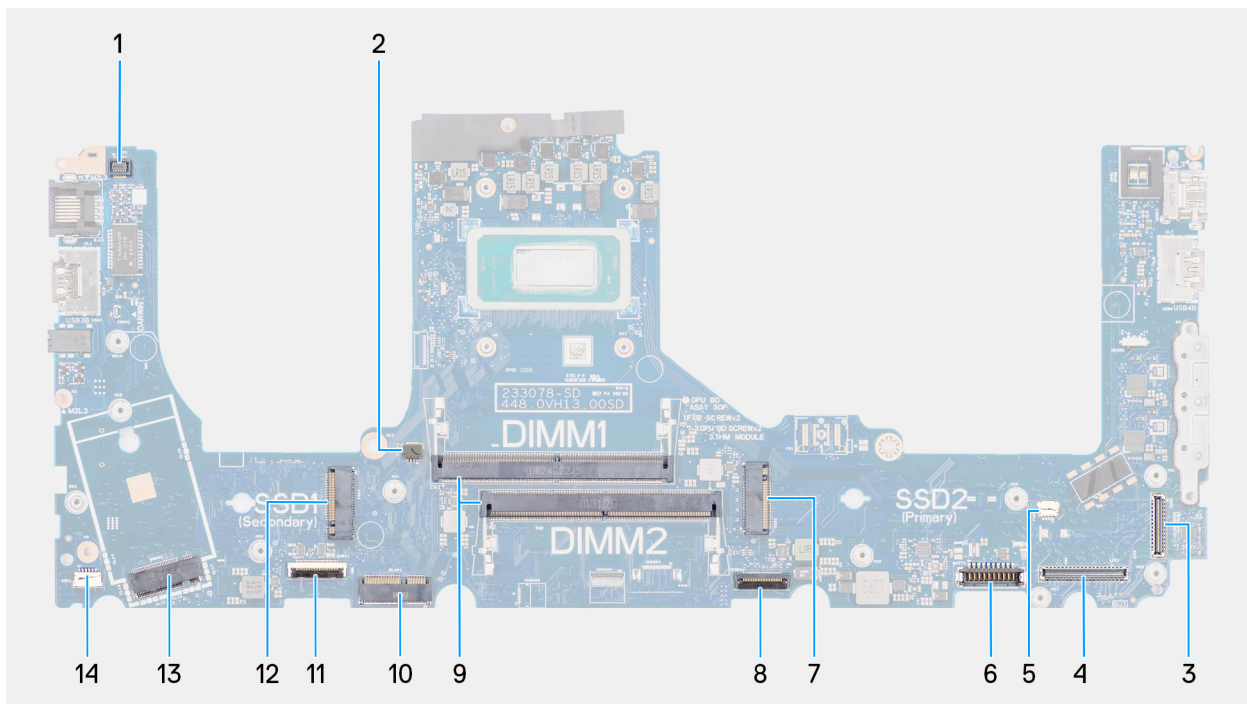

Figure 88. System board connectors

1. Fingerprint-reader cable connector (FP1)
2. Right/Processor-fan cable connector (FANL1)
3. IR-camera cable connector (CAM1)
4. Display-cable connector (LCD1)
5. Left/Video-fan cable connector (FANR2)
6. Battery-cable connector (BATT1)
7. Primary M.2 solid state drive connector (SSD2)
8. Touchpad-cable connector (TPAD1)
9. Memory-module connectors (DIMM1 and DIMM2)
10. Wireless-card connector (WLAN1)
11. USH-board cable connector (CN661)
12. Secondary M.2 solid state drive connector (SSD1)
13. WWAN-module connector (WWAN1)
14. Speaker-cable connector (SPK1)

The following images indicate the location of the system board and provide a visual representation of the removal procedure.

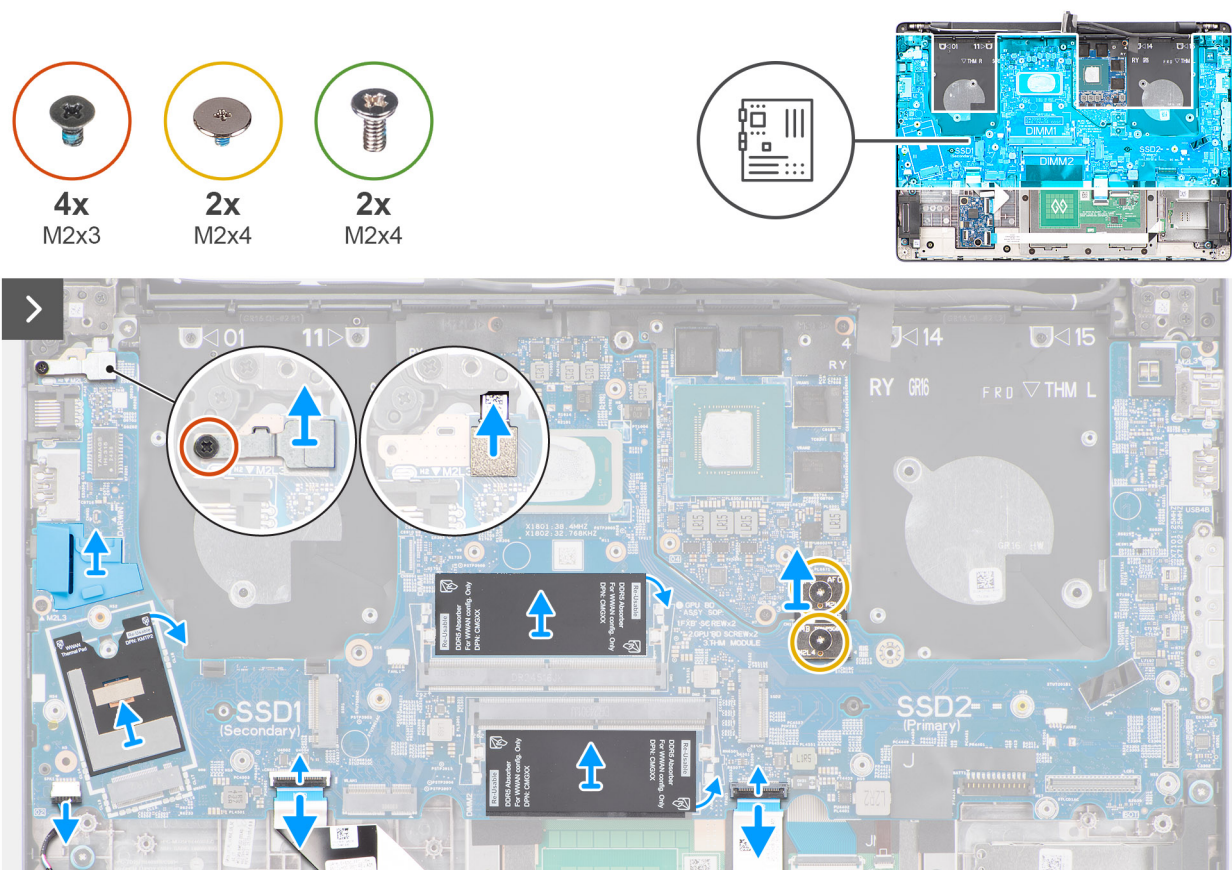

Figure 89. Removing the system board

Steps

1. Remove the reusable Mylar sheet with thermal pads from the system board and transfer it to the new replacement system board.
2. Remove the screw (M2x3) that secures the fingerprint-reader bracket to the palm-rest assembly.
 - i** **NOTE:** Steps 1 to 3 apply only to computers shipped with a fingerprint reader installed.
3. Lift the fingerprint-reader bracket off the system board.
4. Disconnect the fingerprint-reader cable from the connector (FP1) on the system board.
5. Disconnect the following cables from the system board:
 - a. Speaker cable (SPK1)
 - b. Touchpad cable (TPAD1)
 - c. USH-board cable (CN661)
6. For computers shipped without a fingerprint reader, remove the four screws (M2x3) and the two screws (M2x4) that secure the system board to the palm-rest assembly.
 For computers shipped with a fingerprint reader, remove the three screws (M2x3) and the two screws (M2x4) that secure the system board to the palm-rest assembly.

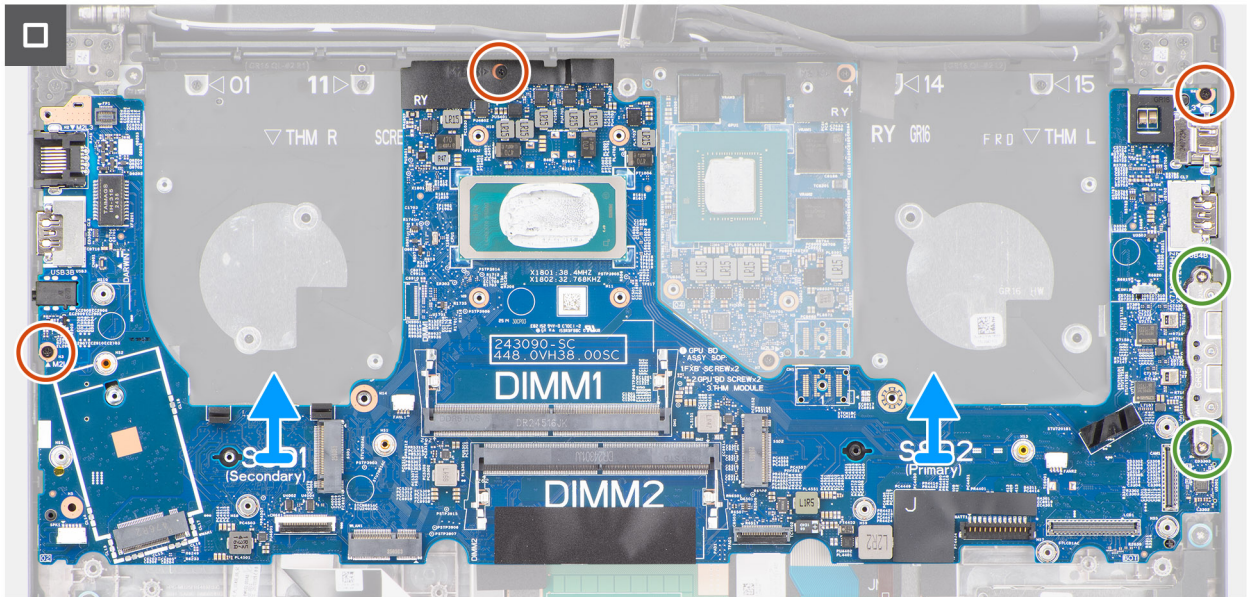

Figure 90. Removing the system board

7. Disconnect and remove the F-beam connector.
8. Carefully lift and remove the system board at angle, from the palm-rest assembly, to clear the ports from the port slots.

Installing the system board - for computers shipped with discrete graphics card

CAUTION: The information in this installation section is intended for authorized service technicians only.

Prerequisites

If you are replacing a component, remove the existing component before performing the installation procedure.

About this task

The following image indicates the connectors on your system board.

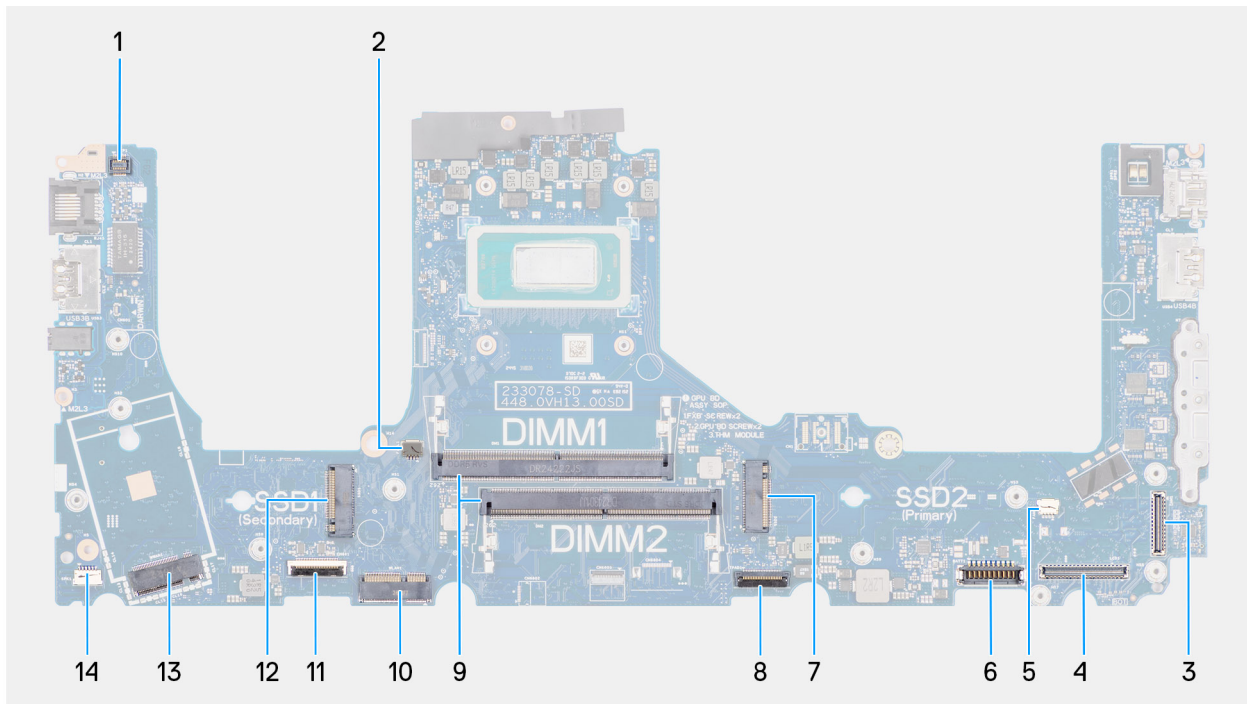

Figure 91. System board connectors

1. Fingerprint-reader cable connector (FP1)
2. Right/Processor-fan cable connector (FANL1)
3. IR-camera cable connector (CAM1)
4. Display-cable connector (LCD1)
5. Left/Video-fan cable connector (FANR2)
6. Battery-cable connector (BATT1)
7. Primary M.2 solid state drive connector (SSD2)
8. Touchpad-cable connector (TPAD1)
9. Memory-module connectors (DIMM1 and DIMM2)
10. Wireless-card connector (WLAN1)
11. USH-board cable connector (CN661)
12. Secondary M.2 solid state drive connector (SSD1)
13. WWAN-module connector (WWAN1)
14. Speaker-cable connector (SPK1)

The following images indicate the location of the system board and provide a visual representation of the installation procedure.

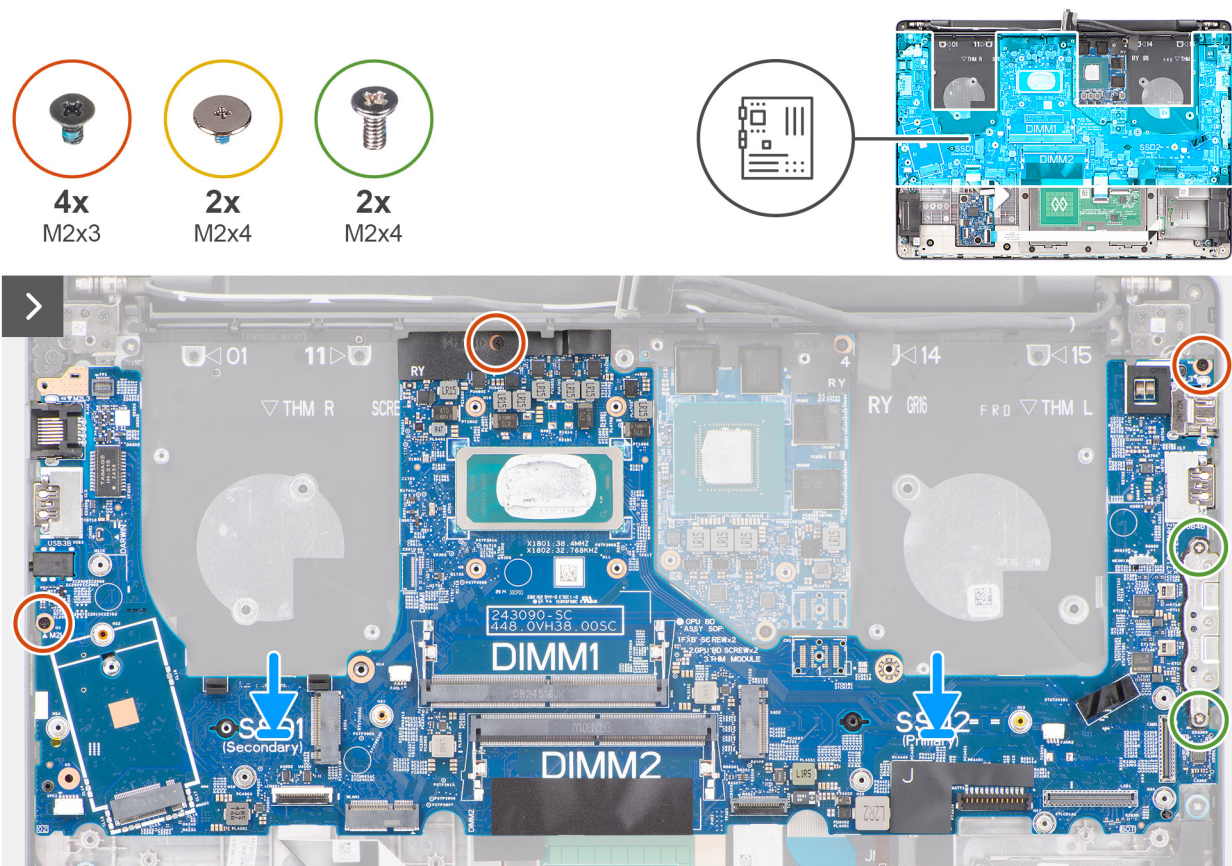

Figure 92. Installing the system board

Steps

1. Align the ports on the system board to the port slots and place the system board on the palm-rest assembly.
2. Align the screw holes on the system board with the screw holes on the palm-rest assembly.
3. Replace the F-beam connector.
4. For computers shipped with a fingerprint reader, replace the three screws (M2x3) and the two screws (M2x4) to secure the system board to the palm-rest assembly.
For computers shipped without a fingerprint reader, replace the four screws (M2x3) and the two screws (M2x4) to secure the system board to the palm-rest assembly.
5. Connect the following cables to the system board:
 - a. Speaker cable (SPK1)
 - b. Touchpad cable (TPAD1)
 - c. USH-board cable (CN661)

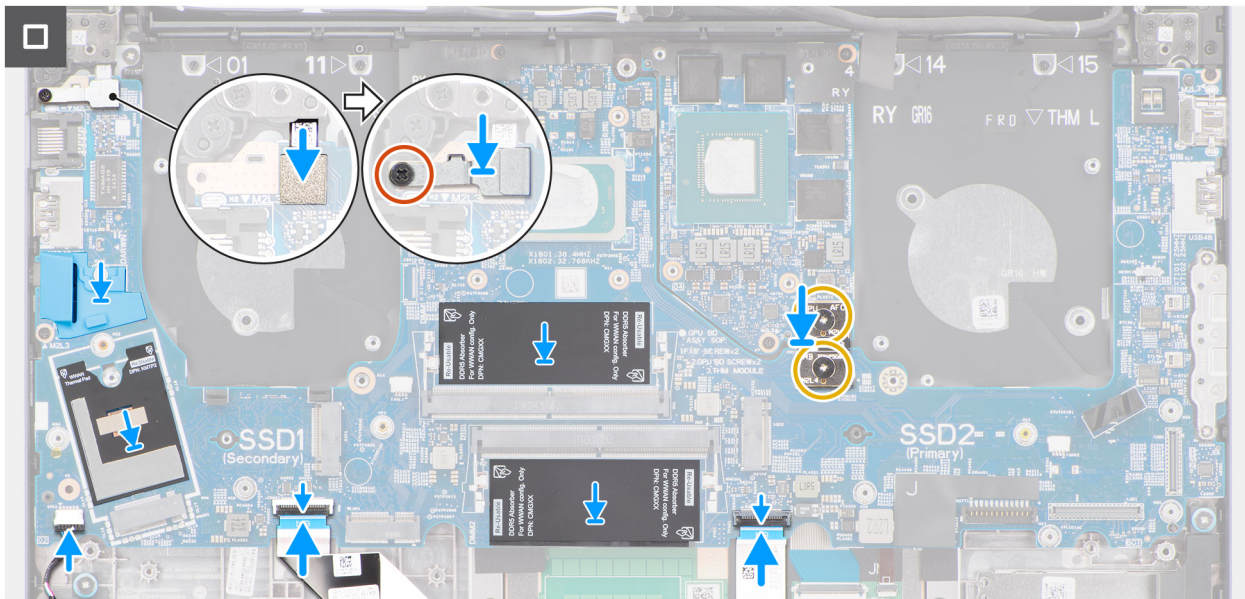

Figure 93. Installing the system board

6. Connect the fingerprint-reader cable to the connector (FP1) on the system board.

NOTE: Steps 6 to 8 apply only to computers shipped with a fingerprint reader installed.

7. Align and place the fingerprint-reader bracket over the fingerprint-reader connector on the system board.
8. Replace the screw (M2x3) to secure the fingerprint-reader bracket to the palm-rest assembly.
9. Ensure that the reusable Mylar sheet with thermal pads is placed on the system board.

NOTE: When replacing the system board, this Mylar sheet should be transferred to the new replacement system board.

Next steps

1. Install the [battery frame](#).
2. Install the [heat sink](#).
3. Install the [left/video fan](#).
4. Install the [right/processor fan](#).
5. Install the [WWAN module](#), if available.
6. Install the [wireless card](#).
7. Install the [M.2 2230 solid-state drive](#) or [M.2 2280 solid-state drive](#), whichever is applicable.
8. Install the [memory module](#).
9. Install the [battery](#).
10. Install the [base cover](#).
11. Follow the procedure in [After working inside your computer](#).

USB Type-C module

Removing the USB Type-C module

CAUTION: The information in this removal section is intended for authorized service technicians only.

Prerequisites

1. Follow the procedure in [Before working inside your computer](#).
2. Remove the [base cover](#).

3. Remove the [battery](#).
4. Remove the [memory module](#).
5. Remove the [M.2 2230 solid state drive](#) or [M.2 2280 solid state drive](#), whichever is applicable.
6. Remove the [wireless card](#).
7. Remove the [WWAN module](#), if available.
8. Remove the [right/processor fan](#).
9. Remove the [left/video fan](#).
10. Remove the [heat sink - integrated](#) or [heat sink - discrete](#), whichever is applicable.

NOTE: If you are removing the system board to replace/access other parts, you may remove the system board with the heat sink attached to it in order to simplify the procedure and preserve the thermal bond between the system board and heat sink.

11. Remove the [battery frame](#).
12. Remove the [system board](#).

NOTE: If you are removing the system board to replace/access other parts, you may remove the system board with the heat sink attached to it in order to simplify the procedure and preserve the thermal bond between the system board and heat sink.

About this task

The following image indicates the location of the USB Type-C module and provides a visual representation of the removal procedure.

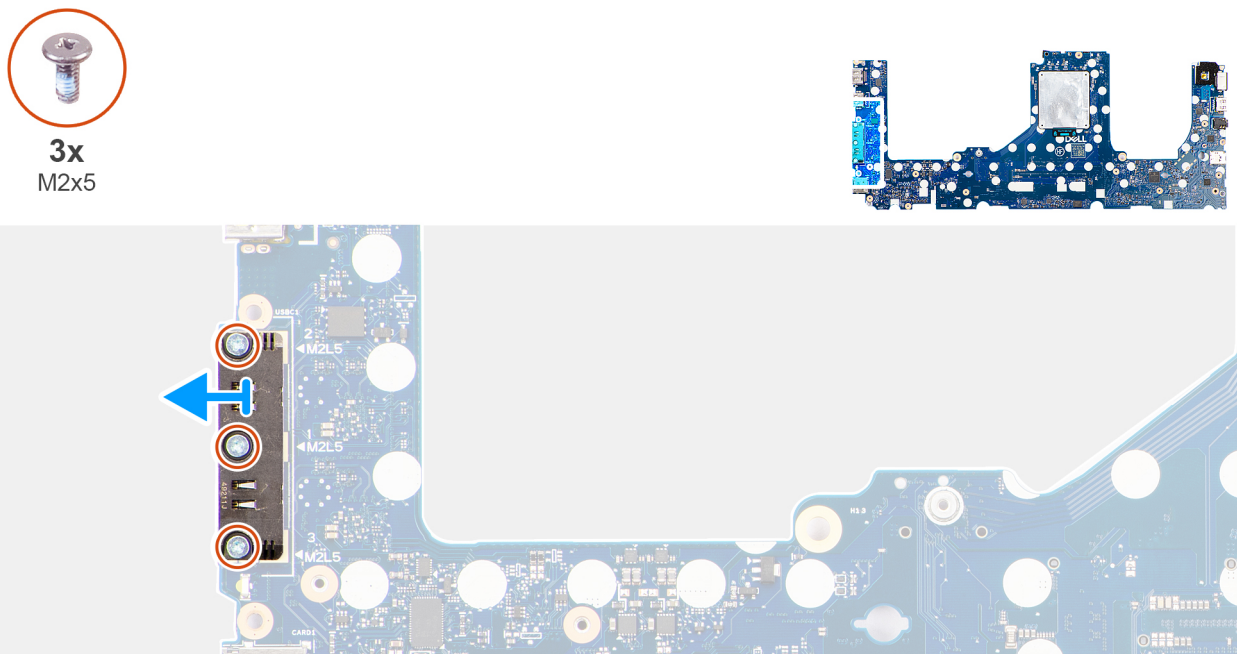

Figure 94. Removing the USB Type-C module

Steps

1. Remove the three screws (M2x5) that secure the USB Type-C module to the system board.
2. Lift the USB Type-C module off the system board.

Installing the USB Type-C module

CAUTION: The information in this installation section is intended for authorized service technicians only.

Prerequisites

If you are replacing a component, remove the existing component before performing the installation procedure.

About this task

The following image indicates the location of the USB Type-C module and provides a visual representation of the installation procedure.

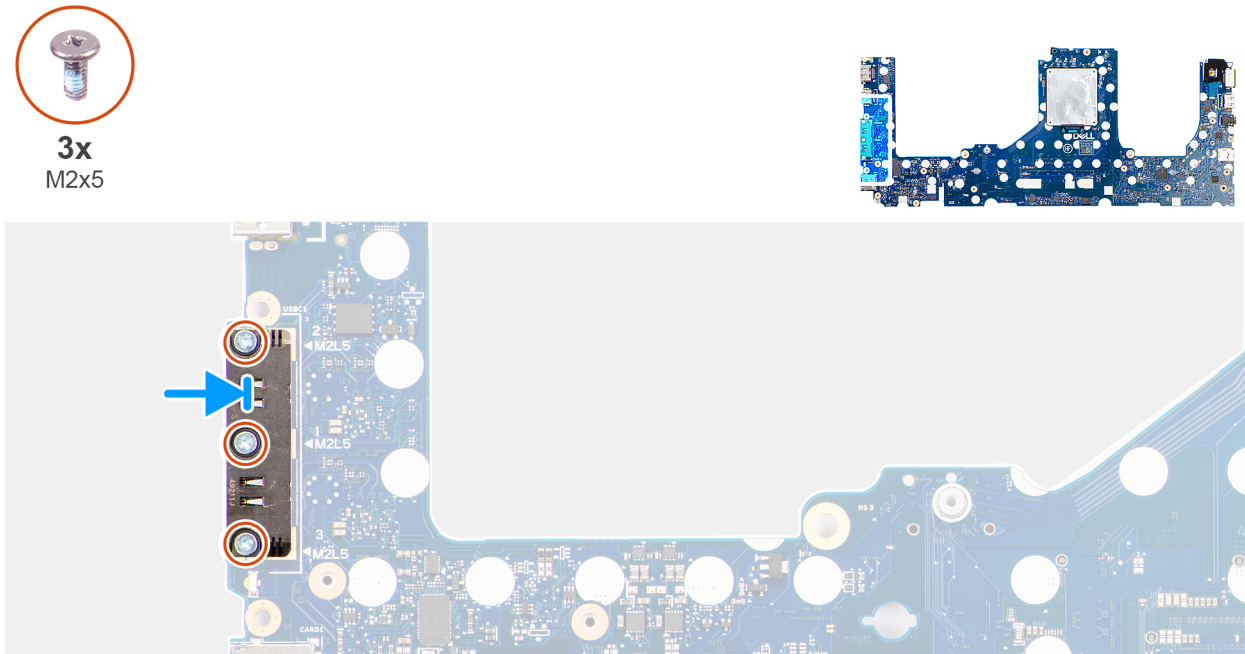

Figure 95. Installing the USB Type-C module

Steps

1. Align and place the USB Type-C module over the USB Type-C ports on the system board.
2. Replace the three screws (M2x5) to secure the USB Type-C module to the system board.

Next steps

1. Install the [system board](#).
2. Install the [battery frame](#).
3. Install the [heat sink - integrated](#) or [heat sink - discrete](#), whichever is applicable.
4. Install the [left/video fan](#).
5. Install the [right/processor fan](#).
6. Install the [WWAN module](#), if available.
7. Install the [wireless card](#).
8. Install the [M.2 2230 solid state drive](#) or [M.2 2280 solid state drive](#), whichever is applicable.
9. Install the [memory module](#).
10. Install the [battery](#).
11. Install the [base cover](#).
12. Follow the procedure in [After working inside your computer](#).

Power button

Removing the power button

 **CAUTION:** The information in this removal section is intended for authorized service technicians only.

Prerequisites

1. Follow the procedure in [Before working inside your computer](#).
2. Remove the [base cover](#).
3. Remove the [battery](#).
4. Remove the [memory module](#).
5. Remove the [M.2 2230 solid state drive](#) or [M.2 2280 solid state drive](#), whichever is applicable.
6. Remove the [wireless card](#).
7. Remove the [WWAN module](#), if available.
8. Remove the [right/processor fan](#).
9. Remove the [left/video fan](#).
10. Remove the [heat sink - integrated](#) or [heat sink - discrete](#), whichever is applicable.

 **NOTE:** If you are removing the system board to replace/access other parts, you may remove the system board with the heat sink attached to it in order to simplify the procedure and preserve the thermal bond between the system board and heat sink.

11. Remove the [battery frame](#).
12. Remove the [system board](#).

 **NOTE:** If you are removing the system board to replace/access other parts, you may remove the system board with the heat sink attached to it in order to simplify the procedure and preserve the thermal bond between the system board and heat sink.

About this task

The following image indicates the location of the power button and provides a visual representation of the removal procedure.



2x
M2x2

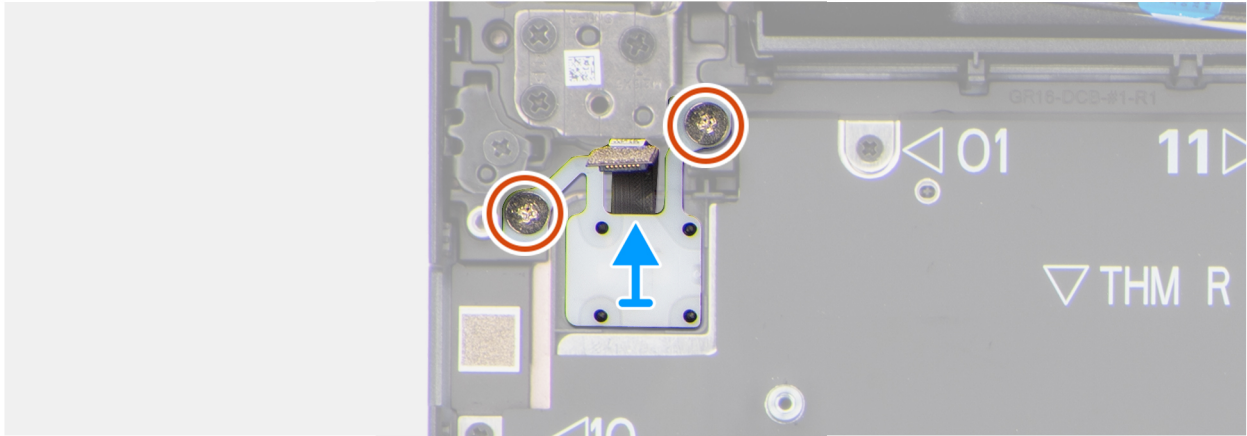
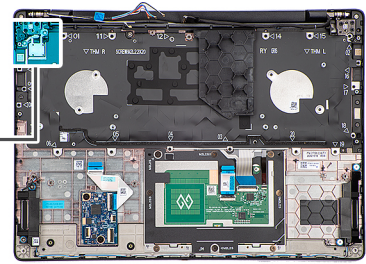

Figure 96. Removing the power button

Steps

1. Remove the two screws (M2x2) that secure the power button to the palm-rest assembly.
2. Lift the power button off the slot on the palm-rest assembly.

Installing the power button

CAUTION: The information in this installation section is intended for authorized service technicians only.

Prerequisites

If you are replacing a component, remove the existing component before performing the installation procedure.

About this task

The following image indicates the location of the power button and provides a visual representation of the installation procedure.

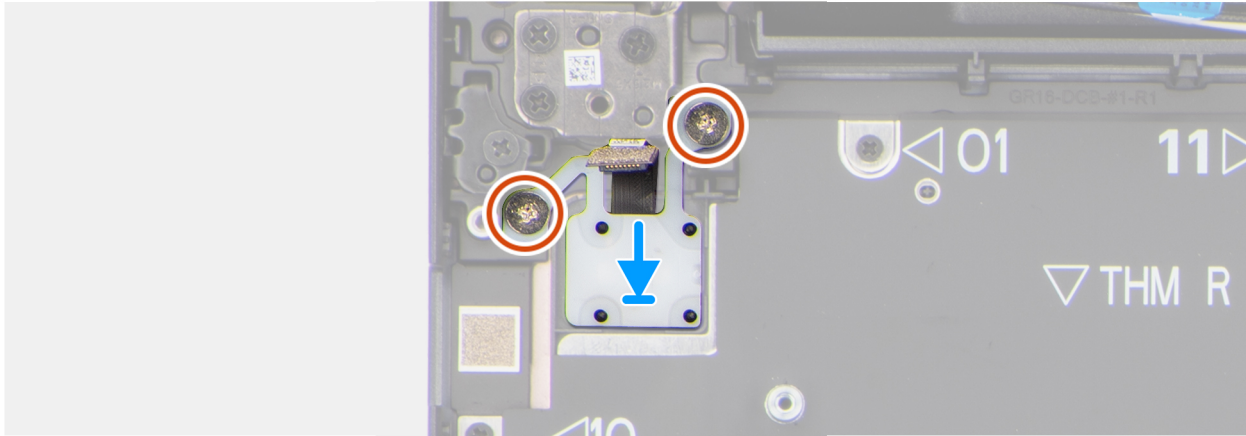
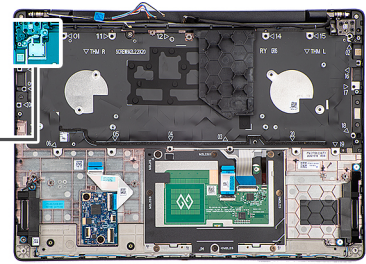

Figure 97. Installing the power button

Steps

1. Place the power button in the slot on the palm-rest assembly.
2. Align the screw holes on the power button with the screw holes on the palm-rest assembly.
3. Replace the two screws (M2x2) to secure the power button to the palm-rest assembly.

Next steps

1. Install the [system board](#).
2. Install the [battery frame](#).
3. Install the [heat sink - integrated](#) or [heat sink - discrete](#), whichever is applicable.
4. Install the [left/video fan](#).
5. Install the [right/processor fan](#).
6. Install the [WWAN module](#), if available.
7. Install the [wireless card](#).
8. Install the [M.2 2230 solid state drive](#) or [M.2 2280 solid state drive](#), whichever is applicable.
9. Install the [memory module](#).
10. Install the [battery](#).
11. Install the [base cover](#).
12. Follow the procedure in [After working inside your computer](#).

Keyboard

Removing the keyboard

CAUTION: The information in this removal section is intended for authorized service technicians only.

Prerequisites

1. Follow the procedure in [Before working inside your computer](#).
2. Remove the [base cover](#).

3. Remove the [battery](#).
4. Remove the [memory module](#).
5. Remove the [M.2 2230 solid state drive](#) or [M.2 2280 solid state drive](#), whichever is applicable.
6. Remove the [wireless card](#).
7. Remove the [WWAN module](#), if available.
8. Remove the [speakers](#).
9. Remove the [right/processor fan](#).
10. Remove the [left/video fan](#).
11. Remove the [heat sink - integrated](#) or [heat sink - discrete](#), whichever is applicable.

i **NOTE:** If you are removing the system board to replace/access other parts, you may remove the system board with the heat sink attached to it in order to simplify the procedure and preserve the thermal bond between the system board and heat sink.

12. Remove the [GPU filler](#).
13. Remove the [system board](#).

i **NOTE:** If you are removing the system board to replace/access other parts, you may remove the system board with the heat sink attached to it in order to simplify the procedure and preserve the thermal bond between the system board and heat sink.

About this task

The following images indicate the location of the keyboard and provide a visual representation of the removal procedure.



29x
M2x2.2

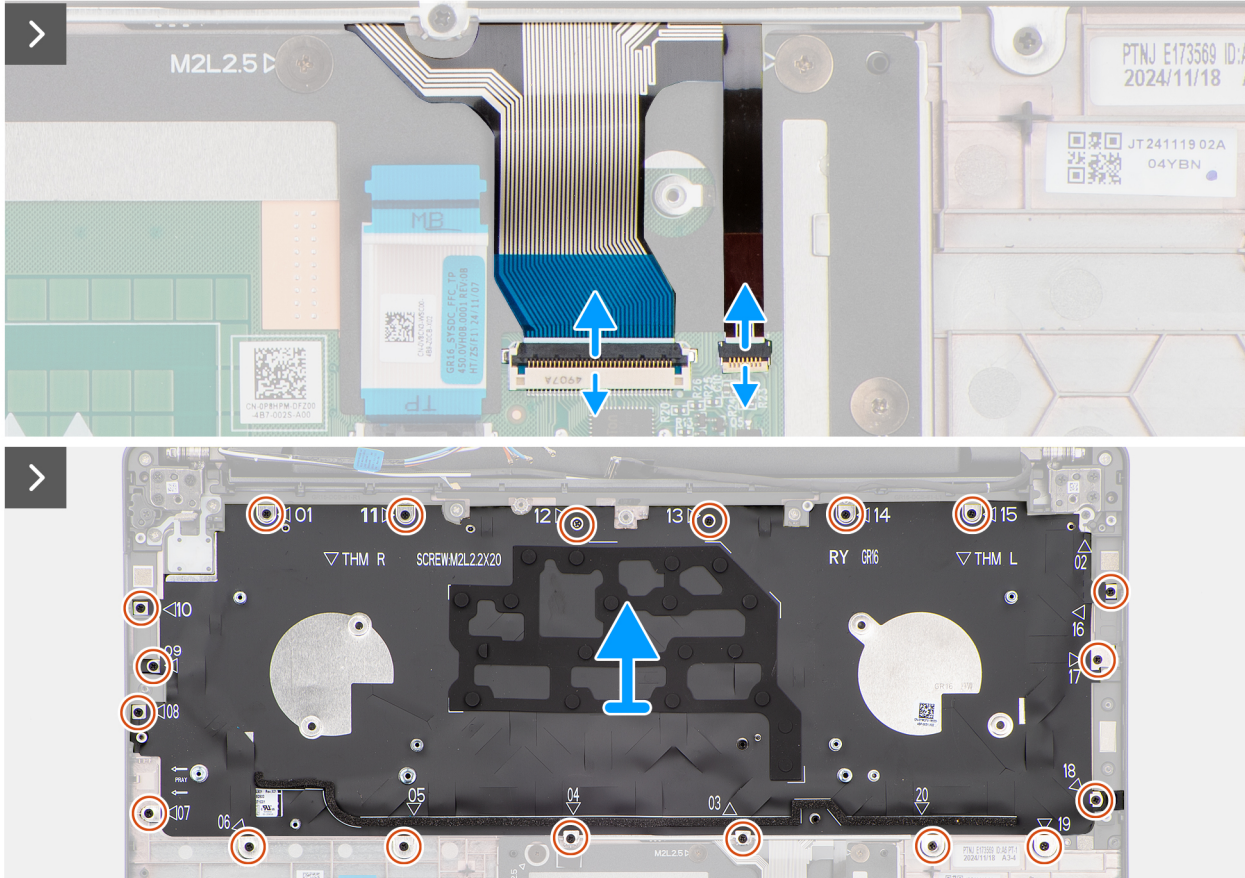
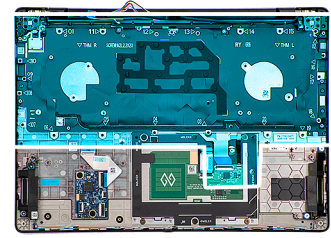

Figure 98. Removing the keyboard



Figure 99. Removing the keyboard

Steps

1. Disconnect the keyboard cable from the connector (KEYBOARD) on the touchpad board.

2. Disconnect the keyboard-backlight cable from the connector (LIGHTING) on the touchpad board.

NOTE: This step applies only to computers shipped with a backlit keyboard installed.

3. Remove the 20 screws (M2x2.2) that secure the keyboard assembly to the palm-rest assembly.

4. Lift the keyboard assembly off the palm-rest assembly.

5. Remove the nine screws (M2x2.2) that secure the keyboard to the keyboard bracket.

6. Lift the keyboard off the keyboard bracket.

Installing the keyboard

CAUTION: The information in this installation section is intended for authorized service technicians only.

Prerequisites

If you are replacing a component, remove the existing component before performing the installation procedure.

About this task

The following images indicate the location of the keyboard and provide a visual representation of the installation procedure.



29x
M2x2.2

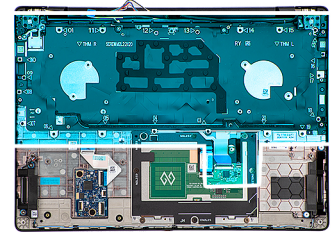

Figure 100. Installing the keyboard

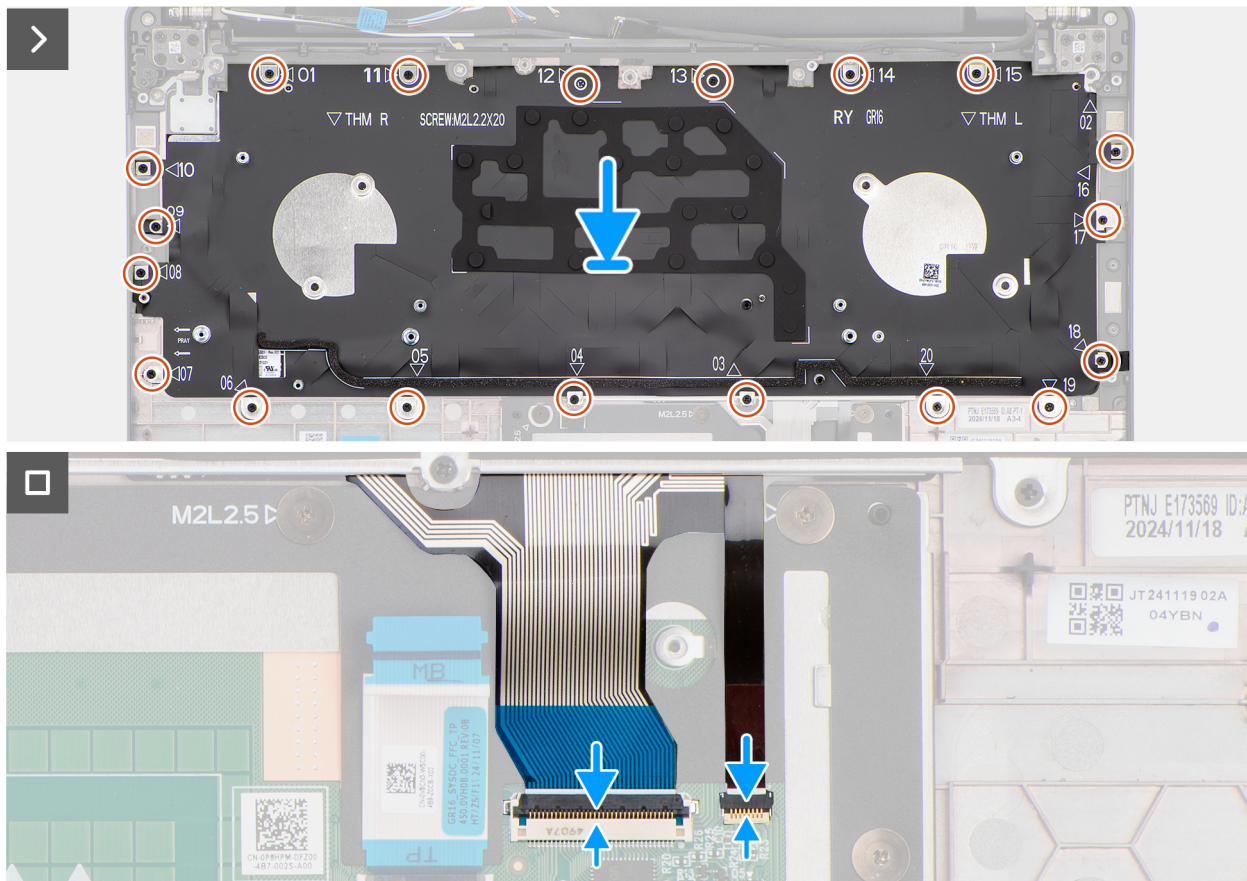

Figure 101. Installing the keyboard

Steps

1. Align and place the keyboard over the keyboard bracket.
2. Replace the nine screws (M2x2.2) to secure the keyboard to the keyboard bracket.
3. Align and place the keyboard assembly in the slot on the palm-rest assembly.
4. Replace the 20 screws (M2x2.2) to secure the keyboard assembly to the palm-rest assembly.
5. Connect the keyboard cable to the connector (KEYBOARD) on the touchpad board.
6. Connect the keyboard-backlight cable to the connector (LIGHTING) on the touchpad board.

NOTE: This step applies only to computers shipped with a backlit keyboard installed.

Next steps

1. Install the [system board](#).
2. Install the [GPU filler](#).
3. Install the [heat sink - integrated](#) or [heat sink - discrete](#), whichever is applicable.
4. Install the [left/video fan](#).
5. Install the [right/processor fan](#).
6. Install the [speakers](#).
7. Install the [WWAN module](#), if available.
8. Install the [wireless card](#).
9. Install the [M.2 2230 solid state drive](#) or [M.2 2280 solid state drive](#), whichever is applicable.
10. Install the [memory module](#).
11. Install the [battery](#).
12. Install the [base cover](#).
13. Follow the procedure in [After working inside your computer](#).

Palm-rest assembly

Removing the palm-rest assembly

 **CAUTION:** The information in this removal section is intended for authorized service technicians only.

Prerequisites

1. Follow the procedure in [Before working inside your computer](#).
2. Remove the [base cover](#).
3. Remove the [battery](#).
4. Remove the [memory module](#).
5. Remove the [M.2 2230 solid state drive](#) or [M.2 2280 solid state drive](#), whichever is applicable.
6. Remove the [wireless card](#).
7. Remove the [WWAN module](#), if available.
8. Remove the [speakers](#).
9. Remove the [right/processor fan](#).
10. Remove the [left/video fan](#).
11. Remove the [heat sink - integrated](#) or [heat sink - discrete](#), whichever is applicable.

 **NOTE:** If you are removing the system board to replace/access other parts, you may remove the system board with the heat sink attached to it in order to simplify the procedure and preserve the thermal bond between the system board and heat sink.

12. Remove the [GPU filler](#).
13. Remove the [battery frame](#).
14. Remove the [USH board](#).
15. Remove the [smart-card reader](#), if available.
16. Remove the [display assembly](#).
17. Remove the [system board](#).

 **NOTE:** If you are removing the system board to replace/access other parts, you may remove the system board with the heat sink attached to it in order to simplify the procedure and preserve the thermal bond between the system board and heat sink.

18. Remove the [power button](#).
19. Remove the [keyboard](#).

About this task

 **NOTE:** The palm-rest assembly cannot be further disassembled once all the **Prerequisites** are completed. If the touchpad is malfunctioning and is required to be replaced, replace the entire palm-rest assembly.

The image below shows the palm-rest assembly after the **Prerequisites** have been performed.

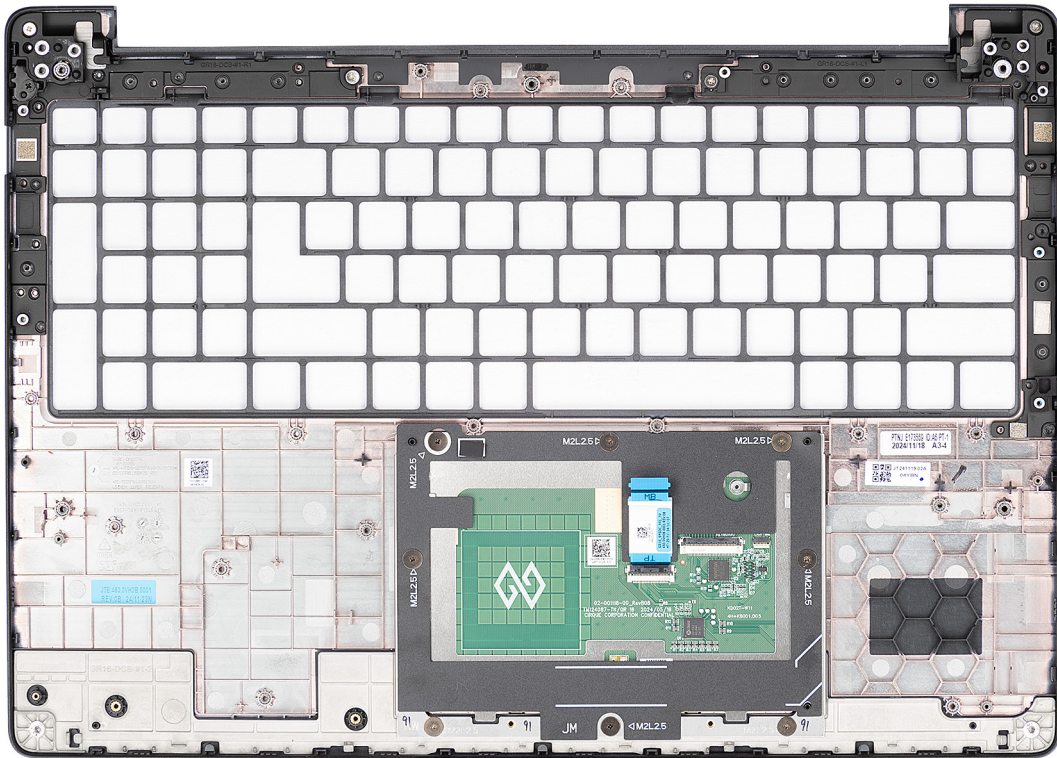

Figure 102. Palm-rest assembly

Steps

After performing the **Prerequisites**, you are left with the palm-rest assembly.

Installing the palm-rest assembly

CAUTION: The information in this installation section is intended for authorized service technicians only.

Prerequisites

If you are replacing a component, remove the existing component before performing the installation procedure.

About this task

NOTE: The system board can be installed with the heat sink attached to it in order to simplify the procedure and preserve the thermal bond between the system board and heat sink.

The image below shows the palm-rest assembly.

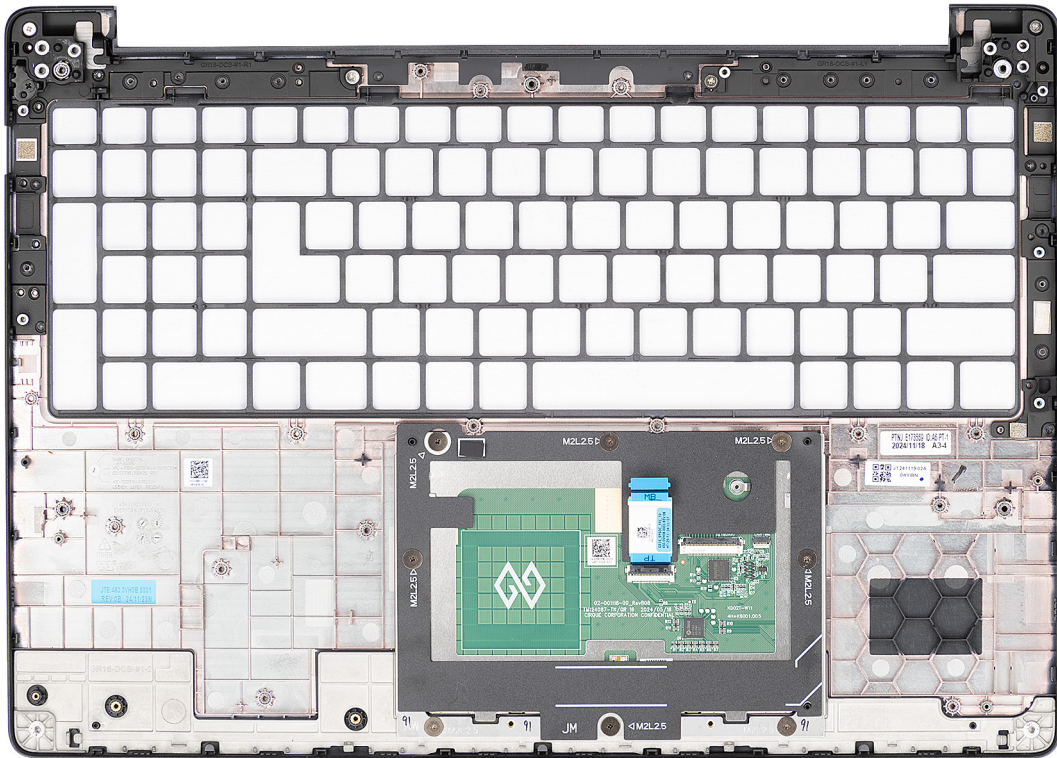

Figure 103. Palm-rest assembly

Steps

Place the palm-rest assembly on a flat surface and perform the **Next steps** to install the palm-rest assembly.

Next steps

1. Install the [keyboard](#).
2. Install the [power button](#).
3. Install the [system board](#).
4. Install the [display assembly](#).
5. Install the [smart-card reader](#), if available.
6. Install the [USH board](#).
7. Install the [battery frame](#).
8. Install the [GPU filler](#).
9. Install the [heat sink - integrated](#) or [heat sink - discrete](#), whichever is applicable.
10. Install the [left/video fan](#).
11. Install the [right/processor fan](#).
12. Install the [speakers](#).
13. Install the [WWAN module](#), if available.
14. Install the [wireless card](#).
15. Install the [M.2 2230 solid state drive](#) or [M.2 2280 solid state drive](#), whichever is applicable.
16. Install the [memory module](#).
17. Install the [battery](#).
18. Install the [base cover](#).
19. Follow the procedure in [After working inside your computer](#).

Software

This chapter details the supported operating systems along with instructions on how to install the drivers.

Operating system

Your Dell Pro Max 16 MC16250 supports the following operating systems:

- Windows 11 Home
- Windows 11 Pro
- Ubuntu Linux 22.04 LTS, 64-bit

Drivers and downloads

When troubleshooting, downloading, or installing drivers, it is recommended that you read the [Dell Knowledge Base article Drivers and Downloads FAQs](#).

BIOS Setup

CAUTION: Certain changes can make your computer work incorrectly. Before you change the settings in BIOS Setup, it is recommended that you note down the original settings for future reference.

NOTE: Depending on the computer and the installed devices, the options that are listed in this section may differ.

Use BIOS Setup for the following purposes:

- Get information about the hardware installed in your computer, such as the amount of RAM and the capacity of the storage device.
- Change the system configuration information.
- Set or change user-selectable options such as the user password, enabling or disabling base devices, and configuring hard drive settings.

Entering BIOS Setup program

Turn on or restart your computer and press F2 immediately.

Navigation keys

NOTE: For most of the BIOS Setup options, changes that you make are recorded but do not take effect until you restart the computer.

Table 38. Navigation keys

Keys	Navigation
Up arrow	Moves to the previous field.
Down arrow	Moves to the next field.
Enter	Selects a value in the selected field (if applicable) or follows the link in the field.
Spacebar	Expands or collapses a drop-down list, if applicable.
Tab	Moves to the next focus area.
Esc	Moves to the previous page until you view the main screen. Pressing Esc in the main screen displays a message that prompts you to save any unsaved changes and restart the computer.

F12 One Time Boot menu

To enter the One Time Boot menu, turn on or restart your computer, and then press F12 immediately.

NOTE: If you are unable to enter the One Time Boot menu, repeat the above action.

The One Time Boot menu displays the devices that you can boot from and also display the options to start diagnostics. The boot menu options are:

- Windows Boot Manager
- UEFI M.2 solid state drive Boot
- UEFI HTTPs Boot

- Diagnostics

The One Time Boot menu screen also displays the option to access BIOS Setup.

View Advanced Setup options

About this task

Some BIOS Setup options are only visible by enabling **Advanced Setup** mode, which is disabled by default.

 **NOTE:** BIOS Setup options, including **Advanced Setup** options, are described in the **System setup options** option.

To enable Advanced Setup:

Steps

1. Enter BIOS Setup.
The Overview menu appears.
2. Click the **Advanced Setup** option to move it to the **ON** mode.
Advanced BIOS Setup options are displayed.

View Service options

About this task

Service options are hidden by default and only visible by entering a hotkey command.

 **NOTE:** Service options are described in [BIOS Setup options](#).

To view Service options:

Steps

1. Enter BIOS Setup.
The Overview menu appears.
2. Enter the hotkey combination **Ctrl + Alt + s** to view the **Service** options.
Service options are displayed.

System Setup options

 **NOTE:** For most of the System Setup options, changes that you make are recorded but do not take effect until you restart the computer.

 **NOTE:** Depending on your computer and its installed devices, the items that are listed in this section may differ.

Table 39. System Setup options—Overview menu

Overview	
Dell Pro Max 16 MC16250	
BIOS Version	Displays the BIOS version number.
Service Tag	Displays the Service Tag of the computer.
Asset Tag	Displays the Asset Tag of the computer.
Manufacture Date	Displays the manufacture date of the computer.
Ownership Date	Displays the ownership date of the computer.
Express Service Code	Displays the Express Service Code of the computer.

Table 39. System Setup options—Overview menu (continued)



Overview	
Ownership Tag	Displays the Ownership Tag of the computer.
BATTERY Information	
Primary	Displays the primary battery of the computer.
Battery Level	Displays the battery level of the computer.
Battery State	Displays the battery state of the computer.
Health	Displays the battery health of the computer.
AC Adapter	Displays whether an AC adapter is connected. If connected, displays the type of AC adapter that is connected.
Battery Life Type	Display the battery life type of the computer.
PROCESSOR Information	
Processor Type	Displays the processor type.
Maximum Clock Speed	Displays the maximum processor clock speed.  NOTE: To view this option, enable Advanced Setup mode as described in View Advanced Setup options .
Core Count	Displays the total core count of the processor.
Processor ID	Displays the processor ID.
Processor L2 Cache	Displays the processor.
Processor L3 Cache	Displays the processor.
Microcode Version	Displays the microcode version of the processor.
Intel Hyper-Threading Capable	Displays whether the processor is Hyper-Threading (HT) capable or not.
Intel vPro Technology	Displays whether the processor is
MEMORY Information	
Memory Installed	Displays the total memory installed on the computer.
Memory Available	Displays the total memory available on the computer.
Memory Speed	Displays the memory speed.  NOTE: To view this option, enable Advanced Setup mode as described in View Advanced Setup options .
Memory Technology	Displays the technology that is used for the memory.
DIMM_SLOT A	Displays the memory speed and memory slot type.
DIMM_SLOT B	Displays the memory speed and memory slot type.
DEVICES Information	
Panel Type	Displays the type of display panel available on the computer.
Panel Revision	Displays the panel revision version of the computer.
Video Controller	Displays the type of video controller available on the computer.
Video Memory	Displays the video memory information of the computer.
Wi-Fi Device	Displays the wireless device information of the computer.
Native Resolution	Displays the native resolution of the computer.
Video BIOS Version	Displays the video BIOS version of the computer.
Audio Controller	Displays the audio controller information of the computer.

Table 39. System Setup options—Overview menu (continued)

Overview	
Bluetooth Device	Displays the Bluetooth device information of the computer.
LOM MAC Address	Displays the LOM MAC Address of the computer.
Pass Through MAC Address	Displays the MAC address of the video pass-through.
Cellular Device	Displays the cellular device of the computer.
dGPU Video Controller	Displays the type of discrete video controller available on the computer.

Table 40. System Setup options—Boot Configuration menu





Boot Configuration	
Boot Sequence	
Boot Sequence	Displays the boot sequence.
Enable PXE Boot Priority	<p>When enabled, any new PXE boot option that is detected by the computer is added to the top of the Boot Sequence.</p> <p>By default, the Enable PXE Boot Priority option is disabled.</p>
Secure Digital (SD) Card Boot	<p>Enables or disables read-only boot from Secure Digital (SD) card.</p> <p>By default, the Secure Digital (SD) Card Boot option is disabled.</p> <p> NOTE: To view this option, enable Advanced Setup mode as described in View Advanced Setup options.</p>
Secure Boot	
	<p>Secure Boot is a method of guaranteeing the integrity of the boot path by performing additional validation of the operating system and PCI add-in cards. The computer stops booting to the operating system when a component is not authenticated during the boot process. Secure Boot can be enabled in BIOS setup or using management interfaces like Dell Command Configure, but can only be disabled from BIOS setup.</p>
Enable Secure Boot	<p>Enables the computer to boot using only validated boot software.</p> <p>By default, this Enable Secure Boot option is disabled. For additional security, Dell Technologies recommends keeping the Secure Boot option enabled to ensure that the UEFI firmware validates the operating system during the boot process.</p> <p> NOTE: To view this option, enable Advanced Setup mode as described in View Advanced Setup options.</p> <p> NOTE: To enable Secure Boot, the computer must be in UEFI boot mode and the Enable Legacy Option ROMs option must be turned off.</p>
Enable Microsoft UEFI CA	<p>When disabled, the UEFI CA is removed from the BIOS UEFI Secure Boot database.</p> <p> CAUTION: If you disable Microsoft UEFI CA, the computer may not boot, computer graphics may not function, some devices may not function properly, and the computer could become unrecoverable.</p> <p>By default, the Enable Microsoft UEFI CA option is enabled.</p> <p>For additional security, Dell Technologies recommends keeping the Enable Microsoft UEFI CA option enabled to ensure the broadest compatibility with devices and operating systems.</p>
Secure Boot Mode	<p>Enables or disables the Secure Boot operation mode.</p> <p>By default, the Deployed Mode is selected. Deployed Mode should be selected for normal operation of Secure Boot.</p>

Table 40. System Setup options—Boot Configuration menu (continued)



Boot Configuration	
	<p> NOTE: To view this option, enable Advanced Setup mode as described in View Advanced Setup options.</p>
Expert Key Management	
Enable Custom Mode	<p>Enables or disables the keys in the PK, KEK, db, and dbx security key databases to be modified.</p> <p>By default, the Enable Custom Mode option is disabled.</p> <p> NOTE: To view this option, enable Advanced Setup mode as described in View Advanced Setup options.</p>
Custom Mode Key Management	<p>Selects the custom values for expert key management.</p> <p>By default, the PK option is selected.</p> <p> NOTE: To view this option, enable Advanced Setup mode as described in View Advanced Setup options.</p>

Table 41. System Setup options—Integrated Devices menu



Integrated Devices	
Date/Time	
Date	Sets the computer date in MM/DD/YYYY format. Changes to the date format take effect immediately.
Time	Sets the computer time in HH/MM/SS 24-hour format. You can select between a 12-hour or 24-hour clock. Changes to the time format take effect immediately.
Camera	
Enable Camera	<p>Enables the camera.</p> <p>By default, the Enable Camera option is enabled.</p> <p> NOTE: Depending on the configuration ordered, the camera setup option may not be available.</p>
Audio	
Enable Audio	<p>Enables all integrated audio controller.</p> <p>By default, all the options are enabled.</p>
Enable Microphone	<p>Enables the microphone.</p> <p>By default, the Enable Microphone option is enabled.</p> <p> NOTE: Depending on the configuration ordered, the microphone setup option may not be available.</p>
Enable Internal Speaker	<p>Enables the internal speaker.</p> <p>By default, the Enable Internal Speaker option is enabled.</p>
USB/Thunderbolt Configuration	
Enable External USB Ports	<p>Enables the external USB ports.</p> <p>By default, the Enable External USB Ports option is enabled.</p> <p> NOTE: To view this option, enable Advanced Setup mode as described in View Advanced Setup options.</p>
Enable USB Boot Support	Enables booting from USB mass storage devices that are connected to external USB ports.

Table 41. System Setup options—Integrated Devices menu (continued)

Integrated Devices	
	<p>By default, the Enable USB Boot Support option is enabled.</p> <p>i NOTE: To view this option, enable Advanced Setup mode as described in View Advanced Setup options.</p>
Enable Thunderbolt Technology Support	<p>Enables the associated ports and adapters for Thunderbolt Technology support.</p> <p>By default, the Enable Thunderbolt Technology Support option is enabled.</p> <p>i NOTE: To view this option, enable Advanced Setup mode as described in View Advanced Setup options.</p>
Enable Thunderbolt Boot Support	<p>Enables the Thunderbolt adapter-peripheral device and USB devices that are connected to the Thunderbolt adapter to be used during BIOS Preboot.</p> <p>By default, the Enable Thunderbolt Boot Support option is disabled.</p> <p>i NOTE: To view this option, enable Advanced Setup mode as described in View Advanced Setup options.</p>
Disable USB4 PCIE Tunneling	<p>Disables the USB4 PCIE Tunneling option.</p> <p>By default, the Disable USB4 PCIE Tunneling option is disabled.</p> <p>i NOTE: To view this option, enable Advanced Setup mode as described in Entering BIOS Setup program.</p>
Video/Power only on Type-C Ports	<p>Enables or disables the Type-C port functionality to video or only power.</p> <p>By default, the Video/Power only on Type-C Ports option is disabled.</p> <p>i NOTE: To view this option, enable Advanced Setup mode as described in View Advanced Setup options.</p>
Type-C Dock	
Type-C Dock Override	<p>Enables or disables to use connected Type-C Dell Dock to provide data stream with external USB ports disabled. When Type-C Dock override is enabled, the Video/Audio/LAN submenu is activated.</p> <p>By default, the Type-C Dock Override option is enabled.</p> <p>i NOTE: To view this option, enable Advanced Setup mode as described in Entering BIOS Setup program.</p>
Type-C Dock Audio	<p>Enables or disables the usage of audio inputs and outputs from the connected Type-C Dell docking station.</p> <p>By default, the Type-C Dock Audio option is enabled.</p> <p>i NOTE: To view this option, enable Advanced Setup mode as described in View Advanced Setup options.</p>
Type-C Dock LAN	<p>Enables or disables the usage of LAN on the external ports of the connected Type-C Dell docking station.</p> <p>By default, the Type-C Dock LAN option is enabled.</p> <p>i NOTE: To view this option, enable Advanced Setup mode as described in View Advanced Setup options.</p>
Miscellaneous Devices	
Enable Fingerprint Reader Device	<p>Enables or disables the Fingerprint Reader Device option.</p> <p>By default, the Enable Fingerprint Reader Device option is enabled.</p>

Table 41. System Setup options—Integrated Devices menu (continued)

Integrated Devices	
	<p>i NOTE: To view this option, enable Advanced Setup mode as described in View Advanced Setup options.</p>
Unobtrusive Mode	
Enable Unobtrusive Mode	<p>Enables or disables the unobtrusive mode. When enabled, all system LEDs, LCD panel backlight and audio devices of the computer are turned off.</p> <p>By default, the Enable Unobtrusive Mode option is disabled.</p> <p>i NOTE: On computers with collaboration touchpad, the Collaboration Touchpad is disabled when the Enable Unobtrusive Mode option is enabled.</p> <p>i NOTE: To view this option, enable Advanced Setup mode as described in View Advanced Setup options.</p>

Table 42. System Setup options—Storage menu

Storage	
SATA/NVMe Operation	<p>Sets the operating mode of the integrated SATA hard drive controller.</p> <p>By default, the RAID On option is selected.</p>
Storage Interface	<p>Displays the information of various onboard drives.</p>
Port Enablement	<p>Enables or disables the M.2 PCIe SSD option.</p> <p>By default, the M.2 PCIe SSD-1 and SSD-2 option is enabled.</p>
SMART Reporting	
Enable SMART Reporting	<p>Enables or disables the SMART reporting option.</p> <p>By default, the Enable SMART Reporting option is disabled.</p> <p>i NOTE: To view this option, enable Advanced Setup mode as described in View Advanced Setup options.</p>
Drive Information	<p>Displays the information of onboard drives.</p>
Enable MediaCard	
Secure Digital (SD) Card	<p>Enables or disables the SD card.</p> <p>By default, the Secure Digital (SD) Card option is enabled.</p> <p>i NOTE: To view this option, enable Advanced Setup mode as described in View Advanced Setup options.</p>
Secure Digital (SD) Card Read-Only Mode	<p>Enables or disables the SD card read-only mode.</p> <p>i NOTE: To view this option, enable Advanced Setup mode as described in View Advanced Setup options.</p> <p>By default, the Secure Digital (SD) Card Read-Only Mode option is disabled.</p>

Table 43. System Setup options—Display menu

Display	
Display Brightness	
Brightness on battery power	<p>By default, the screen brightness is set to 50 when the computer is running on battery power. Set the screen brightness when the computer is running on battery power.</p>

Table 43. System Setup options—Display menu (continued)





Display	
	<p> NOTE: To view this option, enable Advanced Setup mode as described in View Advanced Setup options.</p>
Brightness on AC power	<p>By default, the screen brightness is set to 100 when the computer is running on AC power. Set the screen brightness when the computer is running on AC power.</p> <p> NOTE: To view this option, enable Advanced Setup mode as described in View Advanced Setup options.</p>
Touchscreen	<p>Enables or disables the touch screen option.</p> <p>By default, the Touchscreen option is enabled.</p> <p> NOTE: Only available on computers with touch screen displays.</p> <p> NOTE: To view this option, enable Advanced Setup mode as described in View Advanced Setup options.</p>
Full Screen Logo	<p>Enables or disables the computer to display full screen logo, if the image matches screen resolution.</p> <p>By default, the Full Screen Logo option is disabled.</p> <p> NOTE: To view this option, enable Advanced Setup mode as described in View Advanced Setup options.</p>

Table 44. System Setup options—Connection menu

Connection	
Network Controller Configuration	
Integrated NIC	<p>Enables or disables the onboard LAN controller.</p> <p>By default, the Integrated NIC option is set to Enabled with PXE.</p>
Wireless Device Enable	
WLAN	<p>Enables or disables the internal WLAN device.</p> <p>By default, the WLAN option is enabled.</p>
Bluetooth	<p>Enables or disables the internal Bluetooth device.</p> <p>By default, the Bluetooth option is enabled.</p>
Enable UEFI Network Stack	<p>Enables or disables the UEFI Network Stack and controls the onboard LAN Controller.</p> <p>By default, the Enable UEFI Network Stack option is set to Auto Enabled.</p> <p> NOTE: To view this option, enable Advanced Setup mode as described in View Advanced Setup options.</p>
Wireless Radio Control	
Control WLAN Radio	<p>Enable to sense the connection of the computer to a wired network and then disables the selected WLAN radio. Upon disconnection from the wired network, the selected wireless radios are reenabled.</p> <p>By default, the Control WLAN Radio option is disabled.</p>

Table 44. System Setup options—Connection menu (continued)

Connection	
	<p>i NOTE: To view this option, enable Advanced Setup mode as described in View Advanced Setup options.</p>
Enable UEFI Bluetooth Stack	<p>Enables or disables the UEFI Bluetooth Stack. When enabled, UEFI Bluetooth protocols are installed and are available, allowing pre-OS Bluetooth HID features.</p> <p>By default, the Enable UEFI Bluetooth Stack option is enabled.</p>
HTTP(s) Boot Feature	
HTTP(s) Boot	<p>When enabled, supports HTTP(s) boot on the client BIOS, which offers wired or wireless and HTTP/HTTPS connection options.</p> <p>By default, the HTTP(s) Boot option is enabled.</p> <p>i NOTE: To view this option, enable Advanced Setup mode as described in View Advanced Setup options.</p>
HTTP(s) Boot Modes	<p>In Auto Mode, the boot URL is obtained from the DHCP response; the boot URL specifies the HTTP Boot Server and location of the Network Boot Program (NBP) file. In Manual mode, the user enters the URL in the text box, which must start with <code>http://</code> or <code>https://</code> and end with the NBP file name.</p> <p>By default, Auto Mode is selected.</p> <p>i NOTE: To view this option, enable Advanced Setup mode as described in View Advanced Setup options.</p>
CA Certificate	<p>Upload or delete the CA certificate.</p> <p>i NOTE: To view this option, enable Advanced Setup mode as described in View Advanced Setup options.</p>

Table 45. System Setup options—Power menu

Power	
Battery Configuration	<p>Enables or disables the computer to run on battery during peak power usage hours. Use the table Custom Charge Start and Custom Charge Stop, to prevent AC power usage between certain times of each day.</p> <p>By default, the Adaptive option is selected. Battery settings are adaptively optimized based on your typical battery usage pattern.</p>
Advanced Configuration	
Enable Advanced Battery Charge Configuration	<p>Enables Advanced Battery Charge Configuration from the beginning of the day to a specified work period. When enabled, Advanced Battery Charged maximizes battery health while still supporting heavy use during the work day.</p> <p>By default, the Enable Advanced Battery Charge Configuration option is disabled.</p> <p>i NOTE: To view this option, enable Advanced Setup mode as described in View Advanced Setup options.</p>

Table 45. System Setup options—Power menu (continued)





Power	
Peak Shift	
Enable Peak Shift	<p>Enables or disables the computer to run on battery during peak power usage hours.</p> <p>By default, the Enable Peak Shift option is disabled.</p> <p> NOTE: To view this option, enable Advanced Setup mode as described in View Advanced Setup options.</p>
Type-C Connector Power	
	<p>Allows you to set the maximum power that can be drawn from the Type-C connector.</p> <p>By default, the Type-C Connector Power option is set to 7.5 W.</p>
USB PowerShare	
Enable USB PowerShare	<p>Enables or disables the USB PowerShare on the computer.</p> <p>By default, the Enable USB PowerShare option is disabled.</p>
Thermal Management	
	<p>This setting allows for cooling of fan and processor heat management to adjust system performance, noise and temperature.</p> <p>By default, the Optimized option is selected.</p>
USB Wake Support	
Wake on Dell USB-C Dock	<p>When enabled, connecting a Dell USB-C Dock wakes the computer from Standby, Hibernate, and Power Off.</p> <p>By default, the Wake on Dell USB-C Dock option is enabled.</p> <p> NOTE: To view this option, enable Advanced Setup mode as described in View Advanced Setup options.</p>
Block Sleep	
	<p>Enables or disables the computer from entering Sleep (S3) mode in the operating system.</p> <p>By default, the Block Sleep option is disabled.</p> <p> NOTE: When enabled, the computer does not go to Sleep, Intel Rapid Start is disabled automatically, and the operating system power option is blank if it was set to Sleep.</p> <p> NOTE: To view this option, enable Advanced Setup mode as described in View Advanced Setup options.</p>
Lid Switch	
Enable Lid Switch	<p>Enables or disables the Lid Switch.</p> <p>By default, the Enable Lid Switch option is enabled.</p>
Power On Lid Open	<p>When enabled, allows the computer to turn on from the off state whenever the lid is opened.</p> <p>By default, the Power On Lid Open option is enabled.</p>

Table 46. System Setup options—Security menu

Security	
TPM 2.0 Security	
	<p>Trusted Platform Module (TPM) is a security device that stores computer-generated keys for encryption and features such as BitLocker, Virtual Secure Mode, remote Attestation.</p> <p>By default, the TPM 2.0 Security option is enabled.</p>

Table 46. System Setup options—Security menu (continued)

Security	
	<p>For additional security, Dell Technologies recommends keeping the Trusted Platform Module (TPM) enabled to allow these security technologies to fully function.</p>
TPM 2.0 Security On	<p>Enables or disables the TPM.</p> <p>By default, the TPM 2.0 Security On option is enabled.</p> <p>For additional security, Dell Technologies recommends keeping TPM enabled to allow these security technologies to fully function.</p> <p>NOTE: To view this option, enable Advanced Setup mode as described in View Advanced Setup options.</p>
Attestation Enable	<p>The Attestation Enable option controls the endorsement hierarchy of TPM. Disabling the Attestation Enable option prevents TPM from being used to digitally sign certificates.</p> <p>By default, the Attestation Enable option is enabled.</p> <p>For additional security, Dell Technologies recommends keeping the Attestation Enable option enabled.</p> <p>NOTE: When disabled, this feature may cause compatibility issues or loss of functionality in some operating systems.</p> <p>NOTE: To view this option, enable Advanced Setup mode as described in View Advanced Setup options.</p>
Key Storage Enable	<p>The Key Storage Enable option controls the storage hierarchy of TPM, which is used to store digital keys. Disabling the Key Storage Enable option restricts the ability of TPM to store owner's data.</p> <p>By default, the Key Storage Enable option is enabled.</p> <p>For additional security, Dell Technologies recommends keeping the Key Storage Enable option enabled.</p> <p>NOTE: When disabled, this feature may cause compatibility issues or loss of functionality in some operating systems.</p> <p>NOTE: To view this option, enable Service options as described in View Service options.</p>
Clear	<p>When enabled, the Clear option clears information that is stored in the TPM after exiting the system's BIOS. This option returns to the disabled state when the computer restarts.</p> <p>By default, the Clear option is disabled.</p> <p>Dell Technologies recommends enabling the Clear option only when TPM data is required to be cleared.</p> <p>NOTE: To view this option, enable Advanced Setup mode as described in View Advanced Setup options.</p>
Physical Presence Interface (PPI) Bypass for Clear Commands	<p>The PPI Bypass for Clear Commands option allows the operating system to manage certain aspects of PTT. When enabled, you are not prompted to confirm changes to the PTT configuration.</p> <p>By default, the PPI Bypass for Clear Commands option is disabled.</p> <p>For additional security, Dell Technologies recommends keeping the PPI Bypass for Clear Commands option disabled.</p>
Chassis Intrusion	

Table 46. System Setup options—Security menu (continued)







Security	
Chassis Intrusion	<p>Enables or disables the detection of chassis intrusion events. This feature notifies the user when the base cover has been removed from the computer.</p> <p>When set to Enabled, a notification is displayed on the next boot and the event is logged in the BIOS Events log.</p> <p>When set to Disabled, no notification is displayed and no event is logged in the BIOS Events log.</p> <p>When set to On-Silent, the event is logged in the BIOS Events log, but no notification is displayed.</p> <p>By default, the Chassis Intrusion Detection option is disabled.</p> <p>For additional security, Dell Technologies recommends keeping the Chassis Intrusion option enabled.</p> <p> NOTE: To view this option, enable Advanced Setup mode as described in View Advanced Setup options.</p>
Block Boot Until Cleared	<p>The Block Boot Until Clear option is enabled when Chassis Intrusion is enabled. When enabled, the computer does not boot until the chassis intrusion is cleared.</p> <p> NOTE: To view this option, enable Advanced Setup mode as described in View Advanced Setup options.</p>
Data Wipe on Next Boot	
Start Data Wipe	<p>Data Wipe is a secure wipe operation that deletes information from a storage device.</p> <p> WARNING: The Secure Data Wipe operation deletes information in a way that it cannot be reconstructed.</p> <p>Commands such as delete and format in the operating system may remove files from showing up in the file system. However, they can be reconstructed through forensic means as they are still represented on the physical media. Data Wipe prevents this reconstruction and the data can no longer be recovered.</p> <p>When enabled, the data wipe option provides prompts to wipe any storage devices that are connected to the computer on the next boot.</p> <p>By default, the Start Data Wipe option is disabled.</p> <p> NOTE: To view this option, enable Advanced Setup mode as described in View Advanced Setup options.</p>
Absolute	<p>Absolute Software provides various cyber security solutions, some requiring software preloaded on Dell computers and integrated into the BIOS. To use these features, you must enable the Absolute BIOS setting and contact Absolute for configuration and activation.</p> <p>By default, the Absolute option is enabled.</p> <p>For additional security, Dell Technologies recommends keeping the Absolute option enabled.</p> <p> WARNING: The Permanently Disabled option can only be selected once. When Permanently Disabled is selected, Absolute Persistence cannot be reenabled. No further changes to the Enable/Disable states are allowed.</p> <p> NOTE: The Enable/Disable options are unavailable while the computer is in the activated state.</p> <p> NOTE: When the Absolute features are activated, the Absolute integration cannot be disabled from the BIOS Setup screen.</p>

Table 46. System Setup options—Security menu (continued)

Security	
UEFI Boot Path Security	<p>Enables or disables the computer to prompt the user to enter the Administrator password (if set) when booting to a UEFI boot path device from the F12 boot menu.</p> <p>By default, the Always Except Internal HDD option is enabled.</p> <p>NOTE: To view this option, enable Advanced Setup mode as described in View Advanced Setup options.</p>
Authenticated BIOS Interface	<p>Enable Authenticated BIOS Interface</p> <p>Enables or disables the authenticated BIOS Interface.</p> <p>By default, the Enable Authenticated BIOS Interface option is disabled.</p> <p>NOTE: To view this option, enable Advanced Setup mode as described in View Advanced Setup options.</p>
Clear Certificate Store	<p>Deletes the certificates from KMS storage.</p> <p>NOTE: To view this option, enable Advanced Setup mode as described in View Advanced Setup options.</p>
Legacy Manageability Interface Access	<p>Allows access to the Legacy Manageability Interface.</p> <p>NOTE: To view this option, enable Advanced Setup mode as described in View Advanced Setup options.</p>
Firmware Device Tamper Detection	<p>Allows you to control the firmware device tamper detection feature. This feature notifies the user when the firmware device is tampered. When enabled, a screen warning message is displayed on the computer and a tamper detection event is logged in the BIOS Events log. The computer fails to reboot until the event is cleared.</p> <p>By default, the Firmware Device Tamper Detection option is enabled.</p> <p>For additional security, Dell Technologies recommends keeping the Firmware Device Tamper Detection option enabled.</p> <p>NOTE: To view this option, enable Advanced Setup mode as described in View Advanced Setup options.</p>
Clear Firmware Device Tamper Detection	<p>Allows you to clear the events that are logged when tampering of firmware device is detected.</p> <p>By default, the Clear Firmware Device Tamper Detection option is disabled.</p> <p>NOTE: To view this option, enable Advanced Setup mode as described in View Advanced Setup options.</p>

Table 47. System Setup options—Passwords menu

Passwords	
Admin Password	<p>The Administrator Password prevents unauthorized access to the BIOS Setup options. Once the administrator password is set, the BIOS Setup options can only be modified after providing the correct password.</p> <p>The following rules and dependencies apply to the Administrator Password -</p> <ul style="list-style-type: none"> • The administrator password cannot be set if system and/or internal storage passwords are previously set. • The administrator password can be used in place of the system and/or internal storage passwords. • When set, the administrator password must be provided during a firmware update.

Table 47. System Setup options—Passwords menu (continued)

Passwords	
	<ul style="list-style-type: none"> Clearing the administrator password also clears the system password (if set). <p>Dell Technologies recommends using an administrator password to prevent unauthorized changes to BIOS Setup options.</p>
System Password	<p>The System Password prevents the computer from booting to an operating system without entering the correct password.</p> <p>The following rules and dependencies apply when the System Password is used -</p> <ul style="list-style-type: none"> The computer shuts down when idle for approximately 10 minutes at the system password prompt. The computer shuts down after three incorrect attempts to enter the system password. The computer shuts down when the Esc key is pressed at the System Password prompt. The system password is not prompted when the computer resumes from standby mode. <p>Dell Technologies recommends using the system password in situations where it is likely that a computer may be lost or stolen.</p>
M.2 PCIe SSD-1	<p>The M.2 PCIe SSD-1 password prevents the computer from booting to an operating system without entering the correct password.</p> <p>The following rules and dependencies apply when the System Password is used -</p> <ul style="list-style-type: none"> The computer shuts down when idle for approximately 10 minutes at the system password prompt. The computer shuts down after three incorrect attempts to enter the system password. The computer shuts down when the Esc key is pressed at the System Password prompt. The system password is not prompted when the computer resumes from standby mode. <p>Dell Technologies recommends using the system password in situations where it is likely that a computer may be lost or stolen.</p>
Password Configuration	<p>The Password Configuration page includes several options for changing the requirements of BIOS passwords. You can modify the minimum and maximum length of the passwords as well as require passwords to contain certain character classes (upper case, lower case, digit, special character).</p> <p>When the Lower Case Letter option is enabled, the password requires at least one lower case letter.</p> <p>When the Upper Case Letter option is enabled, the password requires at least one upper case letter.</p> <p>When the Digit option is enabled, the password requires at least one numeric digit.</p> <p>When the Special Character option is enabled, the password requires at least one special character from the set: !"#%&'()*+,-./:;<=>@[\\]^_`{ }~.</p> <p>When setting Minimum Characters for password length, Dell Technologies recommends setting the minimum password length to at least eight characters.</p> <p> NOTE: To view this option, enable Advanced Setup mode as described in View Advanced Setup options.</p>
Password Bypass	<p>The Password Bypass option allows the computer to reboot from the operating system without entering the system or hard drive password. If the computer has already booted to the operating system, it is presumed that the user has already entered the correct system or hard drive password.</p>

Table 47. System Setup options—Passwords menu (continued)

Passwords	
	<p>i NOTE: This option does not remove the requirement to enter the password after shutting down.</p> <p>By default, the Password Bypass option is disabled.</p> <p>For additional security, Dell Technologies recommends keeping the Password Bypass option enabled.</p> <p>i NOTE: To view this option, enable Advanced Setup mode as described in View Advanced Setup options.</p>
Password Changes	
Allow Non-Admin Password Changes	<p>The Allow Non-Admin Password Changes option in BIOS Setup allows an end user to set or change the system or hard drive passwords without entering the administrator password. This gives an administrator control over the BIOS settings but enables an end user to provide their own password.</p> <p>By default, the Allow Non-Admin Password Changes option is enabled.</p> <p>For additional security, Dell Technologies recommends keeping the Allow Non-Admin Password Changes option disabled.</p> <p>i NOTE: To view this option, enable Advanced Setup mode as described in View Advanced Setup options.</p>
Admin Setup Lockout	
Enable Admin Setup Lockout	<p>The Admin Setup Lockout option prevents an end user from even viewing the BIOS Setup configuration without first entering the administrator password (if set).</p> <p>By default, the Enable Admin Setup Lockout option is disabled.</p> <p>For additional security, Dell Technologies recommends keeping the Admin Setup Lockout option disabled.</p> <p>i NOTE: To view this option, enable Advanced Setup mode as described in View Advanced Setup options.</p>
Master Password Lockout	
Enable Master Password Lockout	<p>The Master Password Lockout option allows you to disable the Recovery Password feature. If the system, administrator, or hard drive password is forgotten, the computer becomes unusable.</p> <p>i NOTE: When the owner password is set, the Master Password Lockout option is not available.</p> <p>i NOTE: When an internal hard drive password is set, it must first be cleared before Master Password Lockout can be changed.</p> <p>By default, the Enable Master Password Lockout option is disabled.</p> <p>Dell Technologies does not recommend enabling the Master Password Lockout unless you have implemented your own password recovery system.</p> <p>i NOTE: To view this option, enable Advanced Setup mode as described in View Advanced Setup options.</p>
Allow Non-Admin PSID Revert	
Enable Allow Non-Admin PSID Revert	<p>The Allow Non-Admin PSID Revert option allows a user to clear the hard drive password without entering the BIOS Admin Password. When an Admin Password is set, the ability to enter the PSID is protected by requiring authentication with the Admin Password. If this option is enabled, any user can clear the drive without entering the Admin Password.</p> <p>By default, the Enable Allow Non-Admin PSID Revert option is disabled.</p>

Table 47. System Setup options—Passwords menu (continued)

Passwords	
	<p> NOTE: To view this option, enable Advanced Setup mode as described in View Advanced Setup options.</p>

Table 48. System Setup options—Update, Recovery menu





Update, Recovery	
BIOS Recovery from Hard Drive	<p>Enables or disables the user to recover from certain corrupted BIOS conditions from a recovery file on the user primary hard drive or an external USB drive.</p> <p>By default, the BIOS Recovery from Hard Drive option is enabled.</p> <p> NOTE: BIOS Recovery from Hard Drive is not available for self-encrypting drives (SED).</p> <p> NOTE: BIOS recovery is designed to fix the main BIOS block and cannot work if the Boot Block is damaged. In addition, this feature cannot work in the event of EC corruption, ME corruption, or a hardware issue. The recovery image must exist on an unencrypted partition on the drive.</p> <p> NOTE: To view this option, enable Advanced Setup mode as described in View Advanced Setup options.</p>
BIOS Downgrade	
Allow BIOS Downgrade	<p>Allows downgrading of the system firmware to previous revisions.</p> <p>By default, the Allow BIOS Downgrade option is enabled.</p>
SupportAssist OS Recovery	<p>Enables or disables the boot flow for SupportAssist OS Recovery tool if certain system errors occur.</p> <p>By default, the SupportAssist OS Recovery option is enabled.</p>
BIOSConnect	<p>Enables or disables cloud service operating system recovery if the main operating system fails to boot with the number of failures equal to or greater than the value specified by the Auto OS Recovery Threshold setup option and local service operating system does not boot or is not installed.</p> <p>By default, the BIOSConnect option is enabled.</p>
Dell Auto OS Recovery Threshold	<p>Allows the control of the automatic boot flow for the SupportAssist System Resolution Console and the Dell OS Recovery Tool.</p> <p>By default, the Dell Auto OS Recovery Threshold value is set to 2.</p> <p> NOTE: To view this option, enable Advanced Setup mode as described in View Advanced Setup options.</p>

Table 49. System Setup options—System Management menu

System Management	
Service Tag	Displays the Service Tag of the computer.
Asset Tag	<p>Creates a computer Asset Tag that an IT administrator can use to uniquely identify a particular computer.</p> <p> NOTE: Once set in the BIOS, the Asset Tag cannot be changed.</p>
AC Behavior	
Wake on AC	<p>Enables or disables the computer to turn on and go to boot when AC power is supplied to the computer.</p> <p>By default, the Wake on AC option is disabled.</p>

Table 49. System Setup options—System Management menu (continued)

System Management	
	<p>i NOTE: To view this option, enable Advanced Setup mode as described in View Advanced Setup options.</p>
Wake on LAN	<p>Enables or disables the computer to turn on by a special LAN signal.</p> <p>By default, the Wake on LAN option is disabled.</p> <p>i NOTE: To view this option, enable Advanced Setup mode as described in View Advanced Setup options.</p>
Auto On Time	<p>Enable to set the computer to turn on automatically every day or on a preselected date and time. This option can be configured only if the Auto On Time is set to Everyday, Weekdays, or Selected Days.</p> <p>By default, the Auto On Time option is disabled.</p> <p>i NOTE: To view this option, enable Advanced Setup mode as described in View Advanced Setup options.</p>
Intel AMT capability	
Enable Intel AMT capability	<p>Configure Intel Active Management Technology (AMT) options, which can be enabled, disabled, or restricted.</p> <p>i NOTE: To view this option, enable Advanced Setup mode as described in View Advanced Setup options.</p>
First Power On Date	
Set Ownership Date	<p>Enables setting up ownership date.</p> <p>By default, the Set Ownership Date option is disabled.</p>
Diagnostics	
OS Agent Requests	<p>Enable or disable the option for applications running in the operating system to run with preboot diagnostics on subsequent boots.</p> <p>i NOTE: To view this option, enable Advanced Setup mode as described in View Advanced Setup options.</p>
Power-On-Self-Test Automatic Recovery	<p>Enable or disable the automatic recovery of the computer from no power or no-POST failure by applying mitigation steps.</p> <p>By default, the Power-On-Self-Test Automatic Recovery option is enabled.</p> <p>i NOTE: To view this option, enable Advanced Setup mode as described in View Advanced Setup options.</p>

Table 50. System Setup options—Keyboard menu

Keyboard	
Numlock Enable	
Enable Numlock	<p>Defines if the Numlock function should be enabled when the computer boots. ON by default.</p> <p>By default, the Enable Numlock option is set to ON.</p>
Fn Lock Options	
Fn Lock Options	<p>Enables or disables the Fn Lock option.</p> <p>By default, the Fn Lock option is enabled.</p>
Lock Mode	<p>By default, the Lock Mode Secondary option is selected. With this option, the F1-F12 keys scan the code for their secondary functions.</p>

Table 50. System Setup options—Keyboard menu (continued)

Keyboard	
Keyboard Illumination	<p>Configures the operating mode of the keyboard illumination feature.</p> <p>By default, the Disabled option is selected. The keyboard illumination is always off.</p>
Keyboard Backlight Timeout on AC	<p>Sets the timeout value for the keyboard backlight when an AC adapter is connected to the computer.</p> <p>By default, the 10 seconds option is selected.</p> <p>i NOTE: To view this option, enable Advanced Setup mode as described in View Advanced Setup options.</p>
Keyboard Backlight Timeout on Battery	<p>Sets the timeout value for the keyboard backlight when the computer is running only on the battery power. The keyboard backlight timeout value is only effective when the backlight is enabled.</p> <p>By default, the 10 seconds option is selected.</p> <p>i NOTE: To view this option, enable Advanced Setup mode as described in View Advanced Setup options.</p>
Device Configuration HotKey Access	<p>Allows you to control whether you can access device configuration screens through hotkeys during system startup.</p> <p>By default, the Device Configuration HotKey Access option is enabled.</p> <p>i NOTE: This setting controls only the Intel RAID (CTRL+I), MEBX (CTRL+P), and LSI RAID (CTRL+C) Option ROMs. Other preboot Option ROMs, which support entry using a key sequence, are not affected by this setting.</p> <p>i NOTE: To view this option, enable Advanced Setup mode as described in View Advanced Setup options.</p>

Table 51. System Setup options—Pre-boot Behavior menu

Pre-boot Behavior	
Adapter Warnings	
Enable Adapter Warnings	<p>Enables the warning messages during boot when the adapters with less power capacity are detected.</p> <p>By default, the Enable Adapter Warnings option is enabled.</p> <p>i NOTE: To view this option, enable Advanced Setup mode as described in View Advanced Setup options.</p>
Warnings and Errors	<p>Enables or disables the action to be taken when a warning or error is encountered.</p> <p>By default, the Prompt on Warnings and Errors option is selected.</p> <p>i NOTE: Errors deemed critical to the operation of the computer hardware stop the functioning of the computer.</p> <p>i NOTE: To view this option, enable Advanced Setup mode as described in View Advanced Setup options.</p>
Extend BIOS POST Time	<p>Sets the BIOS POST (Power-On Self-Test) load time.</p> <p>By default, the 0 seconds option is selected.</p> <p>i NOTE: To view this option, enable Advanced Setup mode as described in View Advanced Setup options.</p>
MAC Address Pass-Through	<p>Replaces the external NIC MAC address (in a supported dock or dongle) with the selected MAC address from the computer.</p>

Table 51. System Setup options—Pre-boot Behavior menu (continued)

Pre-boot Behavior	
	By default, the System Unique MAC Address option is selected.
Sign of Life	
Early Keyboard Backlight	<p>Enables or disables the Keyboard Backlight Sign of Life.</p> <p>By default, the Early Keyboard Backlight option is enabled.</p> <p>i NOTE: To view this option, enable Advanced Setup mode as described in View Advanced Setup options.</p>

Table 52. System Setup options—Virtualization menu

Virtualization Support	
Intel Trusted Execution Technology (TXT)	
Enable Intel Trusted Execution Technology (TXT)	<p>Specifies whether a measured Virtual Machine Monitor (MVMM) can use the additional hardware capabilities provided by Intel Trusted Execution Technology. The following must be enabled in order to enable Intel TXT -</p> <ul style="list-style-type: none"> ● Trusted Platform Module (TPM) ● Intel Hyper-Threading ● All CPU cores (Multi-Core Support) ● Intel Virtualization Technology ● Intel VT for Direct I/O <p>By default, the Enable Intel Trusted Execution Technology (TXT) option is disabled.</p> <p>i NOTE: To view this option, enable Advanced Setup mode as described in View Advanced Setup options.</p>
DMA Protection	
Enable Pre-Boot DMA Support	<p>Allows you to control the Pre-Boot DMA protection for both internal and external ports. This option does not directly enable DMA protection in the operating system.</p> <p>i NOTE: This option is not available when the virtualization setting for IOMMU is disabled (VT-d/AMD Vi).</p> <p>By default, the Enable Pre-Boot DMA Support option is enabled.</p> <p>For additional security, Dell Technologies recommends keeping the Enable Pre-Boot DMA Support option enabled.</p> <p>i NOTE: This option is provided only for compatibility purposes, since some older hardware is not DMA capable.</p> <p>i NOTE: To view this option, enable Advanced Setup mode as described in View Advanced Setup options.</p>
Enable OS Kernel DMA Support	<p>Allows you to control the Kernel DMA protection for both internal and external ports. This option does not directly enable DMA protection in the operating system. For operating systems that support DMA protection, this setting indicates to the operating system that the BIOS supports the feature.</p> <p>i NOTE: This option is not available when the virtualization setting for IOMMU is disabled (VT-d/AMD Vi).</p> <p>By default, the Enable OS Kernel DMA Support option is enabled.</p> <p>i NOTE: This option is provided only for compatibility purposes, since some older hardware is not DMA capable.</p> <p>i NOTE: To view this option, enable Advanced Setup mode as described in View Advanced Setup options.</p>

Table 52. System Setup options—Virtualization menu (continued)

Virtualization Support	
Internal Port DMA Compatibility Mode	<p>When enabled, BIOS will notify the operating system if the internal ports are not DMA capable.</p> <p>NOTE: This option is not available when the virtualization setting for IOMMU is disabled (VT-d/AMD Vi).</p> <p>By default, the Internal Port DMA Compatibility Mode option is disabled.</p> <p>NOTE: This option is provided only for compatibility purposes, since some older hardware is not DMA capable.</p> <p>NOTE: To view this option, enable Advanced Setup mode as described in View Advanced Setup options.</p>

Table 53. System Setup options—Performance menu

Performance	
Intel SpeedStep	
Enable Intel SpeedStep Technology	<p>Enables the computer to dynamically adjust processor voltage and core frequency, decreasing average power consumption and heat production.</p> <p>By default, the Enable Intel SpeedStep Technology option is enabled.</p> <p>NOTE: To view this option, enable Service options as described in View Service options.</p>
Enable Adaptive C-States for Discrete Graphics	<p>Enables the ability of the CPU to dynamically detect high usage of a discrete graphic and adjust system parameters for higher performance.</p> <p>By default, the Enable Adaptive C-States for Discrete Graphics option is enabled.</p> <p>NOTE: To view this option, enable Service options as described in View Service options.</p>

Table 54. System Setup options—System Logs menu

System Logs	
BIOS Event Log	
Clear BIOS Event Log	<p>Select the option to keep or clear BIOS events logs.</p> <p>By default, the Keep Log option is selected.</p> <p>NOTE: To view this option, enable Advanced Setup mode as described in View Advanced Setup options.</p>
Thermal Event Log	
Clear Thermal Event Log	<p>Select the option to keep or clear thermal events logs.</p> <p>By default, the Keep Log option is selected.</p> <p>NOTE: To view this option, enable Advanced Setup mode as described in View Advanced Setup options.</p>
Power Event Log	
Clear Power Event Log	<p>Select the option to keep or clear power events logs.</p> <p>By default, the Keep Log option is selected.</p> <p>NOTE: To view this option, enable Advanced Setup mode as described in View Advanced Setup options.</p>

Updating the BIOS

Updating the BIOS in Windows

About this task

CAUTION: If BitLocker is not suspended before updating the BIOS, the BitLocker key is not recognized the next time you reboot the computer. You will then be prompted to enter the recovery key to proceed, and the computer displays a prompt for the recovery key on each reboot. Failure to provide the recovery key can result in data loss or an operating system reinstall. For more information, refer [Updating the BIOS on Dell systems with BitLocker enabled](#).

CAUTION: Do not turn off the computer during the BIOS flash update process. The computer may not boot if you turn off your computer.

Steps

1. Go to [Dell Support Site](#).
2. Go to **Identify your product or ask support**. In the box, enter the product identifier, model, service request or describe what you are looking for, and then click **Search**.
 - NOTE:** If you do not have the Service Tag, click **Detect This PC**. The site automatically detects your device, and you can then click **Explore Product Support** to go to the support page for your device. You can also use the product ID or manually browse for your computer model.
3. Click **Drivers & Downloads**.
4. Select the operating system installed on your computer.
5. In the **Category** drop-down list, select **BIOS**.
6. Select the latest version of BIOS, and click **Download** to download the BIOS file for your computer.
7. After the download is complete, navigate to the folder where the BIOS update file has been saved.
8. Double-click the BIOS update file and follow the on-screen instructions.
For more information, search [Dell Support Site](#).

Updating the BIOS in Linux and Ubuntu

To update the system BIOS on a computer that is installed with Linux or Ubuntu, see [How to Update the Dell BIOS in the Ubuntu or Linux Environment](#) at [Dell Support Site](#).

Updating the BIOS using the USB drive in Windows

About this task

CAUTION: If BitLocker is not suspended before updating the BIOS, the BitLocker key is not recognized the next time you reboot the computer. You will then be prompted to enter the recovery key to proceed, and the computer displays a prompt for the recovery key on each reboot. Failure to provide the recovery key can result in data loss or an operating system reinstall. For more information, refer [Updating the BIOS on Dell systems with BitLocker enabled](#).

CAUTION: Do not turn off the computer during the BIOS flash update process. The computer may not boot if you turn off your computer.

Steps

1. Go to [Dell Support Site](#).
2. Go to **Identify your product or ask support**. In the box, enter the product identifier, model, service request or describe what you are looking for, and then click **Search**.

NOTE: If you do not have the Service Tag, click **Detect This PC**. The site automatically detects your device, and you can then click **Explore Product Support** to go to the support page for your device. You can also use the product ID or manually browse for your computer model.

3. Click **Drivers & Downloads**.
4. Select the operating system installed on your computer.
5. In the **Category** drop-down list, select **BIOS**.
6. Select the latest version of BIOS, and click **Download** to download the BIOS file for your computer.
7. Create a bootable USB drive. For more information, search [Dell Support Site](#).
8. Copy the BIOS setup program file to the bootable USB drive.
9. Connect the bootable USB drive to the computer that needs the BIOS update.
10. Restart the computer and press **F12**.
11. Select the USB drive from the **One Time Boot Menu**.
12. Type the BIOS setup program filename and press **Enter**.
The **BIOS Update Utility** appears.
13. Follow the on-screen instructions to complete the BIOS update.

Updating the BIOS from the One-Time boot menu

To update the BIOS from the One-Time boot menu, see [Updating the BIOS from the One Time Boot Menu](#) at [Dell Support Site](#).

System and setup password

CAUTION: The password features provide a basic level of security for the data on your computer.

CAUTION: Ensure that your computer is locked when it is not in use. Anyone can access the data that is stored on your computer, when left unattended.

Table 55. System and setup password

Password type	Description
System password	Password that you must enter to boot to your operating system.
Setup password	Password that you must enter to access and change the BIOS settings of your computer.

You can create a system password and a setup password to secure your computer.

NOTE: The System and setup password feature is disabled by default.

Assigning a System Setup password

Prerequisites

You can assign a new System or Admin Password only when the status is set to **Not Set**. To enter BIOS System Setup, press F2 immediately after a power-on or reboot.

Steps

1. To enter the **System Setup**, press **F2** immediately after a power-on or reboot.
2. In the **System BIOS** or **System Setup** screen, select **Security** and press Enter.
The **Security** screen is displayed.
3. Select **System/Admin Password** and create a password in the **Enter the new password** field.
Use the following guidelines to create the system password:

- Password can be up to 32 characters.
 - Password must contain at least one special character: "(! " # \$ % & ' * + , - . / : ; < = > ? @ [\] ^ _ ` { | })"
 - The password can contain numbers from 0 to 9.
 - The password can contain alphabets A to Z and a to z.
4. Type the system password that you entered earlier in the **Confirm new password** field and click **OK**.
 5. Press Y to save the changes.
The computer restarts.

Deleting or changing an existing system password or setup password

Prerequisites

Ensure that the **Password Status** is Unlocked in the System Setup before attempting to delete or change the existing system password and/or setup password. You cannot delete or change an existing system password or setup password if the **Password Status** is Locked. To enter the System Setup, press F2 immediately after a power-on or reboot.

Steps

1. To enter the **System Setup**, press **F2** immediately after a power-on or reboot.
2. In the **System BIOS** or **System Setup** screen, select **System Security** and press Enter.
The **System Security** screen is displayed.
3. In the **System Security** screen, verify that the **Password Status** is Unlocked.
4. Select **System Password**. Update or delete the existing system password, and press Enter or Tab.
5. Select **Setup Password**. Update or delete the existing setup password, and press Enter or Tab.
 **NOTE:** If you change the system password and/or setup password, reenter the new password when prompted. If you delete the system password and/or setup password, confirm the deletion when prompted.
6. Press Esc. A message prompts you to save the changes.
7. Press Y to save the changes and exit from **System Setup**.
The computer restarts.

Clearing system and setup passwords

About this task

To clear the system or setup passwords, contact Dell technical support as described at [Contact Support](#).

-  **NOTE:** For information about how to reset Windows or application passwords, see the documentation accompanying Windows or your application.

Troubleshooting

Handling swollen rechargeable Li-ion batteries

Like most laptops, Dell laptops use Lithium-ion batteries. One type of Lithium-ion battery is the rechargeable Li-ion battery. Rechargeable Li-ion batteries have increased in popularity in recent years and have become a standard in the electronics industry due to customer preferences for a slim form factor (especially with newer ultra-thin laptops) and long battery life. Inherent to rechargeable Li-ion battery technology is the potential for swelling of the battery cells.

A swollen battery may impact the performance of the laptop. To prevent possible further damage to the device enclosure or internal components leading to malfunction, discontinue the use of the laptop and discharge it by disconnecting the AC adapter and letting the battery drain.

Swollen batteries should not be used and must be replaced and disposed of properly. We recommend contacting Dell Support for options to replace a swollen battery under the terms of the applicable warranty or service contract, including options for replacement by a Dell authorized service technician.

The guidelines for handling and replacing rechargeable Li-ion batteries are as follows:

- Exercise caution when handling rechargeable Li-ion batteries.
- Discharge the battery before removing it from the laptop. To discharge the battery, unplug the AC adapter from the computer and operate the computer only on battery power. The battery is fully discharged when the computer no longer turns on when the power button is pressed.
- Do not crush, drop, mutilate, or penetrate the battery with foreign objects.
- Do not expose the battery to high temperatures, or disassemble battery packs and cells.
- Do not apply pressure to the surface of the battery.
- Do not bend the battery.
- Do not use tools of any type to pry on or against the battery.
- If a battery gets stuck in a device as a result of swelling, do not try to free it as puncturing, bending, or crushing a battery can be dangerous.
- Do not attempt to reassemble a damaged or swollen battery into a laptop.
- Swollen batteries that are covered under warranty should be returned to Dell in an approved shipping container (provided by Dell)—this is to comply with transportation regulations. Swollen batteries that are not covered under warranty should be disposed of at an approved recycling center. Contact Dell Support at [Dell Support Site](#) for assistance and further instructions.
- Using a non-Dell or incompatible battery may increase the risk of fire or explosion. Replace the battery only with a compatible battery purchased from Dell that is designed to work with your Dell computer. Do not use a battery from other computers with your computer. Always purchase genuine batteries from [Dell Site](#) or otherwise directly from Dell.

Rechargeable Li-ion batteries can swell for various reasons such as age, number of charge cycles, or exposure to high heat. For more information about how to improve the performance and lifespan of the laptop battery and to minimize the possibility of occurrence of the issue, search Dell laptop battery at [Dell Support Site](#).

Dell SupportAssist Pre-boot System Performance Check diagnostics

About this task

SupportAssist diagnostics (also known as system diagnostics) performs a complete check of your hardware. The Dell SupportAssist Pre-boot System Performance Check diagnostics is embedded within the BIOS and launched by the BIOS internally. The embedded system diagnostics provides options for particular devices or device groups allowing you to:

- Run tests automatically or in an interactive mode.
- Repeat the tests.
- Display or save test results.
- Run thorough tests to add more options and obtain details about any failed devices.

- View status messages that inform you when the tests are completed successfully.
- View error messages that inform you of problems encountered during testing.

NOTE: Some tests for specific devices require user interaction. Always ensure that you are present at the computer when the diagnostic tests are performed.

For more information, see [How to Run Dell Preboot Diagnostics and Hardware Tests on Your Dell Computer](#).

Running the SupportAssist Pre-Boot System Performance Check

Steps

1. Turn on your computer.
2. As the computer boots, press the F12 key.
3. On the boot menu screen, select **Diagnostics**.
The diagnostic quick test begins.
NOTE: For more information about running the SupportAssist Pre-Boot System Performance Check on a specific device, see [Dell Support Site](#).
4. If there are any issues, error codes are displayed.
Note the error code and validation number and contact Dell.

Built-in self-test (BIST)

Motherboard Built-In Self-Test (M-BIST)

M-BIST is the system board onboard self-test diagnostics tool that improves the diagnostics accuracy of system board Embedded Controller (EC) failures.

NOTE: M-BIST can be manually initiated before Power On Self-Test (POST).

How to run M-BIST

NOTE: Before initiating M-BIST, ensure that the computer is in a power-off state.

1. Press and hold both the **M** key and the power button to initiate M-BIST.
2. The battery-status light may exhibit two states:
 - Off: No fault was detected.
 - Amber and White: Indicates a problem with the system board.
3. If there is a failure with the system board, the battery-status light flashes one of the following error codes for 30 seconds:

Table 56. LED error codes

Blinking Pattern		Possible Problem
Amber	White	
2	1	CPU Failure
2	8	LCD Power Rail Failure
1	1	TPM Detection Failure
2	4	Memory/RAM failure

4. If there is no failure with the system board, the LCD cycles through the solid color screens (that are described in the LCD-BIST) for 30 seconds and then turn off.

Logic Built-in Self-test (L-BIST)

L-BIST is an enhancement to the single LED error code diagnostics and is automatically initiated during POST. L-BIST will check the LCD power rail. If there is no power being supplied to the LCD (that is if the L-BIST circuit fails), the battery status LED flashes either an error code [2,8] or an error code [2,7].

 **NOTE:** If L-BIST fails, LCD-BIST cannot function as no power will be supplied to the LCD.

How to invoke the L-BIST

1. Turn on your computer.
2. If the computer does not start up normally, look at the battery status LED:
 - If the battery status LED flashes an error code [2,7], the display cable may not be connected properly.
 - If the battery status LED flashes an error code [2,8], there is a failure on the LCD power rail of the system board, hence there is no power that is supplied to the LCD.
3. For cases, when a [2,7] error code is shown, check to see if the display cable is properly connected.
4. For cases when a [2,8] error code is shown, replace the system board.

LCD Built-in Self-Test (LCD-BIST)

Dell laptops have a built-in diagnostic tool that helps you determine if the screen abnormality you are experiencing is an inherent problem with the LCD (screen) of the Dell laptop or with the video card (GPU) and computer settings.

When you notice screen abnormalities like flickering, distortion, clarity issues, fuzzy or blurry image, horizontal or vertical lines, color fade, it is always a good practice to isolate the LCD (screen) by running the LCD-BIST.

How to invoke the LCD-BIST

1. Turn off your computer.
2. Disconnect any peripherals that are connected to the computer. Connect only the AC adapter (charger) to the computer.
3. Ensure that the LCD (screen) is clean (no dust particles on the surface of the screen).
4. Press and hold the **D** key and press the power button to enter LCD-BIST mode. Continue to hold the **D** key until the computer boots up.
5. The screen displays solid colors and changes colors on the entire screen to white, black, red, green, and blue twice.
6. Then it displays the colors white, black, and red.
7. Carefully inspect the screen for abnormalities (any lines, fuzzy color, or distortion on the screen).
8. At the end of the last solid color (red), the computer shuts down.

 **NOTE:** Dell SupportAssist Preboot diagnostics upon launch initiates an LCD-BIST first, expecting a user intervention to confirm functionality of the LCD.

System-diagnostic lights

This section lists the system-diagnostic lights of your Dell Pro Max 16 MC16250.

The following table shows different Service LED blinking patterns and associated problems. The diagnostic light codes consist of a two-digit number, and the digits are separated by a comma. The number stands for a blinking pattern; the first digit shows the number of blinks in amber color, and the second digit shows the number of blinks in white color. The Service LED blinks in the following manner:

- The Service LED blinks the number of times equal to the value of the first digit and turns off with a short pause.
- After that, the Service LED blinks the number of times equal to the value of the second digit.
- The Service LED turns off again with a longer pause.
- After the second pause, the blinking pattern will be repeated.

Table 57. Diagnostic light codes

Diagnostic light codes (Amber, White)	Problem description
1, 1	TPM detection failure
1, 2	Unrecoverable SPI Flash failure
1, 5	EC unable to program i-Fuse
1, 6	Generic catch-all for ungraceful EC code flow errors
1, 7	Non-RPMC Flash on Boot Guard fused system
1, 8	Chipset "Catastrophic Error" signal has tripped
2, 1	Processor configuration or processor failure
2, 2	System board: BIOS or Read-Only Memory (ROM) failure
2, 3	No memory or Random-Access Memory (RAM) detected
2, 4	Memory or Random-Access Memory (RAM) failure
2, 5	Invalid memory installed
2, 6	System board/chipset error
2, 7	Display failure SBIOS message
2, 8	Display power-rail failure on the system board
3, 1	CMOS battery failure
3, 2	PCI of Video card/chip failure
3, 3	Recovery image not found
3, 4	Recovery image found but invalid
3, 5	EC power-rail error
3, 6	Flash corruption detected by SBIOS
3, 7	Timeout waiting on ME to reply to HECI message
4, 1	Memory DIMM power rail failure
4, 2	Processor power cable connection issue
4, 3	Display panel failure (potentially cracked panel)
4, 4	Power rail failure at system board side
4, 5	Display panel failure and power rail failure at system board side
4, 6	Display cable failure

Recovering the operating system

When your computer is unable to boot to the operating system even after repeated attempts, it automatically starts Dell SupportAssist OS Recovery.

Dell SupportAssist OS Recovery is a stand-alone tool that is preinstalled on Dell computers running the Windows operating system. It consists of tools to diagnose and troubleshoot issues that may occur before your computer boots to the operating system. It enables you to diagnose hardware issues, repair your computer, back up your files, and restore your computer to its factory state.

You can also download it from the Dell Support website to troubleshoot and fix your computer when it fails to boot into the primary operating system due to software or hardware failures.

For more information about the Dell SupportAssist OS Recovery, see *Dell SupportAssist OS Recovery User's Guide* at [Serviceability Tools at the Dell Support Site](#). Click **SupportAssist** and then click **SupportAssist OS Recovery**.

 **NOTE:** Windows 11 IoT Enterprise LTSC 2024 and Dell ThinOS 10 do not support Dell SupportAssist. For more information about recovering ThinOS 10, see [Recovery mode using R-Key](#).

Real-Time Clock (RTC Reset)

The Real-Time Clock (RTC) reset function enables you or the service technician to recover Dell computers from No POST/No Power/No Boot situations.

Start the RTC reset with the computer powered off and connected to AC power. Press and hold the power button for twenty-five seconds. The computer RTC Reset occurs after you release the power button.

Backup media and recovery options

It is recommended to create a recovery drive to troubleshoot and fix problems that may occur with Windows. Dell provides multiple options for recovering the Windows operating system on your Dell computer. For more information, see [Dell Windows Backup Media and Recovery Options](#).

Network power cycle

About this task

If your computer is unable to access the Internet due to network connectivity issues, reset your network devices by performing the following steps:

Steps

1. Turn off the computer.
2. Turn off the modem.

 **NOTE:** Some Internet service providers (ISPs) provide a modem and router combo device.

3. Turn off the wireless router.
4. Wait for 30 seconds.
5. Turn on the wireless router.
6. Turn on the modem.
7. Turn on the computer.

Drain flea power (perform hard reset)

About this task

Flea power is the residual static electricity that remains in the computer even after it has been powered off and the battery is removed.

For your safety, and to protect the sensitive electronic components in your computer, you must drain residual flea power before removing or replacing any components in your computer.

Draining flea power, also known as performing a "hard reset," is also a common troubleshooting step if your computer does not turn on or boot into the operating system.

Perform the following steps to drain the flea power:

Steps

1. Turn off the computer.
2. Disconnect the power adapter from the computer.
3. Remove the base cover.
4. Remove the battery.

 **CAUTION:** The battery is a Field Replaceable Unit (FRU) and the removal and installation procedures are intended for authorized service technicians only.

5. Press and hold the power button for 20 seconds to drain the flea power.
6. Install the battery.
7. Install the base cover.
8. Connect the power adapter to the computer.
9. Turn on the computer.

 **NOTE:** For more information about performing a hard reset, go to [Dell Support Site](#). On the menu bar at the top of the Support page, select Support > Support Library. In the Search field on the Support Library page, type the keyword, topic, or model number, and then click or tap the search icon to view the related articles.

Getting help and contacting Dell

Self-help resources

You can get information and help on Dell products and services using these self-help resources:

Table 58. Self-help resources

Self-help resources	Resource location
Information about Dell products and services	Dell Site
Contact Support	In Windows search, type <code>Contact Support</code> , and press Enter.
Online help for operating system	Windows Support Site Linux Support Site
Access top solutions, diagnostics, drivers and downloads, and learn more about your computer through videos, manuals, and documents.	Your Dell computer is uniquely identified using a Service Tag or Express Service Code. To view relevant support resources for your Dell computer, enter the Service Tag or Express Service Code at Dell Support Site . For more information about how to find the Service Tag for your computer, see Locate the Service Tag on your computer .
Dell knowledge base articles	<ol style="list-style-type: none"> 1. Go to Dell Support Site. 2. On the menu bar at the top of the Support page, select Support > Support Library. 3. In the Search field on the Support Library page, type the keyword, topic, or model number, and then click or tap the search icon to view the related articles.

Contacting Dell

To contact Dell for sales, technical support, or customer service issues, see [Dell Support Site](#).

 **NOTE:** Availability of the services may vary depending on the country or region, and product.

 **NOTE:** If you do not have an active Internet connection, you can find contact information in your purchase invoice, packing slip, bill, or Dell product catalog.

Revision history

Tracks all updates that are made to the document. It typically includes the date of change, version number, and a brief description of the modification. This log helps maintain transparency, accountability, and a clear timeline of progress.

Table 59. Revision history

Revision	Date	Description
A00	03-27-2025	Original publish date.
A01	07-17-2025	Post RTS update: Added discrete graphics card details.
A02	09-08-2025	Updated the removal and installation topics of system board.