


Dell Pro 32 Plus QHD USB-C Hub Monitor P3225DE

Dell Pro 32 Plus 4K USB-C Hub Monitor P3225QE

User's Guide

Notes, cautions, and warnings

 **NOTE:** A NOTE indicates important information that helps you make better use of your product.

 **CAUTION:** A CAUTION indicates either potential damage to hardware or loss of data and tells you how to avoid the problem.

 **WARNING:** A WARNING indicates a potential for property damage, personal injury, or death.

Contents

Safety instructions	5
About your monitor	6
Package contents	6
Product features	7
Operating system compatibility	9
Identifying parts and controls	9
Front view	9
Back view	10
Bottom view (P3225DE)	11
Bottom view (P3225QE)	12
Dell Display and Peripheral Manager (DDPM) for Windows	12
Monitor specifications	13
Resolution specifications	14
Supported video modes	14
Preset display modes	14
DP Multi-Stream Transport (MST) modes (P3225DE only)	15
USB-C Multi-Stream Transport (MST) modes (P3225DE only)	15
Electrical specifications	16
Physical characteristics	16
Environmental characteristics	17
Pin assignments	18
Plug-and-play capability	24
LCD monitor quality and pixel policy	24
Ergonomics	25
Handling and moving your display	26
Maintenance guidelines	27
Cleaning your monitor	27
Setting up the monitor	28
Attaching the stand	28
Using the tilt, swivel, and height extension	30
Tilt and swivel adjustment	30
Height adjustment	30
Rotating the display	31
Adjusting the rotation display settings of your system	31
Organizing your cables	31
Connecting your monitor	32
Dell Power Button Sync (DPBS)	35
Connecting the monitor for DPBS for the first time	37
Using DPBS function	38
Connecting the monitor for USB-C Multi-Stream Transport (MST) function (P3225DE only)	39
Connecting the monitor for USB-C in DPBS mode	40
Securing your monitor using Kensington lock (optional)	42
Removing the monitor stand	42
VESA wall mounting (optional)	43
Operating the monitor	44
Turn on the monitor	44

Using the joystick control	44
Using the Menu Launcher	45
Using the navigation keys	46
Using the On-Screen Display (OSD) menu	47
Using the OSD lock function	54
Initial setup	57
OSD warning messages	57
Setting the maximum resolution	60
Troubleshooting	61
Self-test	61
Built-in diagnostics	61
Common problems	62
Product-specific problems	63
Regulatory information	65
TCO Certified	65
FCC notices (U.S. only) and other regulatory information	65
EU product database for energy label and product information sheet	65
Contacting Dell	66

Safety instructions

Use the following safety guidelines to protect your monitor from potential damage and to ensure your personal safety. Unless otherwise noted, each procedure in this document assumes that you have read the safety information that is shipped with your monitor.

NOTE: Before using the monitor, read the safety information that is shipped with your monitor and printed on the product. Keep the documentation at a secure location for future reference.

WARNING: Use of controls, adjustments, or procedures other than those specified in this documentation may result in exposure to shock, electrical hazards and/or mechanical hazards.

CAUTION: The possible long-term effect of listening to audio at high volume through the headphones (on monitor that support it) may damage your hearing ability.

- Place the monitor on a solid surface and handle it carefully.
 - The screen is fragile and can be damaged if dropped or hit with a sharp object.
 - Ensure that your monitor is electrically rated to operate with the AC power available in your location.
 - Keep the monitor in room temperature. Excessive cold or hot conditions can have an adverse effect on the liquid crystal of the display.
 - Connect the power cable from the monitor to a wall outlet that is near and accessible. See [Connecting your monitor](#).
- Do not place and use the monitor on a wet surface or near water.
- Do not subject the monitor to severe vibration or high impact conditions. For example, do not place the monitor inside a car trunk.
- Unplug the monitor when it is going to be left unused for an extended period.
- To avoid electric shock, do not attempt to remove any cover or touch the inside of the monitor.
- Read these instructions carefully. Keep this document for future reference. Follow all warnings and instructions marked on the product.
- Certain monitors can be wall mounted using the VESA mount that is sold separately. Ensure to use the correct VESA specifications as mentioned in the wall mounting section of the User's Guide.

For information about safety instructions, see the Safety, Environmental, and Regulatory Information (SERI) document that is shipped with your monitor.



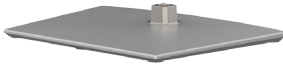






About your monitor

Package contents

The following table provides the list of components that are shipped with your monitor. If any component is missing, contact Dell. For more information, see [Contacting Dell](#).

NOTE: Some items may be optional and may not ship with your monitor. Some features may not be available in certain countries.

Table 1. Monitor components and descriptions.

Component image	Component description
	Monitor
	Stand riser
	Stand base
	Power cable (varies by country)
	DisplayPort 1.4 cable (1.80 m) (DisplayPort to DisplayPort)
	USB Type-C to Type-A 5Gbps 15W cable (1.80 m)
	USB-C to C 10Gbps 100 W cable (1.0 m)
	Cable tie
	<ul style="list-style-type: none"> • QR Card • Safety, Environmental, and Regulatory Information

Product features

The **Dell P3225DE/P3225QE** monitor has an active matrix, Thin-Film Transistor (TFT), Liquid Crystal Display (LCD), anti-static and LED backlight. The monitor has the following features:

- **P3225DE:** 801.0 mm (31.5 in.) active area display (measured diagonally) with a 2560 x 1440 (16:9) resolution, plus full-screen support for lower resolutions.
- **P3225QE:** 800.1 mm (31.5 in.) active area display (measured diagonally) with a 3840 x 2160 (16:9) resolution, plus full-screen support for lower resolutions.
- Wide-viewing angles with 99% sRGB color.
- Tilt, swivel, pivot, and height adjustment capabilities.
- Removable pedestal stand and Video Electronics Standards Association (VESA) 100 mm mounting holes for flexible mounting solutions.
- Ultra-thin bezel minimizes the bezel gap during multi-monitor usage, enabling easier setup with an elegant viewing experience.
- Extensive digital connectivity with DP and HDMI helps future-proof your monitor.
- Plug-and-play capability (if supported by your computer).
- On-Screen Display (OSD) adjustments for ease of setup and screen optimization.
- Power and OSD buttons lock.
- Security lock slot.
- ≤ 0.3 W in Off Mode.
- The Monitor is designed with a Dell Power Button Sync (DPBS) feature to control computer system power state from the monitor power button.*

* For Dell systems that support this feature.

- Premium Panel Exchange for peace of mind.
- Optimize eye comfort with a flicker-free screen and low blue light feature to minimize hazard of blue light emission.
- Dell ComfortView Plus is an integrated low blue light screen feature that improves eye comfort by reducing potentially harmful blue light emissions without compromising color. Through ComfortView Plus technology, Dell has reduced harmful blue light exposure from $\leq 50\%$ to $\leq 35\%$. This monitor is certified with TÜV Rheinland Eye Comfort 3.0 with a 4-star rating. It incorporates key technologies that also deliver a flicker-free screen, up to 100 Hz refresh rate, a color gamut of minimum 99% sRGB, color accuracy, and ambient light sensor performance. Dell ComfortView Plus feature is enabled by default on your monitor.
- This monitor uses a low blue light panel. When the monitor is reset to factory settings or default setting, it is in compliance with TÜV Rheinland's hardware low blue light certification.**

Blue light ratio:

The ratio of light in the range from 415 nm–455 nm compared to 400 nm–500 nm is less than 50%.

Table 2. Blue light ratio

Category	Blue light ratio
1	$\leq 20\%$
2	$20\% < R \leq 35\%$
3	$35\% < R \leq 50\%$

- Decreases the level of hazard blue light emitted from the screen to make viewing more comfortable for your eyes without distortion of color accuracy.
- The monitor adopts Flicker-Free technology, which clears the eye visible flicker, brings comfort viewing experience and preventing users suffer from eye strain and fatigue.

** This monitor is in compliance with TÜV Rheinland hardware low blue light certification under Category 2.

About TÜV Rheinland Eye Comfort 3.0

TÜV Rheinland Eye Comfort 3.0 certification program presents a consumer-friendly star rating scheme to the display industry promoting eye wellness from safety to eye care. Compared to existing certifications, the 5-star-rating program adds rigorous testing requirements on overall eye care attributes such as low blue-light, flicker-free, refresh rate, color gamut, color accuracy and ambient light sensor performance. It lays out requirement metrics and rates the product performance on five levels, and the sophisticated technical assessment process provides consumers and buyers with indicators that are easier to judge.

The eye wellness factors being considered remain constant, however, the standards for the various star ratings are different. The higher the star rating, the more stringent the standards. The table below lists the major eye comfort requirements which apply in addition to the basic eye comfort requirements (such as pixel density, uniformity of luminance and color, and freedom of movement).

For more information around **TÜV Eye Comfort certification** see:

<https://www.tuv.com/world/en/eye-comfort.html>



Table 3. Eye Comfort 3.0 Requirements

Eye Comfort 3.0 Requirements and Star Rating Scheme for Monitors				
Category	Test item	Star Rating Scheme		
		3-star	4-star	5-star
Eye Care	Low Blue Light	TÜV Hardware LBL Category III ($\leq 50\%$) or Software LBL solution ¹	TÜV Hardware LBL Category II ($\leq 35\%$) or Category I ($\leq 20\%$)	TÜV Hardware LBL Category II ($\leq 35\%$) or Category I ($\leq 20\%$)
	Flicker Free	TÜV Flicker Reduced or TÜV Flicker Free	TÜV Flicker Reduced or TÜV Flicker Free	Flicker Free
Ambient Light Management	Ambient Light Sensor performance	No sensor	No sensor	Ambient light sensor
	Intelligent CCT control	No	No	Yes
	Intelligent Luminance control	No	No	Yes
Image quality	Refresh Rate	≥ 60 Hz	≥ 75 Hz	≥ 120 Hz
	Luminance uniformity	Luminance uniformity $\geq 75\%$		
	Color Uniformity	Color uniformity $\Delta u'v' \leq 0.02$		
	Freedom of movement	Luminance changes shall decrease less than 50%; The colour shift is less than 0.01		
	Gamma difference	Gamma difference $\leq \pm 0.2$	Gamma difference $\leq \pm 0.2$	Gamma difference $\leq \pm 0.2$
	Wide color gamut ²	NTSC ³ Min.72% (CIE 1931) or sRGB ⁴ Min 95% (CIE 1931)	sRGB ⁴ Min.95% (CIE 1931)	DCI-P3 ⁵ Min. 95% (CIE 1976) & sRGB ⁴ Min.95% (CIE 1931) or Adobe RGB ⁶ Min.95% (CIE 1931) & sRGB ⁴ Min.95% (CIE 1931)
Eye Comfort User Guide	User guide	Yes	Yes	Yes
Remark	¹ Software controls the blue light emission by reducing excessive blue light, resulting in a more yellow tone. ² Color gamut describes the availability of colors in the display. Various standards were developed for specific purposes. 100% corresponds to the full color space as defined in the standard. ³ NTSC stands for National Television Standards Committee, which developed a color space for the television system that is used in the United States. ⁴ sRGB is a standard red, green, and blue color space that is in use on monitors, printers, and the World Wide Web. ⁵ DCI-P3, short for Digital Cinema Initiatives - Protocol 3, is a color space used in digital cinema that encompasses a wider range of colors than the standard RGB color space. ⁶ Adobe RGB is a color space created by Adobe Systems that encompasses a broader range of colors than the standard RGB color model, particularly in the cyans and greens.			

Operating system compatibility

- Windows 10 and later*
- macOS 12* and macOS 13*

*The operating system compatibility on Dell branded monitors may vary based on factors such as:

- Specific release date(s) when operating system versions, patches, or updates are available.
- Specific release date(s) when Dell branded monitor firmware, software application, or driver updates are available on the Dell support website.

Identifying parts and controls

Front view

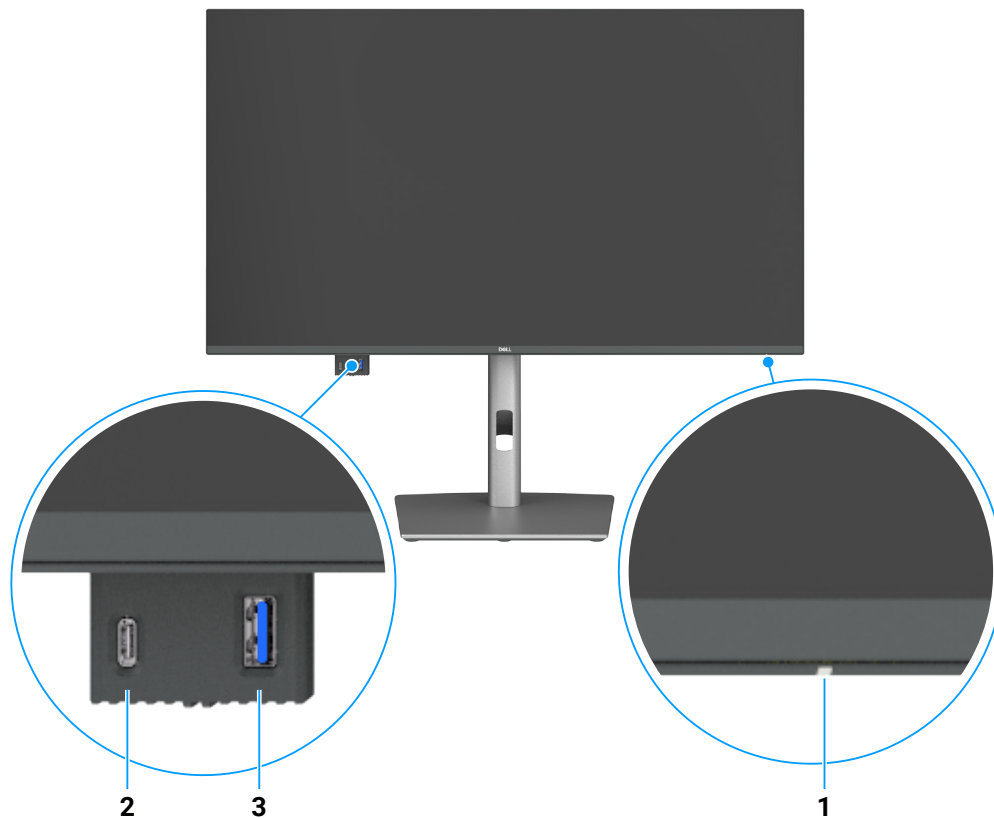


Figure 1. Front view of the monitor

Table 4. Components and descriptions.

Label	Description	Function
1	Power LED indicator	Solid white light indicates the monitor is turned on and functioning normally. Blinking white light indicates the monitor is in Standby Mode.
2	USB-C 5Gbps downstream port	Connect your USB device. The USB-C port supports 5 V/3 A.
3	USB 5Gbps Type-A downstream port	Connect your USB device. The USB Type-A port supports 5 V/0.9 A.

NOTE: You can use this port only after you have connected the USB Type-C to Type-A or USB-C to C cable to the USB-C upstream port at the rear of the monitor to the computer.

Back view

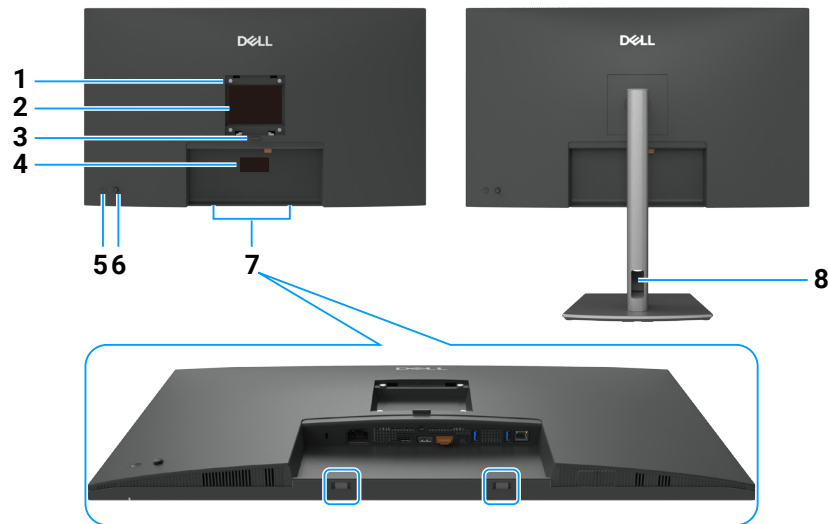


Figure 2. Back view of the monitor

Table 5. Components and descriptions.

Label	Description	Function
1	VESA mounting holes (100 mm x 100 mm-behind attached VESA cover)	Wall mount monitor using VESA-compatible wall mount kit.
2	Regulatory information label	Lists the regulatory approvals.
3	Stand release button	Releases the stand from the monitor.
4	Regulatory label (including Mac address, Barcode, serial number, and Service Tag label)	Refer to this label if you need to contact Dell for technical support. The Service Tag is a unique alphanumeric identifier that enables Dell service technicians to identify the hardware components in your computer and access warranty information.
5	Power On/Off button	To turn the monitor on or off.
6	Joystick	Use it to control the OSD menu. For more information, see Operating the monitor .
7	Dell soundbar mounting slots	Attaches the optional Dell soundbar.
8	Cable-management slot	Use to organize cables by routing them through the slot.

Bottom view (P3225DE)

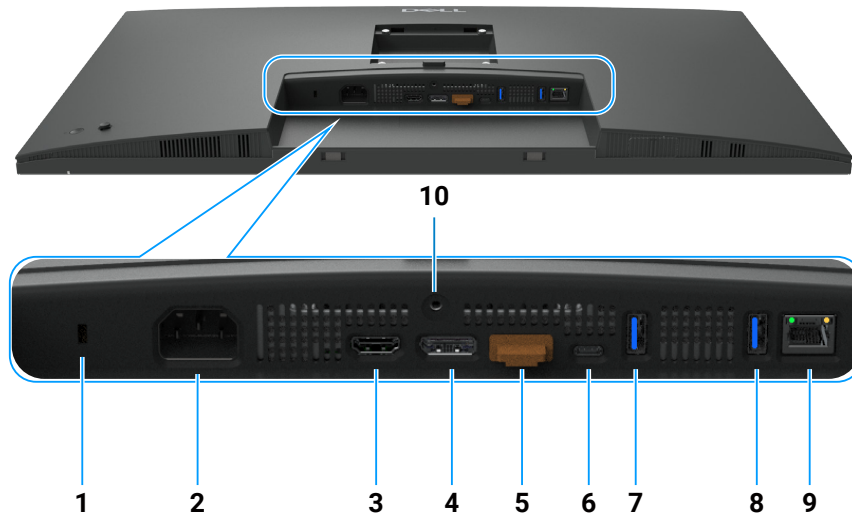









Figure 3. Bottom view of the monitor

Table 6. Components and descriptions.

Label	Description	Function
1	Security lock slot	Secures the monitor with a security cable lock (sold separately).
2	 Power connector	Connects the power cable.
3	 HDMI port	Connects your computer with the HDMI cable.
4	 DisplayPort (in)	Connects your computer with the DisplayPort cable.
5	 DisplayPort (out)	DP output for MST (Multi-Stream Transport) capable monitor. To enable MST, see the instruction on section Connecting the monitor for DP MST function . NOTE: Remove the rubber plug when using DP out connector.
6	 USB-C 5Gbps upstream port (Video + Data)	Connect to your computer using the USB-C cable. The USB-C port offers the fastest transfer rate and the alternate mode with a DP 1.4 support with a maximum resolution of 2560 x 1440 at 100 Hz, PD 20 V/4.5 A, 15 V/3 A, 9 V/3 A, 5 V/3 A. NOTE: USB-C is not supported on Windows versions older than Windows 10.
7,8	 Two USB 5Gbps Type-A downstream ports	Connect your USB device. You can use these ports only after you have connected the USB cable from the computer to the monitor. NOTE: To avoid signal interference, when a wireless USB device has been connected to a USB downstream port, it is NOT recommended to connect any other USB devices to the adjacent port(s).
9	 RJ45 connector	Connect Internet. You can surf the Internet using RJ45 only after you have connected the USB Type-C to Type-A or USB-C to C cable from the computer to the monitor.
10	Stand lock	Lock the stand to the monitor using a M3 x 6 mm screw (screw not included).

Bottom view (P3225QE)

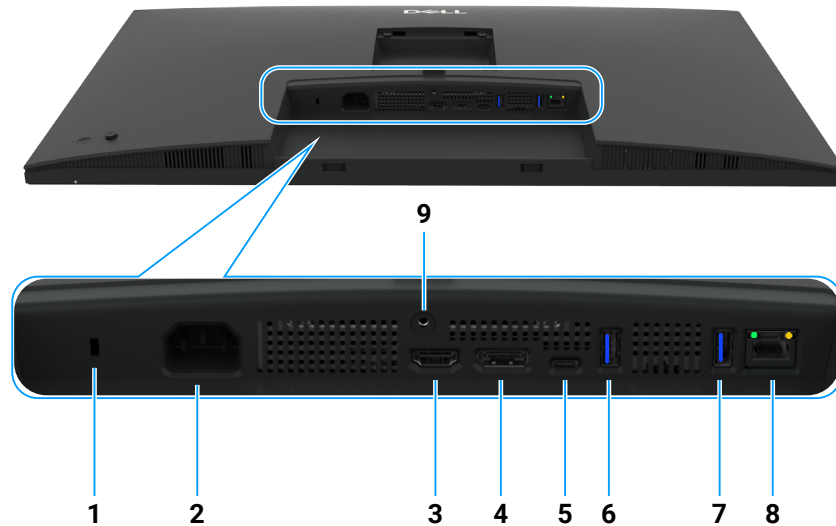








Figure 4. Bottom view of the monitor

Table 7. Components and descriptions.

Label	Description	Function
1	Security lock slot	Secures the monitor with a security cable lock (sold separately).
2	 Power connector	Connects the power cable.
3	 HDMI port	Connects your computer with the HDMI cable.
4	 DisplayPort (in)	Connects your computer with the DisplayPort cable.
5	 USB-C 5Gbps upstream port (Video + Data)	Connect to your computer using the USB-C cable. The USB-C port offers the fastest transfer rate and the alternate mode with a DP 1.4 support with a maximum resolution of 3840 x 2160 at 100 Hz, PD 20 V/4.5 A, 15 V/3 A, 9 V/3 A, 5 V/3 A. NOTE: USB-C is not supported on Windows versions older than Windows 10.
6,7	 Two USB 5Gbps Type-A downstream ports	Connect your USB device. You can use these ports only after you have connected the USB cable from the computer to the monitor. NOTE: To avoid signal interference, when a wireless USB device has been connected to a USB downstream port, it is NOT recommended to connect any other USB devices to the adjacent port(s).
8	 RJ45 connector	Connect Internet. You can surf the Internet using RJ45 only after you have connected the USB Type-C to Type-A or USB-C to C cable from the computer to the monitor.
9	Stand lock	Lock the stand to the monitor using a M3 x 6 mm screw (screw not included).

Dell Display and Peripheral Manager (DDPM) for Windows

DDPM is a software application that helps you set up and configure the Dell monitors and peripherals. Some of its features include:

1. Adjusting the monitor On-Screen Display (OSD) settings such as brightness, contrast, and resolution without needing to use the joystick on the monitor.
2. Arrange multiple applications on your screen by placing them into a template of your choice using Easy Arrange.
3. Assign applications or files to the partitions of Easy Arrange, save the layout as a profile, and restore the profile automatically with Easy Arrange Memory when needed.
4. Connect the Dell Monitor to multiple input sources and manage these video inputs using the Input Source feature.
5. Customize each application with its own distinct color mode using the Color Preset feature.
6. Replicate software application settings from one monitor to another identical monitor using the Import/Export application settings feature.
7. Receive notifications and update the firmware and software.

8. A macOS version of DDPM software is also available for your monitor. For the list of displays that support DDPM macOS version, see the knowledge base article 000201067 at <https://www.dell.com/support>.

① **NOTE:** Some features of the DDPM mentioned above are available only on select monitor models. For more information about DDPM, and the recommended computer configuration to install it, go to <https://www.dell.com/support/ddpm>.

Monitor specifications

Table 8. Monitor specifications.

Description	Value (P3225DE)	Value (P3225QE)
Screen type	Active matrix-TFT LCD	
Panel technology	In-Plane Switching (IPS) Technology	
Aspect ratio	16:9	
Viewable image dimensions		
Diagonal	801.0 mm (31.5 in.)	800.1 mm (31.5 in.)
Active Area		
Horizontal	698.11 mm (27.48 in.)	697.31 mm (27.45 in.)
Vertical	392.69 mm (15.46 in.)	392.23 mm (15.44 in.)
Area	274140.82 mm ² (424.92 in. ²)	273505.90 mm ² (423.94 in. ²)
Pixel pitch		
Horizontal	0.2727 mm	0.1816 mm
Vertical	0.2727 mm	0.1816 mm
Pixel per inch (PPI)	93	140
Viewing angle		
Horizontal	178° (typical)	
Vertical	178° (typical)	
Brightness	350 cd/m ² (typical)	
Contrast ratio	1500:1 (typical)	
Display screen coating	Anti-glare with hard-coating 3H	
Backlight	LED Edgelight System	
Response Time	5 ms (fast mode)	
(Gray to Gray)	8 ms (normal mode)	
Color depth	1.07 billion colors	
Color gamut	sRGB 99% (CIE 1931) (typical)	
Connectivity	<p>Video port</p> <ul style="list-style-type: none"> One HDMI port (HDCP 1.4) (Supports up to QHD 2560 x 1440 100 Hz as per specified in HDMI 2.1TMDS) One DisplayPort 1.4 (HDCP 1.4) (Supports up to QHD 2560 x 1440, 100 Hz) One DisplayPort Output 1.4 (HDCP 1.4) (Supports up to QHD 2560 x 1440, 100 Hz) <p>USB port</p> <ul style="list-style-type: none"> Two USB 5Gbps Type-A downstream ports One USB-C 5Gbps upstream port (DisplayPort 1.4 Alt Mode, Power Delivery up to 90W) One RJ45 <p>Quick Access:</p> <ul style="list-style-type: none"> One USB 5Gbps Type-A downstream port One USB-C 5Gbps downstream port (Data only, Power Delivery up to 15W) 	<p>Video port</p> <ul style="list-style-type: none"> One HDMI port (HDCP 2.2) (Supports up to UHD 3840 x 2160 100 Hz as per specified in HDMI 2.1FRL) One DisplayPort 1.4 (HDCP 2.2) (Supports up to UHD 3840 x 2160, 100 Hz) <p>USB port</p> <ul style="list-style-type: none"> Two USB 5Gbps Type-A downstream ports One USB-C 5Gbps upstream port (DisplayPort 1.4 Alt Mode, Power Delivery up to 90W) One RJ45 <p>Quick Access:</p> <ul style="list-style-type: none"> One USB 5Gbps Type-A downstream port One USB-C 5Gbps downstream port (Data only, Power Delivery up to 15W)
Border width (edge of monitor to active area)		
Top	7.45 mm (0.29 in.)	7.88 mm (0.31 in.)
Left/Right	7.64 mm (0.30 in.)	8.05 mm (0.32 in.)
Bottom	13.01 mm (0.51 in.)	13.03 mm (0.51 in.)
Adjustability		
Height adjustable stand	150.00 mm (5.91 in.)	
Tilt	-5° to 21°	

Description	Value (P3225DE)	Value (P3225QE)
Swivel	-30° to 30°	
Pivot	-90° to 90°	
Cable management	Yes	
Dell Display and Peripheral Manager (DDPM) Compatibility	Easy Arrange and other key features	
Security	Security lock slot (cable lock sold separately)	

Resolution specifications

Table 9. Resolution specifications.

Description	P3225DE	P3225QE
Horizontal frequency	30 kHz to 151 kHz	30 kHz to 230 kHz
Vertical refresh rate	48 Hz to 100 Hz	48 Hz to 100 Hz
Default preset resolution	2560 x 1440 at 60 Hz	3840 x 2160 at 60 Hz
Maximum preset resolution	2560 x 1440 at 100 Hz	3840 x 2160 at 100 Hz

Supported video modes

Table 10. Supported video modes.

Description	P3225DE	P3225QE
Video display capabilities (HDMI, DP, and USB-C alternate mode)	480p, 576p, 720p, 1080p	480p, 576p, 720p, 1080p

Preset display modes

Table 11. Preset display modes (P3225DE)

Display mode	Horizontal frequency (kHz)	Vertical frequency (Hz)	Pixel clock (MHz)	Sync polarity (Horizontal/Vertical)
IBM, 720 x 400	31.47	70.08	28.32	-/+
VESA, 640 x 480	31.47	59.94	25.18	-/-
VESA, 640 x 480	37.50	75.00	31.50	-/-
VESA, 800 x 600	37.88	60.32	40.00	+/+
VESA, 800 x 600	46.88	75.00	49.50	+/+
VESA, 1024 x 768	48.36	60.00	65.00	-/-
VESA, 1024 x 768	60.02	75.03	78.75	+/+
VESA, 1152 x 864	67.50	75.00	108.00	+/+
VESA, 1280 x 1024	63.98	60.02	108.00	+/+
VESA, 1280 x 1024	79.98	75.02	135.00	+/+
VESA, 1600 x 1200	75.00	60.00	162.00	+/+
CTA, 1920 x 1080	67.50	60.00	148.50	+/+
CVR, 2560 x 1440	88.79	59.95	241.50	+/-
QHD 2560 x 1440	150.919	99.946	410.50	-/+

Table 12. Preset display modes (P3225QE)

Display mode	Horizontal frequency (kHz)	Vertical frequency (Hz)	Pixel clock (MHz)	Sync polarity (Horizontal/Vertical)
IBM, 720 x 400	31.47	70.08	28.32	-/+
VESA, 640 x 480	31.47	59.94	25.18	-/-
VESA, 640 x 480	37.50	75.00	31.50	-/-
VESA, 800 x 600	37.88	60.32	40.00	+/+
VESA, 800 x 600	46.88	75.00	49.50	+/+
VESA, 1024 x 768	48.36	60.00	65.00	-/-
VESA, 1024 x 768	60.02	75.03	78.75	+/+
VESA, 1152 x 864	67.50	75.00	108.00	+/+
VESA, 1280 x 1024	63.98	60.02	108.00	+/+
VESA, 1280 x 1024	79.98	75.02	135.00	+/+
VESA, 1600 x 1200	75.00	60.00	162.00	+/+
CTA, 1920 x 1080	67.50	60.00	148.50	+/+
CVR, 2560 x 1440	88.79	59.95	241.50	+/-
CVT, 1280 x 800	49.70	59.81	83.50	+/-
CVT, 1600 x 900	55.54	60.00	97.75	+/-
CVT, 1920 x 1200	61.418	60.00	127.75	+/+
CVT, 3840 x 2160	133.31	60.00	533.25	+/-
CVT, 3840 x 2160	226.50	100	906	+/-

DP Multi-Stream Transport (MST) modes (P3225DE only)**Table 13. DP Multi-Stream Transport (MST) modes.**

Description	Value	
MST source monitor	Maximum number of external monitors that can be supported	
	2560 x 1440 at 100 Hz	
	8 bit	10 bit
HBR3	2	2
HBR2	1	1
HBR3 (DSC)	4	4
HBR2 (DSC)	4	4

NOTE: The maximum external monitor resolution supported is 2560 x 1440 at 100 Hz only.

USB-C Multi-Stream Transport (MST) modes (P3225DE only)**Table 14. USB-C Multi-Stream Transport (MST) modes.**

Description	Value	
MST source monitor	Maximum number of external monitors that can be supported.	
	2560 x 1440 at 100 Hz	
	8 bit	10 bit
HBR3 (High Resolution)	2	2
HBR3 (High Data Speed)	1	1
HBR2 (High Resolution)	1	1
HBR2 (High Data Speed)	0	0
HBR3 (High Resolution) DSC	4	4
HBR3 (High Data Speed) DSC	3	3
HBR2 (High Resolution) DSC	4	4
HBR2 (High Data Speed) DSC	2	2

Electrical specifications

Table 15. Electrical specifications.

Description	P3225DE	P3225QE
Video input signals	Digital video signal for each differential line per differential line at 100 ohm impedance DP/HDMI/USB-C signal input support	
Input voltage/frequency/current	100-240 VAC/50 Hz or 60 Hz \pm 3 Hz/2.8 A (typical)	
Inrush current	120 V: 42 A (maximum) 240 V: 80 A (maximum) Inrush current is measured at an ambient temperature of 0°C (cold start).	
Power consumption	0.3 W (Off Mode) ¹ 0.4 W (Standby Mode) ¹ 0.8 W (Networked standby Mode) ¹ 23.1 W (On Mode) ¹ 192 W (maximum) ² 20.8 W (P _{on}) ³ 66.5 kWh (TEC) ³	0.3 W (Off Mode) ¹ 0.4 W (Standby Mode) ¹ 0.8 W (Networked standby Mode) ¹ 27.8 W (On Mode) ¹ 205 W (maximum) ² 25.2 W (P _{on}) ³ 81 kWh (TEC) ³


¹ As defined in EU 2019/2021 and EU 2019/2013.

² Maximum brightness and contrast setting with maximum power loading on all USB ports.

³ P_{on}: Power consumption of On Mode as defined in Energy Star 8.0 version.

TEC: Total energy consumption in kWh as defined in Energy star 8.0 version.

This document is informational only and reflects laboratory performance. Your product may perform differently, depending on the software, components, and peripherals you have ordered and Dell has no obligation to update such information. Accordingly, the customer should not rely upon this information in making decisions about electrical tolerances or otherwise. No warranty as to accuracy or completeness is expressed or implied.

 **NOTE:** This monitor is ENERGY STAR certified.

This product qualifies for ENERGY STAR in the factory default settings which can be restored by Factory Reset function in the OSD menu. Changing the factory default settings or enabling other features may increase power consumption that could exceed the ENERGY STAR specified limit.

Physical characteristics

Table 16. Physical characteristics.

Description	P3225DE	P3225QE
Signal cable type	DP to DP cable (1.80 m) USB-C to C 10Gbps 100 W cable (1.0 m) USB Type-C to Type-A 5Gbps 15W cable (1.80 m)	
Dimensions (with stand)		
Height (extended)	619.00 mm (24.37 in.)	619.00 mm (24.37 in.)
Height (compressed)	469.00 mm (18.46 in.)	469.00 mm (18.46 in.)
Width	713.40 mm (28.09 in.)	713.40 mm (28.09 in.)
Depth	215.00 mm (8.46 in.)	215.00 mm (8.46 in.)
Dimensions (without stand)		
Height	413.15 mm (16.27 in.)	413.15 mm (16.27 in.)
Width	713.40 mm (28.09 in.)	713.40 mm (28.09 in.)
Depth	49.95 mm (1.97 in.)	49.95 mm (1.97 in.)
Stand dimensions		
Height (extended)	483.30 mm (19.03 in.)	483.30 mm (19.03 in.)
Height (compressed)	436.42 mm (17.18 in.)	436.42 mm (17.18 in.)
Width	287.50 mm (11.32 in.)	287.50 mm (11.32 in.)
Depth	215.00 mm (8.46 in.)	215.00 mm (8.46 in.)
Base	287.50 mm x 215.00 mm (11.32 in. x 8.46 in.)	287.50 mm x 215.00 mm (11.32 in. x 8.46 in.)
Weight		
Weight with packaging	12.90 kg (28.44 lb)	12.94 kg (28.53 lb)

Description	P3225DE	P3225QE
Weight with stand assembly and cables	9.49 kg (20.92 lb)	9.52 kg (20.99 lb)
Weight without stand assembly (For wall mount or VESA mount considerations - no cables)	6.63 kg (14.62 lb)	6.65 kg (14.66 lb)
Weight of stand assembly	2.51 kg (5.53 lb)	2.51 kg (5.53 lb)

Environmental characteristics

Table 17. Environmental characteristics.

Description	P3225DE	P3225QE
Compliant standards	<ul style="list-style-type: none"> ENERGY STAR certified monitor EPEAT registered where applicable. EPEAT registration varies by country. See EPEAT for registration status by country. TCO Certified & TCO Certified Edge. RoHS Compliant. BFR/PVC Free monitor (excluding external cables). Arsenic-Free glass and Mercury-Free for the panel only. 	
Temperature		
Operating	0°C to 40°C (32°F to 104°F)	
Non-operating	-20°C to 60°C (-4°F to 140°F)	
Humidity		
Operating	10% to 80% (non-condensing)	
Non-operating	5% to 90% (non-condensing)	
Altitude		
Operating	5,000 m (16,404 ft) (maximum)	
Non-operating	12,192 m (40,000 ft) (maximum)	
Thermal dissipation	655.13 BTU/hour (maximum) 78.8 BTU/hour (on mode)	699.49 BTU/hour (maximum) 94.9 BTU/hour (on mode)

Pin assignments

DisplayPort (in)

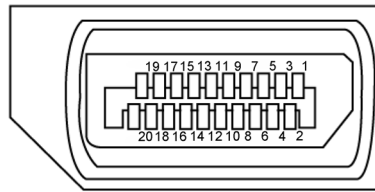


Figure 5. DisplayPort (in)

Table 18. DisplayPort (in).

Pin number	20-pin side of the connected signal cable
1	ML3(n)
2	GND
3	ML3(p)
4	ML2(n)
5	GND
6	ML2(p)
7	ML1(n)
8	GND
9	ML1(p)
10	ML0(n)
11	GND
12	ML0(p)
13	CONFIG1
14	CONFIG2
15	AUX CH (p)
16	GND
17	AUX CH (n)
18	Hot Plug Detect
19	Return
20	DP_PWR

DisplayPort (out) (P3225DE only)

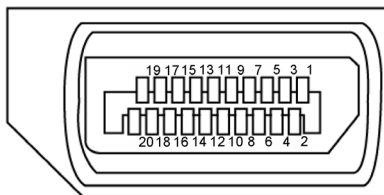


Figure 6. DisplayPort (out)

Table 19. DisplayPort (out)

Pin number	20-pin side of the connected signal cable
1	ML0(p)
2	GND
3	ML0(n)
4	ML1(p)
5	GND
6	ML1(n)
7	ML2(p)
8	GND
9	ML2(n)
10	ML3(p)
11	GND
12	ML3(n)
13	CONFIG1
14	CONFIG2
15	AUX CH(p)
16	GND
17	AUX CH(n)
18	Hot Plug Detect
19	Return
20	DP_PWR

HDMI port

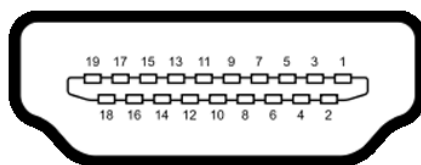


Figure 7. HDMI port

Table 20. HDMI port

Pin number	19-pin side of the connected signal cable
1	TMDS DATA 2+
2	TMDS DATA 2 SHIELD
3	TMDS DATA 2-
4	TMDS DATA 1+
5	TMDS DATA 1 SHIELD
6	TMDS DATA 1-
7	TMDS DATA 0+
8	TMDS DATA 0 SHIELD
9	TMDS DATA 0-
10	TMDS CLOCK+
11	TMDS CLOCK SHIELD
12	TMDS CLOCK-
13	CEC
14	Reserved (N.C. on device)
15	DDC CLOCK (SCL)
16	DDC DATA (SDA)
17	DDC/CEC Ground
18	+5 V POWER
19	HOT PLUG DETECT

USB-C port

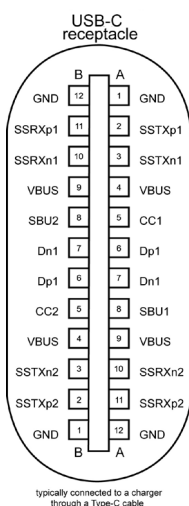



Figure 8. USB-C port

Table 21. USB-C port

Pin	Signal	Pin	Signal
A1	GND	B12	GND
A2	SSTXp1	B11	SSRXp1
A3	SSTXn1	B10	SSRXn1
A4	VBUS	B9	VBUS
A5	CC1	B8	SBU2
A6	Dp1	B7	Dn1
A7	Dn1	B6	Dp1
A8	SBU1	B5	CC2
A9	VBUS	B4	VBUS
A10	SSRXn2	B3	SSTXn2
A11	SSRXp2	B2	SSTXp2
A12	GND	B1	GND

Universal Serial Bus (USB)

This section provides information about the USB ports available on your display.

NOTE: Up to 3 A on USB-C downstream port (port with  icon) with 5 V/3 A compliance devices. Up to 0.9 A on the other USB downstream ports.

Your monitor has the following USB ports:

- One upstream port - One USB-C at rear
- Four downstream ports - Two USB Type-A at rear, one USB-C, and one USB Type-A at bottom

NOTE: The monitor's USB ports work only when the monitor is On or in the Standby Mode. If you turn off the monitor and then turn it on, the attached peripherals may take a few seconds to resume normal functionality.

Table 22. Transfer speed, data rate and common power consumption of USB ports.

Transfer speed	Data rate	Common power consumption (each port)
USB 5Gbps	5Gbps	4.5 W
USB 2.0*	480 Mbps	2.5 W
USB 1.0*	12 Mbps	2.5 W

* Device speed when High Resolution is selected.

Table 23. Pin number and signal name of USB Type-A 5Gbps downstream ports.

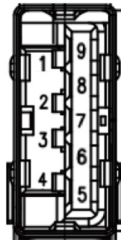


Figure 9. USB 5Gbps Type-A downstream port (bottom)

Pin number	Signal name
1	VBUS
2	D-
3	D+
4	GND
5	StdA_SSRX-
6	StdA_SSRX+
7	GND_DRAIN
8	StdA_SSTX-
9	StdA_SSTX+
Shell	Shield

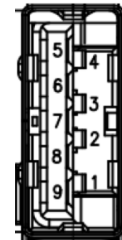


Figure 10. USB 5Gbps Type-A downstream port (rear)

Pin number	Signal name
1	VBUS
2	D-
3	D+
4	GND
5	StdA_SSRX-
6	StdA_SSRX+
7	GND_DRAIN
8	StdA_SSTX-
9	StdA_SSTX+
Shell	Shield

RJ45 Port (connector side)

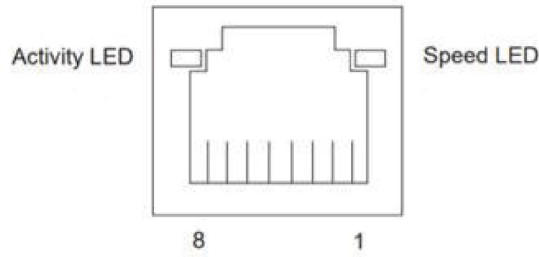


Figure 11. RJ45 Port (connector side)

Table 24. RJ45 Port (connector side).

Pin No.	10BASE-T 100BASE-T	1000BASE-T
1	Transmit+	BI_DA+
2	Transmit-	BI_DA-
3	Receive+	BI_DB+
4	Unused	BI_DC+
5	Unused	BI_DC-
6	Receive-	BI_DB-
7	Unused	BI_DD+
8	Unused	BI_DD-

Driver installation

Install the Realtek USB GBE Ethernet Controller Driver available for your system. You can download the driver from **Drivers & Diagnostics** on [Dell Support Site](#).

Network (RJ45) data rate using USB-C maximum speed is 1000 Mbps.

Table 25. Wake-on-LAN behavior.

Computer power save state	System behavior after receiving Wake-on-LAN (WOL) command
Modern Standby (S0ix)	The computer and monitor remain in Standby mode but the network communication is enabled.
Standby/Sleep (S3)	Both computer and monitor are turned on.
Hibernate (S4)	Both computer and monitor are turned on.
OFF/Shutdown (S5)	Both computer and monitor are turned on.

- ① **NOTE:** The computer BIOS must be configured to enable WOL function first.
- ① **NOTE:** This LAN port is 1000Base-T IEEE 802.3az compliant, supporting Mac Address (Printed on model label) Pass-Through (MAPT), Wake-on-LAN (WOL) from standby mode (S3), and UEFI* PXE Boot function. UEFI PXE Boot is not supported on Dell desktop computers except for OptiPlex 7090/3090 Ultra desktop. These three features depend on BIOS settings and operating system versions. The functionality may vary with non-Dell computers.
*UEFI stands for Unified Extensible Firmware Interface.
- ① **NOTE:** WOL S4 and WOL S5 are only capable with Dell systems that support DPBS and are with USB-C (MFDP) interface connection. Ensure DPBS function is enabled on both the computer and monitor.
- ① **NOTE:** For any issues related to WOL, the users have to debug the computer without a monitor. After the problem is solved, then connect to the monitor.

RJ45 connector LED status:

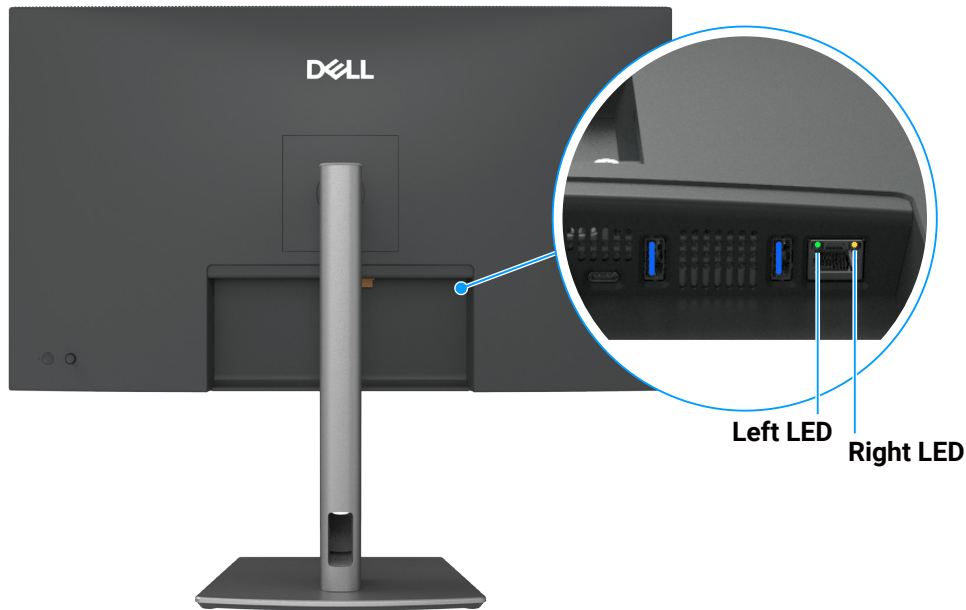


Figure 12. RJ45 LED color

Table 26. RJ45 LED color.

LED	Color	Description
Right LED	Amber or Green	Speed indicator: <ul style="list-style-type: none">• Amber On - 1000 Mbps• Green On - 100 Mbps• Off - 10 Mbps
Left LED	Green	Link/Activity indicator: <ul style="list-style-type: none">• Blinking - Activity on the port.• Green On - Link is being established.• Off - Link is not established.

NOTE: RJ45 cable is not a standard in-box accessory.

Plug-and-play capability

You can connect the monitor to any Plug and Play-compatible system. The monitor automatically provides the computer with its Extended Display Identification Data (EDID) using Display Data Channel (DDC) protocols so that the computer can configure itself and optimize the monitor settings. Most monitor installations are automatic; you can select different settings as required. For more information about changing the monitor settings, see [Operating the monitor](#).

LCD monitor quality and pixel policy

During the LCD Monitor manufacturing process, it is not uncommon for one or more pixels to become fixed in an unchanging state which are hard to see and do not affect the display quality or usability. For more information on Dell Monitor Quality and Pixel Policy, see [Dell Display Pixel Guidelines](#).

Ergonomics

⚠ **CAUTION: Improper or prolonged usage of keyboard may result in injury.**

⚠ **CAUTION: Viewing the monitor screen for extended periods of time may result in eye strain.**

For comfort and efficiency, observe the following guidelines when setting up and using your computer workstation:

- Position your computer so that the monitor and keyboard are directly in front of you as you work. Special shelves are commercially available to help you correctly position your keyboard.
- To reduce the risk of eye strain and neck, arm, back, or shoulder pain from using the monitor for long period, we recommend you to:
 - Set the distance of the screen between 20 to 28 in. (50 - 70 cm) from your eyes.
 - Blink frequently to moisten your eyes or wet your eyes with water after prolonged usage of the monitor.
 - Take regular and frequent breaks for 20 minutes every two hours.
 - Look away from your monitor and gaze at a distant object that is 20 feet away for at least 20 seconds during the breaks.
 - Perform stretches to relieve tension in the neck, arm, back, and shoulders during the breaks.
- Ensure that the monitor screen is at eye level or slightly lower when you are sitting in front of the monitor.
- Adjust the tilt of the monitor, its contrast, and brightness settings.
- Adjust the ambient lighting around you (such as overhead lights, desk lamps, and the curtains or blinds on nearby windows) to minimize reflections and glare on the monitor screen.
- Use a chair that provides good lower-back support.
- Keep your forearms horizontal with your wrists in a neutral, comfortable position while using the keyboard or mouse.
- Always leave space to rest your hands while using the keyboard or mouse.
- Let your upper arms rest naturally on both sides.
- Ensure that your feet are resting flat on the floor.
- When sitting, make sure that the weight of your legs is on your feet and not on the front portion of your seat. Adjust your chair's height or use a footrest if necessary to maintain a proper posture.
- Vary your work activities. Try to organize your work so that you do not have to sit and work for extended periods of time. Try to stand or get up and walk around at regular intervals.
- Keep the area under your desk clear of obstructions and cables or power cords that may interfere with comfortable seating or present a potential trip hazard.

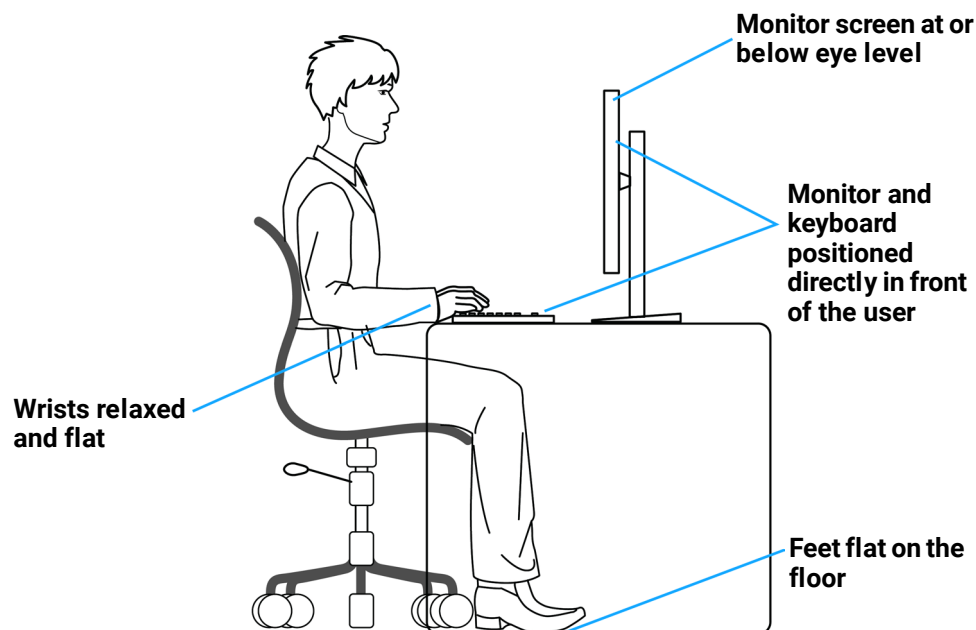


Figure 13. Ergonomics or comfort and efficiency

Handling and moving your display

To ensure the monitor is handled safely when lifting or moving it, follow these guidelines:

- Before moving or lifting the monitor, turn off your computer and the monitor.
- Disconnect all cables from the monitor.
- Place the monitor in the original box with the original packing materials.
- Hold the bottom edge and the side of the monitor firmly without applying excessive pressure when lifting or moving the monitor.

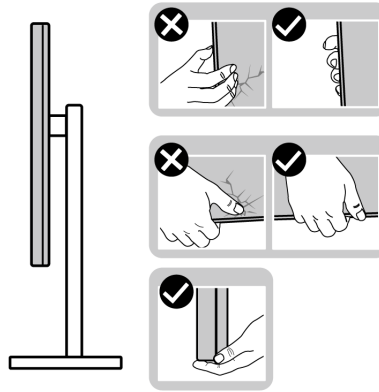


Figure 14. Moving or lifting the monitor

- When lifting or moving the monitor, ensure the screen is facing away from you and do not press on the display area to avoid any scratches or damage.

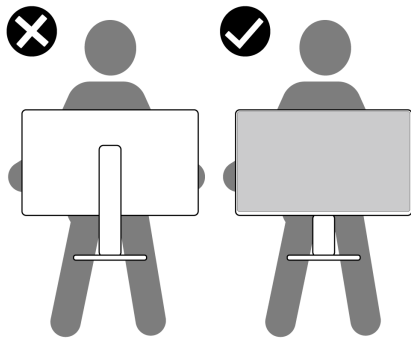


Figure 15. Ensure the screen is facing away from you.

- When transporting the monitor, avoid any sudden shock or vibration to it.
- When lifting or moving the monitor, do not turn the monitor upside down while holding the stand base or stand riser. This may result in accidental damage to the monitor or cause personal injury.

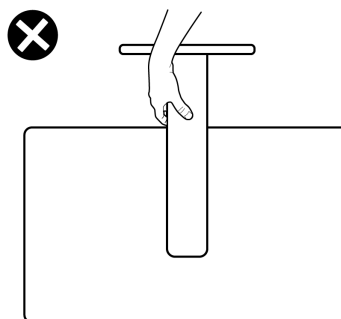


Figure 16. Do not turn the monitor upside down.

Maintenance guidelines

Cleaning your monitor

⚠ CAUTION: Read and follow the [Safety instructions](#) before cleaning the monitor.

⚠ WARNING: Before cleaning the monitor, unplug the monitor power cable from the electrical outlet.

For best practices, follow the instructions in the list below when unpacking, cleaning, or handling your monitor:

- Use a clean cloth that is slightly dampened with water to clean the stand assembly, the screen, and the chassis of your Dell monitor. If available, use a screen-cleaning tissue or solution suitable for cleaning Dell monitors.
- After cleaning the surface of the table, ensure that it is thoroughly dry and free from any moisture or cleaning agent before placing your Dell monitor on it.
- ⚠ **CAUTION:** Do not use detergents or other chemicals such as benzene, thinner, ammonia, abrasive cleaners, alcohol, or compressed air.
- ⚠ **CAUTION:** Using chemicals for cleaning may cause changes in the appearance of the monitor, such as color fading, milky film on the monitor, deformation, uneven dark shade, and peeling of screen area. If you notice white residual powder when you unpack your monitor, wipe it off with a cloth.
- ⚠ **WARNING:** Do not spray the cleaning solution or even water directly on the surface of the monitor. Doing so will allow liquids to accumulate at the bottom of the display panel and corrode the electronics resulting in permanent damage. Instead, apply the cleaning solution or water to a soft cloth and then clean the monitor.
- ⓘ **NOTE:** Monitor damage due to improper cleaning methods and the use of benzene, thinner, ammonia, abrasive cleaners, alcohol, compressed air, detergent of any kind will lead to a Customer Induced Damage (CID). CID is not covered under the standard Dell warranty.
- If you notice white residual powder when you unpack your monitor, wipe it off with a cloth.
- Handle your monitor with care as a darker-colored monitor may get scratched and show white scuff marks more than a lighter-colored monitor.
- To help maintain the best image quality on your monitor, use a dynamically changing screen saver and turn off your monitor when not in use.

Setting up the monitor

Attaching the stand

- ① **NOTE:** The stand is not installed at the factory when shipped.
- ① **NOTE:** The following instructions are applicable only for the stand that was shipped with your monitor. If you are attaching a stand that you purchased from any other source, follow the setup instructions that were included with the stand.

To attach the monitor stand:

1. Open the front flap of the box to get the stand riser and stand base.

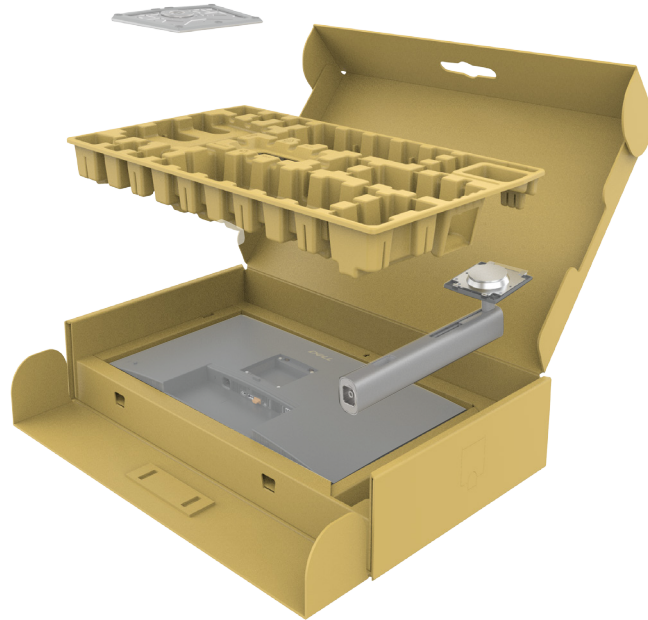


Figure 17. Unboxing

2. Align and place the stand riser on the stand base.
3. Open the screw handle at the bottom of the stand base and turn it clockwise to secure the stand assembly.
4. Close the screw handle.

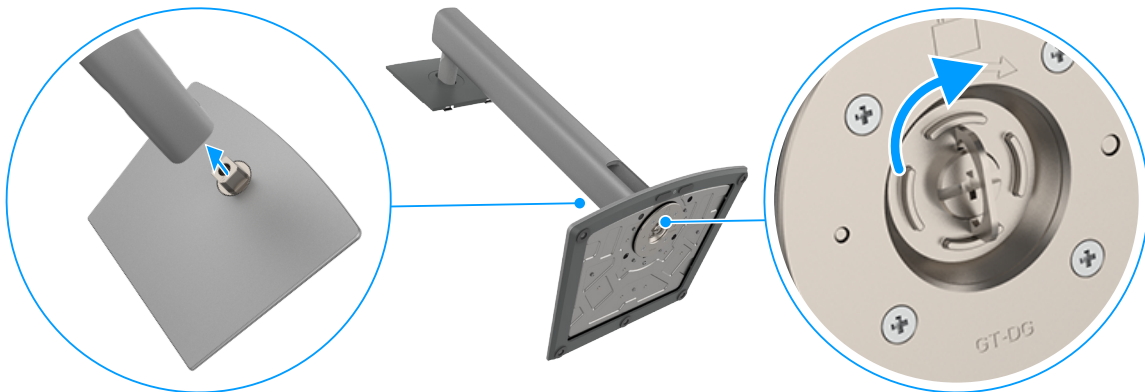


Figure 18. Connecting the stand

5. Open the protective cover on the monitor to access the VESA slot on the monitor.



Figure 19. Open the protective cover

6. Carefully insert the tabs on the stand riser into the slots on the display back-cover and press down the stand assembly to snap it into place.



Figure 20. Insert the tabs on the stand riser into the slots

7. Hold the stand riser and lift the monitor carefully, then place it on a flat surface.

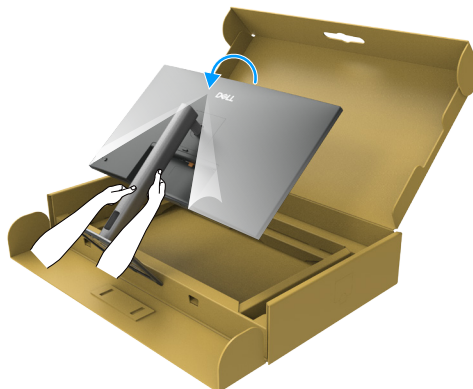


Figure 21. Hold the stand riser and lift the monitor

- NOTE:** Hold the stand riser firmly when lifting the monitor to avoid any accidental damage.

8. Lift the protective cover from the monitor.

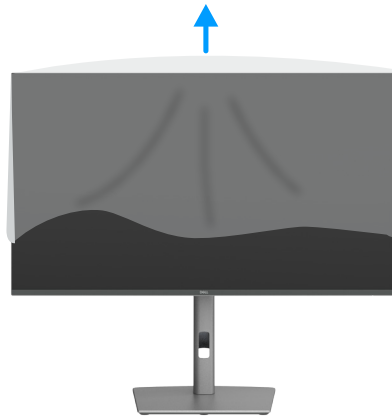


Figure 22. Lift the protective cover from the monitor

Using the tilt, swivel, and height extension

NOTE: The following instructions are applicable only for the stand that is shipped with your monitor. If you are attaching a stand that you purchased from any other source, follow the setup instructions that are included with the stand.

Tilt and swivel adjustment

With the stand that is attached to the monitor, you can tilt and swivel the monitor for the most comfortable viewing angle.

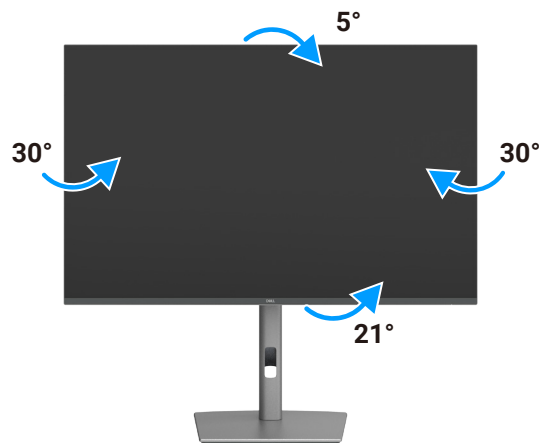


Figure 23. Tilt and swivel adjustment

NOTE: The stand is detached when the monitor is shipped from the factory.

Height adjustment

The stand extends vertically up to 150 mm. The following image illustrates how to extend the stand vertically.

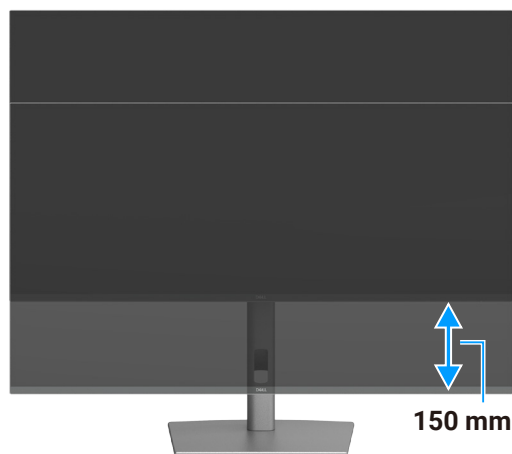


Figure 24. Height adjustment

Rotating the display

Before you rotate the display, extend the display vertically until the top of the stand riser and then tilt the display backwards until the maximum to avoid hitting the bottom edge of the display.

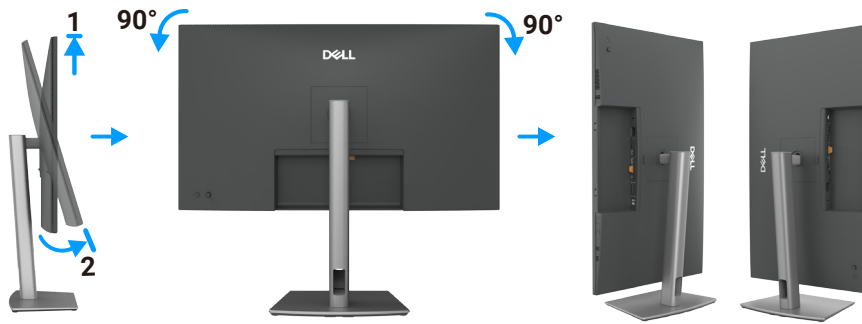


Figure 25. Rotating the display

- ① **NOTE:** To toggle the display setting on your Dell computer between landscape and portrait when rotating the display, download and install the latest graphics driver. To download, go to [Dell Support Site](#), navigate to Drivers & Diagnostics and click **Find Drivers**, and search for the appropriate driver.
- ① **NOTE:** When the display is in portrait mode, you may experience performance degradation when using graphic-intensive applications such as 3D gaming.

Adjusting the rotation display settings of your system

After you have rotated your monitor, you need to complete the procedure below to adjust the Rotation Display Settings of your system.

- ① **NOTE:** If you are using the monitor with a non-Dell computer, you need to go to the graphics driver website or your computer manufacturer website for information on rotating the 'contents' on your display.

To adjust the Rotation Display Settings:

1. Right-click the **Desktop** and click **Properties**.
 2. Select the **Settings** tab and click **Advanced**.
 3. If you have an AMD graphics card, select the **Rotation** tab and set the preferred rotation.
 4. If you have an **NVIDIA** graphics card, click the **NVIDIA** tab, in the left-hand column select **NVRotate**, and then select the preferred rotation.
 5. If you have an Intel graphics card, select the Intel graphics tab, click **Graphic Properties**, select the **Rotation** tab, and then set the preferred rotation.
- ① **NOTE:** If you do not see the rotation option or it is not working correctly, go to [Dell Support Site](#) and download the latest driver for your graphics card.

Organizing your cables

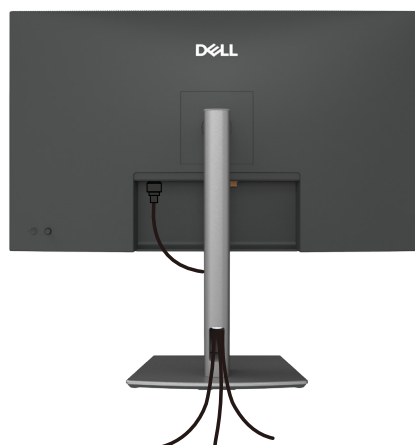


Figure 26. Organizing your cables

Route the cables through the cable-management slot. For more information, see [Connecting your monitor](#).

If your cable is short, connect it directly to the computer without routing through the slot on the monitor stand.

Connecting your monitor

⚠ WARNING: Before you begin any of the procedures in this section, follow the [Safety instructions](#).

⚠ WARNING: For your safety, be sure that the grounded power outlet you plug the power cord into easily accessible to operator and located as close to the equipment as possible. To disconnect power from the equipment, unplug the power cord from the power outlet by grasping the plug firmly. Never pull on the cord.

ⓘ NOTE: Dell monitors are designed to work optimally with the Dell-supplied cables inside the box. Dell does not guarantee the video quality and performance if non-Dell cables are used.

ⓘ NOTE: Route the cables through the cable-management slot before connecting them.

ⓘ NOTE: Do not connect all the cables to the computer simultaneously.

ⓘ NOTE: The images are for the purpose of illustration only. The appearance of the computer may vary.

To connect your monitor to the computer:

1. Turn off your computer and disconnect the power cable.
2. Connect the HDMI/DisplayPort, and the USB-C cable from your monitor to the computer.

⚠ CAUTION: Before using the monitor, it is recommended to fasten the stand riser to a wall using cable tie or a cord that can support the weight of the monitor in order to prevent the monitor from falling.

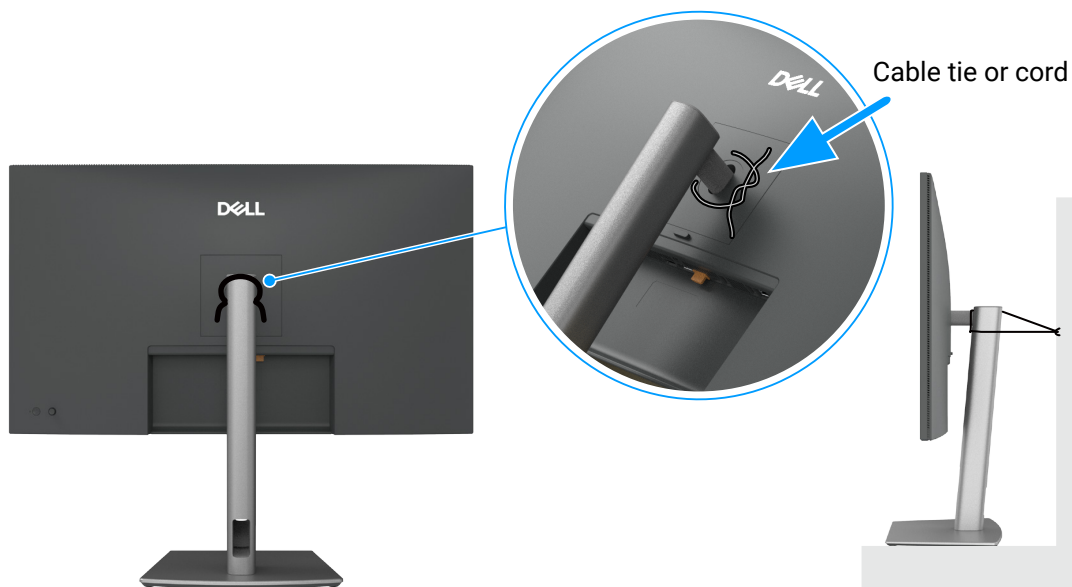


Figure 27. Prevent the monitor from falling

3. Turn on your monitor.
 4. Select the correct input source from the OSD Menu on your monitor and then turn on your computer.
- ⓘ NOTE:** The default setting in P3225DE/P3225QE is DisplayPort 1.4. A DisplayPort 1.1 graphic card may not display normally. See [Product specific problems – No image when using DP connection to the computer](#) to change the default setting.
- ⓘ NOTE:** Remove the rubber plug when using DP (out) connector (P3225DE only).

Connecting the HDMI cable (optional)



Figure 28. Connecting the HDMI cable

Connecting the DisplayPort cable

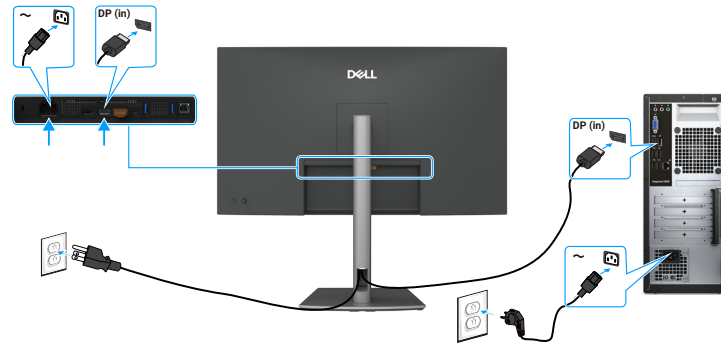


Figure 29. Connecting the DisplayPort cable

Connecting the monitor for DP Multi-Stream Transport (MST) function (P3225DE only)

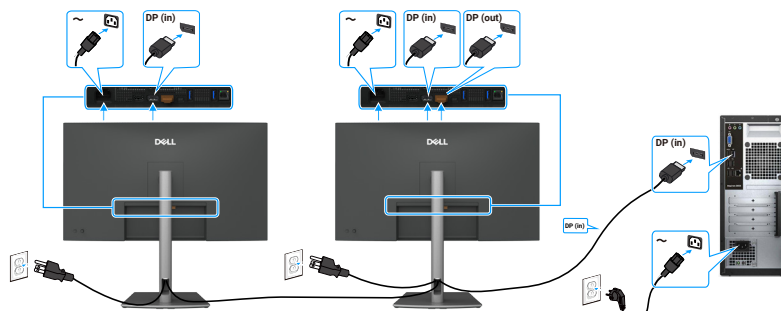


Figure 30. Connecting the monitor for DP Multi-Stream Transport (MST) function

NOTE: Supports the DP MST feature. To use this feature, your computer graphic card must be certified to at least DP 1.2 with MST option.

Connecting the USB-C to C cable

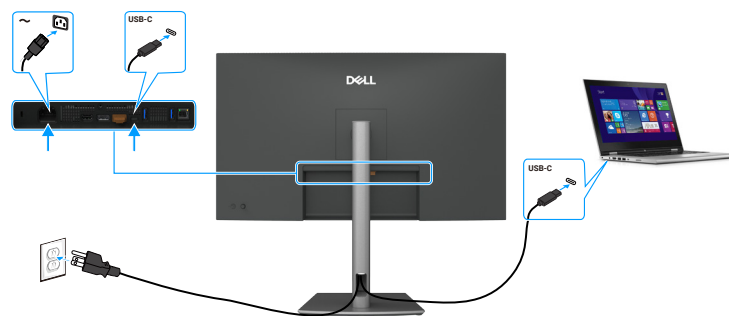


Figure 31. Connecting the USB-C to C cable

Connecting the monitor for USB-C Multi-Stream Transport (MST) function (P3225DE only)

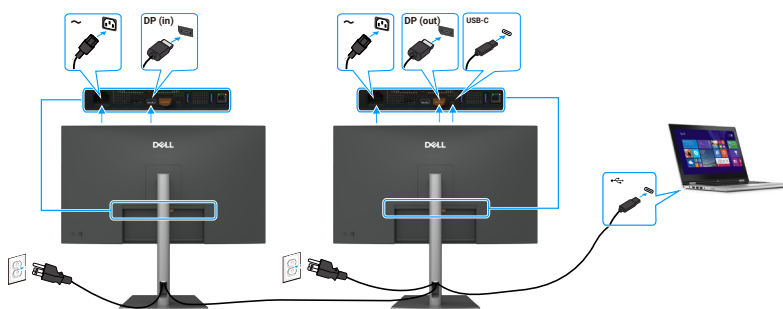


Figure 32. Connecting the Monitor for USB-C Multi-Stream Transport (MST) function

NOTE: The maximum number of monitors supported by MST depends on the bandwidth of the USB-C source.

Connecting the USB Type-C to Type-A cable

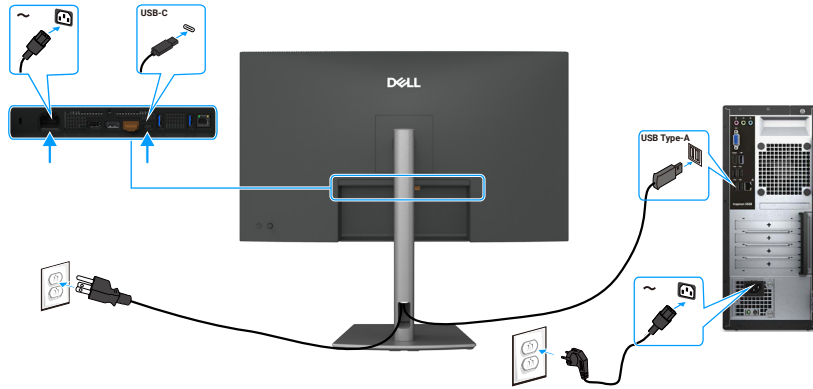


Figure 33. Connecting the USB Type-C to Type-A cable

NOTE: This connection supports data only and does not transmit video. An additional video connection for display is needed.

Connecting the monitor for RJ45 cable (optional)

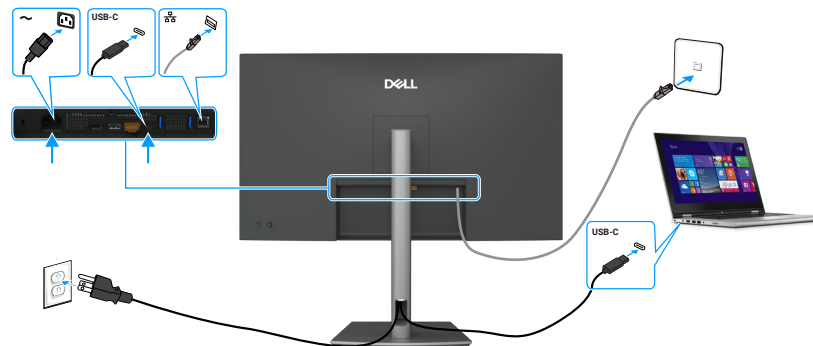


Figure 34. Connecting the monitor for RJ45 cable

Using the quick access ports

When you want to use the monitor's built-in quick access ports, press on the quick access port module and then release. The quick access port module will slide down.

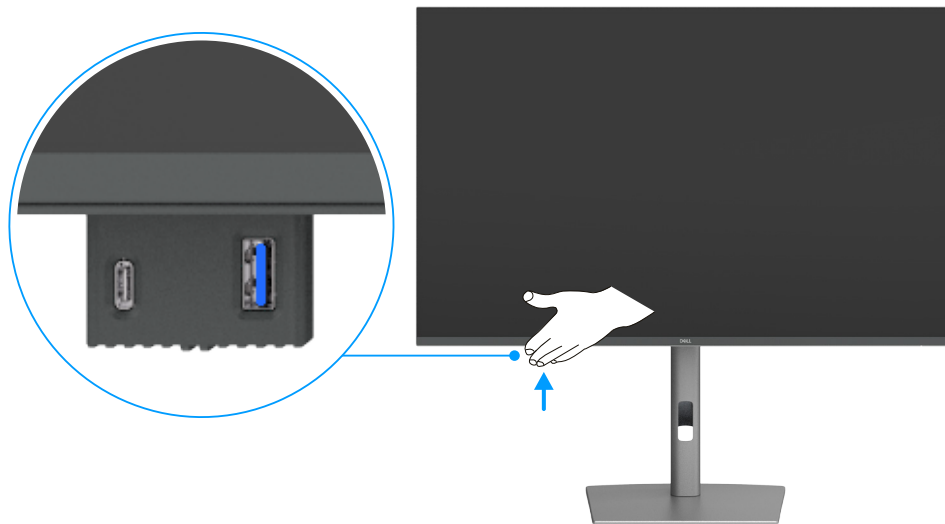


Figure 35. Using the quick access ports

Dell Power Button Sync (DPBS)

The monitor features Dell Power Button Sync (DPBS), enabling you to control your computer's power state using the monitor's power button. This functionality is exclusive to Dell platforms with built-in DPBS and is supported only via the USB-C interface.

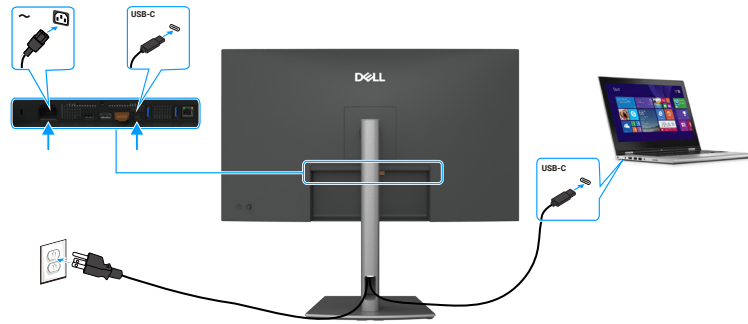


Figure 36. Connecting the USB-C cable

To ensure the DPBS function works initially, perform the following steps on the DPBS supported platform in the **Control Panel** first.

NOTE: DPBS only supports the port with  icon.

NOTE: DPBS is turned off by default. To enable it, go to the Dell Power Button Sync submenu under the Display section in the OSD.

1. Go to **Control Panel**.

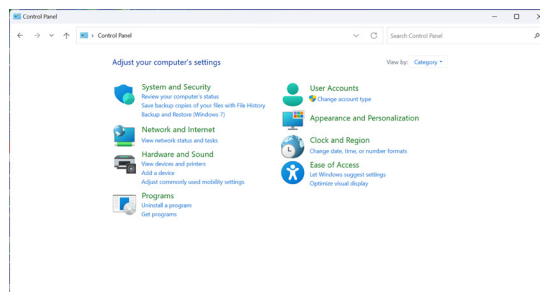


Figure 37. Go to control panel.

2. Select **Hardware and Sound > Power Options**.

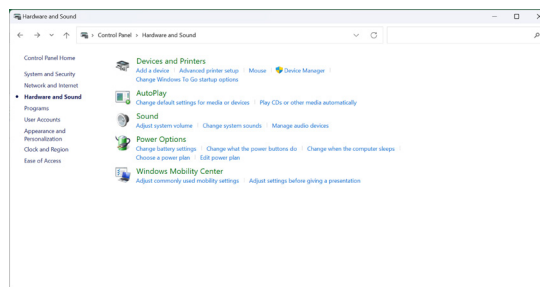


Figure 38. Select Hardware and Sound > Power Options.

3. Go to **System Settings**.

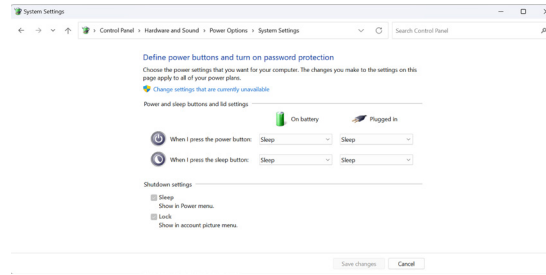


Figure 39. Go to system settings.

4. Select the preferred options from **When I press the power button**.

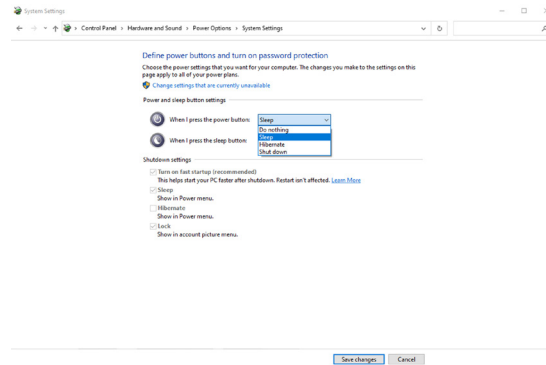


Figure 40. Power button settings

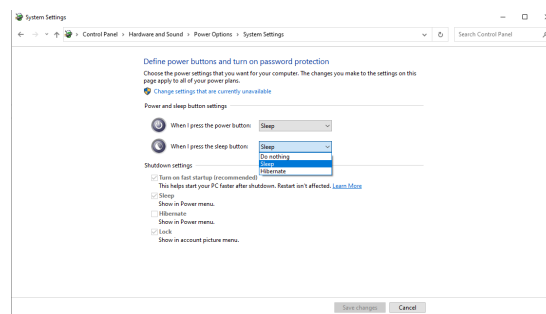


Figure 41. Sleep button settings

NOTE: Avoid selecting **Do nothing** as this will prevent the monitor's power button from syncing with the computer's power state.

Connecting the monitor for DPBS for the first time

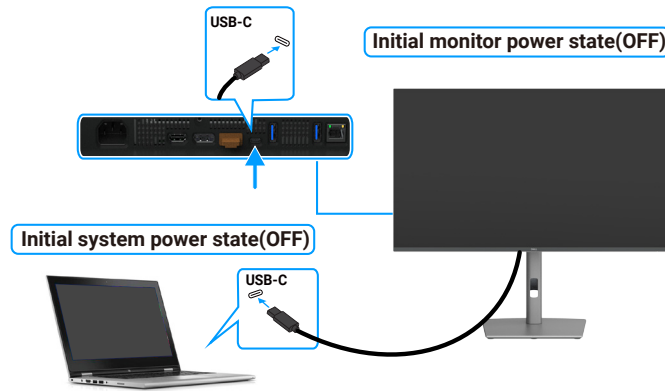


Figure 42. Connecting the monitor for DPBS for the first time

Perform the following steps when setting up the DPBS function for the first time:

1. Navigate to **Dell Power Button Sync** in sub menu under **Display** and enable it.
 2. Ensure both the monitor and computer are turned off.
 3. Connect the USB-C cable from the computer to the monitor.
 4. Press the monitor power button to turn on the monitor.
 5. Both the monitor and computer turn on momentarily. If not, press the power button of the monitor or the computer to boot up the system.
 6. When you connect the Dell OptiPlex 7090/3090 Ultra platform, you may see both the monitor and computer turn on momentarily. Wait for a while (approximately 6 seconds) and both the computer and monitor will turn OFF. When you press either the monitor power button or the computer power button, both the computer and monitor turn ON. The computer system power state is in sync with the monitor power button.
- NOTE:** When the monitor and computer are both at power OFF state at first time, it is recommended that you turn ON the monitor first, then connect the USB-C cable from the computer to the monitor.
- NOTE:** You can power the Dell computer* Ultra platform using its DC adapter jack. Alternatively, you can power the Dell computer* Ultra platform using the monitor's USB-C cable via Power Delivery (PD); set USB-C Charging to On in Off Mode.

* Ensure to check the Dell computer for DPBS supportability.

Using DPBS function

When you connect the USB-C cable, the monitor/computer state is as follows:

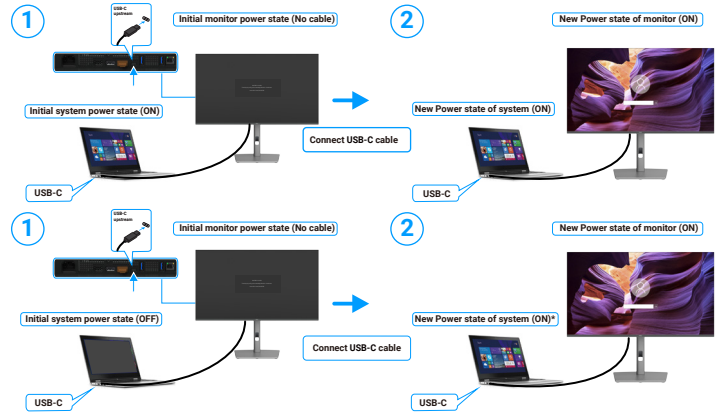


Figure 43. Connect the USB-C cable

* Not all Dell systems support to wake up the platform through the monitor.

* Upon USB-C cable connection, mouse movement or keyboard press is required to wake the system/monitor up from sleep or hibernate.

When you press the monitor power button or computer power button, the monitor/computer state is as follows:

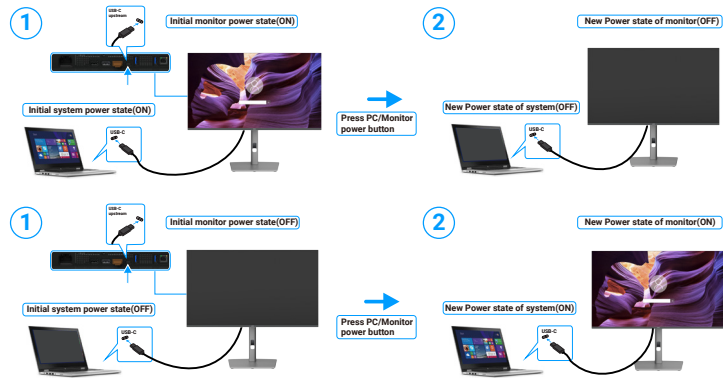


Figure 44. The state of the monitor/computer.

NOTE: You can enable or disable the power button sync function using the OSD. See [Dell Power Button Sync](#).

When the monitor and computer power state are both ON, while you **press and hold 4 seconds on the monitor power button**, the screen prompt asks if you would like to shut down the computer.

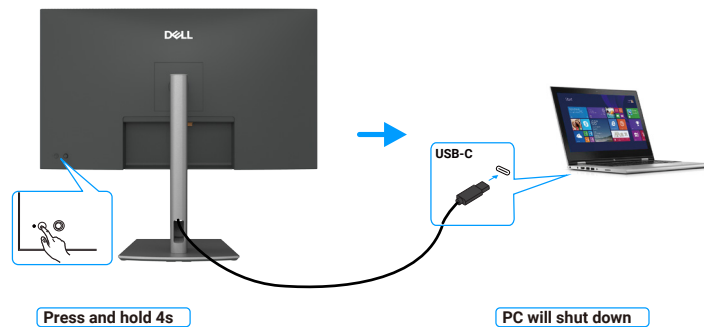


Figure 45. Press and hold 4 seconds on the monitor power button.

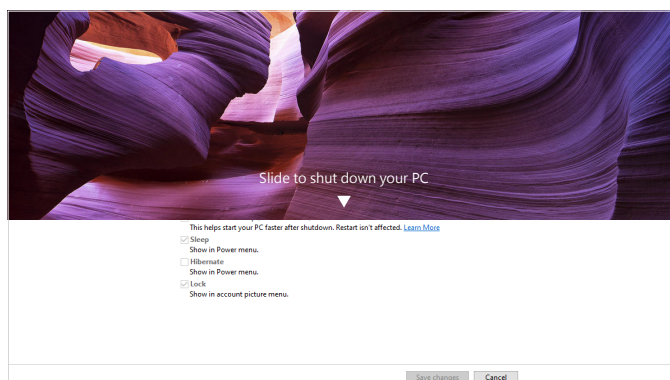


Figure 46. Slide to shut down your PC

When the monitor and computer power state are both ON, while **you press and hold 10 seconds on monitor power button**, the computer will shut down.

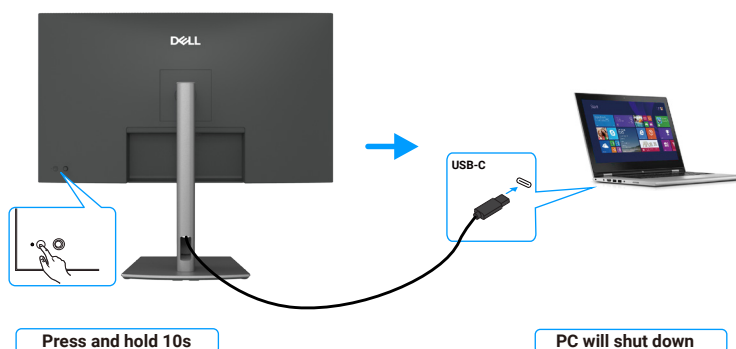


Figure 47. Press and hold 10 seconds on monitor power button.

Connecting the monitor for USB-C Multi-Stream Transport (MST) function (P3225DE only)

A computer is connected to two monitors in an initially OFF power state, and the computer system power state is in sync with Monitor 1 power button. When you press the Monitor 1 or computer power button, both the Monitor 1 and computer turns ON. Meanwhile the Monitor 2 will remain OFF. You need to manually press the power button on Monitor 2 to turn it ON.

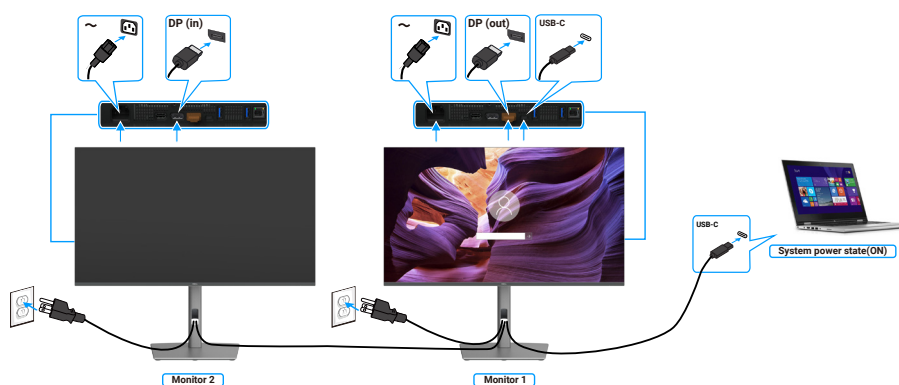


Figure 48. Connecting the monitor for USB-C Multi-Stream Transport (MST) function-ON

Similarly, a computer is connected to two monitors in an initially ON power state, and the computer system power state is in sync with Monitor 1 power button. When you press the Monitor 1 or computer power button, both the Monitor 1 and computer turns OFF. Meanwhile the Monitor 2 will be in Standby mode. You need to manually press the power button on Monitor 2 to turn it OFF.

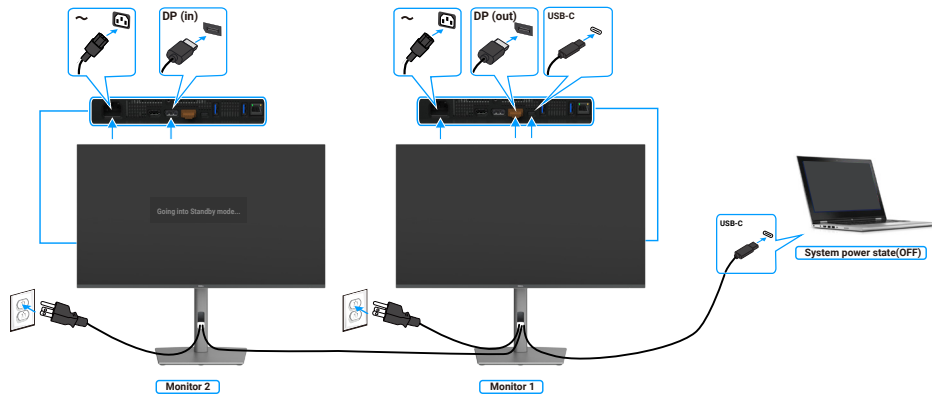


Figure 49. Connecting the monitor for USB-C Multi-Stream Transport (MST) function-OFF

Connecting the monitor for USB-C in DPBS mode

The Dell computer* Ultra platform has two USB-C ports, so both Monitor 1 and Monitor 2 power state can sync with the computer. While the computer and two monitors are in an initially ON power state, by pressing the power button on Monitor 1 or Monitor 2 will turn OFF the computer, Monitor 1, and Monitor 2.

* Ensure to check the Dell computer for DPBS supportability.

NOTE: DPBS only supports the port with  icon.

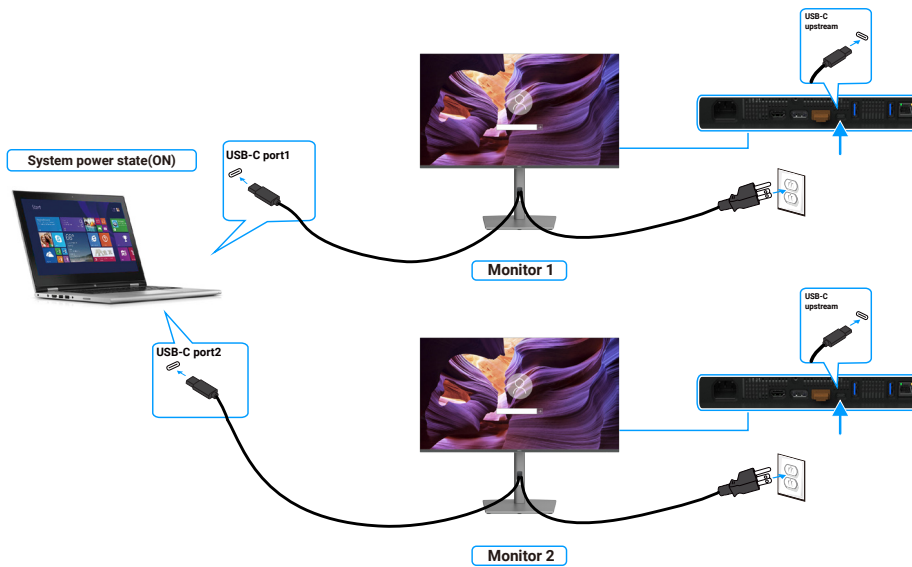


Figure 50. Two monitors power state can sync with the computer in DPBS mode.

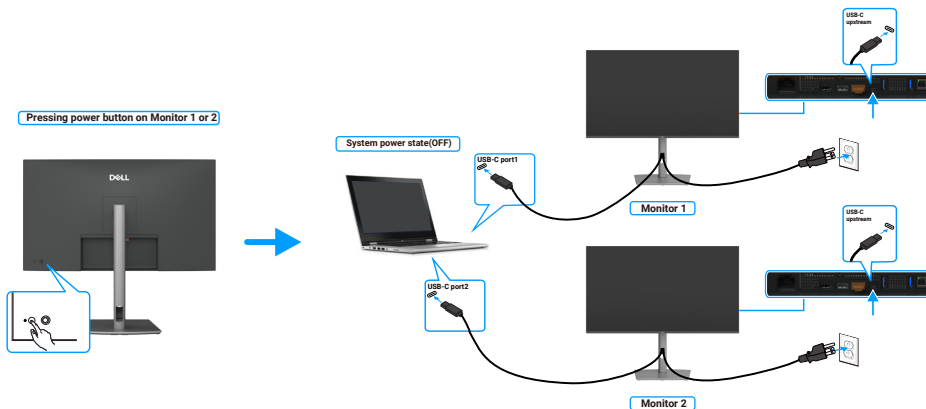


Figure 51. Pressing the power button on either monitor will turn off both monitors and the computer.

Make sure to set **USB-C Charging 90W** to On in Off Mode. While the computer and two monitors are in an initially OFF power state, by pressing the power button on Monitor 1 or Monitor 2 will turn ON the computer, Monitor 1, and Monitor 2.

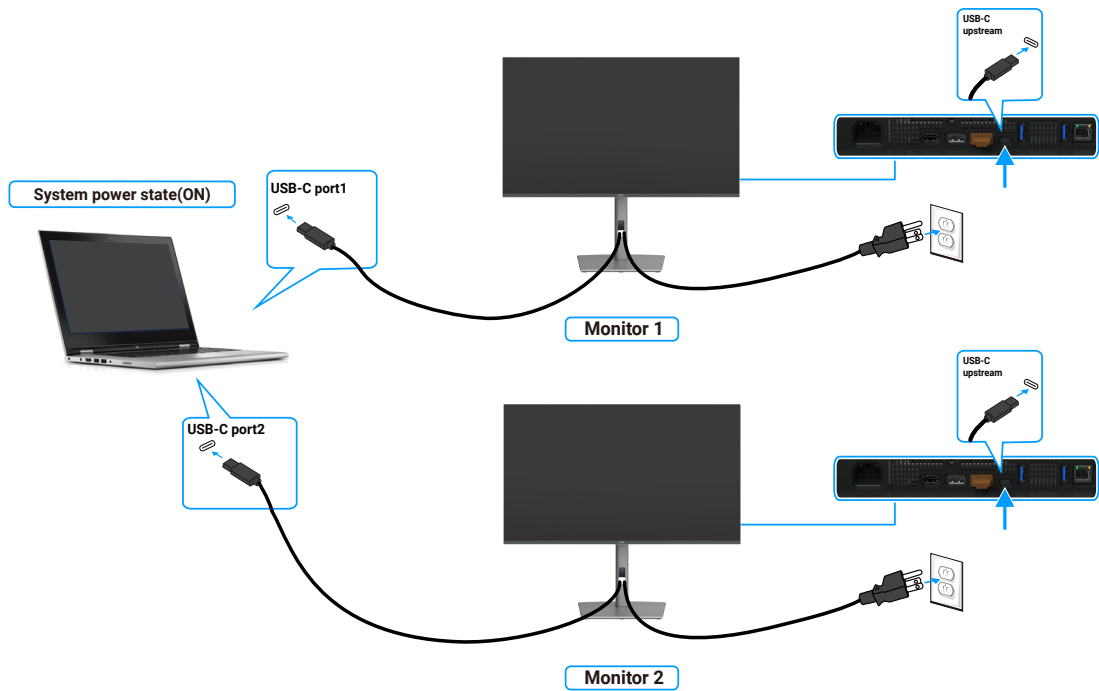


Figure 52. Two monitors and computer power state Off in DPBS mode

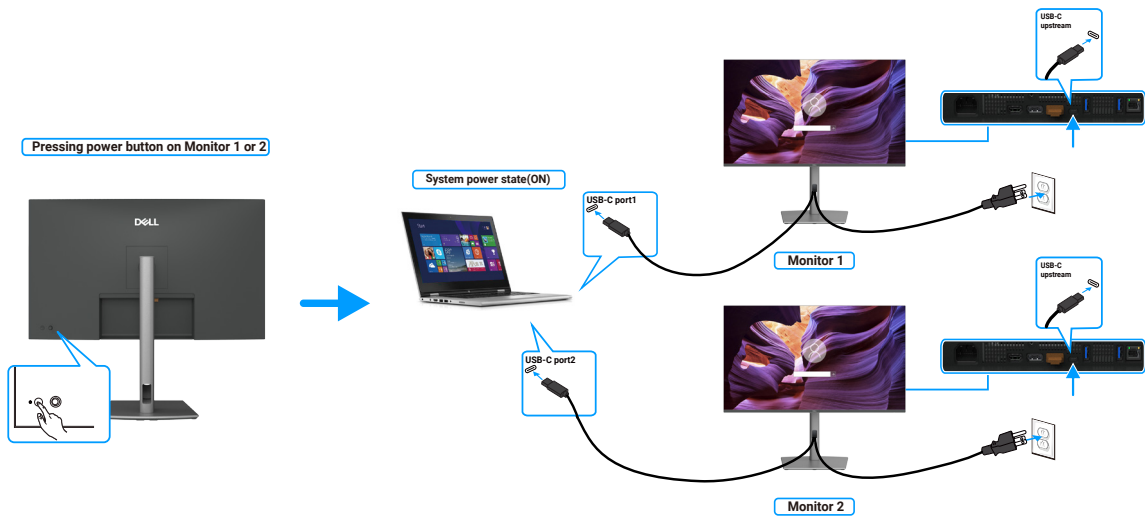


Figure 53. Two monitors and computer power state On in DPBS mode

Securing your monitor using Kensington lock (optional)

The security-lock slot is located at the bottom of the monitor (see [Security lock slot](#)). Secure your monitor to a table using the Kensington security lock.

For more information on using the Kensington lock (sold separately), see the documentation that is shipped with the lock.

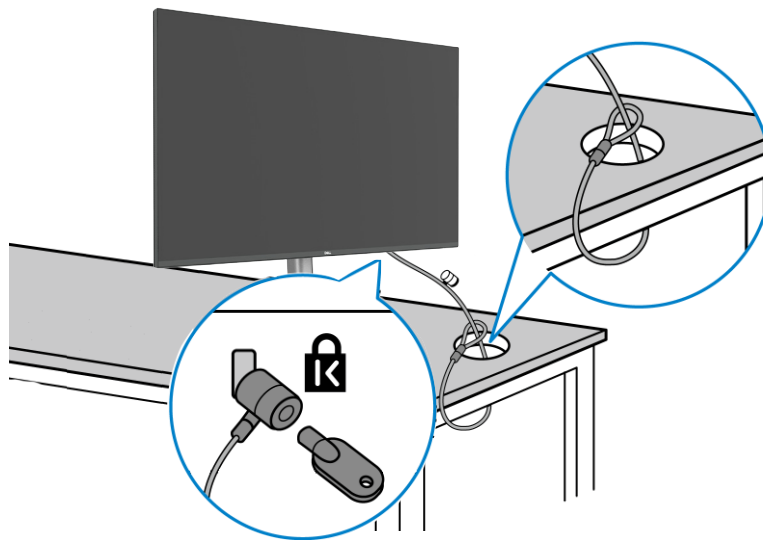


Figure 54. Securing your monitor using Kensington lock

NOTE: The image is for the purpose of illustration only. The appearance of the lock may vary.

Removing the monitor stand

CAUTION: To prevent scratches on the LCD screen when removing the stand, ensure that the monitor is placed on a soft surface and handle it carefully.

NOTE: The following steps are specifically for removing the stand that is shipped with your monitor. If you are removing a stand that you purchased from any other source, follow the setup instructions that are included with the stand.

To remove the stand:

1. Place the monitor on a soft cloth or cushion.
2. Press and hold the stand-release button.
3. Lift the stand up and away from the monitor.



Figure 55. Removing the monitor stand

VESA wall mounting (optional)

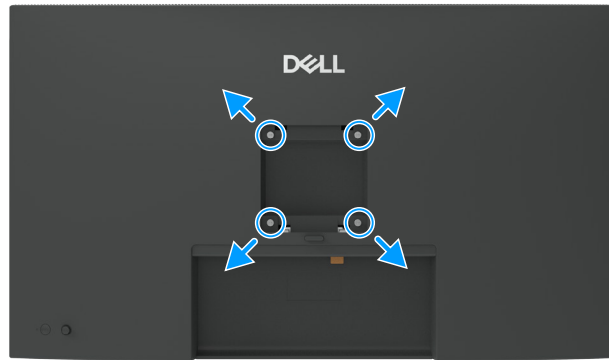


Figure 56. VESA wall mounting

NOTE: Use M4 x 10 mm screws to connect the monitor to the wall-mounting kit.

See the instructions that come with the VESA-compatible wall mounting kit.

1. Place the monitor on a soft cloth or cushion on a stable flat table.
2. Remove the stand (See [Removing the monitor stand](#)).
3. Using a Phillips crosshead screwdriver, remove the four screws securing the plastic cover.
4. Attach the mounting bracket from the wall-mounting kit to the monitor.
5. Mount the monitor on the wall. For more information, see the documentation that shipped with the wall-mounting kit.

NOTE: For use only with UL or CSA or GS-listed wall mount bracket with minimum weight or load bearing capacity of 26.52 kg (58.47 lb) (P3225DE)/26.60 kg (58.64 lb) (P3225QE).

Operating the monitor

Turn on the monitor

Press the power button to turn on the monitor.

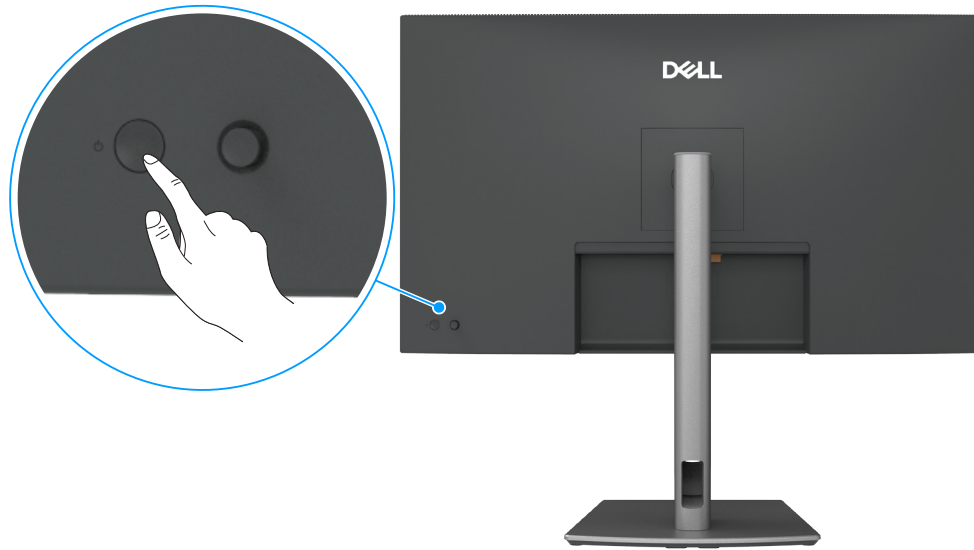


Figure 57. Power on the monitor

Using the joystick control

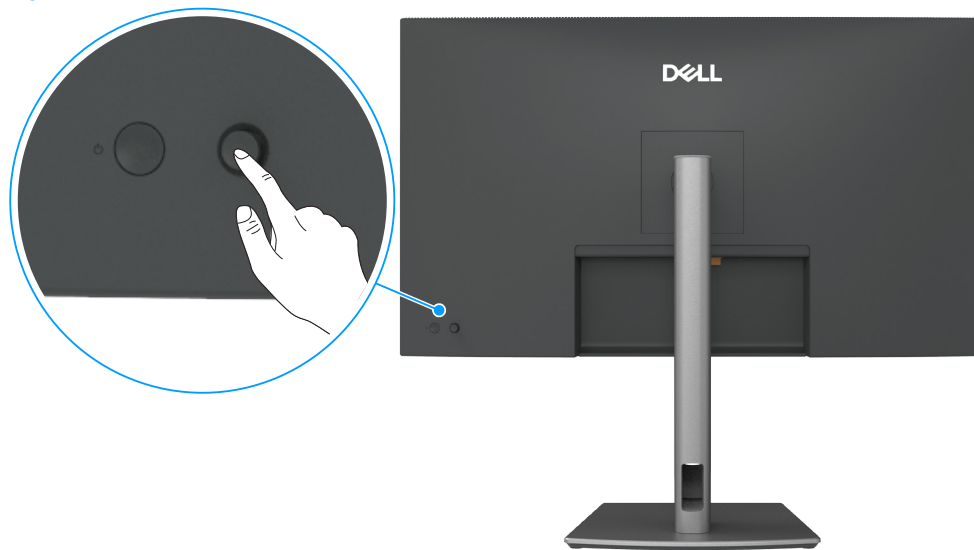





Figure 58. Using the joystick control

Use the joystick control on the back of the monitor to make On-Screen Display (OSD) adjustments.

1. Press the Joystick to open the OSD Menu Launcher.
2. Move the Joystick **Up**, **Down**, **Left**, or **Right** to toggle between the OSD menu options.

Table 27. Joystick functions

Function	Description
	Press Joystick to open the OSD Menu Launcher.
	For right and left navigation.

Function	Description
	For up and down navigation.

Using the Menu Launcher

Press the Joystick to open the OSD Menu Launcher.

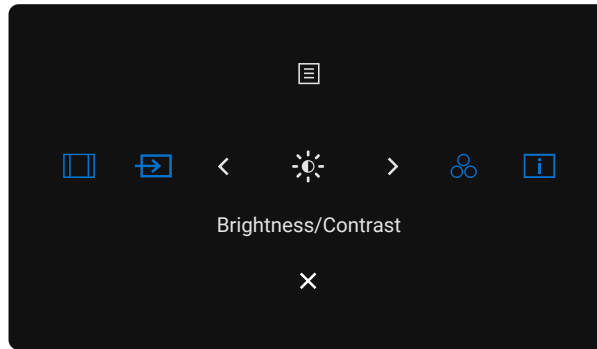









Figure 59. Menu Launcher

- Toggle the Joystick **Up** to open the **Main Menu**.
- Toggle the Joystick **Left** or **Right** to select the desired **Shortcut Keys**.
- Toggle the Joystick **Down** to **Exit**.

Menu Launcher details

The following table describes the Menu Launcher icons:

Table 28. Menu Launcher description

Menu Launcher icon	Description
 Main Menu	Opens the On-Screen Display (OSD). See Using the On-Screen Display (OSD) menu .
 Aspect Ratio (Shortcut key 1)	Use this button to choose from a list of Aspect Ratio .
 Input Source (Shortcut key 2)	Sets the Input Source .
 Brightness/Contrast (Shortcut key 3)	To directly access the Brightness/Contrast adjustment sliders.
 Preset Modes (Shortcut key 4)	Allows to choose from a list of Preset color modes .
 Display Info (Shortcut key 5)	Use this button to choose from a list of Display Info .
 Exit	Exits from the OSD main menu.

Using the navigation keys

When the OSD main menu is active, move the joystick to configure the settings, following the navigation keys displayed below the OSD.

NOTE: To exit the current menu item and return to the previous menu, move the joystick to the left until you exit.

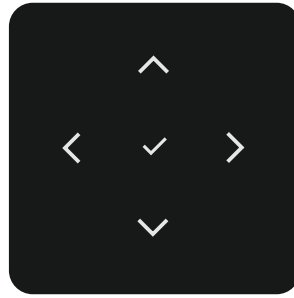








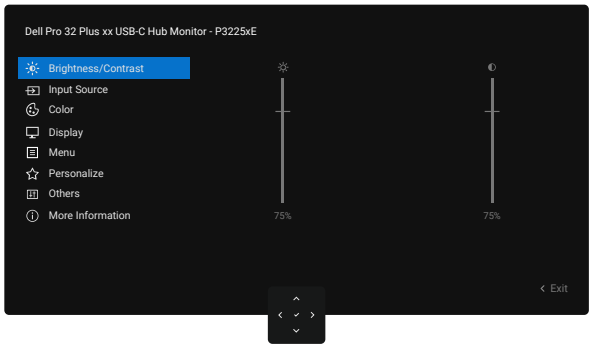

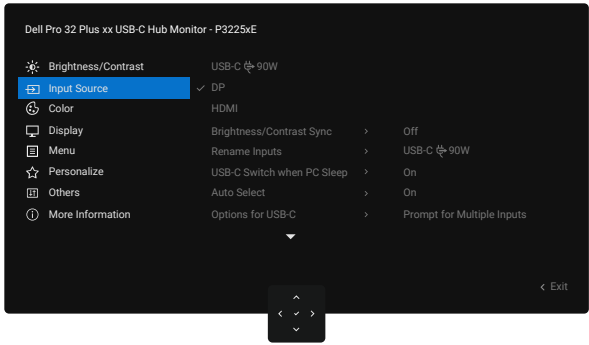



Figure 60. Navigation keys



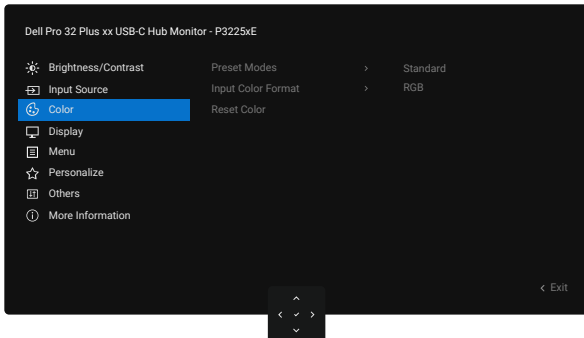
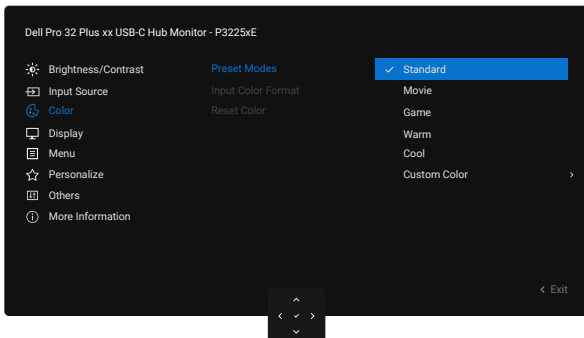
Table 29. Navigation keys description


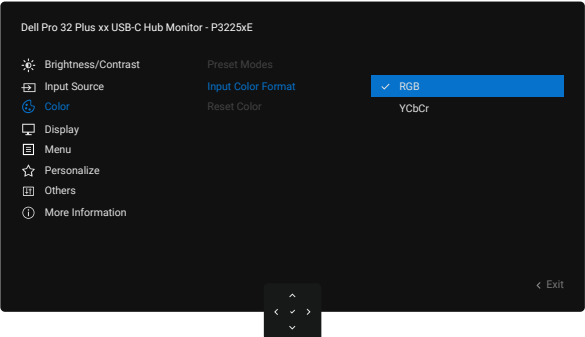



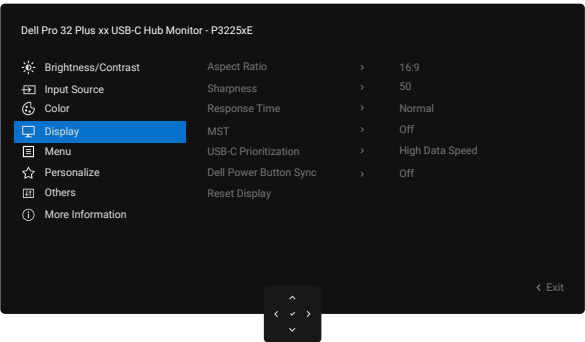


Navigation keys icons	Description
  Up Down	Use the Up (increase) and Down (decrease) navigation keys to adjust items in the OSD menu.
 Left	Use the Left navigation key to go back to the previous menu.
 Right	Use the Right navigation key to confirm your selection.
 OK	Press the joystick to confirm your selection.


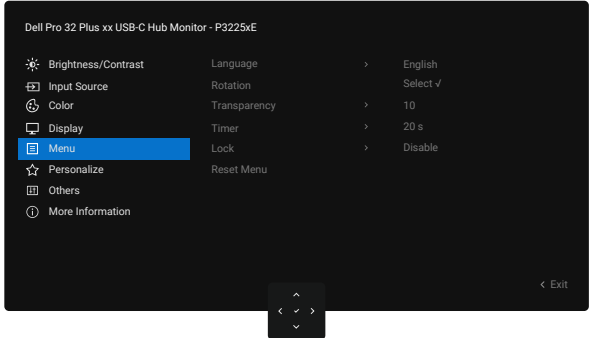
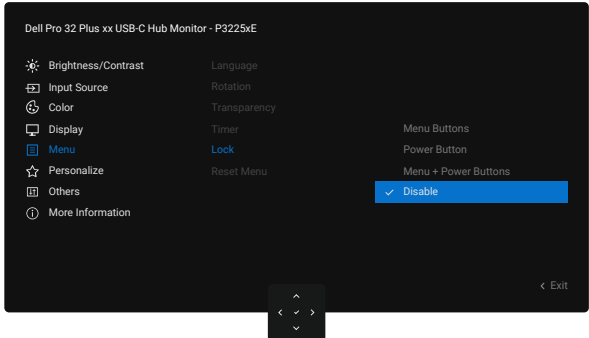
Using the On-Screen Display (OSD) menu

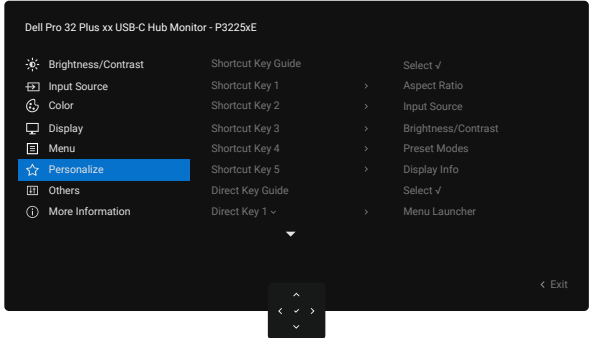

Table 30. On-Screen-Display (OSD) menu description


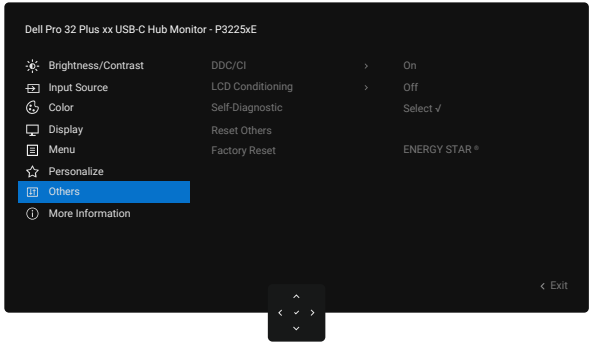
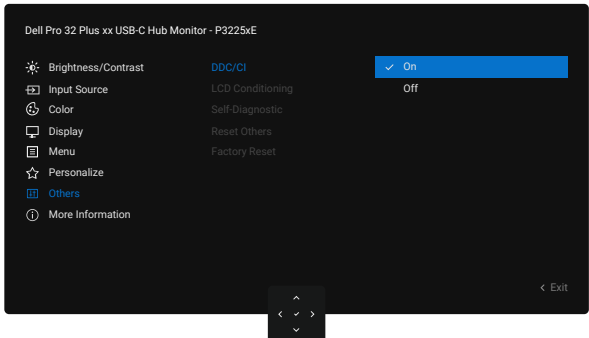
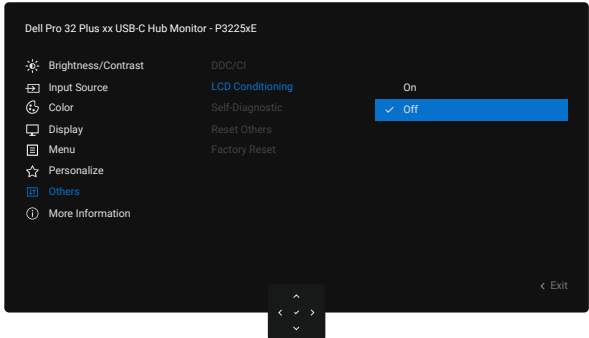
Icon	Menu and submenus	Description
	Brightness/Contrast	Adjusts the brightness and contrast of the display. 
	Brightness	Adjusts the luminance of the backlight (Range: 0–100). Use the Up navigation key to increase brightness. Use the Down navigation key to decrease brightness.
	Contrast	Adjust brightness first, and adjust contrast only if you need further adjustment. Use the Up navigation key to increase contrast and Use the Down navigation key to decrease contrast (Range: 0–100). The Contrast function adjusts the degree of difference between darkness and lightness on the monitor screen.
	Input Source	Selects between different video inputs that are connected to your monitor. 
	USB-C  90W	Select USB-C  90W input when you are using the USB-C  90W connector. Press the joystick to confirm the selection.
	DP	Select DP input when you are using the DP (DisplayPort) connector. Press the Joystick to confirm the selection.
	HDMI	Select the HDMI input when you are using the HDMI connector. Press the Joystick to confirm the selection.
	Brightness/Contrast Sync	Select On to apply unified Brightness and Contrast level to all input sources. Select Off to have independent Brightness and Contrast settings.
	Rename Inputs	Allows you to Rename Inputs .
	USB-C Switch when PC Sleep	This is applicable to computers which provide video source via USB-C port. Set to the desired monitor behaviour when the computer enters sleep mode. On: Monitor switches to other available video input. Off: Monitor enters sleep.
	Auto Select	Allows you to scan for available input sources. Press the joystick to confirm the selection.


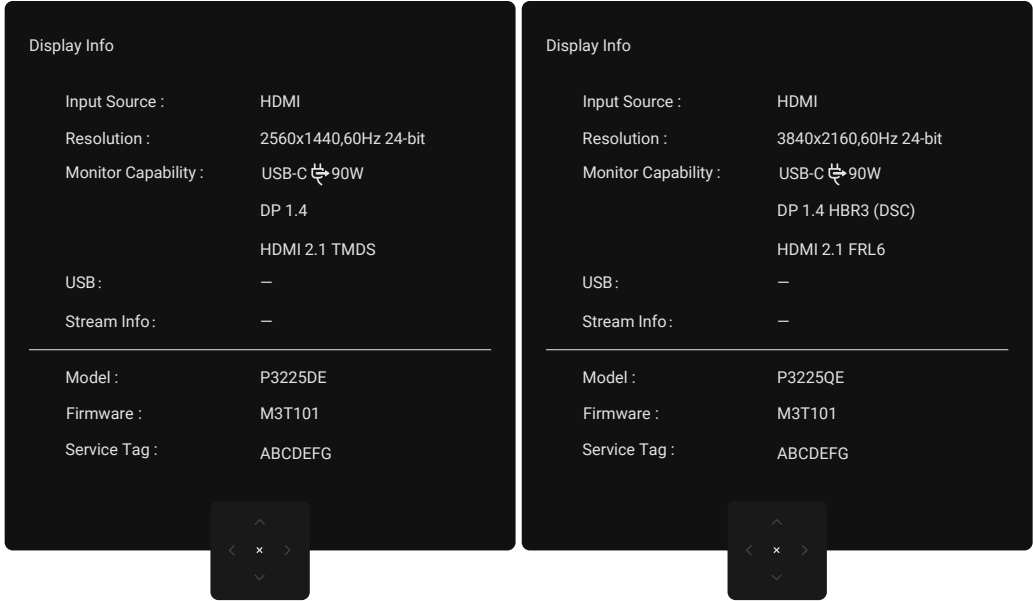
Icon	Menu and submenus	Description
	Option for USB-C	Allows you to set this feature to: <ul style="list-style-type: none"> • Prompt for Multiple Inputs: Always show Switch to USB-C Video Input message for the user to choose whether to switch or not. • Always Switch: The monitor always switches to USB-C video by default while USB-C is connected. • Off: The monitor does not auto-switch to USB-C video from another available input.
	Option for DP/HDMI	Allows you to set this feature to: <ul style="list-style-type: none"> • Prompt for Multiple Inputs: Always show Switch to DP/HDMI Video Input message for user to choose whether to switch or not. • Always Switch: The monitor always switches to DP/HDMI video by default while DP/HDMI is connected. • Off: The monitor does not auto-switch to DP/HDMI video from another available input.
	Reset Input Source	Resets all settings under the Input Source menu to the factory defaults. Press the joystick to confirm the selection.
	Color	Adjusts the color setting mode. 
	Preset Modes	When you select Preset Modes, you can choose Standard , Movie , Game , Warm , Cool , or Custom Color from the list.  <ul style="list-style-type: none"> • Standard: Default Color setting, this monitor uses a low blue light panel, and is certified by TUV to reduce blue light output and create a more relaxing and less stimulating image while reading content on the screen. • Movie: Ideal for movies. • Game: Ideal for most gaming applications. • Warm: Presents colors at lower color temperatures. The screen appears warmer with a red/yellow tint. • Cool: Presents colors at higher color temperatures. The screen appears cooler with a blue tint. • Custom Color: Allows you to manually adjust the color settings. Press the Joystick left and right buttons to adjust the Red, Green, and Blue values and create your own preset color mode.

Icon	Menu and submenus	Description
	Input Color Format	<p>Allows you to set the video input mode to:</p> <ul style="list-style-type: none"> • RGB: Select this option if your monitor is connected to a computer or a media player that supports RGB output. • YCbCr: Select this option if your media player supports only YCbCr output. 
	Hue	<p>Use Joystick Up or Down to adjust the Hue from 0 to 100.</p> <p> NOTE: Hue adjustment is available only for Movie and Game mode.</p>
	Saturation	<p>Use Joystick Up or Down to adjust the Saturation from 0 to 100.</p> <p> NOTE: Saturation adjustment is available only for Movie and Game mode.</p>
	Reset Color	<p>Resets your monitor's color settings to the factory defaults.</p> <p>Press the joystick to confirm the selection.</p>
	Display	<p>Use the Display menu to adjust the image.</p>  <p>Aspect Ratio Adjust the image ratio to 16:9, 4:3, 5:4.</p> <p>Sharpness Adjust the image sharpness to look sharper or softer. Use the Up and Down navigation keys to adjust the sharpness from 0 to 100.</p> <p>Response Time Allows you to set the Response Time to Normal or Fast.</p> <p>MST (P3225DE only) DP Multi Stream Transport, Set to ON enables MST (DP out), Set to OFF disables the MST function.  NOTE: When DP/USB-C upstream cable and DP downstream cable are connected, the monitor sets MST=ON automatically., this action will only be done once after Factory Reset or Display Reset. See Connecting the monitor for DP Multi-Stream Transport (MST) function.</p> <p>USB-C Prioritization Allows you to specify the priority to transfer the data with high resolution (High Resolution) or high speed (High Data Speed) when using the USB-C port (DP ALT mode).</p> <p>Dell Power Button Sync To allow you to control computer system power state from the monitor power button. Allows you to On or Off Dell Power Button Sync function.  NOTE: This feature is only supported with Dell platform which has a built-in DPBS function, and is only supported over USB-C interface.</p> <p>Reset Display Resets all settings in the Display menu to the factory default settings. Press the joystick to confirm the selection.</p>

Icon	Menu and submenus	Description
	Menu	<p>Select this option to adjust the settings of the OSD such as the languages of the OSD, the duration the menu stays on screen, and so on.</p> 
	Language	<p>Select one of eight languages for the OSD display: English, Spanish, French, German, Brazilian Portuguese, Russian, Simplified Chinese, or Japanese.</p>
	Rotation	<p>Rotates the OSD by 0/90/270 degrees. You can press the Joystick to rotate each time.</p>
	Transparency	<p>Select this option to change the menu transparency by moving the Joystick Up or Down (Range: 0–100).</p>
	Timer	<p>OSD Hold Time: Sets the length of time the OSD remains active after you press a button. Move the Joystick to adjust the slider in one second increments, from 5 to 60 seconds.</p>
	Lock	<p>Locking the control buttons prevents unauthorized access and accidental activation, especially in multi-monitor setups.</p>  <ul style="list-style-type: none"> • Menu Buttons: Through OSD to lock the Menu buttons. • Power Button: Through OSD to lock the Power button. • Menu + Power Buttons: Through OSD to lock the Menu and Power buttons. • Disable: Move the Joystick Left and hold for 4 seconds.
	Reset Menu	<p>Resets all settings under the Reset Menu to the factory defaults. Press the joystick to confirm the selection.</p>

Icon	Menu and submenus	Description
★	Personalize	<p>Select this option to adjust the OSD settings such as the Shortcut Key settings, Direct Key settings and so on.</p> 
	Shortcut Keys Guide	This function allows personalization of shortcut keys in the Menu Launcher.
	Shortcut Key 1	Select from Preset Modes, Brightness/Contrast, Input Source, Aspect Ratio, Rotation, Display Info set as shortcut key.
	Shortcut Key 2	
	Shortcut Key 3	
	Shortcut Key 4	
	Shortcut Key 5	
	Direct Key Guide	This function allows one action to access your desired settings.
	Direct Key 1 ↓	Offer users the option to access the most frequently used functions as direct access with just one key press on the Joystick.
	Direct Key 2 →	
	Direct Key 3 ↑	
	Direct Key 4 ←	
	Power LED	Allows you to set the state of the power light to save energy.
 USB-C Charging 90W		<p>Allows you to enable or disable the USB-C Charging 90W charging function during monitor power off mode.</p> <p>NOTE: When this function is enabled, you can charge your laptop or mobile devices through the USB-C cable even when the monitor is powered off.</p>
Other USB Charging		<p>Allows you to enable or disable Other USB Charging function during monitor Standby Mode.</p> <p>NOTE: When this function is enabled, you can charge your mobile phone through the USB Type-A cable even when the monitor is in standby mode.</p>
	Fast Wakeup	Speed up recovery time from sleep mode.
	Reset Personalization	<p>Resets all settings under the Personalize menu to the factory preset values.</p> <p>Press the joystick to confirm the selection.</p>

Icon	Menu and submenus	Description
	Others	<p>Select this option to adjust the OSD settings such as the DDC/CI, LCD Conditioning, and so on.</p> 
	DDC/CI	<p>Display Data Channel/Command Interface (DDC/CI) allows your monitor parameters (brightness, color balance, and so on) to be adjusted using the software on your computer. You can disable this feature by selecting Off. Enable this feature for best user experience and optimum performance of your monitor.</p> 
	LCD Conditioning	<p>Helps reduce minor cases of image retention. Depending on the degree of image retention, the program may take some time to run. You can enable this feature by selecting On.</p> 
	Self-Diagnostic	<p>Use this option to run the built-in diagnostics, see Built-in Diagnostics.</p>
	Reset Others	<p>Resets all settings under the Others menu to the factory default settings. Press the joystick to confirm the selection.</p>
	Factory Reset	<p>Restores all preset values to the factory default settings. These are also the settings for ENERGY STAR tests.</p>

Icon	Menu and submenus	Description
	More Information	<p>Select this option for display information and Dell monitor support.</p> 
	Display Info	<p>Displays the current settings of the monitor. Press the joystick to confirm the selection.</p> 
	Dell Monitor Support	<p>Use your smartphone to scan the QR code to access the general support materials for your monitor.</p>

Using the OSD lock function

You can lock the front-panel control buttons to prevent access to the OSD menu and/or power button.

Use the lock menu to lock the button(s).

1. Select one of the following options.

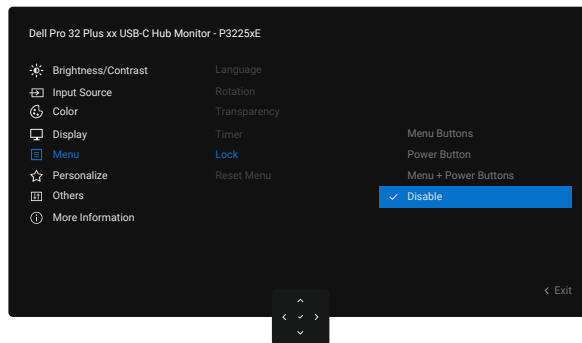


Figure 61. Select the required option to lock

The following message appears:

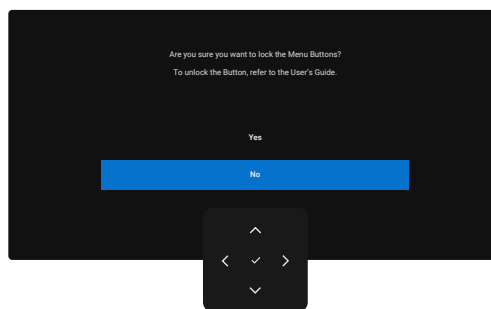


Figure 62. Lock warning message

2. Select **Yes** to lock buttons. Once locked, pressing any control button displays the lock icon .

Use the joystick to lock the button(s)

Press the **Left** directional navigation of Joystick for four seconds, and a menu appears on the screen.

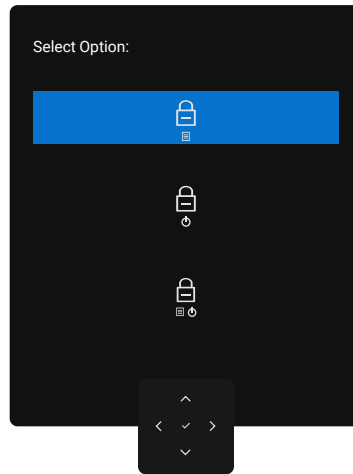





Figure 63. Lock buttons menu

Select one of the following options:

Table 31. Lock buttons menu description

Options	Description
 Menu button lock	Use this option to lock the OSD menu function.
 Power button lock	Use this option to lock the power button. This prevents the user to turn off the monitor using the power button.
 Menu and power button lock	Use this option to lock the OSD menu and the power button to turn off the monitor.

Use the joystick to unlock the button(s)

Press the **Left** directional navigation of Joystick for four seconds until a menu appears on the screen.

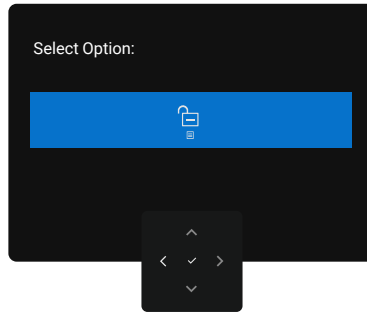





Figure 64. Unlock Menu

The following table describes the options to unlock the front-panel control buttons.

Table 32. Unlock Menu description

Options	Description
 Menu button unlock	Use this option to unlock the OSD menu function.
 Power button unlock	Use this option to unlock the power button to turn off the monitor.
 Menu and power button unlock	Use this option to unlock the OSD menu and the power button to turn off the monitor.

Initial setup

Select OSD items of **Factory Reset** in Other feature, the following message appears:

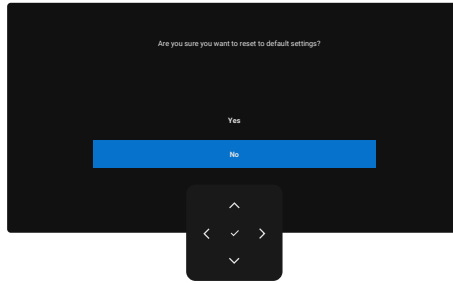


Figure 65. Factory Reset warning message

When you select **Yes** to reset to default settings, the following message is displayed:

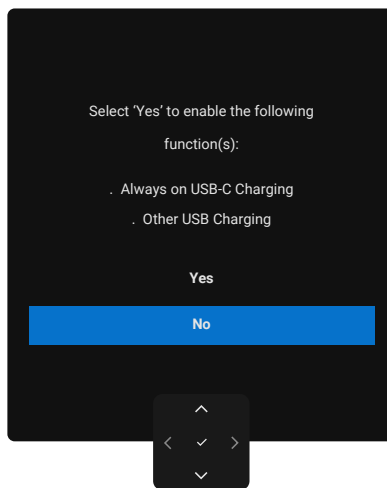


Figure 66. Reset to default settings

OSD warning messages

When the monitor does not support a particular resolution mode, you can see the following message:

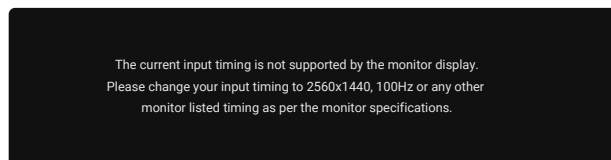


Figure 67. Does not support a particular resolution mode

This means that the monitor cannot synchronize with the signal that it is receiving from the computer. See [Monitor specifications](#) for the horizontal and vertical frequency ranges addressable by this monitor.

NOTE: Recommended mode is **2560 x 1440 (P3225DE)/3840 x 2160 (P3225QE)**.

You can see the following message before the DDC/CI function is disabled:

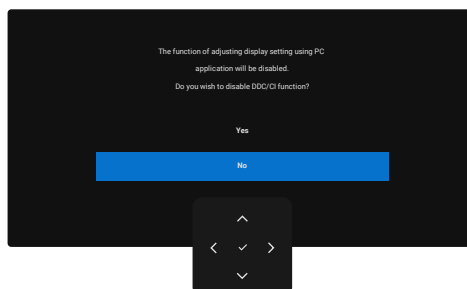


Figure 68. DDC/CI warning message

When the monitor enters the **Standby Mode**, the following message appears:

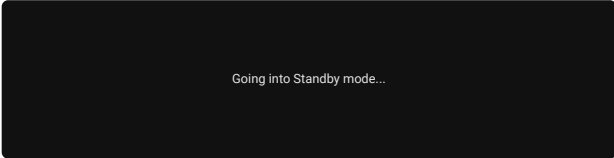


Figure 69. Standby mode warning message

Activate the computer and wake up the monitor to gain access to the **OSD**.

If you press any button other than the power button, the following messages appears depending on the selected input:

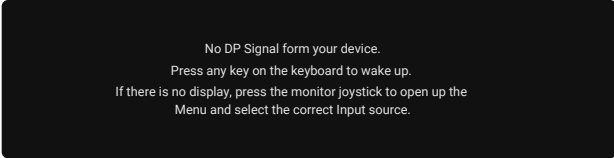


Figure 70. Monitor wake-up warning message

A message is displayed while the cable supporting DP alternate mode is connected to the monitor under the following conditions:

- When Auto Select for **USB-C** is set to **Prompt for Multiple Inputs**.
- When the **USB-C** cable is connected to the monitor.

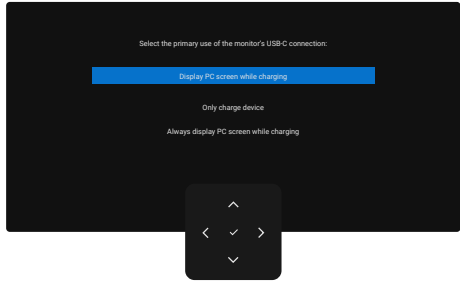


Figure 71. Auto Select for USB-C Warning message

If the monitor connects with two ports or more, when the **Auto** Input Source is selected, it will turn to the next port with signal.

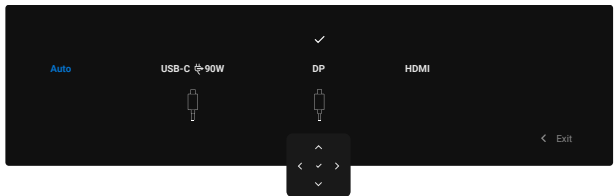


Figure 72. OSD-Auto Select for USB-C

Select OSD items of **On in Standby Mode** in **Personalize** feature, the following message appears:

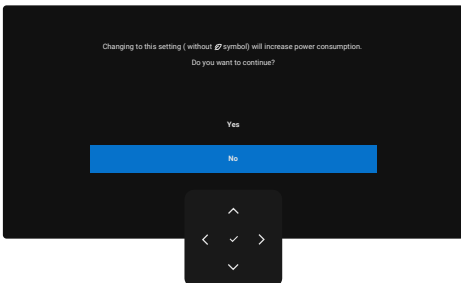


Figure 73. Off in standby mode Warning message

If you adjust the **Brightness** level above the default level over 75%, the following message appears:

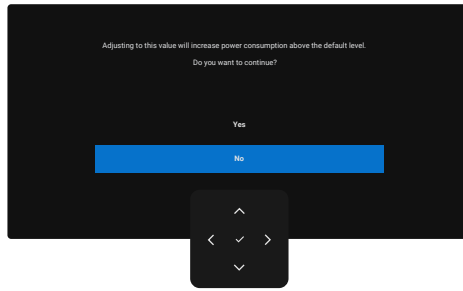


Figure 74. Power warning message

- When you select **Yes**, the power message is displayed only once.
- When you select **No**, the power warning message will pop-up again.
- The power warning message appears again only when you perform a **Factory Reset** from the OSD menu.

If either DP, HDMI, or USB-C input is selected and the corresponding cable is not connected, a dialog box is displayed.

NOTE: The message may slightly vary according to the selected input signal.

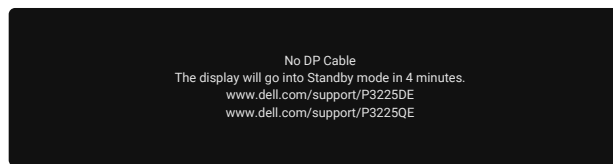


Figure 75. DP cable disconnected warning message

or

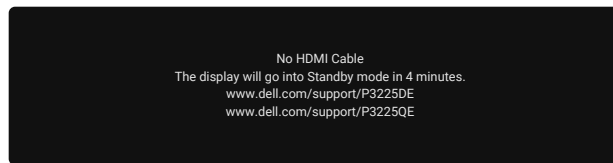


Figure 76. HDMI cable disconnected warning message

or



Figure 77. USB-C cable disconnected warning message

See [Troubleshooting](#) for more information.

Setting the maximum resolution

NOTE: The steps may vary slightly depending on the version of Windows you have.

To set the maximum resolution for the monitor:

In Windows 8.1:

1. For Windows 8.1, select the Desktop tile to switch to classic desktop.
2. Right-click on the desktop and click **Screen resolution**.
3. If you have more than one monitor connected, ensure that you select **P3225DE/P3225QE**.
4. Click the **Screen resolution** drop-down list and select **2560 x 1440 (P3225DE)/3840 x 2160 (P3225QE)**.
5. Click **OK**.

In Windows 10 and Windows 11:

1. Right-click on the desktop and click **Display Settings**.
2. If you have more than one monitor connected, ensure that you select **P3225DE/P3225QE**.
3. Click the **Display Resolution** dropdown list and select **2560 x 1440 (P3225DE)/3840 x 2160 (P3225QE)**.
4. Click **Keep changes**.

If you do not see **2560 x 1440 (P3225DE)/3840 x 2160 (P3225QE)** as an option, you must update your graphics driver to the latest version. Depending on your computer, complete one of the following procedures:

If you have a Dell desktop or laptop:

- Go to [Dell Support Site](#), enter your service tag, and download the latest driver for your graphics card.

If you are using a non-Dell computer (laptop or desktop):

- Go to the support site for your non-Dell computer and download the latest graphic card drivers.
- Go to the graphics card's website and download the latest graphic card drivers.

Troubleshooting

⚠ WARNING: Before you begin any of the procedures in this section, follow the [Safety instructions](#).

Self-test

Your monitor provides a self-test feature that allows you to check whether your monitor is functioning properly. If your monitor and computer are properly connected but the monitor screen remains dark, run the monitor self-test by performing the following steps:

1. Turn off both your computer and the monitor.
2. Unplug the video cable from the back of the computer. To ensure proper Self-Test operation, remove all digital and the analog cables from the back of computer.
3. Turn on the monitor.

If the monitor cannot sense a video signal and is working correctly, a dialog box appears on the screen (against a black background). While in self-test mode, the power LED remains white. Also, depending upon the selected input, one of the dialogs shown will continuously scroll through the screen.

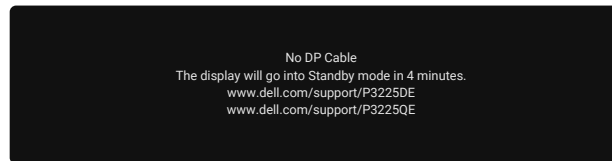


Figure 78. DP cable disconnected warning message

4. This dialog box also appears during normal operation if the video cable is disconnected or damaged.
5. Turn off your monitor and reconnect the video cable; then turn on both your computer and the monitor.

If your monitor screen still remains blank after performing the above steps, it indicates the monitor is functioning properly. Check the video controller and computer.

Built-in diagnostics

Your monitor includes a built-in diagnostic tool to help you identify whether the screen abnormality is due to an issue with the monitor itself or with your computer and video card.

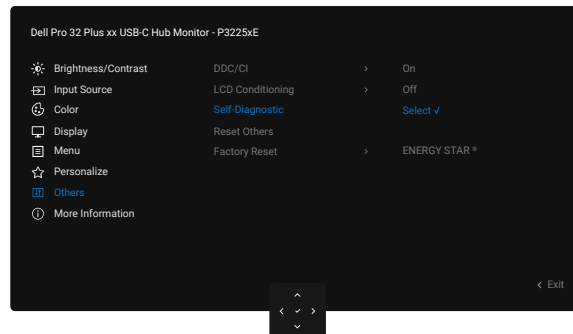


Figure 79. Built-in diagnostics

To run the built-in diagnostics:

1. Ensure that the screen is clean (no dust particles on the surface of the screen).
2. Select OSD items of **Self-Diagnostics** in **Others** feature.
3. Press the Joystick button to start the diagnostics. A gray screen is displayed.
4. Observe if the screen has any defects or abnormalities.
5. Toggle the Joystick once again until a red screen is displayed.
6. Observe if the screen has any defects or abnormalities.
7. Repeat steps 5 and 6 until the screen displays green, blue, black, and white colors. Note any abnormalities or defects.

The test is complete when a text screen is displayed. To exit, toggle the Joystick control again.

If you do not detect any screen abnormalities upon using the built-in diagnostic tool, the monitor is functioning properly. Check the video card and computer.

Common problems

The following table contains general information about common monitor problems you might encounter and the possible solutions:

⚠ WARNING: The monitor LCD panel duty cycle is designed for 18 hours a day, 7 days a week. Usage higher than the designed duty cycle may result in premature decrease in panel backlight luminance, which may not be covered under warranty.

Table 33. Common problems

Common symptoms	What you experience	Possible solutions
No video/power LED off	No picture	<ul style="list-style-type: none"> • Ensure that the video cable connecting the monitor and the computer is properly connected and secure. • Verify that the power outlet is functioning properly using any other electrical equipment. • Ensure that you have pressed the power button properly. • Ensure that the correct input source is selected in the Input Source menu.
No video/power LED on	No picture or no brightness	<ul style="list-style-type: none"> • Increase brightness and contrast controls through OSD. • Perform monitor self-test feature check. • Check for bent or broken pins in the video cable connector. • Run the built-in diagnostics. • Ensure that the correct input source is selected in the Input Source menu.
Missing pixels	LCD screen has spots	<ul style="list-style-type: none"> • Cycle power on-off. • A pixel that stays permanently off is a common defect in LCD technology. • For more information on Dell Monitor Quality and Pixel Policy, see Dell Display Pixel Guidelines.
Stuck-on pixels	LCD screen has bright spots	<ul style="list-style-type: none"> • Cycle power On-Off. • Pixel that is permanently off is a natural defect that can occur in LCD technology. • For more information on Dell Monitor Quality and Pixel Policy, see Dell Display Pixel Guidelines.
Brightness problems	Picture too dim or too bright	<ul style="list-style-type: none"> • Reset the monitor to factory settings. • Adjust brightness and contrast controls through OSD.
Safety-related issues	Visible signs of smoke or sparks	<ul style="list-style-type: none"> • Do not perform any troubleshooting steps. • Contact Dell immediately.
Intermittent problems	Monitor malfunctions on and off	<ul style="list-style-type: none"> • Ensure that the video cable connecting the monitor to the computer is connected properly and is secure. • Reset the monitor to factory settings. • Perform monitor self-test feature check to determine if the intermittent problem occurs in self-test mode.
Missing color	Picture missing color	<ul style="list-style-type: none"> • Perform a monitor self-test. • Ensure that the video cable connecting the monitor to the computer is connected properly and is secure. • Check for bent or broken pins in the video cable connector.
Wrong color	Picture color not good	<ul style="list-style-type: none"> • Try different Preset Modes in Color settings OSD. • Adjust R/G/B value under Custom Color in the Color menu OSD. • Change the Input Color Format to RGB or YCbCr in the Color settings OSD. • Run the built-in diagnostics.
Image retention from a static image left on the monitor for a long period of time	Faint shadow from the static image displayed appears on the screen	<ul style="list-style-type: none"> • Set the screen to turn off after a few minutes of screen idle time. These can be adjusted in the Windows Power Options or Mac Energy Saver setting. • Alternatively, use a dynamically changing screensaver.

Product-specific problems

Table 34. Product-specific problems

Specific symptoms	What you experience	Possible solutions
The screen image is too small	Image is centered on the screen, but does not fill the entire viewing area	<ul style="list-style-type: none"> Check the Aspect Ratio setting in the Display menu OSD. Reset the display to factory settings.
Cannot adjust the monitor with the joystick control on the rear of the monitor	OSD does not appear on the screen	<ul style="list-style-type: none"> Turn off the monitor, unplug the monitor power cable, plug it back, and then turn on the monitor. Check whether the OSD menu is locked. If yes, move and hold the joystick Up, Down, Left, or Right navigation keys for 4 seconds to unlock.
No input signal when user controls are pressed	No picture; the LED light is white	<ul style="list-style-type: none"> Check the signal source. Ensure that the computer is not in the power saving mode by moving the mouse or pressing any key on the keyboard. Ensure the signal cable is securely connected. If needed, disconnect and reconnect the cable to confirm a proper connection. Reset the computer or video player.
The picture does not fill the entire screen	The picture cannot fill the height or width of the screen	<ul style="list-style-type: none"> Due to different video formats (aspect ratio) of DVDs, the monitor may display in full screen. Run the built-in diagnostics.
No image when using DP connection to the computer	Black screen	<ul style="list-style-type: none"> Verify the DisplayPort (DP) certification (DP 1.1a or DP 1.4) of your graphics card. Download and install the latest graphics card driver. Some DP 1.1a graphics card cannot support DP 1.4 monitors.
No image when using USB-C connection to computer, laptop, and so on	Black screen	<ul style="list-style-type: none"> Verify if the USB-C interface of the device can support DP alternate mode. Verify if the device requires more than 90 W power charging. USB-C interface of the device cannot support DP alternate mode. Set Windows to Projection mode. Ensure that the USB-C cable is not damaged.
No charging when using USB-C connection to computer, laptop, and so on	No charging	<ul style="list-style-type: none"> Verify if the device can support one of 5 V/9 V/15 V/20 V charging profiles. Verify if the laptop requires a >90 W power adapter. If the laptop requires a >90 W power adapter, it may not charge with the USB-C connection. Ensure that you use only Dell approved adapter or the adapter that comes with the product. Ensure that the USB-C cable is not damaged.
Intermittent charging when using USB-C connection to computer, laptop, and so on	Intermittent charging	<ul style="list-style-type: none"> Check if the maximum power consumption of the device is over 90 W. Ensure that you use only Dell approved adapter or the adapter that comes with the product. Ensure that the USB-C cable is not damaged.
No image when using USB-C MST (P3225DE only)	Black screen or second DUT is not Prime mode	<ul style="list-style-type: none"> USB-C input - Go to OSD menu. Under Display Info, check if the Link Rate is HBR2 or HBR3. If the Link Rate is HBR2, suggest using USB-C to DP cable to turn on the MST.
No display output on P3225QE when its connected as a 2 nd daisy chained monitor	With an AMD graphic card, connecting P3225QE as a second daisy chained monitor at 3840 x 2160@100 Hz, no signal output/display is observed.	<ul style="list-style-type: none"> Due to bandwidth limitation, DP is unable to support dual 4K monitors at 100 Hz refresh rate. As such, this refresh rate is hidden on non-AMD graphic cards. Do connect both monitors to separate DP/HDMI ports if 3840 x 2160@100 Hz is required. Alternatively, do set the refresh rate of the 2nd monitor (P3225QE) to 60 Hz. (PC> Display> Advanced display > Choose a refresh rate)
No network connection	Network dropped or intermittent	<ul style="list-style-type: none"> Do not toggle Off/On the power button when network is connected, keeps the power button On.

Specific symptoms	What you experience	Possible solutions
The LAN port is not functioning	Operating system setting or cable connection issue	<ul style="list-style-type: none"> • Ensure that your computer has the latest BIOS and drivers installed. • Ensure that the RealTek Ethernet Controller is installed in the Windows Device Manager. • If your BIOS Setup has a LAN/GBE Enabled/ Disabled option, ensure it is set to Enabled. • Ensure that the Ethernet cable is connected securely to both the monitor and the hub/router/ firewall. • Verify the status LED on the Ethernet cable to ensure it is connected. If the LED it not lit, try reconnecting both ends of the cable. • First, turn off the computer and disconnect the USB-C cable and power cord from the monitor. Next, turn the computer back on and reconnect the monitor's power cord and USB-C cable.

Regulatory information

TCO Certified

Any Dell product bearing a TCO label has been certified to a TCO voluntary environmental certification. TCO certification requirements focus on features that contribute to a healthy work environment such as recyclable design, energy efficiency, ergonomics, emissions, avoidance of hazardous substances, and product take back.

For more information on your Dell product and the TCO certification, please visit: Dell.com/environment/TCO_Certified.

For more information on TCO's environmental certifications, please visit: tcocertified.com.

FCC notices (U.S. only) and other regulatory information

For FCC notices and other regulatory information, see the regulatory compliance website at [Dell Regulatory Compliance Home Page](#).

EU product database for energy label and product information sheet

P3225DE: <https://eprel.ec.europa.eu/qr/2156641>

P3225QE: <https://eprel.ec.europa.eu/qr/2156649>

Contacting Dell

To contact Dell for sales, technical support, or customer service issues, see [Contact Support at Dell Support Site](#).

- ① **NOTE:** Availability varies by country and product, and some services may not be available in your country.
- ① **NOTE:** If you do not have an active Internet connection, you can find contact information about your purchase invoice, packing slip, bill, or Dell product catalog.