

Acer OLED Monitor

User Guide

Copyright © 2025. Acer Incorporated.
All Rights Reserved.

Acer OLED Monitor User Guide
Original Issue: 04/2025

Changes may be made periodically to the information in this publication without obligation to notify any person of such revisions or changes. Such changes will be incorporated in new editions of this manual or supplementary documents and publications. This company makes no representations or warranties, either expressed or implied, with respect to the contents hereof and specifically disclaims the implied warranties of merchantability or fitness for a particular purpose.

Record the model number, serial number, purchase date and place of purchase information in the space provided below. The serial number and model number are recorded on the label affixed to your computer. All correspondence concerning your unit should include the serial number, model number and purchase information.

No part of this publication may be reproduced, stored in a retrieval system, or transmitted, in any form or by any means, electronically, mechanically, by photocopy, recording or otherwise, without the prior written permission of Acer Incorporated.

Acer OLED Monitor User Guide

Model number: _____

Serial number: _____

Date of purchase: _____

Place of purchase: _____

Acer and the Acer logo are registered trademarks of Acer Incorporated. Other companies' product names or trademarks are used herein for identification purposes only and belong to their respective companies.

Information for Your Safety and Comfort

Safety instructions

Read these instructions carefully. Keep this document for future reference. Follow all warnings and instructions marked on the product.

Special notes on OLED monitors

The following are normal with the OLED monitor and do not indicate a problem.

- Due to the nature of the fluorescent light, the screen may flicker during initial use. Turn off the power switch and then turn it on again to make sure the flicker disappears.
- You may find slightly uneven brightness on the screen depending on the desktop pattern you use.
- The OLED screen has 99.99% or more effective pixels. It may include blemishes of 0.01% or less such as a missing pixel or a pixel lit all the time.
- Due to the nature of the OLED screen, an afterimage of the previous screen may remain after switching the image, when the same image is displayed for hours. In this case, the screen is recovered slowly by changing the image or turning off the power switch for a few hours.

Cleaning your monitor

Please carefully follow these guidelines when cleaning the monitor:

- Always unplug the monitor before cleaning.
- Use a soft cloth to wipe the screen and cabinet front and sides.

Accessibility

Be sure that the power outlet you plug the power cord into is easily accessible and located as close to the equipment operator as possible. When you need to disconnect power from the equipment, be sure to unplug the power cord from the electrical outlet.

Safe listening

To protect your hearing, follow these instructions.

- Gradually increase the volume until you can hear it clearly and comfortably and without distortion.
- After setting the volume level, do not increase it after your ears have adjusted.
- Limit the amount of time listening to music at high volume.
- Avoid turning up the volume to block out noisy surroundings.
- Turn the volume down if you can't hear people speaking near you.

Warnings

- Do not use this product near water.
- Do not place this product on an unstable cart, stand or table. If the product falls, it could be seriously damaged.
- Slots and openings are provided for ventilation to ensure reliable operation of the product and to protect it from overheating. These openings must not be blocked or covered. The openings should never be blocked by placing the product on a bed, sofa, rug or other similar surface. This product should never be placed near or over a radiator or heat register, or in a built-in installation unless proper ventilation is provided.
- Never push objects of any kind into this product through cabinet slots as they may touch dangerous voltage points or short-out parts that could result in a fire or electric shock. Never spill liquid of any kind onto or into the product.
- To avoid damage of internal components and to prevent battery leakage, do not place the product on a vibrating surface.
- Never use it under sporting, exercising, or any vibrating environment which will probably cause unexpected short current or damage internal devices.

Using electrical power

- This product should be operated from the type of power indicated on the marking label. If you are not sure of the type of power available, consult your dealer or local power company.
- If an extension cord is used with this product, make sure that the total ampere rating of the equipment plugged into the extension cord does not exceed the extension cord ampere rating. Also, make sure that the total rating of all products plugged into the wall outlet does not exceed the fuse rating.
- Do not overload a power outlet, strip or receptacle by plugging in too many devices. The overall system load must not exceed 80% of the branch circuit rating. If power strips are used, the load should not exceed 80% of the power strip's input rating.



.....

Note: The grounding pin also provides good protection from unexpected noise produced by other nearby electrical devices that may interfere with the performance of this product.

Product servicing

Do not attempt to service this product yourself, as opening or removing covers may expose you to dangerous voltage points or other risks. Refer all servicing to qualified service personnel.

Unplug this product from the wall outlet and refer servicing to qualified service personnel when:

- the power cord or plug is damaged, cut or frayed
- liquid was spilled into the product
- the product was exposed to rain or water
- the product has been dropped or the case has been damaged
- the product exhibits a distinct change in performance, indicating a need for service
- the product does not operate normally after following the operating instructions



Note: Adjust only those controls that are covered by the operating instructions, since improper adjustment of other controls may result in damage and will often require extensive work by a qualified technician to restore the product to normal condition.

Potentially explosive environments

Switch off your device in any area with a potentially explosive atmosphere and obey all signs and instructions. Potentially explosive atmospheres include areas where you would normally be advised to turn off your vehicle engine. Sparks in such areas could cause an explosion or fire resulting in bodily injury or even death. Switch off the device near gas pumps at service stations. Observe restrictions on the use of radio equipment in fuel depots, storage and distribution areas; chemical plants; or where blasting operations are in progress. Areas with a potentially explosive atmosphere are often, but not always, marked. They include below deck on boats, chemical transfer or storage facilities, vehicles using liquefied petroleum gas (such as propane or butane), and areas where the air contains chemicals or particles such as grain, dust or metal powders.

Additional safety information

Your device and its enhancements may contain small parts. Keep them out of the reach of small children.

IT Equipment Recycling Information

Acer is strongly committed to environmental protection and views recycling, in the form of salvaging and disposal of used equipment, as one of the company's top priorities in minimizing the burden placed on the environment.

We at Acer are very conscious of the environmental effects of our business and strive to identify and provide the best working procedures to reduce the environmental impact of our products.

For more information and help when recycling, please go to this website:

<https://www.acer-group.com/sustainability/en/our-products-environment.html>

Visit www.acer-group.com for further information on the features and benefits of our other products.

Disposal instructions



Do not throw this electronic device into the trash when discarding. To minimize pollution and ensure utmost protection of the global environment, please recycle. For more information on the Waste from Electrical and Electronics Equipment (WEEE) regulations, visit <https://www.acer-group.com/sustainability/en/our-products-environment.html>

Acer monitor is purposed for video and visual display of information obtained from electronic devices.

OLED pixel statement

The OLED unit is produced with high-precision manufacturing techniques. Nevertheless, some pixels may occasionally misfire or appear as black or red dots. This has no effect on the recorded image and does not constitute a malfunction.

This product has been shipped enabled for power management:

- Activate display's Sleep mode within 5 minutes of user inactivity.
- Wake the monitor when it is in Active Off mode, move the mouse or press any keyboard key.

Tips and information for comfortable use

Computer users may complain of eyestrain and headaches after prolonged use. Users are also at risk of physical injury after long hours of working in front of a computer. Long work periods, bad posture, poor work habits, stress, inadequate working conditions, personal health and other factors greatly increase the risk of physical injury.

Incorrect computer usage may lead to carpal tunnel syndrome, tendonitis, tenosynovitis or other musculoskeletal disorders. The following symptoms may appear in the hands, wrists, arms, shoulders, neck or back:

- numbness, or a burning or tingling sensation
- aching, soreness or tenderness
- pain, swelling or throbbing
- stiffness or tightness
- coldness or weakness

If you have these symptoms, or any other recurring or persistent discomfort and/or pain related to computer use, consult a physician immediately and inform your company's health and safety department.

The following section provides tips for more comfortable computer use.

Finding your comfort zone

Find your comfort zone by adjusting the viewing angle of the monitor, using a footrest, or raising your sitting height to achieve maximum comfort. Observe the following tips:

- refrain from staying too long in one fixed posture
- avoid slouching forward and/or leaning backward
- stand up and walk around regularly to remove the strain on your leg muscles

Taking care of your vision

Long working hours, wearing incorrect glasses or contact lenses, glare, excessive room lighting, poorly focused screens, very small typefaces and low-contrast displays could stress your eyes. The following sections provide suggestions on how to reduce eyestrain.

Eyes

- Rest your eyes frequently.
- Give your eyes regular breaks by looking away from the monitor and focusing on a distant point.
- Blink frequently to keep your eyes from drying out.

Display

- Keep your display clean.
- Keep your head at a higher level than the top edge of the display so your eyes point downward when looking at the middle of the display.
- Adjust the display brightness and/or contrast to a comfortable level for enhanced text readability and graphics clarity.
- Eliminate glare and reflections by:
 - placing your display in such a way that the side faces the window or any light source
 - minimizing room light by using drapes, shades or blinds
 - using a task light
 - changing the display's viewing angle
 - using a glare-reduction filter
 - using a display visor, such as a piece of cardboard extended from the display's top front edge
- Avoid adjusting your display to an awkward viewing angle.
- Avoid looking at bright light sources, such as open windows, for extended periods of time.

Developing good work habits

Develop the following work habits to make your computer use more relaxing and productive:

- Take short breaks regularly and often.
- Perform some stretching exercises.
- Breathe fresh air as often as possible.
- Exercise regularly and maintain a healthy body.

Never place a OLED Monitor in an unstable location. A OLED Monitor may fall, causing serious personal injury or death. Many injuries, particularly to children, can be avoided by taking simple precautions such as:

- Using cabinets or stands recommended by the manufacturer of the OLED Monitor.
- Only using furniture that can safely support the OLED Monitor.
- Ensuring the OLED Monitor is not overhanging the edge of the supporting furniture.
- Not placing the OLED Monitor on tall furniture (for example, cupboards or bookcases) without anchoring both the furniture and the OLED Monitor to a suitable support.
- Not placing the OLED Monitor on cloth or other materials that may be located between the OLED Monitor and supporting furniture.
- Educating children about the dangers of climbing on furniture to reach the OLED Monitor or its controls.

If the existing OLED Monitor is going to be retained and relocated, the same considerations as above should be applied.



EU Declaration of Conformity

We,

Acer Incorporated

8F, 88, Sec. 1, Xintai 5th Rd., Xizhi, New Taipei City 221

And,

Acer Italy s.r.l.

Viale delle Industrie 1/A, 20044 Arese (MI), Italy

Tel: +39-02-9399-921, Fax: +39-02 9399-2913

www.acer.it

Product:	OLED Monitor
Trade Name:	acer
Model Number:	X27
SKU Number:	X27 xxxxxxxx ("x" = 0~9, a~z, A~Z, or blank)

We, Acer Incorporated, hereby declare under our sole responsibility that the product described above is in conformity with the relevant Union harmonization legislations as below Directive and following harmonized standards and/or other relevant standards have been applied:

EMC Directive: 2014/30/EU

EN55032:2015+AC:2016 Class B

EN61000-3-3:2013+A1: 2019

EN61000-3-2:2014 Class D

EN 55035:2017+A11: 2020

LVD Directive: 2014/35/EU

EN62368-1:2014+A11:2017

RoHS Directive: 2011/65/EU

EN IEC 63000:2018

ErP Directive: 2009/125/EC

(EU)2019/2021; EN 50564:2011

Year to begin affixing CE marking: 2025.



RU Jan / Manager
Acer Incorporated (New Taipei City)

Apr.20, 2025
Date



Acer America Corporation
1730 N First St Suite 400,
San Jose, CA 95112
Tel : (408) 533-7700
Fax : (408) 533-4555

English



Federal Communications Commission Declaration of Conformity

This device complies with Part 15 of the FCC Rules. Operation is subject to the following two conditions: (1) this device may not cause harmful interference, and (2) this device must accept any interference received, including interference that may cause undesired operation.

The following local Manufacturer / Importer is responsible for this declaration:

Product:	OLED Monitor
Model Number:	X27
SKU Number:	X27 xxxxxxxx ("x" = 0~9, a ~ z, A ~ Z or blank)
Name of Responsible Party:	Acer America Corporation 1730 N First St Suite 400,
Address of Responsible Party:	San Jose, CA 95112 U. S. A.
Contact Person:	Acer Representative
Phone No.:	(408) 533-7700
Fax No.:	(408) 533-4555

Information for Your Safety and Comfort	iii
Safety instructions	iii
Special notes on OLED monitors	iii
Cleaning your monitor	iii
Accessibility	iii
Safe listening	iii
Warnings	iv
Using electrical power	iv
Product servicing	iv
Potentially explosive environments	v
Additional safety information	v
IT Equipment Recycling Information	v
Disposal instructions	v
OLED pixel statement	vi
Tips and information for comfortable use	vi
Finding your comfort zone	vi
Taking care of your vision	vi
Developing good work habits	vii
PACKAGE CONTENTS	1
Attaching the monitor to the base	2
Attaching the monitor on the wall	3
SCREEN POSITION ADJUSTMENT	4
CONNECTING THE POWER CORD	5
Connecting the adapter and AC Power cord	5
POWER SAVING	5
Display Data Channel (DDC)	6
20-Pin Color Display Signal Cable	6
19-Pin Color Display Signal Cable	7
STANDARD TIMING TABLE	8
Connecting Your Monitor to a Computer	9
External Controls	10
Using the Shortcut Menu	11

Main Menu	13
The Function page	13
TRUBLESHOOTING	21
HDMI/DP Mode (Optional)	21

PACKAGE CONTENTS

Please check the following items are present when you unpack the box, and save the packing materials in case you will need to ship or transport the monitor in future.

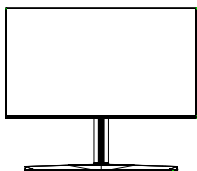
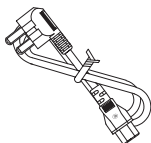
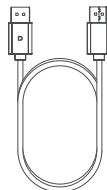
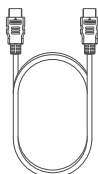
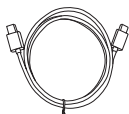
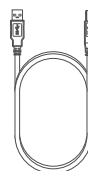
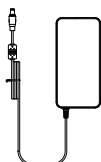
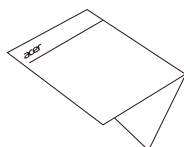
OLED Monitor**Power Cord****DP Cable (Optional)****HDMI Cable (Optional)****Type-C cable (Optional)****USB cable (A to B) (Optional)****Adapter****Quick Start Guide**

Attaching the monitor to the base

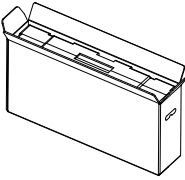

1. Unpack the box. Take out the Styrofoam side by side and set flat on the desktop.

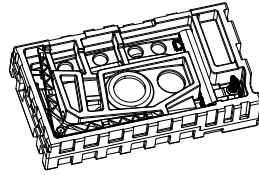

2. Take the Styrofoam with display out of the box.

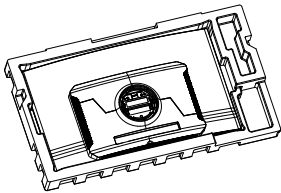

3. Remove the top styrofoam.

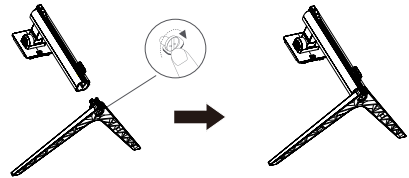

4. Install the stand onto the base and fasten it with the thumb screw from the bottom of the base.

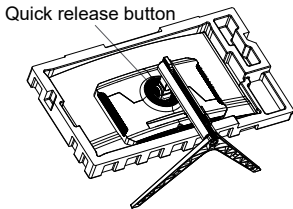

5. Attach the base of step 4 to the quick release notch of the OLED monitor securely.

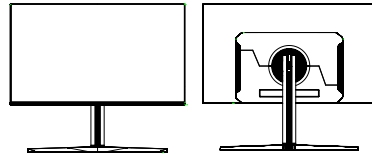

6. Flip the OLED monitor over to make it stand upright on the desk where it will be used. (Note: Do NOT press the screen to avoid damage any time.)

Attaching the monitor on the wall

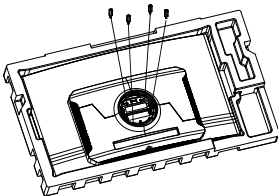

1. Connect the VESA Adapter Mounting Kit with screws (M4x16mm 4pcs).

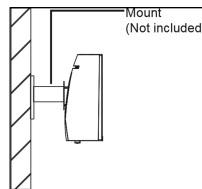

2. Connect the monitor onto the wall.

Remark:

- Please check monitor weight in advance to choose suitable load capacity of VESA arm stand.
- Do not discard the original screws as these may be needed for future use.
- The wall height should be within 2 meters.

SCREEN POSITION ADJUSTMENT

To optimize the viewing position, you can adjust the monitor tilt by using both of your hands to hold the edges of the monitor. The monitor can be adjusted to 20 degrees up or 5 degrees down.

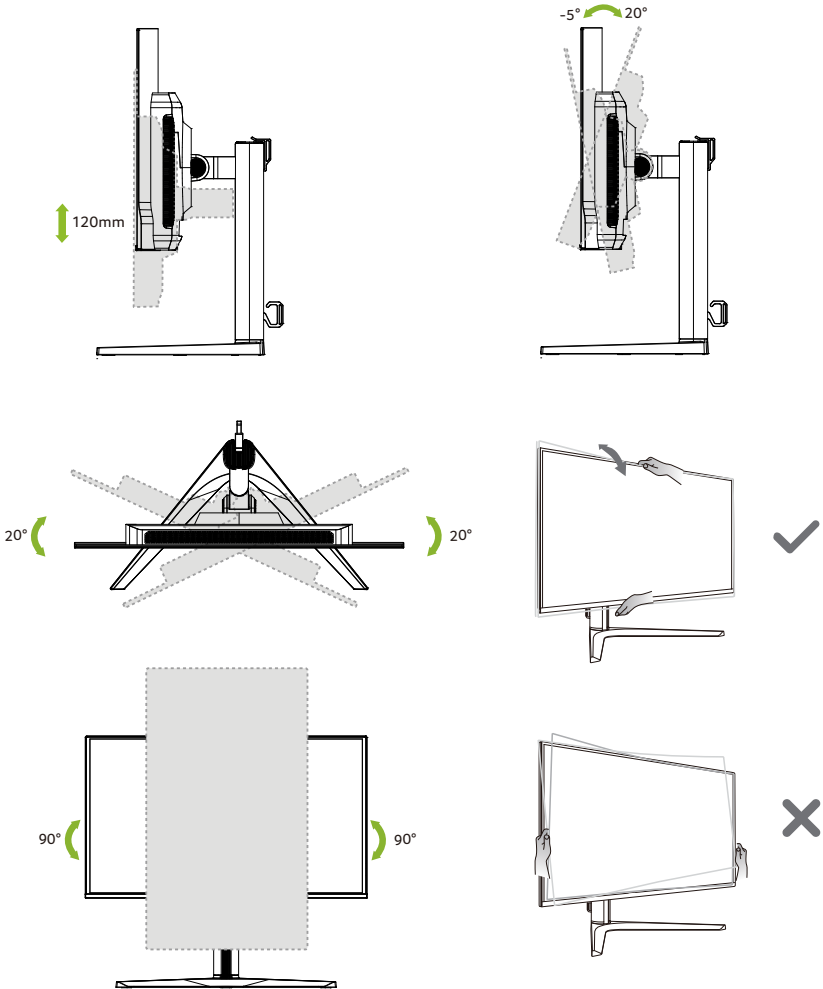

Note: Do NOT press the screen with fingers.

Do NOT grasp the corners or the left and right sides of the monitor to adjust tilt.

CONNECTING THE POWER CORD

- This monitor has a universal power supply that allows operation in either 100/120V AC or 220/240 V AC voltage area. No user-adjustment is required.

Connecting the adapter and AC Power cord

- Check first to make sure that the power cord you use is the correct type required for your area.
- The monitor has a universal power supply that allows operation in either 100/120 V AC or 220/240 V AC voltage area. No user-adjustment is required.
- Plug one end of the AC power cord to the Adapter, and plug the other end into an AC outlet.
- For units using 120 V AC:
 - Use a UL-listed cord set, type SVT wire and plug rated 10 A/125 V.
- For units using 220/240 V AC:
 - Use a cord set consisting of H05VV-F cord and plug rated 10 A/250 V. The cord set should have the appropriate safety approvals for the country in which the equipment will be installed.

POWER SAVING

The power saving states will be kept until a control signal has been detected or the keyboard or mouse is activated. The recovery time from Active OFF state back to ON state is around 3 seconds.

State	LED Light
ON	Blue
Power Saving	Blinking Blue

Display Data Channel (DDC)

To make your installation easier, the monitor is able to Plug and Play with your system if your system also supports DDC protocol. The DDC (Display Data Channel) is a communication protocol through which the monitor automatically informs the host system about its capabilities, for example, supported resolutions and corresponding timing. The monitor supports DDC2B standard.

20-Pin Color Display Signal Cable

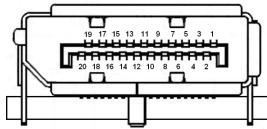

PIN NO.	DESCRIPTION	PIN NO.	DESCRIPTION
1	DP_3.3V	2	GND
3	HPD	4	AUX_CH_N
5	GND	6	AUX_CH_P
7	GND	8	GND
9	ML_LANE0_P	10	GND
11	ML_LANE0-N	12	ML_LANE1-P
13	GND	14	ML_LANE1-N
15	ML_LANE2-P	16	GND
17	ML_LANE2-N	18	ML_LANE3-P
19	GND	20	ML_LANE3-N

19-Pin Color Display Signal Cable

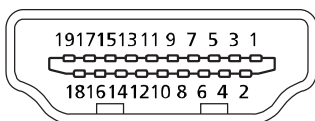

PIN NO.	DESCRIPTION	PIN NO.	DESCRIPTION
1	DATA2-	2	GND
3	DATA2+	4	DATA1-
5	GND	6	DATA1+
7	DATA0-	8	GND
9	DATA0+	10	DCLK-
11	GND	12	DCLK+
13	NC	14	NC
15	HDMI_SCL	16	HDMI_SDA
17	HDMI_DET	18	HDMI15V
19	HDMI_HPD		

STANDARD TIMING TABLE

Mode	Resolution	
VGA	640 x 480	60 Hz
	640 x 480	72 Hz
	640 x 480	75 Hz
MAC	640 x 480	66.66 Hz
VESA	720 x 400	70 Hz
SVGA	800 x 600	56 Hz
	800 x 600	60 Hz
	800 x 600	72 Hz
	800 x 600	75 Hz
XGA	1024 x 768	60 Hz
	1024 x 768	70 Hz
	1024 x 768	75 Hz
VESA	1152 x 864	75 Hz
	1280 x 960	60 Hz
SXGA	1280 x 1024	60 Hz
	1280 x 1024	75 Hz
VESA	1280 x 720	60 Hz
WXGA+	1440 x 900	60 Hz
WSXGA+	1680 x 1050	60 Hz
FHD	1920 x 1080	240 Hz
	1920 x 1080	60 Hz
QHD	2560 x 1440	60 Hz
	2560 x 1440	120 Hz
	2560 x 1440	240 Hz
UHD	3840 x 2160	60 Hz
	3840 x 2160	120 Hz
	3840 x 2160	240 Hz



-
- Note:**
1. DP: Support max timing resolution 3840x2160-240Hz, also support Variable Refresh Rate and HDR function.
 2. DP ALT(Type-C): Support max timing resolution 3840x2160-240Hz, also support Variable Refresh Rate.
 3. HDMI : Support max timing resolution 3840x2160-240Hz, also support Variable Refresh Rate and HDR function.

Connecting Your Monitor to a Computer

1. Make sure both the monitor and computer are powered-OFF.
2. Connect DP Cable (Only DP-input model)
 - a. Make sure both the monitor and computer are powered-OFF.
 - b. Connect the DP cable to the computer.
3. Connect HDMI Cable (Only HDMI-input model)
 - a. Make sure both the monitor and computer are powered-OFF.
 - b. Connect the HDMI cable to the computer.
4. Plug the power cords of your computer and your monitor into a nearby electrical outlet.

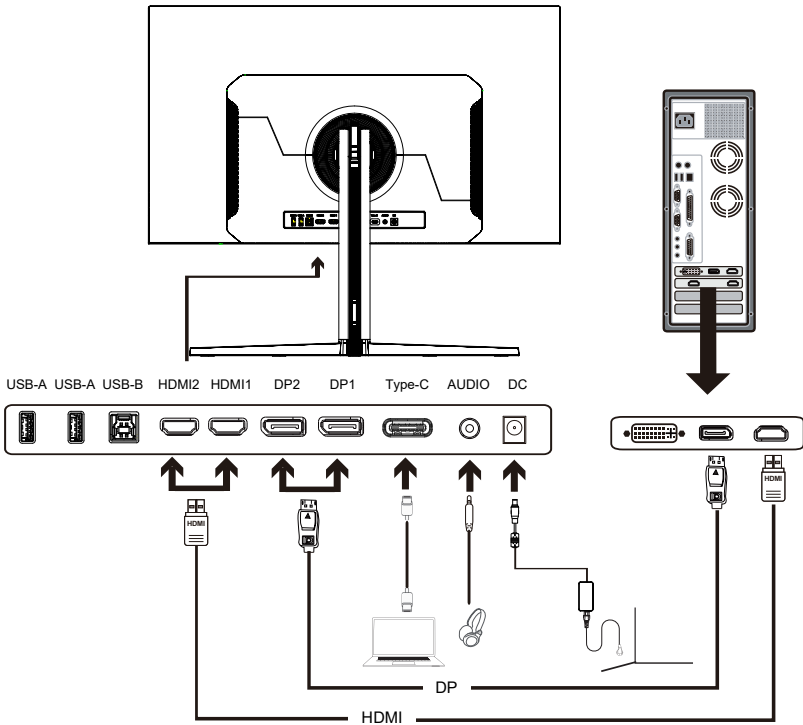

Note: The audio output function depends on models. Please refer to User's Guide for more information.

External Controls

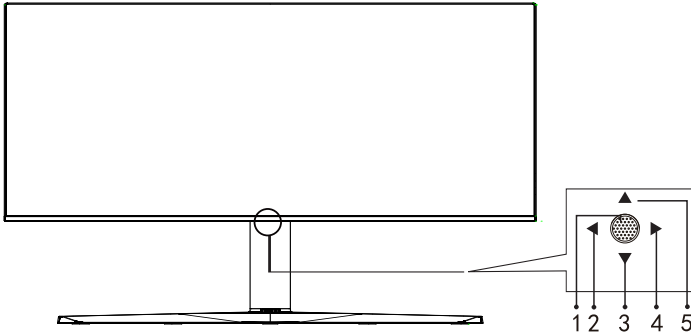

No.	Item	Description
1	Power button	Press the key to turn on the monitor, while press more than 5 seconds to turn off or short key confirmation.
2	Exit/Left button	Exit or return to the previous menu.
3	Down button	Move down in the menu.
4	Menu button	Enter sub-menus.
5	Up button	Move up in the menu.

Variable Refresh Rate:

It allows a graphics source that supports AdaptiveSync, G-Sync Compatibility, and FreeSync to dynamically adjust the display's refresh rate in line with typical content frame rates, delivering power-efficient, smooth, and low-latency visual performance.

Using the Shortcut Menu

The following content is for general reference only. Actual product specifications may vary. The OSD (On Screen Display) can be used to adjust the settings of your OLED monitor. Press the key to open the OSD. You can use the OSD to adjust the picture quality, OSD position and general settings. For advanced settings, please refer to following page:

Main page

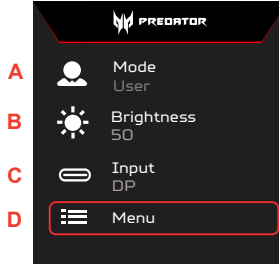

- A. **Hot Key1:** Modes, Brightness, Volume, Gamma, Contrast ,PIP/PBP
- B. **Hot Key2:** Modes, Brightness, Volume, Gamma, Contrast ,PIP/PBP
- C. **Hot Key3:** Input Switch Hot Key
- D. **Main Menu**

Input

Open the Input control and select DP or HDMI input source. When you are done, use  to go back one level.



Hot key1 (default: Mode)

To choose scenario mode (G1, G2, G3) which user-defined profile to use or scenario mode (User, Standard, ECO, Graphics, HDR).

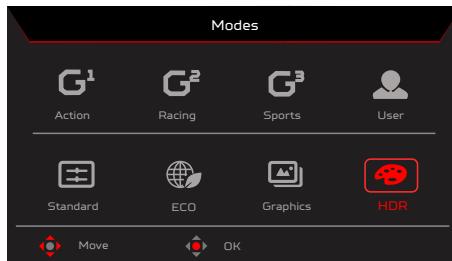

Hot key2 (default: Brightness)

Open the Brightness control and select the brightness setting. When you are done, use  to go back one level.



Main Menu

The Function page

Open the Function page to select a menu function, and adjust the settings which you want using the arrows. You can also view your monitor's system information from this page. When you are done, use **←** to go back one level.

1. Press the **Main Menu** key to open the OSD.
2. Use direction key to the up or down to select Picture from the OSD. Then press **Enter** to go into the element you wish to adjust.
3. Use direction key to the left or right to adjust the sliding scales.

Game Assistant

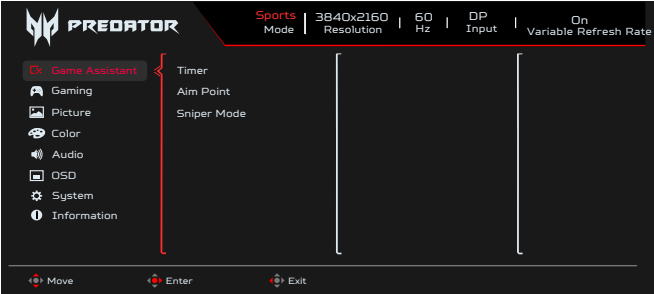

1. Press the MENU key to open the OSD.
2. Toggle the joystick **↔** to the up **▲** or down **▼** to select Game Assistant from the OSD. Then toggle to the right to the function you wish to adjust and press the joystick to enter it.
3. Toggle to the up **▲** or down **▼** to control functions.
4. The Game Assistant menu can be used to adjust the Timer, Aim Point.
5. Timer:OSD Shows the timer on monitor top-left side.



Note: 1. If user select 30mins, OSD will countdown the timer from 30:00 to 00:00.
2. when the Timer Set On, the Aim Point and Refresh Rate Num is gray out.

6. Aim point: Show an Aim point on the screen for shooting games.



Note: If hot key menu or main menu is trigger the "Aim point" temporarily closed.

7. Sniper Mode: Accessibility for games.
 - Scope Mode
 - Scope Ratio: To control the content magnification ratio.
 - Scope Size: To control the scope window size.
 - Scope with Night Vision: To control the night view effect.
 - Scope Ratio: Choose scope ratio(1.5x,2x,4x), default is 2x.
 - Scope Size : Choose scope size(Small,Middle,Large), default is Middle.
 - Scope with Night Vision: To filter R&B channel.





Scope with Night Vision: Off

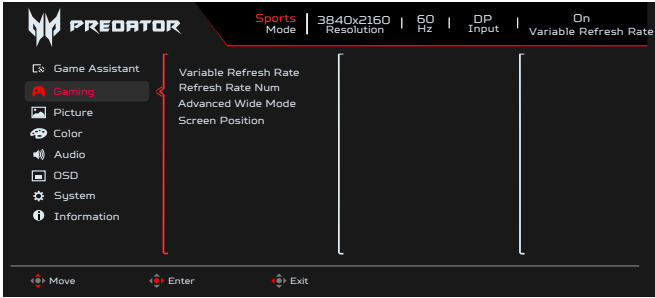

Scope with Night Vision: On





1. Press the MENU key to open the OSD.
2. Toggle the joystick  to the up  or down  to select Gaming from the OSD. Then toggle to the right to the function you wish to adjust and press the joystick to enter it.
3. Toggle to the up  or down  to control functions.
4. The Gaming menu can be used to adjust the Variable Refresh Rate, Refresh Rate Num, Advanced Wide Mode, Screen Position.
5. Variable Refresh Rate: It allows a graphics source that supports AdaptiveSync, G-Sync Compatibility, and FreeSync to dynamically adjust the display's refresh rate in line with typical content frame rates, delivering power-efficient, smooth, and low-latency visual performance.
6. Refresh Rate Num: Display the panel's current refresh rate on the screen.



Note: If Variable Refresh Rate set "On" you can see the V Frequency to changes in the OSD.

7. Advanced Wide Mode: You can select which screen size you are using. The options are Off, 22", 23.8", 24", 24.5".



Note: Only available in single screen/extended screen mode.
When the laptop and screen are in synchronized display mode, the output resolution may be abnormal.

8. Screen Position: Default is "0". User can select "2", "1", "0", "-1", or "-2".

Screen Position = 0, Center

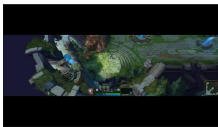

Screen Position = 2, Top

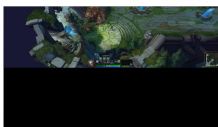

Screen Position = -2, Bottom

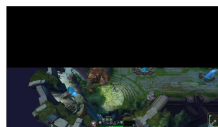

Screen Position = 1, Between Center and

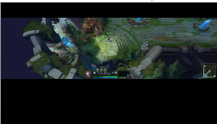

Screen Position = -1, Between Center and

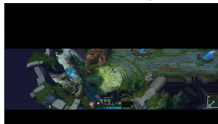

Picture



1. Press the MENU key to open the OSD.
2. Toggle the joystick to the up or down to select Picture from the OSD. Then toggle to the right to navigate to the element you wish to adjust and press the joystick to enter it.
3. Toggle the joystick to the left or right to adjust the sliding scales.
4. Brightness: Adjust the brightness from 0 to 100.



Note: Adjusts the balance between light and dark shades. Default Brightness will vary depending on the sales area.

5. Contrast: Adjust the contrast from 0 to 100.



Note: Sets the degree of difference between light and dark areas.

6. Black Boost: Adjust the black level from 0 to 10. Enhances shadows by increasing the brightness without changing lighter shades.



Note: If the image is very bright or has few shadow areas, adjusting this setting may not result in any noticeable changes to the image.

7. HDR: Can control (Off/Auto/HDR1000(Max)) the default is off, set to auto will automatically detect and deal with HDR signal.



Note:

1. When HDR = Auto, HDR1000 the Modes will also be automatically set to "HDR".
2. When HDR = Auto, HDR1000 some parameters: (ACM, Gamma, Contrast, Black Boost...) functions is gray out and disable, and if you change other adjustable parameters, the "Modes" will not jump to "User" Mode.
3. Because Xbox currently does not support HDR at FHD resolution, HDR function cannot be enabled while connected to Xbox.

8. Super Sharpness: technology can simulate high-resolution images by boosting the pixel density of the original source. It can make images sharper and clear.

9. Low Blue Light: Filters out blue light to protect your eyes (Standard / Level 1 /Level 2 / Level 3 / Level 4).



Note: The lower the level is, the more blue light passes through.

10. Max Brightness:Default is off.









Note: Due to environmental considerations,the default brightness of the display will be low. It can be adjusted to your preferences with the following steps:
step1:Go to OSD menu> picture > Max Brightness,and turn Off to On to increase the brightness.

step2: Once Max Brightness is turned on,adjust Brightness value between 0-100 to your preference.

Color



1. Press the MENU key to open the OSD.
2. Toggle the joystick  to the up  or down  to select Color from the OSD. Then toggle to the right to navigate to the element you wish to adjust and press the joystick to enter it.
3. Toggle the joystick  to the left  or right  to adjust the sliding scales.
4. The Color menu can be used to adjust the Modes, Color Space, GrayScaler Mode, Gamma, Color Temp,6-axis Hue, 6-axis Saturate.
5. Modes: Select your preferred mode from Action, Racing, Sports, User, Standard, ECO, Graphics and HDR.
6. Color Space: You can choose Standard, SMPTE-C, DCI, EBU, HDR, Rec.709 or sRGB.







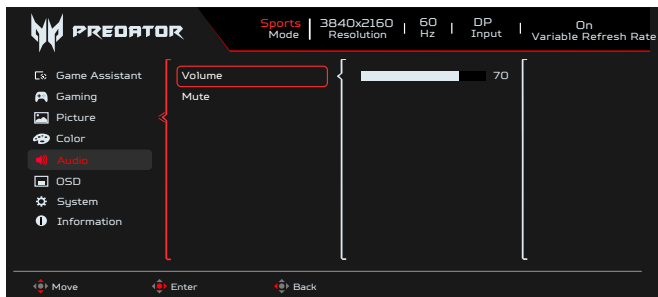

Note: 1. If Color Space is "HDR", then Modes is set to "HDR" automatically.
2. If Color Space not "HDR", then Modes is set to "Standard".

7. Grayscale Mode: Turn grayscale mode On or Off. The default is off.
8. Gamma mode allows you to adjust the luminance tone. The default value is 2.2 (standard value for Windows).
9. Color Temp.: Default is warm. You can choose Normal, User,Cool and Warm.
10. 6-axis Hue: Adjust the red, green, blue, yellow, magenta and cyan hue.
11. 6-axis Saturate: Adjust the red, green, blue, yellow, magenta and cyan saturation.







Audio

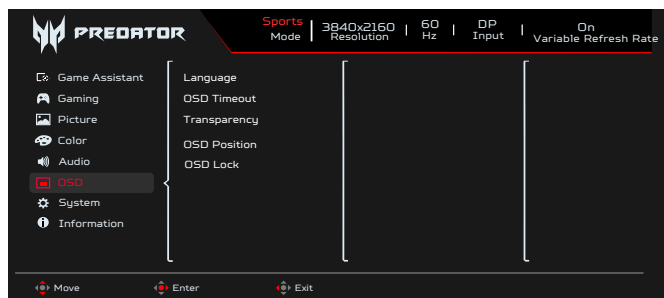

1. Press the MENU key to open the OSD.
2. Toggle the joystick  to the up  or down  to select Audio from the OSD. Then toggle to the right to navigate to the element you wish to adjust and press the joystick to enter it.
3. Toggle the joystick  to the left  or right  to adjust the sliding scales.
4. The Audio menu can be used to adjust the Volume, Mute.
5. Volume: Adjust the volume.
6. Mute: To choose mute on/off .

OSD



1. Press the MENU key to open the OSD.
2. Toggle the joystick  to the up  or down  to select OSD from the OSD. Then toggle to the right to navigate to the element you wish to adjust and press the joystick to enter it.
3. Toggle the joystick  to the left  or right  to adjust the sliding scales.
4. The OSD menu can be used to adjust the Language, OSD Timeout, Transparency, OSD Lock.
5. Language: Set the OSD menu language.
6. OSD Timeout: Adjust the delay before turning the off the OSD menu.
7. Transparency: Select the transparency when using gaming mode. The transparency can be 20%, 40%, 60%, 80%, or Off.
8. OSD Position: The OSD position default is Center, and the display position can be changed to (Top Left, Top Right, Bottom Right, Bottom Left, and Center).

9. OSD Lock: OSD Lock function is used to prevent OSD button from being pressed accidentally.



Note: 1. OSD Locked:

Set the OSD Lock to "On" from the OSD and press "Enter".

The "OSD Locked" message will appear in the middle of the screen, and LED lights will indicate as blinking blue.





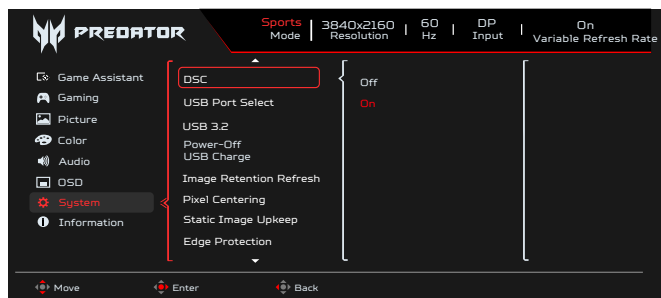
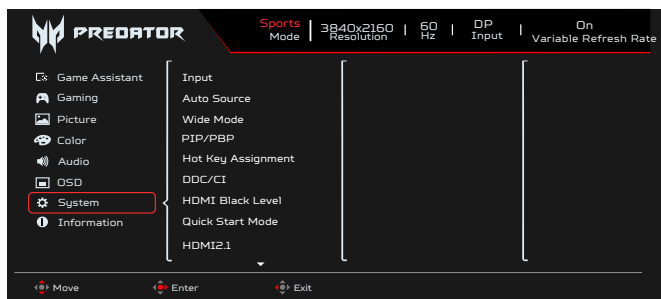

When pressing any key, "OSD Locked" message will be prompted.

2. OSD Unlocked:

Press the second OSD key continuously for 3 seconds to unlock OSD. The "OSD Unlocked" message will appear in the middle of the screen, and LED lights will turn into blue.

System



1. Press the MENU key to open the OSD.
2. Toggle the joystick  to the up  or down  to select System from the OSD. Then toggle to the right to navigate to the element you wish to adjust and press the joystick to enter it.
3. Toggle the joystick  to the left  or right  to adjust the sliding scales.

4. System menu can be used to select signal input sources and other important settings, including input types.
5. Input: Select the source from HDMI1, HDMI2, DP1, DP2, DP ALT.
6. Auto Source: Automatically searches for available input sources.
7. Wide Mode: You can select which screen aspect you are using. The options are Full, Aspect, 1:1 and 21:9.
8. PIP/PBP: The options for PIP/PBP Mode are Off, PIP Large, PIP Small, and PBP. You can also adjust the PIP Position, Sub Source, Source Swap, and Audio Source.



.....
Note: PIP/PBP is not supported while FreeSync Premium is "On"

9. Hot Key Assignment: Select the function of Hot Key 1 or Hot Key 2.
10. DDC/CI: Allows the monitor settings to be set through the software on the PC.



.....
Note: DDC/CI, short for Display Data Channel/Command Interface, which allows monitor controls to be sent via software.

11. HDMI Black Level: You can select the level of blackness under HDMI source.
12. Quick Start Mode: Select Off or On. The default is "Off". Turn on to speed up boot speed.
13. HDMI 2.1: Select to set HDMI 2.1.
14. DSC: The default is "On", Support DP&HDMI has DSC Function.



.....
Note: 1. DSC = "On" is Default

Support DP& HDMI.

All can support max resolution must refer to the "Max Refresh Rate".

2. DSC = "Off"

For some devices such as mobile phones, DSC needs to be set to Off to display properly.

Resolutions that can be supported will depend on the capabilities of the graphics card, and may not be able to display 3840x2160@240Hz.

15. USB Port Select: Set the USB port type to C-Type or B-Type or Auto.
16. USB 3.2: USB 3.2 = "On"
 DP ALT support timing by source.
 Support DP ALT (2 lane).
 USB 3.2="Off" is default
 DP ALT supports maximum resolution which is the reference system condition and the output capability of the device.
 Support DP ALT (4 lane).
17. Power-off USB Charge: Select 'On' to supply power to the USB port and select 'Off' to turn on DC off/Power saving mode.



.....
Note: 1. To comply with international energy standards, this display is currently set to power saving mode, which disables certain functions when display is put to sleep (standby) and has power off (DC off) status.

18. **Image Retention Refresh:** To reduce the risk of image retention occurrence, if the monitor has been in use for Image Retention. Refresh more than 4 hours, Image Retention Refresh, will start automatically after the monitor is turned off. You can also start Image Retention Refresh manually via OSD menu. When Image Retention Refresh process begins, the monitor will display a warning message, the power LED starts flashing blue and amber light alternately. When the power LED lights off, this indicates the Image Retention Refresh process is complete, the duration of the Image Retention Refresh is around 5 minutes.



Note: During Image Retention Refresh process don't turn off monitor and don't unplug the power.

Setting the KVM





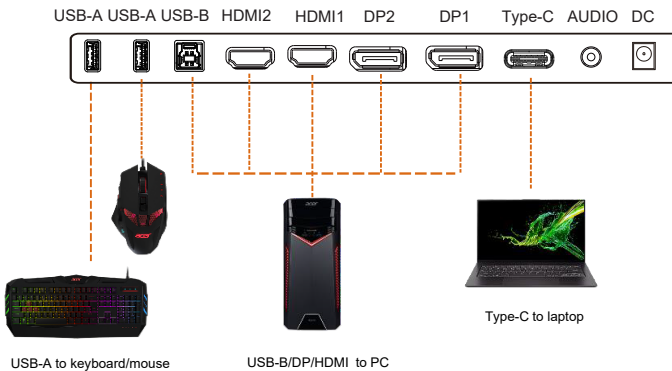

- You can follow below instruction to set up KVM for your monitor:
 - Connect Type-C/USB-B to your computer
 - Select Type-C/USB-B of USB Port Select in the OSD
 - Suggest setup:

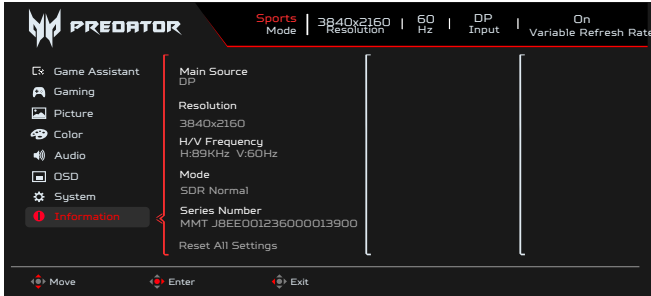

Note: When connecting two computers to the monitor, configure the USB settings from the OSD menu to share a single set of keyboard and mouse connected to the monitor between two computers.



Information

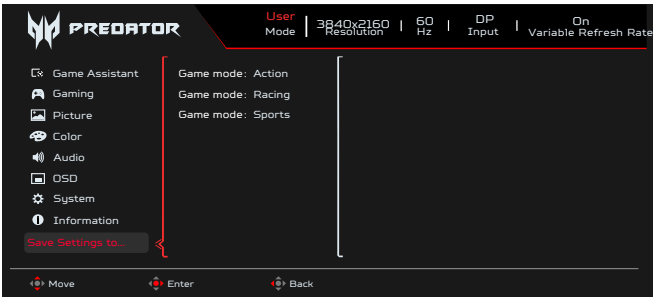

1. Press the MENU key to open the OSD.
2. Toggle the joystick  to the up  or down  to select Information Page to view the basic information for your monitor and current input.
3. Reset All Settings: Reset the custom color settings to factory defaults.

Save Setting to...(User mode only)



1. Press the MENU key to open the OSD.
2. Using the  /  button, select "Save Setting to..." from the OSD. Then select the preferred mode.
3. Save Setting to Game mode: There are three user-defined profiles available (Action, Racing and Sports). Save your customized settings to the Game mode in order to implement those settings automatically when you select it afterwards.

TROUBLESHOOTING

Before sending your OLED monitor for servicing, please check the troubleshooting list below to see if you can self-diagnose the problem.

HDMI/DP Mode (Optional)

Problems	Current Status	Remedy
No Picture	Blue	Using OSD, adjust brightness and contrast to maximum or reset to their default settings.
	Blinking Blue	Check if signal cable is properly connected, which can be determined by plugging and unplugging the cable. Check if the PC is functioning properly or in the Hibernate mode. To wake the PC from Sleep mode, you can click the mouse or tap any key on the keyboard.
	LED OFF	Check the power switch. Check if AC power cord is properly connected to the monitor.

Recycling Information for the United States of America

Acer encourages information technology (IT) equipment owners to responsibly recycle their equipment when it is no longer needed. Acer offers programs and services to assist equipment owners with this process.

For more information on recycling IT equipment, please go to:

<https://www.acer.com/ac/en/US/content/recycling>



Product Information for EU Energy Label