

# ThinkPad®

## ThinkPad X1 Carbon Gen 13 and ThinkPad X1 2-in-1 Gen 10 User Guide



Lenovo

## **Read this first**

Before using this documentation and the product it supports, ensure that you read and understand the following:

- *Safety and Warranty Guide*
- *Setup Guide*
- [Generic Safety and Compliance Notices](#)

**Second Edition (April 2025)**

**© Copyright Lenovo 2025.**

LIMITED AND RESTRICTED RIGHTS NOTICE: If data or software is delivered pursuant to a General Services Administration "GSA" contract, use, reproduction, or disclosure is subject to restrictions set forth in Contract No. GS-35F-05925.

---

# Contents

## Discover your Lenovo notebook. . . . . v

### Chapter 1. Meet your computer. . . . . 1

Front view . . . . .	1
Side view . . . . .	5
Bottom view . . . . .	6
Features and specifications . . . . .	8
USB specifications. . . . .	8

### Chapter 2. Get started with your computer. . . . . 11

Set up your computer . . . . .	11
Turn on the computer. . . . .	11
Complete the operating system setup . . . . .	12
Access networks . . . . .	12
Connect to Wi-Fi networks. . . . .	12
Connect to the wired Ethernet . . . . .	12
Connect to a cellular network (for selected models) . . . . .	13
Turn on Airplane mode . . . . .	14
Manage power . . . . .	14
Check the battery status . . . . .	14
Charge the computer with ac power . . . . .	14
Maximize the life of the battery . . . . .	14
Charge your computer with P-to-P 2.0 charging function . . . . .	15
Change the power settings . . . . .	15
Enable Flip to Start. . . . .	15
Interact with your computer . . . . .	16
Use the keyboard shortcuts . . . . .	16
Use the TrackPoint pointing device . . . . .	17
Use the Haptic Touchpad (for selected models) . . . . .	19
Use the Trackpad (for selected models). . . . .	20
Use the touch screen (for selected models) . . . . .	23
Connect to an external display . . . . .	26
Get to know convertible multi-modes . . . . .	27
Use Lenovo Yoga Pen (for selected models). . . . .	28

### Chapter 3. Explore your computer . . . . . 33

Lenovo apps . . . . .	33
Lenovo Commercial Vantage. . . . .	33
Lenovo AI Now (for selected models). . . . .	33
TrackPoint Quick Menu . . . . .	34
Lenovo AURA EDITION Experiences. . . . .	36
Smart Modes . . . . .	36
Smart Share . . . . .	36
Smart Care. . . . .	37

Copilot in Windows . . . . .	38
Global Power Management . . . . .	38
Transfer data . . . . .	39
Connect to a Bluetooth device . . . . .	39
Set up an NFC connection. . . . .	40

### Chapter 4. Secure your computer and information . . . . . 41

Lock the computer . . . . .	41
Log in with fingerprint recognition . . . . .	41
Log in with facial recognition. . . . .	42
Lock on leave function (for selected models) . . . . .	42
Change the settings . . . . .	42
User Presence Sensing (for selected models) . . . . .	43
Change the settings from the Vantage app . . . . .	44
Use the ePrivacy screen (for ThinkPad X1 2-in-1 Gen 10 only) . . . . .	44
Use the password privacy function . . . . .	45
Protect data against power loss . . . . .	45
USB-C Restricted Mode . . . . .	45
UEFI BIOS passwords . . . . .	46
Password types . . . . .	46
Set, change, or remove a password . . . . .	47
FIDO (Fast Identity Online) authentication. . . . .	48
Register FIDO2 USB device in ThinkShield Passwordless Power-On Device Manager. . . . .	48
Log in to the System with Passwordless Power-On Authentication . . . . .	49
Supervisor Certificate . . . . .	49

### Chapter 5. Configure advanced settings. . . . . 51

UEFI BIOS . . . . .	51
Enter the UEFI BIOS menu. . . . .	51
Navigate the UEFI BIOS menu . . . . .	51
Customize BIOS Defaults . . . . .	51
ThinkShield secure wipe . . . . .	52
Detect memory retraining . . . . .	52

### Chapter 6. Frequently asked questions. . . . . 53

Camera problems . . . . .	53
Audio problems. . . . .	53
Mouse problems . . . . .	54
Keyboard problems . . . . .	55
My keyboard does not work . . . . .	55
My keyboard backlight does not work . . . . .	56
Battery problems . . . . .	56

My computer battery discharges quickly . . . . .	56
My computer battery is not recognized . . . . .	57
My computer battery icon disappears . . . . .	57
Display problems . . . . .	57
Blue screen . . . . .	57
Black screen . . . . .	58
Screen flickering. . . . .	58
My external display does not work. . . . .	59
My display remains dim . . . . .	59
Fingerprint reader problems . . . . .	60
Fingerprint recognition cannot be set up . . . . .	60
Fingerprint enrollment error . . . . .	61
Fingerprint recognition error . . . . .	61
Touchpad or trackpad problems . . . . .	62
My touchpad or trackpad does not respond . . . . .	62
My touchpad or trackpad responds slowly . . . . .	63
Touch screen problems. . . . .	63
Fan problems. . . . .	64
Loud fan noise . . . . .	64
Computer overheating . . . . .	64
Hinge problems . . . . .	65
My computer hinges lose torque . . . . .	65
My computer cannot be opened or closed . . . . .	65
Pen problems . . . . .	65
USB problems . . . . .	66
My USB connector does not work . . . . .	66
Recover data from a USB drive . . . . .	66
Create a recovery drive . . . . .	67
Copilot key problems . . . . .	67
Bluetooth connection problems . . . . .	68
Network connection problems . . . . .	69
Power charging problems . . . . .	70
My computer is not charged when connected to ac power . . . . .	70
My built-in battery cannot be charged . . . . .	71
My built-in battery is not fully charged . . . . .	71
Startup problems . . . . .	72
My computer does not start up . . . . .	72
Windows login error . . . . .	72
Blue screen during the startup . . . . .	72
Performance problems . . . . .	73
My computer does not work . . . . .	73
My computer responds slowly . . . . .	73
Password problems . . . . .	74
Change my Windows password. . . . .	74
Reset my Windows password . . . . .	74
Retrieve my BitLocker recovery key in Windows . . . . .	75
OS problems . . . . .	75
Install a Windows operating system . . . . .	75

Windows operating system installation error . . . . .	76
Upgrade my Windows operating system . . . . .	77
Windows operating system upgrading error . . . . .	78
Recover my Windows operating system . . . . .	78
Windows operating system recovery error. . . . .	79
Driver problems. . . . .	79
Update or install the latest device driver . . . . .	79
Driver installation error . . . . .	80
UEFI BIOS problems . . . . .	81
Update the UEFI BIOS . . . . .	81
Recover the UEFI BIOS . . . . .	81
Reset system to factory defaults . . . . .	82
Self-help resource . . . . .	82

## **Chapter 7. Help and support . . . . . 87**

Error messages . . . . .	87
Battery-charge LED indicator diagnosis . . . . .	87
Diagnostics tool. . . . .	89
Troubleshoot and diagnose at Lenovo Support Web site . . . . .	89
Hardware scan . . . . .	90
UEFI Diagnostics tool. . . . .	90
Lenovo Memory Self Repair . . . . .	91
Windows label . . . . .	91
Call Lenovo . . . . .	92
Before you contact Lenovo . . . . .	92
Find your service QR code and serial number . . . . .	92
Lenovo Customer Support Center. . . . .	93

## **Chapter 8. CRU replacement . . . . . 95**

CRU list . . . . .	95
Before you replace any CRU . . . . .	95
Disable Fast Startup . . . . .	96
Disable the built-in battery. . . . .	96
Replace a CRU . . . . .	96
Base cover assembly . . . . .	96
Built-in battery . . . . .	98
Wireless WAN module and wireless WAN module bracket (for selected models) . . . . .	100
M.2 solid-state drive and M.2 solid-state drive bracket . . . . .	105

## **Appendix A. Compliance information. . . . . 107**

## **Appendix B. Accessibility features . . . . . 111**

## **Appendix C. Notice for USB connector name update . . . . . 115**



**Appendix D. Notices and  
trademarks. . . . .117**



---

## Discover your Lenovo notebook

**Thank you for choosing a Lenovo® notebook! We are dedicated to delivering the best solution to you.**

Before starting your tour, please read the following information:

- Illustrations in this documentation might look different from your product.
- Depending on the model, some optional accessories, features, software programs, and user interface instructions might not be applicable to your computer.
- Documentation content is subject to change without notice. To get the latest documentation, go to <https://pcsupport.lenovo.com>.





---

## Chapter 1. Meet your computer

ThinkPad X1 Carbon Gen 13 and ThinkPad X1 2-in-1 Gen 10 are Lenovo AURA EDITION products with a collection of premium, uncompromising, and exclusive experiences where endless possibilities meet ultimate personalization.









---

### Front view

Have a quick glance at the front view of your computer.

#### ThinkPad X1 Carbon Gen 13











Item	Description	Item	Description
	Microphone		Infrared camera
	Webcam privacy shutter		Touch screen*
	TrackPoint® pointing stick		Fingerprint reader
	NFC (near field communication) mark*		Haptic Touchpad / Trackpad
	TrackPoint buttons		

\* for selected models

**Note:** Depending on the model, your computer comes with either a Trackpad or a Haptic Touchpad.

### ThinkPad X1 2-in-1 Gen 10



Item	Description	Item	Description
	Microphone		Infrared camera
	Webcam privacy shutter		Touch screen
	TrackPoint® pointing stick		Fingerprint reader
	NFC (near field communication) mark*		Haptic Touchpad / Trackpad
	TrackPoint buttons		

\* for selected models

**Note:** Depending on the model, your computer comes with either a Trackpad or a Haptic Touchpad.



## Webcam privacy shutter

Slide the webcam privacy shutter to cover or uncover the camera lens. It is designed to protect your privacy.

### Related topics

- “Use the TrackPoint pointing device” on page 17
- “Use the Haptic Touchpad (for selected models)” on page 19
- “Use the Trackpad (for selected models)” on page 20
- “Use the touch screen (for selected models)” on page 23
- “Log in with fingerprint recognition” on page 41
- “Log in with facial recognition” on page 42
- “Lock on leave function (for selected models)” on page 42

### Important information



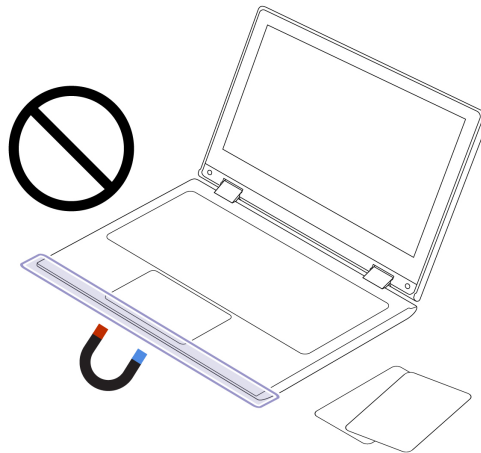



Your computer contains magnets. Keep a safe distance away from devices and objects that might be affected by magnets, such as credit cards.

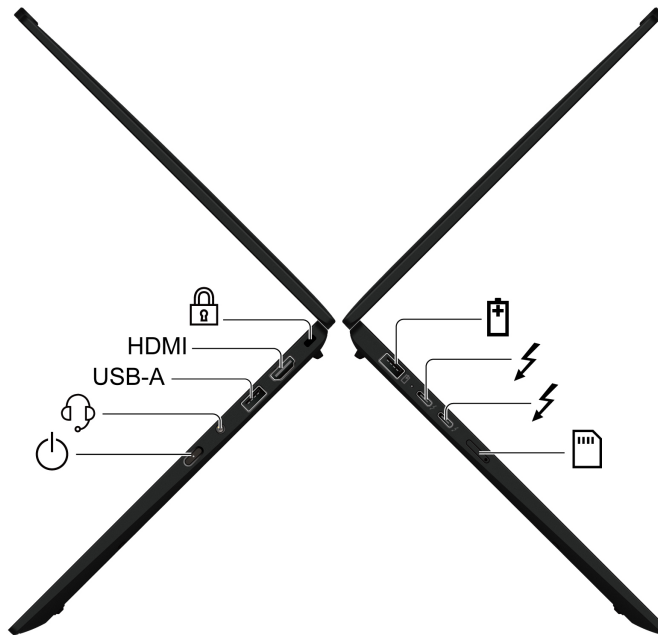

## Side view

Have a quick glance at ports on both sides of your computer.



Item	Description	Item	Description
	USB-A connector (USB 5Gbps, Always On USB)		USB-C® connector (Thunderbolt™ 4)
	Nano-SIM-card tray*		Power button
	Audio connector	USB-A	USB-A connector (USB 5Gbps)
HDMI	HDMI™ connector		Security-lock slot

**Note:** For more information about the USB connector name update, see Appendix C “Notice for USB connector name update” on page 115.

### Statement on USB transfer rate

Depending on many factors such as the processing capability of the host and peripheral devices, file attributes, and other factors related to system configuration and operating environments, the actual transfer rate using the various USB connectors on this device will vary and will be slower than the data rate listed in the connector name or below for each corresponding device.

USB device	Data rate (Gbps)
Thunderbolt 3	40
Thunderbolt 4	40

## Related topics

- “USB specifications” on page 8
- “Connect to a cellular network (for selected models)” on page 13
- “Manage power” on page 14
- “Connect to an external display” on page 26
- “Lock the computer” on page 41

---

## Bottom view

Have a quick glance at the bottom part of your computer.

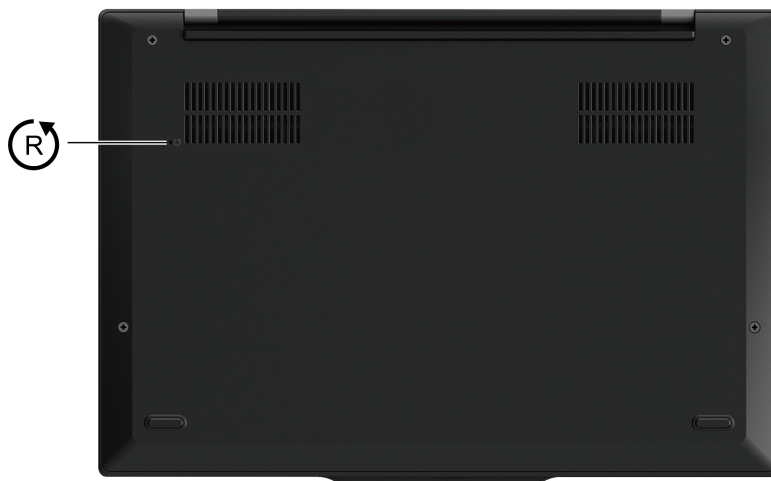

### Emergency-reset hole

Emergency-reset hole can help you to recover computer when the computer stops responding and you cannot turn it off by pressing the power button. Do the following to reset your computer:

- Step 1. Disconnect your computer from ac power.
- Step 2. Insert a straightened paper clip into the hole to cut off power supply temporarily.
- Step 3. Connect your computer to ac power and then turn on your computer.

If your computer is still no response, you can call Lenovo Customer Support Center to get further help.

### **CAUTION:**

**When the computer is operating, it should be placed on a hard and flat surface with its bottom area not in contact with user’s bare skin. Under normal operating conditions, the temperature of the bottom surface will remain within an acceptable range as defined in IEC 62368-1, but such temperatures can still be high enough to cause discomfort or harm to the user if directly touched for over one minute at a time. As such, it is recommended that users avoid prolonged direct contact with the bottom of the computer.**

**Note:** Some Lenovo computers include a display that can be rotated 360 degrees. When those products are used as a tablet computer, the temperatures of all the accessible parts are within an acceptable range as defined in IEC 62368-1.



---

## Features and specifications

Get to know more hardware and software details of your computer.

Specification	Description
Memory	Low Power Double Data Rate 5X (LPDDR5X), soldered on board, up to 64 GB
Storage device	One slot, 2280 M.2 solid-state drive, up to 2 TB <b>Note:</b> In case of M.2 SSD replacement, your computer only supports single-sided M.2 SSD. Double-sided M.2 SSD is not applicable due to the height limitation of the slot.
Audio	<ul style="list-style-type: none"><li>• Dolby Atmos®</li><li>• Dolby Voice®</li></ul>
Display	<ul style="list-style-type: none"><li>• 2.8 K, 120 Hz refresh rate OLED display or WUXGA LCD display</li><li>• Display ratio: 16:10</li><li>• Display resolution: 2880 x 1800 pixels or 1920 x 1200 pixels</li><li>• Multi-touch technology*</li><li>• TUV Eye Safe certified</li></ul>
Security features	<ul style="list-style-type: none"><li>• Face authentication</li><li>• Lock on leave*</li><li>• User Presence Sensing*</li><li>• Fingerprint reader</li><li>• Privacy Guard*</li><li>• Privacy Alert*</li><li>• Trusted Platform Module (TPM)*</li></ul>
Wireless features	<ul style="list-style-type: none"><li>• Bluetooth</li><li>• NFC*</li><li>• GPS (on wireless WAN model)*</li><li>• Wireless LAN</li><li>• Wireless WAN (4G or 5G)*</li></ul> <p><b>Note:</b> The 4G or 5G cellular service is provided by authorized mobile service carriers in some countries or regions. You must have a cellular plan from a service carrier to connect to the cellular network. The cellular data plan might vary by location.</p>

\* for selected models

## USB specifications

Get to know more USB specifications.

### Notes:

- Depending on the model, some USB connectors might not be available on your computer.

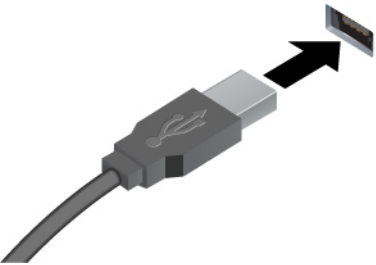
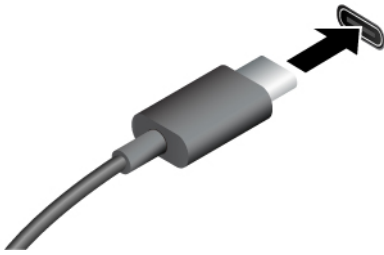

- On very rare occasions, the USB-C compatible devices connected to the USB-C connector might interfere with the wireless feature. If your computer cannot be connected to the Wi-Fi or cellular network, or if your location cannot be pinpointed through the GPS function, detach the USB-C compatible devices from the USB-C connector.

Connector name	Description
 <ul style="list-style-type: none"> <li>• USB-A connector (Hi-Speed USB)</li> <li>• USB-A connector (USB 5Gbps)</li> <li>• USB-A connector (USB 10Gbps)</li> </ul>	<p>Connect USB-compatible devices, such as a USB keyboard, USB mouse, USB storage device, or USB printer.</p>
 <ul style="list-style-type: none"> <li>• USB-C connector (USB 5Gbps)</li> <li>• USB-C connector (USB 10Gbps)</li> <li>• USB-C connector (Thunderbolt 3)</li> <li>• USB-C connector (Thunderbolt 4)</li> <li>• USB-C connector (USB4 40Gbps)</li> <li>• USB-C connector (DP Alt mode DP 2.1)</li> </ul>	<ul style="list-style-type: none"> <li>• Charge USB-C compatible devices with the output voltage and current of 5 V and 1.5 A.</li> <li>• Connect to an external display: <ul style="list-style-type: none"> <li>– USB-C to VGA: up to 1920 x 1200 pixels, 60 Hz</li> <li>– USB-C to DP 1.4: up to 5120 x 3200 pixels, 60 Hz</li> <li>– USB-C to DP 2.1: up to 7680 x 4320pixels, 60 Hz</li> </ul> </li> <li>• Connect to USB-C accessories to help expand your computer functionality. To purchase USB-C accessories, go to <a href="https://www.lenovo.com/accessories">https://www.lenovo.com/accessories</a>.</li> </ul>



---

## Chapter 2. Get started with your computer

This chapter introduces the instructions of setting up your computer, various ways to connect to networks, and to interact with your computer.

---

### Set up your computer

This section helps you to set up your computer and get it ready for use.

### Turn on the computer

Follow the instructions to turn on your computer.

Step 1. Connect the ac power cord to the ac power adapter.

Step 2. Connect the dc cable to your computer.

Step 3. Plug the ac power cord into the ac power.

Step 4. Press the power button to turn on your computer.



#### Notes:

- The appearance varies depending on the computer model.
- Some models might not ship with ac adapters or power cords. Use only the certified adapters and power cords provided by Lenovo that comply with the requirements of relevant national standards to charge the product. It is recommended to use the Lenovo qualified adapters. You can refer to <https://www.lenovo.com/us/en/compliance/eu-doc>.
- It is recommended to fully charge the computer when using it for the first time. Click the battery status icon at the bottom right of your desktop to check the battery status.

#### Related topics

- “Check the battery status” on page 14
- “Charge the computer with ac power” on page 14

## Complete the operating system setup

Before exploring your computer, you need to complete the operating system setup. The setup includes but is not limited to:

- Select the country or region.
- Connect to an available network.
- Accept the license agreement.
- Create a Microsoft account or log in with your Microsoft account.
- Set up your password, fingerprint, or facial recognition as preferred.
- Customize your experience.

### Notes:

- Depending on the model, some settings might not be available on your computer.
- Do not turn off your computer and ensure it is connected to the ac power during the whole process.

Follow the instructions to set up the operating system.

Step 1. Connect the computer to the ac power and turn it on.

Step 2. Follow the on-screen instructions to complete the operating system setup.

### Related topics

- “Log in with your fingerprint” on page 41
- “Log in with facial recognition” on page 42
- “Set, change, or remove a password” on page 47

---

## Access networks

This section helps you connect to a wireless or wired network.

### Connect to Wi-Fi networks

Click the network icon  on the bottom right of your display to connect to an available network. Provide required information, if needed.

**Note:** The wireless LAN module on your computer might support different standards. For some countries or regions, use of 802.11ax might be disabled according to local regulations.

### Connect to the wired Ethernet

To connect your computer to a local network, you need a Lenovo USB-C to Ethernet Adapter. Lenovo USB-C to Ethernet Adapter is available as an option and shipped with some computer models. You can purchase one from Lenovo at <https://www.lenovo.com/accessories>.

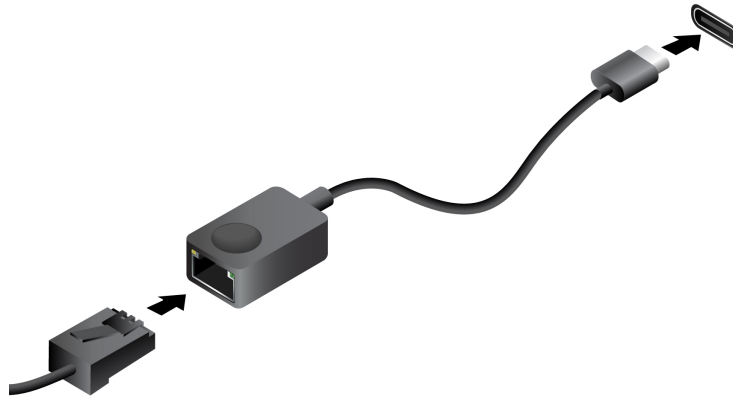

## Connect to a cellular network (for selected models)

To connect a 4G or 5G cellular data network, you must have a wireless wide area network (WWAN) module and a nano-SIM card installed. The nano-SIM card might come with your computer by countries or regions. If no nano-SIM card is shipped, you will need to purchase one from authorized service carriers.

### Notes:

- Depending on the model, your computer might have no WWAN module installed.
- The 4G or 5G cellular service is provided by authorized mobile service carriers in some countries or regions. You must have a cellular plan from a service carrier to connect to the cellular network. The cellular data plan might vary by location.
- Network connection speeds might also vary by location, environment, network conditions and other factors.

## Establish a cellular connection

This section introduces how to establish a cellular connection.

Step 1. Turn off the computer.

Step 2. Insert a straightened paper clip into the hole in the nano-SIM-card tray. The tray ejects. Install a nano-SIM card as shown and insert the tray into the nano-SIM card slot. Note the orientation of the card and ensure that it is seated correctly.

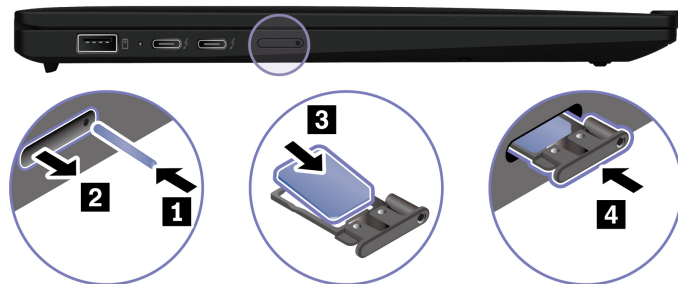

Step 3. Turn on the computer.

Step 4. Click the network icon, and then select the cellular network icon  from the list. Provide required information, if needed.

## Turn on Airplane mode

You might need to turn on Airplane mode if you board an airplane. When Airplane mode is on, all wireless features are turned off automatically. Click the network icon  on the bottom right of your display to turn on Airplane mode.

**Note:** You can enable Wi-Fi networks in this mode according to your actual needs.

---

## Manage power

Use the information in this section to achieve the best balance between performance and power efficiency.

### Check the battery status

Check the battery status to help use computer properly.

Go to **Settings** → **System** to check the battery status. For more details about your battery, refer to the Vantage app.

### Charge the computer with ac power

Power source of the ac power adapter:

- Power: 65 W
- Sine-wave input at 50 Hz to 60 Hz
- Input rating of the ac power adapter: 100 V to 240 V ac, 50 Hz to 60 Hz
- Output rating of the ac power adapter: 20 V dc, 3.25 A

When the battery power is low, charge your battery by connecting your computer to ac power with the supplied power adapter. The 65 W ac power adapter supports the rapid charge function, the battery is 80% charged in about one hour when the computer is turned off. The actual charging time depends on the battery size, the physical environment, and whether you are using the computer.

Battery charging is also affected by its temperature. The recommended temperature range for charging the battery is between 10°C (50°F) and 35°C (95°F).

**Note:** Some models might not ship with ac adapters or power cords. Use only the certified adapters and power cords provided by Lenovo that comply with the requirements of relevant national standards to charge the product. It is recommended to use the Lenovo qualified adapters. You can refer to <https://www.lenovo.com/us/en/compliance/eu-doc>.

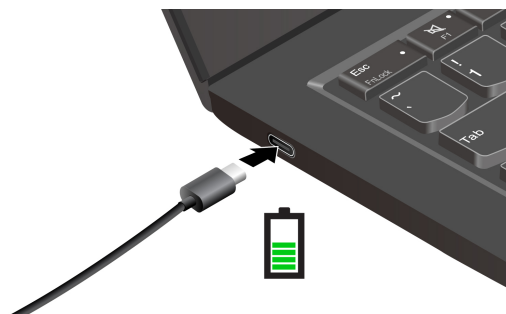

### Maximize the life of the battery

Follow the instructions to maximize the life of the battery.

- Use the battery until the charge is depleted and recharge the battery completely before using it. Once the battery is fully charged, it must discharge to 94% or lower before it will be allowed to recharge again.
- Keep the battery from full charge when it is not in heavy use. For more information, refer to the **Battery settings** tab in the **Power** section of the Vantage app.
- The battery might optimize its full charge capacity based on your usage. After prolonged periods of limited use, full battery capacity might not be available until you discharge to as low as 20% and recharge completely. For more information, refer to the **Battery settings** tab in the **Power** section of the Vantage app.

## Charge your computer with P-to-P 2.0 charging function

Both USB-C connectors (Thunderbolt 4) on the computer feature the Lenovo-unique P-to-P 2.0 (Peer to Peer 2.0) charging function.

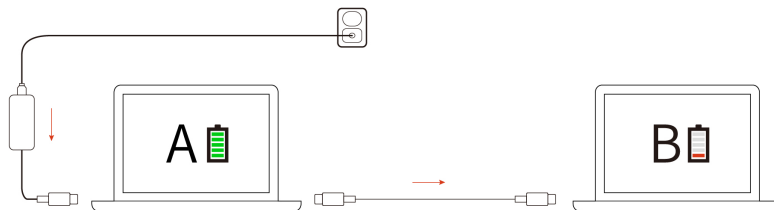

**Note:** The actual charging speed of your computer depends on many factors, such as the remaining battery power of the computers, the wattage of the ac power adapter, and whether you are using the computers.

To use the function, ensure that **Always On USB** and **Charge in Battery Mode** are enabled in UEFI BIOS of your computers, so that the function works even when the computers are off or in hibernation mode. To enable **Always On USB** and **Charge in Battery Mode**:

- Step 1. Restart the computer. When the logo screen is displayed, press F1 to enter to the UEFI BIOS menu.
- Step 2. Click **Config** → **USB**, and then to enable **Always On USB** and **Charge in Battery Mode**.

## Change the power settings

Follow the instructions to change the power settings of your preference.

For ENERGY STAR® compliant computers, the following power plan takes effect by default when your computer is on ac power and has been idle for a specified duration:

- Turn off the display: After 5 minutes
- Put the computer to sleep: After 5 minutes

To change the power plan, the power button function and other settings, do the following:

- Step 1. Go to **Control Panel** and view by Large icons or Small icons.
- Step 2. Click **Power Options**.
- Step 3. Change the settings as you prefer.

## Enable Flip to Start

Your computer supports Flip to Start feature. If you enable this feature, the computer will start up automatically without pressing power button when you open the lid.

Flip to Start feature is disabled by default. To enable Flip to Start feature:

1. Open the Vantage app, and then click **Device → Power → Power settings**.
2. Turn on the **Flip to start** toggle to enable the feature.

If the Vantage app is uninstalled, you can enable this feature in UEFI BIOS menu:

1. Restart the computer. When the logo is displayed, press F1 to enter the UEFI BIOS menu.
2. Select **Config → Power**.
3. Turn on the **Flip to start** toggle to enable the feature.

---

## Interact with your computer











Explore various ways to interact with your computer.

### Use the keyboard shortcuts

Keyboard shortcuts are keys or combinations of keys that provide a quick way to perform particular functions. They help you work more efficiently.



The following tables introduce the functions of keyboard shortcuts.

#### FnLock and function keys

Key / Key combination	Function description
	Switch between the special and standard functions of the function keys (F1–F12).
Fn+FnLock	Function keys provide two sets of functions: special function and standard function. Icons on the key denote the special function, such as  and  . Characters on the key denote the standard function, such as F1 and F2.  LED indicator on Esc key indicates which function of the function keys is enabled: <ul style="list-style-type: none"><li>• When the indicator is off, the special function is enabled.</li><li>• When the indicator is on, the standard function is enabled.</li></ul>
	Mute / Unmute (Speakers).
	Decrease volume.
	Increase volume.
	Enable / Disable the microphone.
	Decrease screen brightness.
	Increase screen brightness.
	Select and set up display devices.
Mode	Launch and hide the Smart Modes widget.
PrtSc	Print screen.
	Open Snipping Tool.
	Launch the Smart Share feature in the Intel® Unison™ app.
☆	Customize the function of this key on the Vantage app.



## Other general keyboard shortcuts

Key / key combination	Function description
	<ul style="list-style-type: none"><li>• Launch Copilot in Windows.</li><li>• Launch Windows Search.</li></ul> <b>Note:</b> The function varies by countries or regions.
Fn+ 	Open the context menu of the current active app.
Fn+ 	Adjust the keyboard backlight.
Fn+<	Go to beginning.
Fn+>	Go to end.
Fn+Tab	Open Magnifier. <b>Note:</b> Press the Windows logo key+Esc to turn it off.
Fn+4	Enter sleep mode.
Fn+B	Break operation.
Fn+D	Enable ePrivacy function (for ThinkPad X1 2-in-1 Gen 10 only).
Fn+K	Scroll lock.
Fn+P	Pause operation.
Fn+S	Send system request.
Fn+N	Open system information Window.
Fn+G	Enable / Disable the tapping gesture to launch TrackPoint Quick Menu.

You can customize keyboard settings in Vantage app. To customize detailed settings, open the Vantage app, and then click **Device → Input & Accessories**.

For more keyboard shortcuts, go to <https://support.lenovo.com/solutions/windows-support>.

## Use the TrackPoint pointing device

The TrackPoint pointing device enables you to perform all the functions of a traditional mouse, such as pointing, clicking, and scrolling.

### For Haptic Touchpad

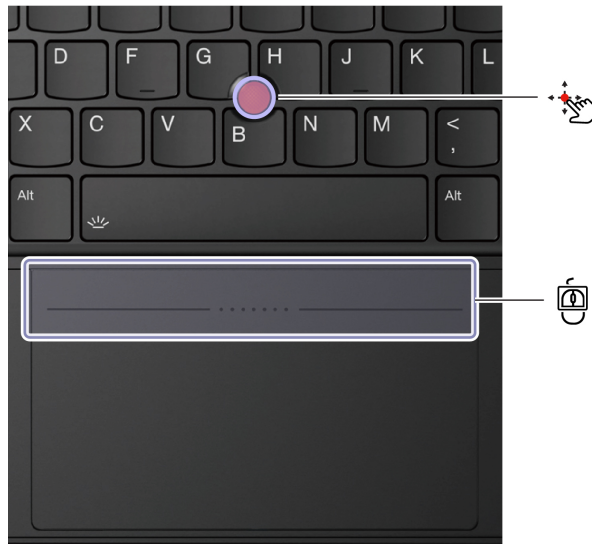

### For Trackpad

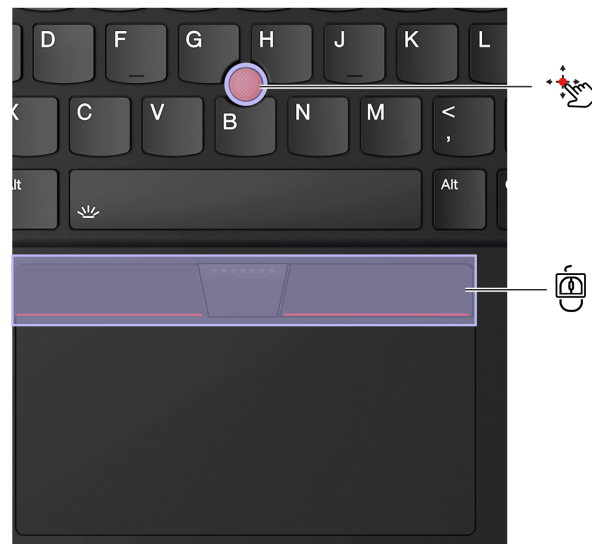

### TrackPoint pointing stick

Use your finger to apply pressure to the pointing-stick nonslip cap (hereafter referred to as the red cap) in any direction parallel to the keyboard. The pointer on the screen moves accordingly. The higher the pressure applied, the faster the pointer moves.

Your computer supports TrackPoint Quick Menu, see “TrackPoint Quick Menu” on page 34.

### TrackPoint Three Buttons

The left-click button and right-click button correspond to the left and right buttons on a traditional mouse. Press and hold the TrackPoint center button while using your finger to applying pressure to the pointing stick in the vertical or horizontal direction. Then, you can scroll through the document, Web site, or apps.

Press **Ctrl+TrackPoint center button+TrackPoint pointing stick** at the same time to zoom in or zoom out.

## Disable the TrackPoint pointing device

The TrackPoint pointing device is enabled by default. You can disable the device and change settings such as the speed of cursor when using the TrackPoint pointing stick and the TrackPoint center button.

To change the settings, do the following:

- Step 1. Type **Mouse settings** in the Windows search box and then press Enter.
- Step 2. Click **TrackPoint settings** and then follow the on-screen instructions to change the settings.

## Replace the pointing-stick nonslip cap

Follow below illustration to replace the pointing-stick nonslip cap.

**Note:** Ensure that the new red cap has grooves **a**.

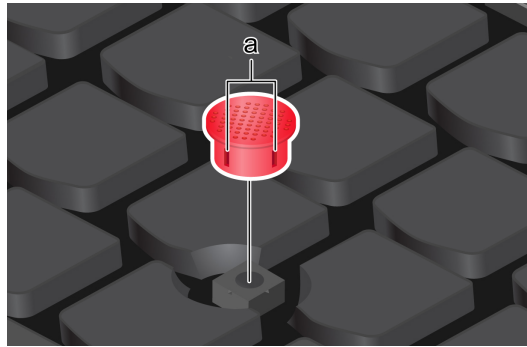

## Use the Haptic Touchpad (for selected models)

You can use the Haptic Touchpad to perform all the pointing, clicking, and scrolling functions of a traditional mouse. It is ideal for you to use for occasions with high portability requirements, for example, business trips.

- When TrackPoint Three Buttons are enabled

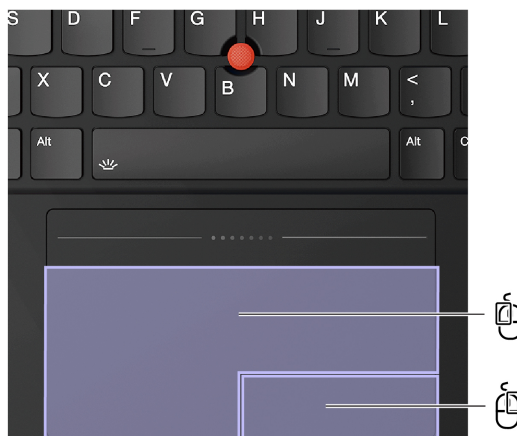

- When TrackPoint Three Buttons are disabled

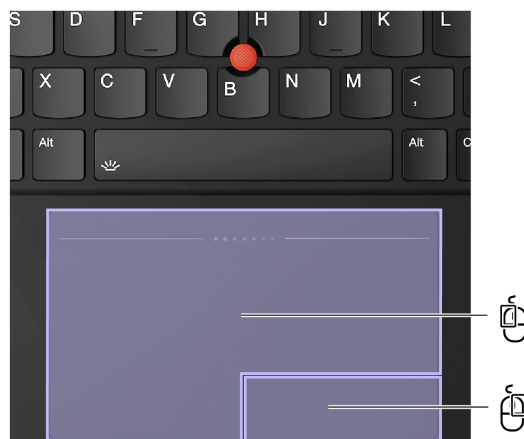

Item	Description	Item	Description
	Left-click zone		Right-click zone

**Notes:**

- When using two or more fingers, ensure that you position your fingers slightly apart.
- Some gestures are not available if the last action was done from the TrackPoint pointing device.
- Some gestures are only available when you are using certain apps.
- If the Haptic Touchpad surface is stained with oil, turn off the computer first. Then, gently wipe the Haptic Touchpad surface with a soft and lint-free cloth moistened with lukewarm water or computer cleaner.

**Use the Trackpad (for selected models)**

You can use the Trackpad to perform all the pointing, clicking, and scrolling functions of a traditional mouse. It is ideal for you to use for occasions with high portability requirements, for example, business trips.

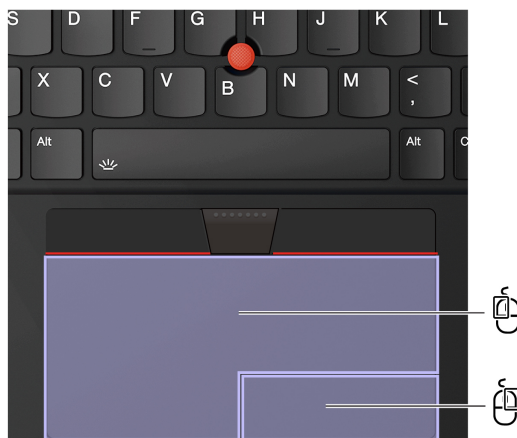

Item	Description	Item	Description
	Left-click zone		Right-click zone

**Notes:**

- Some gestures are not available in the following cases:
  - if the last action was done from the TrackPoint pointing device.
  - when you are using certain apps.

- when you are using two or more fingers and your fingers are too close.
- Trackpad might be insensitive in the following cases:
  - when you position your fingers too close to the edge of Trackpad.
  - when you touch the Trackpad with wet fingers.
  - if the Trackpad surface is stained with water or oil. Turn off the computer first. Then, gently wipe the Trackpad surface with a soft and lint-free cloth that is moistened with lukewarm water or computer cleaner.

## Use the touch gestures

### Notes:

- When using two or more fingers, ensure that you position your fingers slightly apart.
- Some gestures are not available if the last action was done from the TrackPoint pointing device.
- Some gestures are only available when you are using certain apps.
- If the Trackpad surface is stained with oil, turn off the computer first. Then, gently wipe the Trackpad surface with a soft and lint-free cloth moistened with lukewarm water or computer cleaner.

For more gestures, see the help information of the pointing device.

### One-and-two-finger touch gestures

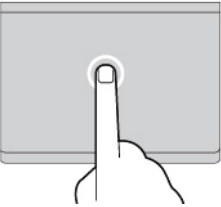
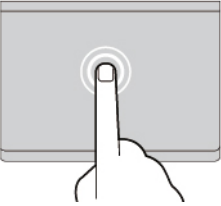
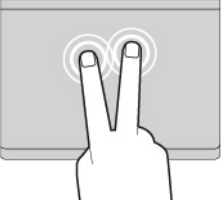
To do this	Gesture
Select an item.	One finger taps once. 
Open an item.	One finger taps twice. 
Display a shortcut menu.	Two fingers tap twice quickly. 

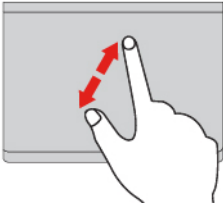
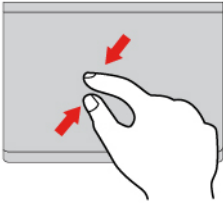
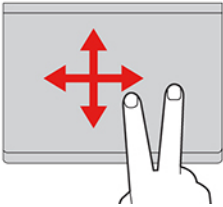
To do this	Gesture
Zoom in.	<p data-bbox="992 226 1240 254">Two fingers stretch out.</p> 
Zoom out.	<p data-bbox="1003 516 1224 543">Two fingers pinch in.</p> 
Scroll through items.	<p data-bbox="894 808 1338 835">Two fingers slide horizontally or vertically.</p> 

**Three-and-four-finger touch gestures**

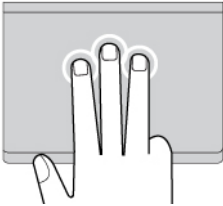
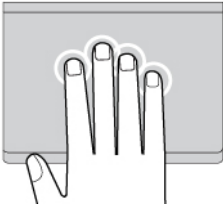
To do this	Gesture
Open search window.	<p data-bbox="992 1224 1240 1251">Three fingers tap once.</p> 
Open notification center.	<p data-bbox="997 1514 1235 1541">Four fingers tap once.</p> 

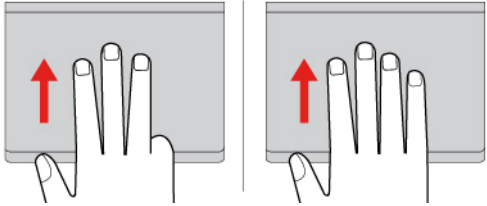
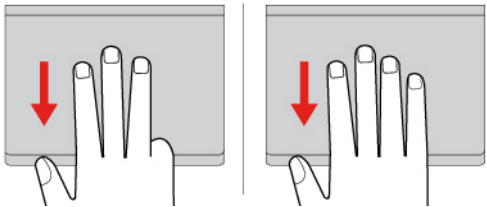
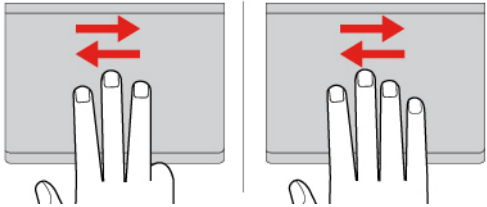
To do this	Gesture
Show all windows.	<p data-bbox="971 226 1315 258">Three- or four-finger swipes up.</p> 
Show the desktop.	<p data-bbox="959 516 1330 548">Three- or four-finger swipes down.</p> 
Switch between open apps or windows.	<p data-bbox="932 810 1359 842">Three- or four-finger swipes left or right.</p> 

## Disable the Trackpad or Haptic Touchpad

The Trackpad or Haptic Touchpad is enabled by default. To disable the Trackpad or Haptic Touchpad:

Step 1. Open the **Start** menu, and then click **Settings** → **Bluetooth & devices** → **Touchpad**.

Step 2. In the **Touchpad** section, turn off the **Touchpad** control.

## Use the touch screen (for selected models)

For computers with a touch-enabled screen, you can touch the screen directly with your fingers and interact with computer in a simple way. The following sections introduce frequently used touch gestures.

### Notes:

- Some gestures might not be available when you are using certain apps.
- Do not use gloved fingers or incompatible pens for input on the screen. Otherwise, the touch screen might be not sensitive or does not respond.
- The touch screen is delicate. Do not apply pressure on the screen or touch the screen with anything hard or sharp. Otherwise, the touch panel might malfunction or get damaged.

## One-finger touch gesture

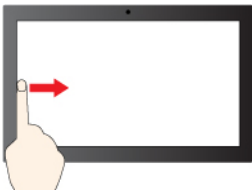
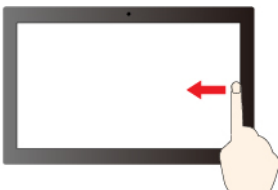
To do this	Gesture
Open a shortcut menu.	Tap and hold. 
Open the widget panel.	Swipe from the left. 
Open notification center.	Swipe from the right. 

## Two-finger touch gesture

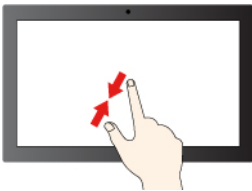
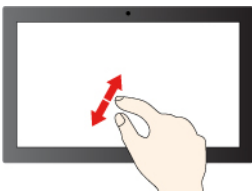
To do this	Gesture
Zoom out.	Move two fingers towards. 
Zoom in.	Spread two fingers apart. 

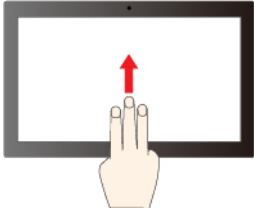
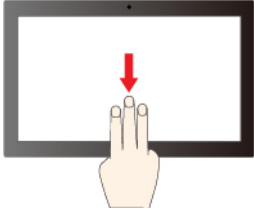
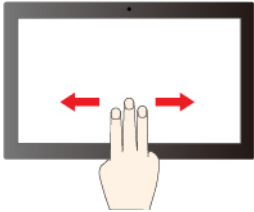
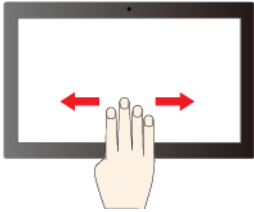

## Three-and-four-finger touch gesture

To do this	Gesture
Show all open windows.	Swipe with three fingers up. 
Show the desktop.	Swipe with three fingers down. 
Switch apps.	Swipe with three fingers to the left or right. 
Switch desktops.	Swipe with four fingers to the left or right. 

### Enable three-and-four-finger touch gestures (for selected models)

- Step 1. Type **touchpad** in the Windows search box and then press Enter.
- Step 2. Turn on the **Three-finger gestures** switch or **Four-finger gestures** switch as you desire.

### What to do if the touch screen is not sensitive or does not respond

Follow the instructions to troubleshoot the touch screen.

- Step 1. Turn off the computer.
- Step 2. Use a dry, soft, and lint-free cloth or a piece of absorbent cotton to remove fingerprints or dust from the touch screen. Do not apply solvents to the cloth.
- Step 3. Restart the computer and check if the touch screen works normally.
- Step 4. If the touch screen cannot work normally, type **Windows Update** in the Windows search box and then press Enter.

- Step 5. Follow the on-screen instructions to update Windows.
- Step 6. After updating Windows, check if the touch screen works normally.
- Step 7. If the touch screen still cannot work normally, the touch screen might get damaged. You can call Lenovo Customer Support Center to get further help.

## Connect to an external display

Connect your computer to a projector or a monitor to give presentations or expand your workspace.

**Note:** It's not recommended that you connect or disconnect the external display when in pre-OS environment. Otherwise, your computer screen might go black.

### Connect to a wired display

You can connect a wired display with your computer through the USB-C connector or HDMI connector.

If your computer cannot detect the external display, right-click a blank area on the desktop and select **Display settings**. Then follow the on-screen instructions to detect the external display.

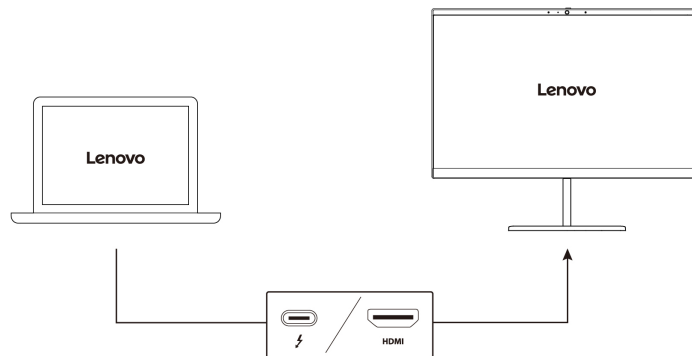

### Supported resolution

The following table lists the supported maximum resolution of the external display.

Connect the external display to	Supported resolution
USB-C connector (Thunderbolt 4)	Up to 8K / 60 Hz
HDMI connector	Up to 4K / 60 Hz

**Note:** The refresh rate higher than 60 Hz can also be supported. If you set the refresh rate higher than 60 Hz, the maximum resolution might be limited.

### Connect to a wireless display

To use a wireless display, ensure that both your computer and the external display support the Miracast® feature.

Press Windows logo key+K and then select a wireless display to connect with.

### Set the display mode

Press or Fn key+ and then select a display mode of your preference.

## Change display settings

You can change the settings for both the computer display and the external display, such as the main or the secondary display, brightness, resolution, and orientation.

To change the settings, do the following:

- Step 1. Right-click a blank area on the desktop and select **Display settings**.
- Step 2. Select the display that you want to configure and change display settings of your preference.

---

## Get to know convertible multi-modes

The computer display can be opened up to an angle of 360 degrees. Rotate the computer display to switch among different convertible multi-modes for different purposes.

### Notes:

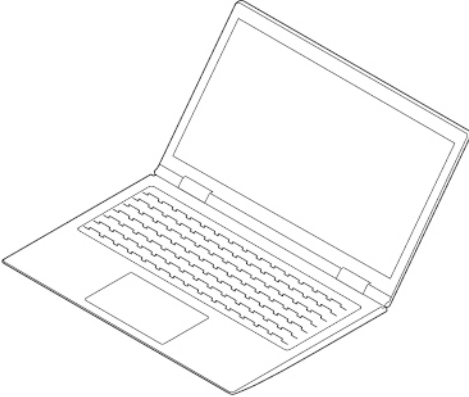
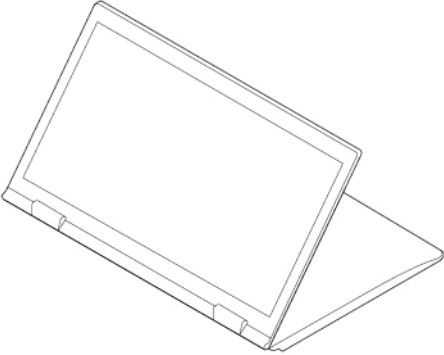
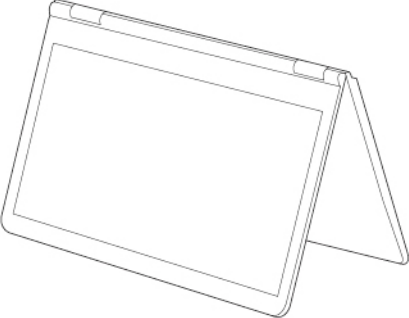
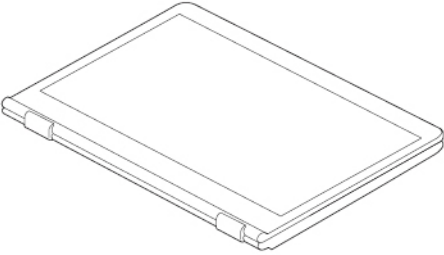

- Do not rotate the display with too much force, or apply too much force to the upper-right or upper-left corner of the display. Otherwise, the computer display or hinges might get damaged.
- The keyboard and the pointing device are automatically disabled in the stand mode, tent mode, and tablet mode. Use the touch screen to control your computer instead. The keyboard and the pointing device will be enabled again automatically when you switch from other modes to notebook mode.

Recommended scenario	Recommended scenario
<p data-bbox="386 226 570 254"><b>Notebook mode</b></p> <p data-bbox="418 285 537 312">Enter text.</p> <p data-bbox="253 342 703 369">Use the Trackpad and the pointing device.</p> 	<p data-bbox="1045 226 1187 254"><b>Stand mode</b></p> <p data-bbox="1019 285 1213 312">Have a video call.</p> <p data-bbox="1008 342 1224 369">Give a presentation.</p> 
<p data-bbox="415 957 540 984"><b>Tent mode</b></p> <p data-bbox="396 1014 560 1041">Watch a video.</p> <p data-bbox="378 1071 578 1098">View a slide show.</p> 	<p data-bbox="1045 957 1187 984"><b>Tablet mode</b></p> <p data-bbox="1029 1014 1203 1041">Write and draw.</p> <p data-bbox="971 1071 1261 1098">Play touch-enabled games.</p> 

## Use Lenovo Yoga Pen (for selected models)

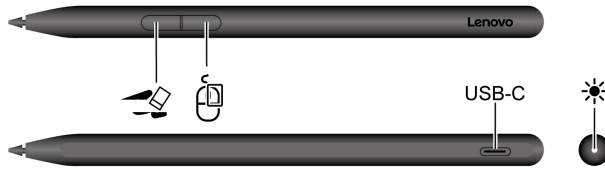
Lenovo Yoga Pen (hereafter referred to as the pen) enables a more precise and easier way of selecting, writing and sketching. It attaches magnetically to your computer.



Item	Description
	Eraser button. To erase text or drawings, hold the button to erase the object in supported apps.
	Click button. To right-click, hold the button and tap the screen in supported apps.
USB-C	USB-C connector. Connect the pen to the ac power adapter that comes with your computer to charge the pen.
	LED indicator. When the LED indicator blinks in orange, the pen battery power is low. The LED indicator is solid orange during charging and turns solid white when the pen is fully charged. The pen is fully charged in about two hours.

**Notes:**

- The default function of each barrel button might vary in different apps.
- To customize the barrel button functions, use Lenovo Pen Settings. You can also check the battery life on your pen in Lenovo Pen Settings. If Lenovo Pen Settings is not installed on your computer, download and install the latest WinTab driver from <https://support.lenovo.com> or from Microsoft Store.
- To purchase the pen, go to <https://www.lenovo.com/accessories>.
- Touch input is disabled while the pen is touching the display.

**Charge the pen**

Connect the pen to a charger with a USB-C cable as shown.



## Place the pen

Attach the pen to the magnetic side of your computer. Depending on different scenarios, the pen should be attached to different magnetic sides as shown.

- Attach the pen to the right side of the display for temporal using.
- Attach the pen to the right side of the body for carrying.

### Notes:

- Ensure that the pen tip is oriented the direction as shown when attaching it to the computer. Otherwise, the pen might drop.
- Keep the computer and the pen clean. Otherwise, the dirt and small particles might cause scratch or wear to the computer or the pen.

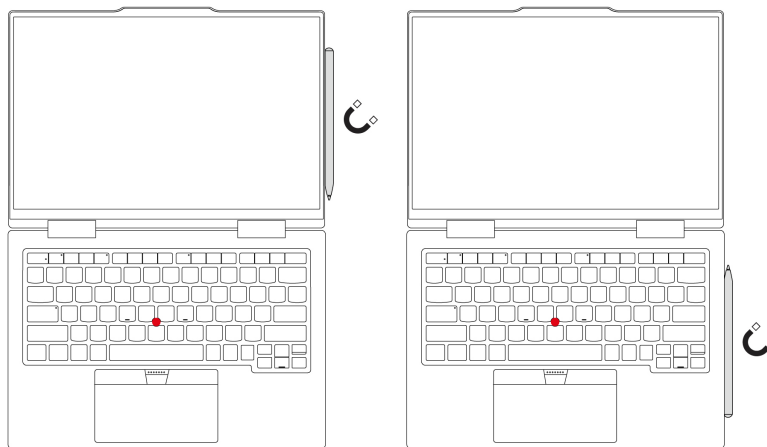

## Exchange the pen tip

1. Pull out the damaged tip by the tip remover.

**Note:** If the damaged tip cannot be extracted, do not disassemble the pen body. You can call Lenovo Customer Center. For the latest Lenovo Support phone numbers for your country or region, go to <https://pcsupport.lenovo.com/supportphonenumber>.

2. Insert a brand-new tip with fingers until the tip touches the bottom of the hole.

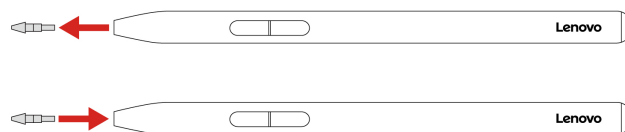

## Maintenance tips

- Do not attach the pen to other areas on your computer even it can be magnetically attached. Otherwise, the pen and your computer might be broken.
- The pen is not waterproof. Keep the pen away from water and excessive moisture.

- If possible, place your pen in a well-ventilated and dry area without direct exposure to sunshine.
- Do not use or store the pen in a place where excessive changes in temperature might occur such as in a car.
- The pen contains pressure sensors. Apply an appropriate amount of pressure when writing on the screen. Do not subject the pen to shock or vibration.





---

## Chapter 3. Explore your computer

This chapter helps you get full use of your computer.

---

### Lenovo apps

This section introduces Lenovo apps that can enrich your computing experience and improve productivity.

### Lenovo Commercial Vantage

The Lenovo Commercial Vantage app (hereafter referred to as Vantage app) is a customized one-stop solution to help you maintain your computer with automated updates and fixes, configure hardware settings, and get personalized support.

To access the Vantage app, type **Lenovo Commercial Vantage** in the Windows search box.

#### Notes:

- The available features vary depending on the computer model.
- The Vantage app makes periodic updates of the features to keep improving your experience with your computer. The description of features might be different from that on your actual user interface. Ensure that you use the latest version of Vantage app, and apply Windows Update to get the latest updates.

The Vantage app enables you to:

- Know the device status easily and customize device settings.
- Download and install UEFI BIOS, firmware, and driver updates to keep your computer up-to-date.
- Monitor your computer health, and secure your computer against outside threats.
- Scan your computer hardware and diagnose hardware problems.
- Look up warranty status (online).
- Access *User Guide* and helpful articles.
- Temporarily disable the keyboard, screen, Trackpad, and TrackPoint pointing device for cleaning.
- Adjust advanced device settings including but not limited to: AI noise suppression, Dolby audio speaker profiles, user presence sensing, power settings, keyboard hot key combinations, Always on USB controls, battery charge thresholds, smart standby, and flip to start.

### Lenovo AI Now (for selected models)

Lenovo AI Now is a personal and private AI assistant to help with inspiration, writing, summarizing, and quick settings for your computer. With local AI models, it can ensure your data security and provide a secure AI experience.

#### Launch Lenovo AI Now

Click the Lenovo AI Now icon  on the task bar or type **Lenovo AI Now** in the Windows search box to launch Lenovo AI Now.

#### Explore key features

- **Knowledge Assistant:** Search for documents, retrieve information, summarize content, and generate reports based on your personal knowledge base.

**Note:** To experience Knowledge Assistant, you have to import documents and build your knowledge base first.

- **PC Assistant:** Set up and optimize your computer. It provides smart setup features and can connect you to timely Lenovo services. For example, you can ask AI Now to help turn on Eye Care mode or find the nearest service center.

#### Notes:

- To quickly chat with Lenovo AI Now, you can launch the AI Now mini window by pressing Ctrl+Q.
- Lenovo AI Now makes periodic updates to keep bringing the latest AI technologies to you and improving your experience. The description of features might be different from that on your actual user interface. For the latest information about Lenovo AI Now, go to [https://support.lenovo.com/solutions/lenovo-ai-apps#lenovo\\_ai\\_now](https://support.lenovo.com/solutions/lenovo-ai-apps#lenovo_ai_now).
- This app is available in some countries and regions.

## TrackPoint Quick Menu

TrackPoint Quick Menu is a clickable app. It offers rapid access to functions, such as camera and microphone. You can adjust the function settings in this app.

### Launch the TrackPoint Quick Menu

Double-tap the TrackPoint pointing stick to launch the TrackPoint Quick Menu. You can also set single-tapping as the launch gesture.

**Note:** If the TrackPoint Quick Menu does not pop up after you use the launch gesture, this case might be caused by the displacement of the TrackPoint pointing stick due to too much force applied on it. Wait 15 to 30 seconds and try again.

To change the settings, do the following:

Step 1. Click the flyout ⓘ and click **ADVANCED SETTINGS**.

Step 2. Select **Single-tapping** under **TrackPoint Quick Menu Launch**.

The TrackPoint Quick Menu is enabled by default. Press Fn+G to disable or enable the tapping gesture. When disabled, it cannot be launched by tapping the TrackPoint pointing stick.



## Use the TrackPoint Quick Menu

You can click the edit button  to rearrange the features in the preview panel, or drag and drop the features on the right to the preview panel to customize your quick menu.

- **Camera**

You can adjust the brightness and contrast of the camera, and restore the settings to default by tapping the reset button .

- **Microphone**

You can mute your computer, and adjust the sound effect of your microphone by selecting the following modes:

- Center mode: Capture the speaker's voice.
- Spatial mode: Capture the speaker's voice and the ambience.

**Note:** When internal microphone is not supported by Dolby or the Dolby driver is disabled, an input device list will be displayed instead. The list provides options and one volume bar to test your microphone.

- **Voice typing**

You can convert the speech to text in the text box. Click **START VOICE TYPING** to invoke the text box.

- **Battery**

You can extend the battery lifespan and health by setting the charging threshold below 100%.

To set the threshold, enable the feature and click **ADJUST THRESHOLD**. Then set the charge threshold in the Vantage app.

- **Audio playback**

You can select the output device of your preference and set the volume of your selected channel or mute it.

- **Noise suppression**

You can suppress your own background noise and the noise from other meeting participants.

- Off: Disable noise suppression.
- Low: Suppress low-level background noise.
- High: Suppress all non-speech background noise.

**Note:** The feature does not work when Dolby Voice is off. Click the link in **NOISE SUPPRESSION** to help you enable it.

- **Enable Haptic Touchpad button area (for selected models)**

You can enable or disable the TrackPoint Three Buttons. When the Haptic Touchpad button area is enabled, it works as the TrackPoint Three Buttons corresponding to the left and right buttons on a traditional mouse. When the Haptic Touchpad button area is disabled, it becomes part of the Haptic Touchpad. You can also click **ADVANCED SETTINGS** to enter OS settings to customize your Haptic Touchpad features.

- **Quick Clean**

You can temporarily disable the keyboard, screen, Haptic Touchpad, and TrackPoint pointing device to clean your computer.

**Note:** The features might vary due to periodic updates. For details of the version installed on your computer, click the flyout  at the top-right corner of the page and click **LEARN MORE**.

---

## Lenovo AURA EDITION Experiences

Lenovo AURA EDITION Experiences include Smart Modes, Smart Share, and Smart Care. These software solutions help elevate the user experience with your Lenovo AURA EDITION computer.

- **Smart Modes:** Seamlessly adapt your preferred settings in dedicated modes for common computer usage scenarios to help improve your productivity.
- **Smart Share:** Quickly share photos between your PC and Android or iOS mobile phone.
- **Smart Care:** Provide personalized interface for all support resources on your computer or mobile phone including 24/7 live agent support.

### Smart Modes

Smart Modes is a productivity widget to quickly activate the following commonly used features for different use scenarios:

- Enhance data security and privacy.
- Minimize distractions to keep you on track.
- Improve your virtual meeting experience (available when the webcam privacy shutter is open).
- Promote eye health and ergonomics.
- Help balance battery life and high performance.

#### Access the Smart Modes widget

Press F8 to launch the Smart Modes widget. Press F8 again to hide.

#### Activate the desired mode in the Smart Modes widget

1. Press F8 to launch the Smart Modes widget.
2. If it is the initial use of Smart Mode, you need to enable features you prefer for each mode in the Vantage app first:
  - a. Click the settings gear icon on top right of the widget to launch the Vantage app.
  - b. Locate the **Smart Modes** section. Select a mode and enable the features of the selected mode as you prefer.
  - c. Exit the Vantage app.
3. Click the mode you prefer in the Smart Modes widget to quickly activate the features you have configured in the Vantage app.

#### Notes:

- The available features vary depending on the computer model.
- The Lenovo View service and Vantage app periodically update features to improve your camera settings and functions. The feature description might be different from that on your actual user interface.

### Smart Share

The Smart Share function supports fast and convenient photo sharing between your computer and phones (both iOS and Android supported).

To get the Smart Share experience:

1. Ensure the following:

- The Intel Unison app is installed on both your computer and the phone. Download the app for free from the app store.
- Pair your phone with your computer through the Intel Unison, and complete the Bluetooth pairing by following the on-screen instructions to finish initial settings on both devices.
- Keep Intel Unison running in the background to ensure that all Smart Share features operate properly.

2. Launch Smart Share by one of the following:

- Tap your paired phone against the left or right side of your computer display.
- Press F11 to launch Smart Share.



3. Follow the on-screen instructions on the app, and then drag and drop photos between your paired computer and phone for editing and sharing.

#### Notes:

- The available features might vary depending on the computer model.
- The Intel Unison app makes periodic updates for the features to improve your experience with your computer.

## Smart Care

Smart Care is a unified software solution to provide prompt support from Lenovo support experts, eliminating the need for multiple platforms. In Smart Care, you can get help from Lenovo on hardware and software solutions using your computer or mobile devices with intuitive interfaces.

To access Smart Care, do one of the following:

- Open the Vantage app, and then click **Smart Care** from the side panel menu.
- Download and install the mobile app **Lenovo Smart Care** from the app store used by your mobile phone, such as Apple App store or Google Play, and add the device serial number to start.

#### **Key features:**

- Check, renew, or upgrade warranty.
- Get in-time support from Lenovo through multiple channels. For example, you can query BIOS problems through a live chat, a live call or even sharing your screen. If you want to query your issue later, you can schedule a callback or submit a ticket.

**Note:** The availability of these services depends on your warranty, country or region, and language.

- Explore Lenovo knowledge base, including user guides, feature articles, and feature videos.
- Diagnose and troubleshoot an issue step by step to help you quickly identify and resolve the issue.

#### **Notes:**

- The PC app features of Smart Care are only available when the Vantage app is installed.
- Some features on the mobile app require coordination with PC app features of Smart Care.

---

## **Copilot in Windows**

Copilot in Windows is an AI-powered assistant to help enhance work efficiency and creativity.

To access Copilot in Windows, do one of the following:

- Press the Copilot key .
- Click the Copilot icon  on the task bar.

#### **Key functions**

- Provide answers or suggestions to your questions through live chat. For example, you could ask Copilot how to change your Windows password.
- Assist you to analyse image by clicking the image button at the bottom right of the chat box. For example, you could ask Copilot to summarize the image you have uploaded.

#### **Notes:**

- This app might not be available in your country or region.
- This app makes periodic updates of the features. Explore this app on your actual user interface.

---

## **Global Power Management**

Global Power Management provides power saving functions such as Intelligent Cooling, Efficiency Optimizer and Brightness Control. It helps improve your computer performance.

#### **Access Global Power Management**

Open the Vantage app, and then click **Device → Power**.



#### **Explore the features**

- **Intelligent Cooling:** Help you adjust power consumption, fan speed, computer temperature, and performance.

Mode	Recommended scenario
Best power efficiency	<ul style="list-style-type: none"> <li>– You want the computer to be quieter and cooler.</li> <li>– You want to maximize the battery life.</li> </ul>
Balanced	<ul style="list-style-type: none"> <li>– You plan to frequently switch between different computer tasks over a period time.</li> <li>– You prefer to balance device performance with temperature and fan noise.</li> </ul>
Best performance	<ul style="list-style-type: none"> <li>– You want the computer to achieve the best performance.</li> <li>– Louder fan noise and higher temperature are acceptable to you.</li> </ul>

- **Efficiency Optimizer:** An exclusive Lenovo power saving feature. Dynamically adjust your CPU's power consumption based on your system's usage.
- **Panel Brightness Control:** An exclusive Lenovo power saving feature. Incrementally adjust your display brightness when you connect or disconnect your charger.

### Enable the features

- **Intelligent Cooling:** Balanced mode is the default setting. To switch among power modes, do one of the following:
  - In Vantage:
    1. Press F8 to launch Smart Modes widget.
    2. Select a preferred power mode.
  - In OS settings:
    1. Right-click the battery icon in the quick settings area    on the right side of the taskbar.
    2. Click **Power and sleep settings**.
    3. Locate the **Power mode** section and select a preferred mode.
- **Efficiency Optimizer :** Turn on the feature switch under **Global Power Management** in the Vantage app.
- **Panel Brightness Control:** Turn on the feature switch under **Global Power Management** in the Vantage app.

## Transfer data

Quickly share your files using the built-in Bluetooth or NFC technology among devices with the same features.

### Connect to a Bluetooth device

You can connect all types of Bluetooth-enabled devices to your computer, such as a keyboard, a mouse, a smartphone, or speakers. To ensure successful connection, place the devices at most 10 meters (33 feet) from the computer.

#### Conventional pair

This topic helps you connect to a Bluetooth device by conventional pair.

- Step 1. Type **Bluetooth** in the Windows search box and then press Enter.
- Step 2. Turn on both the Bluetooth on your computer and the Bluetooth device. Make sure the device is discoverable.

Step 3. Select the device when it is displayed on the **Add device** list, and then follow the on-screen instructions.

## Swift pair

This topic helps you connect to a Bluetooth device by swift pair.

If your Bluetooth device supports swift pair, do the following:

Step 1. Enable swift pair notification on Bluetooth settings page.

Step 2. Turn on both the Bluetooth on your computer and the Bluetooth device. Make sure the device is discoverable.

Step 3. Click **Connect** when a swift pair notification appears on your computer.

## Set up an NFC connection

Simply tap and connect your computer and another NFC-enabled device over a few centimeters or inches.

If your computer supports NFC, you will see an NFC mark or label  around the Trackpad area.

To turn on NFC:

Step 1. Type **Airplane mode** in the Windows search box and then press Enter.

Step 2. Ensure that Airplane mode is off and turn on the NFC function.

By using NFC, you can simply tap and connect your computer and another NFC-enabled device over a few centimeters or inches. To pair with an NFC card or smartphone:



**Note:** Ensure that the NFC card is in NFC Data Exchange Format (NDEF), otherwise the card cannot be detected.



---

## Chapter 4. Secure your computer and information

Your computer can safeguard your privacy and information through some privacy protection functions.

---

### Lock the computer

Lock your computer to a desk, table, or other fixtures through a compatible security cable lock.

**Note:** The slot supports cable locks that conform to the Kensington NanoSaver® lock standards using Cleat™ locking technology. You are responsible for evaluating, selecting, and implementing the locking device and security feature. Lenovo is not responsible for the locking device and security feature. You can purchase the cable locks at <https://smartfind.lenovo.com>.

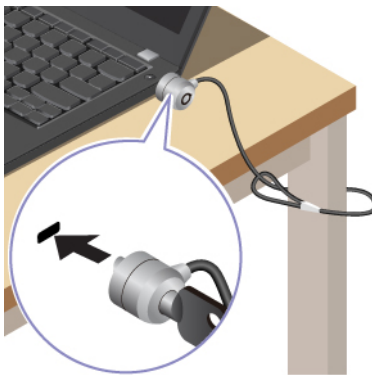

---

### Log in with fingerprint recognition

You can log in to the computer with your fingerprint. It eliminates the need to enter complex passwords, saving your time and boosting your productivity.

To enroll your fingerprints, do the following:

- Step 1. Type **Sign-in options** in the Windows search box and then press Enter.
- Step 2. Select **Fingerprint recognition (Windows Hello)** and then follow the on-screen instruction to enroll your fingerprint.

**Note:** It is recommended that you put your finger at the center of the fingerprint reader key during enrollment and enroll more than one fingerprint in case of any injuries to your fingers. After the enrollment, the fingerprints are associated with the Windows password automatically.

- Step 3. Log in with your fingerprint.



### Maintenance tips:

- Do not scratch the surface of the reader with anything hard or sharp.
- Do not use or touch the reader with a wet, dirty, wrinkled, or injured finger.

---

## Log in with facial recognition

You can log in to the computer with your facial recognition. It provides precise and secure authentication.

For models come with a webcam privacy shutter, slide the webcam privacy shutter to uncover the camera lens before using the Windows Hello face recognition.

Set up facial recognition and unlock your computer by scanning your face:

- Step 1. Type **Sign-in options** in the Windows search box and then press Enter.
- Step 2. Select **Facial recognition (Windows Hello)** and then follow the on-screen instruction to enroll your facial ID.

---

## Lock on leave function (for selected models)

Your computer supports the lock on leave function with ultrasound-based human presence detection, providing added security and improving battery life.



## Change the settings

To enable or disable this function:

Step 1. Go to **Start → Power & battery**.

Step 2. Turn on or turn off the **Turn off my screen when I leave** switch.

---

## User Presence Sensing (for selected models)

Your computer with 4K camera might support User Presence Sensing feature. This feature offers smarter privacy protection, simpler login convenience, and better energy management for your computer. You can customize this feature in the Vantage app.

**Note:** Before using this feature, ensure you set up Windows Hello facial recognition with the IR camera.

This feature provides the following functions:

- **Face Sensing:** Wake your computer from sleep mode without touching when you have set up Windows Hello facial recognition.
- **Zero Touch Login:** Wake your computer from sleep mode. With Windows Hello facial recognition, you can log in without touching your computer.



**Note:** When **Face Sensing** is enabled, only users who have set up Windows Hello facial recognition can wake the computer up.



- **Zero Touch Lock:** Lock the computer automatically when you leave.

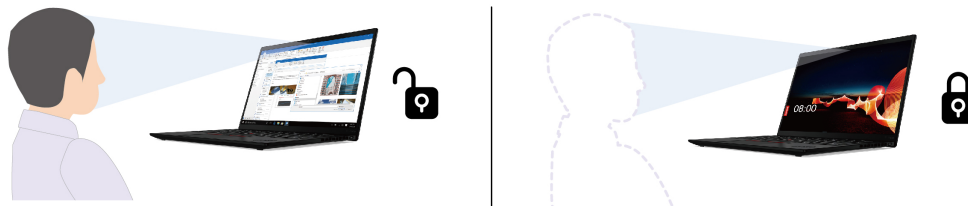

- **Adaptive Dimming:** Track your attention based on head position and eye contact with the display. When your focus is not on your computer screen, the display will dim to save battery power.

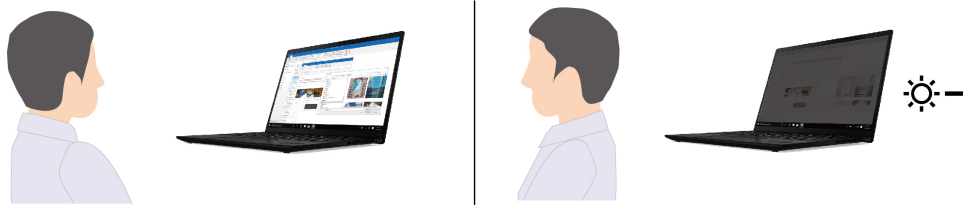

#### Notes:

- The feature does not work in the following cases:
  - the computer is in tent, tablet, or stand mode.
  - the computer is in hibernation mode or has been turned off.
  - the camera shutter is closed.
  - you set the power options to never turn off the display in the OS settings.
- The feature might not work properly in the following cases:
  - when used in bright back light or very dark environment.
  - when your face is partially hidden by your clothing or mask.
  - when the camera recognizes a face image behind you like a poster or picture.
- For some countries or regions, this feature might be disabled according to local regulations.

## Change the settings from the Vantage app



Follow the instructions to change the settings.

- Step 1. Open the Vantage app, and then click **Device** → **Smart Assist**.
- Step 2. Turn on the **User Presence Sensing** toggle to enable the feature.
- Step 3. Customize the sub-features such as **Zero Touch Login**, **Zero Touch Lock**, and **Adaptive Dimming** according to your preference.

---

## Use the ePrivacy screen (for ThinkPad X1 2-in-1 Gen 10 only)

Your computer might come with an ePrivacy screen. It can reduce screen visibility from side angles to protect screen content against visual hacking.

This function is disabled by default. You can press F12 or Fn+D to enable it. You will be prompted by the on-screen icon  or  every time the function is enabled or disabled.

You can press  to increase the privacy level or  to decrease the privacy level.

**Note:** The privacy level of this function varies depending on the screen brightness level, the contrast ratio, and the physical environment where you are using this function. The recommended range of the screen brightness level is 50-60.

## Use the password privacy function

Once enabled, the password privacy function can be automatically activated in case that you are required to input passwords.

To enable this function:

- Step 1. Open the Vantage app, and then click **Device → Display & Camera**.
- Step 2. Locate the **Privacy Guard** option, and select **Enable this feature when typing passwords** to enable this function.

**Note:** Once enabled, the password privacy function is available even when you disable the ePrivacy function.

---

## Protect data against power loss

NVMe (Non-Volatile Memory express) M.2 solid-state drive features the Lenovo-unique PLP (Power Loss Protection) function to avoid data loss or damage.

If your computer is not responding and you might have to shut down your computer by pressing and holding the power button for several seconds. In this case, the PLP function enables your computer data to be saved timely. However, there is no guarantee that all data is saved in any situation.

To check the type of your M.2 solid-state drive:

- Step 1. Restart the computer. When the logo screen is displayed, press F10 to enter the Lenovo diagnostics window.
- Step 2. On the TOOLS tab, select **SYSTEM INFORMATION → STORAGE** using the arrow keys.
- Step 3. Locate the **Device Type** section to check the information.

---

## USB-C Restricted Mode

USB-C Restricted Mode is a security feature that allows you to disable data transfer through USB-C connectors while the charge function of the USB-C connectors is kept. It helps prevent data from being copied from the computer to USB storage devices connected to the computer. By enabling this feature, you can use public USB charging stations, such as those found in cafes and hotel lobbies, without worrying about data leakage from the USB-C connector.

### Notes:

- Before using this feature, ensure that the remaining battery power is not less than 5%. Otherwise, this feature can not be enabled.
- This feature can be enabled or disabled by key combinations only when the computer is turned on.

To enable or disable this feature, press Fn+U, and then press Fn+S.

After this feature is enabled, the LED indicator blinks briefly when a USB device is connected.

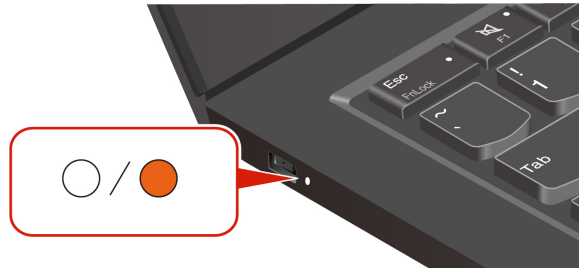

---

## UEFI BIOS passwords

You can set passwords in UEFI (Unified Extensible Firmware Interface) BIOS (Basic Input/Output System) to strengthen the security of your computer.

### Password types

You can set a power-on password, supervisor password, system management password, or NVMe password in UEFI BIOS to prevent unauthorized access to your computer.

However, you are not prompted to enter any UEFI BIOS password when your computer resumes from sleep mode.

### Power-on password

If you set a power-on password, a window is displayed on the screen when you turn on the computer. Enter the correct password to use the computer.

### Supervisor password

The supervisor password protects the system information stored in UEFI BIOS. When entering the UEFI BIOS menu, enter the correct supervisor password in the window prompted. You also can press Enter to skip the password prompt. However, you cannot change most of the system configuration options in UEFI BIOS.

If you have set both the supervisor password and power-on password, you can use the supervisor password to access your computer when you turn it on. The supervisor password overrides the power-on password.

### NVMe passwords

The NVMe password prevents unauthorized access to the data on the storage drive. When an NVMe password is set, you are prompted to type a correct password each time you try to access the storage drive.

- **Single Password**

When a Single NVMe password is set, the user must enter the user NVMe password to access files and applications on the storage drive.

- **Dual Password (User+Admin)**

The admin NVMe password is set and used by a system administrator. It enables the administrator to access any storage drive in a system or any computer connected in the same network. The administrator can also assign a user NVMe password for each computer in the network. The user of the computer can change the user NVMe password as desired, but only the administrator can remove the user NVMe password.

When prompted to enter an NVMe password, press F1 to switch between the admin NVMe password and user NVMe password.

**Notes:** The NVMe password is not available in the following situations:

- A Trusted Computing Group (TCG) Opal-compliant storage drive and a TCG Opal management software program are installed in the computer, and the TCG Opal management software program is activated.
- An eDrive storage drive is installed in the computer preinstalled with the Windows operating system.

## System management password

The system management password can also protect the system information stored in UEFI BIOS like a supervisor password, but it has lower authority by default. The system management password can be set through the UEFI BIOS menu or through Windows Management Instrumentation (WMI) with the Lenovo client-management interface.

You can enable the system management password to have the same authority as the supervisor password to control security-related features. To customize the authority of the system management password through the UEFI BIOS menu:

- Step 1. Restart the computer. When the logo screen is displayed, press F1 to enter the UEFI BIOS menu.
- Step 2. Select **Security** → **Password** → **System Management Password Access Control**.
- Step 3. Follow the on-screen instructions.

If you have set both the supervisor password and the system management password, the supervisor password overrides the system management password. If you have set both the system management password and the power-on password, the system management password overrides the power-on password.

## Set, change, or remove a password

Follow the instructions to set, change or remove a password.

Before you start, print these instructions.

- Step 1. Restart the computer. When the logo screen is displayed, press F1 to enter the UEFI BIOS menu.
- Step 2. Select **Security** → **Password** by using the arrow keys.
- Step 3. Select the password type. Then, follow the on-screen instructions to set, change, or remove a password.

You should record all your passwords and store them in a safe place. If you forget any of your passwords, any potential repair actions required are not covered under warranty.

## What to do if you forget your power-on password

Follow the instructions to remove the power-on password if you forget your power-on password.

If you have set a supervisor password or a system management password and remember it:

- Step 1. Restart the computer. When the logo screen is displayed, immediately press F1.
- Step 2. Type the supervisor password or the system management password to enter the UEFI BIOS menu.
- Step 3. Select **Security** → **Password** → **Power-On Password** by using the arrow keys.
- Step 4. Type the current supervisor password or the system management password in the **Enter Current Password** field. Then, leave the **Enter New Password** field blank, and press Enter twice.
- Step 5. In the Changes have been saved window, press Enter.
- Step 6. Press F10 to save changes and exit the UEFI BIOS menu.

If you have not set a supervisor password or a system management password, contact a Lenovo-authorized service provider to have the power-on password removed.

### **What to do if you forget your system management password**

Follow the instructions to remove the system management password if you forget your system management password.

If you have set a supervisor password and remember it:

- Step 1. Restart the computer. When the logo screen is displayed, immediately press F1.
- Step 2. Type the supervisor password to enter the UEFI BIOS menu.
- Step 3. Select **Security → Password → System Management Password** by using the arrow keys.
- Step 4. Type the current supervisor password in the **Enter Current Password** field. Then, leave the **Enter New Password** field blank, and press Enter twice.
- Step 5. In the Changes have been saved window, press Enter.
- Step 6. Press F10 to save changes and exit the UEFI BIOS menu.

If you have not set a supervisor password, contact a Lenovo-authorized service provider to have the system management password removed.

### **What to do if you forget your NVMe password**

Follow the instructions to remove the NVMe password if you forget your NVMe password.

If you forget your NVMe password (Single password) or both user and admin NVMe passwords (Dual password), Lenovo cannot reset your passwords or recover data from the storage drive. You can contact a Lenovo-authorized service provider to have the storage drive replaced. A fee will be charged for parts and service. If the storage drive is a CRU (Customer Replaceable Unit), you can also contact Lenovo to purchase a new storage drive to replace the old one by yourself. To check whether the storage drive is a CRU and the relevant replacement procedure, see “CRU list” on page 95.

### **What to do if you forget your supervisor password**

Follow the instructions to remove the supervisor password if you forget your supervisor password.

There is no service procedure to remove the password. You can contact a Lenovo-authorized service provider to have the system board replaced. A fee will be charged for parts and service.

---

## **FIDO (Fast Identity Online) authentication**

Your computer supports FIDO (Fast Identity Online) authentication feature. This feature works as an alternative to password-based authentication to achieve passwordless authentication.

This feature only works when a power-on password is set in UEFI BIOS and the FIDO2 USB device is registered in ThinkShield™ Passwordless Power-On Device Manager. With this feature, you can input the power-on password or use the registered FIDO2 USB device to power on your computer.

### **Register FIDO2 USB device in ThinkShield Passwordless Power-On Device Manager**

Follow the instructions to register FIDO2 USB device in ThinkShield Passwordless Power-On Device Manager.

- Step 1. Turn on the computer.



- Step 2. Press F12 during the power-on process.
- Step 3. If you set a power-on password, you are prompted to enter the correct password.
- Step 4. Select **App Menu → ThinkShield Passwordless Power-On Device Manager** and press Enter
- Step 5. Insert the FIDO2 USB device to register the device by following steps:
  - a. Select the available FIDO2 USB device that you want to register in the **Discovered Devices** field.
  - b. Click **Yes** in the displayed window to confirm the device you selected
  - c. If you set a power-on password, you are prompted to enter the correct password.
  - d. The **User operation request** window is displayed. You are prompted to press the button on the connected FIDO2 USB device, and then follow the on-screen instructions to close the window.
  - e. Press Esc to exit and restart your computer.

**Notes:**

- If you want to unregister your devices, click the available FIDO2 USB device that you want to unregister in the **My Device** field and enter the correct power-on password for verification.
- If you use more than one FIDO2 USB device with a common identifier for registration, only one device is available.

## Log in to the System with Passwordless Power-On Authentication

Follow the instructions to log in to the System with Passwordless Power-On Authentication.

- Step 1. Restart the computer.
- Step 2. **ThinkShield Passwordless Power-On Authentication** window is displayed.
- Step 3. Insert your registered FIDO2 USB device for detection.
- Step 4. Then follow the on-screen instructions to press the button on your FIDO2 USB device for verification.
- Step 5. After your device is verified, the power-on process continues.

**Note:** You should insert the FIDO2 USB device or enter the power-on password within 60 seconds. Otherwise, your computer will shut down automatically.

---

## Supervisor Certificate

Supervisor Certificate (also called the password-less management mode) provides more secure UEFI BIOS management with password-free solution. It is used to replace the supervisor password / system management password for authentication if you have set one.

**Note:** Supervisor password / system management password are disabled automatically when certificate mode is enabled. But the power-on password / NVMe password still can be used normally in certificate mode if you have set one.

For certificate enrollment, go to: [Certificate-based BIOS Authentication](#).

### Enter the BIOS menu with certificate

Once you have enrolled the certificate, you can enter the BIOS menu with the certificate.

1. Restart the computer. When the logo screen is displayed, press F1 to enter the BIOS menu.

2. The QR code is displayed. Scan the QR code to save the request data and send the request data to IT admin by e-mail or phone.

**Note:** If you choose to authenticate without the QR code, save the request data in a USB key and send the request data to IT admin by e-mail or phone.

3. Enter the unlock code provided by IT admin and click **OK**.

**Notes:**

- The unlock encode is a one-time password and is valid only during logon prompt (in one power-on cycle) for up to two hours.
- If you click **Skip**, you can enter the BIOS setup menu without BIOS management authority. But certificate reset is allowed.

**Reset certificate**

The enrolled certificate cannot be disabled. You can reset or remove it:

1. Restart the computer. When the logo screen is displayed, press F1.
2. Enter the BIOS menu with the certificate or skip the certification authentication process.
3. Select **Security → Reset Certificate**.
4. Follow the on-screen instructions to enter the reset code provided by IT admin.

---

## Chapter 5. Configure advanced settings

---

### UEFI BIOS

UEFI BIOS is the first program that the computer runs. When the computer turns on, the UEFI BIOS performs a self test to make sure that various devices in the computer are functioning properly.

#### Enter the UEFI BIOS menu

Turn on or restart the computer. When the logo screen is displayed, press F1 repeatedly to enter the UEFI BIOS menu.

#### Navigate the UEFI BIOS menu

Follow the on-screen instructions to navigate in the UEFI BIOS menu.

The table below introduces some available settings of the UEFI BIOS menu. To know more about the UEFI BIOS, for example, BIOS Event log, you can go to <https://pcsupport.lenovo.com> and then type **UEFI BIOS** in search box.

**Note:** The UEFI BIOS menu might vary depending on system configurations.

Menu	Introduction
<b>Main</b>	This category displays the general product-related information, such as UEFI BIOS version, machine type, system serial number, preinstalled OS license, and BIOS Event log.
<b>Config</b>	This category enables you to update configurations relating to system settings such as network, USB, keyboard, display, CPU, and power.
<b>Date/Time</b>	This category enables you to set computer date and time in this category.
<b>Security</b>	This category enables you to configure security settings related to such as password, fingerprint, and I/O accessibility.
<b>Startup</b>	This category enables you to manage settings relevant to booting up.
<b>Restart</b>	This category enables you to save or discard changes before exiting.

You can go to Lenovo BIOS Simulator Center <https://download.lenovo.com/bSCO/index.html> to explore the detailed settings by your product name.

**Note:** The Lenovo BIOS Simulator Center makes periodic updates of the settings. The UEFI BIOS simulator interface and description of settings might be different from that on your actual user interface.

### Customize BIOS Defaults

The feature provides a solution to backup your preferred BIOS Setup settings.

It helps you to save the BIOS Setup settings as customized BIOS default settings, load them to current BIOS settings when needed, and reset the settings to Setup Defaults.

#### Save the customized settings configuration

Follow the instructions to save the customized settings configuration.

Step 1. Restart the computer. When the logo screen is displayed, press F1 to enter the UEFI BIOS menu.

- Step 2. Select **Restart → Save Custom Defaults**.
- Step 3. Click **Yes** to save the settings configuration you customized.

### Load the customized settings configuration

Follow the instructions to load the customized settings configuration.

- Step 1. Restart the computer. When the logo screen is displayed, press F1 to enter the UEFI BIOS menu.
- Step 2. Select **Restart → Load Custom Defaults**.
- Step 3. Click **Yes** to load the customized settings configuration you saved.

You can also press F9 and click **Custom Defaults** to load the customized settings configuration.

**Note:** **Load Custom Defaults** is unavailable if no customized BIOS default settings are saved.

### Reset the settings configuration to Setup Defaults

Follow the instructions to reset the settings configuration to Setup Defaults.

- Step 1. Restart the computer. When the logo screen is displayed, press F1 to enter the UEFI BIOS menu.
- Step 2. Select **Restart → Load Factory Defaults**.
- Step 3. Click **Yes** to reset the settings configuration to Setup Defaults.

You can also press F9 and click **Factory Defaults** to reset the settings configuration to Setup Defaults.

---

## ThinkShield secure wipe

ThinkShield secure wipe feature is ThinkPad Drive Erase Utility for the Resetting the Cryptographic Key and the Erasing the Solid State Drive. This feature provides you a secure method to wipe all the data on your computer.

- Step 1. Restart the computer. When the logo screen is displayed, press F12.
- Step 2. Select **App Menu → ThinkShield secure wipe**, and then follow the on-screen instructions.

---

## Detect memory retraining

Memory retraining is a process to initialize the memory module and run diagnostic tests for the memory module in your computer.

The memory retraining might occur during POST if any of the following situations is detected:

- Total Memory Encryption setting change in the UEFI BIOS
- Memory Reference Code (MRC) change when the UEFI BIOS updates

When memory retraining occurs, the screen might be blank. You might see the LED indicators on Esc, F1, and F4 blinking sequentially to indicate the progress. Do not press the power button to interrupt the process. Wait a few minutes until the logo screen is displayed.

---

## Chapter 6. Frequently asked questions

This chapter provides solutions to some hardware and software issues.

---

### Camera problems

#### My camera cannot be launched or found

**Problem:** What should I do if my camera cannot be launched or found?

**Solution:** If your camera can't be launched or found, try the following solutions one by one to troubleshoot and fix the issue:

1. If you are using an external camera, ensure that it is connected to a working USB connector on your computer.
2. If you are using an integrated camera, ensure that it is uncovered and enabled. Take the following steps:
  - a. Open the camera shutter.
  - b. Open the Start menu, click **Settings** → **Bluetooth & devices** → **Cameras**, and enable the camera.
3. Authorize apps to have access to the camera. Take the following steps:
  - a. Open the **Start** menu, and select **Settings** → **Privacy & security** → **Camera**.
  - b. Turn on **Camera access** switch and **Let apps access your camera** switch.
4. Unblock access to the camera in your antivirus software settings.
5. Update the camera driver. Take the following steps:
  - a. Type **device manager** in the Windows search box and then press Enter.
  - b. Click **Device Manager** from the list of results. The Device Manager window opens.
  - c. Click the arrow icon > next to **Camera** to expand the section.
  - d. Right-click the camera that you would like to update.
  - e. Select **Update driver** and follow the on-screen instructions.
6. Run the automated camera troubleshooter in the Get Help app. Take the following steps:
  - a. Open the **Start** menu and click **Settings** → **Privacy & security** → **Camera**.
  - b. Scroll down to the bottom. Click **Get help** and follow the on-screen instructions.

If the problem persists, do not hesitate to call Lenovo Customer Center. For the latest Lenovo Support phone numbers for your country or region, go to <https://pcsupport.lenovo.com/supportphonenumberlist>.

---

### Audio problems

#### My audio does not work

**Problem:** What should I do if my audio does not work?

**Solution:** If you encounter any audio problems, such as no audio or malfunctioning audio, try the following solutions one by one to troubleshoot and fix the issue:

1. If you are using an external audio device, ensure that the device is properly connected to your computer.
2. Verify your audio settings. Take the following steps:

- a. Go to **Start → Settings → System → Sound**.
  - b. Verify that the sound output and input devices are selected correctly.
  - c. Verify that the volume is properly set and your computer is not muted.
3. Run the audio troubleshooter. Take the following steps:
- a. Go to **Start → Settings → System → Sound**.
  - b. Under **Advanced**, find **Troubleshoot common sound problems**, and click **Output devices** or **Input devices** to troubleshoot and fix the problem.

For more solutions to audio problems, go to <https://support.lenovo.com/solutions/ht501860>.

If the problem persists, do not hesitate to call Lenovo Customer Center. For the latest Lenovo Support phone numbers for your country or region, go to <https://pcsupport.lenovo.com/supportphonenumber>.

---

## Mouse problems

### My mouse does not work

**Problem:** What should I do if my mouse does not work?

**Solution:** If you encounter mouse problems such as mouse not responding or mouse cursor disappearing, try the following solutions one by one to troubleshoot and fix the issue:

1. Ensure the power switch on your mouse is turned on.
2. If you are using a wireless mouse, try the following solutions one by one:
  - Ensure that the battery power is enough for working.
  - If it is connected through a USB dongle, ensure that the USB dongle is connected to a working USB connector of your computer. The USB dongle is usually stored within the battery compartment of the mouse.
  - If it is a Bluetooth mouse, ensure that the Bluetooth connection with your computer is correct. If there is a Bluetooth connection problem, refer to “Bluetooth connection problems” in this *User Guide*.
3. If you are using a wired mouse, try the following solutions one by one:
  - Connect it to a working USB connector on your computer correctly.
  - Connect another wired mouse to the same USB connector. If it is connected correctly and works well, there may be something wrong with the original mouse.
4. Update the mouse driver. Take the following steps:
  - a. Type **device manager** in the Windows search box.
  - b. Click **Device Manager** from the list of results. The Device Manager window opens.
  - c. Click the arrow icon > next to **Mice and other pointing devices** to expand the section.
  - d. Right-click the mouse driver, click **Update driver**, and then follow the on-screen instructions to update the driver.

If the problem persists, do not hesitate to call Lenovo Customer Center. For the latest Lenovo Support phone numbers for your country or region, go to <https://pcsupport.lenovo.com/supportphonenumber>.

---

## Keyboard problems

### My keyboard does not work

**Problem:** What should I do if my keyboard does not work?

**Solution:** If your keyboard does not work or types wrong characters, try the following solutions one by one to troubleshoot and fix the issue:

1. Ensure that the keyboard is well connected.
  - If you are using a wired keyboard, check if it is connected to your computer correctly or try to connect the keyboard to another compatible connector on your computer.
  - If you are using a wireless keyboard, ensure that your keyboard is powered on. Check if the dongle is connected to your computer correctly or the Bluetooth connection with your computer is established.
2. Ensure that the keyboard layout settings are correct. Take the following steps:
  - a. Go to **Settings → Time & language → Language & region**.
  - b. Under **Preferred languages**, click on the three horizontal dots next to your primary language preference and select **Language options**.
  - c. Under **Installed keyboards**, check the keyboard layout and add the corresponding keyboard if you're not using the right one.
3. Ensure that the keyboard is in good status. Take the following steps:
  - a. Type **device manager** in the Windows search box and then press Enter.
  - b. Click **Device Manager** from the list of results. The Device Manager window opens.
  - c. Click the arrow icon > next to **Keyboard** to expand the section.
  - d. Double-click the keyboard that is not working and check the status.
  - e. If it is not working properly, select **Driver** from the tabs on the top and click **Uninstall device** to uninstall the device.
  - f. Apply Windows Update to install the latest driver automatically.
4. Ensure that the sticky keys and filter keys are disabled. Take the following steps:
  - a. Open the **Start** menu, and click **Settings → Accessibility → Keyboard**.
  - b. Disable **Sticky keys** switch and **Filter keys** switch.
5. Clean the keyboard.
  - For external keyboard, take the following steps:
    - a. Disconnect your keyboard.
    - b. Turn the keyboard upside down and gently shake it.
    - c. Use compressed air to blow out the dirt and debris from underneath the keys.
    - d. Use a cotton swab dipped in rubbing alcohol to remove stickiness around and underneath stuck keys.
  - For integrated keyboard, take the following steps:
    - a. Turn off your computer.
    - b. Use compressed air to blow out the dirt and debris from underneath the keys.
    - c. Use a cotton swab dipped in rubbing alcohol to remove stickiness around and underneath stuck keys.
6. Restart your computer.

If the problem persists, do not hesitate to call Lenovo Customer Center. For the latest Lenovo Support phone numbers for your country or region, go to <https://pcsupport.lenovo.com/supportphonenumberlist>.

## My keyboard backlight does not work

**Problem:** What should I do if my keyboard backlight does not work?

**Solution:** If your keyboard backlight does not work, try the following solutions one by one to troubleshoot and fix the issue:

1. Turn on or adjust the keyboard backlight by pressing the key combination Fn+space.
2. Update the keyboard driver. Take the following steps:
  - a. Type **device manager** in the Windows search box and then press Enter.
  - b. Click **Device Manager** from the list of results. The Device Manager window opens.
  - c. Click the arrow icon > next to **Keyboard** to expand the section.
  - d. Right-click the keyboard you would like to update.
  - e. Select **Update driver** and follow the on-screen instructions.

If the problem persists, do not hesitate to call Lenovo Customer Center. For the latest Lenovo Support phone numbers for your country or region, go to <https://pcsupport.lenovo.com/supportphonenumberlist>.

---

## Battery problems

### My computer battery discharges quickly

**Problem:** What should I do if my computer battery discharges quickly?

**Solution:** If your computer battery discharges quickly, try the following solutions one by one to troubleshoot and fix the issue:

1. Terminate any power-consuming settings, operations, or running apps, such as:
  - Decrease the screen brightness.
  - Turn off the keyboard backlight.
  - Disconnect unnecessary peripheral devices.
2. Ensure your computer is not set to high performance mode, which can consume more power. Take the following steps:
  - a. Click the quick settings area  on the right side of the taskbar.
  - b. Click the battery icon to change the settings.
3. Reset the battery gauge, which can help estimate the full charge capacity more accurately. Take the following steps:
  - a. Open the Vantage app, and then click **Device → Power**.
  - b. Follow the on-screen instructions to reset the battery gauge.
4. Update the battery driver to the latest version. For details, refer to “Driver problems” in this *User Guide*.
5. If your computer battery is old or drained, consider replacing the battery.

If the problem persists, do not hesitate to call Lenovo Customer Center. For the latest Lenovo Support phone numbers for your country or region, go to <https://pcsupport.lenovo.com/supportphonenumberlist>



## My computer battery is not recognized

**Problem:** What should I do if my computer battery is not recognized?

**Solution:** If your computer battery is not recognized, try the following solutions one by one to troubleshoot and fix the issue:

1. Ensure that the ac power adapter, power cord, power connector, and the power outlet are working correctly.
2. Restart the computer.
3. Reset the computer. Remove the ac power adapter and take the following steps:
  - For models with an emergency reset hole, insert a straightened paper clip into the emergency reset hole. Then, restart the computer with ac power connected.
  - For models without an emergency reset hole, press and hold the power button for about seven seconds. Then, restart the computer with ac power connected.
4. Update the battery driver to the latest version. For details, refer to “Driver problems” in this *User Guide*.
5. Update UEFI BIOS to the latest version. For details, refer to “UEFI BIOS problems” in this *User Guide*.

If the problem persists, do not hesitate to call Lenovo Customer Center. For the latest Lenovo Support phone numbers for your country or region, go to <https://pcsupport.lenovo.com/supportphonenumber>.

## My computer battery icon disappears

**Problem:** What should if the battery icon in the quick settings area disappears?

**Solution:** If the battery icon in the quick settings area disappears, try the following solutions one by one to troubleshoot and fix the issue:

1. Ensure that the ac power adapter, power cord, power connector, and the power outlet are working correctly.
2. Restart the computer.
3. Reset the computer. Remove the ac power adapter and take the following steps:
  - For models with an emergency reset hole, insert a straightened paper clip into the emergency reset hole. Then, restart the computer with ac power connected.
  - For models without an emergency reset hole, press and hold the power button for about seven seconds. Then, restart the computer with ac power connected.
4. Update the battery driver to the latest version. For details, refer to “Driver problems” in this *User Guide*.
5. Update UEFI BIOS to the latest version. For details, refer to “UEFI BIOS problems” in this *User Guide*.

If the problem persists, do not hesitate to call Lenovo Customer Center. For the latest Lenovo Support phone numbers for your country or region, go to <https://pcsupport.lenovo.com/supportphonenumber>.

---

## Display problems

### Blue screen

**Problem:** How to troubleshoot blue screen errors?

**Solution:** To troubleshoot blue screen errors, take the following steps:

1. Type **Get Help** in the Windows search box and then press Enter.
2. In the search box of the Get Help app, type **Troubleshoot BSOD error**.
3. Follow the guided walkthrough.

If the problem persists, do not hesitate to call Lenovo Customer Center. For the latest Lenovo Support phone numbers for your country or region, go to <https://pcsupport.lenovo.com/supportphonenumberlist>.

## Black screen

**Problem:** How to troubleshoot black screen issues?

**Solution:** To troubleshoot black screen errors, try the following solutions one by one:

1. Update the Windows operating system. Take the following steps:
  - a. Press the Windows logo key+Ctrl+Shift+B to wake your computer from the black screen.
  - b. Select the Start menu on the taskbar and then select **Settings**.
  - c. Select **Windows Updates** and then select **Check for updates**. If updates are available, download and install them.
2. Update the mouse and keyboard drivers. Take the following steps:
  - a. Press the Windows logo key+Ctrl+Shift+B to wake your computer from the black screen.
  - b. Type **device manager** in the Windows search box and then press Enter.
  - c. Under **Keyboards**, select **HID Keyboard Device**.
  - d. Select the **Power Management** tab and then check **Allow this device to wake the computer**.
  - e. Under **Keyboards**, select **HID Keyboard Device**, and then select **Update driver**.
  - f. Select **Search automatically for drivers** and then follow the on-screen instructions to confirm the best available driver is installed.

**Note:** If there is more than one HID keyboard device listed, perform steps c-f for each device.

- g. Repeat steps c-f for **Mice and other pointing devices**.

**Note:** If there is more than one HID-compliant mouse device listed, perform steps c-f for each device.

If the problem persists, do not hesitate to call Lenovo Customer Center. For the latest Lenovo Support phone numbers for your country or region, go to <https://pcsupport.lenovo.com/supportphonenumberlist>.

## Screen flickering

**Problem:** What should I do if my screen flickers?

**Solution:** If your screen flickers, take the following steps:

1. Check whether Task Manager also flickers. To open Task Manager, press Ctrl+Alt+Delete or Ctrl+Shift+Esc.
2. If Task Manager also flickers, roll back your display driver. Take the following steps:
  - a. Type **device manager** in the Windows search box and then press Enter.
  - b. Under **Display adapters**, select a display adapter.
  - c. Select the **Driver** tab and then select **Roll Back Driver**.
  - d. Click **Yes** to roll back your display driver and restart your computer.

**Note:** If the **Roll Back Driver** option is unavailable, Windows does not have a previous driver to roll back to. In this scenario, you can try updating or uninstalling your display driver in the **Driver** tab.

3. If Task Manager does not flicker, update or uninstall incompatible apps that are probably causing the problem. Take the following steps:
  - a. Keep all apps updated from the Microsoft Store or the manufacturer's site.
  - b. Check whether screen flickers in a specific app. If yes, uninstall the app. Take the following steps:
    - 1) Select the Start menu on the taskbar and then select **Settings**.
    - 2) Select **Apps → Installed apps**.
    - 3) Scroll down the list, find the app you want to uninstall, and then select **Uninstall**.
    - 4) In the popup window, select **Uninstall**.
    - 5) If you're asked to confirm your choice, select **Yes**.

If the problem persists, do not hesitate to call Lenovo Customer Center. For the latest Lenovo Support phone numbers for your country or region, go to <https://pcsupport.lenovo.com/supportphonenumberlist>.

## My external display does not work

**Problem:** What should I do if my external display does not work?

**Solution:** If my external display does not work, try the following solutions one by one to troubleshoot and fix the issue:

1. Ensure that the external display is well connected to your computer.
2. Reconnect the external display to your computer.
3. Update the display driver. Take the following steps:
  - a. Type **device Manager** in the Windows search box and then press Enter.
  - b. Click the arrow icon > next to **Display adapters** to expand the section.
  - c. Right-click your display adapter, select **Update driver**, and follow the on-screen instructions.
4. Roll back to the previous installed driver if the display problem occurs after a recent driver update. Take the following steps:
  - a. Type **device Manager** in the Windows search box and then press Enter.
  - b. Click the arrow icon > next to **Display adapters** to expand the section.
  - c. Right-click the display driver and select **Properties**.
  - d. Under **Driver**, select **Roll Back Driver** and follow the on-screen instructions.

If the problem persists, do not hesitate to call Lenovo Customer Center. For the latest Lenovo Support phone numbers for your country or region, go to <https://pcsupport.lenovo.com/supportphonenumberlist>.

## My display remains dim

**Problem:** What should I do if my display remains dim?

**Solution:** If my display remains dim, try the following solutions one by one to troubleshoot and fix the issue:

1. Adjust the display brightness. Choose one of the following ways:
  - Press the hotkey to increase the display brightness.
  - Go to **Start → Settings → System → Display**, and move the **Brightness** slider to the right.

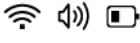
- Click the quick settings area  on the right side of the taskbar to open the quick settings panel, and then move the **Brightness** slider to the right.
2. Update the display driver. Take the following steps:
    - a. Type **Device Manager** in the Windows search box and then press Enter.
    - b. Click the arrow icon > next to **Display adapters** to expand the section.
    - c. Right-click your display adapter, select **Update driver**, and follow the on-screen instructions.
  3. Roll back to the previous installed driver if the problem occurs after a recent driver update. Take the following steps:
    - a. Type **Device Manager** in the Windows search box and then press Enter.
    - b. Click the arrow icon > next to **Display adapters** to expand the section.
    - c. Right-click the display driver and select **Properties**.
    - d. Under **Driver**, select **Roll Back Driver** and follow the on-screen instructions.

If the problem persists, do not hesitate to call Lenovo Customer Center. For the latest Lenovo Support phone numbers for your country or region, go to <https://pcsupport.lenovo.com/supportphonenumber>.

---

## Fingerprint reader problems

### Fingerprint recognition cannot be set up

**Problem:** What should I do if I cannot set up fingerprint recognition?

**Solution:** If you cannot set up fingerprint recognition, try the following solutions one by one to troubleshoot and fix the issue:

1. Restart the computer.
2. Cut off power supply to the fingerprint reader temporarily. Remove the ac power adapter and take the following steps:
  - For models with an emergency reset hole, insert a straightened paper clip into the emergency reset hole. Then, restart the computer with ac power connected.
  - For models without an emergency reset hole, press and hold the power button for about seven seconds. Then, restart the computer with ac power connected.
3. Check the fingerprint device driver. Take the following steps:
  - a. Type **device manager** in the Windows search box.
  - b. Click **Device Manager** from the list of results. The Device Manager window opens.
  - c. Click the arrow icon > next to **Biometric devices** to expand the section.
    - If there is no fingerprint device, it might be a fingerprint reader failing problem, and you might need to have the fingerprint reader serviced.
    - If there is a yellow exclamation mark next to the fingerprint device, update the fingerprint reader driver. Take the following steps:
      - 1) Download the latest driver from Lenovo support website. For how to download the driver, refer to “Driver problems” in this *User Guide*.
      - 2) In the **Biometric devices** section of the Device manager, right-click the fingerprint device, and then click **Update driver**.
      - 3) In the Update Drivers window, click **Browse my computer for drivers**.

- 4) Browse to the folder where the latest fingerprint driver is stored. Double-click to run the driver and then follow the on-screen instructions to update the driver.
- 5) Restart your computer.

If the problem persists, do not hesitate to call Lenovo Customer Center. For the latest Lenovo Support phone numbers for your country or region, go to <https://pcsupport.lenovo.com/supportphonenumber>.

## Fingerprint enrollment error

**Problem:** What should I do if there is an error during fingerprint enrollment?

**Solution:** If there is an error during fingerprint enrollment, try the following solutions one by one to troubleshoot and fix the issue:

1. Download the latest driver from Lenovo support website. For how to download the driver, refer to “Driver problems” in this *User Guide*.
2. Update the fingerprint reader driver. Take the following steps:
  - a. Type **device manager** in the Windows search box.
  - b. Click **Device Manager** from the list of results. The Device Manager window opens.
  - c. Click the arrow icon > next to **Biometric devices** to expand the section.
  - d. Right-click the fingerprint driver, and then click **Update driver**.
  - e. In the Update Drivers window, click **Browse my computer for drivers**.
  - f. Browse to the folder where the latest fingerprint driver is stored. Double-click to run the driver and then follow the on-screen instructions to update the driver.
3. Restart your computer, and then enroll again.

If the problem persists, do not hesitate to call Lenovo Customer Center. For the latest Lenovo Support phone numbers for your country or region, go to <https://pcsupport.lenovo.com/supportphonenumber>.

## Fingerprint recognition error

**Problem:** What should I do if fingerprint recognition always fails?

**Solution:** If fingerprint recognition always fails, try the following solutions one by one to troubleshoot and fix the issue:

1. Remove the fingerprint, and enroll again. Take the following steps:
  - a. Click **Start → Settings → Accounts → Sign-in options → Fingerprint recognition (Windows Hello)**.
  - b. Click **Remove** to remove the fingerprint. No matter how many fingers have been set, you only need to remove once.
  - c. Enroll the fingerprint again. For how to enroll the fingerprint, refer to fingerprint recognition topic in this *User Guide*.

**Note:** During the enrollment, it is recommended that you follow the on-screen instructions to enroll the full image of your fingerprint.

2. Update the fingerprint driver and enroll again. Take the following steps:
  - a. Download the latest driver from Lenovo support website. For how to download the driver, refer to “Driver problems” in this *User Guide*.
  - b. Remove the fingerprint. Take the following steps:

- 1) Click **Start** → **Settings** → **Accounts** → **Sign-in options** → **Fingerprint recognition (Windows Hello)**.
  - 2) Click **Remove** to remove the fingerprint. No matter how many fingers have been set, you only need to remove once.
- c. Update the fingerprint driver. Take the following steps:
- 1) Type **device manager** in the Windows search box.
  - 2) Click **Device Manager** from the list of results. The Device Manager window opens.
  - 3) Click the arrow icon > next to **Biometric devices** to expand the section.
  - 4) Right-click the fingerprint driver, and then click **Update driver**.
  - 5) Browse to the folder where the latest fingerprint driver is stored. Double-click to run the driver and then follow the on-screen instructions to update the driver.
  - 6) Restart your computer.
- d. Enroll the fingerprint again. For how to enroll the fingerprint, refer to fingerprint recognition topic in this *User Guide*.

**Note:** During the enrollment, it is recommended that you follow the on-screen instructions to enroll the full image of your fingerprint.

If the problem persists, do not hesitate to call Lenovo Customer Center. For the latest Lenovo Support phone numbers for your country or region, go to <https://pcsupport.lenovo.com/supportphonenumberlist>.

---

## Touchpad or trackpad problems

### My touchpad or trackpad does not respond

**Problem:** What should I do if my touchpad or trackpad does not respond?

**Solution:** If your touchpad or trackpad is not responding, try the following solutions one by one to troubleshoot and fix the issue:

1. Enable the touchpad. Take the following steps:
  - a. Go to **Start** → **Settings** → **Bluetooth & devices** → **Touchpad**.
  - b. Turn on the **Touchpad** toggle.

**Note:** For some Lenovo computers, you can also press the touchpad hotkey  or the key combination Fn+M to enable or disable the touchpad.
2. Update the touchpad driver. Take the following steps:
  - a. Type **device Manager** in the Windows search box and then press Enter.
  - b. Click the arrow next to **Human Interface Devices** to expand the section.
  - c. Right-click the touchpad, select **Update driver**, and follow the on-screen instructions.
3. Roll back the touchpad driver. Take the following steps:
  - a. Type **device Manager** in the Windows search box and then press Enter.
  - b. Click the arrow icon > next to **Human Interface Devices** to expand the section.
  - c. Right-click the touchpad, and select **Properties**.
  - d. Under **Driver**, select **Roll Back Driver** and follow the on-screen instructions.

If the problem persists, do not hesitate to call Lenovo Customer Center. For the latest Lenovo Support phone numbers for your country or region, go to <https://pcsupport.lenovo.com/supportphonenumber>.

## My touchpad or trackpad responds slowly

**Problem:** What should I do if my touchpad or trackpad responds slowly?

**Solution:** If your touchpad or trackpad response is very slow, take the following steps to troubleshoot and fix the issue:

1. Go to **Start → Settings → Bluetooth & devices → Touchpad**.
2. Adjust the cursor speed.
3. Under **Taps**, adjust the touchpad or trackpad sensitivity.

If the problem persists, do not hesitate to call Lenovo Customer Center. For the latest Lenovo Support phone numbers for your country or region, go to <https://pcsupport.lenovo.com/supportphonenumber>.

---

## Touch screen problems

### My touch screen does not respond

**Problem:** What should I do if my touch screen does not respond?

**Solution:** If your touch screen does not respond, try the following solutions one by one to troubleshoot and fix the issue:

1. Clean your touch screen. Take the following steps:
  - a. Turn off the computer.
  - b. Use a dry, soft, and lint-free cloth or a piece of absorbent cotton to remove fingerprints or dust from the touch screen. Do not apply solvents to the cloth.
  - c. Restart the computer.
2. Enable your touch screen. Take the following steps:
  - a. Type **device manager** in the Windows search box and then press Enter.
  - b. Under **Human Interface Devices**, right-click **HID-compliant touch screen**.
  - c. Select the **Driver** tab, select **Enable device**, and then confirm.

**Note:** If there's more than one HID-compliant touch screen device listed, perform steps b-c for each device.

- d. If **Intel(R) Quick I2C Host Controller** is listed under **Human Interface Devices**, right-click **Intel(R) Quick I2C Host Controller**, select **Driver → Enable device**, and then confirm.

**Note:** If there is more than one Intel(R) Quick I2C Host Controller device listed, perform step d for each device.

3. Update your touch screen driver. Take the following steps:
  - a. Type **device manager** in the Windows search box and then press Enter.
  - b. Under **Human Interface Devices**, right-click **HID-compliant touch screen**.
  - c. Select the **Driver** tab and then select **Update Driver**.
  - d. Select **Search automatically for drivers** and then follow the on-screen instructions to confirm the best available driver is installed.

**Note:** If there is more than one HID-compliant touch screen device listed, perform steps b-d for each device.

- e. If **Intel(R) Quick I2C Host Controller** is listed under **Human Interface Devices**, right-click **Intel(R) Quick I2C Host Controller**, select **Driver** → **Update Driver** → **Search automatically for drivers**, and then follow the on-screen instructions to confirm the best available driver is installed.

**Note:** If there is more than one Intel(R) Quick I2C Host Controller device listed, perform step e for each device.

4. Upgrade a Windows operating system. Take the following steps:
  - a. Type **windows update** in the Windows search box and press Enter.
  - b. Click **Check for updates**. If an operating system update package is available, it will be automatically downloaded and installed.
  - c. Follow the on-screen instructions to install the device drivers and necessary programs.

If the problem persists, do not hesitate to call Lenovo Customer Center. For the latest Lenovo Support phone numbers for your country or region, go to <https://pcsupport.lenovo.com/supportphonenumberlist>.

---

## Fan problems

### Loud fan noise

**Problem:** What should I do if my fan makes loud noise?

**Solution:** If your fan makes loud noise, try the following solutions one by one to troubleshoot and fix the issue:

1. Terminate power-consuming applications or processes that are not in use to reduce fan noises. Take the following steps:
  - a. Type **task manager** in the Windows search box and press Enter.
  - b. Terminate power-consuming applications or processes that are not in use.
2. Try to adjust your computer operation mode to the proper one. Choose one of the following solutions:
  - For computer models with the intelligent cooling feature, power efficiency mode or balanced mode is preferred. For details, see “Intelligent cooling” in this *User Guide*.
  - For computer models with the system operation modes feature, power saving (quiet) mode or auto (balanced) mode is preferred. For details, see “System operation modes” in this *User Guide*.
3. Try to update the operating system or device drivers to the latest version. For details, see “OS problems” or “Driver problems” in this *User Guide*.

If the problem persists, do not hesitate to call Lenovo Customer Center. For the latest Lenovo Support phone numbers for your country or region, go to <https://pcsupport.lenovo.com/supportphonenumberlist>.

## Computer overheating

**Problem:** What should I do if my computer is overheating?

**Solution:** If your computer is overheating, try the following solutions one by one to troubleshoot and fix the issue:

1. Improve airflow. Ensure that the vents of your computer are not covered and there is enough airflow to keep the computer cool. Avoid using the computer on a soft surface, such as a bed or couch. It is recommended to use the computer on a table or lap desk in a cool room.



2. Try to adjust your computer operation mode to the proper one. Choose one of the following solutions:
  - For computer models with the intelligent cooling feature, power efficiency mode or balanced mode is preferred. For details, see “Intelligent cooling” in this *User Guide*.
  - For computer models with the system operation modes feature, power saving (quiet) mode or auto (balanced) mode is preferred. For details, see “System operation modes” in this *User Guide*.
3. If the issue is still not fixed, try to terminate power-consuming applications or processes that are not in use to reduce heat. Take the following steps:
  - a. Type **task manager** in the Windows search box and press Enter.
  - b. Terminate power-consuming applications or processes that are not in use.

If the problem persists, do not hesitate to call Lenovo Customer Center. For the latest Lenovo Support phone numbers for your country or region, go to <https://pcsupport.lenovo.com/supportphonenumberlist>.

---

## Hinge problems

### My computer hinges lose torque

**Problem:** What should I do if my computer hinges lose torque?

**Solution:** If your computer hinges lose torque, take the following steps:

1. Go to <https://support.lenovo.com/partnerlocator> to locate the nearest service center.
2. Go to a service center in your area for professional support.

If the problem persists, do not hesitate to call Lenovo Customer Center. For the latest Lenovo Support phone numbers for your country or region, go to <https://pcsupport.lenovo.com/supportphonenumberlist>.

### My computer cannot be opened or closed

**Problem:** What should I do if I cannot open or close the computer?

**Solution:** If you cannot open or close the computer, take the following steps:

1. Go to <https://support.lenovo.com/partnerlocator> to locate the nearest service center.
2. Go to a service center in your area for professional support.

If the problem persists, do not hesitate to call Lenovo Customer Center. For the latest Lenovo Support phone numbers for your country or region, go to <https://pcsupport.lenovo.com/supportphonenumberlist>.

---

## Pen problems

### My pen is not detected or does not work



**Problem:** What should I do if my pen is not detected or does not work?

**Solution:** If your pen is not detected or does not work, try the following solutions one by one to troubleshoot and fix the issue:

1. Charge the pen.

**Note:** The charging time might vary depending on pen types.

2. Establish Bluetooth connection between your pen and your computer properly. Take the following steps:

- a. Click the quick settings area    on the right side of taskbar.
  - b. Click the Bluetooth settings and turn on the Bluetooth.
  - c. Select the pen in the list displayed and follow on-screen instructions.
3. Update **Lenovo Pen Settings**, an app preinstalled on your computer, and ensure that your pen has paired to your computer through Bluetooth.

If the problem persists, do not hesitate to call Lenovo Customer Center. For the latest Lenovo Support phone numbers for your country or region, go to <https://pcsupport.lenovo.com/supportphonenumberlist>.

---

## USB problems

### My USB connector does not work

**Problem:** What should I do if my USB connector does not work?

**Solution:** If your USB connector does not work, try the following solutions one by one to troubleshoot and fix the issue:

1. Ensure that the cable is connected properly to your computer or there are no debris in your USB connector.
2. Try to use a different USB connector on your computer.
3. Ensure that your USB connector supports charging function if you are using a USB connector for charging.
4. Try to disable **USB selective suspend setting**. Take the following steps:
  - a. Type **power plan** in the Windows search box and press Enter.
  - b. Click **Edit power plan → Change advanced power settings**.
  - c. Double-click **USB settings → USB selective suspend setting** to expand the menu.
  - d. Disable **On battery** and **Plugged in** and click **Apply**.
  - e. Restart your computer.
5. Try to restart your computer.
6. Try to update the driver. Take the following steps:
  - a. Type **device manager** in the Windows search box and then press Enter.
  - b. Click **Device Manager** from the list of results. The Device Manager window opens.
  - c. Click the arrow icon > next to **Universal Serial Bus controllers** to expand the section.
  - d. Right-click the USB device you would like to update.
  - e. Select **Update driver** and follow the on-screen instructions.

If the problem persists, do not hesitate to call Lenovo Customer Center. For the latest Lenovo Support phone numbers for your country or region, go to <https://pcsupport.lenovo.com/supportphonenumberlist>.

### Recover data from a USB drive

**Problem:** How to recover data from a USB drive?

**Solution:** To recover data from a USB drive, choose one of the following solutions to troubleshoot and fix the issue:

- Recover data by using command lines. Take the following steps:
  1. Connect the USB drive to your computer.
  2. Press Windows key+R to launch Windows Explorer.
  3. Type **CMD** in the search box and press Enter.
  4. Type **chkdsk E: /f** and press Enter.

**Note:** Replace E with your actual USB drive letter.

5. Type **ATTRIB -H -R -S /S /D E:\*. \*** and press Enter.

**Note:** Replace E with your actual USB drive letter.

6. Wait for the process to finish.

All the recovered files will be in a new folder on your USB drive after the process is complete.

**Note:** These files names might be with the extension “.chk”. You can change it into the original extension, for example, “.jpg” , and save the files to another location.

- If you have created a recovery USB drive as a backup for the Windows recovery programs, recover data by restoring to a previous version. Take the following steps:
  1. Connect the USB drive to your computer and enter **This PC**.
  2. Right-click your USB drive and select **Properties**.
  3. Click **Previous Versions** and select an available previous version.
  4. Click **Restore to** and choose a new location to save the files.
- Recover data by using a reliable USB data recovery tool.

If the problem persists, do not hesitate to call Lenovo Customer Center. For the latest Lenovo Support phone numbers for your country or region, go to <https://pcsupport.lenovo.com/supportphonenumberlist>.

## Create a recovery drive

**Problem:** How to create a recovery drive?

**Solution:** To create a recovery drive, take the following steps:

**Attention:** The process of creating a recovery drive deletes all the data stored on the USB drive, including the data stored in a hidden folder.

1. Prepare a USB drive (at least 32 GB of storage).
2. Type **Create a recovery drive** in the Windows search box and then select it.
3. Ensure that **Back up system files to the recovery drive** is selected and then click **Next**.
4. Connect the USB drive to your computer, select it and then click **Next**.
5. Click **Create** to start the recovery drive creation process.

If the problem persists, do not hesitate to call Lenovo Customer Center. For the latest Lenovo Support phone numbers for your country or region, go to <https://pcsupport.lenovo.com/supportphonenumberlist>.

---

## Copilot key problems

### Windows Copilot is not launched by pressing the Copilot key

**Problem:** What should I do if I cannot open Copilot in Windows by pressing the Copilot key on the keyboard?

**Solution:** If you cannot open Copilot in Windows by pressing the Copilot key on the keyboard, try the following solutions one by one to troubleshoot and fix the issue:

1. Check whether your country or region supports the function. Copilot in Windows is available in selected global markets. If the Windows Search opens after you press the Copilot key , it means your country or region does not support the function.
2. Update your Windows operating system to 23H2 or later version.

If the problem persists, do not hesitate to call Lenovo Customer Center. For the latest Lenovo Support phone numbers for your country or region, go to <https://pcsupport.lenovo.com/supportphonenumber>.

---

## Bluetooth connection problems

### Bluetooth connection error

**Problem:** What should I do if I cannot connect to Bluetooth?

**Solution:** If you cannot connect to Bluetooth, try the following solutions one by one to troubleshoot and fix the issue:

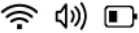
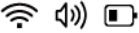
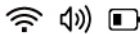
1. Ensure Bluetooth is supported and enabled on both your computer and your Bluetooth device. To turn on Bluetooth on your computer, take the following steps:
  - a. Click the quick settings area  on the right side of the taskbar.
  - b. In the Bluetooth quick setting, ensure that Bluetooth is turned on. If not, click the Bluetooth icon to turn it on.
2. Try to restart your Bluetooth device.
3. Ensure that your Bluetooth device is charged or has enough power.
4. Ensure that your Bluetooth device is placed within the required Bluetooth connection distance range of your computer.
5. Ensure that airplane mode is turned off on your computer. Take the following steps:
  - a. Click the quick settings area  on the right side of the taskbar.
  - b. In the Airplane mode quick setting, ensure that Airplane mode is turned off. If not, click the Airplane mode icon to turn it off.
6. Ensure that your Bluetooth device is not too close to other USB devices that are connected to your computer. Unshielded USB devices might interfere with Bluetooth connections.
7. Try to remove your Bluetooth device, and then add it again. Take the following steps:
  - a. Remove your Bluetooth device. Take the following steps:
    - 1) Click **Start → Settings → Bluetooth & devices → Devices**.
    - 2) Click **More options** of the Bluetooth device you are having problem with.
    - 3) Click **Remove device → Yes** to remove the Bluetooth device.
    - 4) Ensure that the Bluetooth on both your computer and the Bluetooth device are turned on. Ensure that the device is discoverable.
  - b. Add your Bluetooth device. Take the following steps:
    - 1) Click the quick settings area  on the right side of the taskbar.
    - 2) Click **Manage Bluetooth devices (>)** on the Bluetooth quick setting to expand the section.

- 3) Click the device when it is displayed on the **New devices** list, and then follow the on-screen instructions.
8. Try to run the Bluetooth troubleshooter. Take the following steps:
  - a. Click **Start → Settings → System → Troubleshoot → Other troubleshooters**.
  - b. Locate the Bluetooth section, click **Run** and then follow the on-screen instructions.
9. Try to uninstall the driver of the Bluetooth adapter. Windows will automatically install the latest driver. Take the following steps:
  - a. Type **device manager** in the Windows search box.
  - b. Click **Device Manager** from the list of results. The Device Manager window opens.
  - c. Click the arrow icon > next to **Bluetooth** to expand the section.
  - d. Right-click the Bluetooth device you are having problem with, and then click **Uninstall device**.
  - e. Confirm that you want to uninstall this device from your system in the Uninstall Device window, and then click **Uninstall**.
  - f. After the driver is uninstalled, restart your computer. Windows will automatically install the latest driver.
  - g. If Windows does not reinstall the driver automatically, open device manager and click **Action → Scan for hardware changes**.

If the problem persists, do not hesitate to call Lenovo Customer Center. For the latest Lenovo Support phone numbers for your country or region, go to <https://pcsupport.lenovo.com/supportphonenumberlist>.







---



## Network connection problems

### Wi-Fi connection error

**Problem:** What should I do if I cannot connect to Wi-Fi?

**Solution:** If you cannot connect to Wi-Fi, try the following solutions one by one to troubleshoot and fix the issue:

1. Ensure that Wi-Fi is turned on and Airplane mode is turned off. Take the following steps:
  - a. Click the quick settings area    on the right side of the taskbar.
  - b. Check if Wi-Fi is turned on. If not, click the Wi-Fi icon to turn it on.
  - c. Check if Airplane mode is turned off. If not, click the Airplane mode icon to turn it off.
2. Reconnect to Wi-Fi. Take the following steps:
  - a. Click the quick settings area    on the right side of the taskbar.
  - b. Click **Manage Wi-Fi connections** (>) on the Wi-Fi quick setting to expand the section.
  - c. Select the network you want to connect, and click **Connect**.
3. Connect to the network with a different frequency band. Most Wi-Fi routers support both 2.4 GHz and 5 GHz network frequency bands. They appear as two different networks in the list of Wi-Fi networks. If your list of Wi-Fi networks includes these two networks, connect to the one with different frequency band.
4. Run the network troubleshooter on your computer to diagnose and solve common network connecting problems. Take the following steps:

- a. Right-click the network icon in the quick settings area    on the right side of the taskbar.
- b. Click **Diagnose network problems** and follow on-screen instructions.
5. Restart your modem and wireless router. Take the following steps:
  - a. Disconnect your modem and wireless router from power source.
  - b. If your modem has a backup battery, remove the battery.
  - c. Wait for at least 30 seconds.
  - d. If you had removed the backup battery from the modem, install it.
  - e. Connect your modem and wireless router to the power source.
  - f. Connect to Wi-Fi network on your computer again.
6. Disable your wireless network adapter driver and enable it again. Take the following steps:
  - a. Type **device manager** in the Windows search box.
  - b. Click **Device Manager** from the list of results. The Device Manager window opens.
  - c. Click the arrow icon > next to **Network adapters** to expand the section.
  - d. Right-click the wireless network adapter driver, and then click **Disable device**.
  - e. Click **Yes** in the window prompted. The wireless network adapter driver is disabled.
  - f. Right-click the wireless network adapter driver again, and then click **Enable device** to enable the driver.
7. Uninstall your wireless network adapter driver and restart your computer. Take the following steps:
  - a. Before uninstalling, download the available driver on a different computer from Lenovo support website and save it to a USB flash drive. For how to download the driver, see “Driver problems” in this *User Guide*.
  - b. Type **device manager** in the Windows search box.
  - c. Click **Device Manager** from the list of results. The Device Manager window opens.
  - d. Click the arrow icon > next to **Network adapters** to expand the section.
  - e. Right-click the wireless network adapter driver, and then click **Uninstall device**.
  - f. In the Uninstall Device window, confirm that you want to uninstall this device from your system, and then click **Uninstall**.
  - g. After the driver is uninstalled, restart your computer.
  - h. Install the driver you have downloaded.
8. Contact your Internet service provider to check if there are any issues with your internet plan or connection.

If the problem persists, do not hesitate to call Lenovo Customer Center. For the latest Lenovo Support phone numbers for your country or region, go to <https://pcsupport.lenovo.com/supportphonenumber>.

---

## Power charging problems

### My computer is not charged when connected to ac power

**Problem:** What should I do if my computer is connected to ac power but not charged?

**Solution:** If your computer is connected to ac power but not charged, try the following solutions one by one to troubleshoot and fix the issue:

1. Ensure that you use Lenovo-certified ac power adapter and power cord that are designed for charging with proper wattage. If there are any visible signs of damage, you can purchase a new ac power adapter or power cord at <https://www.lenovo.com/accessories>.
2. Ensure that the power connector is clean and well-conditioned.
3. Ensure that the power adapter and power cord are completely and firmly connected to both your computer and a working power outlet.
4. Turn off the computer and disconnect the computer from ac power and all connected cables. Wait a few minutes. Then, reconnect to ac power and turn on the computer.

If the problem persists, do not hesitate to call Lenovo Customer Center. For the latest Lenovo Support phone numbers for your country or region, go to <https://pcsupport.lenovo.com/supportphonenumber>.

## My built-in battery cannot be charged

**Problem:** What should I do if my built-in battery cannot be charged?

**Solution:** If your built-in battery cannot be charged, try the following solutions one by one to troubleshoot and fix the issue:

1. Ensure that you use the power adapter with proper wattage. Low-wattage power adapters might cause battery charging problem.
2. Exit any heavy-loading programs and charge the computer again. To check the load of programs in process: Press Ctrl+Alt+Delete, and then click **Task Manager** → **Processes**.
3. Move your computer to a cool and well-ventilated spot. Battery charging is also affected by its temperature.
4. Reset the battery gauge. Take the following steps:
  - a. Open the Vantage app, and then click the menu icon at the top-right corner.
  - b. Select **Power** → **BATTERY SETTINGS**, and then click **RESET** in **Battery gauge reset** section.
5. Update the UEFI BIOS to the latest version. For details, refer to “UEFI BIOS problems” in this *User Guide*.

If the problem persists, do not hesitate to call Lenovo Customer Center. For the latest Lenovo Support phone numbers for your country or region, go to <https://pcsupport.lenovo.com/supportphonenumber>.

## My built-in battery is not fully charged

**Problem:** What should I do if my built-in battery is not fully charged?

**Solution:** Keeping the battery from full charge when battery power is not in heavy use can help extend its lifespan. If you want to fully charge the battery, try the following solutions one by one:

1. Disable the Smart Charge. Take the following steps:
  - a. Open the Vantage app, and then click the menu icon at the top-right corner.
  - b. Select **Power** → **BATTERY SETTINGS**, and then slide the **Smart charge** switch to disable the function.
2. Reset the battery gauge. Take the following steps:
  - a. Open the Vantage app, and then click the menu icon at the top-right corner.
  - b. Select **Power** → **BATTERY SETTINGS**, and then click **RESET** in **Battery gauge reset** section.
3. Update the UEFI BIOS to the latest version. For details, refer to “UEFI BIOS problems” in this *User Guide*.

If the problem persists, do not hesitate to call Lenovo Customer Center. For the latest Lenovo Support phone numbers for your country or region, go to <https://pcsupport.lenovo.com/supportphonenumberlist>.

---

## Startup problems

### My computer does not start up

**Problem:** What should I do if my computer does not start up?

**Solution** If your computer does not start up, take the following steps:

1. Ensure that the power adapter is connected to your computer and the power cord of your computer is plugged into a working electrical outlet.
2. If you are using a power strip or surge protector, ensure it is turned on and working.
3. Press the power button to turn on your computer again.

If the problem persists, do not hesitate to call Lenovo Customer Center. For the latest Lenovo Support phone numbers for your country or region, go to <https://pcsupport.lenovo.com/supportphonenumberlist>.

### Windows login error

**Problem:** What should I do if I cannot log in to Windows?

**Solution:** If you cannot log in to Windows, try the following solutions one by one to troubleshoot and fix the issue:

1. Restart your computer. The startup process might be interrupted abnormally. Restart to see if your computer can start up normally:
  - a. Shut down your computer by pressing the power button for 10 seconds until the screen turns off.
  - b. Wait about 1 minute. Then, press the power button to turn on your computer again.
2. Set the drive that the operating system has been installed on as the first boot device. Then, restart your computer. For details, refer to the BIOS related information in this *User Guide*.
3. Recover your Windows operating system. Depending on your specific situation, you can choose from different Windows recovery options. For details, go to [https://support.microsoft.com/windows\\_recovery](https://support.microsoft.com/windows_recovery)
4. Recover and restore the UEFI BIOS from the last uncorrupted and secure backup. Then, restart your computer. For details, refer to “UEFI BIOS problems” in this *User Guide*.
5. Reset the UEFI BIOS to factory default settings. Then, restart your computer. For details, refer to “BIOS problems” in this *User Guide*.

If the problem persists, do not hesitate to call Lenovo Customer Center. For the latest Lenovo Support phone numbers for your country or region, go to <https://pcsupport.lenovo.com/supportphonenumberlist>.

### Blue screen during the startup

**Problem:** What should I do if I encounter a blue screen during the startup?

**Solution:** If you encounter a blue screen during the startup, try the following solutions one by one to troubleshoot and fix the issue:

1. Fix STOP code errors:

For details, go to [https://support.microsoft.com/stop\\_code\\_error](https://support.microsoft.com/stop_code_error).
2. Update the Windows operating system. Take the following steps:
  - a. Restart your computer in safe mode. For details, go to [https://support.microsoft.com/safe\\_mode](https://support.microsoft.com/safe_mode).



- b. Get the latest updates from the Windows Update. For details, go to [https://support.microsoft.com/windows\\_update](https://support.microsoft.com/windows_update).
- c. Restart your computer.

If the problem persists, do not hesitate to call Lenovo Customer Center. For the latest Lenovo Support phone numbers for your country or region, go to <https://pcsupport.lenovo.com/supportphonenumber>.

---

## Performance problems

### My computer does not work

**Problem:** What should I do if my computer does not work?

**Solution:** If your computer does not work, try the following solutions one by one to troubleshoot and fix the issue:

1. Wait several seconds to see if your computer responds properly later.
2. Terminate tasks that are not responding.
3. Restart your computer.
  - Restart in Windows
    - a. Press Ctrl+Alt+Delete at the same time.
    - b. Click power icon  , then select **Restart**.
  - Shut down and turn on the computer again
    - a. Shut down your computer by pressing the power button for 10 seconds until the screen turns off.
    - b. Wait about 1 minute. Then, press the power button to turn on your computer again.

If the problem persists, do not hesitate to call Lenovo Customer Center. For the latest Lenovo Support phone numbers for your country or region, go to <https://pcsupport.lenovo.com/supportphonenumber>.

### My computer responds slowly

**Problem:** What should I do if my computer responds slowly?

**Solution:** If your computer responds slowly, try the following solutions one by one to troubleshoot and fix the issue:

1. Restart your computer.
2. Cool down your computer.

Turn off your computer, move it to a cooler place, and let it cool down for at least five minutes.
3. Clean up disks in Windows.

Delete temporary files and free up more drive space on your computer using Disk Cleanup. For details, go to [https://support.microsoft.com/disk\\_cleanup](https://support.microsoft.com/disk_cleanup).
4. Remove unnecessary programs from the startup programs.
  - a. Open the **Start** menu, and then click **Settings** → **Apps** → **Startup**.
  - b. In the **Startup** section, turn off the switch of programs that are not necessary to start automatically when you log in to Windows.
5. Uninstall unnecessary software.
6. Scan for viruses and Malware using the anti-virus software that is installed on your computer.

7. Change to another power mode with higher performance. For details, go to [https://support.microsoft.com/change\\_the\\_power\\_mode\\_for\\_your\\_windows\\_pc](https://support.microsoft.com/change_the_power_mode_for_your_windows_pc).
8. Repair missing or corrupted system files using the System File Checker tool. For details, go to [https://support.microsoft.com/system\\_file\\_checker](https://support.microsoft.com/system_file_checker).
9. Update the Windows operating system.  
Get the latest updates from the Windows Update. For details, go to [https://support.microsoft.com/windows\\_update](https://support.microsoft.com/windows_update).
10. Update drivers.  
You can update drivers manually. For details, refer to “Driver problems” in this *User Guide*.
11. Recover your Windows operating system.  
Depending on your specific situation, you can choose from different recovery options. For details, go to [https://support.microsoft.com/windows\\_recovery](https://support.microsoft.com/windows_recovery).

If the problem persists, do not hesitate to call Lenovo Customer Center. For the latest Lenovo Support phone numbers for your country or region, go to <https://pcsupport.lenovo.com/supportphonenumberlist>.

---

## Password problems

### Change my Windows password

**Problem:** How to change my Windows password?

**Solution:** To change your Windows password, take the following steps:

1. Type **Sign-in options** in the Windows search box and press Enter.
2. Select **Password** → **Change** and follow on-screen instructions to change the password.

If the problem persists, do not hesitate to call Lenovo Customer Center. For the latest Lenovo Support phone numbers for your country or region, go to <https://pcsupport.lenovo.com/supportphonenumberlist>.

### Reset my Windows password

**Problem:** How to reset my Windows password?

**Solution:** To reset your Windows password, choose one of the following solutions:

- If you have set security questions, take the following steps:
  1. Click **Reset password** on the sign-in screen after you have entered an incorrect password.  
**Note:** Contact your administrator if you do not see an option to reset your password.
  2. Follow on-screen instructions to reset a new password.
- If you have created a password reset disk, take the following steps:
  1. Connect a password reset disk to a USB-compatible connector on your computer.
  2. Follow on-screen instructions to reset your password.
- If you have an administrator account take the following steps:
  1. Sign in to your computer with the local administrator account.
  2. Follow on-screen instructions to reset your password.

If the problem persists, do not hesitate to call Lenovo Customer Center. For the latest Lenovo Support phone numbers for your country or region, go to <https://pcsupport.lenovo.com/supportphonenumber>.

## Retrieve my BitLocker recovery key in Windows

**Problem:** How to retrieve my BitLocker recovery key in Windows?

**Solution:** To retrieve your BitLocker recovery key in Windows, choose one of the following solutions:

- In your Microsoft account:
  1. Open a web browser on any device such as mobile phone with internet access.
  2. Sign into your Microsoft account at <https://account.microsoft.com/devices/recoverykey>.
  3. Follow on-screen instructions to find the recovery key.
- On a printed paper:

Find out the paper with the record of BitLocker recovery information if you have printed or recorded the recovery key on the paper.
- On a USB flash drive:
  1. Connect the USB flash drive into a USB-compatible connector on your computer.
  2. Follow the on-screen instructions to find the recovery key.
- By your administrator:

Contact your administrator to have the recovery key if your computer is connected to a domain or signed into an organization using a work or school e-mail account.

For more details, go to <https://support.microsoft.com/windows/finding-your-bitlocker-recovery-key-in-windows>.

If the problem persists, do not hesitate to call Lenovo Customer Center. For the latest Lenovo Support phone numbers for your country or region, go to <https://pcsupport.lenovo.com/supportphonenumber>.

---

## OS problems

### Install a Windows operating system

**Problem:** How to install a Windows operating system?

**Solution:** To install a Windows operating system, take the following steps:

**Attention:**

- It is recommended that you update your operating system through official channels. Any unofficial update might cause security risks.
  - The process of installing a new operating system deletes all the data on your internal storage drive, including the data stored in a hidden folder.
  - Before installing or upgrading a particular Windows version, make a backup copy of all the data that you want to keep.
  - Ensure that your computer is connected to the network and ac power during the whole process.
1. Get your computer ready for installing a Windows operating system. Take the following steps:

- a. Microsoft® constantly makes updates to the Windows operating system. Before installing a particular Windows version, check the compatibility list and the minimum system requirements for the Windows version. For details, go to <https://support.lenovo.com/solutions/ht512575>.
  - b. For models with a Trusted Platform Module, if you are using the Windows BitLocker® Drive Encryption feature, ensure that you have disabled the feature. You can re-enable the feature after the operating system installation is complete.
  - c. Enable the security-related features (Security Chip, Virtualization, and Secure Boot). Take the following steps:
    - 1) Restart the computer. When the logo screen is displayed, choose one of the following solutions to enter the UEFI BIOS menu depending on your computer model:
      - For ThinkPad and ThinkBook computers: Press F1.
      - For Yoga and IdeaPad computers: Press F2.
    - 2) Select **Security** and select the security-related features. Then, press Enter. Ensure that the security-related features are enabled.
    - 3) Press F10 to save the settings and exit.
2. Connect the drive that contains the operating system installation program to the computer.  
To create the installation media, refer to <https://support.microsoft.com/windows>.
3. Restart the computer. When the logo screen is displayed, choose one of the following solutions to enter the UEFI BIOS menu depending on your computer model:
- For ThinkPad and ThinkBook computers: Press F1.
  - For Yoga and IdeaPad computers: Press F2.
4. Choose one of the following solutions depending on your computer model:
- For ThinkPad computers: Select **Startup → Boot** to open the **Boot Priority Order** submenu.
  - For ThinkBook, Yoga, and IdeaPad computers: Select **Boot**.
5. Change the startup sequence. Take the following steps:
- a. Select the drive that contains the operating system installation program. Choose one of the following solutions depending on your computer model:
    - For ThinkPad computers: Such as **USB HDD**. Then, press Esc.
    - For ThinkBook, Yoga, and IdeaPad computers: Such as **USB Boot**. Then, press Esc.
  - b. Press F10 to save the setting and exit.
- Attention:** After you change the startup sequence, ensure that you select the correct device during a copy, save, or format operation. If you select the wrong device, the data on that device might be erased or overwritten.
- Note:** If the system cannot boot from the selected drive, disable **Secure Boot** and try again. Ensure that you re-enable the feature after the operating system installation is complete.
6. Follow the on-screen instructions to install the device drivers and necessary programs.

If the problem persists, do not hesitate to call Lenovo Customer Center. For the latest Lenovo Support phone numbers for your country or region, go to <https://pcsupport.lenovo.com/supportphonenumber>.

## Windows operating system installation error

**Problem:** What should I do if the installation of Windows operating system fails?

**Solution:** If the installation of Windows operating system fails, take the following steps:

1. Read the error message to figure out the specific cause.
2. Ensure that the UEFI BIOS version on your device is up-to-date.
3. Ensure that the available disk space of your computer meets the requirement of the new Windows operating system.
4. If you had antivirus software or a firewall installed on the previous system, temporarily disable the antivirus functionality within the BIOS before attempting system installation.
5. Reinstall the Windows system.

If the problem persists, do not hesitate to call Lenovo Customer Center. For the latest Lenovo Support phone numbers for your country or region, go to <https://pcsupport.lenovo.com/supportphonenumber>.

## Upgrade my Windows operating system

**Problem:** How to upgrade my Windows operating system?

**Solution:** To upgrade your Windows operating system, take the following steps:

**Attention:**

- It is recommended that you upgrade your operating system through official channels. Any unofficial update might cause security risks.
- Before upgrading a particular Windows version, make a backup copy of all the data that you want to keep.
- Ensure that your computer is connected to the network and ac power during the whole process.

1. Get your computer ready for updating the Windows operating system. Take the following steps:
  - a. Microsoft constantly makes updates to the Windows operating system. Before upgrading a particular Windows version, check the compatibility list and the minimum system requirements for the Windows version. For details, go to <https://support.lenovo.com/solutions/ht512575>.
  - b. For models with a Trusted Platform Module, if you are using the Windows BitLocker® Drive Encryption feature, ensure that you have disabled the feature. You can re-enable the feature after the operating system installation is complete.
  - c. Enable the security-related features (Security Chip, Virtualization, and Secure Boot). Take the following steps:
    - 1) Restart the computer. When the logo screen is displayed, choose one of the following ways to enter the UEFI BIOS menu depending on your computer model:
      - For ThinkPad and ThinkBook computers: Press F1.
      - For Yoga and IdeaPad computers: Press F2.
    - 2) Select **Security** and select the security-related features. Then, press Enter. Ensure that the security-related features are enabled.
    - 3) Press F10 to save the settings and exit.
2. Type **Windows Update** in the Windows search box and press Enter.
3. Click **Check for updates**. If an operating system update package is available, it will be automatically downloaded and installed.
4. Follow the on-screen instructions to install the device drivers and necessary programs.

If the problem persists, do not hesitate to call Lenovo Customer Center. For the latest Lenovo Support phone numbers for your country or region, go to <https://pcsupport.lenovo.com/supportphonenumber>.

## Windows operating system upgrading error

**Problem:** What should I do if the upgrading of Windows operating system fails?

**Solution:** If the upgrading of Windows operating system fails, take the following steps:

1. Read the error message to figure out the specific cause.
2. Ensure that the UEFI BIOS version on your device is up-to-date.
3. Ensure that the available disk space of your computer meets the requirement of the new Windows operating system.
4. Upgrade the system again.

If the problem persists, do not hesitate to call Lenovo Customer Center. For the latest Lenovo Support phone numbers for your country or region, go to <https://pcsupport.lenovo.com/supportphonenumber>.

## Recover my Windows operating system

**Problem:** How to recover my Windows operating system?

**Solution:** To recover your Windows operating system, choose one of the following recovery options:

- **Reset system to factory default:**

Refer to the instructions in <https://support.lenovo.com/HowToCreateLenovoRecovery>.

- **Other recovery options such as recovering system to a previous system point:**

Refer to the instructions in Popular Topics: <https://support.lenovo.com/solutions/ht118590>.

Here are some frequently-asked cases and solutions for your reference:

Cases	Solutions
Your computer does not work well and you recently installed a device from Windows Update.	Remove the installed update device.
Your computer does not work well and it has been a while since you installed an app or changed system settings.	Reset your system.
Your computer cannot start or is still loading.	Use the Startup Repair function.
Your computer cannot start, you have not created a recovery drive, and resetting your computer does not work.	Use installation media to reinstall Windows operating system.
Your computer cannot start and you have not created a recovery drive.	Use installation media to restore your computer.
Your computer cannot start and you have created a recovery drive.	Use a recovery drive to restore or recover your computer.
You want to reinstall your previous operating system.	Go back to your previous version of Windows operating system.
Your computer does not work well and you recently installed an app.	Restore from a system restore point.
You suspect your device has been infected.	Use installation media to reinstall Windows operating system.

If the problem persists, do not hesitate to call Lenovo Customer Center. For the latest Lenovo Support phone numbers for your country or region, go to <https://pcsupport.lenovo.com/supportphonenumber>.

## Windows operating system recovery error

**Problem:** What should I do if the recovery of Windows operating system fails?

**Solution:** If the recovery of Windows operating system fails, take the following steps:

1. Read the error message to figure out the specific cause.
2. Ensure that the computer is connected to the network and ac power source.
3. Ensure that the UEFI BIOS version on your device is up-to-date.
4. Ensure that the available disk space of your computer meets the requirement of the new Windows operating system.
5. Reinstall the Windows operating system.

If the problem persists, do not hesitate to call Lenovo Customer Center. For the latest Lenovo Support phone numbers for your country or region, go to <https://pcsupport.lenovo.com/supportphonenumber>.

---

## Driver problems

### Update or install the latest device driver

**Problem:** How to update or install the latest device driver?

**Solution:** Download the latest driver for a component when you notice poor performance from that component or when you install a new component.

**Attention:**

- Before updating or installing a driver:
  - Check if it is compatible with your computer. Ensure that the driver you download matches your computer and system version to avoid compatibility issues.
  - Make a backup copy of all the essential data to avoid data loss. Especially for drivers like graphic card, sound card, network card, and so on, which can potentially affect the stability and the performance of your computer.
- During the process of updating or installing a driver, ensure that your computer is connected to the network.
- After completing the process of updating or installing a driver, restart your computer to enable the new driver.
- Among the following solutions, it is recommended to download Lenovo-qualified drivers from Lenovo Support Web site.

To update and install the latest driver, try one of the following solutions:

- From the Lenovo Support Web site:
  1. Go to <https://pcsupport.lenovo.com> and type the product name or the serial number of your computer into the search box and select your product from the dropdown list.
  2. Click **Drivers & Software**. Click **Select Drivers** under the **Manual Update** tab. Select and download the update package as desired.
  3. Follow the instruction at <https://support.lenovo.com/solutions/HT074189> to manually install the driver.
- From the Windows Update:
  1. Type **Windows Update** in the Windows search box and press Enter.

2. Click **Check for Updates**. If an update package is available, it will be automatically downloaded and installed.

- From the Vantage app:

**Note:** Ensure that the Vantage app is up to date for the best features and performance.

1. Open the Vantage app and then click **Device → System Update → CHECK FOR UPDATES**.
2. If an update package is available, follow the on-screen instructions to download and install the package.

If the problem persists, do not hesitate to call Lenovo Customer Center. For the latest Lenovo Support phone numbers for your country or region, go to <https://pcsupport.lenovo.com/supportphonenumberlist>.

## Driver installation error

**Problem:** What should I do if I encounter driver installation errors?

**Solution:** If you encounter driver installation errors, try the following solutions to troubleshoot and fix the issue according to your case:

Cases	Solutions
The device cannot be recognized by the system.	<p>Try the following solutions one by one:</p> <ol style="list-style-type: none"> <li>1. Ensure that the driver you just installed matches your computer and system version in Lenovo Support Web site.</li> <li>2. Restart your computer.</li> <li>3. Reinstall the driver. Take the following steps:               <ol style="list-style-type: none"> <li>a. Type <b>device manager</b> in the Windows search box.</li> <li>b. Click <b>Device Manager</b> from the list of results. The Device Manager window opens.</li> <li>c. Right-click the device that cannot be recognized. Then, select <b>Uninstall device</b>.</li> <li>d. After the driver is uninstalled, restart your computer. Windows will automatically install the latest driver.</li> </ol> </li> </ol>
An error message is displayed.	<p>Take the following steps:</p> <ol style="list-style-type: none"> <li>1. Read the error message to figure out the specific cause.</li> <li>2. Download the appropriate driver version from Lenovo support Web site according to the error message.</li> <li>3. Reinstall the driver.</li> </ol>
There is an exception in Device Manager.	<p>Try the following solutions one by one:</p> <ol style="list-style-type: none"> <li>1. Reinstall the driver.</li> <li>2. Roll back to the previously installed driver.</li> </ol>
<p>There are some system stability issues, for example:</p> <ul style="list-style-type: none"> <li>• The system frequently crashes.</li> <li>• Blue Screen of Death occurs.</li> </ul>	<p>For detailed operations, refer to the “Display problems” in this <i>User Guide</i>.</p>



Cases	Solutions
Performance degradation	For detailed operations, refer to the “Performance problems” in this <i>User Guide</i> .
The installation progress is stuck.	Try the following solutions one by one: <ol style="list-style-type: none"> <li>1. Restart your computer.</li> <li>2. Reinstall the driver.</li> </ol>

Find general solutions, go to <https://support.lenovo.com/solutions/HT105331>.

If the problem persists, do not hesitate to call Lenovo Customer Center. For the latest Lenovo Support phone numbers for your country or region, go to <https://pcsupport.lenovo.com/supportphonenumberlist>.

---

## UEFI BIOS problems

### Update the UEFI BIOS

**Problem:** How to update the UEFI BIOS?

**Solution:** To update the UEFI BIOS, choose one of the following solutions:

**Note:** During the UEFI BIOS update process, MRC change might cause memory retraining. Memory retraining is a process to initialize the memory module and run diagnostic tests for the memory module in your computer. When memory retraining occurs, the screen might be blank. For some computer models, you might see the LED indicators on Esc, F1, and F4 blinking sequentially to indicate the progress. **Do not press the power button to interrupt the process.** Wait a few minutes until the logo screen is displayed.

- From the Lenovo Support Web site:
  1. Go to <https://pcsupport.lenovo.com> and search by your product name.
  2. Click **Drivers & Software** → **Select Drivers** under **Manual Update** tab **BIOS/UEFI**.
  3. Follow the on-screen instructions to download and install the latest UEFI BIOS update package.
- From the Windows Update:
  1. Type **Windows update** in the Windows search box and press Enter.
  2. Click **Check for updates**.
  3. If a UEFI BIOS update package is available, it will be automatically downloaded and installed.
- From the Vantage app (for some computer models):
  1. Open the Vantage app, and then click **Device** → **System Update** → **CHECK FOR UPDATES**.
  2. If the latest UEFI BIOS update package is available, follow the on-screen instructions to download and install the package.

If the problem persists, do not hesitate to call Lenovo Customer Center. For the latest Lenovo Support phone numbers for your country or region, go to <https://pcsupport.lenovo.com/supportphonenumberlist>.

### Recover the UEFI BIOS

**Problem:** How to recover the UEFI BIOS?

**Solution:** If the UEFI BIOS is corrupted or maliciously attacked, the UEFI BIOS will automatically recover from the last uncorrupted and secure backup to protect your computer data.

During the UEFI BIOS auto-recovery, the screen will go blank. Do not press the power button to interrupt the progress. Wait a few minutes until the logo screen is displayed.

**Note:** For some computer models, you can check the progress based on blinking modes of the LED indicators on Esc, F1, and F4. For details, refer to the following table.

Blinking modes	Self-recovery progress
LED indicator on Esc blinks	0% to 32%
LED indicators on Esc and F1 blink simultaneously	33% to 65%
LED indicators on Esc, F1 and F4 blink simultaneously	66% to 100%

If the problem persists, do not hesitate to call Lenovo Customer Center. For the latest Lenovo Support phone numbers for your country or region, go to <https://pcsupport.lenovo.com/supportphonenumberlist>.

## Reset system to factory defaults

**Problem:** How to reset system to factory defaults?

**Solution:** For some computer models, you can reset the UEFI BIOS to the factory default settings, including all UEFI BIOS settings and internal system data. It helps you wipe user data in case that you want to dispose of or reuse your computer.

User data erasure is performed on the following components:

- UEFI BIOS
- Security Engine
- Embedded Controller
- Fingerprint Reader
- TPM

To reset system to factory defaults, take the following steps:

1. Restart the computer. When the logo screen is displayed, press F1 to enter the UEFI BIOS menu.
2. Select **Security** → **Reset System to Factory Defaults** and press Enter.
3. Several warning windows might be displayed. Follow the instructions to prepare for the reset.
4. Select **Reset System to Factory Defaults** again and select **Yes** to reset.

If the problem persists, do not hesitate to call Lenovo Customer Center. For the latest Lenovo Support phone numbers for your country or region, go to <https://pcsupport.lenovo.com/supportphonenumberlist>.

---

## Self-help resource

Find more information about your device through the following self-help resources.

### Product information

- Product specifications: <https://psref.lenovo.com>
- Technical specifications for Lenovo workstations: <https://thinkstation-specs.com>

## Lenovo Support resource

- Lenovo PC Technical Support web site: <https://pcsupport.lenovo.com>. You can obtain the following information and resources:
  - Drivers and software
  - Troubleshoot and diagnose
  - How to's
  - Guides and manuals
  - Warranty lookup
  - Parts lookup
  - Accessories
  - Contact us
  - Repair status check
  - Imaging and security resources
  - Glossary
- Lenovo Support phone numbers: <https://pcsupport.lenovo.com/supportphonenumber>
- Vantage app: Type **vantage** in the Windows search box. You can use the app to:
  - Configure device settings
  - Download and install UEFI BIOS, drivers, and firmware updates
  - Secure your device from outside threats
  - Diagnose hardware problems
  - Check the warranty status of your device
  - Access *User Guide* and helpful articles
- Lenovo communities:
  - Forums: <https://forums.lenovo.com>
  - Legion Gaming Community: <https://gaming.lenovo.com>
  - Lenovo EDU Community: <https://education.lenovo.com>
  - Lenovo Pro Community: <https://smbcommunity.lenovo.com>
- Troubleshooting tips: <https://www.lenovo.com/tips>

## Service information

- Warranty lookup: <https://support.lenovo.com/warranty-lookup>. You can check the warranty status of your device.
- Repair status check: <https://support.lenovo.com/track-repair-status>. You can check the repair status of your device by repair ticket, serial number, or IMEI number.
- Parts lookup and purchase: <https://support.lenovo.com/parts-lookup>. You can find service parts by serial number or machine type.
- Lenovo BIOS Simulation Center: <https://download.lenovo.com/bSCO/index.html>. You can explore the BIOS settings of your device.
- Additional services purchase: <https://pcsupport.lenovo.com/warrantyupgrade>. You can protect your device with extended warranty, Accidental Damage Protection, Premium Care & Support, and Vantage Smart Performance.

## Product documentation

Documentation title	Information included	How to Access
<i>Setup Guide</i>	Initial setup and overview information	<ul style="list-style-type: none"><li>• Access the printed version from the product package.</li><li>• Go to <a href="https://pcsupport.lenovo.com">https://pcsupport.lenovo.com</a> and search by the product name or serial number. Then, click <b>Guides &amp; Manuals</b>.</li></ul>
<i>User Guide</i>	Instructions, guidance, resources, and contact information	<ul style="list-style-type: none"><li>• Scan the QR code in <i>Setup Guide</i>.</li><li>• In Windows Start menu, click <b>User Guide</b>  .</li><li>• Type <b>vantage</b> in the Windows search box and press Enter. Then, find the <i>User Guide</i> in the app.</li><li>• Go to <a href="https://pcsupport.lenovo.com">https://pcsupport.lenovo.com</a> and search by the product name or serial number. Then, click <b>Guides &amp; Manuals</b>.</li></ul>
<i>Hardware Maintenance Manual</i>	Hardware diagnostic and replacement information for technicians	Go to <a href="https://pcsupport.lenovo.com">https://pcsupport.lenovo.com</a> and Search by the product name or serial number. Then, click <b>Guides &amp; Manuals</b> .

## Operating system support resource

- Windows help information
  - Type **get help** in the Windows search box
  - Use Windows Search or the Cortana® personal assistant
  - Microsoft Support Web site: <https://support.microsoft.com>
- Reset or restore Windows
  - Use Lenovo recovery options: <https://support.lenovo.com/HowToCreateLenovoRecovery>
  - Use Windows recovery options: Go to <https://pcsupport.lenovo.com> and search by the product name or serial number. Then, navigate to the troubleshooting menu to diagnose the operating system for recovery instructions.

## Accessory information

- Purchase accessories: <https://www.lenovo.com/accessories>
- Service recommendation and accessory configurator: <https://smartfind.lenovo.com>
- Accessories and option compatibility matrix: <https://www.lenovo.com/accessoriesguide>

## Legal and compliance information

- Product compliance: <https://www.lenovo.com/compliance>
- Legal information: <https://www.lenovo.com/us/en/legal>
- Regulatory documentation: Go to <https://pcsupport.lenovo.com> and search by the product name or serial number. Then, click **Guides & Manuals**.
  - *Safety and Warranty Guide*: Safety, warranty, recycling, and other information
  - *Generic Safety and Compliance Notices*: Compliance, accessibility, RoHS, and other information
  - *Regulatory Notice*: Regulatory notices for wireless modules

## Lenovo responsibility

- Accessibility information: <https://www.lenovo.com/accessibility>

- Environment information: <https://www.lenovo.com/us/en/sustainability-operational-impact>
- Product security: <https://www.lenovo.com/us/en/product-security/landing/>



---

## Chapter 7. Help and support

This chapter provides solutions to some hardware and software issues.

---

### Error messages

An error message is displayed for each error detected in POST or system operation. Refer to the error messages in the table below to solve your computer problems.

If you see a message that is not included in the following table, record the error message first, then shut down the computer and call Lenovo for help. See “Lenovo Customer Support Center” on page 93.

Message	Solution
0190: Critical low-battery error	The computer turned off because the battery power is low. Connect the ac power adapter to the computer and charge the batteries.
0191: System Security - Invalid remote change requested	The system configuration change has failed. Confirm the operation and try again.
0199: System Security - Security password retry count exceeded.	This message is displayed when you enter a wrong supervisor password more than three times. Confirm the supervisor password and try again.
0271: Check Date and Time settings.	The date or the time is not set in the computer. Enter the UEFI BIOS menu and set the date and time.
210x/211x: Detection/Read error on HDDx/SSDx	The storage drive is not working. Reinstall the storage drive. If the problem still exists, replace the storage drive.

Error: The non-volatile system UEFI variable storage is nearly full.

**Note:**

This error indicates that the operating system or programs cannot create, modify, or delete data in the non-volatile system UEFI variable storage due to insufficient storage space after POST.

The non-volatile system UEFI variable storage is used by the UEFI BIOS and by the operating system or programs. This error occurs when the operating system or programs store large amounts of data in the variable storage. All data needed for POST, such as UEFI BIOS setup settings, chipset, or platform configuration data, are stored in a separate UEFI variable storage. Press F1 after the error message is displayed to enter the UEFI BIOS menu. A dialog asks for confirmation to clean up the storage. If you select “Yes”, all data that were created by the operating system or programs will be deleted except global variables defined by the Unified Extensible Firmware Interface Specification. If you select “No”, all data will be kept, but the operating system or programs will not be able to create, modify, or delete data in the storage.

If this error happens at a service center, Lenovo-authorized service personnel will clean up the non-volatile system UEFI variable storage using the preceding solution.

---

### Battery-charge LED indicator diagnosis

The battery-charge LED indicator (hereafter referred to as LED indicator) blinks to help you diagnose and solve some computer problems.

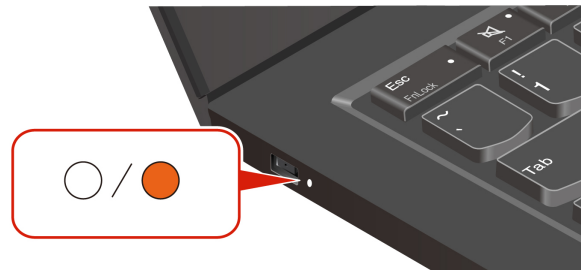

### Indicator blinking patterns

The LED indicator blinks amber first and then white continually, consisting of different blinking patterns. Each blinking pattern corresponds to an error code. For example, when the LED indicator blinks amber once ● and then blinks white twice ○○, the blinking pattern ●○○ corresponds to error code 0001.





#### Notes:

- The LED indicator blinks automatically only when the error in the following table occurs.
- The LED indicator blinks continually until the computer turns off. If you need to interrupt the process, press power button for a few seconds.
- We recommend that you speak to our Customer Support Center before attempting to service the computer yourself so that you can be directed to the correct documentation and repair information. It might be recommended to have a Lenovo-authorized service provider repair your computer depending on the complexity of the error or fault.

Refer to the blinking patterns and error codes in the table below to solve your computer problems.

Blinking patterns	Error codes	Solutions
●○○○	0001: Reset error (platform reset not de-asserted)	<ol style="list-style-type: none"> <li>1. Remove the ac power adapter and the removable battery if your computer has one. Then, reset the computer by doing one of the following: <ul style="list-style-type: none"> <li>• For models with the emergency-reset hole, insert a straightened paper clip into the emergency reset hole to cut off power supply temporarily. Then, restart the computer with ac power connected.</li> <li>• For models without the emergency-reset hole, press and hold the power button for about seven seconds. Then, reconnect to all power resources and restart the computer.</li> </ul> </li> <li>2. If step 1 does not work, replace the system board (service provider only).</li> </ol>
●○○○○	0002: Internal bus error	Replace the system board (service provider only).
●●○○○	0283: PCI resource error	<ol style="list-style-type: none"> <li>1. Remove PCIe devices (the M.2 card, PCIe card, and so on) (service provider only).</li> <li>2. If step 1 does not work, replace the system board (service provider only).</li> </ol>



Blinking patterns	Error codes	Solutions
	0284: TCG-compliant functionality-related error (might be the BIOS code validation failure)	Replace the system board (service provider only).
	0285: TCG-compliant functionality-related error (might be the TPM initialization failure)	Replace the system board (service provider only).
	0286: Integrated graphics error	Replace the system board (service provider only).
	0288: Computer display error	<ol style="list-style-type: none"> <li>1. Reconnect the display cable on both the system board side and the computer display side (service provider only) and check the LCD panel.</li> <li>2. If step 1 does not work, connect an external display to your computer and check the status (customer or service provider). <ul style="list-style-type: none"> <li>• If the external display works, replace the LCD panel (service provider only).</li> <li>• If the external display does not work, replace the system board (service provider only).</li> </ul> </li> </ol>

## Diagnostics tool

This section provides introduction to a set of diagnostics and troubleshooting tools at Lenovo Support Web site, the Vantage app, and in your computer. They can help you diagnose common software and hardware issues.

The following table lists these diagnostics tools and the recommended conditions for each tool.

Diagnostics tool	Recommended scenario
Troubleshoot and diagnose at Lenovo Support Web site	You want to have an online troubleshooting or scan of hardware and drivers on your computer.
Hardware scan	<ul style="list-style-type: none"> <li>• Your computer is installed with the Vantage app.</li> <li>• You want to perform basic examinations of the hardware components.</li> </ul>
UEFI Diagnostics tool	<ul style="list-style-type: none"> <li>• You cannot log in to the operating system.</li> <li>• Your computer cannot connect to the network.</li> </ul>

## Troubleshoot and diagnose at Lenovo Support Web site

Lenovo provides two different diagnosing options to help you identify and resolve problems on your computer.

- Step 1. Go to <https://www.pcsupport.lenovo.com/> and enter your product name in the search box.
- Step 2. Click **Troubleshoot & Diagnose** and select from the following two options depending on your needs.

If you are unsure of the problem with your computer, it is recommended that you select **Easy** and follow on-screen instructions to get your firmware updated and obtain the hardware status.

If you have identified the problem on your computer, you can select **Custom** and follow on-screen instructions to resolve the problem.

**Notes:**

- Before launching any automatic diagnosing process, a pop-up window will prompt you to install Lenovo Service Bridge. Lenovo Service Bridge helps to connect your computer with Lenovo diagnosing tools.
- Lenovo Support Web site makes periodic updates of the sections to keep improving your experience with your computer. The Web site interface and descriptions of sections might be different from that on your actual interface.

If solutions cannot resolve problems on your computer, you can follow on-screen instructions to submit an e-ticket or contact Lenovo for professional assistance.

## Hardware scan

Hardware scan is an effective hardware testing tool to help you identify existing hardware issues.

To run the Hardware scan:

- Step 1. Type **Vantage** in the Windows search box and then press Enter.
- Step 2. Click **Hardware scan** or **Support → Hardware scan**.
- Step 3. Select **QUICK SCAN** or **CUSTOMIZE** and then follow the on-screen instructions to run the hardware scan.

**Notes:**

- The Quick Scan tool contains a pre-selected suite of tests that performs basic examinations of the hardware components found in the system. The Customize tool enables you to select one or several hardware components to perform the examinations.
- Before selecting **QUICK SCAN**, click **Refresh Modules** to ensure that the list of hardware components is the components currently available for the computer.

- Step 4. If any hardware failure is detected, the result varies depending on the warranty status and varies by country or region. Follow the on-screen instructions to resolve the issue.

## UEFI Diagnostics tool

UEFI Diagnostics tool enables you to view system information and identify hardware issues when you cannot log in to the operating system, or the computer cannot connect to the network.

To use the UEFI Diagnostics tool:

- Step 1. Connect your computer to ac power.
- Step 2. Turn on your computer, and press F10 immediately to enter the UEFI Diagnostics tool.
- Step 3. Follow the on-screen instructions to run the test.
- Step 4. Press Esc to exit the tool. Your computer will restart immediately.
- Step 5. If any hardware failure is detected and you are unable to locate and resolve the problem, you can call Lenovo Customer Support Center. See “Call Lenovo” on page 92.

---

## Lenovo Memory Self Repair

Lenovo Memory Self Repair (hereafter referred to as repair tool) enables you to repair memory single-bit or single-row failure with internal redundant resources.

It is recommended that you use the repair tool in the following situations:

- The operating system is unstable, such as having blue screen error or system crash.
- Any application operates abnormally, such as crashing or quitting unexpectedly.
- Any test result indicates memory-related errors.

**Note:** The repair tool can be used only when your computer can be turned on normally.

Step 1. Restart the computer.

Step 2. When the logo screen is displayed, trigger the repair tool by one of the following methods:

- Press F4.
- Press Enter to enter **Startup Interrupt Menu**, and then press F4.
- Press F12 to enter **App Menu**, and then select **Lenovo Memory Self Repair**.

Step 3. Read through the important information in the displayed window and click **Yes** to run the tool.

Step 4. Check the repair result on the pop-up dialog box. There are three types of results.

- **Memory Repaired:** it means that the memory failure is detected and repaired.
- **Memory failure detected but repair was unsuccessful:** it means that the memory failure is detected but cannot be repaired.
- **No failure detected:** it means that no memory failure is detected.

If the issue persists, you can try again or contact Lenovo for additional support.

Step 5. Click **Continue** to turn on the computer.

### Related topics

“Call Lenovo” on page 92

---

## Windows label

Windows Genuine Microsoft label indicates the edition of Windows preinstalled on your computer and whether the device is preinstalled with or licensed for genuine Windows.

Your computer might have a Windows Genuine Microsoft label affixed to its cover depending on the following factors:

- Your geographic location
- Edition of Windows that is preinstalled

Go to <https://www.microsoft.com/howtotell/Hardware.aspx> for illustrations of the various types of Genuine Microsoft labels.

- In the People’s Republic of China, the Genuine Microsoft label is required on all computer models preinstalled with any edition of the Windows operating system.
- In other countries and regions, the Genuine Microsoft label is required only on computer models licensed for Windows Pro editions.

The absence of a Genuine Microsoft label does not indicate that the preinstalled Windows version is not genuine. For details on how to tell whether your preinstalled Windows product is genuine, refer to the information provided by Microsoft at <https://www.microsoft.com/howtotell/default.aspx>.

There are no external, visual indicators of the Product ID or Windows version for which the computer is licensed. Instead, the Product ID is recorded in the computer firmware. Whenever a Windows product is installed, the installation program checks the computer firmware for a valid, matching Product ID to complete the activation.

In some cases, an earlier Windows version might be preinstalled under the terms of the Windows Pro edition license downgrade rights.

---

## Call Lenovo

If you have tried to correct the problem yourself and still need help, you can call Lenovo Customer Support Center.

## Before you contact Lenovo

Prepare the needed information before you contact Lenovo.

1. Record the problem symptoms and details:
  - What is the problem? Is it continuous or intermittent?
  - Any error message or error code?
  - What operating system are you using? Which version?
  - Which software applications were running at the time of the problem?
  - Can the problem be reproduced? If so, how?
2. Record the system information:
  - Product name.
  - Machine type and “serial number” on page 92.

## Find your service QR code and serial number

This topic helps you find service QR code and serial number.

Scan the QR code on the base cover assembly to view the following information:

- Your product information and warranty status
- The latest Lenovo-verified drivers and software
- Troubleshooting and diagnosing solutions when hardware or software issue is encountered
- Customer support center and e-ticket entry for professional support

You can find your serial number via:

- **Dashboard** or **Device** in the **Vantage** app
- Serial-number label of your computer (shown as below illustration)

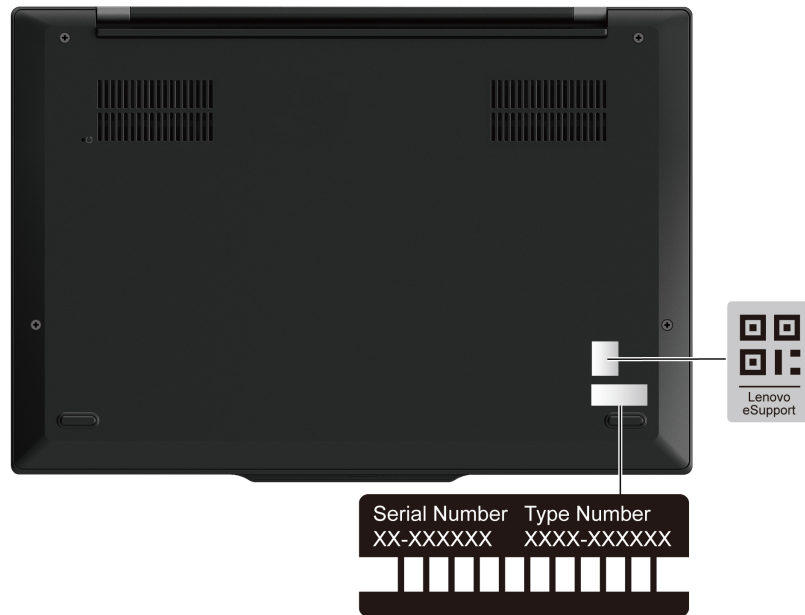

## Lenovo Customer Support Center

During the warranty period, you can call Lenovo Customer Support Center for help.

### Telephone numbers

For a list of the Lenovo Support phone numbers for your country or region, go to <https://pcsupport.lenovo.com/supportphonenumber> for the latest phone numbers.

**Note:** Phone numbers are subject to change without notice. If the number for your country or region is not provided, contact your Lenovo reseller or Lenovo marketing representative.

### Services available during the warranty period

- Problem determination - Trained personnel are available to assist you with determining if you have a hardware problem and deciding what action is necessary to fix the problem.
- Lenovo hardware repair - If the problem is determined to be caused by Lenovo hardware under warranty, trained service personnel are available to provide the applicable level of service.
- Engineering change management - Occasionally, there might be changes that are required after a product has been sold. Lenovo or your reseller, if authorized by Lenovo, will make selected Engineering Changes (ECs) that apply to your hardware available.

### Services not covered

- Replacement or use of parts not manufactured for or by Lenovo or nonwarranted parts
- Identification of software problem sources
- Configuration of UEFI BIOS as part of an installation or upgrade
- Changes, modifications, or upgrades to device drivers
- Installation and maintenance of network operating systems (NOS)
- Installation and maintenance of programs

For the terms and conditions of the Lenovo Limited Warranty that apply to your Lenovo hardware product, go to:

- [https://www.lenovo.com/warranty/llw\\_02](https://www.lenovo.com/warranty/llw_02)

- <https://pcsupport.lenovo.com/warrantylookup>

---

## Chapter 8. CRU replacement

This section provides instructions on how to replace Customer Replaceable Units (CRUs).

Customer Replaceable Units (CRUs) are parts that can be replaced by the customer. The computers contain the following types of CRUs:

- **Self-service CRUs:** Refer to parts that can be replaced easily by customer themselves or by trained service technicians at an additional cost.
- **Optional-service CRUs:** Refer to parts that can be replaced by customers with a greater skill level. Trained service technicians can also provide service to replace the parts under the type of warranty designated for the customer's machine.

If you intend on installing a CRU, Lenovo will ship the CRU to you. CRU information and replacement instructions are shipped with your product and are available from Lenovo at any time upon request. You might be required to return the defective part that is replaced by the CRU. When return is required: (1) return instructions, a prepaid shipping label, and a container will be included with the replacement CRU; and (2) you might be charged for the replacement CRU if Lenovo does not receive the defective CRU within thirty (30) days of your receipt of the replacement CRU. For full details, see the Lenovo Limited Warranty documentation at [https://www.lenovo.com/warranty/llw\\_02](https://www.lenovo.com/warranty/llw_02).

---

### CRU list

This topic provides the CRU list of your computer.

#### Self-service CRUs

- ac power adapter\*
- Base cover assembly
- M.2 solid-state drive
- M.2 solid-state drive bracket
- Nano-SIM-card tray\*
- Power cord\*
- Lenovo Yoga Pen\* (for ThinkPad X1 2-in-1 Gen 10 only)

#### Optional-service CRUs

- Built-in battery
- Wireless WAN module\*
- Wireless WAN module bracket\* (for 4G wireless WAN module only)
- Captive bracket\*

\* for selected models

**Note:** Replacement of any parts not listed above should be done by a qualified repair technician or by ensuring that you carefully follow all instructions provided by Lenovo. You can also find Lenovo-authorized repair facilities by going to <https://support.lenovo.com/partnerlocator> for more information.

---

### Before you replace any CRU

Before replacing any CRU, ensure that you disable Fast Startup first and then disable the built-in battery.

## Disable Fast Startup

Follow the instructions to disable Fast Startup.

- Step 1. Go to **Control Panel** and view by Large icons or Small icons.
- Step 2. Click **Power Options**, and then click **Choose what the power buttons do** on the left pane.
- Step 3. Click **Change settings that are currently unavailable** at the top.
- Step 4. If prompted by User Account Control (UAC), click **Yes**.
- Step 5. Clear the **Turn on fast startup** check box, and then click **Save changes**.

## Disable the built-in battery

Follow the instructions to disable the built-in battery.

- Step 1. Restart your computer. When the logo screen is displayed, immediately press F1 to enter the UEFI BIOS menu.
- Step 2. Select **Config → Power**. The **Power** submenu is displayed.
- Step 3. Select **Disable Built-in Battery** and press Enter.
- Step 4. Select **Yes** in the Setup Confirmation window.

The built-in battery is disabled and the computer turns off automatically.

Wait three to five minutes to let the computer cool.

**Note:** If your computer cannot enter the UEFI BIOS menu, you cannot disable the built-in battery. To ensure safety when you replace a CRU, it is recommended to do the following:

- For the built-in battery connected to the system board with cables: Disconnect the battery cables.
- For the CRUable built-in battery connected to the system board with comb connectors: Remove the battery. For the removal procedure, refer to the built-in battery replacement instructions in this documentation.
- For the non-CRUable built-in battery connected to the system board with comb connectors: Call Lenovo Customer Support Center for help.

To check whether the built-in battery on your computer is a CRU, see the CRU list in Chapter 8 “CRU replacement” on page 95.

---

## Replace a CRU

Follow the instructions to replace a CRU.

### Base cover assembly

Follow the instructions to replace the base cover assembly.

Before you start, read [Generic Safety and Compliance Notices](#).

**Note:** Do not remove the base cover assembly when your computer is connected to ac power. Otherwise, there might be a risk of short circuits.

For access, do the following:

1. Disable Fast Startup and the built-in battery. See “Before you replace any CRU” on page 95.



2. Turn off the computer and disconnect the computer from ac power and all connected cables.
3. Close the computer display and turn over the computer.

**Tool needed:** Phillips head screwdriver

### For ThinkPad X1 Carbon Gen 13

Step 1. Remove the base cover assembly as shown below.

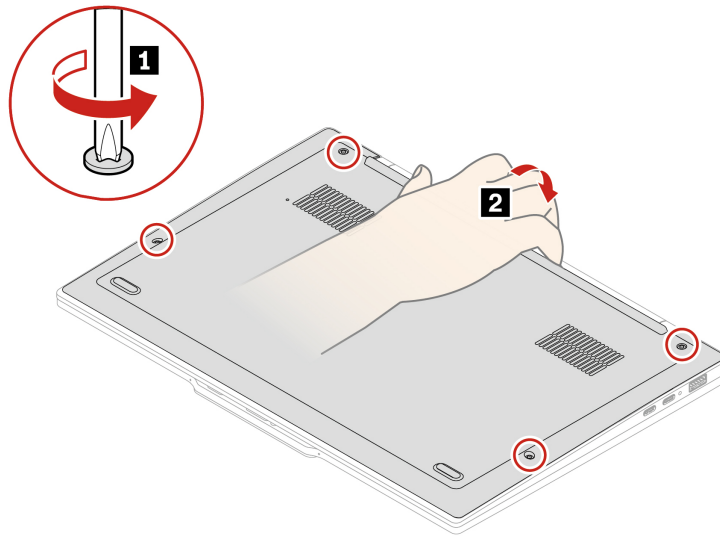

Step 2. Install the base cover assembly in reverse order.

If the computer does not start up after you reinstall the base cover assembly, disconnect the ac power adapter and then reconnect it to the computer.

### For ThinkPad X1 2-in-1 Gen 10

Step 1. Remove the base cover assembly as shown below.

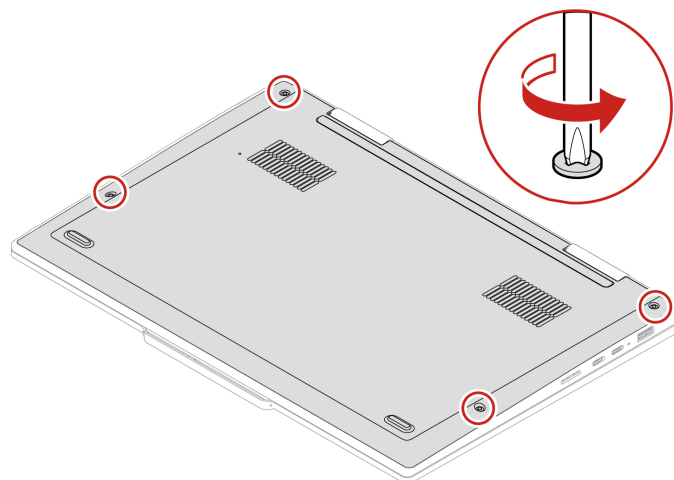

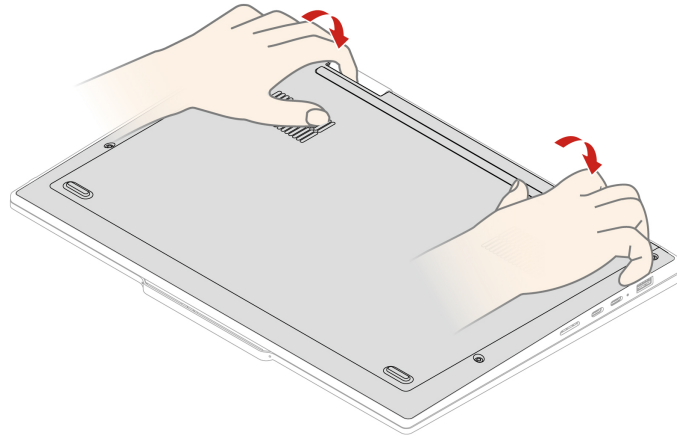

Step 2. Install the base cover assembly in reverse order.

If the computer does not start up after you reinstall the base cover assembly, disconnect the ac power adapter and then reconnect it to the computer.

## Built-in battery

Follow the instructions to replace the built-in battery.

Before you start, read [Generic Safety and Compliance Notices](#).

### CAUTION:

**Use only the Lenovo-authorized battery specified for the computer. Any other battery could ignite or explode.**

**Batteries supplied by Lenovo for use with your product have been tested for compatibility and should only be replaced with approved parts. A battery other than the one specified by Lenovo, or a disassembled or modified battery may not be covered by warranty.**

**Battery abuse or mishandling can cause overheating, liquid leakage, or an explosion. To avoid possible injury:**

- **Do not open, disassemble or service any battery unless you are competent to do so and ensure that you carefully follow all instructions provided by Lenovo.**
- **Do not crush or puncture the battery.**
- **Do not short-circuit the battery, or expose it to water or other liquids.**
- **Keep the battery away from children.**
- **Keep the battery away from fire.**
- **Stop using the battery if it is damaged, or if you notice any discharge or the buildup of foreign materials on the battery leads.**
- **Store the rechargeable batteries or products containing the rechargeable batteries at room temperature, charged to approximately 30 to 50% of capacity. We recommend that the batteries be charged about once per year to prevent overdischarge.**
- **Do not put the battery in trash that is disposed of in landfills. When disposing of the battery, comply with local ordinances or regulations.**
- **If the battery is incorrectly replaced, there is danger of an explosion. The battery contains a small amount of harmful substances.**

Lenovo recommends you use a qualified repair technician or ensure that you carefully follow all instructions provided by Lenovo. The Lenovo-authorized repair facilities or technicians recycle Lenovo batteries according to local laws and regulations. Please do not dispose of your battery with your household waste. For recycling information go to <https://www.lenovo.com/recycling>.

**Attention:** Lenovo has no responsibility for the performance or safety of unauthorized batteries, and provides no warranties for failures or damage arising out of their use.

The Vantage app provides an automatic battery diagnostic test that determines if the built-in battery is defective. A built-in battery should not be replaced unless this diagnostic test shows that the battery is defective. The only exception to this is if the built-in battery is physically damaged or a customer is reporting a possible safety issue.

If the Vantage app is not installed on the computer, the customer should download and install the program to diagnose the built-in battery, before replacing a non-physically damaged built-in battery. Note that the replacement of a physically damaged built-in battery is not covered by the warranty.

For access, do the following:

1. Disable Fast Startup and the built-in battery. See “Before you replace any CRU” on page 95.
2. Turn off the computer and disconnect the computer from ac power and all connected cables.
3. Close the computer display and turn over the computer.
4. Remove the base cover assembly. See “Base cover assembly” on page 96.

**Tool needed:** Phillips head screwdriver

Step 1. Remove the built-in battery as shown below.

- a. Loosen the six captive screws.

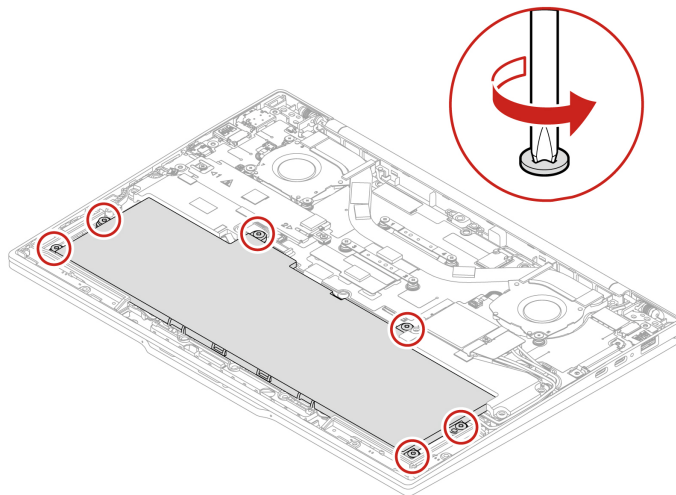

- b. Remove the battery as shown below.

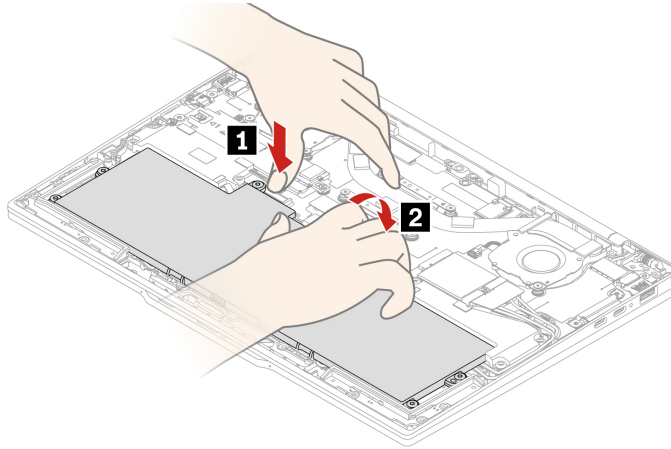

Step 2. Before installing the built-in battery, thoroughly check the battery compartment and ensure that there are no foreign or sharp objects that could cause damage to the battery.

Step 3. Install the built-in battery in reverse order.

**When installing:**

- Ensure that the connector is attached firmly.
- Ensure that the base cover assembly is secured in place. Otherwise, the battery connection might fail.

## Wireless WAN module and wireless WAN module bracket (for selected models)

Follow the instructions to replace the Wireless WAN module.

The following information is only for the computer with user-installable modules. Ensure that you use only a Lenovo-authorized wireless module specifically tested for this computer model. Otherwise, the computer will generate an error-code beep sequence when you turn on the computer.

Before you start, read [Generic Safety and Compliance Notices](#).

**Notes:**

- Wireless WAN ready model identifies that product has preinstalled wireless WAN antennas and allows a user-installable wireless WAN module.
- Only wireless WAN model or wireless WAN ready model is allowed to install the optional Lenovo wireless WAN module.

**Attention:** Do not touch the contact edge of the wireless WAN module. Otherwise, the wireless WAN module might get damaged.

For access, do the following:

1. Disable Fast Startup and the built-in battery. See “Before you replace any CRU” on page 95.
2. Turn off the computer and disconnect the computer from ac power and all connected cables.
3. Close the computer display and turn over the computer.
4. Remove the base cover assembly. See “Base cover assembly” on page 96.

**Tools needed:**

- Phillips head screwdriver
- Pry tool

### Type one – 4G wireless WAN module

Step 1.

**Note:** Depending on models, the 4G wireless WAN module might be either 4 connectors or 2 connectors.

Remove the captive bracket and wireless WAN module as shown below.

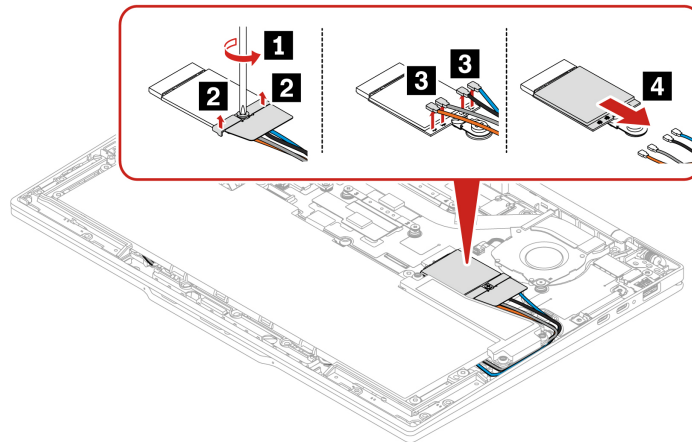

Step 2. Install the captive bracket and wireless WAN module in reverse order.

### Type two – 5G wireless WAN module

Step 1. Remove the captive bracket and wireless WAN module as shown below.

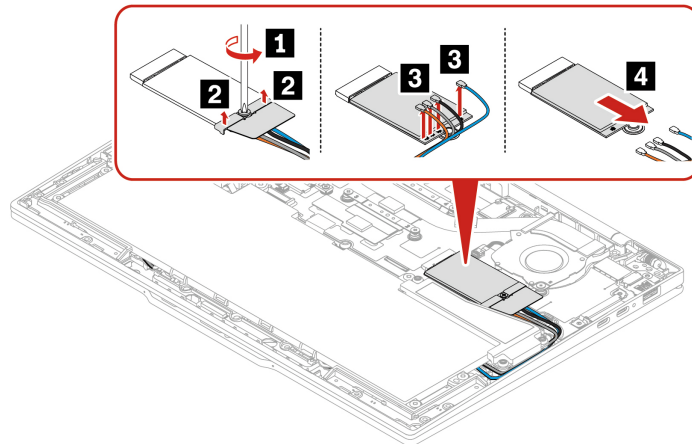

Step 2. Install the captive bracket and wireless WAN module in reverse order.

### Type three – captive bracket only

Step 1. Remove the captive bracket as shown below.

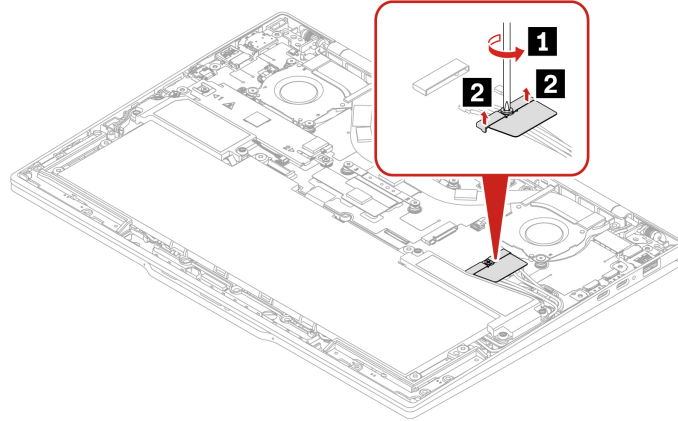

Step 2. Install the captive bracket in reverse order.

### **Type four – captive bracket and wireless WAN module bracket**

Step 1. Remove the captive bracket and wireless WAN module bracket as shown below.

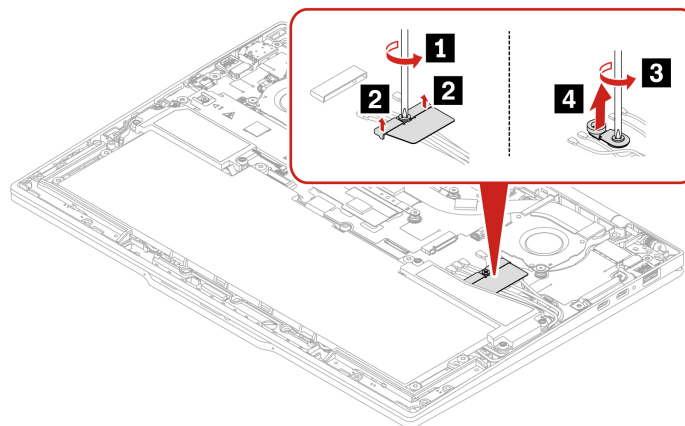

Step 2. Install the captive bracket and wireless WAN module bracket in reverse order.

### **Antenna cable routing (for selected models)**

The cable routing is different for 4G wireless WAN module and 5G wireless WAN module. Ensure that the antenna cables are installed appropriately when installing a wireless WWAN module.

**Type one – 4G wireless WAN module with 2 connectors**

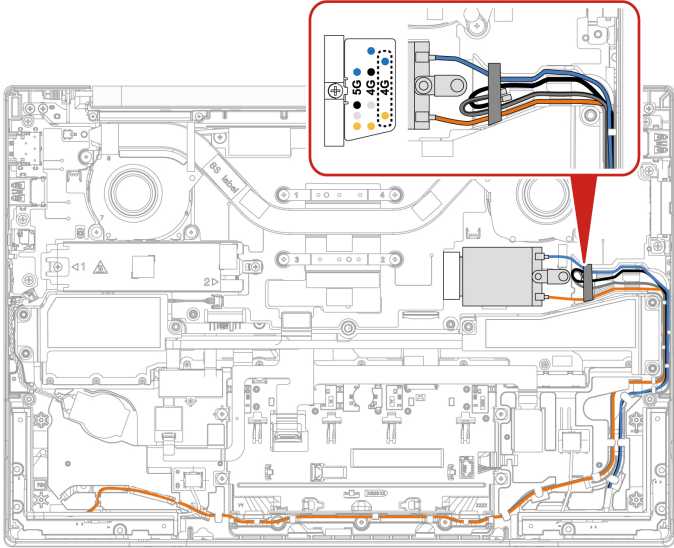

**Type two – 4G wireless WAN module with 4 connectors**

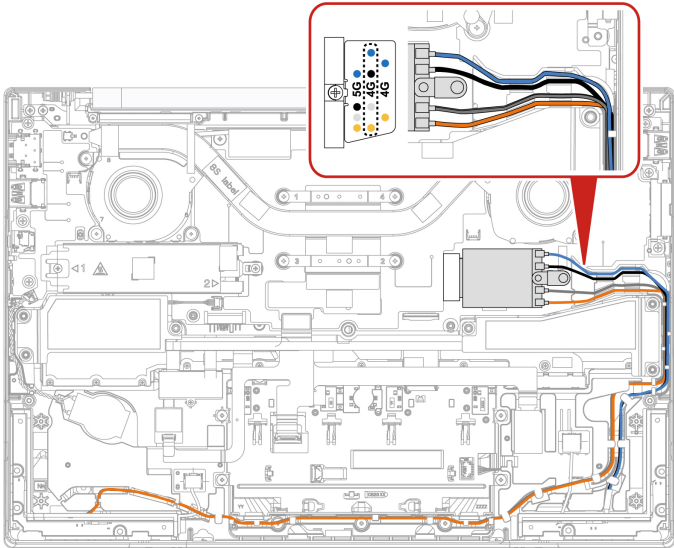

## Type three – 5G wireless WAN module

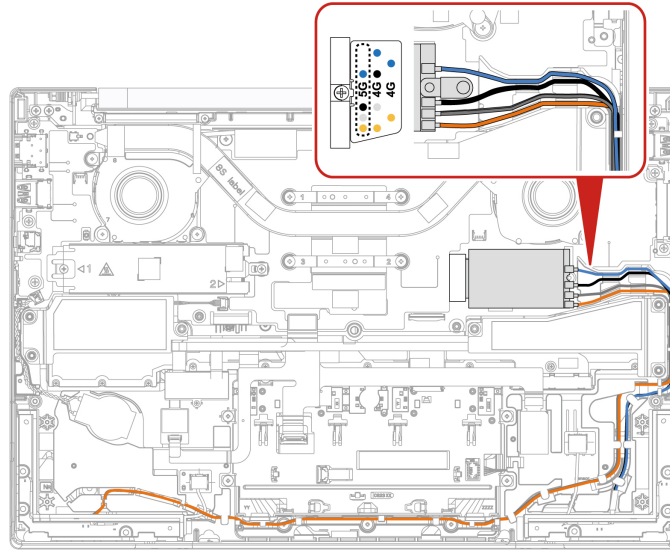

### Notes:

- Keep the tape attached away from the speaker.

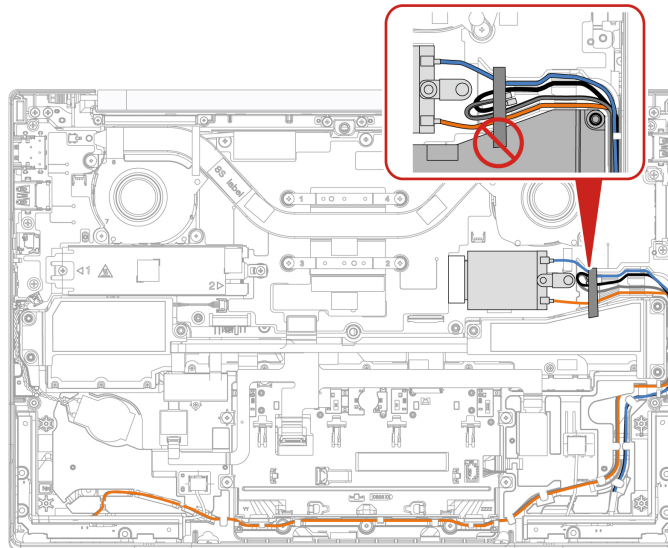

- Ensure that the orange cable does not touch the speaker.
- Ensure that the blue cable does not touch the thermal fan.



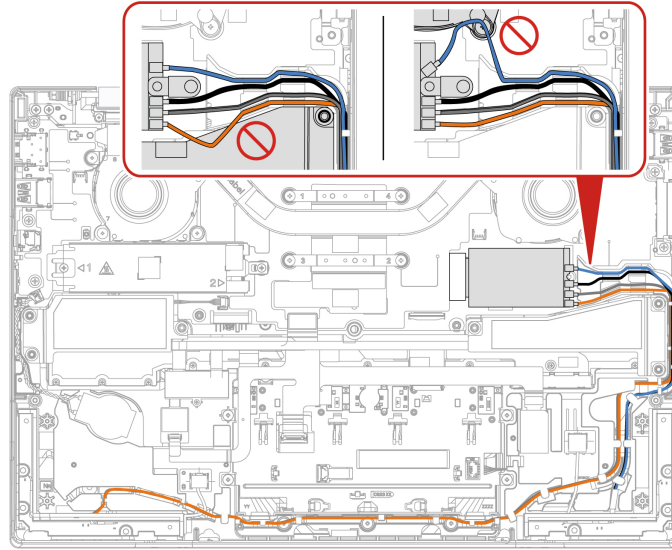

- Do not remove the plastic cover from new antenna connectors until you install the new antennas.



## M.2 solid-state drive and M.2 solid-state drive bracket

Follow the instructions to replace the M.2 solid-state drive and M.2 solid-state drive bracket.

Before you start, read [Generic Safety and Compliance Notices](#).

**Attention:** If you replace an M.2 solid-state drive, you might need to install a new operating system. For details on how to install a new operating system, see “Install a Windows operating system” on page 75.

The M.2 solid-state drive is sensitive. Inappropriate handling might cause damage and permanent loss of data.

When handling the M.2 solid-state drive, remove or insert the M.2 solid-state drive horizontally. Otherwise the slot might get damaged.

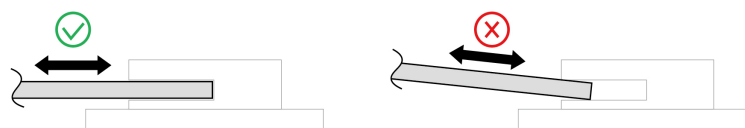

When handling the M.2 solid-state drive, observe the following guidelines:

- Replace the M.2 solid-state drive only for repair. The M.2 solid-state drive is not designed for frequent changes or replacement.
- Before replacing the M.2 solid-state drive, make a backup copy of all the data that you want to keep.
- Do not apply pressure to the M.2 solid-state drive.
- Do not touch the contact edge or circuit board of the M.2 solid-state drive. Otherwise, the M.2 solid-state drive might get damaged.
- Do not subject the M.2 solid-state drive to physical shocks or vibration. Put the M.2 solid-state drive on a soft material, such as cloth, to absorb physical shocks.

1. Disable Fast Startup and the built-in battery. See “Before you replace any CRU” on page 95.
2. Turn off the computer and disconnect the computer from ac power and all connected cables.
3. Close the computer display and turn over the computer.
4. Remove the base cover assembly. See “Base cover assembly” on page 96.

**Tool needed:** Phillips head screwdriver

Step 1. Remove the M.2 solid-state drive and M.2 solid-state drive bracket as shown below.

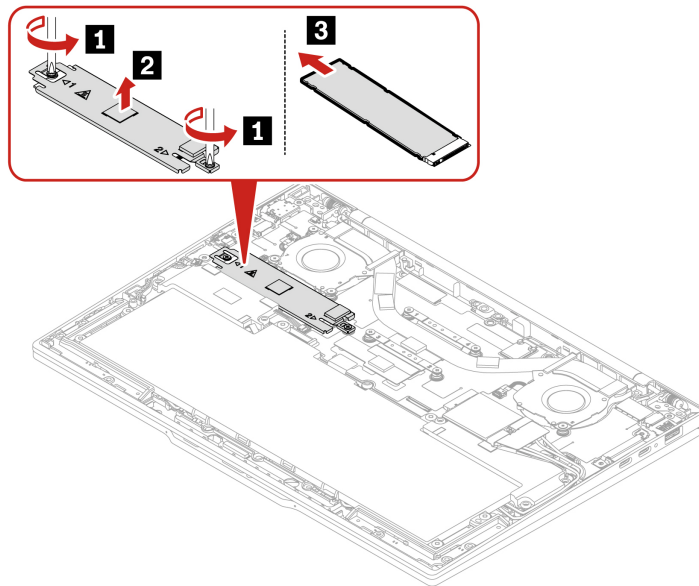

Step 2. Install the M.2 solid-state drive and M.2 solid-state drive bracket in reverse order.

## Appendix A. Compliance information

This chapter provides the compliance information of your computer.

For compliance information, refer to *Regulatory Notice* at <https://pcsupport.lenovo.com> and *Generic Safety and Compliance Notices* at [https://pcsupport.lenovo.com/docs/generic\\_notices](https://pcsupport.lenovo.com/docs/generic_notices).

### Certification-related information

This section provides certification-related information, such as product name and machine type.

Product name	Compliance ID	Machine type(s)
<ul style="list-style-type: none"> <li>ThinkPad X1 Carbon Gen 13</li> <li>ThinkPad X1 Carbon Gen 13 CAT4<sup>1</sup></li> <li>ThinkPad X1 Carbon Gen 13 LTE<sup>1</sup></li> <li>ThinkPad X1 Carbon Gen 13 5G<sup>1</sup></li> </ul>	TP00150B TP00150B0	21NS, 21NT21NX and 21NY
<ul style="list-style-type: none"> <li>ThinkPad X1 2-in-1 Gen 10</li> </ul>	TP00151B TP00151B0	21NU, 21NV, 21Q0 and 21Q1

<sup>1</sup> for mainland China only

Further compliance information related to your product is available at <https://www.lenovo.com/compliance>.

Table 1. Korean Minimum Energy Performance Standard (MEPS) value (For ThinkPad X1 Carbon Gen 13)

Energy efficiency labeling	Energy efficiency information
Computer type	A
Annual power consumption (kWh)	3.6
Power consumption in sleep mode (W)	0.5
Power consumption in off mode (W)	0.2

Table 2. Korean Minimum Energy Performance Standard (MEPS) value (For ThinkPad X1 2-in-1 Gen 10)

Energy efficiency labeling	Energy efficiency information
Computer type	A
Annual power consumption (kWh)	9.5
Power consumption in sleep mode (W)	0.7
Power consumption in off mode (W)	0.3

---

## Locate the UltraConnect wireless antennas

Your computer has an UltraConnect™ wireless antenna system. You can enable wireless communication wherever you are.

The following illustration shows the antenna locations on ThinkPad X1 Carbon Gen 13:



- 1** Wireless LAN antenna (main and auxiliary)
- 2** Wireless WAN antenna (MIMO1)\*
- 3** Wireless WAN antenna (main)\*
- 4** Wireless WAN antenna (auxiliary)\*
- 5** Wireless WAN antenna (MIMO2)\*

\* for selected models

The following illustration shows the antenna locations on ThinkPad X1 2-in-1 Gen 10:



- 1 Wireless LAN antenna (auxiliary)
- 2 Wireless LAN antenna (main)
- 3 Wireless WAN antenna (MIMO1)\*
- 4 Wireless WAN antenna (main)\*
- 5 Wireless WAN antenna (auxiliary)\*
- 6 Wireless WAN antenna (MIMO2)\*

\* for selected models

---

## Operating environment

This section provides information about the operating environment of your computer.

### Maximum altitude (without pressurization)

3048 m (10 000 ft)

### Temperature

- Operating: 5°C to 35°C (41°F to 95°F)
- Storage and transportation in original shipping packaging: -20°C to 60°C (-4°F to 140°F)
- Storage without packaging: 5°C to 43°C (41°F to 109°F)

**Note:** When you charge the battery, its temperature must be no lower than 10°C (50°F).

### Relative humidity

- Operating: 8% to 95% at wet-bulb temperature 23°C (73°F)
- Storage and transportation: 5% to 95% at wet-bulb temperature 27°C (81°F)



---

## Appendix B. Accessibility features

Lenovo is committed to making information technology accessible to everyone, including those with hearing, vision, or mobility limitations. Lenovo supports accessibility features in the following ways to help all users better engage with Lenovo products.

### Accessible documentation

Lenovo documentation is designed to meet users' accessibility needs. Users can read the documentation with assistance as needed. For example:

- Text and images are in high contrast. Color contrast can enhance the visual experience. In this mode, all contents are highlighted to be more visible.
- Text is logical and readable. Images are also readable with alternative text provided. A screen reader can enhance the hearing or listening experience. In this mode, all contents are clearer and easier to understand.
- Text is large and clear, making it easier to read. A magnifier can enlarge the text to improve readability.

For more information, watch the video at:

[https://support.lenovo.com/docs/pc\\_pub\\_accessibility](https://support.lenovo.com/docs/pc_pub_accessibility)

### Accessible product design

Lenovo product design also supports accessibility features.

**Note:** The accessibility features vary by product. Depending on the product model, some accessibility features listed below might not be applicable to the product. To get the most up-to-date accessibility information for the product, go to <https://www.lenovo.com/accessibility>. For additional support from Lenovo, users can find phone numbers for their country or region from <https://support.lenovo.com/supportphonenumber>.

- **Keyboards**

Lenovo keyboards support various accessibility features. For example:

- Tactile markings on some keys for easier identification

Tactile markings provide all users with a way to find keys without looking at the keyboard. Lenovo provides bumps for the following keys:

- Function keys: F2 and F3
- Control keys: Fn and Insert
- Typing keys: F, J, and Enter
- Navigation key: Down arrow



- Consistent layout of keyboards for easier use
- Appropriate spacing between keys for typing efficiency
- Sufficient contrast of keys, controls, and labels for better visibility
- On-screen notification or lighted notification for some keys for ease of use
- Keys and controls that can be reached and operated using one hand and require minimal dexterity for ease of use

- **Prominent Communication Bar**

As a welcome addition to your computer, the communication bar incorporates front facing camera options and microphone with 360-degree coverage. It helps you orient computer and open laptop easily.

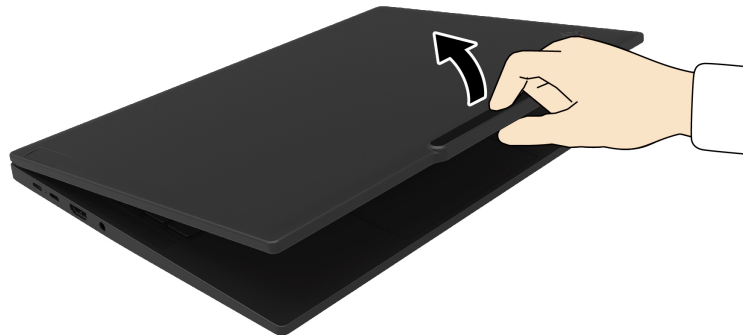

- **Alternative TrackPoint pointing device**

The TrackPoint pointing device comes with TrackPoint pointing stick and TrackPoint Three Buttons. It's a useful alternative for users to interact with the computer without using a traditional mouse. To learn how to use the TrackPoint pointing device, see “Use the TrackPoint pointing device” on page 17

- **Industry-standard connectors**

The industry-standard connectors on Lenovo products enable better compatibility with peripheral devices.

- **Operating systems**

The accessibility features of the operating systems can be configured to assist users in the following ways:



- Vision features, such as text size and visual effect settings, make the screen contents easier to see.
- Hearing features, such as audio and caption settings, make the screen contents easier to hear.
- Interaction features, such as speech and eye-control settings, make the product easier to control.

To access the accessibility features of the Windows 11 operating system, go to **Start → Settings → Accessibility**.



---

## Appendix C. Notice for USB connector name update

The USB Implementers Forum published a revision of the guideline for USB connector names in September, 2022. Lenovo follows the revised guideline and updates USB connector names accordingly. You can refer to the table below for naming update details.

<b>Current name</b>	<b>Previous name</b>
USB-A connector (Hi-Speed USB)	USB-A 2.0 connector
USB-A connector (USB 5Gbps)	USB-A 3.2 Gen 1 connector
USB-A connector (USB 10Gbps)	USB-A 3.2 Gen 2 connector
USB-A connector (USB 5Gbps, Always On USB)	Always on USB-A 3.2 Gen 1 connector
USB-A connector (USB 10Gbps, Always On USB)	Always on USB-A 3.2 Gen 2 connector
USB-C connector (USB 5Gbps)	USB-C (3.2 Gen 1) connector
USB-C connector (USB 10Gbps)	USB-C (3.2 Gen 2) connector
USB-C connector (USB 20Gbps)	USB 3.2 Gen 2x2
USB-C connector (USB4 20Gbps)	USB 4 Gen 2x2
USB-C connector (USB4 40Gbps)	USB-C (USB 4) connector
USB-C connector (Thunderbolt 3)	USB-C (Thunderbolt 3) connector
USB-C connector (Thunderbolt 4)	USB-C (Thunderbolt 4) connector



---

## Appendix D. Notices and trademarks

### Notices

Lenovo may not offer the products, services, or features discussed in this document in all countries. Consult your local Lenovo representative for information on the products and services currently available in your area. Any reference to a Lenovo product, program, or service is not intended to state or imply that only that Lenovo product, program, or service may be used. Any functionally equivalent product, program, or service that does not infringe any Lenovo intellectual property right may be used instead. However, it is the user's responsibility to evaluate and verify the operation of any other product, program, or service.

Lenovo may have patents or pending patent programs covering subject matter described in this document. The furnishing of this document does not give you any license to these patents. You can send license inquiries, in writing, to:

*Lenovo (United States), Inc.  
8001 Development Drive  
Morrisville, NC 27560  
U.S.A.  
Attention: Lenovo Director of Licensing*

LENOVO PROVIDES THIS PUBLICATION "AS IS" WITHOUT WARRANTY OF ANY KIND, EITHER EXPRESS OR IMPLIED, INCLUDING, BUT NOT LIMITED TO, THE IMPLIED WARRANTIES OF NON-INFRINGEMENT, MERCHANTABILITY OR FITNESS FOR A PARTICULAR PURPOSE. Some jurisdictions do not allow disclaimer of express or implied warranties in certain transactions, therefore, this statement may not apply to you.

Changes are made periodically to the information herein; these changes will be incorporated in new editions of the publication. To provide better service, Lenovo reserves the right to improve and/or modify the products and software programs described in the manuals included with your computer, and the content of the manual, at any time without additional notice.

The software interface and function and hardware configuration described in the manuals included with your computer might not match exactly the actual configuration of the computer that you purchase. For the configuration of the product, refer to the related contract (if any) or product packing list, or consult the distributor for the product sales. Lenovo may use or distribute any of the information you supply in any way it believes appropriate without incurring any obligation to you.

The products described in this document are not intended for use in implantation or other life support applications where malfunction may result in injury or death to persons. The information contained in this document does not affect or change Lenovo product specifications or warranties. Nothing in this document shall operate as an express or implied license or indemnity under the intellectual property rights of Lenovo or third parties. All information contained in this document was obtained in specific environments and is presented as an illustration. The result obtained in other operating environments may vary.

Lenovo may use or distribute any of the information you supply in any way it believes appropriate without incurring any obligation to you.

Any references in this publication to non-Lenovo Web sites are provided for convenience only and do not in any manner serve as an endorsement of those Web sites. The materials at those Web sites are not part of the materials for this Lenovo product, and use of those Web sites is at your own risk.

Any performance data contained herein was determined in a controlled environment. Therefore, the result obtained in other operating environments may vary significantly. Some measurements may have been made on development-level systems and there is no guarantee that these measurements will be the same on generally available systems. Furthermore, some measurements may have been estimated through extrapolation. Actual results may vary. Users of this document should verify the applicable data for their specific environment.

This document is copyrighted by Lenovo and is not covered by any open source license, including any Linux® agreement(s) which may accompany software included with this product. Lenovo may update this document at any time without notice.

For the latest information or any questions or comments, contact or visit the Lenovo Web site:

<https://pcsupport.lenovo.com>

### **Trademarks**

Lenovo, the Lenovo logo, ThinkPad, the ThinkPad logo, and TrackPoint are trademarks of Lenovo. Intel and Thunderbolt are trademarks of Intel Corporation or its subsidiaries in the U.S. and/or other countries. Linux is the registered trademark of Linus Torvalds in the U.S. and other countries. Microsoft, Windows, Windows Hello, BitLocker, , and Cortana are trademarks of the Microsoft group of companies. Dolby, Dolby Voice, and Dolby Atmos are trademarks of Dolby Laboratories Licensing Corporation. The terms HDMI and HDMI High-Definition Multimedia Interface are trademarks or registered trademarks of HDMI Licensing LLC in the United States and other countries. USB4® and USB-C® are registered trademarks of USB Implementers Forum. Wi-Fi and Miracast are registered trademarks of Wi-Fi Alliance. All other trademarks are the property of their respective owners.