

EPSON®

EM-C7100 User's Guide

Contents

EM-C7100 User's Guide	17
Product Basics	18
Installing or Using Optional Parts	18
Optional Accessories and Replacement Parts	18
Installing the Optional Cabinet.....	19
Installing the Optional Paper Cassette Units	26
Enabling the Optional Paper Cassettes - Windows.....	33
Enabling the Optional Paper Cassettes - PostScript Printer Software - Windows.....	34
Enabling the Optional Paper Cassettes - Mac	36
Enabling the Optional Paper Cassette - PostScript Printer Software - Mac	37
Product Parts Locations	38
Product Parts - Front	39
Product Parts - Inside	43
Product Parts - Back.....	45
Using the Control Panel	46
Control Panel Buttons and Lights	46
Guide to the Home Screen.....	48
Status Icon Information	48
Changing LCD Screen Language.....	50
Selecting the Date and Time	50
Selecting Your Country or Region	51
Setting a Password and Locking the Control Panel	51
Entering Characters on the LCD Screen.....	53
Using Presets.....	53
Setting User Feature Restrictions (Access Control)	54
Adjusting Control Panel Sounds	55
Adjusting the Screen Brightness.....	55
Turning Off the Operation Time Out Setting	56
Preventing PC Connection via USB	56
Using Power Saving Settings	56

Changing the Sleep Timer Settings	56
Changing the Power Off Timer Settings	57
Epson Connect Solutions for Smartphones, Tablets, and More	58
Setting Up Epson Connect Services.....	58
Using Epson Email Print	59
Using Epson Remote Print	59
Using Epson Scan to Cloud.....	60
Using AirPrint	61
Using the Mopria Print Service	62
Using Mopria Scan	62
Setting Up Printing on a Chromebook	63
Android Printing Using the Epson Print Enabler	63
Voice-activated Printing	63
Wi-Fi or Wired Networking.....	65
Network Security Recommendations	65
Wi-Fi Infrastructure Mode Setup.....	66
Selecting Wireless Network Settings from the Control Panel	67
Wi-Fi Direct Mode Setup	68
Enabling Wi-Fi Direct Mode	69
Wi-Fi Protected Setup (WPS).....	70
Using WPS to Connect to a Network	70
Printing a Network Status Sheet.....	71
Configuring Email Server Settings.....	71
Changing or Updating Network Connections	72
Changing a USB Connection to a Wi-Fi Connection.....	72
Changing a Wi-Fi Connection to a Wired Network Connection.....	72
Connecting to a New Wi-Fi Router	73
Disabling Wi-Fi Features	73
Enabling Epson Universal Print Driver (PCL) or PostScript Printing.....	75
Installing the Epson Universal Print Driver - Windows	75
Installing the PostScript (PS3) Printer Software - Windows	79
Installing the PostScript (PS3) Printer Software - Mac	79
Selecting PDL (Page Description Language) Settings	80

PDL Print Configuration Options.....	80
Selecting Printer Language and Interface Settings	83
Printing Language and Interface Options	83
Printing a PCL or PS (PostScript) Status Sheet	84
Loading Paper	85
Loading Paper in the Cassette and Rear Paper Feed Slot	85
Paper Loading Capacity	87
Double-sided Printing Paper Types.....	89
Compatible Epson Papers.....	90
Paper or Media Type Settings - Printing Software.....	93
Selecting the Paper Settings for Each Source - Control Panel	94
Paper Type Settings - Control Panel	94
Selecting Default Paper Settings - Administrator.....	95
Selecting the Default Printer Settings	95
Paper Source Settings Options.....	96
Selecting the Universal Print Settings.....	97
Universal Print Settings Options	97
Placing Originals on the Product	99
Placing Originals on the Scanner Glass	99
Placing Originals in the Automatic Document Feeder	100
Copying.....	102
Copying Documents or Photos.....	102
Copying Options.....	103
Printing from a Computer	106
Printing with the Standard Epson Printer Software - Windows	106
Selecting Basic Print Settings - Windows	107
Paper Source Options - Windows	109
Print Quality Options - Windows	110
Multi-Page Printing Options - Windows.....	110
Selecting Double-sided Printing Settings - Windows	111
Double-sided Printing Options - Windows.....	113
Print Density Adjustments - Windows	114

Selecting Additional Layout and Print Options - Windows	114
Custom Color Correction Options - Windows	116
Image Options and Additional Settings - Windows.....	117
Header/Footer Settings - Windows	118
Selecting a Printing Preset - Windows	120
Selecting Extended Settings - Windows	122
Extended Settings - Windows	123
Printing Your Document or Photo - Windows.....	125
Locking Printer Settings - Windows	125
Locked Setting Options.....	127
Entering a User ID and Password for Printing	128
Selecting Default Print Settings - Windows.....	130
Changing the Language of the Printer Software Screens	131
Changing Automatic Update Options	132
Printing with the Epson Standard Printer Software - Mac.....	133
Selecting Basic Print Settings - Mac	133
Paper Source Options - Mac.....	136
Print Quality Options - Mac	137
Print Options - Mac	137
Selecting Page Setup Settings - Mac	138
Selecting Print Layout Options - Mac.....	139
Selecting Double-sided Printing Settings - Mac.....	139
Double-sided Printing Options and Adjustments - Mac.....	141
Managing Color - Mac	141
Color Matching and Color Options - Mac	142
Selecting Printing Preferences - Mac	143
Printing Preferences - Mac.....	144
Printing Your Document or Photo - Mac	145
Checking Print Status - Mac.....	146
Printing with the Epson Universal Print Driver - Windows.....	146
Synchronizing Printer Settings - Epson Universal Print Driver - Windows	147
Selecting Print Settings - Epson Universal Print Driver - Windows	149
Selecting Default Print Settings - Epson Universal Print Driver - Windows.....	151

Locking Printer Settings - Epson Universal Print Driver - Windows	152
Epson Universal Print Driver Locked Setting Options	153
Adding Network Printers - Epson Universal Print Driver - Windows.....	154
Printing with the PostScript (PS3) Printer Software - Windows	157
Selecting Print Settings - PostScript Printer Software - Windows	157
Selecting Default Print Settings - PostScript Printer Software - Windows.....	159
Printing with the PostScript (PS3) Printer Software - Mac	161
Selecting Basic Print Settings - PostScript Printer Software - Mac	161
Printing from a Smartphone or Tablet.....	166
Cancelling Printing Using a Product Button.....	166
Scanning	167
Starting a Scan.....	167
Starting a Scan Using the Product Control Panel	167
Scanning to Email	169
Scanning to a Memory Device	170
Scanning to the Cloud.....	170
Setting Up a WSD Port (Windows 7).....	171
Control Panel Scanning Options.....	172
Setting Up and Scanning to a Network Folder or FTP Server	173
Creating a Shared Network Folder.....	174
Registering Contacts for Network Folder or FTP Scanning - Web Config	176
Registering Contacts for Email, Network, or FTP Scanning - Control Panel	177
Scanning to a Network Folder or FTP Server.....	178
Entering a User ID and Password for Scanning.....	180
Starting a Scan Using the Epson Scan 2 Icon	180
Starting a Scan from a Scanning Program.....	183
Starting a Scan from a Smartphone or Tablet.....	185
Scanning with Document Capture Pro or Document Capture	185
Setting the Operation Mode on the Product Control Panel	186
Scanning with Simple Scan in Document Capture Pro - Windows	186
Scanning with Job Scan in Document Capture Pro - Windows.....	188
Adding and Assigning Scan Jobs with Document Capture Pro - Windows	189
Scanning with Document Capture - Mac	192

Adding and Assigning Scan Jobs with Document Capture - Mac	195
Scanning in Epson Scan 2	196
Available Document Source Settings	199
Additional Scanning Settings - Main Settings Tab	199
Additional Scanning Settings - Advanced Settings Tab	200
Saving Scanned Documents as a Searchable PDF Using Epson Scan 2	201
Image Format Options	203
Scan Resolution Guidelines	203
Scanning Special Projects.....	204
Scanning to a SharePoint Server or Cloud Service - Windows.....	204
Scanning to a SharePoint Server or Cloud Service - Mac	206
Scanning Multi-Page Originals as Separate Files - Windows	208
Faxing.....	211
Connecting a Telephone or Answering Machine	211
Setting Up Fax Features	216
Setting Up Basic Fax Features	216
Using the Fax Setting Wizard.....	216
Selecting the Line Type.....	218
Setting the Number of Rings to Answer	218
Selecting Advanced Fax Settings	218
Basic Settings - Fax	219
Send Settings - Fax.....	221
Receive Settings - Fax	222
Report Settings - Fax	224
Security Settings - Fax	225
Setting Up the Fax Utility - Windows.....	226
Setting Up Fax Features Using the Fax Utility - Mac	228
Setting Up Contacts and Contact Groups.....	229
Setting Up Contacts Using the Product Control Panel	230
Creating a Contact	230
Editing or Deleting a Contact	231
Creating a Contact Group	231
Editing or Deleting a Contact Group.....	232

Sending Faxes	232
Sending Faxes from the Product Control Panel.....	233
Sending a Fax Using the Keypad, Contact List, or History	233
Fax Sending Options	235
Sending a Fax at a Specified Time	237
Receiving a Fax by Polling	238
Sending a Stored Fax	238
Dialing Fax Numbers from a Connected Telephone	239
Sending Faxes Using the Fax Utility - Windows	240
Sending Faxes Using the Fax Utility - Mac	242
Receiving Faxes.....	245
Fax Reception	245
Receiving Faxes Automatically	246
Receiving Faxes Manually.....	246
Forwarding Received Faxes.....	247
Receiving a Fax by Polling	247
Saving Faxes to an External USB Device	248
Saving and Viewing Received Faxes	248
Checking Fax Status	249
Printing Fax Reports.....	250
Fax Report Options	250
Using External USB Devices with Your Product.....	251
Connecting a USB Device.....	251
Viewing and Printing from the LCD Screen	252
Printing JPEG Photos.....	252
Print Setting Options - JPEG Mode.....	253
Printing TIFF and PDF Files	254
Print Setting Options - TIFF Mode.....	255
Print Setting Options - PDF Mode.....	256
Transferring Files on a USB Device	256
Setting Up USB Device Access	256
Replacing Ink Cartridges, Maintenance Boxes, and Cassette Rollers.....	258
Check Cartridge and Maintenance Box Status.....	258

Ink Safety Precautions.....	259
Checking Ink Status on the LCD Screen.....	261
Checking Ink and Maintenance Box Status with Windows	262
Checking Cartridge and Maintenance Box Status - Mac	262
Purchase Epson Ink Cartridges and Maintenance Box	263
Ink Cartridge Part Numbers	264
Removing and Installing Ink Cartridges	264
Maintenance Box Replacement	267
Replacing the Rollers for Paper Cassette 1.....	268
Replacing the Rollers for Paper Cassettes 2 to 4	273
Resetting the Roller Counter on the LCD Screen	278
Printing with Black Ink and Expended Color Cartridges	279
Printing with Expended Color Ink Cartridges - Control Panel.....	279
Printing with Expended Color Cartridges - Windows	280
Printing with Expended Color Cartridges - Mac	280
Conserving Low Black Ink with Windows	282
Adjusting Print Quality.....	283
Print Quality Adjustment.....	283
Adjusting the Print Quality Using the Product Control Panel.....	283
Adjusting the Quality for Each Paper Type	285
Printhead Maintenance	286
Print Head Nozzle Check.....	286
Checking the Nozzles Using the Product Control Panel	286
Checking the Nozzles Using a Computer Utility	288
Print Head Cleaning	291
Cleaning the Print Head Using the Product Control Panel	291
Cleaning the Print Head Using a Computer Utility.....	292
Print Head Alignment	294
Aligning the Print Head Using the Product Control Panel	295
Cleaning the Paper Guide	295
Cleaning and Transporting Your Product	297
Cleaning Your Product	297
Cleaning the Scanner Glass.....	298

Cleaning the Automatic Document Feeder.....	299
Transporting Your Product	301
Administering Your Product.....	304
Accessing the Web Config Utility.....	304
Changing the Administrator Password in Web Config	305
Configuring Product Settings.....	305
Checking Status Information	306
Managing the Network Connection.....	306
Network Settings.....	307
Setting Control Panel Options	311
Sending Email Notifications	311
Adjusting Power Saving Settings.....	312
Adjusting Control Panel Sounds	312
Importing and Exporting Product Settings	313
Exporting Settings Using Web Config	313
Importing Settings Using Web Config	314
Updating Firmware Using Web Config	314
Synchronizing the Date and Time with a Time Server	314
Clearing the Internal Memory	315
Adjusting the Contact List View Options	315
Powering Off or Rebooting the Product Remotely	316
Restoring Default Product Settings.....	316
Configuring Security Settings	316
Connecting an Authentication Device.....	317
Restricting Features Available for Users	318
User Feature Restriction	318
Configuring User Feature Restrictions	318
Disabling the External Interface.....	319
Setting Up Password Encryption	320
Working with Audit Logs	320
Restricting PDL File Operations	321
Enabling Program Verification on Start Up	321
Restricting Domain Access.....	321

Using Your Product on a Secure Network	322
Configuring Protocols and Services in Web Config	322
Protocol Settings.....	322
Configuring SSL/TLS Communication.....	326
Configuring SSL/TLS Settings	326
Configuring a Server Certificate for the Product.....	327
Configuring IPsec/IP Filtering	327
About IPsec/IP Filtering	328
Configuring the Default IPsec/IP Filtering Policy	328
Configuring the Group IPsec/IP Filtering Policies	328
IPsec/IP Filtering Policy Settings	329
IPsec/IP Filtering Configuration Examples.....	333
Configuring an IPsec/IP Filtering Certificate	334
Connecting the Product to an IEEE 802.1X Network.....	335
Configuring an IEEE 802.1X Network	335
IEEE 802.1X Network Settings	336
Configuring a Certificate for an IEEE 802.1X Network	337
IEEE 802.1X Network Status	337
Using a Digital Certificate	338
About Digital Certification.....	338
Obtaining and Importing a CA-signed Certificate	339
CSR Setup Settings	340
CSR Import Settings	340
Deleting a CA-signed Certificate	342
Updating a Self-signed Certificate.....	342
Importing a CA Certificate.....	343
Deleting a CA Certificate.....	343
Setting Up Universal Print (Microsoft)	344
Using Epson Device Admin Configuration Software.....	344
Solving Problems	345
Viewing the Help Screen	345
Product Status Messages	345
Job Status Error Codes	349

Running a Product Check	353
Resetting Control Panel Defaults	354
Solving Setup Problems	355
Product Does Not Turn On or Off.....	355
Noise After Ink Installation	356
Software Installation Problems	356
Solving Network Problems	356
Product Cannot Connect to a Wireless Router or Access Point	357
Network Software Cannot Find Product on a Network.....	358
Product Does Not Appear in Mac Printer Window	359
Cannot Print Over a Network.....	360
Cannot Scan Over a Network	362
Solving Copying Problems	363
Product Makes Noise, But Nothing Copies.....	363
Product Makes Noise When It Sits for a While.....	363
Originals Do Not Feed From the Automatic Document Feeder.....	363
Solving Paper Problems	364
Paper Feeding Problems	364
Paper Jams Inside the Product.....	365
Paper Ejection Problems	366
Solving Problems Printing from a Computer.....	366
Nothing Prints	367
Product Icon Does Not Appear in Windows Taskbar	368
Printing is Slow	368
Solving Page Layout and Content Problems	370
Inverted Image.....	370
Too Many Copies Print	371
Blank Pages Print	371
Incorrect Margins on Printout.....	372
Incorrect Characters Print.....	372
Incorrect Image Size or Position	372
Slanted Printout	373
Solving Print Quality Problems	374

White or Dark Lines in Printout	374
Blurry or Smearred Printout	375
Faint Printout or Printout Has Gaps	376
Grainy Printout.....	377
Incorrect Colors	378
Solving Scanning Problems	379
Scanning Software Does Not Operate Correctly	379
Cannot Start Epson Scan 2	380
Solving Scanned Image Quality Problems	381
Image Consists of a Few Dots Only.....	382
Line of Dots Appears in All Scanned Images.....	382
Straight Lines in an Image Appear Crooked	383
Image is Distorted or Blurry	383
Image Colors are Patchy at the Edges	383
Image is Too Dark	384
Back of Original Image Appears in Scanned Image	384
Ripple Patterns Appear in an Image	384
Scanned Image Colors Do Not Match Original Colors.....	385
Scanned Image Edges are Cropped	385
Solving Faxing Problems.....	385
Cannot Send or Receive Faxes.....	386
Cannot Receive Faxes with a Telephone Connected to Your Product	388
Fax Memory Full Error Appears.....	388
Sent Fax is Received in an Incorrect Size	389
Received Fax is Not Printed	389
Solving USB Device Problems	390
Cannot View or Print from a USB Device.....	390
Cannot Save Files on a USB Device	390
Cannot Transfer Files To or From a USB Device.....	391
Uninstall Your Product Software.....	391
Uninstalling Product Software - Windows.....	391
Uninstalling Product Software - Mac.....	393
Where to Get Help	393

Technical Specifications	395
Windows System Requirements	395
Mac System Requirements	396
Paper Specifications	397
Printable Area Specifications	398
Automatic Document Feeder (ADF) Specifications	400
Scanning Specifications	400
Fax Specifications	401
Ink Cartridge Specifications.....	403
Dimension Specifications	404
Electrical Specifications	405
Environmental Specifications	406
Interface Specifications	406
External USB Device Specifications.....	406
Network Interface Specifications	407
Safety and Approvals Specifications	409
PostScript Fonts.....	410
PCL Fonts	411
PCL Mode 5 Symbol Sets	413
Notices	417
Important Safety Instructions.....	417
General Product Safety Instructions	417
Ink Cartridge Safety Instructions.....	419
Wireless Connection Safety Instructions	420
LCD Screen Safety Instructions.....	420
Telephone Equipment Safety Instructions	421
FCC Compliance Statement.....	421
Binding Arbitration and Class Waiver	424
Trademarks	427
Copyright Notice.....	428
A Note Concerning Responsible Use of Copyrighted Materials.....	428
Default Delay Times for Power Management for Epson Products	428
Copyright Attribution	429

EM-C7100 User's Guide

Welcome to the EM-C7100 *User's Guide*.

For a printable PDF copy of this guide, [click here](#).

Product Basics

See these sections to learn about the basic features of your product.

[Installing or Using Optional Parts](#)

[Product Parts Locations](#)

[Using the Control Panel](#)

[Using Power Saving Settings](#)

[Epson Connect Solutions for Smartphones, Tablets, and More](#)

[Using AirPrint](#)

[Using the Mopria Print Service](#)

[Using Mopria Scan](#)

[Setting Up Printing on a Chromebook](#)

[Android Printing Using the Epson Print Enabler](#)

[Voice-activated Printing](#)

Installing or Using Optional Parts

Follow the instructions in this section to install or use optional parts.

[Optional Accessories and Replacement Parts](#)

[Installing the Optional Cabinet](#)

[Installing the Optional Paper Cassette Units](#)

Parent topic: [Product Basics](#)

Optional Accessories and Replacement Parts

You can purchase genuine Epson ink, maintenance boxes, and paper at epson.com (U.S. sales) or epson.ca (Canadian sales). You can also purchase supplies from an Epson authorized reseller. To find the nearest one, call 800-GO-EPSON (800-463-7766) in the U.S. or 800-807-7766 in Canada.

Option or part	Part number
Replacement maintenance box	C12C938211
Optional paper cassette	C12C937901
Optional cabinet	C12C932891
Paper Feed Roller for Cassette A (C1)	C12C938261

Option or part	Part number
Paper Feed Roller for Cassette B (C2-C4)	C12C938281
Authentication Device Table-P2	C12C939531

Parent topic: [Installing or Using Optional Parts](#)

Installing the Optional Cabinet

You can install the optional cabinet to provide mobility and extra storage space.

1. Turn off the product, and unplug the power cord and any connected cables.

Warning: To avoid electric shock, make sure you unplug the power cord.

2. Remove the cabinet from its packaging and remove any protective materials.
3. Make sure you have all the items shown here:

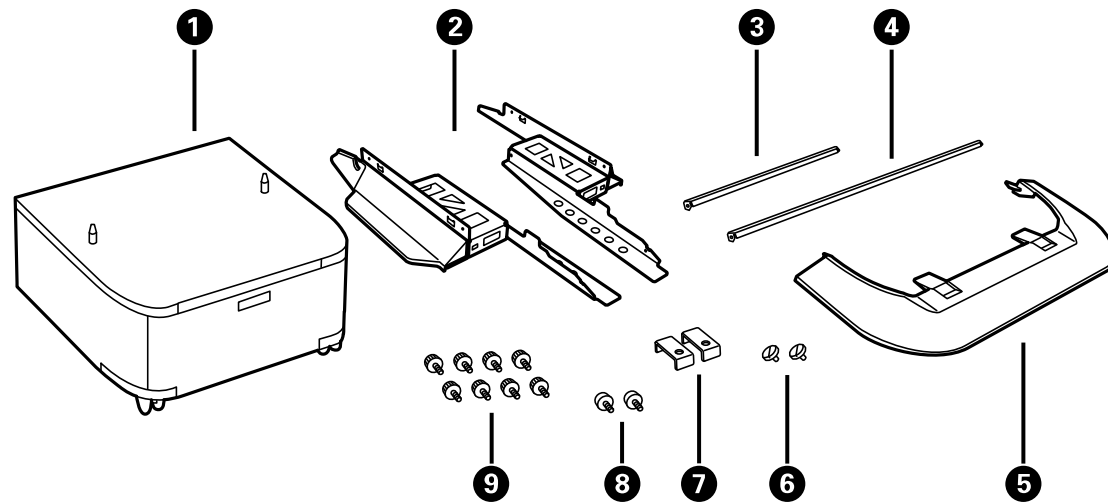

- 1 Optional cabinet
- 2 Side stands (×2)
- 3 Front reinforcing bar

- 4 Rear reinforcing bar
- 5 Front cover
- 6 Cabinet screws (×2)
- 7 Rear brackets (×2)
- 8 Bracket screws (x2)
- 9 Side stand and reinforcing bar screws (×8)

4. Place the stands between the cabinet's casters as shown.

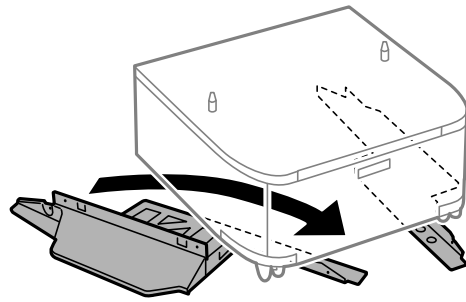

5. Secure the stands to the cabinet with the included screws.

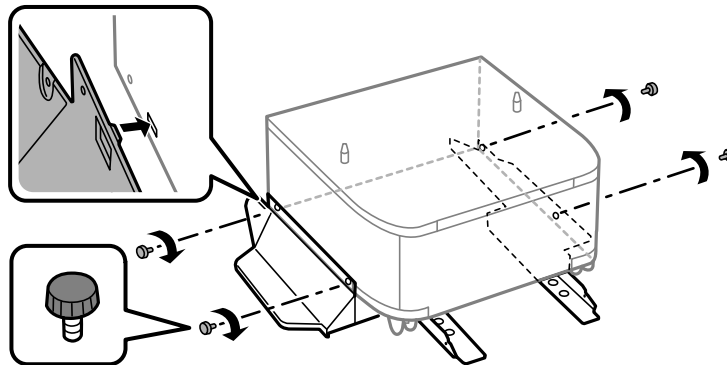

Caution: Make sure the stands are securely attached or the product may fall over.

6. Attach and secure the reinforcing bars to the stands with the included screws.

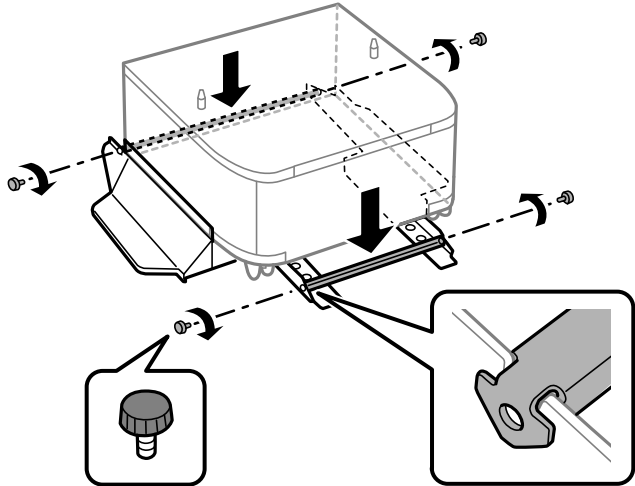

7. Place the cabinet on a flat surface and lock the front casters.

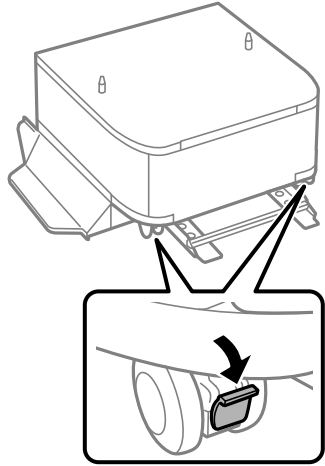

8. Attach the front cover to the stands.

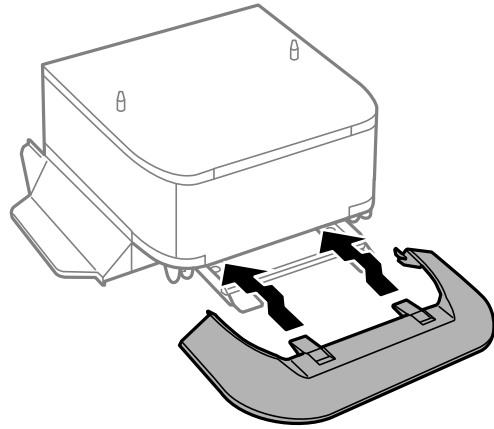

9. Remove the output tray from the product.

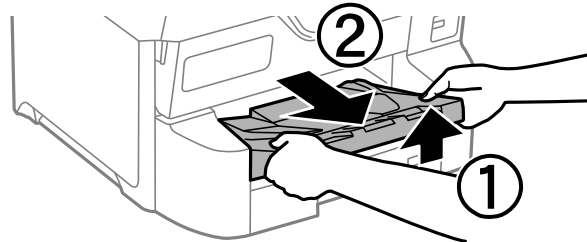

10. Remove the paper cassette from the product.

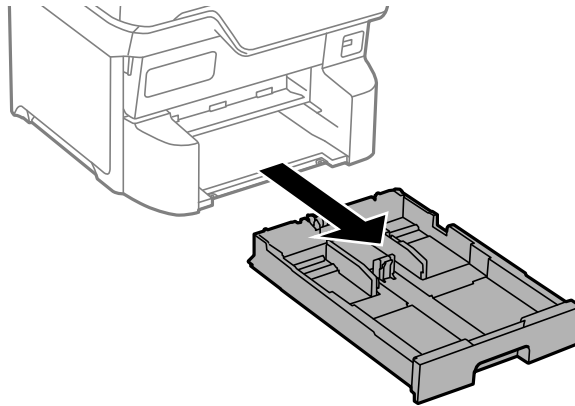

Note: If you are installing the optional cabinet under the optional paper cassette unit, remove the paper cassette from the optional cassette unit instead.

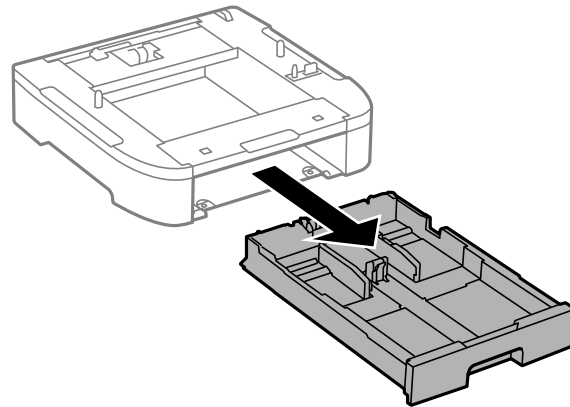

11. Lift up your product or optional cassette unit and gently lower it onto the cabinet with the corners aligned. Secure the product or optional cassette unit to the cabinet with the included screws using a screwdriver.

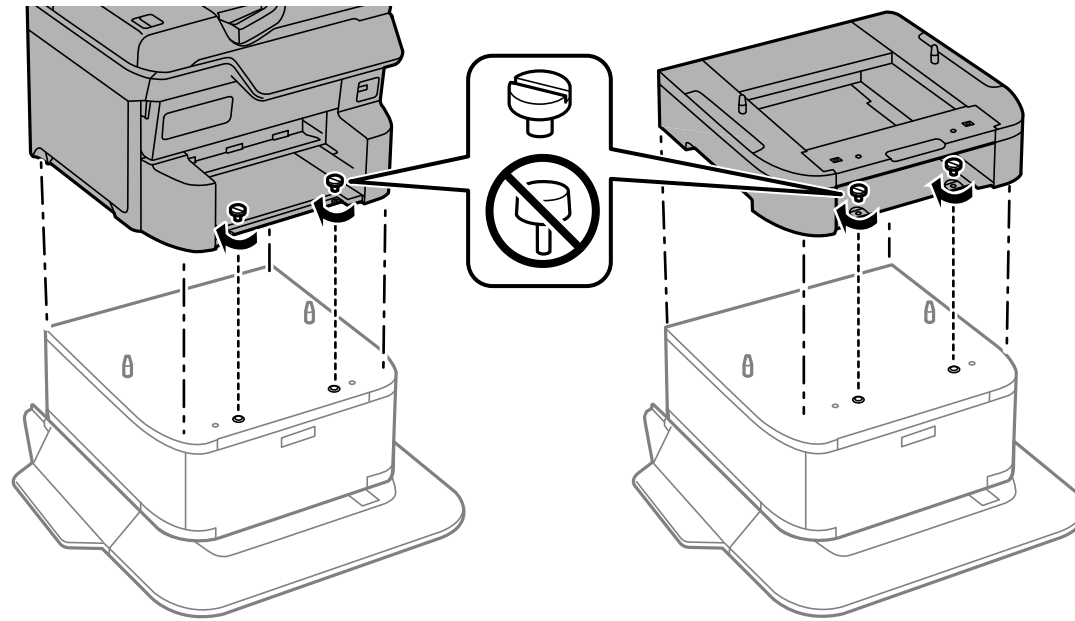

Note: Screws may be left over after installation.

Warning: To lift the product, have two or more people hold it as shown here. Lifting from other areas may cause the product to fall or cause you to pinch your fingers when placing the product down.

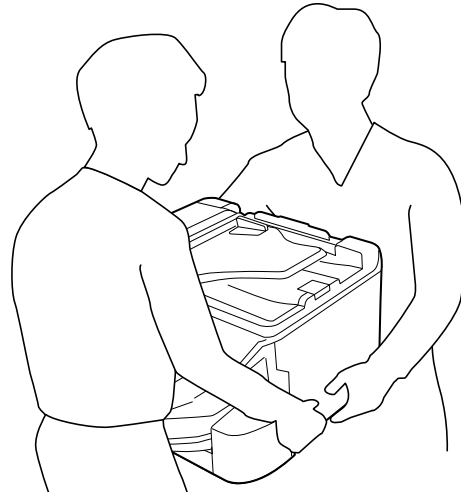

12. Secure the back of the product or paper cassette unit to the cabinet using the included brackets and screws.

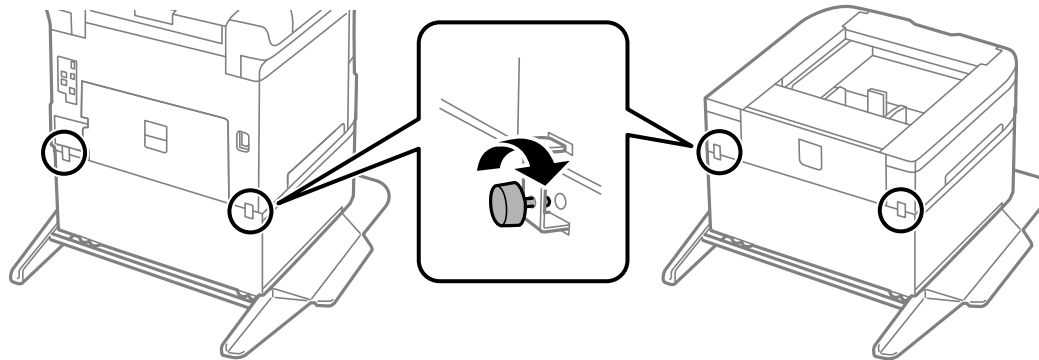

13. Insert the paper cassette you removed and attach the output tray.
14. Connect the power cord and other connection cables, then plug in the product.

Parent topic: [Installing or Using Optional Parts](#)

Installing the Optional Paper Cassette Units

You can install up to three optional paper cassette units to provide more paper capacity. If you are using the optional cabinet, install the cabinet under the bottom optional cassette unit first.

1. Turn off the product, and unplug the power cord and any connected cables.

Warning: To avoid electric shock, make sure you unplug the power cord.

2. Uninstall any optional cassette units already installed on the product.

Note: To uninstall optional cassette units, turn off the product, unplug the power cord, disconnect any cables, and follow the rest of these instructions in reverse.

3. Remove the paper cassette unit from its packaging and remove any protective materials.
4. Make sure you have all the items shown here:

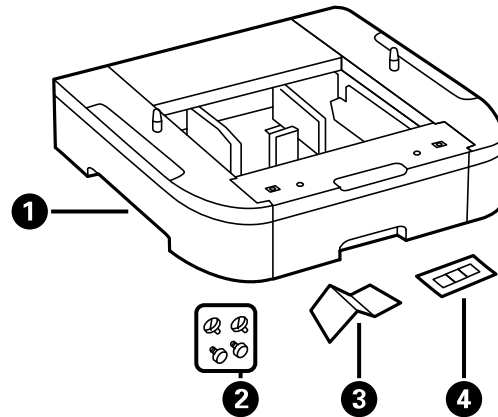

- 1 Optional cassette
- 2 Screws (×4)
- 3 Paper size label
- 4 Cassette number sticker

5. Remove the output tray from the product.

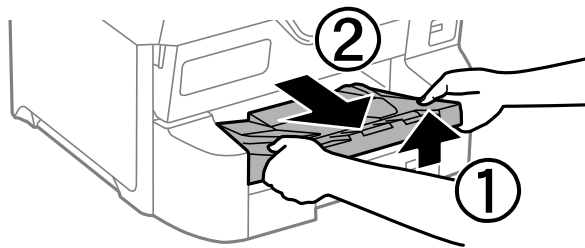

6. Remove the paper cassette from the product.

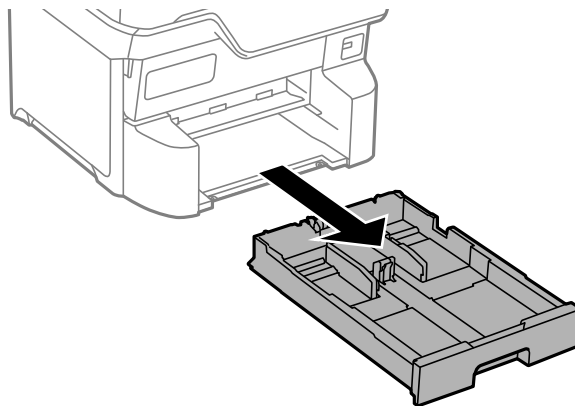

7. Remove the paper cassette from the optional paper cassette unit.

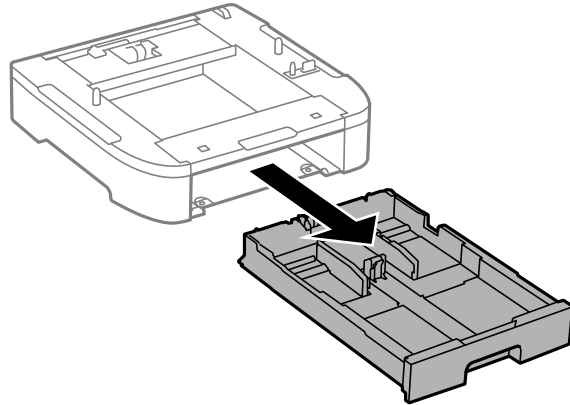

8. Stack all optional paper cassette units on top of each other and secure them to each other with the included screws.

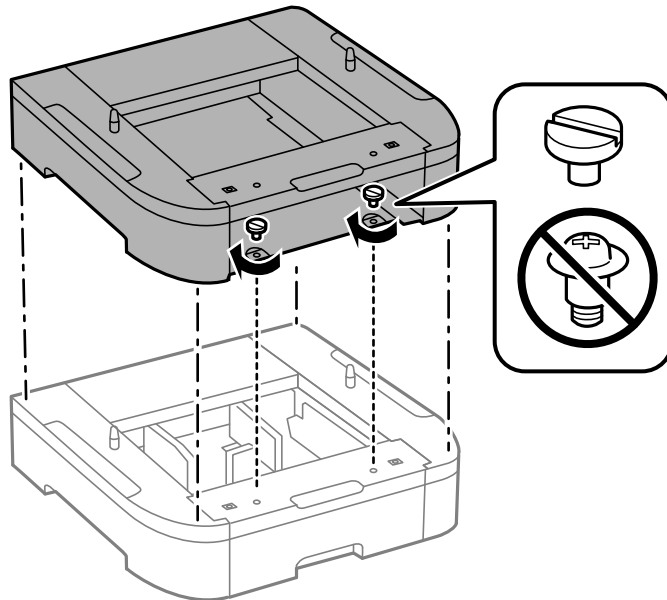

9. Lift up your product and gently lower it onto the paper cassette unit with the corners aligned. Secure the product to the paper cassette unit with the included screws using a screwdriver.

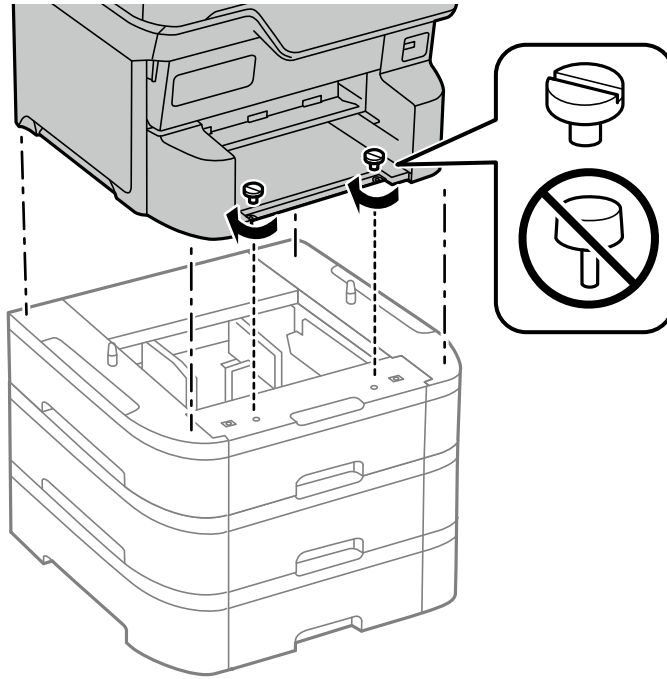

Note: Screws may be left over after installation.

Warning: To lift the product, have two people hold it as shown here. Lifting from other areas may cause the product to fall or cause you to pinch your fingers when placing the product down.

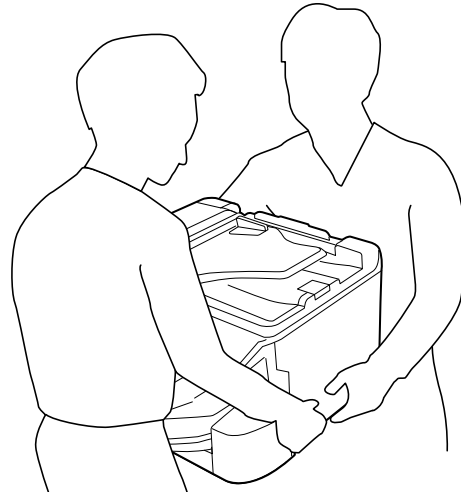

- Secure the back of the paper cassette units to each other and to the product using the included brackets and screws.

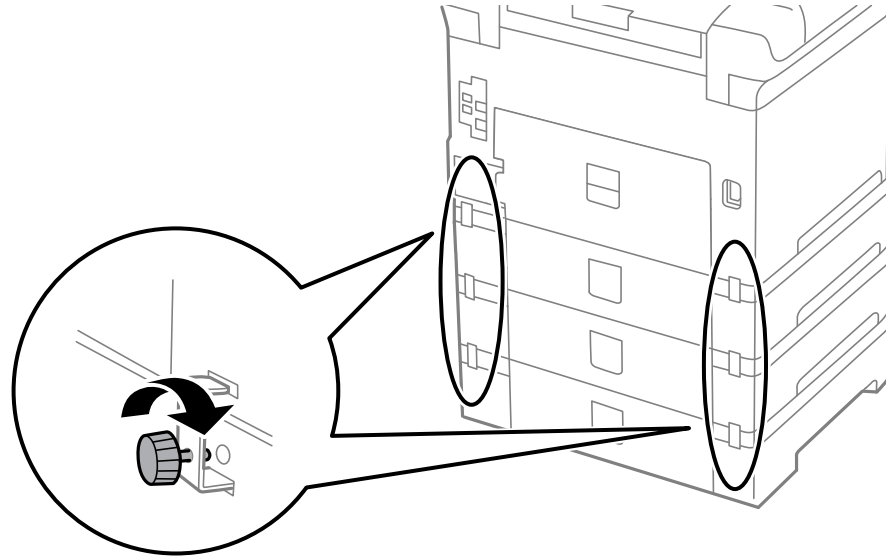

- Insert a label into the holder indicating the paper size to be loaded in each of the paper cassettes.

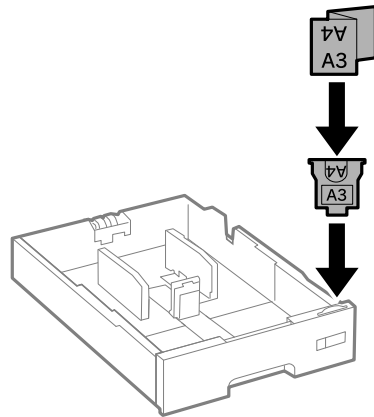

12. Insert the paper cassette and place the correct sticker on the cassette unit to indicate the cassette number.

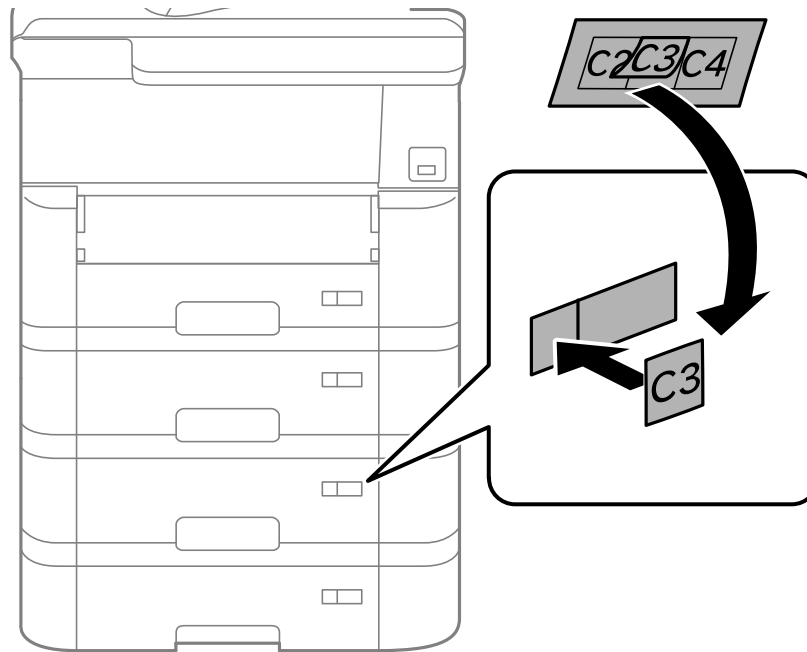

13. Attach the output tray.
14. Connect the power cord and other connection cables, then plug in the product.
15. Turn on the product.
16. Pull out and reinsert the paper cassettes in the optional paper cassette units and confirm that each cassette unit number is displayed on the screen.
17. Enable the optional paper cassette units in the printer software.

[Enabling the Optional Paper Cassettes - Windows](#)

[Enabling the Optional Paper Cassettes - PostScript Printer Software - Windows](#)

[Enabling the Optional Paper Cassettes - Mac](#)

[Enabling the Optional Paper Cassette - PostScript Printer Software - Mac](#)

Parent topic: [Installing or Using Optional Parts](#)

Related tasks

[Synchronizing Printer Settings - Epson Universal Print Driver - Windows](#)

[Enabling the Optional Paper Cassettes - PostScript Printer Software - Windows](#)





[Enabling the Optional Paper Cassette - PostScript Printer Software - Mac](#)

Enabling the Optional Paper Cassettes - Windows

You need to enable the optional paper cassette units before you can use them with the printer software.

Note: Log on to your computer as an administrator.

1. Do one of the following:

- **Windows 11:** Click , search for **Settings** and select it. Select **Bluetooth & devices > Printers & scanners**. Select your product name, then select **Printer properties**.
- **Windows 10:** Click  and select  (Settings) > **Devices > Printers & scanners**. Select your product name and select **Manage > Printer properties**.
- **Windows 8.x:** Navigate to the **Apps** screen and select **Control Panel > Hardware and Sound > Devices and Printers**. Right-click your product name and select **Printer properties**.
- **Windows 7:** Click  and select **Devices and Printers**. Right-click your printer name and select **Printer properties**.
- **Windows Vista:** Click  and select **Control Panel**. Click **Printer** under **Hardware and Sound**, then right-click your printer name and select **Properties**.

2. Click the **Optional Settings** tab.

You see a window like this:

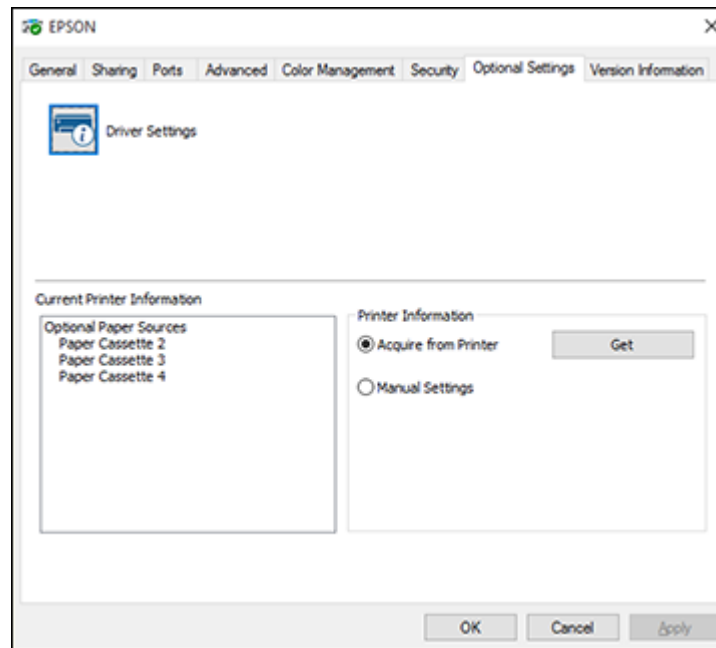

3. Make sure **Acquire from Printer** is selected and click **Get**.

The optional paper sources are listed in the Current Printer Information section.

4. Click **OK**.

The optional paper cassettes are now enabled.

Parent topic: [Installing the Optional Paper Cassette Units](#)

Related tasks





[Synchronizing Printer Settings - Epson Universal Print Driver - Windows](#)

[Enabling the Optional Paper Cassettes - PostScript Printer Software - Windows](#)

Enabling the Optional Paper Cassettes - PostScript Printer Software - Windows

If you installed optional paper cassette units, you need to enable the optional cassette units before you can use them with the PS3 printer software.

Note: Log on to your computer as an administrator.

1. Do one of the following:
 - **Windows 11:** Click , search for **Settings** and select it. Select **Bluetooth & devices > Printers & scanners**. Select your product name, then select **Printer properties**.
 - **Windows 10:** Click  and select  (Settings) > **Devices > Printers & scanners** . Select your product name and select **Manage > Printer properties**.
 - **Windows 8.x:** Navigate to the **Apps** screen and select **Control Panel > Hardware and Sound > Devices and Printers**. Right-click your product name and select **Printer properties**.
 - **Windows 7:** Click  and select **Devices and Printers**. Right-click your product name and select **Printer Properties**.
 - **Windows Vista:** Click  and select **Control Panel**. Click **Printer** under **Hardware and Sound**, then right-click your product name, and select **Properties**.
2. Click the **Device Settings** tab.

You see a window like this:

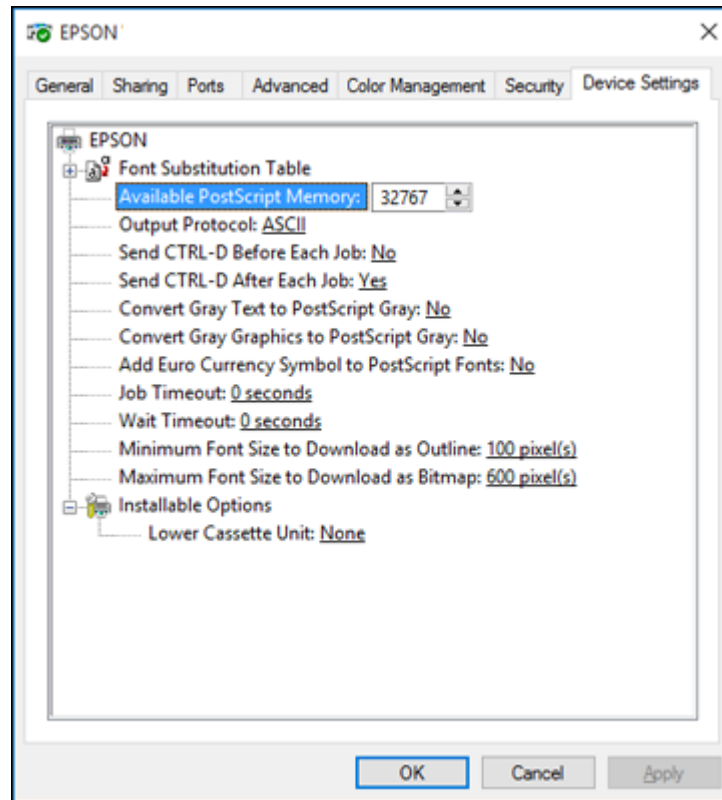

3. Select the number of optional cassettes installed as the Lower Cassette Unit setting.
4. Click **OK**.

The optional paper cassettes are now enabled.

Parent topic: [Installing the Optional Paper Cassette Units](#)

Enabling the Optional Paper Cassettes - Mac

You need to enable the optional paper cassette units before you can use them with the printer software.

Note: If you are using the PostScript (PS3) printer software, see the link below to enable the optional cassette units.

1. In the Apple menu or the Dock, select **System Preferences** or **System Settings**.
2. Select **Print & Fax**, **Print & Scan**, or **Printers & Scanners**, select your product, and select **Options & Supplies**.
3. Select **Driver** or **Options**.

You see a screen like this:

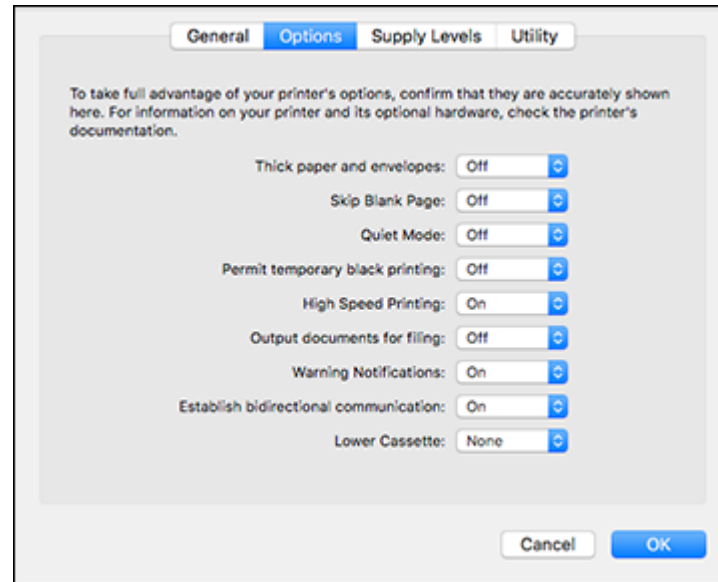

4. Select the number of cassette units installed as the **Lower Cassette** setting.
5. Click **OK**.

The optional paper cassettes are now enabled.

Parent topic: [Installing the Optional Paper Cassette Units](#)

Related tasks

[Enabling the Optional Paper Cassette - PostScript Printer Software - Mac](#)

Enabling the Optional Paper Cassette - PostScript Printer Software - Mac

If you installed the optional paper cassette unit, you need to enable it before you can use it with the PS3 printer software.

1. In the Apple menu or the Dock, select **System Preferences**.

2. Select **Print & Fax**, **Print & Scan**, or **Printers & Scanners**, select your product, and select **Options & Supplies**.
3. Select **Driver** or **Options**.

You see a screen like this:

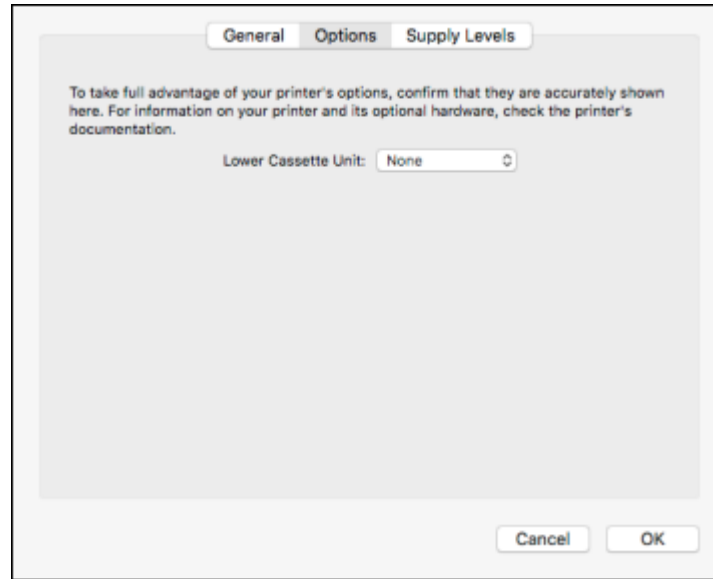

4. Select the optional cassette installed as the Lower Cassette Unit setting.
5. Click **OK**.

The optional paper cassette is now enabled.

Parent topic: [Installing the Optional Paper Cassette Units](#)

Product Parts Locations

See these sections to identify the parts on your product.

[Product Parts - Front](#)

[Product Parts - Inside](#)

[Product Parts - Back](#)

Parent topic: [Product Basics](#)

Product Parts - Front

Certain parts are labeled with a letter and number code. If you encounter any paper jams or errors, you can use these codes to locate and correct the problem.

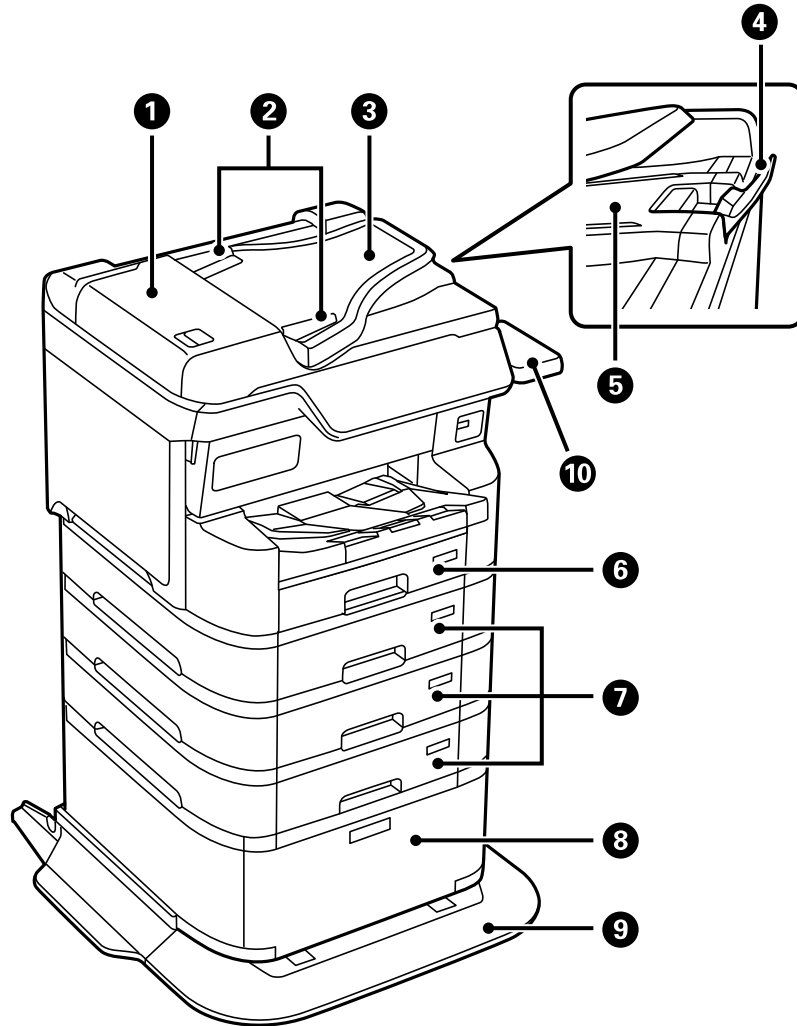

1 Automatic Document Feeder (ADF) cover (F)

- 2 ADF edge guides
- 3 ADF input tray (F)
- 4 ADF stopper
- 5 ADF output tray
- 6 Paper cassette 1 (C1)
- 7 Optional cassettes 2, 3, and 4 (C2, C3, and C4)
- 8 Optional cabinet
- 9 Optional cabinet front cover

10 Authentication Device Table-P2 (Optional)

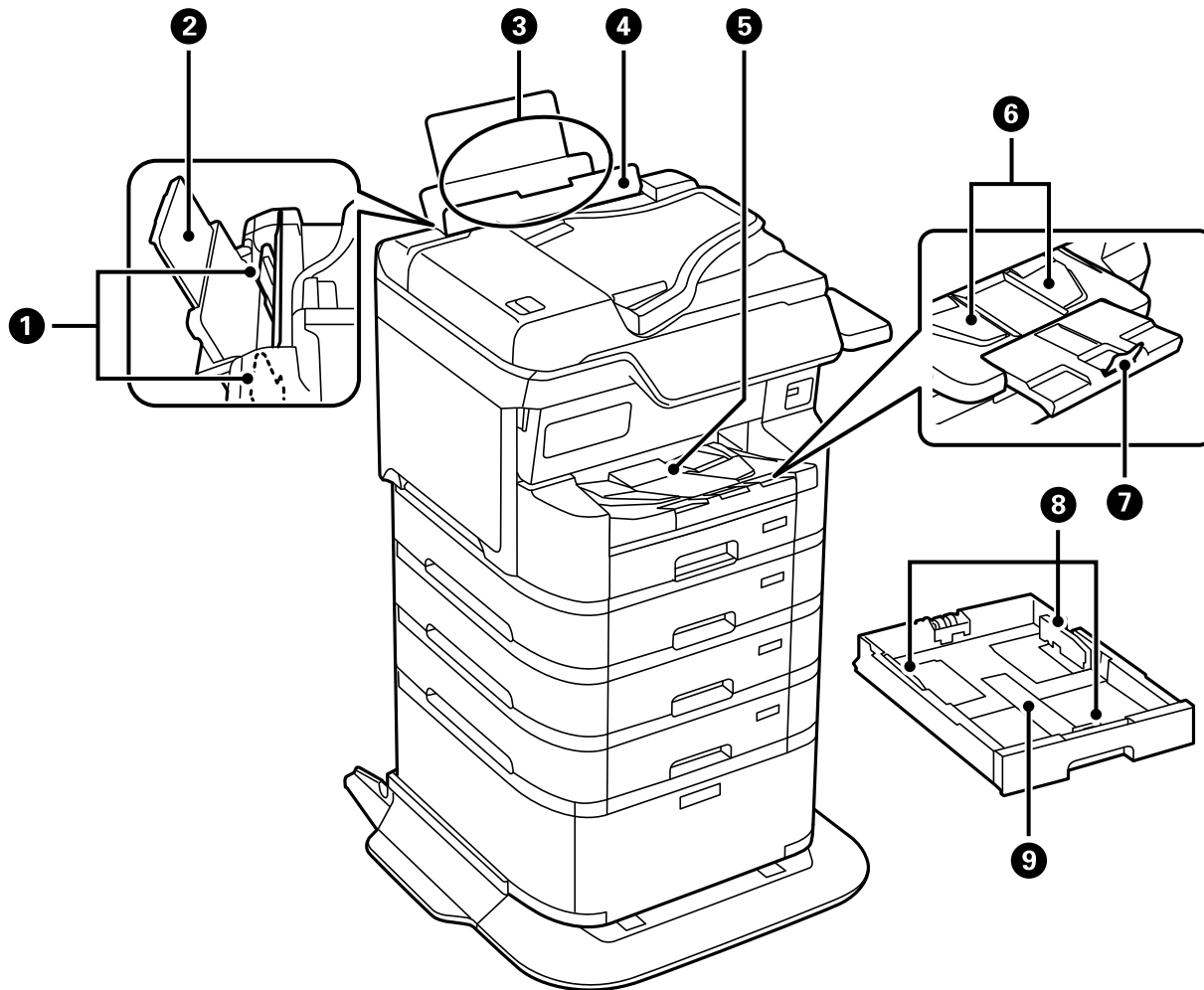

- 1 Rear paper feed edge guides
- 2 Paper support and extension
- 3 Rear paper feed slot (B)

- 4 Feeder guard
- 5 Output tray
- 6 Output tray guide
- 7 Output tray stopper
- 8 Paper cassette edge guides
- 9 Paper cassette

Parent topic: [Product Parts Locations](#)

Product Parts - Inside

Certain parts are labeled with a letter and number code. If you encounter any paper jams or errors, use these codes to locate and correct the problem.

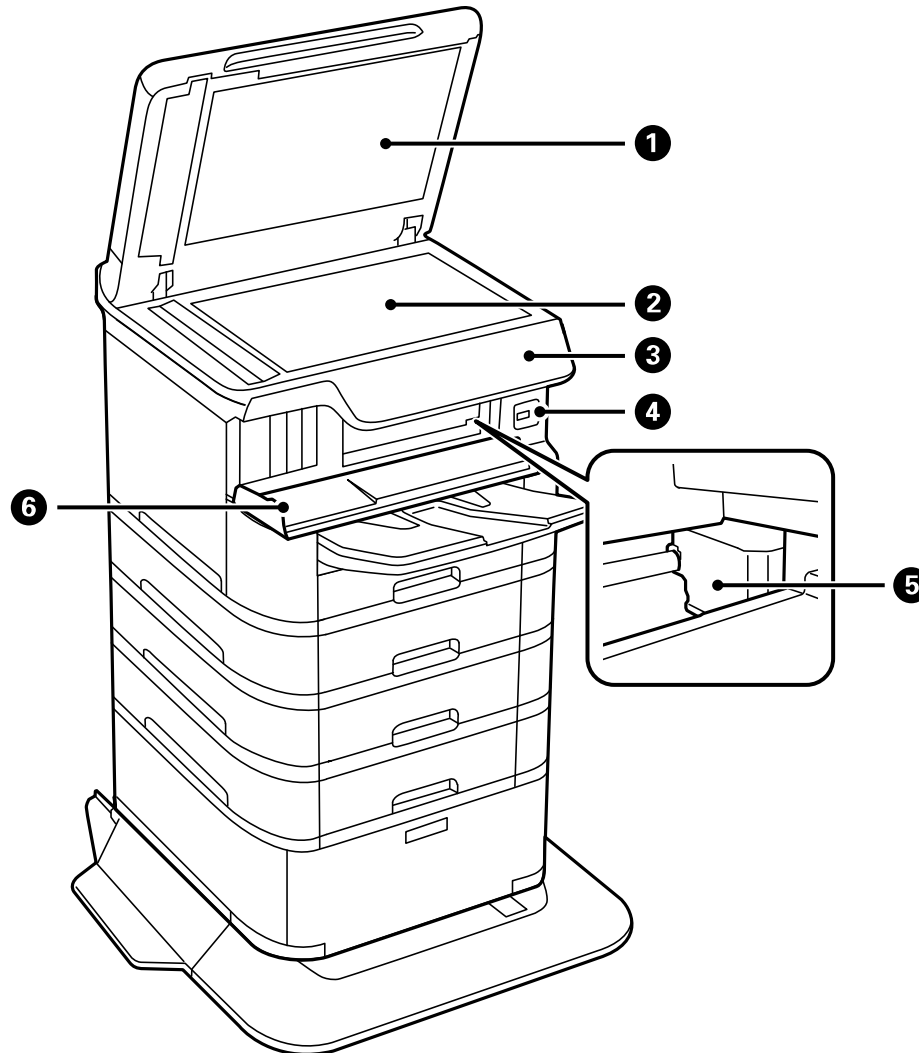

1 Document cover

- 2 Scanner glass
- 3 Control panel
- 4 USB Type A port for external devices
- 5 Print head
- 6 Front cover (A)

Parent topic: [Product Parts Locations](#)

Product Parts - Back

Certain parts are labeled with a letter and number code. If you encounter any paper jams or errors, use these codes to locate and correct the problem.

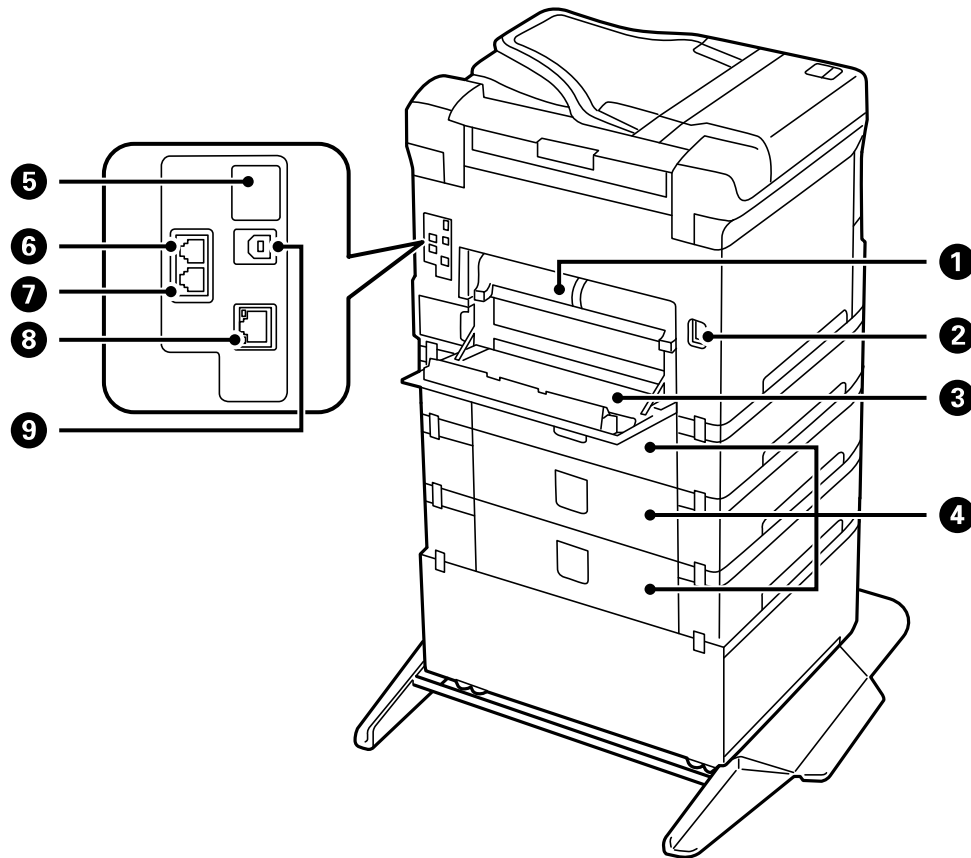

- 1 Rear cover 2 (D2)
- 2 AC inlet
- 3 Rear cover 1 (D1)
- 4 Optional cassette rear covers (E)
- 5 Service USB port for future use (do not remove sticker)

- 6 **LINE** port
- 7 **EXT.** port
- 8 **LAN** port
- 9 **USB** port

Parent topic: [Product Parts Locations](#)

Using the Control Panel

See these sections to learn about the control panel and select control panel settings.

[Control Panel Buttons and Lights](#)

[Changing LCD Screen Language](#)

[Selecting the Date and Time](#)

[Selecting Your Country or Region](#)

[Setting a Password and Locking the Control Panel](#)

[Setting User Feature Restrictions \(Access Control\)](#)

[Adjusting Control Panel Sounds](#)

[Adjusting the Screen Brightness](#)









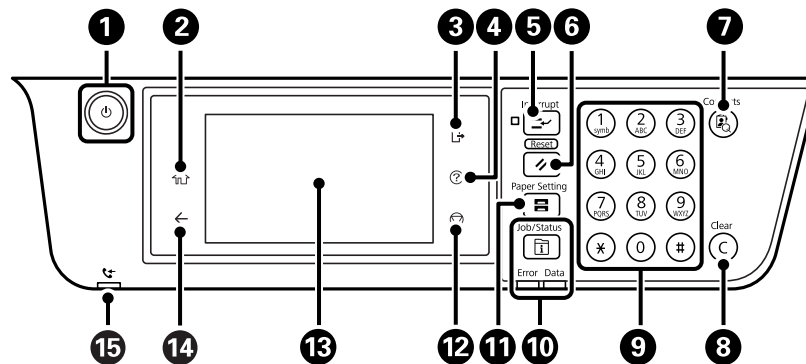



[Turning Off the Operation Time Out Setting](#)

[Preventing PC Connection via USB](#)

Parent topic: [Product Basics](#)

Control Panel Buttons and Lights



- 1 The  power button and light
- 2 The  home button
- 3 The  log out button
- 4 The  help button
- 5 The  **Interrupt** button
- 6 The  **Reset** button
- 7 The  **Contacts** button
- 8 The **C Clear** button
- 9 The numeric keypad
- 10 The  **Job/Status** button, the **Error** light, and the **Data** light
- 11 The  **Paper Setting** button
- 12 The  stop button
- 13 The LCD screen
- 14 The  return button
- 15 The  received fax light

[Guide to the Home Screen](#)

[Status Icon Information](#)

Parent topic: [Using the Control Panel](#)

Guide to the Home Screen

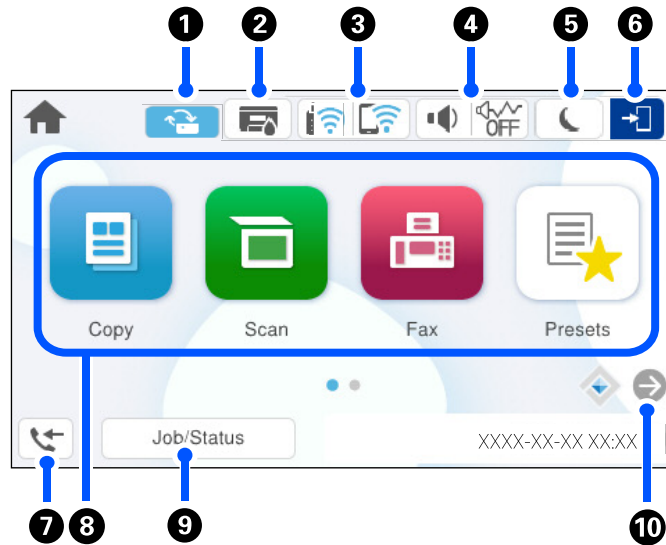



















- 1 Indicates when a firmware update is available
- 2 Displays ink and maintenance box status
- 3 Indicates network status and accesses network settings
- 4 Indicates whether Quiet Mode is enabled
- 5 If the icon is not grayed out, enters into sleep mode when selected.
- 6 Indicates that the user restriction feature is enabled.
- 7 Displays the Fax Data Information screen.
- 8 Displays the menu options
- 9 Displays ongoing jobs that are on stand by.
- 10 Scrolls the screen to the right

Parent topic: [Control Panel Buttons and Lights](#)

Status Icon Information

Your product displays status icons on the LCD screen for certain product status conditions.

Icons	Description
	Indicates a firmware update is available
	Ink and maintenance box status; select the icon to view the ink and maintenance box levels
	<p>Displays the network connection status</p> <ul style="list-style-type: none"> •  Not connected to a wired (Ethernet) network •  Connected to a wired (Ethernet) network •  Searching for an SSID or experiencing a wireless network connection issue •  Connected to a wireless network; the number of bars indicates the connection's signal strength •  Wi-Fi Direct is not enabled •  Wi-Fi Direct is enabled
	<p>Displays the Device Sound Settings screen; select the icon to change the setting.</p> <ul style="list-style-type: none"> •  Quiet Mode is enabled; noise is reduced during printing but print speed is slower •  Quiet Mode is disabled •  Mute is enabled
	If the icon is not grayed out, enters into sleep mode when selected.
	<p>Indicates that the user restriction feature is enabled. Select this icon to log in to the printer. You need to select a user name and then enter a password. Contact your printer administrator for login information.</p> <p>When  is displayed, a user with access permission has logged in. Select the icon to logout.</p>

Icons	Description
	Displays the Fax Data Information screen.
	Scrolls the screen to the right.

Parent topic: [Control Panel Buttons and Lights](#)

Changing LCD Screen Language

You can change the language used on the LCD screen.

Note: This setting can be locked by an administrator. If you cannot access or change this setting, contact your administrator for assistance.

1. Press the  home button, if necessary.
2. Select **Settings > General Settings > Basic Settings > Language**.
3. Scroll up or down, if necessary, and select a language.

Parent topic: [Using the Control Panel](#)

Selecting the Date and Time

Before using your product, select the current date, time, and daylight saving phase in your area, and choose your preferred date and time format.

Note: This setting can be locked by an administrator. If you cannot access or change this setting, contact your administrator for assistance.

1. Press the  home button, if necessary.
2. Select **Settings > General Settings > Basic Settings > Date/Time Settings**.
3. Select **Daylight Saving Time**, then select the setting that applies to your area:
 - **Winter:** it is winter or your region does not use Daylight Saving Time (DST)
 - **Summer:** it is spring or summer and your region uses Daylight Saving Time (DST)

Note: If your region uses Daylight Saving Time (DST), you must change this setting to match the season. When you change from **Winter** to **Summer**, your product automatically sets its clock ahead one hour. When you change from **Summer** to **Winter**, it sets its clock back one hour.

4. On the Date/Time Settings screen, select **Date/Time**.
5. Select the date format you want to use.
6. Use the numeric keypad to enter the current date.
7. Select the time format you want to use.
8. Use the numeric keypad to enter the current time.
9. On the Date/Time Settings screen, select **Time Difference**.
10. Use the numeric keypad to enter the time difference between your time zone and UTC (Coordinated Universal Time).

Parent topic: [Using the Control Panel](#)

Selecting Your Country or Region

Before using your product, select the country or region in which you are using your product.

Note: If you change the country or region, your fax settings return to their defaults and you must select them again. This setting can be locked by an administrator. If you cannot access or change this setting, contact your administrator for assistance.

1. Press the  home button, if necessary.
2. Select **Settings > General Settings > System Administration > Customer Research > Country/Region**.
3. Scroll up or down, if necessary, and select your country or region.
You see a confirmation screen.
4. If the setting is correct, select **Yes**. (If not, select **No** and retry.)

Parent topic: [Using the Control Panel](#)

Setting a Password and Locking the Control Panel

You can set an administrator password to lock the following settings and prevent them from being changed:

- Network settings

- Web Service settings
 - Fax settings
 - Scan settings
 - System Administration settings
 - Language
 - User settings
 - Web Config settings
1. Press the  home button, if necessary.
 2. Select **Settings** > **General Settings** > **System Administration** > **Security Settings** > **Admin Settings** > **Admin Password** > **Register**.
 3. Use the displayed keyboard to enter a password, then select **OK**.
 4. Enter your password again to confirm, then select **OK**.

Note: Keep a copy of your password in a safe place.

5. Select **Lock Setting** and select **On**.

When the control panel is locked, you must enter the password to access any of the locked settings.

Note: If you forget your password, contact Epson for assistance.

[Entering Characters on the LCD Screen](#)

[Using Presets](#)

Parent topic: [Using the Control Panel](#)

Related tasks

[Setting User Feature Restrictions \(Access Control\)](#)

Entering Characters on the LCD Screen

Follow these guidelines to enter characters for passwords and other settings.

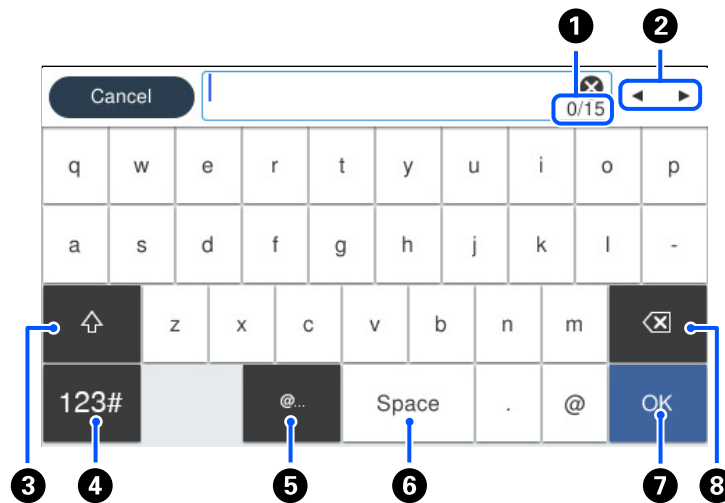

- 1 Displays the character count
- 2 Moves the cursor left or right
- 3 Switches between uppercase and lowercase characters, numbers, and symbols
- 4 Switches between characters, numbers, and symbols
- 5 Displays a list of common domain names to choose from
- 6 Enters a space
- 7 Select when you are finished
- 8 Deletes the previous character

Parent topic: [Setting a Password and Locking the Control Panel](#)

Using Presets

You can save frequently used copy, fax, and scan settings as presets. This lets you easily reuse them whenever necessary.

Note: Presets can be locked by an administrator. If you cannot access or change presets, contact your administrator for assistance.

1. Press the  home button, if necessary.
2. Select **Presets**.
3. Select **Add New**. Enter the Administrator password, if necessary.

Note: You can save up to 50 presets.

4. Select the function for which you want to set up a preset.
5. Select the settings you want to save and select **Register**.
6. Select **Name**.
7. Use the displayed keyboard to enter a name for the preset and select **OK**.
8. Select **OK** to return to the **Presets** screen.

When you copy, fax, or scan, you can use the preset by selecting **Presets** and selecting your preset name from the list.

Parent topic: [Setting a Password and Locking the Control Panel](#)

Related tasks

[Entering Characters on the LCD Screen](#)

Setting User Feature Restrictions (Access Control)

Using Web Config Access Control Settings, you can restrict product features for individual users to prevent misuse of the product. Restricted features require the user to enter an ID and password on the product control panel.

After you setup feature restrictions, you must enable them using the product control panel.

1. Press the  home button, if necessary.
2. Select **Settings > General Settings > System Administration > Security Settings > Access Control**.
3. Select **On**.
4. Enable **Accept Unknown User Jobs** to allow jobs that do not have the necessary authentication information.

Parent topic: [Using the Control Panel](#)

Related tasks

[Setting a Password and Locking the Control Panel](#)

[Entering a User ID and Password for Printing](#)



[Entering a User ID and Password for Scanning](#)

Adjusting Control Panel Sounds

You can adjust the sound level heard when you press buttons on the control panel.

1. Press the  home button, if necessary.
2. Select **Settings** > **General Settings** > **Basic Settings** > **Sound**.
3. Do one of the following:
 - Select **Mute** to turn off all control panel sounds, then go to step 6.
 - Select **Normal Mode** or **Quiet Mode** to adjust control panel sounds.

Note: Press the  icon on the home screen to adjust sounds.

4. Select **Button Press**.
5. Select  to decrease or  to increase the sound select **OK**.
6. Select the back arrow to exit.

Note: You can also adjust the **Sound Type** and the sound level for various product functions.

Parent topic: [Using the Control Panel](#)

Adjusting the Screen Brightness

You can adjust the brightness of the LCD screen.

1. Press the  home button, if necessary.
2. Select **Settings** > **General Settings** > **Basic Settings** > **LCD Brightness**.
3. Press the – or + icons to decrease or increase the brightness.
4. Select **OK** to exit.

Parent topic: [Using the Control Panel](#)

Turning Off the Operation Time Out Setting

The Operation Time Out setting causes the LCD screen to return to the Home screen after a few minutes of inactivity. This feature is enabled by default, but you can turn it off.

Note: This setting can be locked by an administrator. If you cannot access or change this setting, contact your administrator for assistance.

1. Press the  home button, if necessary.
2. Select **Settings** > **General Settings** > **Basic Settings** > **Operation Time Out**.
3. Select **Off**.

Parent topic: [Using the Control Panel](#)

Preventing PC Connection via USB

You can disable access from a USB-connected computer. This restricts non-network access to the product and protects the security of confidential scanned documents.

Note: This setting can be locked by an administrator. If you cannot access or change this setting, contact your administrator for assistance.

1. Press the  home button, if necessary.
2. Select **Settings** > **General Settings** > **Printer Settings** > **PC Connection via USB**.
3. Select **Disable**, then select **OK**.

Parent topic: [Using the Control Panel](#)

Using Power Saving Settings

Your product enters sleep mode automatically and turns off the LCD screen if it is not used for a period of time. You can make the time period shorter and select other options to save energy and resources.

[Changing the Sleep Timer Settings](#)

[Changing the Power Off Timer Settings](#)

Parent topic: [Product Basics](#)

Changing the Sleep Timer Settings

You can adjust the time period before your product enters sleep mode and turns off the LCD screen.

Note: This setting can be locked by an administrator. If you cannot access or change this setting, contact your administrator for assistance.

1. Press the  home button, if necessary.
2. Select **Settings > General Settings > Basic Settings > Sleep Timer**.

Note: Enter the administrator password, if necessary.

3. Do one of the following:
 - Select the **–** or **+** icon to decrease or increase the number of minutes.
 - Select the number of minutes on the LCD screen, select the number of minutes from the on-screen or control panel keypad, and select **OK**.
4. Select **OK**.
5. Select **Wake from Sleep**.
6. Select **Touch LCD Screen to Wake**.
7. Do one of the following:
 - Select **On** to wake the printer from sleep mode by tapping the LCD touchscreen or by pressing a button on the control panel.
 - Select **Off** to wake the printer from sleep mode by only pressing a button on the control panel. This prevents unintentional operations due to objects bumping the LCD touchscreen.
 - Select **Scheduled** to set a time range for the feature to be enabled.

Parent topic: [Using Power Saving Settings](#)

Changing the Power Off Timer Settings

You can have the product turn off automatically if it is not used for a specified period of time.

Note: This setting can be locked by an administrator. If you cannot access or change this setting, contact your administrator for assistance.

1. Press the  home button, if necessary.
2. Select **Settings > General Settings > Basic Settings**.
3. Do one of the following depending on the setting you see displayed on the LCD screen:
 - Select **Power Off Timer**, then select a time period between **30minutes** and **12h** (12 hours).

- Select **Power Off Settings**, then select **Power Off If Inactive** to turn the printer off if it is not used after a specified period of time or **Power Off If Disconnected** to turn the printer off if all ports including the LINE port are disconnected after a specified period of time.

Parent topic: [Using Power Saving Settings](#)

Epson Connect Solutions for Smartphones, Tablets, and More

Use your smartphone, tablet, or computer to print and scan documents, photos, emails, and web pages from your home, office, or even across the globe.

Note: If you are using your Epson product with the Windows 10 S operating system, you cannot use the software described in this section. You also cannot download and install any Epson product software from the Epson website for use with Windows 10 S; you must obtain software only from the Windows Store.

Print from anywhere with these Epson Connect solutions:

- Epson Email Print
- Epson Remote Print

Scan and send a file as an email or upload it to an online service directly from your Epson product with Epson Scan to Cloud.

[Setting Up Epson Connect Services](#)

[Using Epson Email Print](#)

[Using Epson Remote Print](#)

[Using Epson Scan to Cloud](#)

Parent topic: [Product Basics](#)

Setting Up Epson Connect Services

If you did not activate your product's email address for use with Epson Connect when you set up your product, you can activate it using the product control panel.

1. Press the  home button, if necessary.
2. Select **Settings > General Settings > Web Service Settings > Epson Connect Services**
3. Select **Register**.
4. Follow the instructions on the screen to activate your product's email address.

Parent topic: [Epson Connect Solutions for Smartphones, Tablets, and More](#)

Using Epson Email Print

With Epson Email Print, you can print from any device that can send email, such as your smartphone, tablet, or laptop. Just activate your product's unique email address. When you want to print, attach a PDF, Microsoft Office document, or photo to an email and send it to your product. Both the email and the attachments will print automatically.

1. Connect your product to your network. See the link below.
2. If you did not already set up Email Print when you installed your product software, see the link below to use your product control panel to activate your unique email address. Or visit epson.com/connect (U.S.) or epson.ca/connect (Canada) to learn more about Email Print, create your Epson Connect account, and register your product to the Epson Connect service.
3. Now you are ready to send and print emails to your product's Email Print address.

Note: Go to epsonconnect.com and log into your Epson Connect account to personalize your product's email, adjust print settings, and set up other Epson Connect services.

Parent topic: [Epson Connect Solutions for Smartphones, Tablets, and More](#)

Related tasks

[Setting Up Epson Connect Services](#)

Related topics

[Wi-Fi or Wired Networking](#)

Using Epson Remote Print

With Epson Remote Print software, you can print from your laptop or desktop computer to an Epson Email-enabled product anywhere in the world.

1. Connect your Epson product to your wireless network. See the link below.
2. If you did not already set up an Epson Connect account when you installed your product software, visit epsonconnect.com to create your account and register your product to the Epson Connect service.

Note: Make a note of your product's email address.

3. Visit epsonconnect.com to learn more about Remote Print and how to download the Remote Print Driver software.
4. Download and install the Remote Print software.

5. Enter the email address and optional access key of your Epson product during Remote Print setup.
6. Now you are ready to print remotely. Select the print command in your laptop or desktop computer application and choose the Remote Print option for your Epson product.

Parent topic: [Epson Connect Solutions for Smartphones, Tablets, and More](#)

Related topics

[Wi-Fi or Wired Networking](#)

Using Epson Scan to Cloud

The Epson Scan to Cloud service allows you to scan and send a file as an email or upload it to an online service directly from your Epson product. Register an email address or online services such as Box, DropBox, Evernote, or Google Drive with your Epson Connect account.

1. Connect your Epson product to your network. See the link below.
2. If you did not already set up an Epson Connect account when you installed your product software, visit epsonconnect.com to create your account and register your product to the Epson Connect service.

Note: Make a note of your product's email address and password.

3. Visit epsonconnect.com to sign into your account with the email address and password you selected.
4. Select your product, select **Scan to Cloud**, and select **Destination List**.
5. Click **Add**, then follow the instructions on the screen to create your destination list.
6. Now you are ready to use Scan to Cloud. Select the setting for scanning to Scan to Cloud on your Epson product control panel.

Parent topic: [Epson Connect Solutions for Smartphones, Tablets, and More](#)

Related topics

[Wi-Fi or Wired Networking](#)

Using AirPrint

AirPrint enables instant wireless printing from iPhone, iPad, iPod touch, and Mac without the need to install drivers or download software.



Note: If you disabled paper configuration messages on your product control panel, you cannot use AirPrint. See the link below to enable the messages, if necessary.

1. Load paper in your product.
2. Set up your product for wireless printing. See the link below.
3. Connect your Apple device to the same wireless network that your product is using.
4. Print from your device to your product.

Note: For details, see the AirPrint page on the Apple website.

Parent topic: [Product Basics](#)

Related topics

[Wi-Fi or Wired Networking](#)

[Selecting Default Paper Settings - Administrator](#)

Using the Mopria Print Service

Mopria Print Service enables printing to Mopria certified printers and multifunction printers from many manufacturers. Mobile printing from your Android phone or tablet may be accomplished using the Mopria Print Service app in the Google Play Store.



Note: For details and support on the Mopria Print Service, visit <https://mopria.org>.

Parent topic: [Product Basics](#)

Related topics

[Wi-Fi or Wired Networking](#)

Using Mopria Scan

Mopria Scan enables scanning from Mopria certified multifunction printers and scanners from many manufacturers. Mobile scanning from your Android phone or tablet may be accomplished using the Mopria Scan app in the Google Play Store.



Note: For details and support on Mopria Scan, visit <https://mopria.org>.

Parent topic: [Product Basics](#)

Setting Up Printing on a Chromebook

Your Epson printer supports native printing on Chromebook, allowing you to print from a Chromebook without drivers or cables.

For directions on setting up your printer, visit [Setting Up Your Epson Printer on Your Chromebook \(U.S.\)](#) or [Setting Up Your Epson Printer on Your Chromebook \(Canada\)](#).

Parent topic: [Product Basics](#)

Android Printing Using the Epson Print Enabler

You can wirelessly print your documents, emails, photos, and web pages right from your Android phone or tablet. With a few taps, your Android device will discover your nearby Epson product and print.

Note: Operations may differ depending on the device.

1. Connect your Epson product to your wireless network. See the link below.
2. On your Android device, download the Epson Print Enabler plug-in from Google Play.
3. Go to **Settings** on your Android device, select **Printing**, and enable the Epson plug-in, if necessary.
4. Connect your Android device to the same wireless network as your product.
5. Now you are ready to print. From an Android application such as Chrome or Gmail, tap the menu icon and print whatever is on the screen.

Note: If you do not see your product, tap **All Printers** and select your product.

Parent topic: [Product Basics](#)

Related topics

[Wi-Fi or Wired Networking](#)

Voice-activated Printing

Take advantage of voice-activated, hands-free printing from your Epson product with Alexa. You can ask your product to print photos, calendars, recipes, photo props, and more. [Click here](#) for more information.

1. Connect your product to your network. See the link below.

2. Set up your product's email address for use with Epson Connect. See the link below to activate it from the product control panel.
3. [Click here](#) for instructions on how to set up your product and voice assistant to use the voice-activated printing feature.

Now you are ready to print with your voice and your Epson product.

Parent topic: [Product Basics](#)

Wi-Fi or Wired Networking

See these sections to use your product on a Wi-Fi or wired network.

[Network Security Recommendations](#)

[Wi-Fi Infrastructure Mode Setup](#)

[Wi-Fi Direct Mode Setup](#)

[Wi-Fi Protected Setup \(WPS\)](#)

[Printing a Network Status Sheet](#)

[Configuring Email Server Settings](#)

[Changing or Updating Network Connections](#)

Network Security Recommendations

To help deter unauthorized access to your product over a network, you should protect your network environment using appropriate security measures.

Security measures such as these can help deter threats such as loss of user data, use of telephone and fax lines, and other intrusions:

- **Enable security on your wireless LAN**

Enable the appropriate security on the wireless LAN you plan to use with your product. Network security such as a network password can deter interception of traffic over the wireless LAN. Your router may already have a default password enabled by your Internet service provider (ISP). See your ISP and router documentation for instructions on how to change the default password and better secure your network.

- **Connect your product only to a network protected by a firewall**

Connecting your product directly to the Internet may leave it vulnerable to security threats. Instead, connect it to a router or other network connection protected by a firewall. Your router may already have a firewall set up by your Internet service provider; check with your ISP for confirmation. For best results, set up and use a private IP address for your network connection.

- **Change the default administrator password on your product**

If your product has the option to set an administrator password, change the default administrator password to deter access by unauthorized users to personal data stored on your product, such as IDs, passwords, and contact lists.

Parent topic: [Wi-Fi or Wired Networking](#)

Wi-Fi Infrastructure Mode Setup

You can set up your product to communicate with your computer using a wireless router or access point. The wireless router or access point can be connected to your computer over a wireless or wired network.

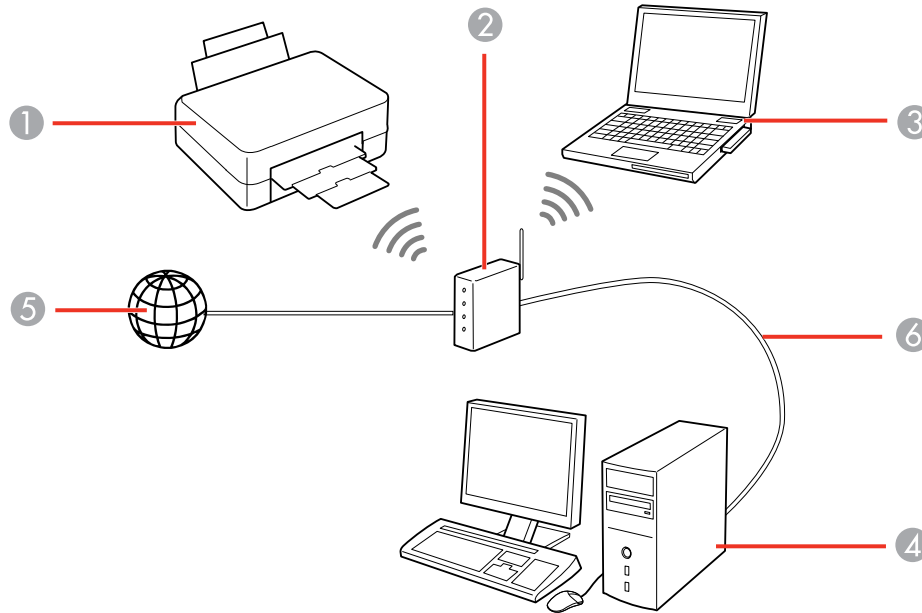

- 1 Epson product
- 2 Wireless router or access point
- 3 Computer with a wireless interface
- 4 Computer
- 5 Internet
- 6 Ethernet cable (used only for wired connection to the wireless router or access point)

[Selecting Wireless Network Settings from the Control Panel](#)



Parent topic: [Wi-Fi or Wired Networking](#)

Selecting Wireless Network Settings from the Control Panel



You can select or change wireless network settings using your product control panel.

To install your product on a wireless network, install the necessary software by downloading it from the Epson website. The installer program guides you through network setup.

Note: Breakdown or repair of this product may cause loss of fax and network data and settings. Epson is not responsible for backing up or recovering data and settings during or after the warranty period. We recommend that you make your own backup or print out your fax and network data and settings.

1. Press the  home button, if necessary.
2. Press the  icon.
3. Select **Router**.
4. Select **Start Setup**, **Change Settings**, or **Change to Wi-Fi Connection**, depending on your current connection settings.
5. Select **Wi-Fi Setup Wizard**.
6. Select the name of your wireless network or select **Enter Manually** to enter the name manually. Use the displayed keypad to enter your network name.
7. Select the **Password** field and enter your wireless password using the displayed keypad.

Note: The network name and password are case sensitive. Be sure to correctly enter uppercase and lowercase letters, and numeric or special characters.

- To move the cursor, press the left or right arrows.
 - To change the case of letters, press .
 - To delete the previous character, press .
 - To enter numbers and symbols, press .
 - To enter a space, press **Space**.
8. Press **OK** when you finish entering your password.
 9. Confirm the displayed network settings and select **Start Setup** to save them.

10. If you want to print a network setup report, select **Print Check Report**. (Otherwise, select **OK**.)
11. Press the  home button to exit.

You see the  icon on the LCD screen and should be able to connect to your product directly from your computer or device, and then print. If you are printing from a computer, make sure you installed the network software from the Epson website.

Note: If you don't see the  icon, you may have selected the wrong network name or entered the password incorrectly. Repeat these steps to try again.

Parent topic: [Wi-Fi Infrastructure Mode Setup](#)

Related references

[Status Icon Information](#)

Related tasks

[Entering Characters on the LCD Screen](#)

Wi-Fi Direct Mode Setup

You can set up your product to communicate directly with your computer or another device without requiring a wireless router or access point. In Wi-Fi Direct Mode, the product itself acts as a network access point for up to 8 devices.

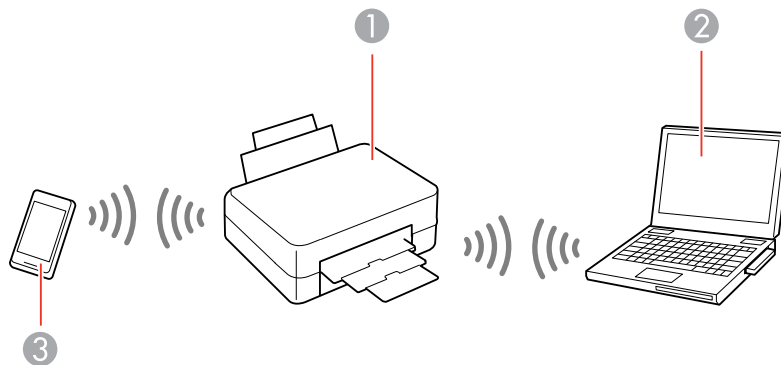

1 Epson product

- 2 Computer with a wireless interface
- 3 Other wireless device

Note: The product normally uses W52 (36ch) as the channel when connecting to Wi-Fi Direct (Simple AP). Since the channel for wireless LAN (Wi-Fi) connection is selected automatically, the channel used may differ when used at the same time as a Wi-Fi Direct connection. Sending data to the printer may be delayed if the channels are different. If it does not interfere with use, connect to the SSID in the 2.4 GHz band. In the 2.4 GHz frequency band, the channels used will match.



When setting the wireless LAN to 5 GHz, we recommend disabling Wi-Fi Direct.

[Enabling Wi-Fi Direct Mode](#)

Parent topic: [Wi-Fi or Wired Networking](#)

Enabling Wi-Fi Direct Mode

You can enable Wi-Fi Direct mode to allow direct communication between your product and computer or other devices without a wireless router or access point.

1. Press the  home button, if necessary.
2. Press the  icon.
3. Select **Wi-Fi Direct**.
4. Scroll down and select **Start Setup**.
5. Select **Start Setup** again.
6. Use your computer or wireless device to select the Wi-Fi network name (SSID) displayed on the LCD screen, then enter the password shown.
7. Press the  home button to exit.

You see the  icon on the LCD screen and should be able to connect to your product directly from your computer or device, and then print. If you are printing from a computer, make sure you installed the network software from the Epson website.

Note: If you don't see the  icon on the LCD screen, you may have selected the wrong network name or entered the password incorrectly. Repeat these steps to try again.

Parent topic: [Wi-Fi Direct Mode Setup](#)

Related references

[Status Icon Information](#)

Related tasks

[Entering Characters on the LCD Screen](#)

Wi-Fi Protected Setup (WPS)

If your network uses a WPS-enabled wireless router or access point, you can quickly connect your product to the network using Wi-Fi Protected Setup (WPS).



Note: To check if your router is WPS-enabled, look for a button labeled **WPS** on your router or access point. If there is no hardware button, there may be a virtual WPS button in the device's software. Check your network product documentation for details.

[Using WPS to Connect to a Network](#)

Parent topic: [Wi-Fi or Wired Networking](#)

Using WPS to Connect to a Network

If you have a WPS-enabled wireless router or access point, you can use Wi-Fi Protected Setup (WPS) to connect your product to the network.

1. Press the  home button, if necessary.
2. Press the  icon.

You see a screen like this:

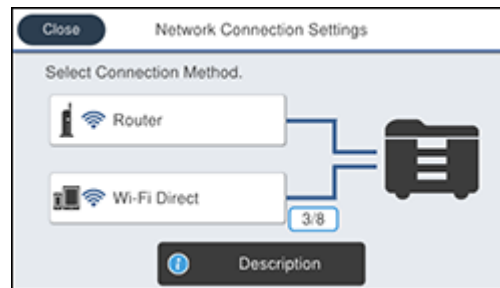

3. Select **Router**, then select **Start Setup, Change Settings**, or **Change to Wi-Fi connection**, depending on your current connection settings.
4. Select **Push Button Setup (WPS)**.
5. Follow the instructions on the LCD screen to complete WPS setup.
6. Press the  home button to exit.

You see the  icon on the LCD screen and should be able to connect to your product directly from your computer or device, and then print. If you are printing from a computer, make sure you installed the network software from the Epson website.

Note: If you don't see the  icon, repeat these steps to try again.

Parent topic: [Wi-Fi Protected Setup \(WPS\)](#)

Printing a Network Status Sheet

You can print a network status sheet to help you determine the causes of any problems you may have using your product on a network.

1. Press the  home button, if necessary.
2. Select **Settings > General Settings > Network Settings > Network Status > Print Status Sheet > Print**.

Examine the settings shown on the network status sheet to diagnose any problems you have.

Parent topic: [Wi-Fi or Wired Networking](#)

Configuring Email Server Settings

To use features such as scanning to email or forwarding faxes to email, you need to configure the email server. You can select settings for the email server using the control panel on the product.

Note: These settings can be locked by an administrator. If you cannot access these settings, contact your administrator for assistance.

1. Press the  home button, if necessary.
2. Select **Settings > General Settings > Network Settings**.
3. Scroll down and select **Advanced**.

4. Select **Email Server > Server Settings**.
5. Select one of the options shown above, then select the settings you want to use. Contact your internet service provider if necessary to confirm the authentication method for the email server.
6. Select **Proceed** to save your settings.
7. Select **Close** to exit.
8. Select **Connection Check** to verify the connection to the email server.

Parent topic: [Wi-Fi or Wired Networking](#)

Related tasks

[Scanning to Email](#)

[Forwarding Received Faxes](#)

Changing or Updating Network Connections

See these sections to change or update how your product connects to a network.

[Changing a USB Connection to a Wi-Fi Connection](#)

[Changing a Wi-Fi Connection to a Wired Network Connection](#)

[Connecting to a New Wi-Fi Router](#)

[Disabling Wi-Fi Features](#)

Parent topic: [Wi-Fi or Wired Networking](#)

Changing a USB Connection to a Wi-Fi Connection

If you have already connected your product to your computer using a USB connection, you can change to a Wi-Fi connection.

1. Disconnect the USB cable from your product.
2. Uninstall your product software.
3. Download and install your product software from the Epson website.

Parent topic: [Changing or Updating Network Connections](#)

Changing a Wi-Fi Connection to a Wired Network Connection

If you have already connected your product to your computer wirelessly, you can change to a wired network connection if necessary.

1. Disable your product's Wi-Fi features.

2. Connect one end of an Ethernet network cable to the product's **LAN** port.
3. Connect the other end to any available LAN port on your router or access point.
4. Uninstall your product software.
5. Download and install your product software from the Epson website.
6. Follow the on-screen instructions to install the software.
7. When you see the Select Your Connection screen, select **Wired network connection**.
8. If you see a Select Setup Option screen, select **Set up printer for the first time**.
9. Continue following the rest of the on-screen instructions.

Parent topic: [Changing or Updating Network Connections](#)

Related tasks

[Disabling Wi-Fi Features](#)

Connecting to a New Wi-Fi Router

If you change the wireless router you have been using on your network, you need to update your product's Wi-Fi connection to the new router.

Note: If you switch to a 5 GHz wireless router, set the router to operate in dual band (2.4 GHz and 5 GHz) mode. If your router uses a single network name (SSID) for both the 2.4 GHz and 5 GHz band, give each band its own network name (SSID) instead, such as Home Network 2.4 GHz and Home Network 5 GHz. See your router documentation for instructions.

1. Do one of the following:
 - **Windows:** Uninstall your product software.
 - **Mac:** Go to the next step.
2. Download and install your product software from the Epson website.

Parent topic: [Changing or Updating Network Connections](#)



Related tasks

[Uninstalling Product Software - Windows](#)

Disabling Wi-Fi Features

You may need to disable your product's Wi-Fi features if you change your network connection type or need to solve a problem with your network connection.

Note: Before disabling Wi-Fi features, make a note of your product's SSID (network name) and password, and any network settings selected for the Epson Connect services you may use.

1. Press the  home button, if necessary.
2. Press the  icon.
3. Select **Router > Change Settings > Others > Disable Wi-Fi > Yes** to disable Wi-Fi.

Parent topic: [Changing or Updating Network Connections](#)

Enabling Epson Universal Print Driver (PCL) or PostScript Printing

Before enabling Epson Universal Print Driver (PCL) or PostScript printing on your product, make sure you have installed the software from the Epson website.

To download the Epson Universal Print Driver or PostScript drivers, visit epson.com/support (U.S.), epson.ca/support (Canada), or latin.epson.com/support (Latin America) and select your product.

[Installing the Epson Universal Print Driver - Windows](#)

[Installing the PostScript \(PS3\) Printer Software - Windows](#)

[Installing the PostScript \(PS3\) Printer Software - Mac](#)

[Selecting PDL \(Page Description Language\) Settings](#)

[Selecting Printer Language and Interface Settings](#)

[Printing a PCL or PS \(PostScript\) Status Sheet](#)

Installing the Epson Universal Print Driver - Windows

The Epson Universal Print Driver supports multiple printer languages, such as PCL and ESC/P-R, and can be installed on a Windows computer.

Note: Make sure your product is turned on and connected to the same network as your computer before installing the printer software. Depending on your model, not all printer languages may be supported.

1. To download the **EPSON Universal Print Driver** file, visit epson.com/support (U.S) or epson.ca/support (Canada) and select your product.
2. After downloading the installer file, double-click the downloaded file to install the software.

3. Follow the on-screen instructions until you see this screen:

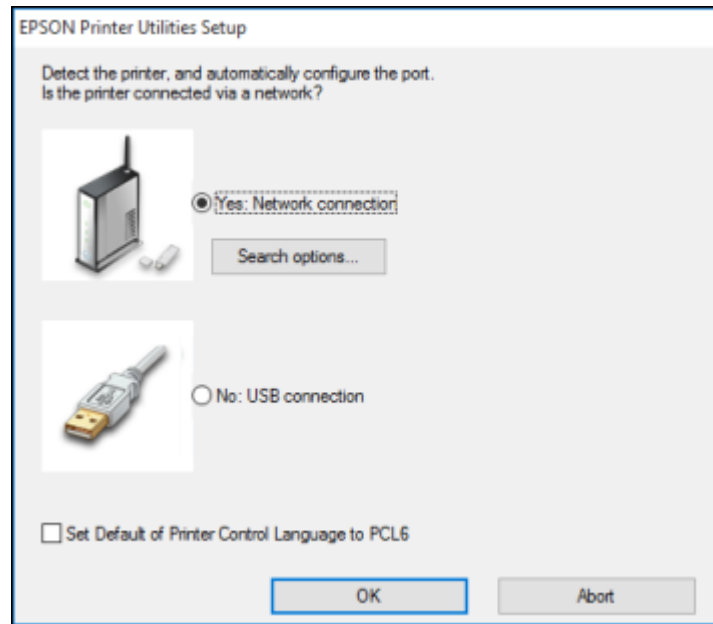

4. Select **Yes: Network connection** and click **OK**.

Note: Select the **Set Default of Printer Control Language to PCL6** checkbox if you want to set the default printer language to PCL6. Leave this option deselected to set the printer language to ESC/P-R. (You can change this setting later as needed.)

After the software finishes searching for products, you see a screen like this:

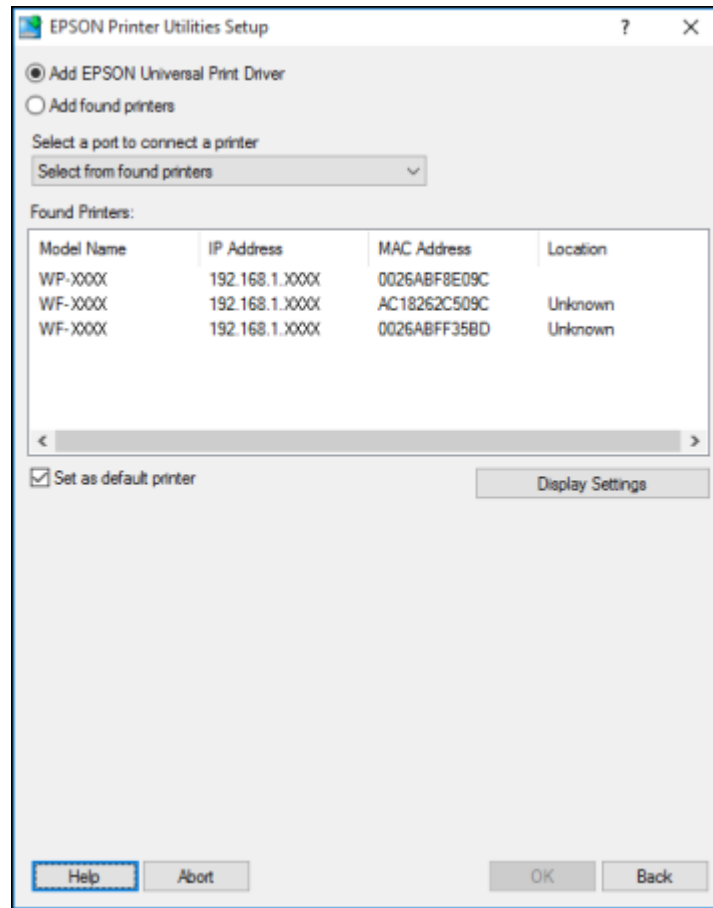

5. Do one of the following:
 - If you are installing one product, make sure **Add EPSON Universal Print Driver** is selected and continue with the next step.
 - If you are installing more than one product, select **Add found printers** and go to step 9.

Note: You can customize and filter your product search results by clicking **Display Settings**.

6. Open the **Select a port to connect a printer** menu and select an existing printer port, if necessary. Otherwise, skip this option to create a new port automatically.
7. Select the product you want to install from the Found Printers list.

Note: Deselect the **Set as default printer** checkbox if you do not want the product to be set as your default printer.

8. Click **OK**, then skip the remaining steps.
9. If you are installing more than one product, select the products from the Found Printers list and click **Add to Printer Folder**.

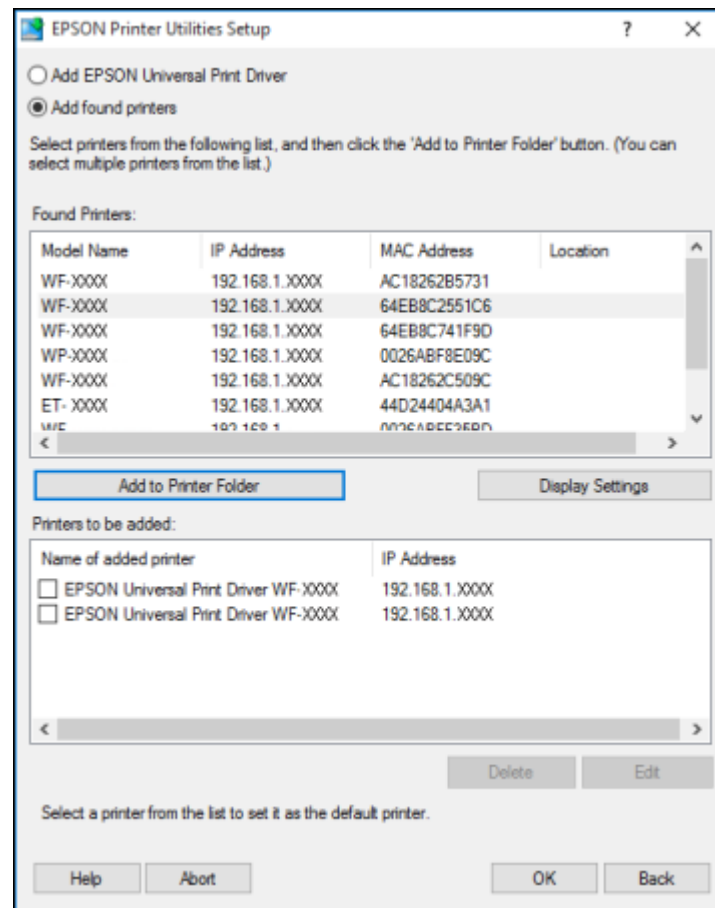

The selected products appear in the lower section of the screen.

10. Select the checkbox next to the product you want to make your default printer, if necessary.
11. Click **OK**.

Parent topic: [Enabling Epson Universal Print Driver \(PCL\) or PostScript Printing](#)

Installing the PostScript (PS3) Printer Software - Windows

If you did not install the standard Epson printer software or Epson Universal Print Driver, you need to install the PostScript (PS3) printer software before you can adjust the print settings and print to your network printer.

Note: Make sure your product is turned on and connected to the same network as your computer before installing the printer software.

1. To download the **Drivers and Utilities Combo Package - PS3 PostScript** file, visit epson.com/support (U.S.), epson.ca/support (Canada), or latin.epson.com/support (Latin America) and select your product.
2. After downloading the installer file, double-click the downloaded file to install the software.
3. Click **OK**.
4. Click **Accept**.
5. Click **Install**.
6. Click **Next** and follow the on-screen instructions.

Parent topic: [Enabling Epson Universal Print Driver \(PCL\) or PostScript Printing](#)

Installing the PostScript (PS3) Printer Software - Mac

If you did not install the standard Epson printer software, you need to install the PostScript (PS3) printer software before you can adjust the print settings and print to your network printer.

Note: Make sure your product is turned on and connected to the same network as your computer before installing the printer software.

1. To download the **Drivers and Utilities Combo Package - PS3 PostScript** file, visit epson.com/support (U.S) or epson.ca/support (Canada) and select your product.
2. After downloading the installer file, double-click the downloaded file to install the software.



3. Double-click **EPSON**.
4. Click **Continue** on the next two screens.
5. Click **Agree**.
6. Click **Install** or **Continue**.
7. If necessary, enter the administrator password.
8. Click **Start** and follow the on-screen instructions.

Parent topic: [Enabling Epson Universal Print Driver \(PCL\) or PostScript Printing](#)

Selecting PDL (Page Description Language) Settings

You can select settings for PCL and PostScript printing using the control panel on the product.

Note: These settings can be locked by an administrator. If you cannot access these settings, contact your administrator for assistance.

1. Press the  home button, if necessary.
2. Select **Settings > General Settings > Printer Settings > PDL Print Configuration**.
3. Select one of the options shown above, then select the PDL print configuration options you want to use.
4. When you are finished, press the  home button to exit.

[PDL Print Configuration Options](#)

Parent topic: [Enabling Epson Universal Print Driver \(PCL\) or PostScript Printing](#)

PDL Print Configuration Options

Select the **PDL Print Configuration** options you want to use for PCL or PostScript printing.

PDL Print Configuration option	Available settings	Description
Common Settings		
Paper Size	Various sizes	Sets the default paper size for PCL or PostScript printing
Paper Type	Various paper types	Sets the default paper type for PCL or PostScript printing

PDL Print Configuration option	Available settings	Description
Orientation	Portrait	Sets the default orientation for PCL or PostScript printing
	Landscape	
Quality	Draft	Sets the quality for PCL or PostScript printing
	Standard	
	Best	
Ink Save Mode	On/Off	Saves ink by reducing print density
Print Order	Last Page on Top	Starts printing from the first page of a file
	First Page on Top	Starts printing from the last page of a file
Number of Copies	1 to 999	Selects the number of copies to print
Binding Margin	Left Edge	Specifies the binding edge for double-sided documents
	Top Edge	
Auto Paper Ejection	On/Off	Ejects paper automatically when printing is stopped during a print job
2-Sided Printing	On/Off	Selects duplex printing
PCL Menu		
Font Source	Resident	Uses a font preinstalled on the printer
	Download	Uses a font you have downloaded
Font Number	1 to 111	Selects the default font number for the default font source
Pitch	0.44 to 99.99 cpi	Selects the default font pitch if the font is scalable and fixed-pitch (availability depends on font source and number settings)
Height	4.00 to 999.75 pt	Selects the default font height if the font is scalable and proportional (availability depends on font source and number settings)



PDL Print Configuration option	Available settings	Description
Symbol Set	Various	Selects the default symbol set. If the selected font is not available for the selected symbol set, the font source and number are replaced with IBM-US (the default setting).
Form	5 to 128 lines	Sets the number of lines for the selected paper size and orientation. Changes the line spacing (VMI) stored in the printer. Later changes in page size or orientation cause changes in the Form value based on the stored VMI.
CR Function	CR	Selects the carriage return and line feed commands when printing with a driver from a specific operating system
	CR+LF	
LF Function	LF	
	CR+LF	
Paper Source Assign	4	Makes the paper source select command compatible with HP LaserJet 4
	4K	Makes the paper source select command compatible with HP LaserJet 4000, 5000, and 8000
	5S	Makes the paper source select command compatible with HP LaserJet 5S
PS3 Menu		
Error Sheet	On/Off	Prints a sheet showing the status when errors occur during PostScript or PDF printing
Coloration	Color	Selects the color mode for PostScript printing
	Mono	
Binary	On/Off	Enable when printing files that contain binary images (available when the product is connected to the network). Allows you to print binary images even if the driver is set to ASCII.
PDF Page Size	Various sizes	Selects the paper size when printing a PDF file. If Auto is selected, the paper size is determined based on the size of the first page.

Parent topic: [Selecting PDL \(Page Description Language\) Settings](#)

Selecting Printer Language and Interface Settings

You can select printer language and interface settings using the control panel on the product.

Note: These settings can be locked by an administrator. If you cannot access these settings, contact your administrator for assistance.

1. Press the  home button, if necessary.
2. Select **Settings > General Settings > Printer Settings**.
3. To change interface settings, scroll down and select the interface options for your connection type.
4. To select printer language settings, select **Printing Language** and select the printing language for your connection type.
5. When you are finished, press the  home button to exit.

[Printing Language and Interface Options](#)

Parent topic: [Enabling Epson Universal Print Driver \(PCL\) or PostScript Printing](#)

Printing Language and Interface Options

Select the printing language and interface options you want to use.

Option	Available settings	Description
PC Connection via USB	Enable	Select whether to allow USB communication with the product
	Disable	
USB I/F Timeout Setting	0.5 to 300 seconds	Specify the length of time before ending USB communication from a computer using the PCL or PostScript driver. This setting is necessary to avoid endless USB communication.
Printing Language	Auto	Select the language for the USB or network interface
	PCL	
	PS3	
	PDF	

Parent topic: [Selecting Printer Language and Interface Settings](#)

Printing a PCL or PS (PostScript) Status Sheet

You can print a PCL or PS3 (PostScript) status sheet to confirm the current font information.

1. Press the  home button, if necessary.
2. Select **Settings**.
3. Scroll down and select **Print Status/Print**.
4. Select **Print Status Sheet**.
5. Select **PCL Font List** or **PS Font List**.
6. Select **Print** to print the status sheet.

Parent topic: [Enabling Epson Universal Print Driver \(PCL\) or PostScript Printing](#)

Loading Paper

Before you print, load paper for the type of printing you will do.

[Loading Paper in the Cassette and Rear Paper Feed Slot](#)

[Paper Loading Capacity](#)

[Double-sided Printing Paper Types](#)

[Compatible Epson Papers](#)

[Paper or Media Type Settings - Printing Software](#)

[Selecting the Paper Settings for Each Source - Control Panel](#)



[Selecting Default Paper Settings - Administrator](#)

Loading Paper in the Cassette and Rear Paper Feed Slot

You can load paper up to Letter (8.5 × 11 inches [216 × 279 mm]) or A4 (8.3 × 11.7 inches [210 × 297 mm]) in the standard and optional paper cassettes. The paper tray can accommodate user-defined paper sizes from 2.2 × 5.0 inches (55 × 127 mm) to 12.95 × 47.2 inches (329 × 1200 mm) for single-sided printing.

You can view instructions on how to load paper in the cassettes or paper tray on the control panel.

Note: If the optional paper cassette units are installed, do not remove more than one cassette at a time.

1. Select the  icon on the LCD screen.
2. Select **How To > Load paper**.
3. Select one of the options.
4. Select **How To**.
5. Select the  icon to scroll through the paper loading instructions.

Caution: Slowly open and close the paper cassettes. Do not let the paper's edge slide across your skin because the edge of the paper may cut you.

6. If necessary, select **Close** and then select the  **Paper Setting** button and select the size and type of paper you loaded on the LCD screen.

Note: If the **Paper Size Auto Detect** setting is enabled, your product will automatically detect the size of the paper you loaded. To select a user-defined paper size, disable the **Paper Size Auto Detect** setting.

Always follow these paper loading guidelines:

- Load only the recommended number of sheets.
- Fan and align the edges of the paper or envelopes before loading.
- Load letterhead or pre-printed paper top edge first.
- Do not load paper above the arrow mark inside the edge guides.
- Insert and remove paper cassettes slowly.
- Check the paper package for any additional loading instructions.

Caution: Do not use the following papers; they may cause paper jams, smears on the printout, or damage to the printer.

- Papers that are wavy or damp
- Papers that have not dried after printing on one side
- Papers that are wadded or curled
- Papers that are torn, cut, or folded
- Papers that are too thick or thin
- Preprinted papers printed by other inkjet printers, thermal transfer printers, page printers, or copiers
- Papers that are perforated
- Papers that have stickers
- Papers held together with tape, staples, or paper clips
- Envelopes with adhesive surfaces or windows

Note: Store paper flat in its packaging or a plastic bag to avoid absorbing moisture. Store paper in a location with low humidity and away from direct sunlight. Do not store paper vertically and do not get the paper wet.

Parent topic: [Loading Paper](#)

Related references

[Paper Specifications](#)

[Paper Loading Capacity](#)

Paper Loading Capacity

Paper Cassettes

The table below shows the paper cassette capacity for paper in the following sizes unless noted otherwise:

- Letter (8.5 × 11 inches [216 × 279 mm]), Executive (7.25 × 10.5 inches [184 × 267 mm]), 8.5 × 13 inches (216 × 330 mm), Legal (8.5 × 14 inches [216 × 356 mm]), 11 × 17 inches (279 × 432 mm)
- A5 (5.8 × 8.2 inches [148 × 210 mm]), A4 (8.3 × 11.7 inches [210 × 297 mm]), A3 (11.7 × 16.5 inches [297 × 420 mm])
- B5 (7.2 × 10.1 inches [182 × 257 mm]), B4 (13.9 × 9.84 inches [353 × 250 mm])
- Oficio 9 (8.46 × 12.4 inches [215 × 315 mm]), Mexico-Oficio (8.5 × 13.4 inches [216 × 340 mm])
- A6 (4.1 × 5.8 inches [105 × 148 mm]), B6 (5 × 7.2 inches [128 × 182 mm]), Half Letter (5.5 × 8.5 inches [140 × 216 mm]), 13 × 19 inches (330 × 483 mm) (for C1 only)
- User-defined (3.9 × 5.8 inches to 11.7 × 17.0 inches [100 × 148 mm to 297 × 431.8 mm]) (for C1 only)
- User-defined (5.8 × 8.3 inches to 11.7 × 17.0 inches [148 × 210 mm to 297 × 431.8 mm]) (for C2-C4 only)

Paper type	Loading capacity
Plain paper	Up to the line indicated by the triangle symbol on the edge guide: <ul style="list-style-type: none">• 250 sheets (for C1 only)• 500 sheets (for C2-C4 only)
Pre-printed paper	
Letterhead paper	
Colored paper	
Recycled paper	
High quality plain paper	
Thin paper (14 to 16 lb [52 to 59 g/m ²])	

Paper type	Loading capacity
Epson Bright White Premium Paper Epson Bright White Pro Paper Epson Multipurpose Plus Paper	Letter (8.5 × 11 inches [216 × 279 mm]): <ul style="list-style-type: none"> • 250 sheets (for C1 only) • 500 sheets (for C2-C4 only)

Paper Tray

The table below shows the paper tray capacity for paper in the following sizes unless noted otherwise.

Note: For paper longer than 17 inches (431.9 mm), load one sheet at a time.

- Letter (8.5 × 11 inches [216 × 279 mm]), Executive (7.25 × 10.5 inches [184 × 267 mm]), Half Letter (5.5 × 8.5 inches [140 × 216 mm]), Legal (8.5 × 14 inches [216 × 356 mm]), 11 × 17 inches (279 × 432 mm)
- A6 (4.1 × 5.8 inches [105 × 148 mm]), A5 (5.8 × 8.2 inches [148 × 210 mm]), A4 (8.3 × 11.7 inches [210 × 297 mm]), A3 (11.7 × 16.5 inches [297 × 420 mm])
- B6 (5 × 7.2 inches [128 × 182 mm]), B5 (7.2 × 10.1 inches [182 × 257 mm]), B4 (13.9 × 9.84 inches [353 × 250 mm])
- Oficio 9 (8.46 × 12.4 inches [215 × 315 mm]), Mexico-Oficio (8.5 × 13.4 inches [216 × 340 mm])
- 8.5 × 13 inches (216 × 330 mm)
- User-defined (3.9 × 5.8 inches to 11.7 × 17.0 inches [100 × 148 mm to 297 × 431.8 mm])
- User-defined (5.8 × 8.3 inches to 11.7 × 17.0 inches [148 × 210 mm to 297 × 431.8 mm])
- User-defined (2.2 × 5.0 inches to 12.95 × 47.2 inches [55 × 127 mm to 329 × 1200 mm])

Paper type	Loading capacity
Plain paper Pre-printed paper Letterhead paper Colored paper Recycled paper Thin paper (14 to 16 lb [52 to 59 g/m ²])	Up to the line indicated by the triangle symbol on the edge guide (100 sheets)
Epson Bright White Premium Paper Epson Bright White Pro Paper Epson Multipurpose Plus Paper	85 sheets: Letter (8.5 × 11 inches [216 × 279 mm])
Envelopes	10

Parent topic: [Loading Paper](#)

Related references
[Paper Specifications](#)

Double-sided Printing Paper Types

You can print double-sided on the following papers:

- Plain paper
- Pre-printed paper
- Letterhead paper
- Colored paper
- Recycled paper
- High quality plain paper
- Thick paper 25 to 68 lb (91 to 256 g/m²)
- Epson Bright White Premium Paper
- Epson Bright White Pro Paper

- Epson Multipurpose Plus Paper

Note: You can print double-sided on any supported sizes except the following:

- 13 × 19 inches (330 × 483 mm)
- Half Letter (5.5 × 8.5 inches [140 × 216 mm])
- A6 (4.1 × 5.8 inches [105 × 148 mm])
- B6 (5 × 7.2 inches [128 × 182 mm])

To print double-sided with a user-defined size, the dimensions of the paper must have a width between 5.8 and 8.27 inches (148 to 210 mm) and a length between 11.7 and 17.0 inches (297 to 431.8 mm).

Parent topic: [Loading Paper](#)

Related tasks

[Selecting Double-sided Printing Settings - Windows](#)

[Selecting Double-sided Printing Settings - Mac](#)

Compatible Epson Papers

You can purchase genuine Epson ink, maintenance boxes, and paper at epson.com (U.S. sales), epson.ca (Canadian sales), or latin.epson.com (Latin American sales). You can also purchase supplies from an Epson authorized reseller. To find the nearest one, call 800-GO-EPSON (800-463-7766) in the U.S. or 800-807-7766 in Canada.

Note: Paper/media availability varies by country.

Paper Type	Size	Part number	Sheet count
Epson Bright White Pro Paper	Letter (8.5 × 11 inches [216 × 279 mm])	S041586	500

Paper Type	Size	Part number	Sheet count
Epson Presentation Paper Matte	Legal (8.5 × 14 inches [216 × 356 mm])	S041067	100
	Letter (8.5 × 11 inches [216 × 279 mm])	S041062	100
	A3 (11.7 × 16.5 inches [297 × 420 mm])	S041069-L	100
	11 × 17 inches (279 × 432 mm)	S041070	100
Epson Premium Presentation Paper Matte	8 × 10 inches (203 × 254 mm)	S041467	50
	Letter (8.5 × 11 inches [216 × 279 mm])	S041257	50
		S042180	100
	13 × 19 inches (330 × 483 mm)	S041263	50
A3 (11.7 × 16.5 inches [297 × 420 mm])	S041260	50	
Epson Photo Paper Glossy	4 × 6 inches (102 × 152 mm)	S041809	50
		S042038	100
	Letter (8.5 × 11 inches [216 × 279 mm])	S041141	20
		S041649	50
		S041271	100
	A4 (8.3 × 11.7 inches [210 × 297 mm])	S041140	20
11 × 17 inches (279 × 432 mm)	S041156	20	
13 × 19 inches (330 × 483 mm)	S041143	20	

Paper Type	Size	Part number	Sheet count
Epson Premium Photo Paper Glossy	4 × 6 inches (102 × 152 mm)	S041727	100
	5 × 7 inches (127 × 178 mm)	S041464	20
	8 × 10 inches (203 × 254 mm)	S041465	20
	Letter (8.5 × 11 inches [216 × 279 mm])	S042183	25
		S041667	50
	11 × 17 inches (279 × 432 mm)	S041290	20
	A3 (11.7 × 16.5 inches [297 × 420 mm])	S041288	20
13 × 19 inches (330 × 483 mm)	S041289	20	
Epson Ultra Premium Photo Paper Glossy	4 × 6 inches (102 × 152 mm)	S042181	60
		S042174	100
	5 × 7 inches (127 × 178 mm)	S041945	20
	8 × 10 inches (203 × 254 mm)	S041946	20
	Letter (8.5 × 11 inches [216 × 279 mm])	S042182	25
S042175		50	
Epson Premium Photo Paper Semi-gloss	4 × 6 inches (102 × 152 mm)	S041982	40
	Letter (8.5 × 11 inches [216 × 279 mm])	S041331	20
	13 × 19 inches (330 × 483 mm)	S041327	20

Parent topic: [Loading Paper](#)

Paper or Media Type Settings - Printing Software



For this paper	Select this Paper Type or Media Type setting
Plain paper Epson Bright White Premium Paper Epson Bright White Pro Paper Epson Multipurpose Plus Paper	Plain Paper / Bright White Paper
Letterhead paper	Letterhead
Recycled paper	Recycled
Colored paper	Color
Pre-printed paper	Preprinted
High-quality plain paper	High Quality Plain Paper
Envelopes	Envelope
Epson Ultra Premium Photo Paper Glossy	Ultra Premium Photo Paper Glossy
Epson Premium Photo Paper Glossy	Premium Photo Paper Glossy
Epson Photo Paper Glossy	Photo Paper Glossy
Epson Premium Photo Paper Semi-gloss	Premium Photo Paper Semi-Gloss
Epson Presentation Paper Matte Epson Premium Presentation Paper Matte	Premium Presentation Paper Matte
Thick paper (25 to 40 lb [91 to 150 g/m ²])	Card Stock 1
Thick paper (41 to 53 lb [151 to 200 g/m ²])	Card Stock 2
Thick paper (54 to 68 lb [201 to 256 g/m ²])	Card Stock 3

Note: The settings listed here are available only when printing from your computer; they do not apply to your product's control panel settings.

Parent topic: [Loading Paper](#)

Selecting the Paper Settings for Each Source - Control Panel

You can change the default paper size and paper type for each source using the control panel on the product.

1. Press the  **Paper Setting** button.
2. Select the paper source you want to select settings for.
3. Select **Paper Size**.
4. Select the paper size you loaded.
5. Select **Paper Type**.
6. Select the paper type for the paper you loaded.
7. Turn on the **Paper Size Auto Detect** setting to automatically detect the size of the paper loaded in the paper source.
8. Select another paper source to change or press the  home button to exit.

[Paper Type Settings - Control Panel](#)

Parent topic: [Loading Paper](#)

Paper Type Settings - Control Panel

Select a **Paper Type** setting that matches the paper you loaded.

Paper type loaded	Paper Type setting
Plain paper Epson Bright White Premium Paper Epson Bright White Pro Paper Epson Multipurpose Plus Paper	Plain Paper
Letterhead paper	Letterhead
Recycled paper	Recycled
Colored paper	Color
Pre-printed paper	Preprinted
High-quality plain paper	High Quality Plain Paper
Envelopes	Envelope

Paper type loaded	Paper Type setting
Epson Ultra Premium Photo Paper Glossy	Ultra Glossy
Epson Premium Photo Paper Glossy	Prem. Glossy
Epson Photo Paper Glossy	Glossy
Epson Premium Photo Paper Semi-gloss	Prem. Semi-Gloss
Epson Presentation Paper Matte Epson Premium Presentation Paper Matte	Prem. Matte
Thick paper up to 25 to 40 lb (91 to 150 g/m ²)	Card Stock 1
Thick paper up to 41 to 53 lb (151 to 200 g/m ²)	Card Stock 2
Thick paper up to 54 to 68 lb (201 to 256 g/m ²)	Card Stock 3

Parent topic: [Selecting the Paper Settings for Each Source - Control Panel](#)

Selecting Default Paper Settings - Administrator

As an administrator, you can adjust default paper settings that apply to all print jobs sent to the product.

Note: These settings can be locked by an administrator. If you cannot access these settings, contact your administrator for assistance.

[Selecting the Default Printer Settings](#)
[Selecting the Universal Print Settings](#)

Parent topic: [Loading Paper](#)

Selecting the Default Printer Settings

You can change default printer settings using the control panel on the product.

Note: These settings can be locked by an administrator. If you cannot access these settings, contact your administrator for assistance.

1. Press the  home button, if necessary.
2. Select **Settings**.
3. Select **General Settings**.

4. Select **Printer Settings**.
5. Select one of these options for the **Auto Error Solver** setting:
 - Turn on this setting to display a warning and print single-sided when a 2-sided printing error occurs, or to print only what the printer could process when a full memory error occurs.
 - Turn off this setting to display an error message and stop printing if an error occurs.
6. Select **Paper Source Settings**.
7. Select the Paper Source Settings options you want to use.
8. When you are finished, press the  home button to exit.

[Paper Source Settings Options](#)

Parent topic: [Selecting Default Paper Settings - Administrator](#)

Paper Source Settings Options

Select the paper source options you want to use for your print jobs.



Paper Source Settings option	Available settings	Description
Paper Setting	Various	Select the paper size and type for each paper source
A4/Letter Auto Switching	On	Select On to switch the selected paper size to match the loaded paper (Letter or A4) if the wrong size is selected
	Off	
Auto Select Settings	Available paper sources	Select On for any of these settings to automatically print on paper from any source containing paper that matches your paper settings Note: More than one paper source needs to be set to On .
Error Notice	Paper Size Notice	Select On for either of these settings to display an error message when the selected paper type or size does not match the loaded paper
	Paper Type Notice	
Paper Setup Auto Display	On	Select On to automatically display a menu that lets you select the paper size and type when you load paper in the product
	Off	
User-Defined Paper Size List	Various	Enter a user-defined paper size setting

Parent topic: [Selecting the Default Printer Settings](#)

Selecting the Universal Print Settings

You can change the default universal print settings using the control panel on the product.

Note: These settings can be locked by an administrator. If you cannot access these settings, contact your administrator for assistance.

1. Press the  home button, if necessary.
2. Select **Settings > General Settings > Printer Settings > Universal Print Settings**.
3. Adjust the settings as necessary.
4. When you are finished, press the  home button to exit.

[Universal Print Settings Options](#)

Parent topic: [Selecting Default Paper Settings - Administrator](#)

Universal Print Settings Options

Select the universal print setting options you want to use for your print jobs.

Universal Print Settings option	Available settings	Description
Top Offset	—	Adjust the top or left margin
Left Offset		
Top Offset in Back	—	Adjust the top or left margin of the back page when printing double-sided
Left Offset in Back		
Check Paper Width	On	Select On to check the paper width before printing. This prevents printing beyond the edges of the paper when the paper size settings are incorrect, but may reduce the printing speed.
	Off	
Skip Blank Page	On	Select On to skip printing of blank pages automatically
	Off	

Universal Print Settings option	Available settings	Description
Color Correction	On	Select On to adjust settings such as brightness, contrast, saturation, and more
	Off	

Parent topic: [Selecting the Universal Print Settings](#)

Placing Originals on the Product

Follow the instructions here to place your original documents or photos on the product.

Caution: Do not place anything on top of your product or use its cover as a writing surface to avoid damaging it.

Note: If **Auto Detect** is selected as the paper size setting, the scanner glass and ADF should automatically detect the size of your original. The size of originals that are ripped, folded, wrinkled, curled, or glossy, or transparencies or originals with lots of holes may not be correctly detected. If the document size isn't detected, you need to manually select it on the control panel.

[Placing Originals on the Scanner Glass](#)

[Placing Originals in the Automatic Document Feeder](#)

Placing Originals on the Scanner Glass

You can place originals up to this size on the scanner glass: Letter (8.5 × 11 inches [216 × 279 mm]) or A4 (8.3 × 11.7 inches [210 × 297 mm]).

Note: When originals are placed in the ADF and on the scanner glass, priority is given to the originals in the ADF.

1. Press the ⓘ help button and select **How To > Place Originals > Scanner Glass**.
2. Follow the on-screen instructions.

Caution: Be careful not to trap your hands or fingers when opening or closing the document cover. Do not push down on the document cover or scanner glass or you may damage the product.

Note: If there is any dust or dirt on the scanner glass, the scanning range may expand to include it, so the image of the original may be displaced or reduced. Use a soft, dry, clean cloth to remove any dust and dirt on the scanner glass before scanning. When placing bulky originals such as books, prevent exterior light from shining directly onto the scanner glass.

Note: The edges of your original may be cropped by 0.06 inch (1.5 mm) from the edge of the scanner glass. Manually position your original away from the edges to prevent cropping.

Note: Do not press with too much force on the original; otherwise, blurring, smudges, and spots may occur. If the original has folds or wrinkles, smooth them out before loading it on the scanner glass. Images may be blurry at the parts where the original is not in close contact with the scanner glass.

Remove your originals after scanning. If you leave the originals on the scanner glass for a long time, they may stick to the glass surface.

Parent topic: [Placing Originals on the Product](#)

Placing Originals in the Automatic Document Feeder

You can place single- or multi-page original documents in the Automatic Document Feeder (ADF). You can also use the ADF to scan both sides of a 2-sided document. Make sure the originals meet the Automatic Document Feeder specifications before loading them.

Caution: Do not load the following types of originals in the ADF, or they may be damaged or may damage the scanner. Use the scanner glass for these types:

- Ripped, curled, folded, deteriorated, or wrinkled originals
- Originals with holes
- Originals containing staples or paper clips
- Originals with carbon paper backing
- Originals with labels, stickers, or sticky notes
- Originals that are bound
- Originals that are cut irregularly or not cut at a right angle
- Photos or valuable artwork
- Thermal paper
- Transparencies
- Fabric or other non-paper originals
- Originals with uneven surfaces, such as embossed documents
- Originals with wet ink

Note: When originals are placed in the ADF and on the scanner glass, priority is given to the originals in the ADF.

Note: Do not load originals above the line under the triangle symbol on the ADF edge guide. Do not load originals while scanning.

1. Select the  help icon and select **How To > Place Originals > ADF**.
2. Follow the on-screen instructions.

Note: Place the long edge of the original toward the paper feed entrance of the ADF.

Parent topic: [Placing Originals on the Product](#)

Copying

See the information here to copy documents or photos using your product.

Note: Copies may not be exactly the same size as your originals.

[Copying Documents or Photos](#)

[Copying Options](#)

Copying Documents or Photos

You can copy documents or photos onto various sizes and types of paper, including Epson special papers.

1. Place your original document or photo on the scanner glass, or place multi-page documents in the ADF.
2. Load the paper you want to print on.
3. Press the  home button, if necessary.
4. Select **Copy**.
5. To print more than one copy, press a number key on the product's control panel, or select **Copies** and use the displayed keypad to enter the number of copies.
6. Change any of the displayed settings as necessary.
7. Select **Advanced** to view and change additional copy settings, if necessary.
8. Select **Preview** to preview your copy on the LCD screen.
9. Select **Presets** to save your copy settings.

Note: Presets can be locked by an administrator. If you can't access or change this setting, contact your administrator for assistance.

10. When you are ready to copy, press the **Copy** icon.

Note: To cancel printing, press the  stop button or select **Cancel**.

Parent topic: [Copying](#)

Related references[Copying Options](#)**Related tasks**[Using Presets](#)**Related topics**[Loading Paper](#)[Placing Originals on the Product](#)

Copying Options

Select the copying options you want to use for your copies.

Note: Not all options or settings may be available, depending on other copying settings.

Basic Settings

Copying option	Available settings	Description
B&W	—	Copies the document in black and white
Color	—	Copies the document in color
Density	Varying levels	Adjusts the lightness or darkness of copies
Paper Setting	Various sources	Select the paper source that you want to use. If you select Auto , paper is fed automatically depending on the paper settings you selected for the paper sources.
Reduce/Enlarge	Reduce to Fit Paper	Automatically decreases the size of the image by the percentage you select
	100%	Copies the original at its full size
	Auto	Automatically sizes the image to fit the paper size you selected
	50%->200% and other conversions	Automatically converts from one size to another
Original Type	Various types	Specifies the document type of your originals and adjusts the quality of your copies

Copying option	Available settings	Description
2-Sided	1>1-Sided	Select to make 2-sided copies. When you select 1>2-Sided or 2>1-Sided , scroll down and select the orientation and binding edge for your originals or copies.
	2>2-Sided	
	1>2-Sided	
	2>1-Sided	

Advanced settings

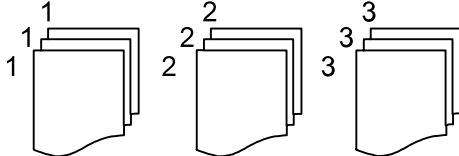
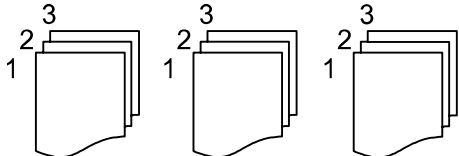
Copying option	Available settings	Description
Multi-Page	Single Page	Copies each page of the original onto an individual sheet
	2-up	Copies multiple page documents onto one sheet. Scroll down and select the document orientation and layout order settings as necessary.
	4-up	
Original Size	Various sizes	Select the document size of your original . When you select Auto Detect , the size of your original is automatically detected. When copying non-standard size originals, select the size closest to your original.
Finishing	Group (Same Pages)	Select to print multiple copies of a multi-page document in unordered groups 
	Collate (Page Order)	Select to print multiple copies of a multi-page document in ordered sets 
Mixed Size Originals	Off	Select On to copy originals of varying sizes in their original sizes
	On	

Copying option	Available settings	Description
Orientation (Original)	Up Direction	Specifies the orientation of your originals
	Left Direction	
Book>2Pages	Off	Select On to copy two pages of a book onto separate sheets of paper
	On	
Image Quality	Various settings	Select advanced quality settings such as Saturation and Sharpness
Binding Margin	Off	Select On to adjust the margin and orientation of the pages when copying a book
	On	
Reduce to Fit Paper	Off	Select On to automatically decrease the image by the percentage you select
	On	
Remove Shadow	Frame	Removes shadows that appear around copies when copying thick paper
	Center	Removes shadows that appear in the center of copies when copying a booklet
Remove Punch Holes	Off	Select On to erase the binding holes on a document. Scroll down and select the erasing position and orientation for your originals or copies.
	On	
ID Card Copy	Off	Select On to copy both sides of an ID card onto one side of a sheet of paper. Select the orientation for your originals or copies.
	On	

Parent topic: [Copying](#)

Printing from a Computer

Before printing from your computer, make sure you have set up your product and installed its software from the Epson website.

Note: If you have an Internet connection, it is a good idea to check for updates to your product software on Epson's support website. If you see a Software Update screen, select **Enable automatic checking** and click **OK**. The update scans your system to see if you have the latest product software. Follow the on-screen instructions.

[Printing with the Standard Epson Printer Software - Windows](#)

[Printing with the Epson Standard Printer Software - Mac](#)

[Printing with the Epson Universal Print Driver - Windows](#)

[Printing with the PostScript \(PS3\) Printer Software - Windows](#)

[Printing with the PostScript \(PS3\) Printer Software - Mac](#)

[Printing from a Smartphone or Tablet](#)

[Cancelling Printing Using a Product Button](#)

Printing with the Standard Epson Printer Software - Windows

You can print with the standard Epson printer software using any Windows printing program, as described in these sections.

Note: If you are using your Epson product with the Windows 10 S operating system, you cannot use the software described in this section. You also cannot download and install any Epson product software from the Epson website for use with Windows 10 S; you must obtain software only from the Windows Store.

[Selecting Basic Print Settings - Windows](#)

[Selecting Double-sided Printing Settings - Windows](#)

[Selecting Additional Layout and Print Options - Windows](#)

[Selecting a Printing Preset - Windows](#)

[Selecting Extended Settings - Windows](#)

[Printing Your Document or Photo - Windows](#)

[Locking Printer Settings - Windows](#)

[Entering a User ID and Password for Printing](#)

[Selecting Default Print Settings - Windows](#)

[Changing Automatic Update Options](#)

Parent topic: [Printing from a Computer](#)

Selecting Basic Print Settings - Windows

Select the basic settings for the document or photo you want to print.

1. Open a photo or document for printing.
2. Select the print command in your application.

Note: You may need to select a print icon on your screen, the **Print** option in the **File** menu, or another command. See your application's help utility for details.

3. If necessary, select your product name as the printer you want to use.

Note: You may also need to select **More settings**, **Properties**, or **Preferences** to view your print settings.

You see the **Main** tab of your printer settings window:

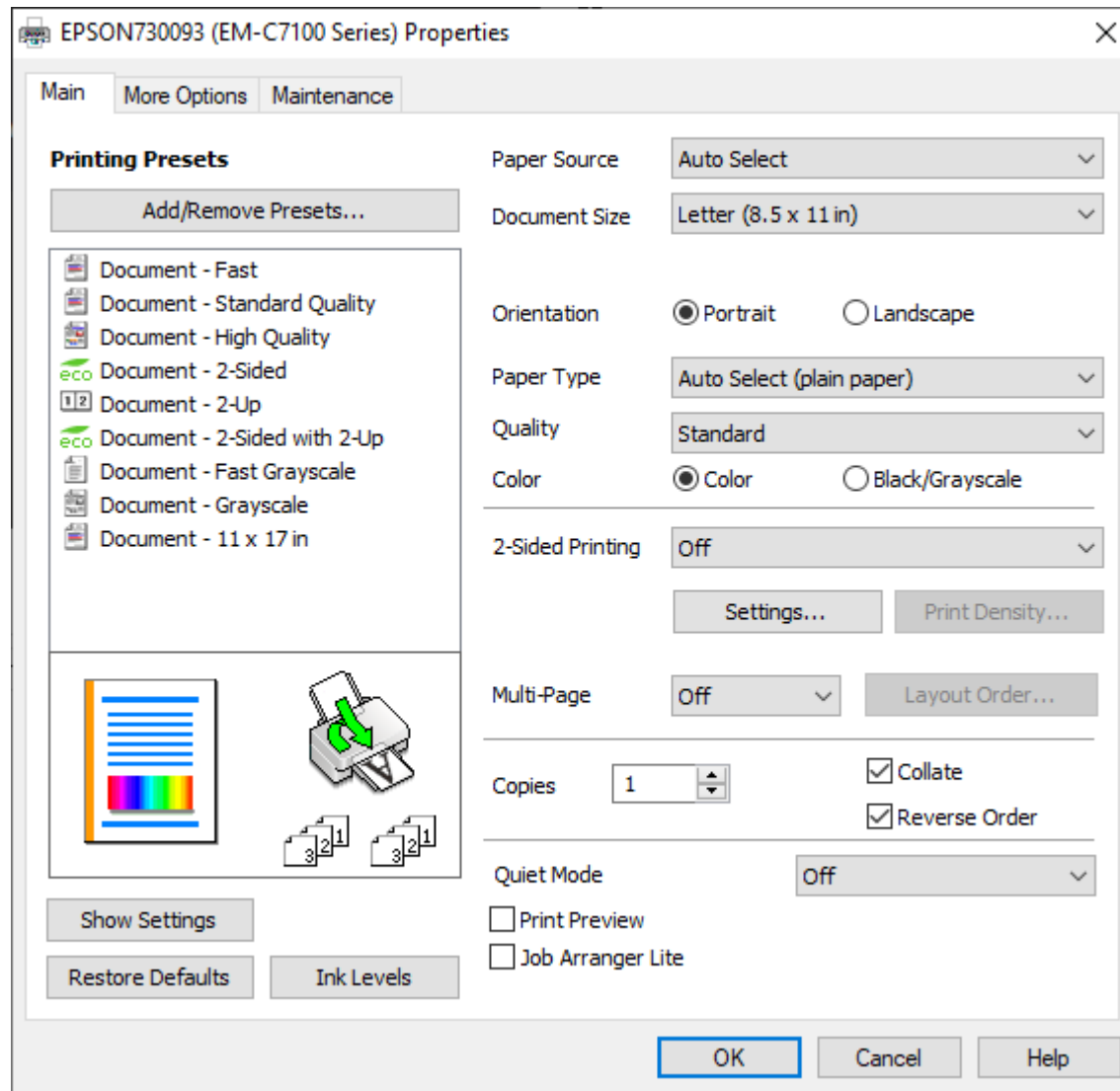

4. For the **Paper Source** setting, select where you loaded the paper you want to print on. Select **Auto Select** to automatically select the paper source in the paper setting menu on the product.

5. Select the size of your document or photo as the **Document Size** setting.
6. Select the orientation of your document.

Note: If you are printing an envelope, select **Landscape**.

7. Select the type of paper you loaded as the **Paper Type** setting. Select **Auto Select (plain paper)** to automatically use the paper type selected on the product control panel.

Note: The setting may not exactly match the name of your paper. Check the paper type settings list for details.

8. Select the **Quality** setting that matches the print quality you want to use.
9. Select a **Color** option:
 - To print a color document or photo, select the **Color** setting.
 - To print text and graphics in black or shades of gray, select the **Black/Grayscale** setting.
10. To print on both sides of the paper, select a **2-Sided Printing** option and click **Settings** to select printing options.
11. To print multiple pages on one sheet of paper, or print one image on multiple sheets of paper, select one of the **Multi-Page** options and click **Layout Order** to select the printing options.
12. To print multiple copies and arrange their print order, select the **Copies**, **Reverse Order**, and **Collate** options.
13. To preview your job before printing, select the **Print Preview** checkbox.
14. To save your print job as a project that can be modified and combined with other print jobs, select **Job Arranger Lite**.

[Paper Source Options - Windows](#)

[Print Quality Options - Windows](#)

[Multi-Page Printing Options - Windows](#)

Parent topic: [Printing with the Standard Epson Printer Software - Windows](#)

Paper Source Options - Windows

You can select any of the available options in the Paper Source menu to print on the paper loaded in that source.

Note: Paper Cassette 2 through Paper Cassette 4 are available only if you have installed the optional cassettes.

Auto Select

Automatically selects the paper source based on the selected paper size.

Paper Cassette 1

Selects the paper in cassette 1 as the paper source.

Paper Cassette 2

Selects the paper in cassette 2 as the paper source.

Paper Cassette 3

Selects the paper in cassette 3 as the paper source.

Paper Cassette 4

Selects the paper in cassette 4 as the paper source.

Rear Paper Feed Slot

Selects the paper in the rear feed slot as the paper source.

Parent topic: [Selecting Basic Print Settings - Windows](#)

Print Quality Options - Windows

You can select any of the available Quality options to fine-tune the quality of your print. Some settings may be unavailable, depending on the paper type and border setting you have chosen.

Draft

For draft printing on plain paper.

Standard

For everyday text and image printing.

High

For photos and graphics with high print quality.

Parent topic: [Selecting Basic Print Settings - Windows](#)

Multi-Page Printing Options - Windows

You can select any of the available options in the Multi-Page menu to set up your multi-page print job.

2-Up, 4-Up, 6-Up, 8-Up, 9-Up, and 16-Up

Prints several pages on one sheet of paper. Click the **Layout Order** button to select page layout and border options.

2×1 Poster, 2×2 Poster, 3×3 Poster, 4×4 Poster

Prints one image on multiple sheets of paper to create a larger poster. Click the **Settings** button to select image layout and guideline options.

Parent topic: [Selecting Basic Print Settings - Windows](#)

Selecting Double-sided Printing Settings - Windows

You can print on both sides of the paper by selecting one of the 2-Sided Printing options on the Main tab.

Note: Some options may be pre-selected or unavailable, depending on other settings you have chosen or if you are accessing the product over a network.

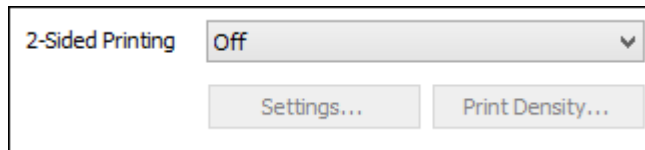

1. Select one of the following options for **2-Sided Printing**:
 - **Auto (Long-edge binding)** to print your double-sided print job by automatically flipping the paper on the long edge.
 - **Auto (Short-edge binding)** to print your double-sided print job by automatically flipping the paper on the short edge.
2. Click the **Settings** button.

You see a window like this:

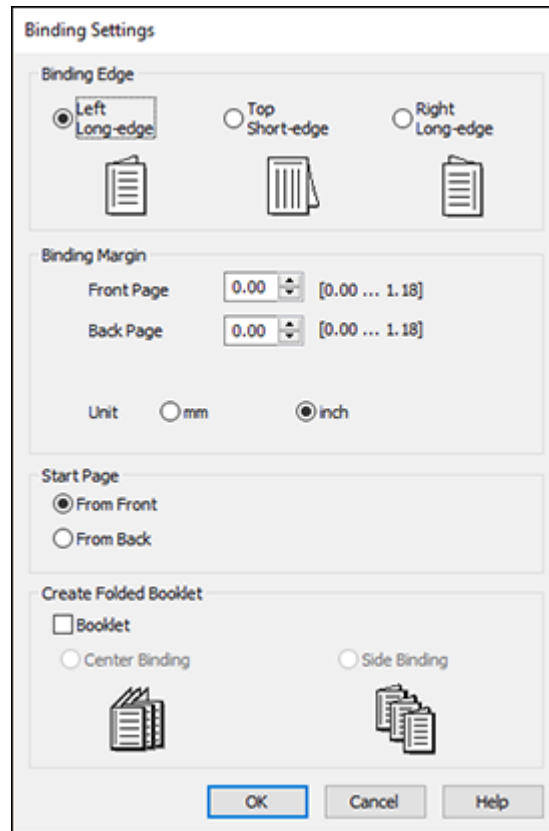

3. Select the double-sided printing options you want to use.
4. Click **OK** to return to the Main tab.
5. Click the **Print Density** button.

You see this window:

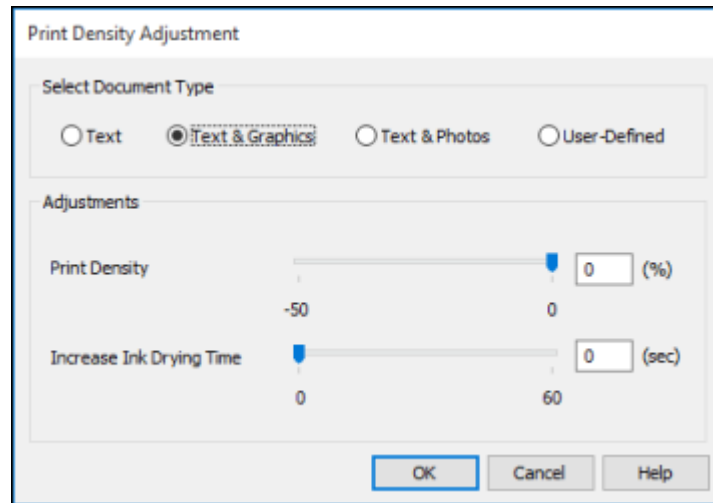

6. Select the type of document you are printing as the Document Type setting. The software automatically sets the Adjustments options for that document type.
7. Click **OK** to return to the Main tab.
8. Print a test copy of your double-sided document to test the selected settings.
9. Follow any instructions displayed on the screen during printing.

[Double-sided Printing Options - Windows](#)

[Print Density Adjustments - Windows](#)

Parent topic: [Printing with the Standard Epson Printer Software - Windows](#)

Related references

[Double-sided Printing Paper Types](#)

Related tasks

[Selecting Basic Print Settings - Windows](#)

Double-sided Printing Options - Windows

You can select any of the available options on the Binding Settings window to set up your double-sided print job.

Binding Edge Options

Select a setting that orients double-sided print binding in the desired direction.

Binding Margin Options

Select options that define a wider margin to allow for binding.

Start Page

Selects whether printing starts on the front or back page.

Create Folded Booklet Options

Select the **Booklet** checkbox and a binding option to print double-sided pages as a booklet.

Parent topic: [Selecting Double-sided Printing Settings - Windows](#)

Print Density Adjustments - Windows

You can select any of the available options on the Print Density Adjustment window to adjust the print quality of your double-sided print job.

Print Density

Sets the level of ink coverage for double-sided printing.

Increase Ink Drying Time

Sets the amount of time required for drying ink after printing on one side of the paper before printing the other side in double-sided printing to prevent ink smearing.

Parent topic: [Selecting Double-sided Printing Settings - Windows](#)

Selecting Additional Layout and Print Options - Windows

You can select a variety of additional layout and printing options for your document or photo on the **More Options** tab.

1. To change the size of your printed document or photo, select the **Reduce/Enlarge Document** checkbox and select one of these sizing options:
 - Select the **Fit to Page** option to size your image to fit the paper you loaded. Select the size of your document or photo as the Document Size setting, and the size of your paper as the Output Paper setting. If you want to center your image on the paper, select the **Center** option.
 - Select the **Zoom to** option to reduce or enlarge your document or photo by a specific percentage. Select the percentage in the % menu.
2. Select one of the following Color Correction options:
 - Select **Automatic** to automatically adjust the sharpness, brightness, contrast, and color saturation for your image.

- Select **Custom** and click the **Advanced** button to manually adjust the color correction settings or turn off color management in your printer software.
- Select **Image Options** to access additional settings for improving printed images.

Note: You can also select **Color Universal Print** settings.

3. To add the following features, click the **Watermark Features** button:

- **Anti-Copy Pattern:** adds a watermark that only appears when your printout is copied

Note: This setting is not available for all types of printing. Click the **Add/Delete** button to create your own pattern, and click the **Settings** button to customize the pattern.

- **Watermark:** adds a visible watermark to your printout

Note: Click the **Add/Delete** button to create your own watermark, and click the **Settings** button to customize the watermark.

- **Header/Footer:** adds information such as the date and time to the top or bottom of your printout

Note: Click the **Settings** button to customize the text and location of the header or footer.

4. To add a password to your print job, select the **Confidential Job** checkbox, then enter a password. Confidential jobs are stored in the product's memory without being printed. To print the job, enter the password for the confidential job on the product's control panel.

Note: Confidential print jobs are cleared from the product's memory after printing.

5. Select any of the Additional Settings options to customize your print.

[Custom Color Correction Options - Windows](#)

[Image Options and Additional Settings - Windows](#)

[Header/Footer Settings - Windows](#)

Parent topic: [Printing with the Standard Epson Printer Software - Windows](#)

Related tasks

[Printing Your Document or Photo - Windows](#)

Custom Color Correction Options - Windows

You can select any of the available options in the Color Correction window to customize the image colors for your print job.

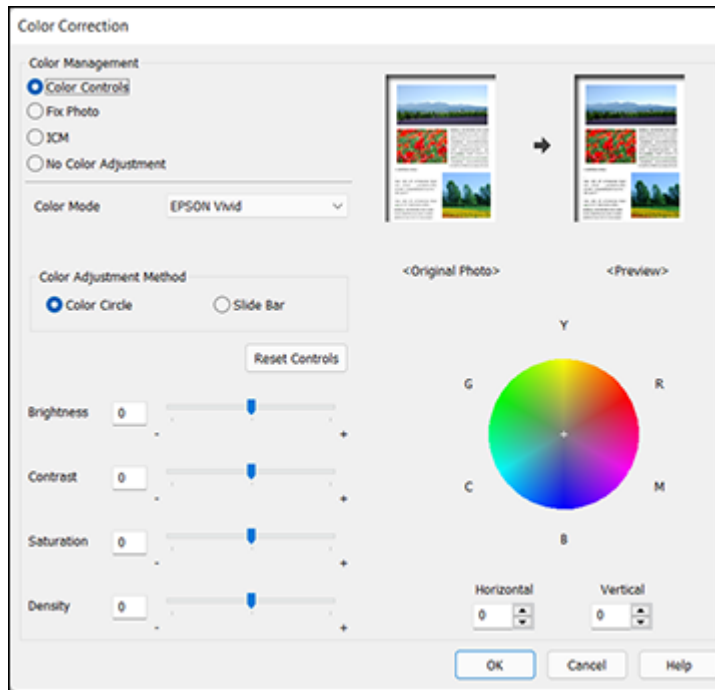

Color Controls

Lets you select a **Color Mode** setting, individual settings for **Brightness**, **Contrast**, **Saturation**, and **Density**, and individual color tones. Depending on the selected color mode, you can also adjust the midtone density using the **Gamma** setting.

Fix Photo

Improves the color, contrast, and sharpness of flawed photos.

Note: Fix Photo uses a sophisticated face recognition technology to optimize photos that include faces. For this to work, both eyes and the nose must be visible in the subject's face. If your photo includes a face with an intentional color cast, such as a statue, you may want to turn off **Fix Photo** to retain the special color effects.

ICM

Lets you manage color using installed color printing profiles.

No Color Adjustment

Turns off color management in your printer software so you can manage color using only your application software.

Parent topic: [Selecting Additional Layout and Print Options - Windows](#)

Image Options and Additional Settings - Windows

You can select any of the Image Options and Additional Settings to customize your print. Some options may be pre-selected or unavailable, depending on other settings you have chosen.

Image Options**Emphasize Text**

Adjusts the weight of printed text to increase readability.

Emphasize Thin Lines

Adjusts the weight of printed lines to increase visibility.

Edge Smoothing

Smooths jagged edges in low-resolution images such as screen captures or images from the Web.

Fix Red-Eye

Reduces or removes red-eye in photos.

Print Text in Black

Prints colored text in black.

For Color Text

Prints colored text on a background pattern or underlined.

For Color Graphs and Images

Prints colored graphics and images with overlay patterns.

For Color Text, Graphs, and Images

Prints colored text, graphics, and images with overlay patterns.

Enhancement Options

Specifies Color Universal Print enhancement settings for text, graphics, and images.

Additional Settings Options**Rotate 180°**

Prints the image rotated 180° from its original orientation.

Bidirectional Printing

Prints in both directions (right-to-left and left-to-right), speeding up printing, but may reduce print quality.

Mirror Image

Flips the printed image left to right.

Quiet Mode

Lessens noise during printing but may decrease print speed.

Parent topic: [Selecting Additional Layout and Print Options - Windows](#)

Header/Footer Settings - Windows

You can select any of the Header/Footer Settings options to add headers or footers when you print. The items are available to print at the top or bottom of your pages, in either the left, right, or center of the page.

Note: These settings are not saved with your document.

The screenshot shows a dialog box titled "Header/Footer Settings". It is organized into several sections:

- Top Left:** A dropdown menu set to "User Name".
- Top Center:** A dropdown menu set to "None".
- Top Right:** A dropdown menu set to "Date/Time".
- Bottom Left:** A dropdown menu set to "None".
- Bottom Center:** A dropdown menu set to "None".
- Bottom Right:** A dropdown menu set to "None".
- Starting number:** A spinner box set to "1".
- Start printing on page:** A spinner box set to "1".
- Text:** An empty text input field.
- Color:** A dropdown menu set to "Black".
- Font:** A dropdown menu set to "Arial".
- Size:** A spinner box set to "11 pt [6 ... 72]".
- Style:** A text box containing "Bold" and "Italic" options.

At the bottom of the dialog are four buttons: "Reset Defaults", "OK", "Cancel", and "Help".

You can select to print the following information:

- User Name
- Computer Name
- Date
- Date/Time
- Document Name
- Collate Number

- Page Number

Note: To specify the first page number, select **Page Number** from the position you want to print in the header or footer, then select the number in Starting number.

- Text

You can also adjust the text settings for the printed information.

Note: The user name, computer name, date, and time come from the Windows Control Panel on your computer.

Parent topic: [Selecting Additional Layout and Print Options - Windows](#)

Selecting a Printing Preset - Windows

For quick access to common groups of print settings, you can select a printing preset on the **Main** or **More Options** tab.

Note: You can create your own preset by clicking the **Add/Remove Presets** button.

1. Click the **Main** or **More Options** tab.

You see the available **Printing Presets** on the left:

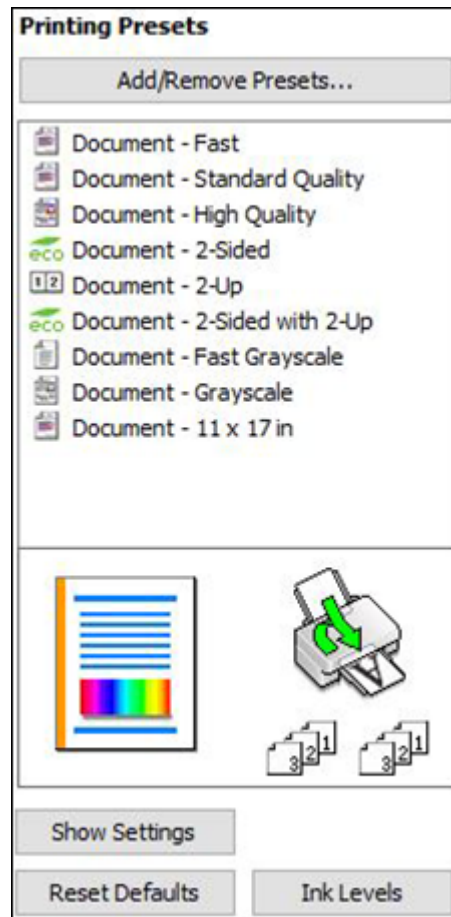



2. Place your cursor over one of the **Printing Presets** to view its list of settings.
3. Click on a preset to change its settings or delete it, or use any of the available options on the screen to control your printing presets.
4. To choose a preset for printing, select it.
5. Click **OK**.

Parent topic: [Printing with the Standard Epson Printer Software - Windows](#)

Selecting Extended Settings - Windows

You can select additional settings that apply to all the print jobs you send to your product.

1. Access the Windows Desktop and right-click the  icon for your product in the right side of the Windows taskbar, or click the up arrow and right-click .
2. Select **Printer Settings**.
3. Click the **Maintenance** tab.

You see the maintenance options:

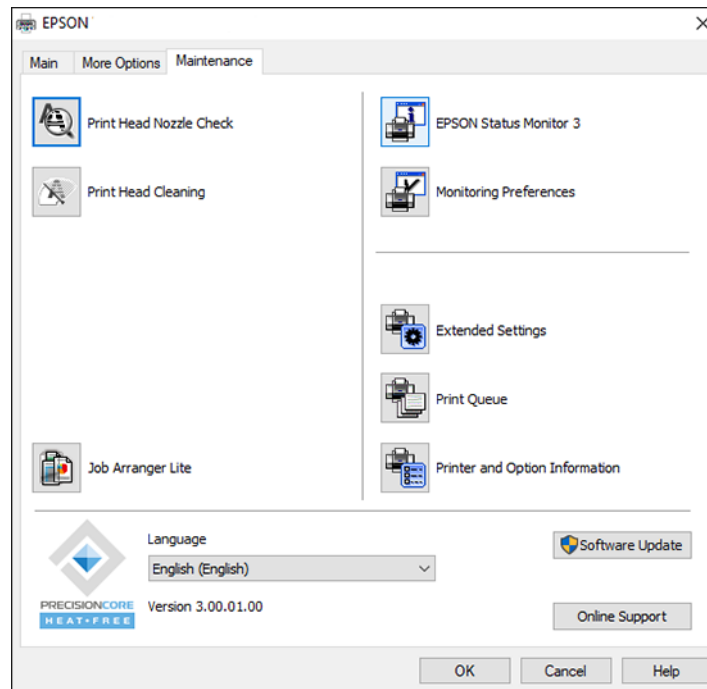

4. Click the **Extended Settings** button.

You see this window:

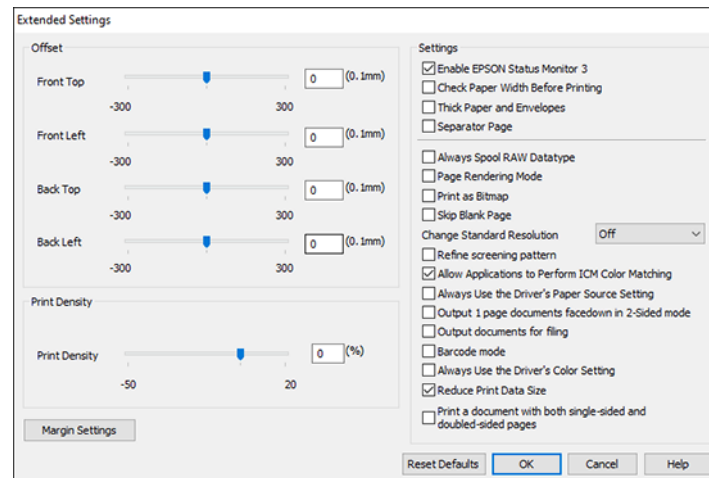

5. Select any of the extended settings to customize your print.
6. Click **OK** to close the Extended Settings window.
7. Click **OK** to close the printer software window.

[Extended Settings - Windows](#)

Parent topic: [Printing with the Standard Epson Printer Software - Windows](#)

Extended Settings - Windows

You can select these settings on the Extended Settings window.

Enable EPSON Status Monitor 3

Enables product monitoring for ink and paper supplies and other issues.

Check Paper Width Before Printing

Prevents printing beyond the edges of the paper if the paper size setting is incorrect; may reduce print speed.

Thick Paper and Envelopes

Prevents ink from smearing when you print on envelopes or other thick paper.

Short Grain Paper

Prevents ink from smearing when you print on envelopes or other thick paper, and the **Thick Paper** setting does not help.

Separator Page

Before each document, prints a separator page containing the title, user, date, and time.

Always Spool RAW Datatype

Increases print speed and may solve other printing problems.

Page Rendering Mode

Increases print speed when printing is extremely slow or the print head stops during printing.

Print as Bitmap

Increases print speed when printing is extremely slow or the print head stops during printing, and other settings do not help.

Skip Blank Page

Ensures that your product does not print pages that contain no text or images.

Change Standard Resolution

Reduces the resolution of print data to correct printing problems.

Refine screening pattern

Prints graphics with a finer screening pattern.

Allow Applications to Perform ICM Color Matching

Allows applications to perform ICM color matching.

Always Use the Driver's Paper Source Setting

Prints using the paper source setting in the printer driver, rather than the setting in your application.

Output 1 page documents facedown in 2-Sided mode

Outputs single-sided pages in a 2-sided print job facedown instead of faceup.

Output documents for filing

Outputs all landscape, portrait, 1-sided, and 2-sided documents in the same orientation for easier filing.

Barcode mode

Reduces bleeding when printing barcodes on plain paper, letterhead paper, recycled paper, preprinted paper, envelopes, and thick paper.

Always Use the Driver's Color Setting

Prioritizes color settings from the printer driver software.

Reduce Print Data Size

Increases print data compression to improve print speed. Not recommended when printing fine patterns.

Print a document with both single-sided and double-sided pages

Prints an entire document that contains both single- and double-sided pages.

Parent topic: [Selecting Extended Settings - Windows](#)

Printing Your Document or Photo - Windows

Once you have selected your print settings, you are ready to save your settings and print.

1. Click **OK** to save your settings.

You see your application's Print window, such as this one:

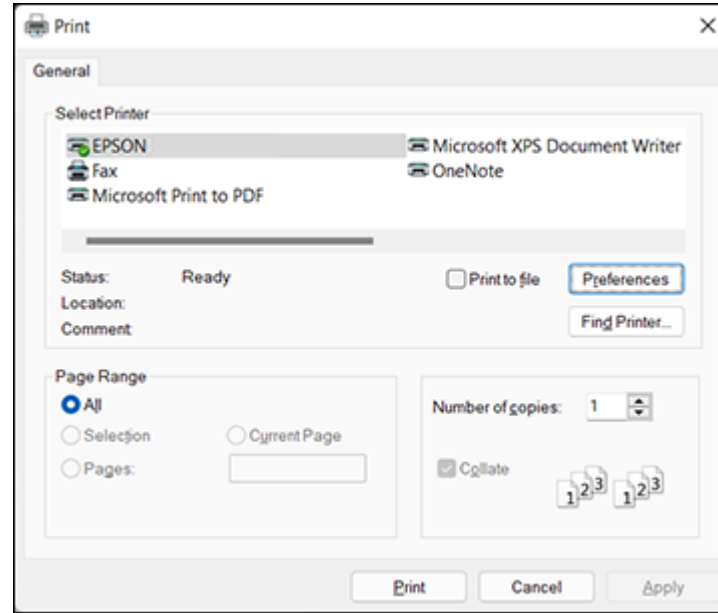

2. Click **OK** or **Print** to start printing.



Parent topic: [Printing with the Standard Epson Printer Software - Windows](#)

Locking Printer Settings - Windows

Windows administrators can lock access to some printer settings to prevent unauthorized changes.

1. Do one of the following:

- **Windows 11:** Click , search for **Settings** and select it. Select **Bluetooth & devices > Printers & scanners**. Select your product name and select **Printer properties**.

- **Windows 10:** Click  and select  (Settings) > **Devices** > **Printers & scanners**. Select your product name and select **Manage** > **Printer properties**.
- **Windows 8.x:** Navigate to the **Apps** screen and select **Control Panel** > **Hardware and Sound** > **Devices and Printers**. Right-click your product and select **Printer properties**.
- **Windows 7:** Click  and select **Devices and Printers**. Right-click your product and select **Printer properties**.

2. Click the **Optional Settings** tab.

Note: You can prevent access to the **Optional Settings** tab by changing the user or group permissions in the **Security** tab.

3. Click **Driver Settings**.

You see a window like this:

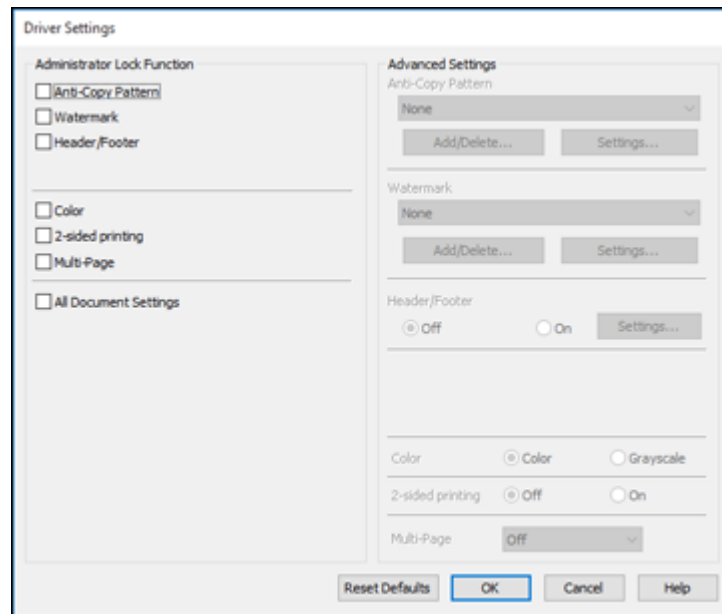

4. Select the checkbox for each setting you want to lock. To lock all print settings, select **All Document Settings**.

5. Under **Advanced Settings**, select the setting option you want to use for each locked setting.
6. Click **OK**.

[Locked Setting Options](#)

Parent topic: [Printing with the Standard Epson Printer Software - Windows](#)

Locked Setting Options

Select the options you want to use for any locked print settings.

Setting	Options	Description
Anti-Copy Pattern	Various data items	Lets you select the data to use for the pattern or prohibit anti-copy patterns
	Add/Delete	Lets you add or delete a customized anti-copy pattern
	Settings	Lets you select the arrangement, size, and other settings for the custom anti-copy pattern
Watermark	Various text watermarks	Lets you select the text for the watermark or prohibit watermarks
	Add/Delete	Lets you add or delete a customized text or image-based watermark
	Settings	Lets you select the size, position, and other watermark settings
Header/Footer	Off	Prohibits headers or footers
	On	Allows headers and footers
	Settings	Lets you select the text and position for printing headers and footers
Color	Color	Allows color printing
	Grayscale	Allows printing in black or shades of gray only
2-sided printing	Off	Allows printing on one side of the paper only
	On	Allows printing on both sides of the paper



Setting	Options	Description
Multi-Page	Off	Prohibits multi-page settings
	2-Up	Allows printing of 2 pages on one sheet of paper
	4-Up	Allows printing of 4 pages on one sheet of paper
	6-Up	Allows printing of 6 pages on one sheet of paper
	8-Up	Allows printing of 8 pages on one sheet of paper
	9-Up	Allows printing of 9 pages on one sheet of paper
	16-Up	Allows printing of 16 pages on one sheet of paper

Parent topic: [Locking Printer Settings - Windows](#)

Entering a User ID and Password for Printing

If you enabled Access Control on the product, you must enter a user ID and password in the printer driver to be able to print.

Note: If you do not know the user ID or password, contact your administrator for assistance.

1. Access the Windows Desktop and right-click the  icon for your product in the right side of the Windows taskbar, or click the up arrow and right-click . Select **Printer Settings** and click the **Maintenance** tab.

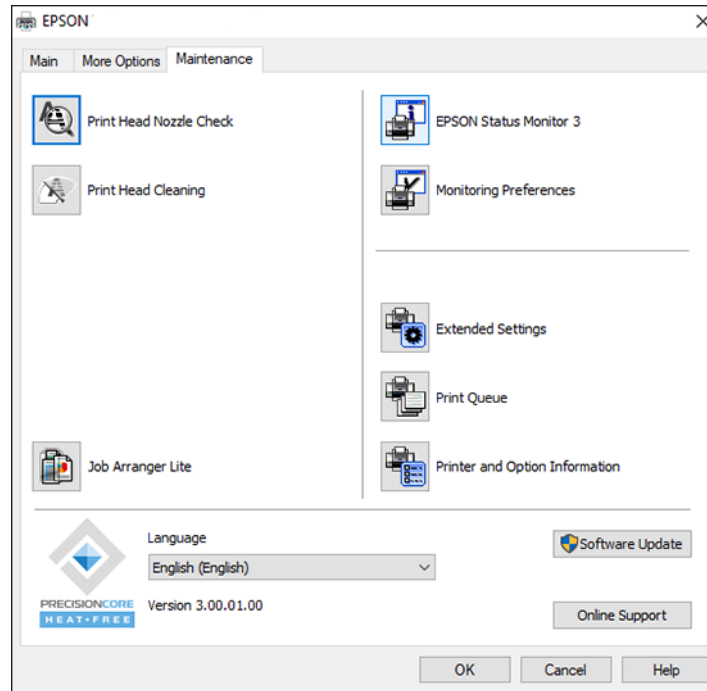



2. Click the **Printer and Option Information** button.
3. Select the **Save Access Control settings** checkbox.
4. Click the **Settings** button.
5. Enter your user name and password.
6. Click **OK**.

Parent topic: [Printing with the Standard Epson Printer Software - Windows](#)

Selecting Default Print Settings - Windows

When you change your print settings in a program, the changes apply only while you are printing in that program session. If you want to change the print settings you use in all your Windows programs, you can select new default print settings.

1. Access the Windows Desktop and right-click the  icon for your product in the right side of the Windows taskbar, or click the up arrow and right-click .
2. Select **Printer Settings**.

You see a printer settings window like this:

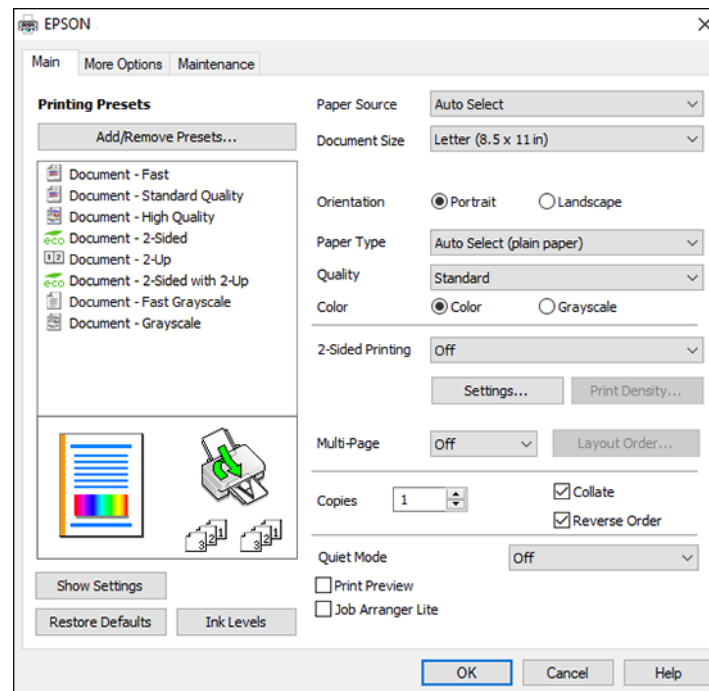

3. Select the print settings you want to use as defaults in all your Windows programs.
4. Click **OK**.



These settings are now the defaults selected for printing. You can still change them as needed for printing in any program session.

Changing the Language of the Printer Software Screens

Parent topic: [Printing with the Standard Epson Printer Software - Windows](#)

Changing the Language of the Printer Software Screens

You can change the language used on the Windows printer software screens.

1. Access the Windows Desktop and right-click the  icon for your product in the right side of the Windows taskbar, or click the up arrow and right-click .

2. Select **Printer Settings**.

You see the printer settings window.

3. Click the **Maintenance** tab.

You see the maintenance options:

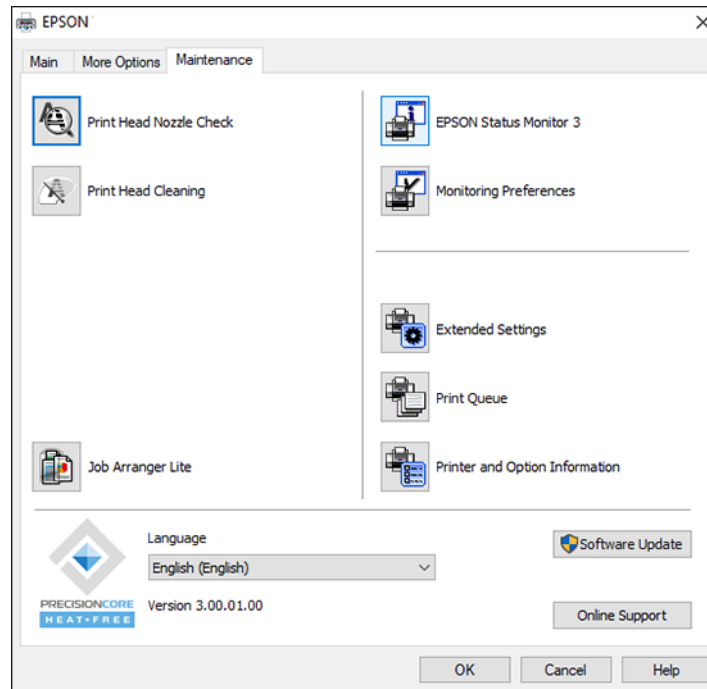

4. Select the language you want to use as the **Language** setting.



5. Click **OK** to close the printer software window.

The printer software screens appear in the language you selected the next time you access them.

Parent topic: [Selecting Default Print Settings - Windows](#)

Changing Automatic Update Options

Your printer software for Windows automatically checks for updates to the product software. You can change how often the software checks for updates or disable this feature.

1. Access the Windows Desktop and right-click the  icon for your product in the right side of the Windows taskbar, or click the up arrow and right-click .
2. Select **Software Update Settings**.

You see a window like this:

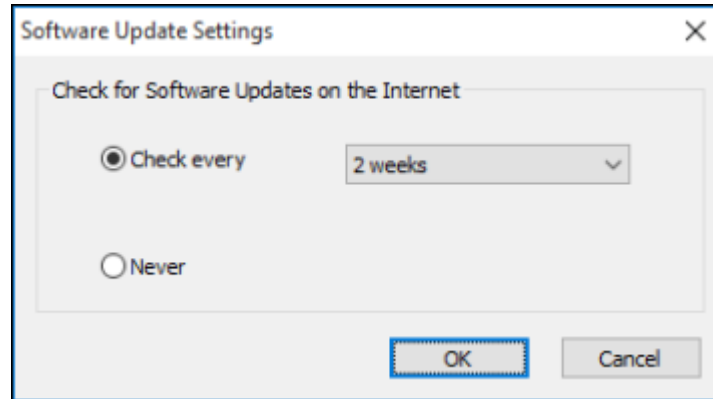

3. Do one of the following:
 - To change how often the software checks for updates, select a setting in the **Check every** menu.
 - To disable the automatic update feature, select the **Never** option.
4. Click **OK** to exit.

Note: If you choose to disable the automatic update feature, you can check for updates manually.

Parent topic: [Printing with the Standard Epson Printer Software - Windows](#)

Printing with the Epson Standard Printer Software - Mac

You can print with your product using any Mac printing program, as described in these sections.

Note: If you have an Internet connection, it is a good idea to check for updates to your product software on Epson's support website.

[Selecting Basic Print Settings - Mac](#)

[Selecting Page Setup Settings - Mac](#)

[Selecting Print Layout Options - Mac](#)

[Selecting Double-sided Printing Settings - Mac](#)

[Managing Color - Mac](#)

[Selecting Printing Preferences - Mac](#)

[Printing Your Document or Photo - Mac](#)

Parent topic: [Printing from a Computer](#)

Related references

[Paper or Media Type Settings - Printing Software](#)

Related tasks

[Selecting Page Setup Settings - Mac](#)

Selecting Basic Print Settings - Mac

Select the basic settings for the document or photo you want to print.

1. Open a photo or document for printing.
2. Select the print command in your application.

Note: You may need to select a print icon on your screen, the **Print** option in the File menu, or another command. See your application's help utility for details.

3. Select your product as the **Printer** setting.

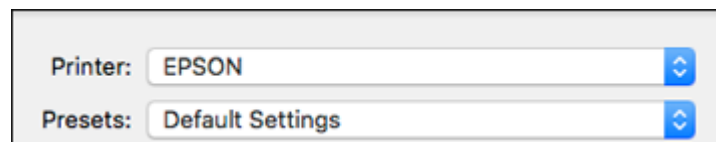

4. If necessary, click the arrow next to the Printer setting or the **Show Details** button to expand the print window.

You see the expanded printer settings window for your product:

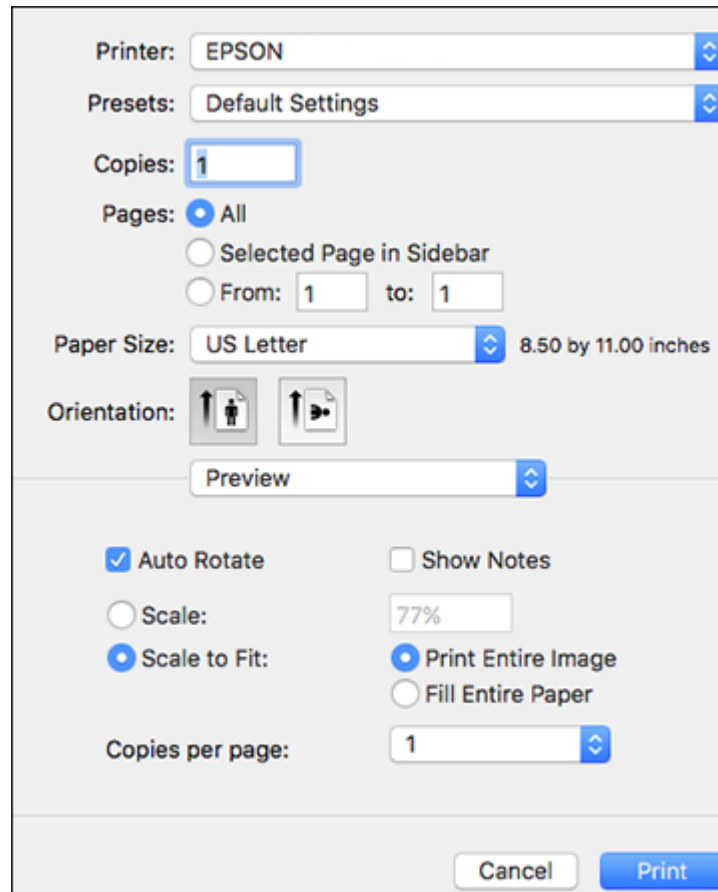

The screenshot shows a print dialog box with the following settings:

- Printer: EPSON
- Presets: Default Settings
- Copies: 1
- Pages: All, Selected Page in Sidebar, From: 1 to: 1
- Paper Size: US Letter (8.50 by 11.00 inches)
- Orientation: Portrait (selected), Landscape
- Preview: (dropdown menu)
- Auto Rotate, Show Notes
- Scale: 77%, Scale to Fit
- Print Entire Image, Fill Entire Paper
- Copies per page: 1
- Buttons: Cancel, Print

Note: The print window may look different, depending on the Mac OS version and the application you are using.

5. Select the **Copies** and **Pages** settings as necessary.

Note: If you do not see these settings in the print window, check for them in your application before printing.

6. Select the page setup options: **Paper Size** and **Orientation**.

Note: If you do not see these settings in the print window, check for them in your application before printing. They may be accessible by selecting **Page Setup** from the File menu.

7. Select any application-specific settings that appear on the screen, such as those shown in the image above for the Preview application.
8. Select **Print Settings** or **Printer Features** from the pop-up menu.

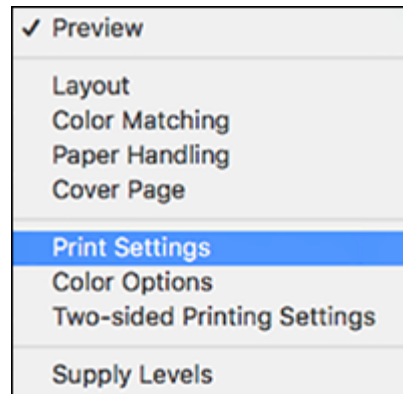

You see these settings:

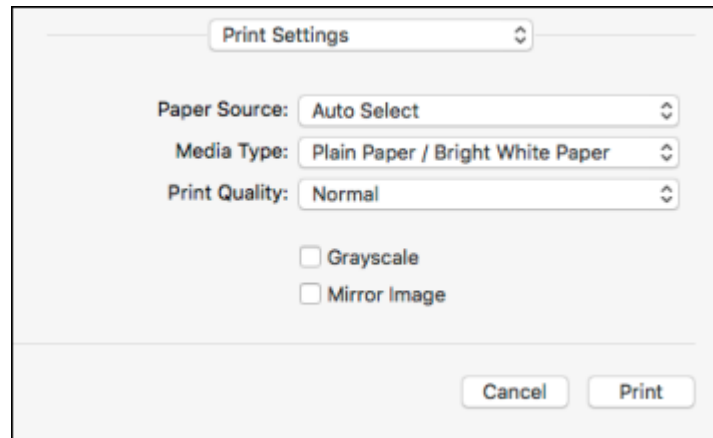

9. Select the **Paper Source** you wish to print from.
10. Select the type of paper you loaded as the **Media Type** setting.

Note: The setting may not exactly match the name of your paper. Check the paper type settings list for details.

11. Select the **Print Quality** setting you want to use.
12. Select any of the available print options.

[Paper Source Options - Mac](#)

[Print Quality Options - Mac](#)

[Print Options - Mac](#)

Parent topic: [Printing with the Epson Standard Printer Software - Mac](#)

Paper Source Options - Mac

You can select any of the available options in the Paper Source menu to print on the paper loaded in that source.

Auto Select

Automatically selects the paper source based on the selected paper size.

Cassette 1

Selects the paper in cassette 1 as the paper source.

Cassette 2

Selects the paper in cassette 2 as the paper source.

Cassette 3

Selects the paper in cassette 3 as the paper source.

Cassette 4

Selects the paper in cassette 4 as the paper source.

Rear Paper Feed Slot

Selects the paper in the rear feed slot as the paper source.

Parent topic: [Selecting Basic Print Settings - Mac](#)

Print Quality Options - Mac

You can select any of the available Print Quality options to fine-tune the quality of your print. Some settings may be unavailable, depending on the paper type setting you have chosen.

Draft

For draft printing on plain paper.

Normal

For everyday text and image printing.

Fine

For text and graphics with good quality and print speed.

Best Quality

For the best print quality, but the slowest print speed.

Parent topic: [Selecting Basic Print Settings - Mac](#)

Print Options - Mac

You can select any of the print options to customize your print. Some options may be unavailable, depending on other settings you have chosen.

Grayscale

Prints text and graphics in black or shades of gray.

Mirror Image

Lets you flip the printed image horizontally.

Parent topic: [Selecting Basic Print Settings - Mac](#)

Selecting Page Setup Settings - Mac

Depending on your application, you may be able to select the paper size and orientation settings from the print window.

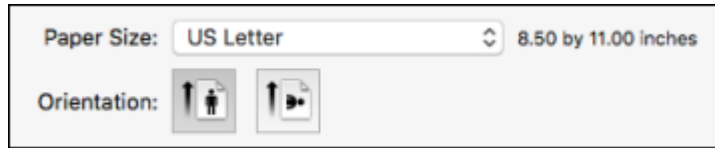

Note: If you do not see these settings in the print window, check for them in your application before printing. They may be accessible by selecting **Page Setup** from the File menu.

1. Select the size of the paper you loaded as the **Paper Size** setting.
2. Select the orientation of your document or photo as shown in the print window.

Note: If you are printing an envelope, select the  icon or **Landscape** setting.

Note: You can reduce or enlarge the size of the printed image by selecting **Paper Handling** from the pop-up menu and selecting a scaling option.

Parent topic: [Printing with the Epson Standard Printer Software - Mac](#)

Selecting Print Layout Options - Mac

You can select a variety of layout options for your document or photo by selecting **Layout** from the pop-up menu on the print window.



- To print multiple pages on one sheet of paper, select the number of pages in the **Pages per Sheet** pop-up menu. To arrange the print order of the pages, select a **Layout Direction** setting.
- To print borders around each page on the sheet, select a line setting from the **Border** pop-up menu.
- To print on both sides of each page, select a setting from the **Two-Sided** pop-up menu.
- To invert or flip the printed image, select the **Reverse page orientation** or **Flip horizontally** settings.

Parent topic: [Printing with the Epson Standard Printer Software - Mac](#)

Selecting Double-sided Printing Settings - Mac

You can print on both sides of the paper by selecting **Two-sided Printing Settings** from the pop-up menu on the print window.

Note: For macOS 13 and later, select **Printer Options** then select **Two-sided Printing Settings**.

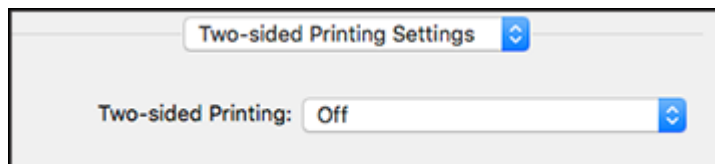

Note: Some options may be pre-selected or unavailable, depending on other settings you have chosen or if you are accessing the product over a network. This screen may be different, depending on the Mac OS version you are using.

1. Select one of the **Two-sided Printing** options.
2. Select the type of document you are printing as the **Document Type** setting. The software automatically sets the Adjustments options for that document type.

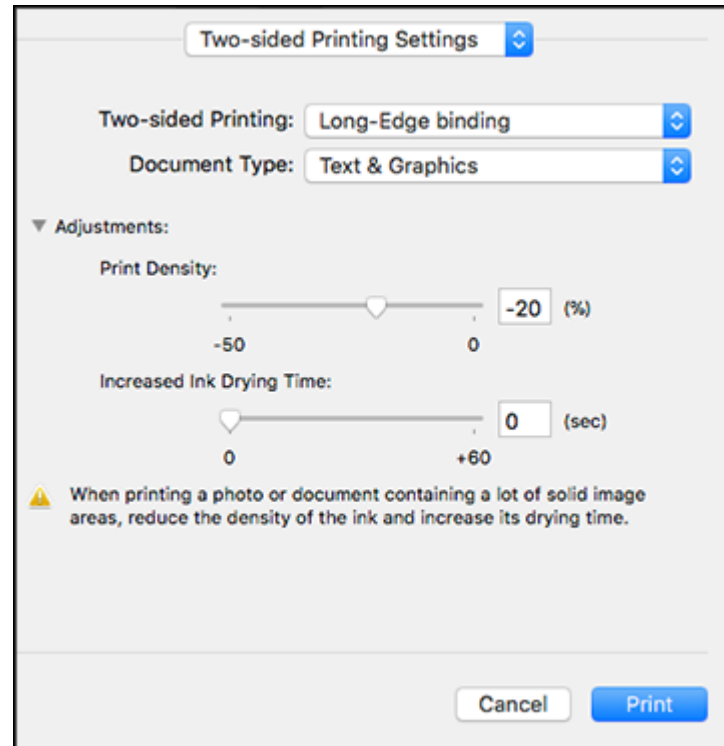

3. If necessary, customize the Adjustments settings as instructed on the screen.
4. Print a test copy of your double-sided document to test the selected settings.
5. Follow any instructions displayed on the screen during printing.

[Double-sided Printing Options and Adjustments - Mac](#)

Parent topic: [Printing with the Epson Standard Printer Software - Mac](#)

Related references

[Double-sided Printing Paper Types](#)

Double-sided Printing Options and Adjustments - Mac

You can select any of the available options in the **Two-sided Printing Settings** pop-up menu to set up your double-sided print job.

Long-Edge binding

Orients double-sided printed pages to be bound on the long edge of the paper.

Short-Edge binding

Orients double-sided printed pages to be bound on the short edge of the paper.

Print Density

Sets the level of ink coverage for double-sided printing.

Increased Ink Drying Time

Sets the amount of time required for drying ink after printing on one side of the paper before printing the other side in double-sided printing.

Parent topic: [Selecting Double-sided Printing Settings - Mac](#)

Managing Color - Mac

You can adjust the Color Matching and Color Options settings to fine-tune the colors in your printout or turn off color management in your printer software.

1. Select **Color Matching** from the pop-up menu in the print window.

Note: For macOS 13 and later, select **Printer Options** then select **Color Matching**.



2. Select one of the available options.

3. Select **Color Options** from the pop-up menu in the print window.

Note: For macOS 13 and later, select **Printer Options** then select **Color Options**.

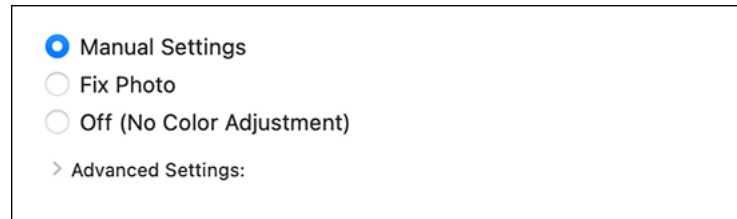

Note: The available settings on the Color Options menu depend on the option you selected on the Color Matching menu.

4. Select one of the available options.

[Color Matching and Color Options - Mac](#)

Parent topic: [Printing with the Epson Standard Printer Software - Mac](#)

Color Matching and Color Options - Mac

You can select these settings on the **Color Matching** and **Color Options** menus.

Color Matching Settings

EPSON Color Controls

Lets you manage color using controls in your printer driver or turn off color management.

ColorSync

Prints using standard color profiles for your product and paper to help match image colors. You can customize the conversion method and filter settings on the ColorSync pop-up menu in the print window.

Color Options Settings

Manual Settings

Lets you select manual color adjustments. Click the arrow next to **Advanced Settings** and select settings for **Brightness**, **Contrast**, **Saturation**, and individual color tones. You can also select a color **Mode** setting for printing photos and graphics and the **Fix Red-Eye** setting to reduce or remove red-eye in photos. Depending on the selected color mode, you can also adjust the midtone density using the **Gamma** setting.

Fix Photo

Improves the color, contrast, and sharpness of flawed photos. Click the arrow next to **Advanced Settings** and select the **Fix Red-Eye** setting to reduce or remove red-eye in photos.

Note: Fix Photo uses a sophisticated face recognition technology to optimize photos that include faces. For this to work, both eyes and the nose must be visible in the subject's face. If your photo includes a face with an intentional color cast, such as a statue, you may want to turn off **Fix Photo** to retain the special color effects.

Off (No Color Adjustment)

Turns off color management in your printer software so you can manage color using only your application software.

Note: An ICC profile is required if color management is turned off.

Parent topic: [Managing Color - Mac](#)

Selecting Printing Preferences - Mac

You can select printing preferences that apply to all the print jobs you send to your product.

1. In the Apple menu or the Dock, select **System Preferences** or **System Settings**.
2. Select **Print & Fax**, **Print & Scan**, or **Printers & Scanners**, select your product, and select **Options & Supplies**.
3. Select **Driver** or **Options**.

You see a screen like this:

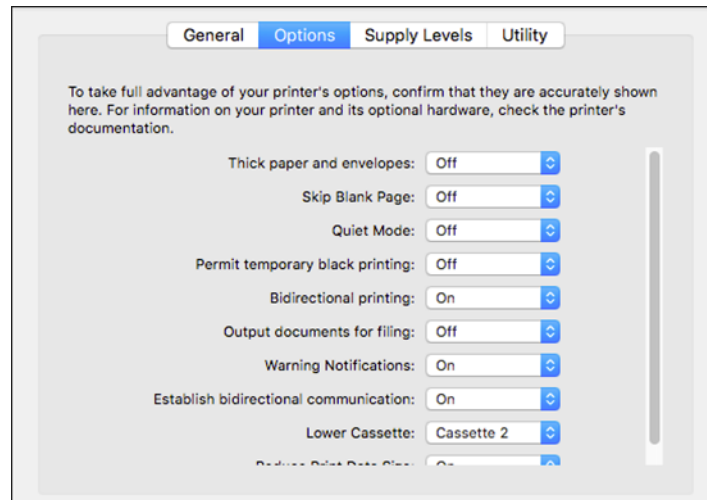

Note: The available settings and appearance of the options window may be different than those covered here, depending on the Mac OS version and the application you are using.

4. Select any of the available printing preferences.
5. Click **OK**.

[Printing Preferences - Mac](#)

Parent topic: [Printing with the Epson Standard Printer Software - Mac](#)

Printing Preferences - Mac

You can select these settings on the **Options** or **Driver** tab.

Thick Paper and Envelopes

Prevents ink from smearing when you print on envelopes or other thick paper.

Skip Blank Page

Ensures that your product does not print pages that contain no text or images.

Quiet Mode

Lessens noise during printing but may decrease print speed.

Permit temporary black printing

Allows you to print using black ink when color ink is expended.

Bidirectional printing

Prints in both directions (right-to-left and left-to-right), speeding up printing, but may reduce print quality.

Output documents for filing

Outputs all landscape, portrait, 1-sided, and 2-sided documents in the same orientation for easier filing.

Warning Notifications

Lets you choose whether or not to receive warning notifications from the printer software for various operating conditions.

Establish bidirectional communication

Allows the product to communicate with the computer. Do not change the default setting unless you experience issues when using a shared printing pool.

Reduce Print Data Size

Increases print data compression to improve print speed. Not recommended when printing fine patterns.

Lower Cassette

Specifies whether the optional cassette is present.

Parent topic: [Selecting Printing Preferences - Mac](#)

Printing Your Document or Photo - Mac

Once you have selected your print settings, you are ready to print.

Click **Print** at the bottom of the print window.

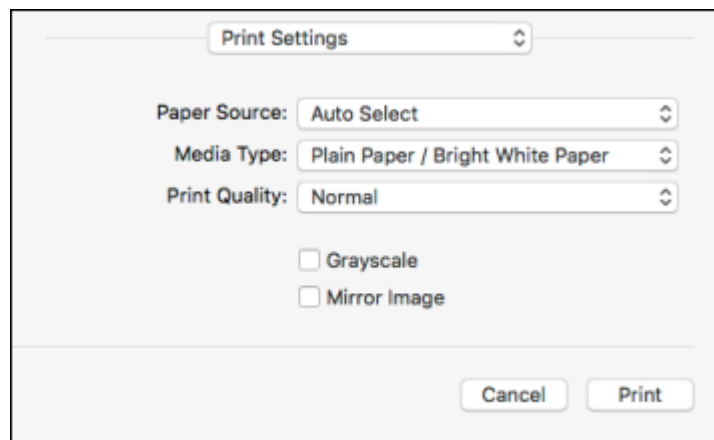

[Checking Print Status - Mac](#)

Parent topic: [Printing with the Epson Standard Printer Software - Mac](#)

Checking Print Status - Mac



During printing, you can view the progress of your print job, control printing, and check ink status.

1. Click the printer icon when it appears in the Dock.

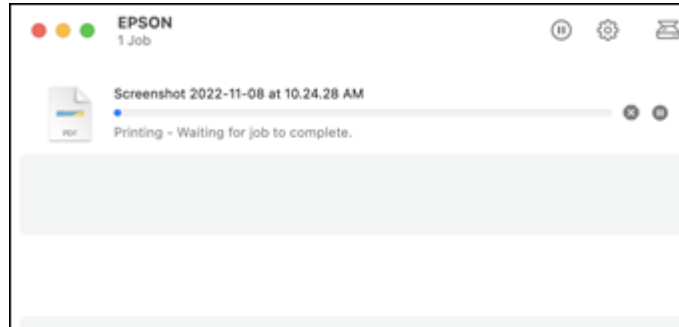
You see the print status window:



2. Select the following options as necessary for your Mac OS version:

- To cancel printing, click the print job and click  or **Delete**.
- To pause a print job, click the print job and click  or **Hold**. To resume a print job, click the paused print job and click  or **Resume**.
- To pause printing for all queued print jobs, click **Pause** or **Pause Printer**.
- To display other printer information, click **Settings** or **Supply Levels**.

Parent topic: [Printing Your Document or Photo - Mac](#)

Printing with the Epson Universal Print Driver - Windows

You can print with the Epson Universal Print Driver using any Windows printing program, as described in these sections.

[Synchronizing Printer Settings - Epson Universal Print Driver - Windows](#)

[Selecting Print Settings - Epson Universal Print Driver - Windows](#)

[Selecting Default Print Settings - Epson Universal Print Driver - Windows](#)

[Locking Printer Settings - Epson Universal Print Driver - Windows](#)





[Adding Network Printers - Epson Universal Print Driver - Windows](#)

Parent topic: [Printing from a Computer](#)

Synchronizing Printer Settings - Epson Universal Print Driver - Windows

You may need to synchronize the printer driver with the product if the printer driver does not detect the correct information or settings from the product.

Note: You must sync the printer driver before you can use any optional equipment installed on the product.

1. Do one of the following:
 - **Windows 11:** Click  and select **Settings > Bluetooth & devices > Printers & scanners**. Select **EPSON Universal Print Driver** and select **Printer properties**.
 - **Windows 10:** Click  and select  (Settings) > **Devices > Printers & scanners**. Select **EPSON Universal Print Driver** and select **Manage > Printer properties**.
 - **Windows 8.x:** Navigate to the **Apps** screen and select **Control Panel > Hardware and Sound > Devices and Printers**. Right-click **EPSON Universal Print Driver** and select **Printer properties**.
 - **Windows 7:** Click  and select **Devices and Printers**. Right-click **EPSON Universal Print Driver** and select **Printer properties**.
2. Click the **Optional Settings** tab.

You see a window like this:

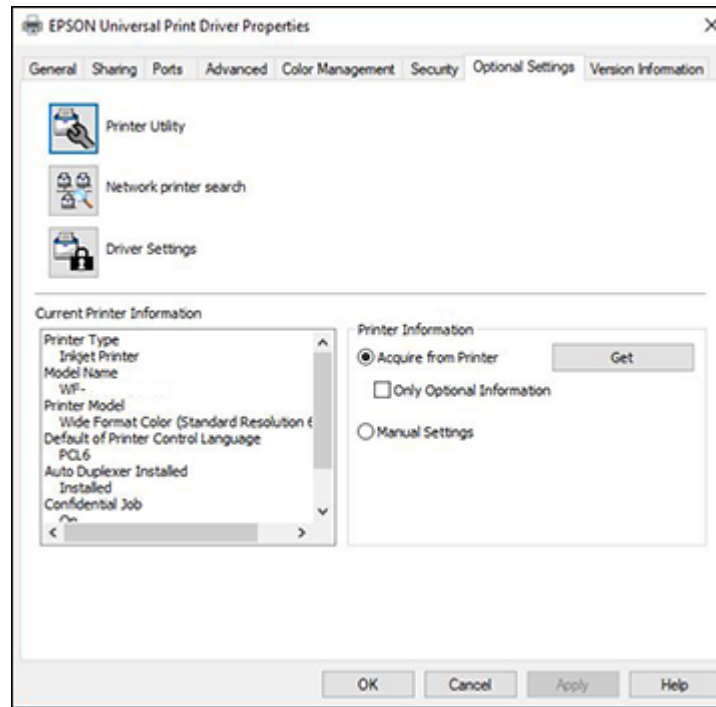

3. Make sure **Acquire from Printer** is selected and click **Get**.

Note: Select the **Only Optional Information** checkbox if you only want to enable any optional equipment installed on the product.

The product's settings and other information appears in the Current Printer Information area.

4. Click **OK**.

Parent topic: [Printing with the Epson Universal Print Driver - Windows](#)

Related tasks

[Enabling the Optional Paper Cassettes - Windows](#)

Selecting Print Settings - Epson Universal Print Driver - Windows

Select the basic settings for the document or photo you want to print.

Note: The names of settings on the universal print driver screens may vary slightly, depending on the version of the print driver you have installed.

1. Open a photo or document for printing.
2. Select the print command in your application.

Note: You may need to select a print icon on your screen, the **Print** option in the **File** menu, or another command. See your application's help utility for details.

3. If necessary, select **EPSON Universal Print Driver** as the printer you want to use.

Note: You may also need to select **Properties** or **Preferences** to view your print settings.

You see the **Main** tab of a printer settings window like this:

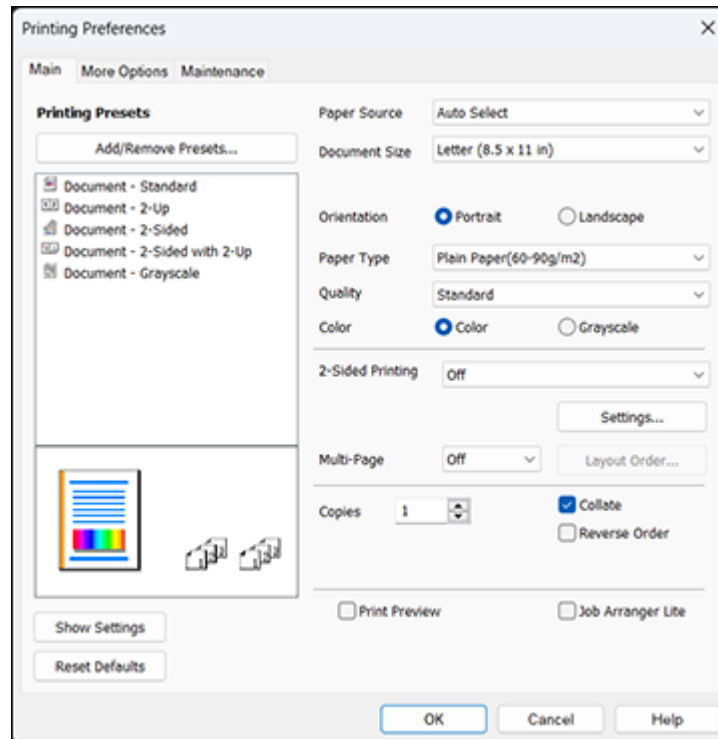

Note: For more information about a setting, right-click it and select **Help**.

4. For the **Paper Source** setting, select where you loaded the paper you want to print on.
5. Select the size of the paper you loaded as the **Document Size** setting.

Note: You can also select the **User-Defined** setting to create a custom paper size.

6. Select the orientation of your document.

Note: If you are printing an envelope, select **Landscape**.

7. Select the type of paper you loaded as the **Paper Type** setting.





Note: The setting may not exactly match the name of your paper. Check the paper type settings list for details.

8. Select any of the available print options.
9. To select a variety of additional layout and printing options for your document or photo, select the **More Options** tab and select the printing options you want.
10. To select maintenance and other optional settings, select the **Maintenance** tab and select the options you want.

Parent topic: [Printing with the Epson Universal Print Driver - Windows](#)

Selecting Default Print Settings - Epson Universal Print Driver - Windows

When you change your print settings in a program, the changes apply only while you are printing in that program session. If you want to change the print settings you use in all your Windows programs, you can select new default print settings.

1. Do one of the following:
 - **Windows 10:** Click  and select  (Settings) > **Devices** > **Printers & scanners**. Select **EPSON Universal Print Driver** and select **Manage** > **Printing Preferences**.
 - **Windows 8.x:** Navigate to the **Apps** screen and select **Control Panel** > **Hardware and Sound** > **Devices and Printers**. Right-click **EPSON Universal Print Driver** and select **Print Preferences**.
 - **Windows 7:** Click  and select **Devices and Printers**. Right-click **EPSON Universal Print Driver** and select **Printing Preferences**.
 - **Windows Vista:** Click  and select **Control Panel**. Click **Printer** under **Hardware and Sound**, right-click **EPSON Universal Print Driver**, and select **Printing Preferences**.

You see the printer settings window:

Note: For more information about a setting, right-click it and select **Help**.





2. Select the print settings you want to use as defaults in all your Windows programs.
3. Click **OK**.

These settings are now the defaults selected for printing. You can still change them as needed for printing in any program session.

Parent topic: [Printing with the Epson Universal Print Driver - Windows](#)

Locking Printer Settings - Epson Universal Print Driver - Windows

Administrators can lock some printer settings to prevent unauthorized changes.

1. Do one of the following:
 - **Windows 11:** Click  and select **Settings > Bluetooth & devices > Printers & scanners**. Select **EPSON Universal Print Driver** and select **Printer properties**.
 - **Windows 10:** Click  and select  (Settings) > **Devices > Printers & scanners**. Select **EPSON Universal Print Driver** and select **Manage > Printer properties**.
 - **Windows 8.x:** Navigate to the **Apps** screen and select **Control Panel > Hardware and Sound > Devices and Printers**. Right-click **EPSON Universal Print Driver** and select **Printer properties**.
 - **Windows 7:** Click  and select **Devices and Printers**. Right-click **EPSON Universal Print Driver** and select **Printer properties**.
2. Click the **Optional Settings** tab.
3. Click **Driver Settings**.

You see this window:

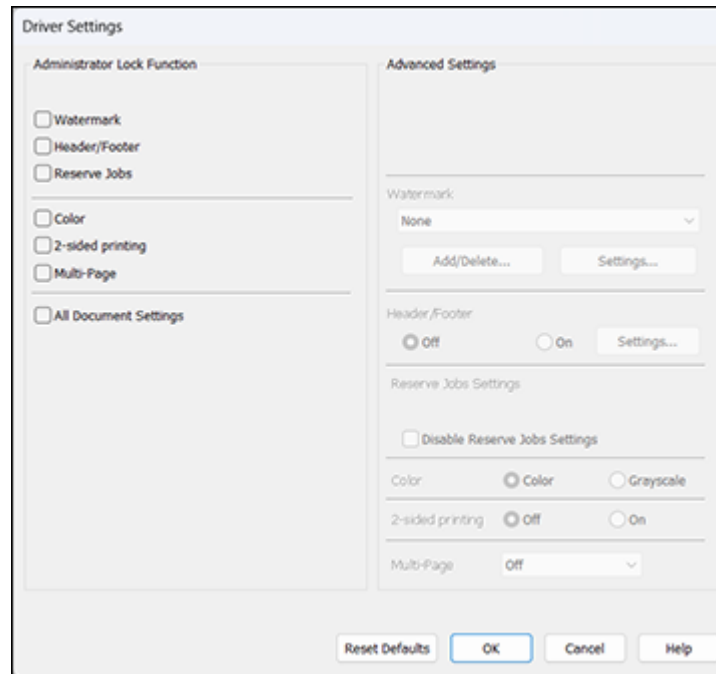

4. Select the checkbox for the settings you want to lock. To lock all print settings, select **All Document Settings**.
5. Under **Advanced Settings**, select the setting option you want to use for each locked setting.
6. Click **OK**.

[Epson Universal Print Driver Locked Setting Options](#)

Parent topic: [Printing with the Epson Universal Print Driver - Windows](#)

Epson Universal Print Driver Locked Setting Options

Select the options you want to use for any locked print settings.

Setting	Options	Description
Watermark	Various text watermarks	Lets you select the text for the watermark or prohibit watermarks
	Add/Delete	Lets you add or delete a customized text or image-based watermark
	Settings	Lets you select the size, position, and other watermark settings
Header/Footer	Off	Prohibits headers or footers
	On	Allows headers and footers
	Settings	Lets you select the text and position for printing headers and footers
Color	Color	Allows color printing
	Grayscale	Allows printing in black or shades of gray only
2-sided printing	Off	Allows printing on only one side of the paper
	On	Allows printing on both sides of the paper
Multi-Page	Off	Prohibits multi-page settings
	2-Up	Allows printing of 2 pages on one sheet of paper
	4-Up	Allows printing of 4 pages on one sheet of paper
	6-Up	Allows printing of 6 pages on one sheet of paper
	8-Up	Allows printing of 8 pages on one sheet of paper
	9-Up	Allows printing of 9 pages on one sheet of paper
	16-Up	Allows printing of 16 pages on one sheet of paper



Parent topic: [Locking Printer Settings - Epson Universal Print Driver - Windows](#)

Adding Network Printers - Epson Universal Print Driver - Windows

You can use the Epson Universal Print Driver to find and add network printers.

1. Do one of the following:

- **Windows 11:** Click  and select **Settings > Bluetooth & devices > Printers & scanners**. Select **EPSON Universal Print Driver** and select **Printer properties**.

- **Windows 10:** Click  and select  (Settings) > **Devices > Printers & scanners**. Select **EPSON Universal Print Driver** and select **Manage > Printer properties**.
- **Windows 8.x:** Navigate to the **Apps** screen and select **Control Panel > Hardware and Sound > Devices and Printers**. Right-click **EPSON Universal Print Driver** and select **Printer properties**.
- **Windows 7:** Click  and select **Devices and Printers**. Right-click **EPSON Universal Print Driver** and select **Printer properties**.

2. Click the **Optional Settings** tab.

You see this window:

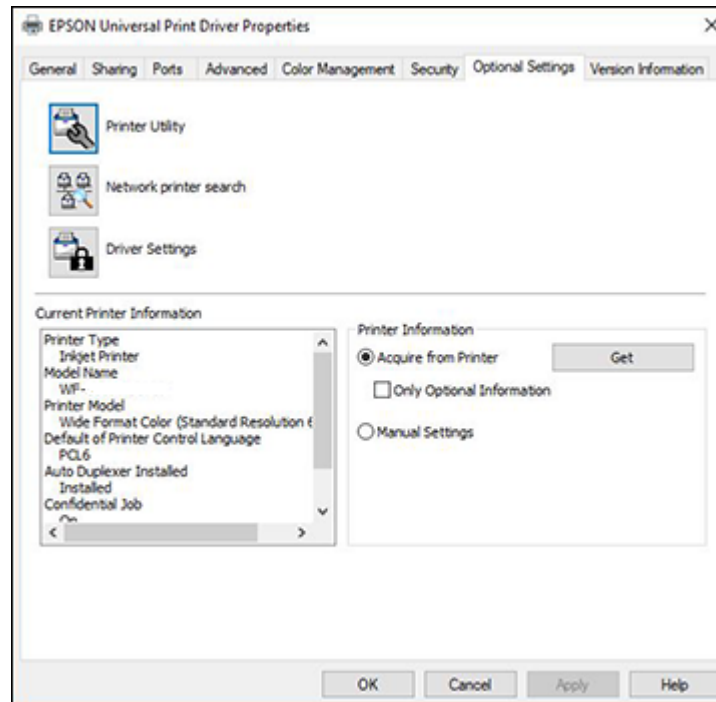

3. Click **Network printer search**.

4. When you see the search results, select **Add found printers**.

You see a screen like this:

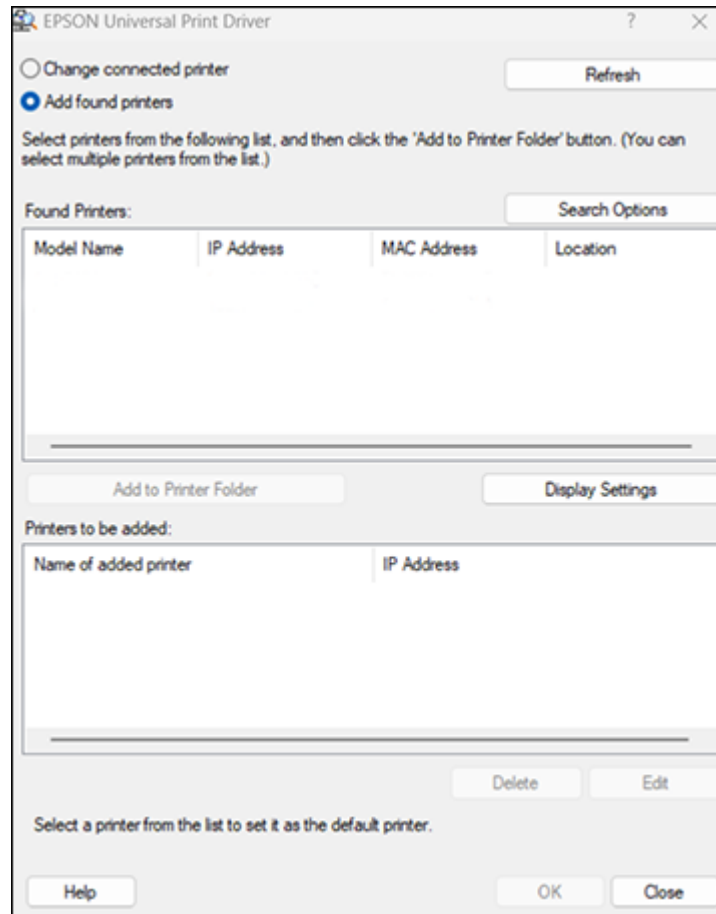

5. Select the printer or printers you want to add.
6. Click **Add to Printer Folder**.
The selected printer or printers appear in the lower section of the screen.
7. Select the checkbox next to the product you want to make your default printer, if necessary.
8. Click **OK**.

Parent topic: [Printing with the Epson Universal Print Driver - Windows](#)

Printing with the PostScript (PS3) Printer Software - Windows

You can print with the PostScript (PS3) printer software using any Windows printing program, as described in these sections.

Note: The PostScript printer software supports products that are connected via Ethernet. If your product is connected via USB, you will need to install the standard Epson printer software. To download the standard Epson printer software, visit epson.com/support (U.S.), epson.ca/support (Canada), or latin.epson.com/support (Latin America) and select your product.

[Selecting Print Settings - PostScript Printer Software - Windows](#)

[Selecting Default Print Settings - PostScript Printer Software - Windows](#)

Parent topic: [Printing from a Computer](#)

Selecting Print Settings - PostScript Printer Software - Windows

Select the basic settings for the document or photo you want to print.

1. Open a photo or document for printing.
2. Select the print command in your application.

Note: You may need to select a print icon on your screen, the **Print** option in the **File** menu, or another command. See your application's help utility for details.

3. If necessary, select your product name as the printer you want to use, and then click the **Preferences** or **Properties** button, depending on the application.

You see the Paper/Quality tab of your printer settings window:

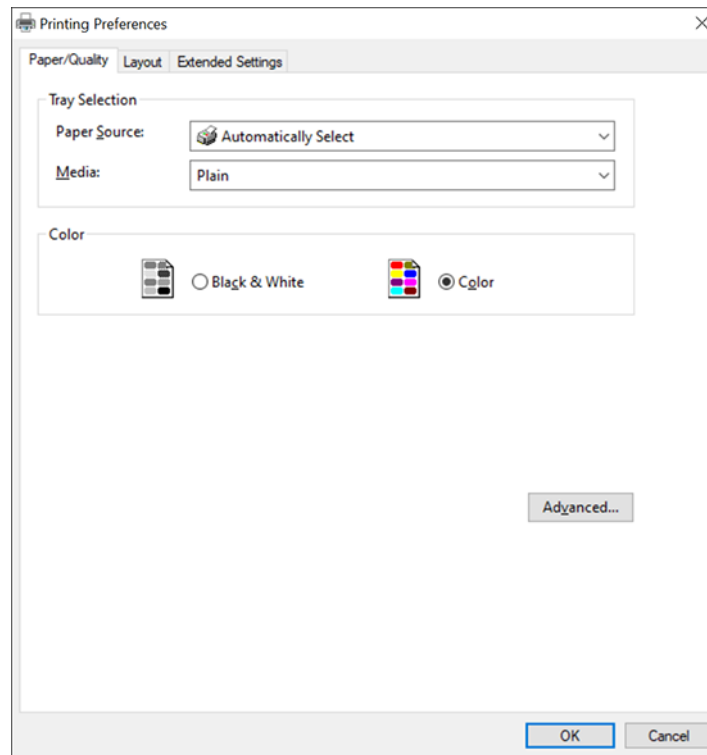

4. Select the **Paper Source** that matches where you loaded the paper you want to print on.
5. Select **Plain** as the **Media** setting.
6. Select one of the following as the Color setting:
 - To print text and graphics in black only, select the **Black & White** setting.
 - To print a color document or photo, select the **Color** setting.
7. To select additional PostScript layout and printing options, select **Advanced** and select additional settings as necessary.
8. Select the **Layout** tab.

You see a screen like this:

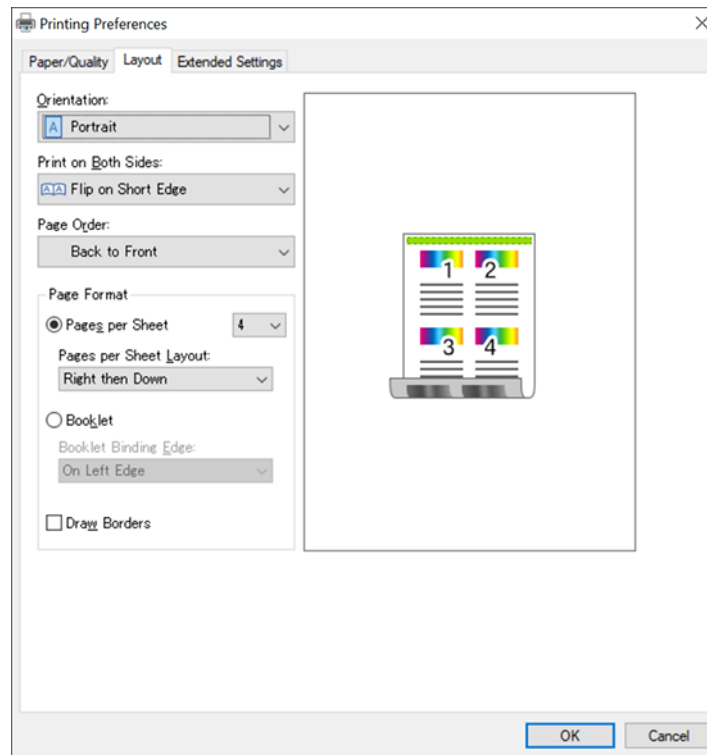





9. Select any settings as necessary.
10. If you have set up Access Control or want to print a confidential job, select **Extended Settings** to enable printing by entering a user name and password , or print a confidential job by entering the necessary information.

Parent topic: [Printing with the PostScript \(PS3\) Printer Software - Windows](#)

Selecting Default Print Settings - PostScript Printer Software - Windows

When you change your print settings in a program, the changes apply only while you are printing in that program session. If you want to change the print settings you use in all your Windows programs, you can select new default print settings.

1. Do one of the following:

- **Windows 10:** Click  and select  (Settings) > **Devices** > **Printers & scanners**. Select your product name and select **Manage** > **Printing preferences**.
- **Windows 8.x:** Navigate to the **Apps** screen and select **Control Panel** > **Hardware and Sound** > **Devices and Printers**. Right-click your product name and select **Print Preferences**.
- **Windows 7:** Click  and select **Devices and Printers**. Right-click your product name and select **Printing Preferences**.
- **Windows Vista:** Click  and select **Control Panel**. Click **Printer** under **Hardware and Sound**, right-click your product name, and select **Printing Preferences**.

2. Click the **Layout** tab.

You see the printer settings window:

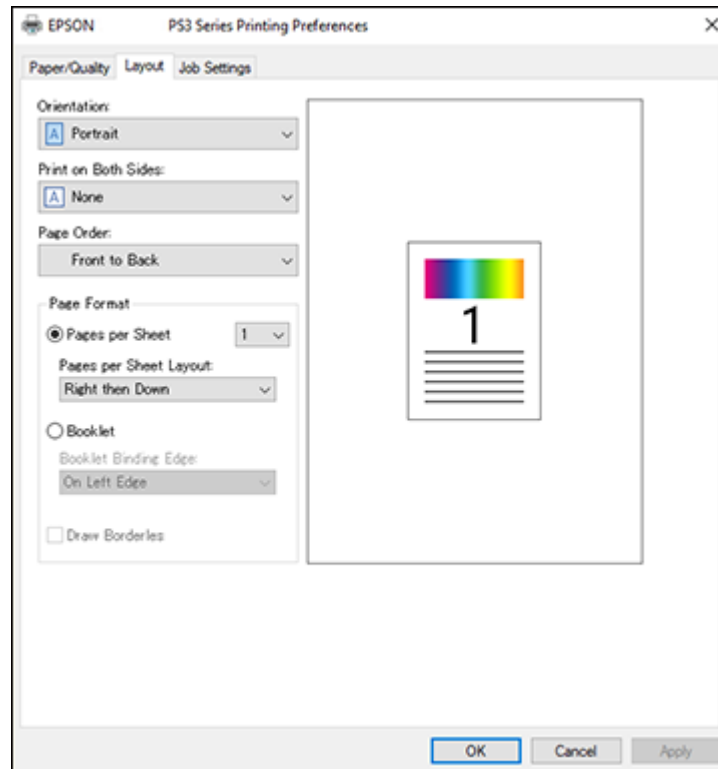

3. Select the print settings you want to use as defaults in all your Windows programs.
4. Click **OK**.

These settings are now the defaults selected for printing. You can still change them as needed for printing in any program session.

Parent topic: [Printing with the PostScript \(PS3\) Printer Software - Windows](#)

Printing with the PostScript (PS3) Printer Software - Mac

You can print with the PostScript (PS3) printer software using any Mac printing program, as described in these sections.

Note: The PostScript printer software supports products that are connected via Ethernet. If your product is connected via USB, you will need to install the standard Epson printer software. To download the standard Epson printer software, visit epson.com/support (U.S.), epson.ca/support (Canada), or latin.epson.com/support (Latin America) and select your product.

[Selecting Basic Print Settings - PostScript Printer Software - Mac](#)

Parent topic: [Printing from a Computer](#)

Selecting Basic Print Settings - PostScript Printer Software - Mac

Select the basic settings for the document or photo you want to print.

The PostScript printer software supports plain paper printing on these paper and envelope sizes:

- A4 (8.3 × 11.7 inches [210 × 297 mm])
- Letter (8.5 × 11 inches [216 × 279 mm])
- No. 10 (4.1 × 9.5 inches [105 × 241 mm])
- A5 (5.8 × 8.2 inches [148 × 210 mm])
- B5 (7.2 × 10.1 inches [182 × 257 mm])
- A6 (4.1 × 5.8 inches [105 × 148 mm])
- B6 (5 × 7.2 inches [128 × 182 mm])
- Executive (7.25 × 10.5 inches [184 × 267 mm])
- Legal (8.5 × 14 inches [216 × 356 mm])
- 8.5 × 13 inches (216 × 330 mm)
- A3 (11.7 × 16.5 inches [297 × 420 mm])

- 13 × 19 inches (330 × 483 mm)
- 11 × 17 inches (279 × 432 mm)
- B4 (13.9 × 9.84 inches [353 × 250 mm])
- Envelope C6 (4.49 × 6.38 inches [114 × 162 mm])
- Envelope DL (4.33 × 8.66 inches [110 × 220 mm])

1. Open a photo or document for printing.
2. Select the print command in your application.

Note: You may need to select a print icon on your screen, the **Print** option in the **File** menu, or another command. See your application's help utility for details.

3. Select your product as the **Printer** setting.



4. If necessary, click the arrow next to the Printer setting or the **Show Details** button to expand the print window.

You see the expanded printer settings window for your product:

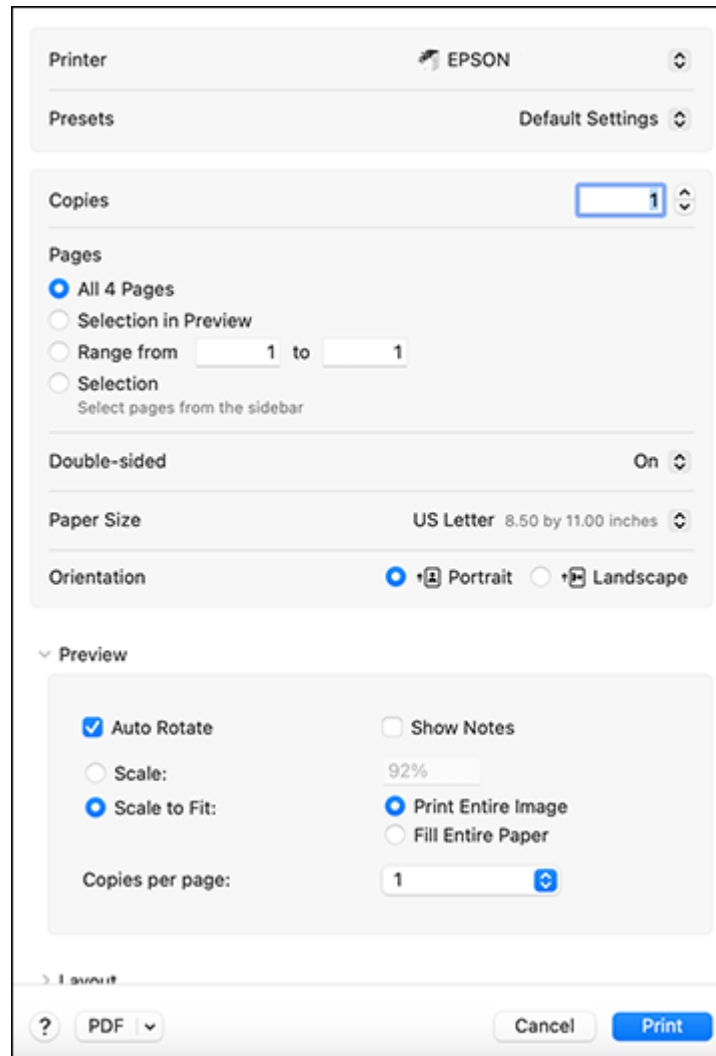

Note: The print window may look different, depending on the Mac OS version and the application you are using.

5. Select the **Two-Sided**, or **Double-sided**, **Copies**, and **Pages** settings as necessary.

Note: If you do not see these settings in the print window, check for them in your application before printing.

6. Select the page setup options: **Paper Size** and **Orientation**.

Note: If you do not see these settings in the print window, check for them in your application before printing. They may be accessible by selecting **Page Setup** from the File menu.

7. Select any application-specific settings that appear on the screen, such as those shown in the image above for the Preview application.

8. Select **Paper Feed** from the **Printer Options** menu or select **Paper Feed** from the pop-up menu in the print window.



You see these settings:

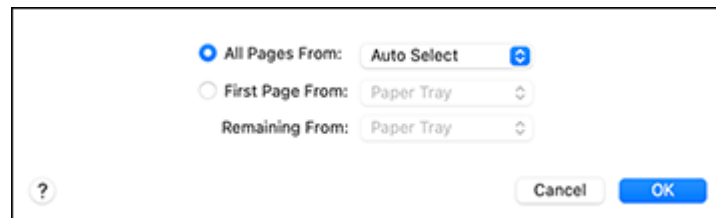

9. Select **All Pages From** or **First Page From** and select the paper source you want to print from.

10. Select **Printer Features** from the **Printer Options** menu or select **Printer Features** from the pop-up menu in the print window.



You see these settings:



11. Select a **MediaType** setting.
12. Select one of the following **Print Quality** options:
 - For fast printing with reduced quality, select **Fast**.
 - For printing text and graphics with good quality and print speed, select **Fine**.
 - For the best printing with reduced speed, select **Maximum**.
13. Select **Color** from the Feature Sets pop-up menu.

You see these settings:
14. Select a **Color Mode** option:
 - To print a color document or photo, select the **Color** setting.
 - To print text and graphics in black only, select the **Monochrome** setting.
15. Select any of the following from the pop-up menu as necessary:
 - Select **Layout** to adjust a variety of layout options for your document or photo.

- Select **Paper Handling** to adjust the size of the image as you print it.
- Select **Color Matching** to fine-tune the colors in your printout. For monochrome printers, this adjusts the tone and brightness of your printout.

Parent topic: [Printing with the PostScript \(PS3\) Printer Software - Mac](#)

Printing from a Smartphone or Tablet

You can print from a smartphone or tablet running iOS or Android using the Epson Smart Panel app.

Note: Your device must be connected to the same wireless network as your Epson product, and Epson Smart Panel must be configured for use with your product.

1. Download the Epson Smart Panel app from your device's app store or from Epson's website.
2. Open the Epson Smart Panel app and select a print menu on the home screen.
3. Follow the on-screen instructions to begin printing.

Parent topic: [Printing from a Computer](#)

Cancelling Printing Using a Product Button

If you need to cancel printing in progress, press the  stop button.

To cancel stored jobs or jobs waiting to print, follow the instructions below.

1. Press the  **Job/Status** button.
2. Select **Active** on the **Job Status** tab.
3. Select the job you want to cancel and select **Cancel**.

Parent topic: [Printing from a Computer](#)

Scanning

You can scan your originals and save them as digital files.

[Starting a Scan](#)

[Scanning with Document Capture Pro or Document Capture](#)

[Scanning in Epson Scan 2](#)

[Scanning Special Projects](#)

Starting a Scan

After placing your originals on your product for scanning, start scanning using one of these methods.

Note: You can also scan using Document Capture Pro (Windows) or Document Capture (Mac).

[Starting a Scan Using the Product Control Panel](#)

[Setting Up and Scanning to a Network Folder or FTP Server](#)

[Entering a User ID and Password for Scanning](#)

[Starting a Scan Using the Epson Scan 2 Icon](#)

[Starting a Scan from a Scanning Program](#)

[Starting a Scan from a Smartphone or Tablet](#)

Parent topic: [Scanning](#)

Related topics

[Scanning with Document Capture Pro or Document Capture](#)

[Placing Originals on the Product](#)

Starting a Scan Using the Product Control Panel

You can scan an image to a variety of destinations using your product's control panel.

1. Make sure you installed the product software and connected the product to your computer or network.

Note: Restart your computer after installing the product software to enable scanning from the control panel.

2. Place your original on the product for scanning.

Note: To scan a double-sided or multi-page document, place your originals in the ADF.

3. Press the  home button, if necessary.
4. Select **Scan**.
5. Select one of the following **Scan to** options:
 - **Network Folder/FTP** saves your scan file to a specified folder on a network.
 - **Email** lets you send scanned files through a pre-configured email server.
 - **Document Capture Pro** lets you scan over a network using your saved job settings in Document Capture Pro or Document Capture.

Note: You cannot use this option to scan an image to Document Capture or Document Capture Pro when your product is connected to your computer's USB port.

- **Memory Device** saves your scan file on a USB device inserted in your product's external USB port and lets you select the file format, quality, and other settings.
 - **Cloud** sends your scanned files to a destination that you have registered with Epson Connect.
 - **Computer (WSD)** lets you manage network scanning in Windows. To use this feature on Windows 7 or Windows Vista, you must first set up WSD (Web Services for Devices) on the computer.
6. Follow the instructions in the links below to complete your scan.

[Scanning to Email](#)

[Scanning to a Memory Device](#)

[Scanning to the Cloud](#)

[Setting Up a WSD Port \(Windows 7\)](#)

[Control Panel Scanning Options](#)

Parent topic: [Starting a Scan](#)

Related tasks

[Scanning to the Cloud](#)

[Entering Characters on the LCD Screen](#)

[Using Presets](#)

Related topics

[Placing Originals on the Product](#)

Scanning to Email

You can scan an original and email the scanned file using your product's control panel. You need to have a preconfigured email server before you can scan to email. You can either enter the email address directly on the product's control panel or select an address from the **Contacts** list. Make sure the date and time are set correctly so the time stamps on your emails are accurate.

Note: You can also use the Scan to Document Capture Pro function to scan and email the scanned file.

1. Place your original on the product for scanning.

Note: To scan a double-sided or multi-page document, place all of the pages in the ADF.

2. Press the  home button, if necessary.
3. Select **Scan > Email**.
4. Do one of the following:
 - Select from any displayed frequent contacts.
 - Select **Keyboard** to use the displayed keyboard to enter the address for the recipient and select **OK**.
 - Select **Contacts** and choose an email address from the list.
 - Select **History** to choose an email address from your recent scan history.
5. Select **Scan Settings**.
6. Select **File Format** to choose the file format for your scan.
7. Scroll down and change the **Subject** and **File Name** settings, if necessary.
8. Select any additional scan settings as necessary.
9. Select **Presets** to save your scan settings.

Note: Presets can be locked by an administrator. If you cannot access or change this setting, contact your administrator for assistance.

10. Press the **Send** icon.

Your product scans your original and emails the scanned file.

Parent topic: [Starting a Scan Using the Product Control Panel](#)

Scanning to a Memory Device

You can scan an original and save the scanned image to a external USB device connected to your product.

1. Insert a external USB device into the product's USB port.
2. Place your original on the product for scanning.

Note: To scan a double-sided or multi-page document, place all of the pages in the ADF.

3. Press the  home button, if necessary.
4. Select **Scan > Memory Device**.
5. Select **Basic Settings** options as necessary.
6. Select the **Advanced** tab and select options as necessary.
7. Select **Presets** to save your scan settings.

Note: Presets can be locked by an administrator. If you cannot access or change this setting, contact your administrator for assistance.

8. Select the **Save** icon.

Your product scans your original and saves the scanned file to a memory device.

Parent topic: [Starting a Scan Using the Product Control Panel](#)

Scanning to the Cloud

You can use the control panel to send your scanned files to a destination that you have registered with Epson Connect.

Note: Make sure to set up your product using Epson Connect before using this feature.

1. Place your original on the product for scanning.

Note: To scan a double-sided or multi-page document, place all of the pages in the ADF.

2. Press the  home button, if necessary.
3. Select **Scan > Cloud**.

4. Press the **+** icon and select a cloud destination.
5. Select **Basic Settings** options as necessary.
6. Select the **Advanced** tab and select options as necessary.
7. Select **Presets** to save your scan settings.

Note: Presets can be locked by an administrator. If you cannot access or change this setting, contact your administrator for assistance.

8. Press the **Upload** icon.

Your product scans your original and saves the scanned file to the selected destination.

Parent topic: [Starting a Scan Using the Product Control Panel](#)

Setting Up a WSD Port (Windows 7)

You can scan to a networked Windows computer using WSD (Web Services for Devices). You must first set up a WSD port on your Windows 7 system (the port is set up automatically on Windows 11, Windows 10, and Windows 8.x).

Before you set up a WSD port, make sure you installed your product software, and connected your product and computer to the same network.

1. Turn on your product.
2. Print a network status sheet so you can identify the network name and model name for your product on the network.
3. Click  and select **Computer**.
4. On the left side of the window, select **Network**.
5. Locate your product on the Network screen, right-click it, and select **Install**.
6. When you see the User Account Control screen, click **Continue**.

Note: If you see an Uninstall screen, click **Uninstall** and repeat these steps as necessary.

7. When you see the message **Your device is ready to use** in the Windows taskbar, click the message.
8. On the Driver Software Installation screen, make sure your product is listed as **Ready to use**. Then click **Close**.
9. Click  and select **Devices and Printers**.

10. Make sure that an icon appears for your product's name on the network.

When you use WSD, select your product name to scan over the network.

Parent topic: [Starting a Scan Using the Product Control Panel](#)

Control Panel Scanning Options

Select the options you want to use for scanning.

Note: Not all options or settings may be available, depending on the **Scan to** option selected.

Scan Settings	Available options	Description
Color Mode	B&W	Select to scan images in black and white
	Color	Select to scan images in color
File Format	JPEG	Select for photos. You can also select the Compression Ratio .
	PDF (Single Page)	Select for documents. You can also select the Compression Ratio and PDF Settings .
	PDF (Multi Page)	
	PDF/A (Single Page)	
	PDF/A (Multi Page)	Select for scanned files that you can print from a device. Multi Page TIFF documents are scanned in black and white.
	TIFF (Single Page)	
TIFF (Multi Page)		
Resolution	200dpi	Select for documents
	300dpi	Select for photos
	600dpi	Select for highest quality printing
2-Sided	1-Sided	Lets you scan 2-sided originals placed in the ADF. If you select 2-Sided , you can also select the Binding (Original) setting.
	2-Sided	
Scan Area	Auto Cropping	Select to automatically adjust the scan area
	Various sizes	Select the page size for documents
	Max Area	Select for most photos

Scan Settings	Available options	Description
Original Type	Text	Specify the type of original you are scanning
	Text & Image	
	Photo	
Orientation (Original)	Readable Direction	Select the orientation direction for how you placed the originals
	Left Direction	
Mixed Size Originals	A3 and A4	Select one of the size combinations to place in the ADF at the same time. When using these combinations, originals are scanned at the actual size of the originals. Place your originals by aligning the width of the originals.
	B4 and B5	
	A4 and A5	
Density	Varying levels	Adjust the lightness or darkness of scanned images.
Remove Shadow	Off	Erase the shadows that appear in the center of a document when copying a book or the shadows that appear around a document when copying thick paper
	On	
Remove Punch Holes	Off	Erase the binding holes on a document
	On	
Subject	—	Enter a subject for your email
Attached File Max Size	Various sizes	Select the maximum file size that can be attached to an email
File Name	—	Enter a prefix, the date, and the time to the file name for your scanned file

Parent topic: [Starting a Scan Using the Product Control Panel](#)

Setting Up and Scanning to a Network Folder or FTP Server

Before you can scan to a network folder on your computer or on an FTP server, you need to create a shared folder and optionally register its location to your product's Contacts list. Select the links below as necessary to create and register the folder, and to scan to it over the network.

[Creating a Shared Network Folder](#)

[Registering Contacts for Network Folder or FTP Scanning - Web Config](#)

[Registering Contacts for Email, Network, or FTP Scanning - Control Panel](#)
[Scanning to a Network Folder or FTP Server](#)

Parent topic: [Starting a Scan](#)

Creating a Shared Network Folder

You can create a shared network folder on your computer or an FTP site and register its location to your product's Contacts list.

Note: If you are creating a shared network folder on a Mac, see your Mac documentation for instructions on creating the folder. The instructions here are for Windows.

First make sure you connected your product and computer to the same network.

Note: If you are running a Home version of the Windows operating system, you cannot create a shared folder on your Windows desktop or in the Documents or Pictures folder unless you have created a Home Group Configuration for sharing. You can, however, create a shared folder in the root of the C: drive on your system.

If you want to scan to a folder on an FTP server, contact the FTP server administrator for the server address and authentication access to a shared folder on the server.

1. If you are scanning to a network folder on your computer, do one of the following to check the format of your computer name:
 - **Windows 11, Windows 10, or Windows 8.x:** Hold down the Windows key on your keyboard and press the **X** key. Select **System** from the list that appears. Check the Computer Name or Device Name listed for your computer on the System window.
 - **Windows 7:** Click , right-click **Computer**, and select **Properties**. Check the Computer Name listed for your computer on the System window.

Note: The settings in these steps may vary, depending on your version of Windows. See Windows Help for details on your operating system.

2. If the computer's name uses any characters that are not alphanumeric (letters or numbers), do one of the following to change the computer's name:
 - **Windows 11, Windows 10, or Windows 8.x:** Select **Rename this PC** and follow the on-screen prompts.

- **Windows 7:** Select **Change Settings**, change the computer's name, and click **OK**. (See Windows Help for instructions, if necessary.)

Note: You need to be logged into Windows as an administrator to change the computer's name. After changing the name, restart your computer.

3. Click the Windows start button, then select **Windows System > Control Panel**.
4. On the Control Panel, click **Network and Internet > Network and Sharing Center > Change advanced sharing settings**.

The network profile is displayed.

Make sure that **Turn on file and printer sharing** is selected under File and Printer Sharing for the network profile (current profile). If already selected, click **Cancel** to close the window.

5. Start File Explorer or Windows Explorer.
6. Create a folder on the Windows desktop with a folder name of 12 characters or less; otherwise, your product may not be able to access the folder.

Note: You need to be logged into Windows as an administrator to access the desktop folder and the document folder under each User folder.

7. Right-click the folder you created and select **Properties**.
8. On the **General** tab, deselect the **Read-only** checkbox to allow users to access the folder over the network.
9. Select the **Sharing** tab and click the **Advanced Sharing** button.

Note: You need to be logged into Windows as an administrator to select the **Advanced Sharing** button.

10. On the Advanced Sharing screen, select the **Share this folder** checkbox.
11. Click the **Permissions** button and select the following on the Share Permissions tab:
 - Select **Everyone** under Group or user names.
 - Select the checkbox in the **Allow** column for the **Change** setting.
12. Click **OK** to save the settings, then click **OK** again to close the Advanced Sharing window.
13. Select the **Security** tab and check that the Group or user names list at the top includes the current computer user and the administrators who can now access the folder.

14. Select the **Sharing** tab again and write down the **Network Path** listed under Network File and Folder Sharing at the top. This is the path you will register to your product's Contacts list so you can select it for network scanning.
15. Click **OK** or **Close**.

Now you can register the folder path to your product's Contacts list.

Parent topic: [Setting Up and Scanning to a Network Folder or FTP Server](#)

Registering Contacts for Network Folder or FTP Scanning - Web Config

You can register a list of contacts for scanning to a network folder or FTP server using Web Config and your computer's internet browser.

Before you begin, print a network status sheet and locate the IP address for your product on the sheet.

1. Start an internet browser on a computer that is using the same network as your product.
2. Type your product's IP address into the address bar and press **Enter**.
3. Click **Continue to this website (not recommended)**.

Note: This step may vary depending on the browser version you are using.

4. Log in as an administrator.
5. Click the **Scan/Copy** tab.
6. Click **Contacts**.
7. Select an empty number you want to use for the contact you are adding and click **Edit**.
8. Enter the following information for the contact:
 - **Name:** The name to display in your product's contact list.
 - **Index Word:** Enter a word to identify this entry when searching for it (up to 30 characters). This field is optional.
 - **Type:** Select **Network Folder (SMB)**, **FTP**, or **SharePoint(WebDAV)**.
 - **Assign to Frequent Use:** If you want to identify the contact as a frequently used address, select **On**. This makes it quicker to select the contact when you scan.
 - **Save to:** The network path to the shared folder.

Enter the folder path name in one of the following formats depending on the **Type** setting you selected:

- **SMB:** host_name\folder

- **FTP/SharePoint:** host_name/folder_name
- **Secure Connection:** For FTP locations, select the secure connection type.
- **User Name** and **Password:** Enter only if you have set up a password on your computer.
- **Connection Mode:** For FTP locations, select **Passive Mode** if there is a firewall between the product and FTP server.
- **Port Number:** For FTP locations, enter the port number.
- **Certificate Validation:** For FTP locations, choose to enable or disable an imported certificate.

Note: This setting is only available if you select **FTPS** as the **Secure Connection** setting.

9. Click **Apply**.

After a moment, you see a message telling you that contact registration is complete.

10. Close your web browser.

Parent topic: [Setting Up and Scanning to a Network Folder or FTP Server](#)

Registering Contacts for Email, Network, or FTP Scanning - Control Panel

You can create a list of contacts for scanning to email or to a network folder or FTP.

Note: Contacts can be locked by an administrator. If you cannot access or change contacts, contact your administrator for assistance. You can create up to 2,000 contacts and contact groups combined (including fax contacts for models with optional fax board installed).

1. Press the  home button, if necessary.
2. Select **Settings**.
3. Select **Contacts Manager**.
4. Select **Add/Edit/Delete**.
5. Select **Add New**.
6. Select **Add Contact**.
7. Do one of the following:
 - To create a contact for scanning to fax, select **Fax** (models with optional fax board installed).
 - To create a contact for scanning to email, select **Email**.
 - To create a location for scanning to a network folder or FTP, select **Network Folder/FTP**.

8. Select the number you want to use for the contact you are adding.
9. Select the **Name** field. Use the on-screen keyboard to enter the contact name (up to 30 characters) and select **OK**.
10. Select the **Index Word** field. Use the on-screen keyboard to enter a word to use when searching for an entry (up to 30 characters) and select **OK**. (This field is optional.)
11. Do one of the following:
 - For a fax contact (models with optional fax board installed), select the **Fax Number** field. Use the displayed keyboard to enter the fax number and select **OK**.
Select any other fax settings as necessary.
 - For an email contact, select the **Email Address** field. Use the on-screen keyboard to enter the address and select **OK**.
 - For a network folder or FTP location, select the **Communication Mode** field and select **Network Folder (SMB)** or **FTP**. Then select the **Location** field, use the on-screen keyboard to enter the location, and select **OK**. Enter other information if necessary.
Enter the folder path name for the **Location** setting in one of the following formats depending on the **Communication Mode** setting you selected:
 - **SMB**: \\host name\folder
 - **FTP**: ftp://host name/folder name
12. Select **OK**.

Note: If you need to edit or delete scanning contacts, the procedures are the same as for fax contacts.

Parent topic: [Setting Up and Scanning to a Network Folder or FTP Server](#)

Scanning to a Network Folder or FTP Server

You can scan an image and save it to a network folder using your product's control panel. You can either enter the folder path directly on the product's control panel or select a folder from the **Contacts** list.

Note: Make sure the date and time are set correctly before using this feature.

1. Place your original on the product for scanning.

Note: To scan a double-sided or multi-page document, place your originals in the ADF.

2. Press the  home button, if necessary.

3. Select **Scan > Network Folder/FTP**.
4. Specify the destination by doing one of the following:
 - Select from frequently used addresses by choosing a saved location in the **Destination** tab.
 - Enter the folder path directly by selecting **Keyboard > Communication Mode**, then select the **Location (Required)** field and enter the folder location. Enter other information as necessary.

Note: Selecting **Browse** will search a folder on computers connected to a network. You can only use **Browse** when **Communication Mode** is set to **SMB**.

Enter the folder path name for the **Location (Required)** setting in one of the following formats depending on the **Communication Mode** setting you selected:

- **SMB:** \\host name\folder name
 - **FTP:** ftp://host name/folder name
 - **FTPS:** ftps://host name/folder name
 - **WebDAV (HTTPS):** https://host name/folder name
 - **WebDAV (HTTP):** http://host name/folder name
- Select from the contacts list by selecting **Contacts**.
5. Select **Scan Settings**.
 6. Select **File Format** to choose the file format for your scan.
 7. Scroll down and change the **File Name** setting, if necessary.
 8. Select any additional scan settings as necessary.
 9. Select **Presets** to save your scan settings.

Note: Presets can be locked by an administrator. If you cannot access or change this setting, contact your administrator for assistance.

10. Select the **Save** icon.

Your product scans your original and saves it in the selected location.

Parent topic: [Setting Up and Scanning to a Network Folder or FTP Server](#)

Related tasks

[Entering Characters on the LCD Screen](#)

[Selecting the Date and Time](#)

Related topics

[Placing Originals on the Product](#)

Entering a User ID and Password for Scanning

If you enabled Access Control on your product, a user ID and password may be required to scan. You can enter the user ID and password in Epson Scan 2.

Note: If you do not know the user ID or password, contact your administrator for assistance.

1. Start Epson Scan 2.
2. Select **Settings** from the **Scanner** drop-down list.

You see this window:

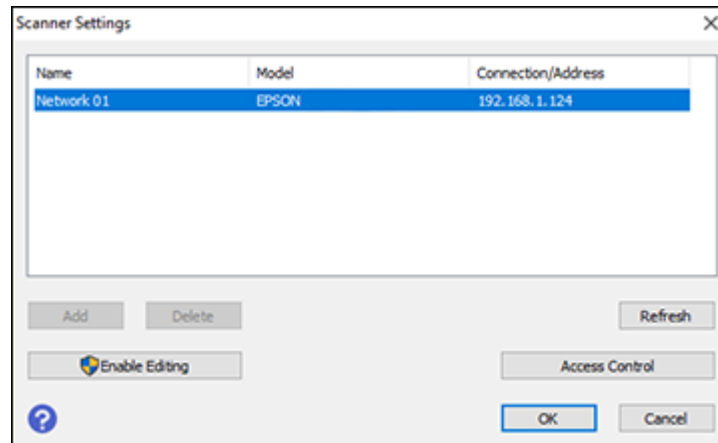



3. Select **Access Control**.
4. Enter your user name and password.
5. Click **OK**.

Parent topic: [Starting a Scan](#)

Starting a Scan Using the Epson Scan 2 Icon

You can start the Epson Scan 2 program to select scan settings, scan, and save the scanned image to a file.

Note: If you are using your Epson product with the Windows 10 S operating system, you cannot use the software described in this section. You also cannot download and install any Epson product software from the Epson website for use with Windows 10 S; you must obtain software only from the Windows Store.

- **Windows 11:** Click , then search for **Epson Scan 2** and select it.
- **Windows 10:** Click  and select **EPSON > Epson Scan 2**.
- **Windows 8.x:** Navigate to the **Apps** screen and select **Epson Scan 2**.
- **Windows (other versions):** Click  or **Start**, and select **All Programs** or **Programs**. Select **EPSON > Epson Scan 2 > Epson Scan 2**.
- **Mac:** Open the **Applications** folder, open the **Epson Software** folder, and select **Epson Scan 2**.

You see an Epson Scan 2 window like this:

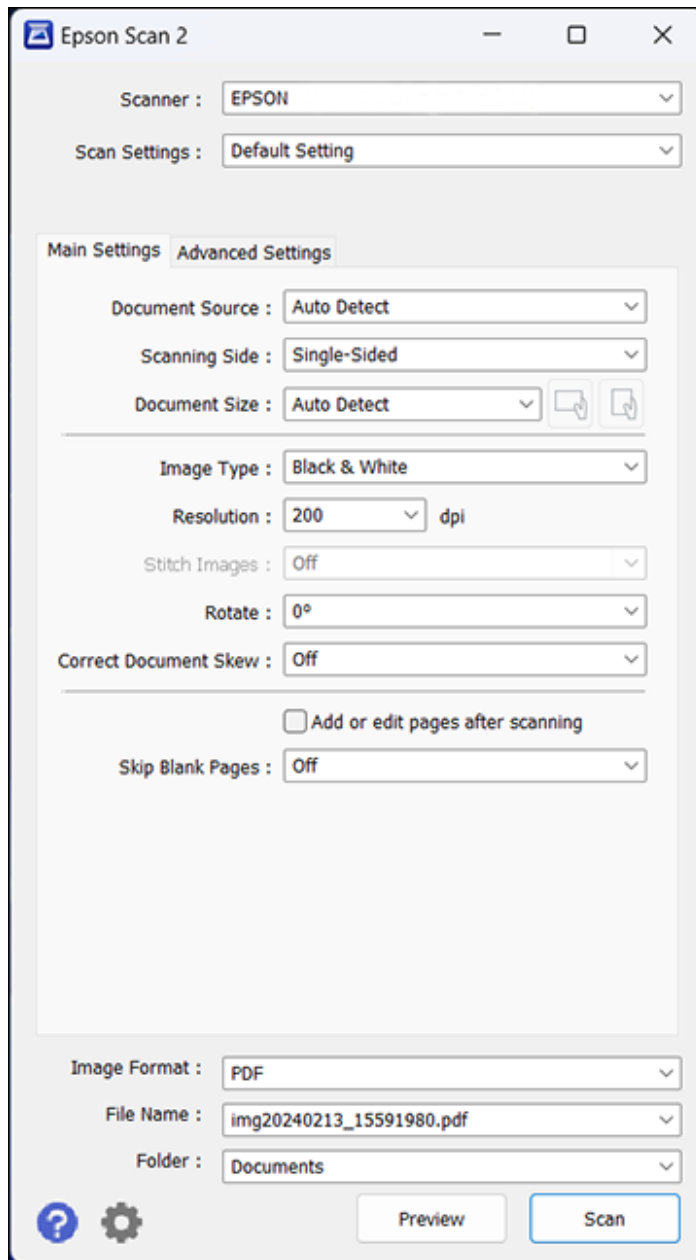

Note: Select your product from the list, if necessary.

Parent topic: [Starting a Scan](#)

Related tasks

[Entering a User ID and Password for Scanning](#)

[Starting a Scan from a Scanning Program](#)

Related topics

[Placing Originals on the Product](#)

Starting a Scan from a Scanning Program

You can start Epson Scan 2 from a TWAIN-compliant scanning program to select scan settings, scan, and open the scanned image in the program.

Note: If you are using your Epson product with the Windows 10 S operating system, you cannot use the software described in this section. You also cannot download and install any Epson product software from the Epson website for use with Windows 10 S; you must obtain software only from the Windows Store.

1. Open your scanning program and select its scanning option. (See your scanning program help for instructions.)
2. Select your product.

Note: In certain programs, you may need to select your product as the "source" first. If you see a **Select Source** option, choose it and select your product. With Windows, do not select a **WIA** option for your product; not all scan functions will be available.

You see an Epson Scan 2 window like this:

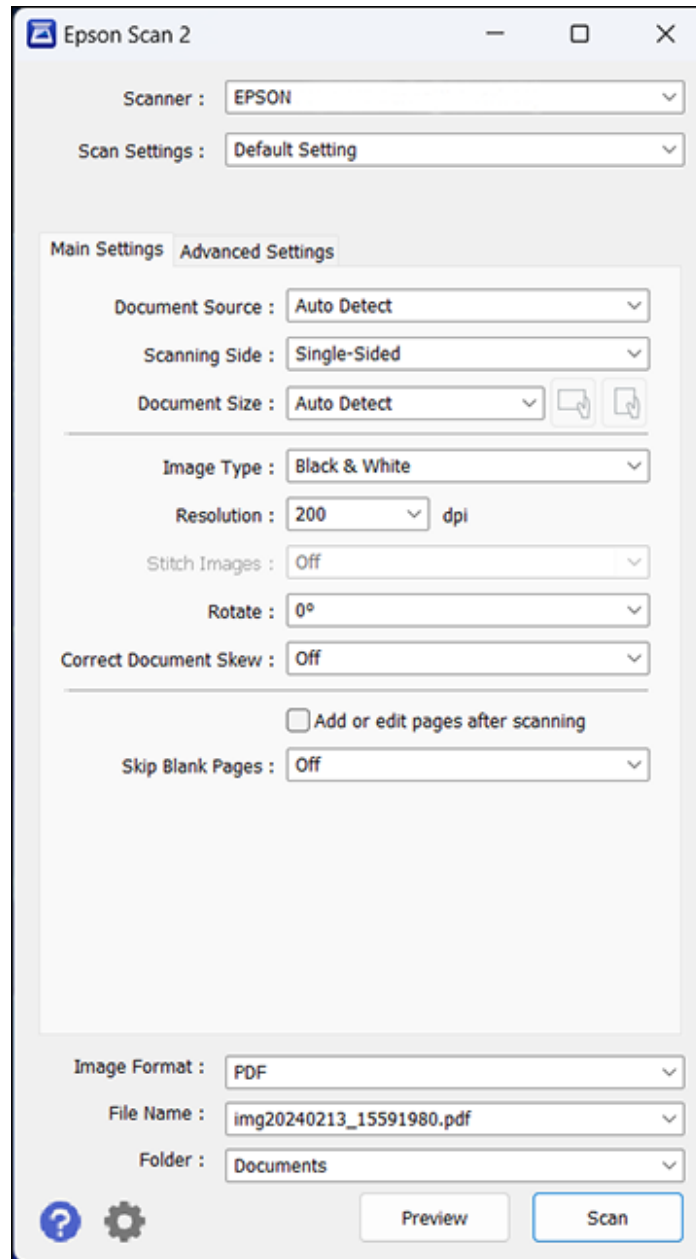

Parent topic: [Starting a Scan](#)

Related tasks

[Entering a User ID and Password for Scanning](#)

Related topics

[Placing Originals on the Product](#)

Starting a Scan from a Smartphone or Tablet

You can use the Epson Smart Panel app to scan from a network scanner to an iOS or Android device over a direct Wi-Fi connection.

1. Download the Epson Smart Panel app from your device's app store or from Epson's website. See the link below.
2. Place your original on the product for scanning.
3. Open the Epson Smart Panel app and select a scan menu on the home screen.
4. Follow the on-screen instructions to scan and save your original.

Parent topic: [Starting a Scan](#)

Scanning with Document Capture Pro or Document Capture

Follow the instructions in these sections to scan using Document Capture Pro (Windows) or Document Capture (Mac).

Note: The Document Capture Pro (Windows) or Document Capture (Mac) software must be installed on your computer.

[Setting the Operation Mode on the Product Control Panel](#)

[Scanning with Simple Scan in Document Capture Pro - Windows](#)

[Scanning with Job Scan in Document Capture Pro - Windows](#)

[Adding and Assigning Scan Jobs with Document Capture Pro - Windows](#)

[Scanning with Document Capture - Mac](#)

[Adding and Assigning Scan Jobs with Document Capture - Mac](#)

Parent topic: [Scanning](#)

Related topics

[Placing Originals on the Product](#)

Setting the Operation Mode on the Product Control Panel

Before scanning to Document Capture Pro, set the operation mode on the control panel.

1. Make sure you installed the product software and connected the product to your computer or network.
2. Press the  home button, if necessary.
3. Select **Settings**.
4. Select **General Settings > Scan Settings > Document Capture Pro**.

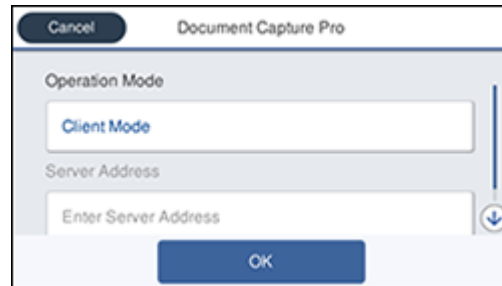

5. Choose from the following Operation Mode options:
 - Select **Client Mode** if Document Capture Pro is installed on a Windows or Mac computer.
 - Select **Server Mode** if Document Capture Pro is installed on a Windows Server computer. Enter the server address.
6. Click **OK**.

Parent topic: [Scanning with Document Capture Pro or Document Capture](#)



Scanning with Simple Scan in Document Capture Pro - Windows

You can use the Simple Scan option in Document Capture Pro to quickly scan an original.

Note: Settings may vary depending on the software version you are using. Click the **Help** icon in Document Capture Pro at any time for more information.

1. Load your original in the product.

2. Do one of the following to start Document Capture Pro:

- **Windows 11:** Click , then search for **Document Capture Pro** and select it.
- **Windows 10:** Click  and select **Epson Software > Document Capture Pro**.
- **Windows 8.x:** Navigate to the **Apps** screen and select **Document Capture Pro**.
- **Windows (other versions):** Click  or **Start**, and select **All Programs** or **Programs**. Select **Epson Software > Document Capture Pro**.

You see the Document Capture Pro window.

Note: Add and select your product in the Epson Scan 2 **Scanner Settings** list, if necessary. Open Epson Scan 2, then select **Settings** from the **Scanner** drop-down list.

3. Select the **Simple Scan** tab.

You see a window like this:

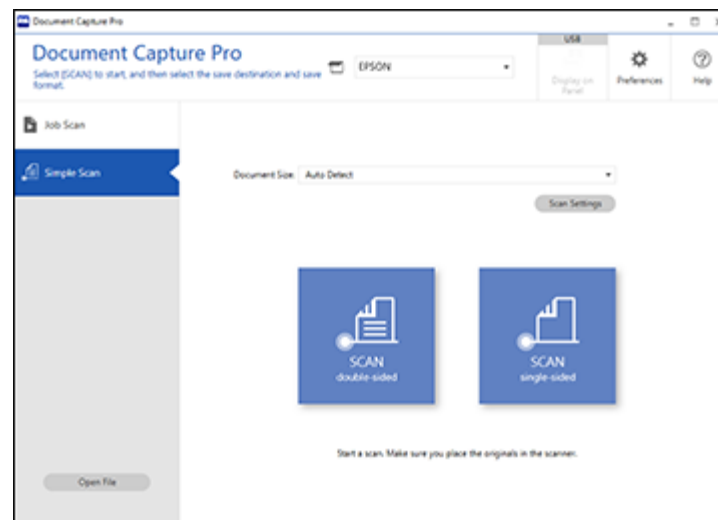

4. Select the size of your original from the **Document Size** menu.

5. If you want to change specific settings for the scan, click the **Scan Settings** button. Change any of the settings as necessary and click **OK**. For additional settings, click the **Detailed Settings** button on the Scan Settings screen.

6. Do one of the following:
 - To scan both sides of an original, select **SCAN double-sided**.
 - To scan the front side of an original, select **SCAN single-sided**.Your product scans the original and the image appears in the Edit Scanned Results window.
7. Review and edit the scanned image as necessary and click **Next** when you are finished.
8. Select a destination for the scanned image, change any settings as necessary, and click **Complete**.



Note: If you are sending the scanned image to a server or cloud destination, you need to enter your login information.

Parent topic: [Scanning with Document Capture Pro or Document Capture](#)

Scanning with Job Scan in Document Capture Pro - Windows

You can create scan jobs in Document Capture Pro and use them to quickly scan originals and save them to various destinations.

Note: Settings may vary depending on the software version you are using. Click the **Help** icon in Document Capture Pro at any time for more information.

1. Load your original in the product.
2. Do one of the following to start Document Capture Pro:
 - **Windows 11:** Click , then search for **Document Capture Pro** and select it.
 - **Windows 10:** Click  and select **Epson Software > Document Capture Pro**.
 - **Windows 8.x:** Navigate to the **Apps** screen and select **Document Capture Pro**.
 - **Windows (other versions):** Click  or **Start**, and select **All Programs** or **Programs**. Select **Epson Software > Document Capture Pro**.

You see the Document Capture Pro window.

Note: Add and select your product in the Epson Scan 2 **Scanner Settings** list, if necessary. Open Epson Scan 2, then select **Settings** from the **Scanner** drop-down list.

3. Select the **Job Scan** tab.

You see a window like this:

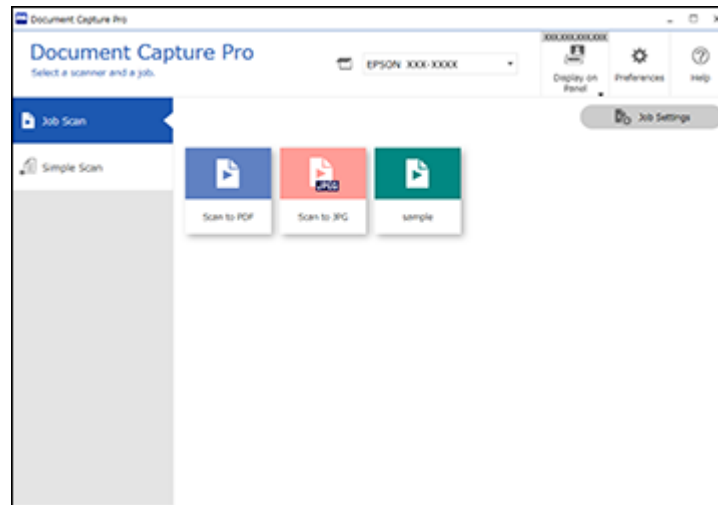

4. Select one of the scan jobs (or click **Job Settings** to create a new scan job).
The product scans the loaded original and saves it according to the job settings.
5. Depending on the settings for the scan job you selected, you may be able to view and edit the pages before saving them. If so, click **Complete** when finished.
The scanned image is saved according to the job settings.



Parent topic: [Scanning with Document Capture Pro or Document Capture](#)

Adding and Assigning Scan Jobs with Document Capture Pro - Windows

You can add scan jobs that contain specific scan settings and use the jobs when you scan from your product control panel or the Job Scan option in Document Capture Pro. You can save up to 30 scan jobs.

Note: Settings may vary depending on the software version you are using. Click the **Help** icon in Document Capture Pro at any time for more information.

1. Do one of the following to start Document Capture Pro:
 - **Windows 11:** Click , then search for **Document Capture Pro** and select it.

- **Windows 10:** Click  and select **Epson Software > Document Capture Pro**.
- **Windows 8.x:** Navigate to the **Apps** screen and select **Document Capture Pro**.
- **Windows (other versions):** Click  or **Start**, and select **All Programs** or **Programs**. Select **Epson Software > Document Capture Pro**.

You see the Document Capture Pro window.

Note: Add and select your product in the Epson Scan 2 **Scanner Settings** list, if necessary. Open Epson Scan 2, then select **Settings** from the **Scanner** drop-down list.

2. Select the **Job Scan** tab.

You see a screen like this:

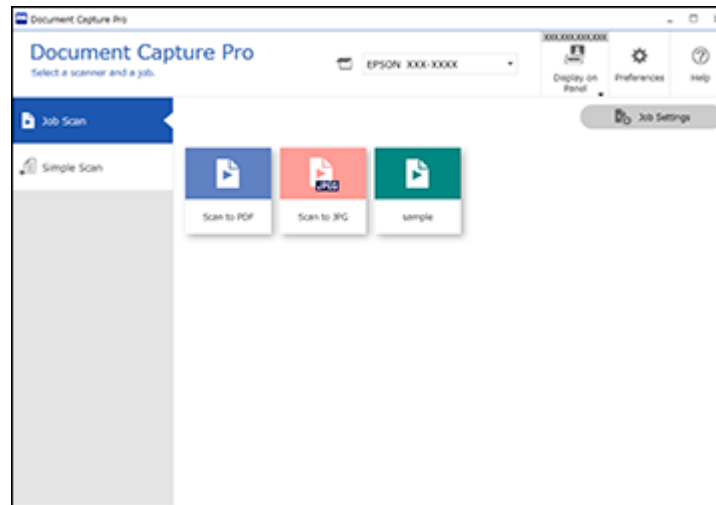

3. Click the **Job Settings** button.

You see a screen like this:

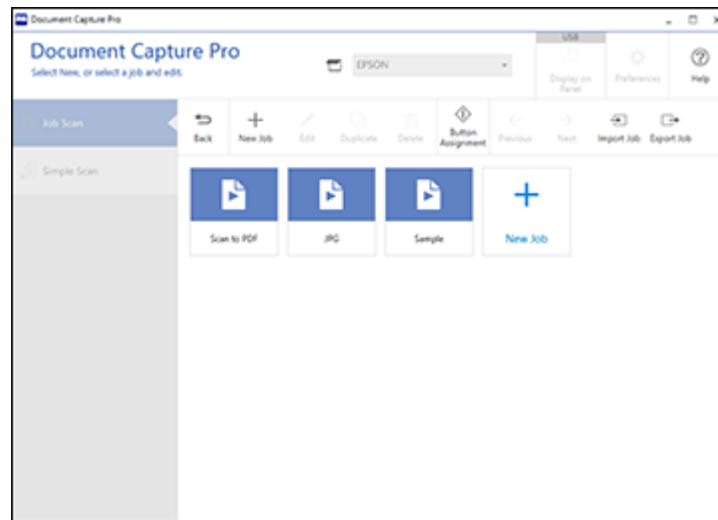

4. To add a scan job, click the **New Job** icon.
5. Enter a name for the new job, and select any settings as necessary from the following options:
 - **Scan**: select the size, color, or resolution
 - **Save**: select the file name, file type, or destination folder
 - **Index**: enable the index setting and choose output options for an index file
 - **Send**: select the destination for the scanned file, or choose to email or print the file
 - **Confirm/Test**: select the job button icon and color, choose display settings, and run a test scan if necessary
6. Click **Save** when you are finished.
The new job appears in the Job Scan window.
Note: Click **OK**, if necessary.
7. To assign a scan job to the product control panel, click the **Button Assignment** icon.

You see a screen like this:

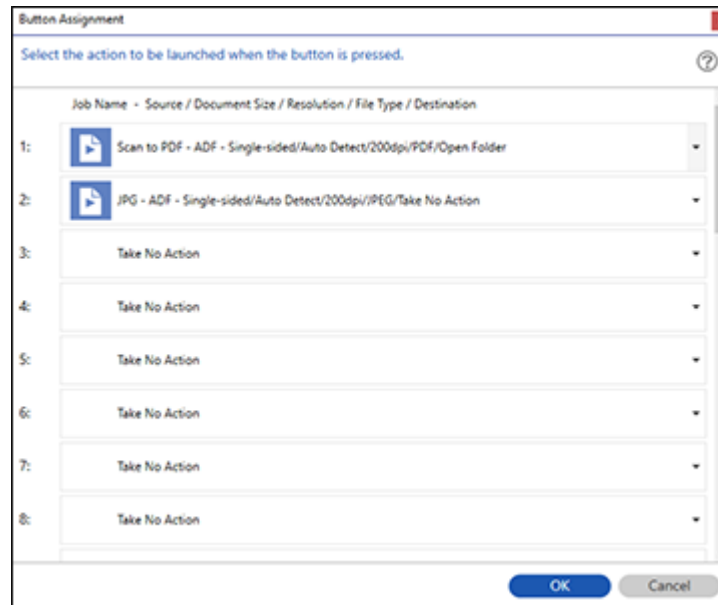

8. Select the jobs that you want to assign to the product control panel using any of the pull-down menus.

Note: The number of pull-down menus available may vary, depending on your product and any connected options.

9. Click **OK**, then click **Back**.

You can now use the added scan jobs when you scan from the product control panel.

Parent topic: [Scanning with Document Capture Pro or Document Capture](#)

Scanning with Document Capture - Mac

When you scan with Document Capture, the program automatically saves your scanned file on your computer in the folder you specify. You can select settings, preview, and change the scanned file settings as necessary. Document Capture also allows you to send the scanned file directly to an email address or printer, or upload it to a server or cloud destination.

Note: Settings may vary depending on the software version you are using. See the **Help** menu in Document Capture at any time for more information.

1. Load your original in the product.
2. Open the **Applications** folder, open the **Epson Software** folder, and select **Document Capture**.
You see a window like this:

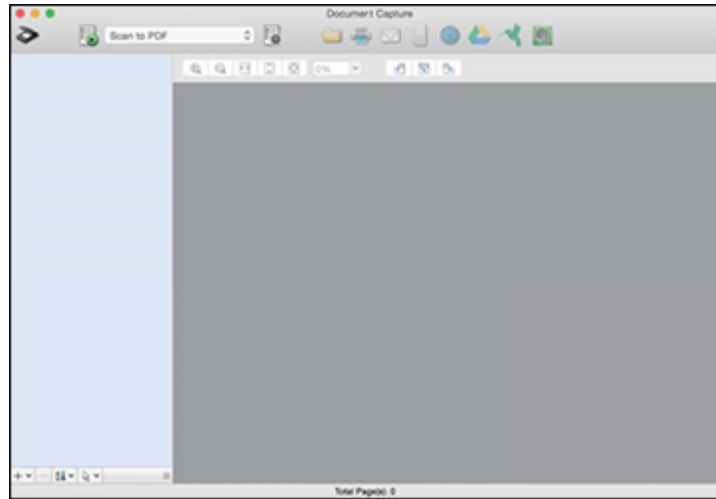

Note: You may need to select your product from the drop-down list.

3. Click the  scan icon.

You see a window like this:

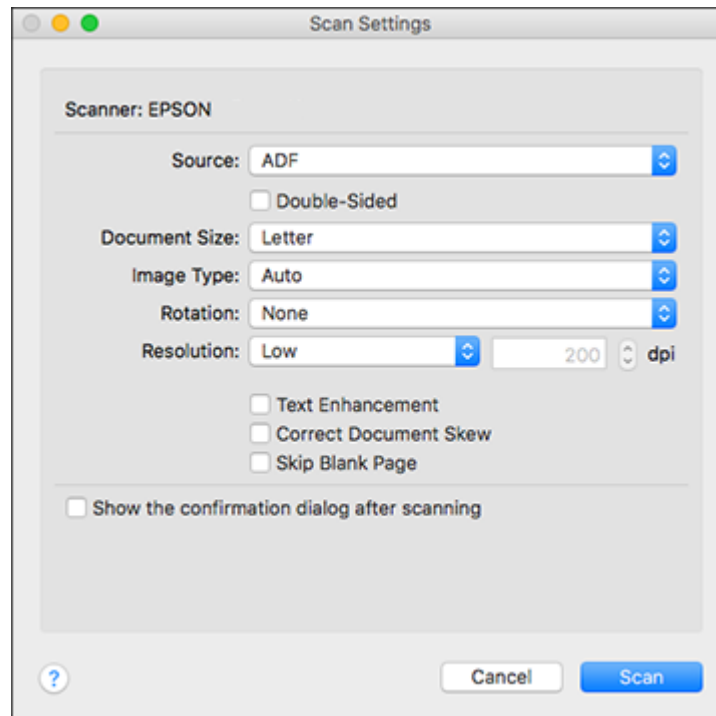

Note: If you want to use a scan job that you created instead, select it from the Job list in the Document Capture window, click the  Start Job button, and skip the rest of these steps.

4. Select any displayed scan settings you want to use.

Note: See the Help information in Document Capture for details.

5. If you want to select detailed scan settings, close the Scan Settings window, open the **Scan** menu at the top of the Mac desktop, and select **Displays the EPSON Scan Setup Screen**.
6. Click the  Scan icon and select any detailed scan settings you want to use from the Epson Scan 2 window.
7. Click **Scan**.

You see a preview of your scan in the Document Capture window.

Note: You may have to close the Epson Scan 2 window to view your scan in the Document Capture window.

8. If you would like to scan additional originals and add them to the current captured images, click the + icon, select **Acquire from Scanner**, and repeat the previous steps.
9. Check the scanned images and edit them as necessary.
10. Click one of the destination icons to choose where to send your scanned files. (If you cannot see all of the icons, click the arrow next to the icons.) Change any settings as necessary.



Note: If you are sending the scanned image to a server or cloud destination, you need to enter your login information. If you want to use Evernote as the destination, download the Evernote application from the Evernote Corporation website and install it before scanning.

11. Depending on the destination you chose, click **OK**, **Print**, or **Send** to complete the operation.

Parent topic: [Scanning with Document Capture Pro or Document Capture](#)



Adding and Assigning Scan Jobs with Document Capture - Mac

You can add scan jobs that contain specific scan settings and use the jobs when you scan from your product control panel or Document Capture. You can save up to 30 scan jobs.

Note: Settings may vary depending on the software version you are using. See the **Help** menu in Document Capture at any time for more information.

1. Start Document Capture on a computer connected to the product.
2. Click the  Manage Job icon from the toolbar at the top of the window.
You see a window showing the current scan job list.
3. To add a scan job, click the + icon, enter a name for the new job, select settings as necessary, and click **OK**.

You can now use the new scan job when you scan with Document Capture.

4. To assign a scan job to the product control panel, click the  or  settings icon at the bottom of the window and click **Event Settings**.
5. Select the jobs that you want to assign to the product control panel using any of the pull-down menus.

Note: The number of pull-down menus available may vary, depending on your product and any connected options.

6. Click **OK**, then click **OK** again.

You can now use the added scan jobs when you scan from the product control panel.

Parent topic: [Scanning with Document Capture Pro or Document Capture](#)

Scanning in Epson Scan 2

Epson Scan 2 gives you access to basic and advanced scanning features. You can scan your document and save the scanned image in various file formats in your operating system's Documents or My Documents folder, or open it in your scanning program. You can preview the scanned image and select or change settings as necessary.

Note: If you are using your Epson product with the Windows 10 S operating system, you cannot use the software described in this section. You also cannot download and install any Epson product software from the Epson website for use with Windows 10 S; you must obtain software only from the Windows Store.

1. Start Epson Scan 2.

You see this window:

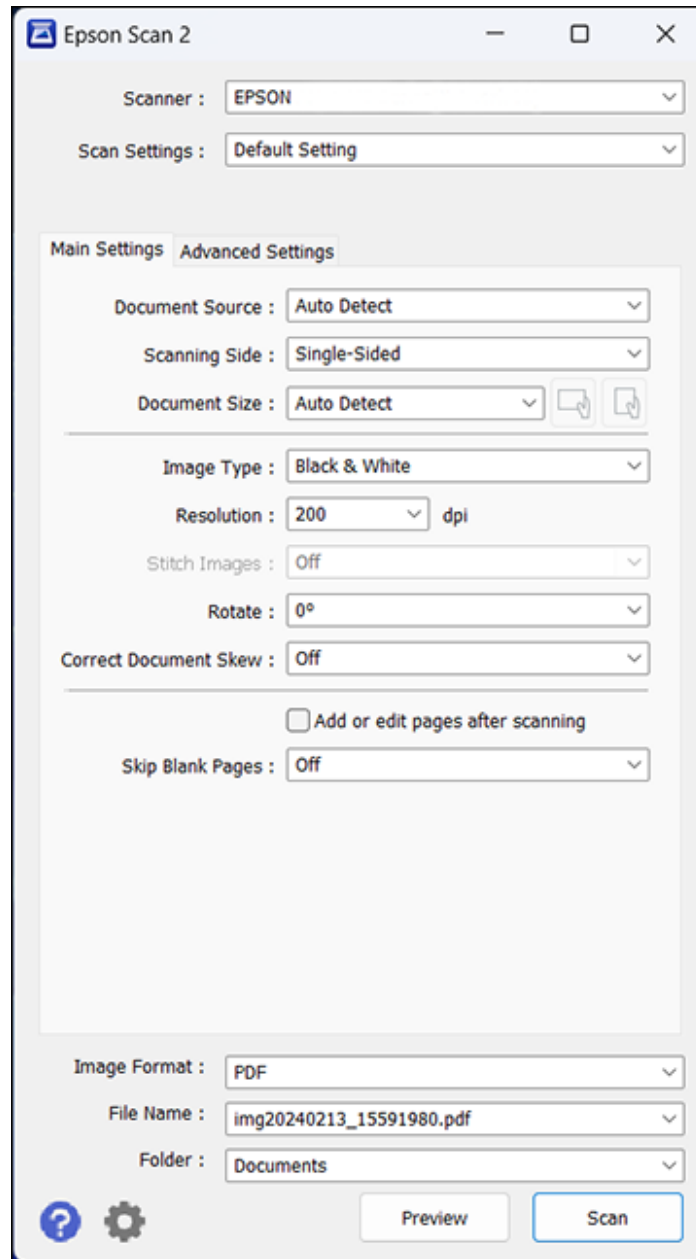

Note: Select your product from the list, if necessary.

2. Select the **Document Source** setting that matches where you placed your original, or select **Auto Detect** to have Epson Scan 2 automatically detect the source.
3. Select the **Scanning Side** setting if you are scanning from the ADF.
4. Select the **Document Size** setting that matches the size of your original, or select **Auto Detect** to have Epson Scan 2 automatically detect the size. You can select **Customize** to enter a custom size, if necessary.
5. Select the image type of your original and how you want it scanned as the **Image Type** setting.
6. Select the **Resolution** setting you want to use for your scan.
7. Select the **Rotate** setting to rotate the scanned image.
8. Select the **Correct Document Skew** setting to correct skewed originals, image contents, or both.
9. Click the **Preview** button.

Epson Scan 2 previews your original and displays the results in the Epson Scan 2 window.

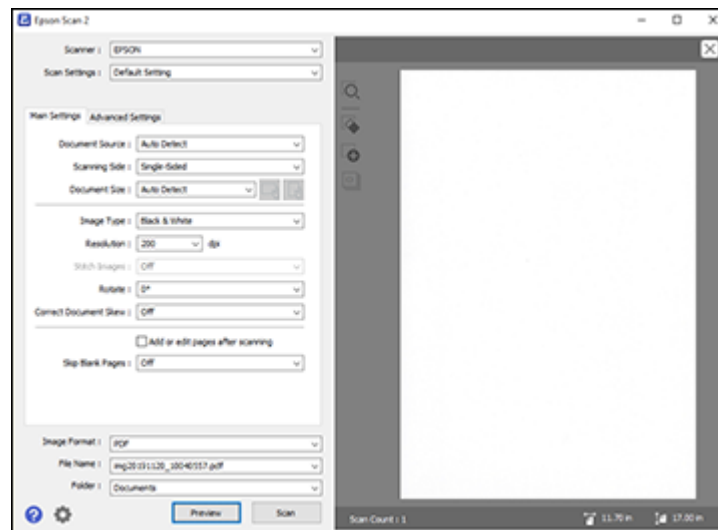

10. Reinsert your original into the ADF, if necessary.
11. Select any of the additional settings that you want to use on the Main Settings tab.

12. Click the **Advanced Settings** tab and select any settings that you want to use.
13. Select the format in which you want to save your scanned file as the **Image Format** setting. If necessary, select **Options** and select any desired format options.
14. Enter the file name for your scanned file in the **File Name** field. If necessary, select **Settings** to modify the file name settings.
15. Select the location in which you want to save your scanned file as the **Folder** setting. If necessary, select **Select** to create a new folder.
16. Click **Scan**.

The product scans your original and saves the scanned file in the location you specified.

[Available Document Source Settings](#)

[Additional Scanning Settings - Main Settings Tab](#)

[Additional Scanning Settings - Advanced Settings Tab](#)

[Saving Scanned Documents as a Searchable PDF Using Epson Scan 2](#)

[Image Format Options](#)

[Scan Resolution Guidelines](#)

Parent topic: [Scanning](#)

Related topics

[Placing Originals on the Product](#)

Available Document Source Settings

You can select these Document Source options in Epson Scan 2:

Auto Detect

Automatically detects where the originals are placed on your product for scanning.

ADF

Selects the Automatic Document Feeder as the location where the originals are placed on your product for scanning.

Scanner Glass

Selects the scanner glass as the location where the originals are placed on your product for scanning.

Parent topic: [Scanning in Epson Scan 2](#)

Additional Scanning Settings - Main Settings Tab

You can select these additional scanning settings on the Epson Scan 2 Main Settings tab. Not all adjustment settings may be available, depending on other settings you have chosen.

Stitch Images

When scanning double-sided originals, lets you lay out images from both sides of the original onto one scanned page.

Rotate

Rotates the original image clockwise to the desired angle before scanning it. Select **Auto** to allow your product to automatically rotate the image based on the orientation of the text (may take longer to scan).

Correct Document Skew

Corrects skewed originals, image contents, or both.

Add or edit pages after scanning

Lets you add, remove, or edit the pages in a scan, including rotating pages and changing the page order.

Note: To save multiple pages in a single file, you must select a file format that supports multiple pages such as **PDF** or **Multi-TIFF**. If you select another file format, each scanned image or page is saved as a separate file.

Skip Blank Pages

If the scanner detects marks from the other side of a blank page and adds the marks to the scanned image, adjust this setting to prevent this.

Parent topic: [Scanning in Epson Scan 2](#)

Additional Scanning Settings - Advanced Settings Tab

You can select these additional scanning settings on the Epson Scan 2 Advanced Settings tab. Not all adjustment settings may be available, depending on other settings you have chosen.

Remove Background

Removes the background of the originals.

Text Enhancement

Sharpens the appearance of letters in text documents.

Auto Area Segmentation

Makes black and white images clearer and text recognition more accurate by separating the text from the graphics.

Threshold

Adjusts the level at which black areas in text and line art are delineated, improving text recognition in OCR (Optical Character Recognition) programs.

Color Enhance

Enhances the shades of the color you select in the scanned image. This setting is available only if you select **Grayscale** or **Black & White** as the Image Type setting.

Brightness

Adjusts the overall lightness and darkness of the scanned image.

Contrast

Adjusts the difference between the light and dark areas of the overall scanned image.

Gamma

Adjusts the midtone density of the scanned image.

Sharpness

Makes the edges of certain image areas clearer. Turn off this option to leave softer edges.

Descreening

Removes the ripple pattern that might appear in subtly shaded image areas, such as skin tones. This option improves results when scanning magazines or newspapers. (The results of descreening do not appear in the preview image, only in your scanned image.)

Edge Fill

Corrects shadowing around the edges of the image by filling the shadows with black or white.

Dual Image Output

Scans the original image twice using different output settings (Windows only).

Parent topic: [Scanning in Epson Scan 2](#)

Saving Scanned Documents as a Searchable PDF Using Epson Scan 2

You can scan a document and save the text in a searchable PDF. In a searchable PDF, text is recognized using Optical Character Recognition (OCR) and then embedded in the scanned original.

Note: The required Epson Scan 2 OCR Component is installed automatically when you install your product software. If you install your product software programs individually, be sure to also install this component if you want to perform OCR.

1. Load your original in the product for scanning.
2. Start Epson Scan 2.
3. Select your scan settings.
4. Click **Preview** and adjust the area you want to scan, if necessary.
5. If you are using the ADF, reload the ejected original.

6. Select **Searchable PDF** as the Image Format setting.
7. Select **Options** from the Image Format list.

You see this window:

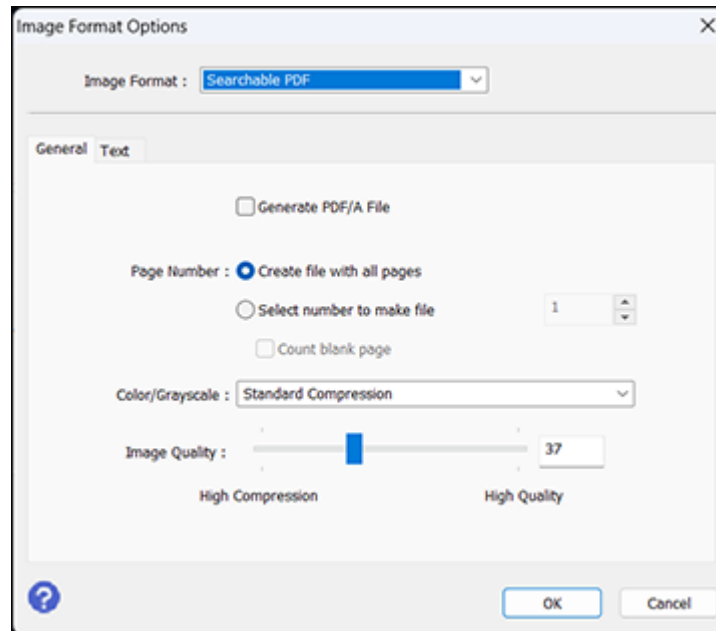

8. Select any of the options on the General tab.
9. Select the **Text** tab.
10. Make sure the language used in the document text is selected as the **Text Language** setting.
11. Click **OK**.
12. Confirm the **File Name** setting and select a **Folder** setting for your document.
13. Click **Scan**.

The scanned image is saved as a searchable PDF.

Parent topic: [Scanning in Epson Scan 2](#)

Related topics

[Placing Originals on the Product](#)

Image Format Options

You can select different image formats and related options. For details on available options, click the ? icon on the Epson Scan 2 Image Format Options window. Not all image formats have options.

BITMAP (*.bmp)

A standard image file format for most Windows programs.

JPEG (*.jpg)

An image format that lets you highly compress image data. However, the higher the compression, the lower the image quality. (The TIFF format is recommended when you need to modify or retouch your scanned image.)

PNG (*.png)

An image format that does not lose quality during editing.

TIFF (*.tif)

A file format created for exchanging data between many programs, such as graphic and DTP software.

Multi-TIFF (*.tif)

A TIFF file format when multiple pages are saved to the same file, allowing you to edit the images using a compatible program.

PDF (*.pdf)

A document format that is readable by Windows and Mac systems using Adobe Reader, Acrobat, or other programs. You can save multi-page documents in one PDF file.

Searchable PDF (*.pdf)

A document format that is readable by Windows and Mac systems using Adobe Reader, Acrobat, or other programs. You can save multi-page documents in one PDF file. Recognized text in the scanned document can be searched.

In order to use the OCR option to create searchable PDFs, you must install the OCR license key.

Parent topic: [Scanning in Epson Scan 2](#)

Scan Resolution Guidelines

The **Resolution** setting, measured in dpi (dots per inch), controls the amount of detail captured in your scans. Increasing the resolution raises the amount of detail captured but comes with the following disadvantages:

- Larger file sizes
- It takes longer to scan your originals, send/receive your scans by email or fax, and to print your scans
- The image may become too large to fit on your display or print on paper

If you plan to enlarge a scanned image so you can print it at a larger size, you may need to increase the resolution from the default resolution set by Epson Scan 2. Follow these guidelines to determine the resolution setting you need:

- You will scan the image at its original size but enlarge it later in an image-editing program.
Increase the Epson Scan 2 Resolution setting in your scan. Increase the resolution by the same amount you will increase the image size to retain a high image quality. For example, if the resolution is 300 dpi (dots per inch) and you will double the image size later, change the Resolution setting to 600 dpi.
- You will scan the image at 100% or a smaller size.
Select the Epson Scan 2 Resolution setting based on how you will use the scanned image:
 - Email/view on a computer screen/post on the web: 96 to 200 dpi
 - Print/fax/convert to editable text (OCR)/create searchable PDF: 200 to 300 dpi

Parent topic: [Scanning in Epson Scan 2](#)

Scanning Special Projects

Your product's scanning software offers various options to help you quickly complete special scan projects.

[Scanning to a SharePoint Server or Cloud Service - Windows](#)

[Scanning to a SharePoint Server or Cloud Service - Mac](#)

[Scanning Multi-Page Originals as Separate Files - Windows](#)



Parent topic: [Scanning](#)

Scanning to a SharePoint Server or Cloud Service - Windows

You can use Document Capture Pro (Windows) to upload scanned images to a SharePoint server or a cloud service.

Note: The settings may vary, depending on the software version you are using. See the help information in Document Capture Pro for details.

1. Load your original in the product.
2. Do one of the following to start Document Capture Pro:
 - **Windows 11:** Click , then search for **Document Capture Pro** and select it.

- **Windows 10:** Click  and select **Epson Software > Document Capture Pro**.
- **Windows 8.x:** Navigate to the **Apps** screen and select **Document Capture Pro**.
- **Windows (other versions):** Click  or **Start**, and select **All Programs** or **Programs**. Select **Epson Software > Document Capture Pro**.

You see the Document Capture Pro window.

Note: Add and select your product in the Epson Scan 2 **Scanner Settings** list, if necessary. Open Epson Scan 2, then select **Settings** from the **Scanner** drop-down list.

3. Select the **Simple Scan** tab.

You see a window like this:

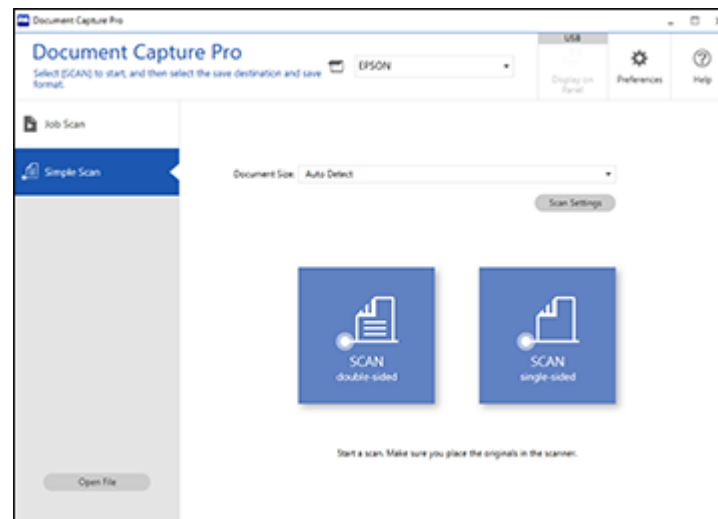

4. If you want to select specific scan settings for the scan, click the **Scan Settings** button, select any displayed settings you want to use, and click **OK**.

Note: See the help information in Document Capture Pro for details.

5. Do one of the following:
 - To scan both sides of an original, select **SCAN double-sided**.

- To scan the front side of an original, select **SCAN single-sided**.

Your product starts scanning and you see the Edit Scanned Results window.

6. View and edit the scanned pages as necessary and click **Next** when you are finished.

Note: See the help information in Document Capture Pro for details.

7. Click one of the cloud server or service destination icons. You see the settings window.
8. Enter any required information to set up the destination. You may need to log in to your cloud service to authenticate the connection and allow Document Capture Pro to access the cloud service.
9. Adjust any settings and click **Complete**.

Note: See the help information in Document Capture Pro for details.

Your originals are uploaded to the indicated server or cloud service.

Parent topic: [Scanning Special Projects](#)

Scanning to a SharePoint Server or Cloud Service - Mac

You can use Document Capture to upload scanned images to a SharePoint server or a cloud service.

Note: The screen shown may vary, depending on your OS version.

1. Open the **Applications** folder, open the **Epson Software** folder, and select **Document Capture**.

You see a window like this:

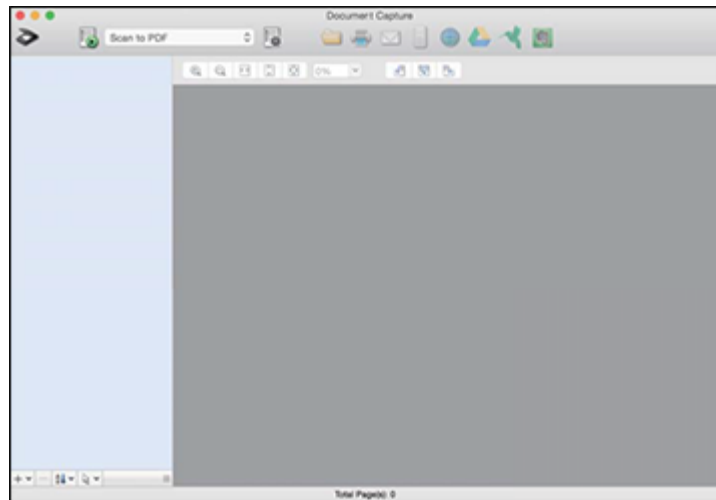

Note: You may need to select your product from the drop-down list.

2. Click the  scan icon.
3. Select any displayed scan settings you want to use.

Note: See the Help information in Document Capture for details.

4. Click **Scan**.
You see a preview of your scan in the Document Capture window.
5. Click one of the cloud service Destination icons to choose where to save your scanned file. (If you cannot see all of the icons, the service software may not be installed, the service may not be available on your platform, or you need to click the arrow next to the icons.)

You see the Transfer Settings window.

6. Enter any required information to set up the destination. You may need to log in to your cloud service to authenticate the connection and allow Document Capture to access the cloud service. If you have previously created a saved setting for the destination, select it from the drop-down list.
7. Adjust any save settings, then click **OK** or **Send**, depending on the destination.



Your originals are scanned and uploaded to the indicated server or cloud service.

Parent topic: [Scanning Special Projects](#)

Scanning Multi-Page Originals as Separate Files - Windows

You can use Document Capture Pro to scan multi-page originals as separate scanned files. You can indicate how the separate files are created by defining a maximum page count per file or by inserting blank pages, barcodes, or characters that can be detected by the software as separation markers.

Note: Settings may vary depending on the software version you are using. Click the **Help** icon in Document Capture Pro at any time for more information.

1. Load your multi-page original in the product.
2. Do one of the following to start Document Capture Pro:
 - **Windows 11:** Click , then search for **Document Capture Pro** and select it.
 - **Windows 10:** Click  and select **Epson Software > Document Capture Pro**.
 - **Windows 8.x:** Navigate to the **Apps** screen and select **Document Capture Pro**.
 - **Windows (other versions):** Click  or **Start**, and select **All Programs** or **Programs**. Select **Epson Software > Document Capture Pro**.

You see the Document Capture Pro window.

Note: Add and select your product in the Epson Scan 2 **Scanner Settings** list, if necessary. Open Epson Scan 2, then select **Settings** from the **Scanner** drop-down list.

3. Select the **Job Scan** tab.

You see a window like this:

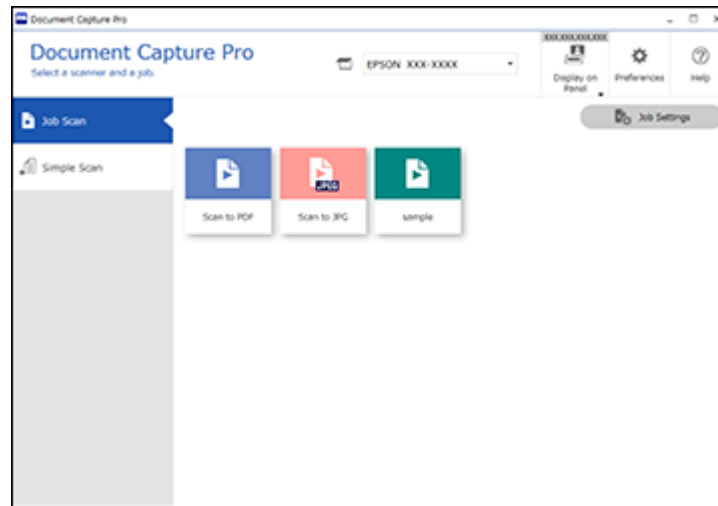

4. Click the **Job Settings** button.

You see a window like this:

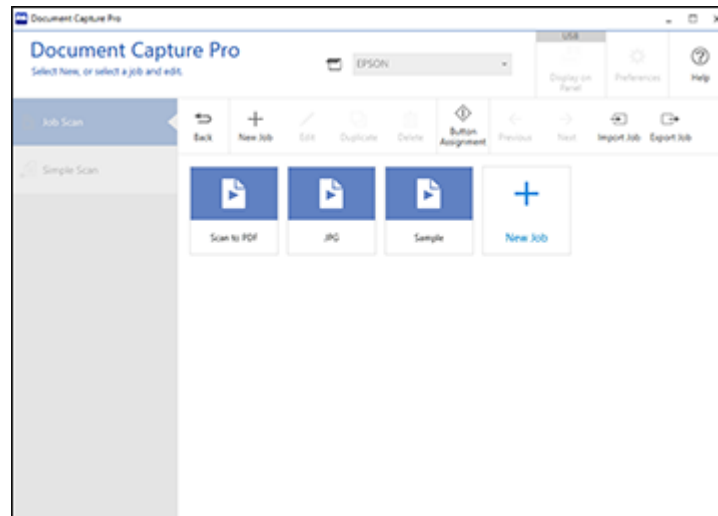

5. Select **New Job** and select the scan settings. Click **Next** when finished.
You see a window like this:

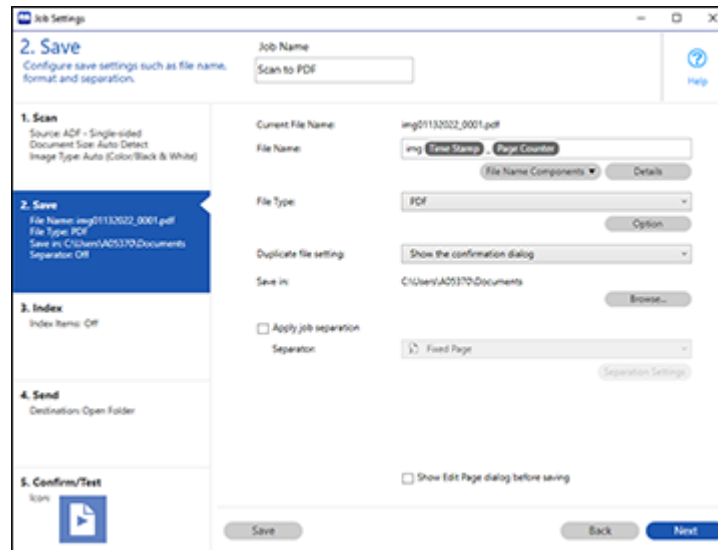

6. Select the **Apply job separation** checkbox.
7. Select the method you want to use to separate the originals as the **Separator** setting. Click **Separation Settings** to specify the settings for the selected option.
8. Finish creating the new scan job and click **Save**.
9. Click **Back** on the Job Settings screen.

Your originals are saved into separate files and folders as specified when the job is run.

Parent topic: [Scanning Special Projects](#)

Faxing

See these sections to fax using your product.

Note: This product allows you to store names, telephone numbers, and fax data in its memory even when the power is turned off. Make sure you restore all of the default settings if you give away or dispose of the product. This will erase all of your network settings and fax data.

Note: When using the PCL or PostScript (PS3) printer software with the product, you can fax using the printer buttons or the utilities included with the standard Epson printer software. To download the standard Epson printer software, visit epson.com/support (U.S.), epson.ca/support (Canada), or latin.epson.com/support (Latin America) and select your product.

[Connecting a Telephone or Answering Machine](#)

[Setting Up Fax Features](#)

[Setting Up Contacts and Contact Groups](#)

[Sending Faxes](#)

[Receiving Faxes](#)

[Checking Fax Status](#)

[Printing Fax Reports](#)

Connecting a Telephone or Answering Machine

You must connect your product to a telephone wall jack to send or receive faxes. If you want to use the same telephone line to receive calls, you can connect a telephone or answering machine to your product using an additional phone cable.

Note: In areas where lightning strikes occur frequently, we recommend that you use a surge protector.

Note: If you do not connect a telephone to your product, make sure Receive Mode is set to **Auto**. Otherwise, you cannot receive faxes.

1. Connect a phone cable to your telephone wall jack and to the **LINE** port on your product.

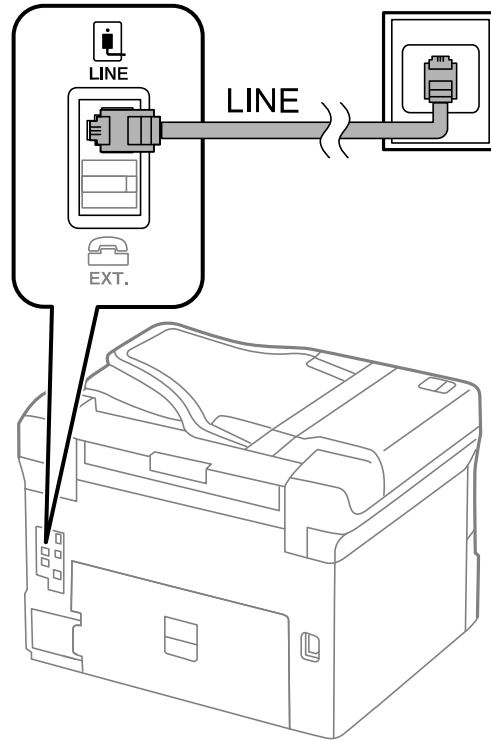

Note: If you have a DSL or ISDN connection, you must connect the appropriate DSL filter, or ISDN terminal adapter or router to the wall jack to be able to use the line for faxing or voice calls using your product. Contact your DSL or ISDN provider for the necessary equipment.

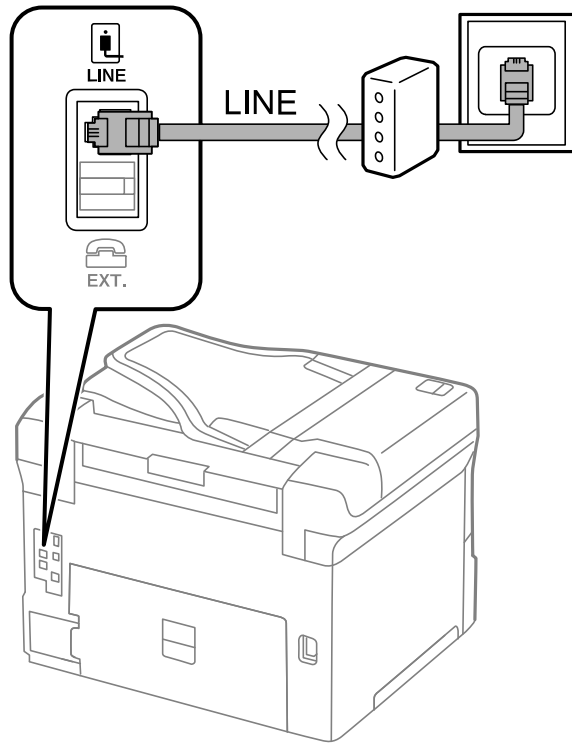

2. If you are connecting a telephone or answering machine to your product using a second phone cable, remove the cap from the **EXT** port on your product.

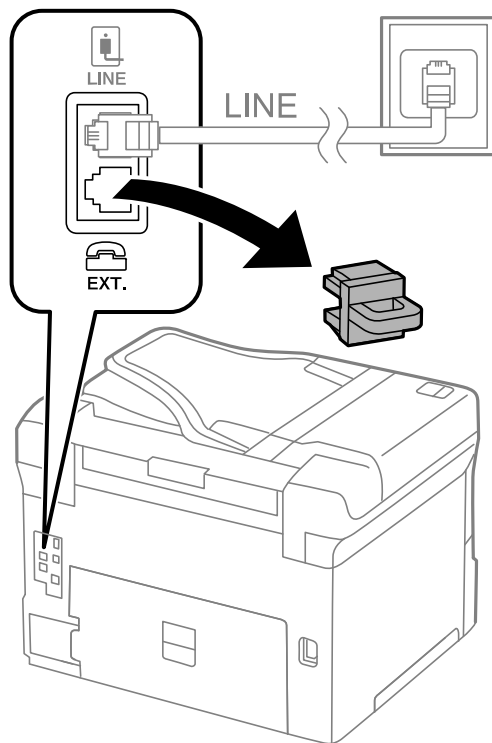

3. Connect a second phone cable to your telephone or answering machine and to the **EXT** port on your product.

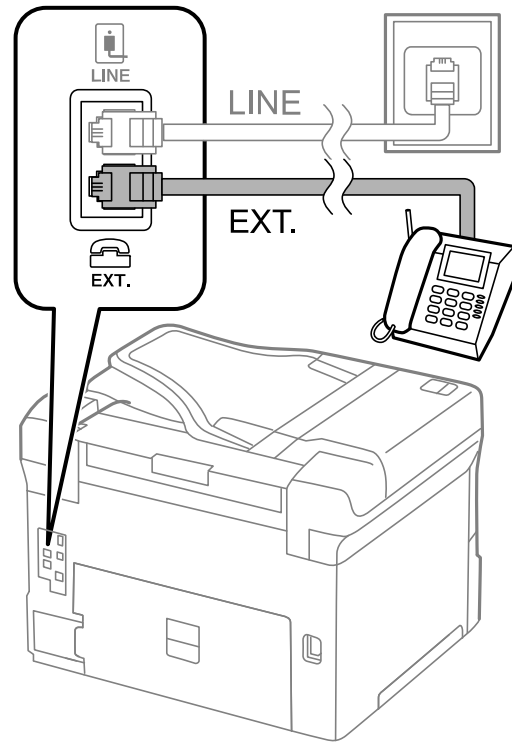

Note: If you connect an answering machine and Receive Mode is set to **Auto**, set the number of rings before your product answers a call to a number that is higher than your answering machine's setting for the number of rings.

Parent topic: [Faxing](#)

Related references

[Cannot Receive Faxes with a Telephone Connected to Your Product](#)

Related tasks

[Using the Fax Setting Wizard](#)

[Receiving Faxes Automatically](#)

Setting Up Fax Features

Before faxing with your product, set up your fax header and select the fax features you want to use.

Note: If you leave your product unplugged for a long period of time, you may need to reset the date and time settings for faxes.

[Setting Up Basic Fax Features](#)

[Selecting Advanced Fax Settings](#)

[Setting Up the Fax Utility - Windows](#)

[Setting Up Fax Features Using the Fax Utility - Mac](#)

Parent topic: [Faxing](#)

Setting Up Basic Fax Features

See these sections to select the basic settings you need to use the product's fax features.

[Using the Fax Setting Wizard](#)

[Selecting the Line Type](#)

[Setting the Number of Rings to Answer](#)

Parent topic: [Setting Up Fax Features](#)

Using the Fax Setting Wizard

You can setup the product's basic fax settings using the Fax Setting Wizard. This wizard is automatically displayed when the product is turned on for the first time. You can also change these settings individually from the Fax Settings menu.

1. Press the  home button, if necessary.
2. Select **Settings > General Settings > Fax Settings > Fax Setting Wizard**.
3. Connect your phone line and select **Proceed**.
4. On the next screen, use the displayed keypad to enter the sender name for your fax source, such as your name or a business name. You can enter up to 40 characters. Select **OK** when complete.
5. On the next screen, use the displayed keypad to enter your fax number, up to 20 characters. Select **OK** when complete.

Note: The name and phone number in the fax header identifies the source of the faxes you send.

6. On the Distinctive Ring Setting screen, do one of the following:
 - If you have subscribed to a distinctive ring service from your telephone company, select **Proceed**. Select the ring pattern to be used for incoming faxes. If you select **All**, skip to step 7. Otherwise, skip to step 9.
 - If you do not have a distinctive ring service, select **Skip** and skip to step 9.

Note: Distinctive ring services allows you to have several phone numbers on one phone line. Each number is assigned a different ring pattern. You can use one number for voice calls and another for fax calls. Select the ring pattern assigned to fax calls in the Distinctive Ring Setting. If you select a ring pattern other than **All**, Receive Mode is automatically set to **Auto**.

7. On the Receive Mode Setting screen, do one of the following:
 - If you have connected an external telephone or answering machine to the product, select **Yes**.
 - If you did not connect an external telephone or answering machine, select **No** and skip to step 9. (Receive Mode is automatically set to **Auto**; otherwise you cannot receive faxes.)
8. On the next Receive Mode Setting screen, select **Yes** to receive faxes automatically or select **No** to receive faxes manually.

Note: If you connect an external answering machine and select to receive faxes automatically, make sure the **Rings to Answer** setting is correct. If you select to receive faxes manually, you need to answer every call and operate the product's control panel or your phone to receive faxes.

9. On the Proceed screen, confirm the displayed settings and select **Proceed**, or press the back arrow to change the settings.
10. On the Run Check Fax Connection screen, select **Start Checking** and follow the on-screen instructions to check the fax connection and print a report of the check result. If there are any errors reported, try the solutions on the report and run the check again.

If the Select Line Type screen appears, select the correct line type.

If the Select Dial Tone Detection screen appears, select **Disable**. However, disabling the dial tone detection function may drop the first digit of a fax number and send the fax to the wrong number.

Parent topic: [Setting Up Basic Fax Features](#)

Related tasks

[Entering Characters on the LCD Screen](#)

Selecting the Line Type

If you connect the product to a PBX phone system or terminal adapter, you must change the product's line type. PBX (Private Branch Exchange) is used in office environments where an external access code such as "9" must be dialed to call an outside line. The default Line Type setting is PSTN (Public Switched Telephone Network), which is a standard home phone line.

1. Press the  home button, if necessary.
2. Select **Settings > General Settings > Fax Settings > Basic Settings > Line Type > PBX**.
3. Select **Access Code** and select **Use**.
4. Select the **Access Code** field and use the displayed keypad to enter the access code, such as 9. Then select **OK**.
5. Select **OK** to exit.

Parent topic: [Setting Up Basic Fax Features](#)

Setting the Number of Rings to Answer

If you connect an external answering machine and select to receive faxes automatically, make sure the Rings to Answer setting is correct. The number of rings should be higher than the number of rings your answering machine is set to for answering a call.

1. Press the  home button, if necessary.
2. Select **Settings > General Settings > Fax Settings > Basic Settings > Rings to Answer**.
3. Select the number of rings and select **OK**. Make sure to select a number higher than the number of rings your answering machine is set to for answering a call.

Note: An answering machine picks up every call faster than the product, but the product can detect fax tones and start receiving faxes. If you answer the phone and hear a fax tone, check that the product has started receiving the fax, then hang up the phone.

Parent topic: [Setting Up Basic Fax Features](#)

Selecting Advanced Fax Settings

You can select a variety of advanced fax settings.

1. Press the  home button, if necessary.
2. Select **Settings > General Settings > Fax Settings**.

- If you want to create shortcuts for up to three fax operations, select **Quick Operation Button** and select a setting and a shortcut button.

Note: These shortcuts are displayed on the Fax Settings tab in the main **Fax** screen.

- Select the group of settings you want to change.

[Basic Settings - Fax](#)

[Send Settings - Fax](#)

[Receive Settings - Fax](#)

[Report Settings - Fax](#)

[Security Settings - Fax](#)

Parent topic: [Setting Up Fax Features](#)

Basic Settings - Fax

Select the basic options you want to use for incoming and outgoing faxes.

Setting	Options	Description
Fax Speed	Fast(33,600bps)	Sets the speed at which you send and receive faxes
	Medium(14,400bps)	
	Slow(9,600bps)	
ECM	On	Turns on Error Correction Mode (ECM) to automatically correct errors in sent or received fax data
	Off	Turns off Error Correction Mode (ECM); color faxes cannot be sent or received
Dial Tone Detection	On	Automatically dials the number you enter for faxing when the product detects a dial tone
	Off	Turns off automatic dial tone detection, which may be necessary if the product is connected to a PBX (Private Branch Exchange) or a TA (Terminal Adapter). However, turning this setting off may cause the product to drop the first digit of a fax number.
Dial Mode	Various types of phone systems	Selects the type of phone system you have connected to the printer.

Setting	Options	Description
Line Type	PSTN	Selects a standard phone line (Public Switched Telephone Network)
	PBX	Selects Private Branch Exchange, the type of phone line used in office environments where an access code such as 9 must be used to call an outside line
Header	Your Phone Number	Select to enter the header information and your phone number for inclusion on outgoing faxes
	Fax Header	
Receive Mode	Manual	Lets you confirm whether an incoming fax should be printed; a telephone must be connected to the product
	Auto	Automatically receives and prints faxes
Distinctive Ring	All	If you are using a Distinctive Ring Service on your phone line, your telephone company can assign two or more phone numbers to the same line and assign different ring patterns to each. If you use this service, select the number of rings for your fax number so your product can receive faxes on the correct number of rings. Select All for phones lines that do not use this service.
	Single	
	Double	
	Triple	
	Double&Triple	
Rings to Answer	1 to 9	Sets the number of rings before your product receives a fax. If Receive Mode is set to Auto and an answering machine is connected to the product, make sure this setting is set higher than the number of rings your answering machine is set to answer a call.
Remote Receive	Off	Lets you start receiving faxes using your phone instead of operating the product (if the Receive Mode is set to Auto). When you select On , you must also set a Start Code . If you are using a cordless handset with its base connected to the product, you can start receiving the fax by entering the code using the handset.
	On	
	Start Code	

Setting	Options	Description
Rejection Fax	Various	Lets you automatically reject faxes from blocked numbers, with blank headers, or from unrecognized contacts
Receiving Paper Size	A4/Letter	Select the maximum paper size for faxes that the product can receive.
	B4	
	A3/11x17	
	Auto	
Save/Forward File Format	PDF	Saves or forwards a fax as a PDF file. You can also set a password for opening the PDF or allowing printing and editing permissions.
	TIFF	Saves or forwards a fax as a TIFF file.
Cloud Destination List	Various	Allows user to register up to five addresses at a cloud service recognized by Epson Connect. Received faxes may be forwarded to the selected cloud service. To use this feature, the printer must be registered with Epson Connect.

Parent topic: [Selecting Advanced Fax Settings](#)

Send Settings - Fax

Select the send options you want to use for outgoing faxes.

Setting	Options	Description
Auto Rotation	Off	Sends an A4 or letter-size document that is placed long edge first into the ADF as an A3-size fax
	On	
Quick Memory Send	Off	Sends the first page of a multi-page document as soon as it finishes scanning. Select this option to decrease the amount of time it takes to fax a document.
	On	
Batch Send	Off	Sorts outgoing faxes by recipient in the product's memory, and then sends them as a batch
	On	

Setting	Options	Description
Save Failure Data	Off	Saves faxes that failed to be sent in the product's memory. You can resend the faxes from the product's Status Menu.
	On	
Wait Time for Next Original	Off	Sets a time in between sending the next fax
	On	
Fax Preview Display Time	Off	Sets a time for previewing the scanned document on the LCD screen before it is sent
	On	
Allow Backup	Allowed	Allows you to back up sent faxes. Select Fax > Fax Settings > Backup to view backed up faxes.
	Not Allowed	

Parent topic: [Selecting Advanced Fax Settings](#)

Receive Settings - Fax

Set the save/forward or print options you want to use for incoming faxes.

Save/Forward Settings

Setting	Options	Description
Unconditional Save/Forward	Save to Inbox	Saves received faxes in printer's inbox
	Save to Computer	Converts received faxes to PDFs and saves them on a computer connected to the printer
	Save to Memory Device	Converts received faxes to PDFs and saves them on an external memory device connected to the printer
	Forward	Forwards received faxes to another fax machine, or converts them to PDFs or TIFFs and forwards them to a shared folder on a network, or an email address. You can also forward them to a cloud destination in either PDF or JPEG format. Forwarded faxes are deleted from the printer.
	Email Notifications	Sends an email notification after a fax is received, printed, saved, or forwarded

Setting	Options	Description
Conditional Save/Forward	—	Sets up conditions to save, forward, or print received faxes. Select Unregistered to enter conditions and other settings.
Common Settings	Inbox Settings	Sets up what happens when the fax memory is full, or sets up a password for the inbox.
	Email Subject to Forward	Specifies a subject when forwarding a fax to an email address.
	Box Document Delete Settings	Select On to automatically delete received faxes after a set period of time.

Print Settings

Setting	Options	Description
Auto Reduction	On	Select to reduce the size of large received faxes to fit on the paper size in the selected paper source.
	Off	Select to print large incoming faxes at their original size on multiple sheets, if necessary.
Split Page Settings	Delete Print Data After Split	Select how to split large incoming faxes across multiple sheets when using the Auto Reduction option.
	Overlap When Split	
Acting Print	On(Split to Pages)	Select to split large incoming faxes across multiple sheets.
	On (Reduce to Fit)	Select to reduce the size of large received faxes to fit on the paper size in the selected paper source.
	Off	Select to print large incoming faxes at their original size on multiple sheets, if necessary.
Auto Rotation	On	If you have loaded A5-size paper, select On to rotate landscape-oriented incoming faxes so that they print correctly on the paper.
	Off	
Add Reception Information	On	Select On to include the date, time, the sender's information, and a page number in the header of your incoming faxes.
	Off	

Setting	Options	Description
2-Sided	On	Select On to print incoming faxes double sided. You can also select the Binding Margin .
	Off	
Print Start Timing	All Pages Received	Select to print incoming faxes after the product receives all of the pages of the document.
	First Page Received	Select to print incoming faxes as soon as the product receives the first page of the document.
Collation Stack	On	Select On to print incoming faxes so that the pages are stacked in the correct page order. (When the product is low on memory, this option may not be available.)
	Off	
Print Suspend Time	Off	Select On to set a time period to stop automatic printing of faxes or reports and save received faxes in the product's memory. (Make sure there is enough free memory before using this function.)
	On	
	Time to Stop	
	Time to Restart	
Quiet Mode	On	Select On to reduce noise during printing (printing speed may be reduced).
	Off	

Parent topic: [Selecting Advanced Fax Settings](#)

Report Settings - Fax

Select the options you want to use for fax reports.

Setting	Options	Description
Forwarding Report	Print on Error	Prints a report after forwarding a received document only if an error occurs
	Print	Prints a report after forwarding a received document
	Do Not Print	Does not print a report after forwarding a received document
Backup Error Report	On	Select On to print a report when a backup error for sending faxes occurs
	Off	

Setting	Options	Description
Fax Log Auto Print	Off	Does not print a fax log
	On(Every 100)	Prints a fax log after every 100 fax jobs are completed
	On(Time)	Prints a fax log at a specified time. If the number of completed fax jobs exceeds 30, the fax log prints before the specified time.
Reception Report	Print on Error	Prints a report after receiving a fax only if an error occurs
	Print	Prints a report after receiving a fax
	Do Not Print	Does not print a report after receiving a fax
Attach Fax image to report	Off	Does not include an image on the Transmission Report
	On(Large Image)	Prints a Transmission Report that includes the upper part of the first page of the sent document
	On(Small Image)	Prints a Transmission Report that includes a reduced size of the entire first page of the sent document
Fax Log Layout	Combine Send and Receive	Prints a Transmission Report and a Reception Report on the same sheet when you print a fax log
	Separate Send and Receive	Prints a Transmission Report and a Reception Report on separate sheets when you print a fax log
Report Format	Simple	Prints a simple fax report
	Detail	Prints a fax report that includes error codes
Fax Log Output Method	Print	Prints fax reports
	Save to Memory Device	Saves fax reports to an inserted memory device. Select Create a folder to save fax data to create a folder on the inserted memory device.
	Forward	Forwards fax reports to a specified destination

Parent topic: [Selecting Advanced Fax Settings](#)

Security Settings - Fax

Select the security options you want to use for fax data.



Setting	Options	Description
Direct Dialing Restrictions	Off	Does not restrict dialed fax numbers.
	On	Allows faxing only to numbers stored in the contacts list or history.
	Enter Twice	Requires you to enter fax numbers twice to prevent errors.
Broadcasting Restrictions	Off	Select On to allow only one fax number to be entered as the recipient
	On	
Confirm Address List	Off	Selects whether or not to display a recipient confirmation screen before a fax is sent.
	On	
Backup Data Auto Clear	Off	Automatically erases sent or received fax data from your product's memory.
	On	
Clear Backup Data	—	Deletes all sent or received fax data remaining in your product's memory; run this function if you are giving away or disposing of your product.

Parent topic: [Selecting Advanced Fax Settings](#)

Setting Up the Fax Utility - Windows

You can set up the FAX Utility for Windows for use with your product.

Note: Before using the FAX Utility for Windows, make sure you have set up the fax features on your product using the product control panel. Also first confirm that you can send and receive faxes using the control panel.

- Do one of the following:
 - Windows 11:** Click , then search for **EPSON Software** and select it.
 - Windows 10:** Click  and select **EPSON Software**.
 - Windows 8.x:** Navigate to the **Apps** screen.
 - Windows (other versions):** Click  or **Start > Programs** or **All Programs > EPSON Software**.
- Select **FAX Utility**.

The first time you use the FAX Utility, you see this introduction window:

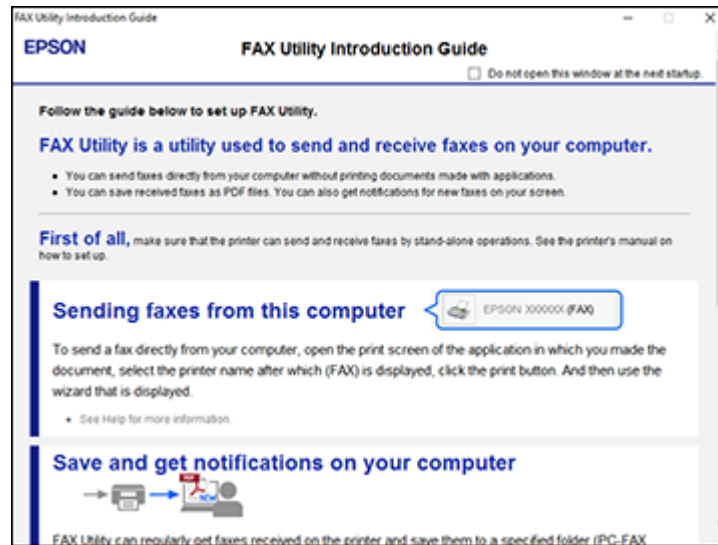

3. Read about the FAX Utility and click **Return to the main window** at the bottom of the window.

You see this window:

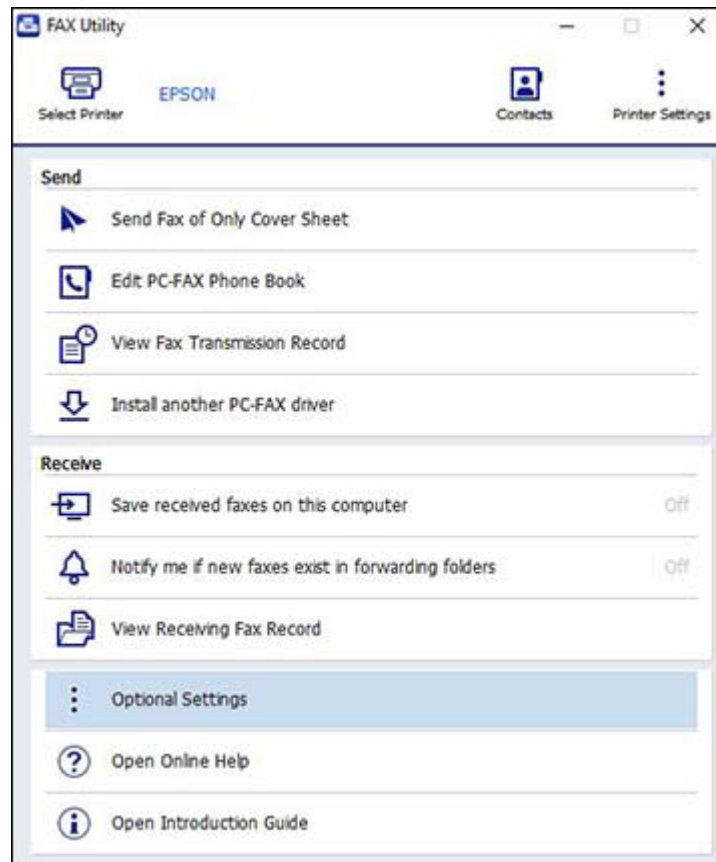

4. Click **Select Printer** and follow the on-screen instructions to transfer your product's fax settings to the FAX Utility.

Note: For detailed information, click **Help** or **Open Online Help**.

Parent topic: [Setting Up Fax Features](#)

Setting Up Fax Features Using the Fax Utility - Mac

You can set up your fax header and select your fax settings using the FAX Utility for Mac.

1. In the Apple menu or the Dock, select **System Preferences** or **System Settings**. Select **Print & Fax**, **Print & Scan**, or **Printers & Scanners**, select the **FAX** option for your product, and select **Options & Supplies**. Select **Utility** and select **Open Printer Utility**.
2. Double-click **FAX Utility**, if necessary.

You see a window like this:

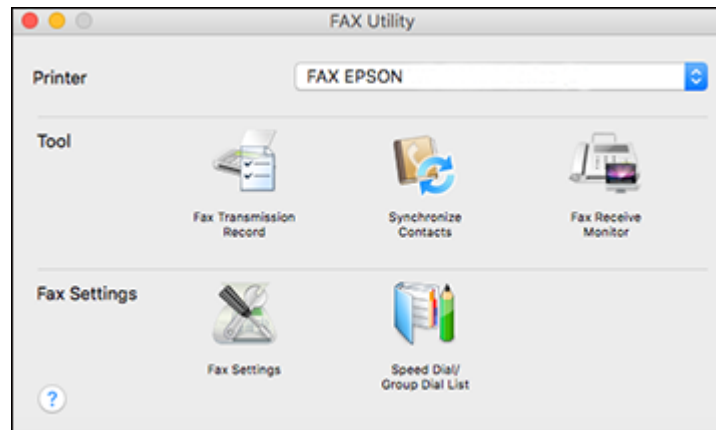

3. Select your **FAX** product in the Printer list.
4. Select **Fax Settings**.
5. Follow the prompts that appear on the screen to enter your fax header information and select your fax settings.

Note: For detailed information, select the FAX Utility ? icon.

Parent topic: [Setting Up Fax Features](#)

Setting Up Contacts and Contact Groups

You can set up a list of contacts and their fax numbers so you can quickly select them for faxing. You can also set up contact groups to send a fax message to multiple contacts.

[Setting Up Contacts Using the Product Control Panel](#)

Parent topic: [Faxing](#)

Setting Up Contacts Using the Product Control Panel

You can set up your contacts and contact groups using the control panel on your product.

Note: Contacts can be locked by an administrator. If you cannot access or change contacts, contact your administrator for assistance.

[Creating a Contact](#)

[Editing or Deleting a Contact](#)

[Creating a Contact Group](#)



[Editing or Deleting a Contact Group](#)

Parent topic: [Setting Up Contacts and Contact Groups](#)

Creating a Contact

You can create a list of contacts to save frequently used fax numbers.

Note: You can create up to 200 contacts and contact groups combined.

1. Press the  home button, if necessary.
2. Select **Fax > Contacts**.
3. Select the  icon.
4. Select **Add Contact**.
5. Select the registry number you want to use for the contact you are adding.
6. Select the **Name** field, use the displayed keyboard to enter the contact name (up to 30 characters), and select **OK**.
7. Select the **Index Word** field, use the displayed keyboard to enter a word to use when searching for an entry (up to 30 characters), and select **OK**. (This field is optional.)
8. Select the **Fax Number** field, use the numeric keypad on the LCD screen or the buttons on the product to enter the fax number, and select **OK**. You can enter up to 64 characters.

Note: If necessary, enter an outside line access code (such as **9**) at the beginning of the fax number. If the access code has been set up in the **Line Type** setting, enter the **#** pound sign instead of the code.

9. If you are sending a fax to a confidential box or relay box, enter a sub-address and password in the **Subaddress (SUB/SEP)** and **Password (SID/PWD)** fields.
10. Select any additional settings as necessary.
11. Select **OK** to save the entry.

Parent topic: [Setting Up Contacts Using the Product Control Panel](#)

Editing or Deleting a Contact

You can edit or delete any of the contacts on your list.



1. Press the  home button, if necessary.
2. Select **Fax > Contacts**.
3. Select the tab containing the first letter of the contact name, then select the **>** icon next to the contact you want to edit or delete.
4. Do one of the following:
 - To delete the contact, select **Delete** and select **Yes** on the confirmation screen.
 - To edit the contact, select **Edit**, select the item you want to change, enter the correct information, and select **OK**. When you are finished editing, select **OK**.

Parent topic: [Setting Up Contacts Using the Product Control Panel](#)

Creating a Contact Group

You can create a group of contacts so that you can easily send faxes to multiple recipients.

Note: You can create up to 200 contacts and contact groups combined. You must create a contact before creating a contact group.

1. Press the  home button, if necessary.
2. Select **Fax > Contacts**.
3. Select the  **Add Contact** icon.
4. Select **Add Group**.
5. Select the registry number you want to use for the group you are adding.
6. Select the **Group Name** field, use the displayed keyboard to enter the group name (up to 30 characters), and select **OK**.

7. Select the **Index Word** field, use the displayed keyboard to enter a word to use when searching for a group (up to 30 characters), and select **OK**. (This field is optional.)
8. Select the **Contact(s) Added to the Group** field.
You see your contacts list.
9. Select each contact you want to include in your group.
A check mark appears next to each selected contact.
10. Select **Close** when complete.
11. Select **Assign to Frequent Use** to list the group on the **Recipient** tab.
12. Select **OK** to save the group.

Parent topic: [Setting Up Contacts Using the Product Control Panel](#)

Editing or Deleting a Contact Group

You can edit an existing contact group to add or delete entries. You can also delete the entire contact group.

1. Press the  home button, if necessary.
2. Select **Fax > Contacts**.
3. Select the **>** icon next to the group you want to edit or delete.
4. Do one of the following:
 - To delete the group, select **Delete** and select **Yes** on the confirmation screen.
 - To edit the group, select **Edit** and change the group name or contacts included as necessary.
5. Select **OK** when complete.

Parent topic: [Setting Up Contacts Using the Product Control Panel](#)

Sending Faxes

See these sections to send faxes using your product.

[Sending Faxes from the Product Control Panel](#)

[Sending Faxes Using the Fax Utility - Windows](#)

[Sending Faxes Using the Fax Utility - Mac](#)

Parent topic: [Faxing](#)

Sending Faxes from the Product Control Panel

See these sections to send faxes using the product's control panel.

[Sending a Fax Using the Keypad, Contact List, or History](#)

[Fax Sending Options](#)

[Sending a Fax at a Specified Time](#)

[Receiving a Fax by Polling](#)

[Sending a Stored Fax](#)

[Dialing Fax Numbers from a Connected Telephone](#)

Parent topic: [Sending Faxes](#)

Sending a Fax Using the Keypad, Contact List, or History

You can send a fax from your product control panel by entering the fax number, or selecting the number from either the contact list or fax history.

Note: You can send a black-and-white fax to up to 200 recipients at a time, or send a color fax to one recipient at a time. If your recipient's fax machine does not print in color, your fax is automatically sent in black-and-white.

1. Place your original on the product for faxing.
2. Press the  home button, if necessary.
3. Select **Fax**.
4. Do one of the following to select fax recipients:
 - **Manually enter a fax number:** Select **Keypad**, enter a fax number, and select **OK**. To add another fax number, repeat the same steps. You can also use the numeric keypad on the control panel to enter a fax number.

Note: If direct dialing has been restricted, you can only select the number from the contact list or fax history. If necessary, enter an outside line access code (such as 9) at the beginning of the fax number. If the access code has been set up in the **Line Type** setting, enter the # pound sign instead of the code. If your fax number requires a brief pause, select the - icon to insert a pause symbol (-).

- **Select from the contact list:** Select **Contacts** to display the contact list. Select one or more contacts (select the contacts again to deselect it). You can also select the **Search for Contacts** field to search for recipients by name, index name, or entry number. Select **Close** when you are finished.

- **Select from the sent fax history:** Select **Recent** to display the sent fax history. Select a recipient from the list.

Note: To delete entered recipients, select the **Select Recipient** field, select the recipient you want to delete, and select **Remove**.

5. If you need to change any fax settings, select **Fax Settings** and select your settings.
6. If you want to preview your fax in black-and-white on the LCD, press the  icon. (If the preview looks incorrect, select **Retry**, reposition the document or change the fax settings, and repeat this step.) You cannot send the fax in color after previewing it.

Note: If you do not touch the preview screen for 20 seconds, your product sends the fax automatically. You cannot preview images when the Direct Send setting is turned on.

7. If you want to save your fax settings for later use, select **Presets** and add a new entry.
8. Press the **Send** icon.

Note: To cancel faxing, select **Cancel**.

Your product scans your original and prompts you to place additional pages, if necessary. After scanning your originals, your product dials the number and sends the fax.

Note: Your product does not save sent color faxes to its memory. If the **Settings > General Settings > Fax Settings > Send Settings > Save Failure Data** setting is enabled, faxes that failed to send are stored to the product's memory and you can resend them from **Job** in the **Job/Status** screen.

Parent topic: [Sending Faxes from the Product Control Panel](#)

Related references

[Fax Sending Options](#)

Related tasks

[Using Presets](#)

[Selecting the Line Type](#)

Related topics

[Setting Up Contacts and Contact Groups](#)

[Placing Originals on the Product](#)

Fax Sending Options

While sending a fax, you can select **Fax Settings** and select these options.

Setting	Options	Description
Original Size (Glass)	Various sizes	Sets the size for a document placed on the scanner glass
Original Type	Text	Specifies the document type of your originals and adjusts the quality of your copies
	Text & Image	
	Photo	
Color Mode	B&W	Select whether to scan images in black and white or color
	Color	
Resolution	Standard	Adjusts the scan resolution and print quality of outgoing faxes
	Fine	
	Super Fine	
	Ultra Fine	
Density	Varying levels	Lets you select from various density levels
Remove Background	Auto	Automatically removes any background color on scanned images
	Varying levels available	Lets you select from various levels of background color adjustment
Sharpness	Varying levels available	Lets you adjust the sharpness level of outgoing faxes
ADF 2-Sided	Off	Select On to enable 2-sided faxing from the ADF. The Direct Send option and color faxing are disabled when you turn on this setting.
	On	

Setting	Options	Description
Continuous Scan (ADF)	Off	<p>Select On to have the product to prompt if you want to scan another page after a document in the ADF has finished scanning.</p> <p>If you leave the product with the prompt displayed for 20 seconds, the product starts sending the document.</p> <p>If you load multiple sizes of documents in a single batch, they are sent at the size of the largest document. To send them at their original size, do not mix sizes in the ADF.</p>
	On	
Direct Send	Off	<p>Select On to send black-and-white faxes to a single recipient as soon as the connection is made, without saving the scanned image to memory. You cannot use this setting when sending a color fax or sending a fax to multiple recipients.</p>
	On	
Priority Send	Off	<p>Select On to send the current fax before other faxes waiting to be sent</p>
	On	
Send Fax Later	Off	<p>Select On to send the current fax at a selected time</p>
	On	
Add Sender Information	Off	<p>Lets you include a header, your phone number, or a destination list in the selected location on your outgoing faxes</p>
	Outside of Image	
	Inside of Image	
Notify Send Result	Off	<p>Sends a notification to the selected email address when an outgoing fax is sent</p>
	On	
Transmission Report	Print on Error	<p>Lets you select when to print transmission reports</p>
	Print	
	Do Not Print	
Backup	Off	<p>Saves a copy of the scanned fax to the selected email address or network folder/FTP location</p>
	On	

Parent topic: [Sending Faxes from the Product Control Panel](#)

Sending a Fax at a Specified Time

You can send a fax at a time of your choice.

Note: Make sure the product's date and time settings are correct. You can only send faxes in black-and-white when you use this option.

1. Place your original on the product for faxing.
2. Press the  home button, if necessary.
3. Select **Fax**.
4. Enter a fax number or select a number from the **Contacts** or **Recent** lists.
5. Select **Fax Settings**.
6. Select **Send Fax Later**.
7. Select **On**.
8. Select **Time**, use the displayed keypad on the LCD screen to enter your desired time, and select **OK**.
9. Select **Send**.

Note: To cancel faxing, select **Cancel**.

After scanning your originals, your product dials the number and sends the fax at the specified time.

Note: If the product is turned off at the specified time, the fax is sent when it is powered on.

Parent topic: [Sending Faxes from the Product Control Panel](#)

Related references

[Fax Sending Options](#)

Related tasks

[Selecting the Date and Time](#)

Related topics



[Placing Originals on the Product](#)

[Setting Up Contacts and Contact Groups](#)

Receiving a Fax by Polling

You can use polling to receive a fax from another fax machine (such as a fax information service).

Note: You cannot use polling to receive a fax from a fax information service that uses audio guidance.



1. Press the  home button, if necessary.
2. Select **Fax**.
3. Select the  icon.
4. Select **Extended Fax**.
5. Select **Polling Receive** to turn on the setting and select **Close**.
6. Select **Close**.
7. Enter the fax number you expect to receive the fax from.
8. Select **Polling** to start receiving the fax.

Parent topic: [Sending Faxes from the Product Control Panel](#)
[Receiving Faxes](#)

Sending a Stored Fax

You can store up to 10 scanned documents (up to 100 black-and-white pages) and send them whenever necessary.

Note: If you try to store more than 10 jobs or 100 pages, they overwrite previously stored documents. Be sure to check how many fax jobs are stored before storing additional jobs by running a Fax Report.

1. Place your original on the product for faxing.
2. Press the  home button, if necessary.
3. Select **Fax**.
4. Select the  icon.
5. Select **Extended Fax**.
6. Select **Store Fax Data** to turn on the setting and select **Close**.
7. Select any other fax settings as necessary and select **Close**.
8. Select **Store**.

9. When you are ready to send the document, press the  home button if necessary and select **Fax Box**.
10. Select **Stored Documents**.
11. Select the stored fax job you want to send.
12. Select **Start Sending**.

Parent topic: [Sending Faxes from the Product Control Panel](#)

Related references

[Fax Sending Options](#)

Related topics

[Placing Originals on the Product](#)

Dialing Fax Numbers from a Connected Telephone

If you connected a telephone to the **EXT** port on your product, you can send a fax by dialing the fax number from the connected telephone. If the recipient's phone number and fax number are the same, you can speak to the recipient before sending the fax.

1. Place your original on the product for faxing.
2. Press the  home button, if necessary.
3. Dial the fax number from the connected telephone. Speak to the recipient if necessary.

Note: If you are using a pre-paid calling card, enter the number and password required to use the card before entering the destination fax number.

4. Select **Fax** on the LCD screen.
5. Select **Fax Settings** and select settings as necessary.

Note: Your product now communicates with the recipient's fax machine. Do not hang up the telephone.

6. When you hear a fax tone, select **Send** to start sending the fax.

Note: If your recipient's fax machine does not print in color, your fax is automatically sent in black-and-white.

7. Hang up the telephone.

Parent topic: [Sending Faxes from the Product Control Panel](#)

Related references

[Fax Sending Options](#)

Related topics

[Placing Originals on the Product](#)

Sending Faxes Using the Fax Utility - Windows

You can send a fax from a printing program in Windows. You can fax up to 100 pages at a time, including a cover sheet.

1. Open the file you want to fax and select the print command.

You see a window like this:

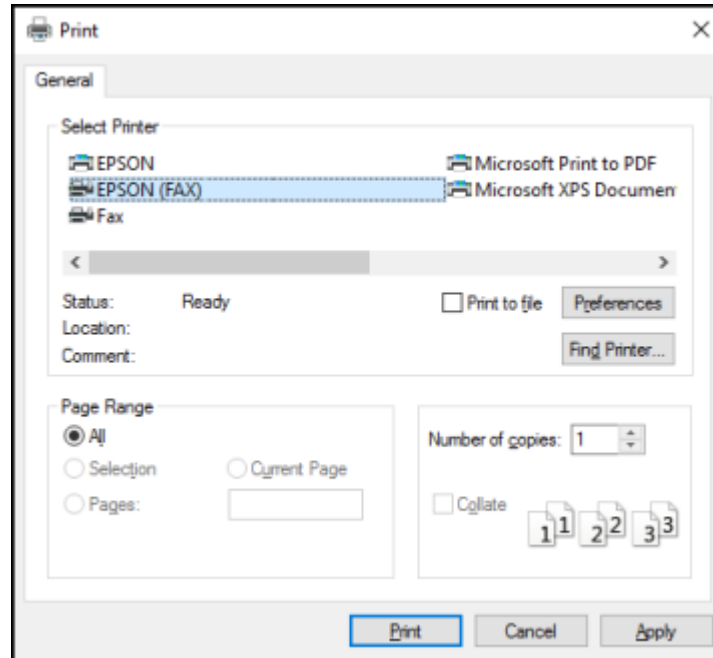

2. Select your product with the **FAX** option as the printer.

3. To change the Paper Size, Orientation, Color, Image Quality, or Character Density settings, click the **Preferences** or **Properties** button, change the necessary settings, and click **OK**.

Note: If you see a **Setup**, **Printer**, or **Options** button, click it. Then click **Preferences** or **Properties** on the next screen. For more information about selecting fax print settings, click **Help**.

4. Select the Page Range as necessary. (Leave the Number of copies set to 1.)
5. Click **Print** or **OK**.

If you're faxing for the first time, you see a window like this one:

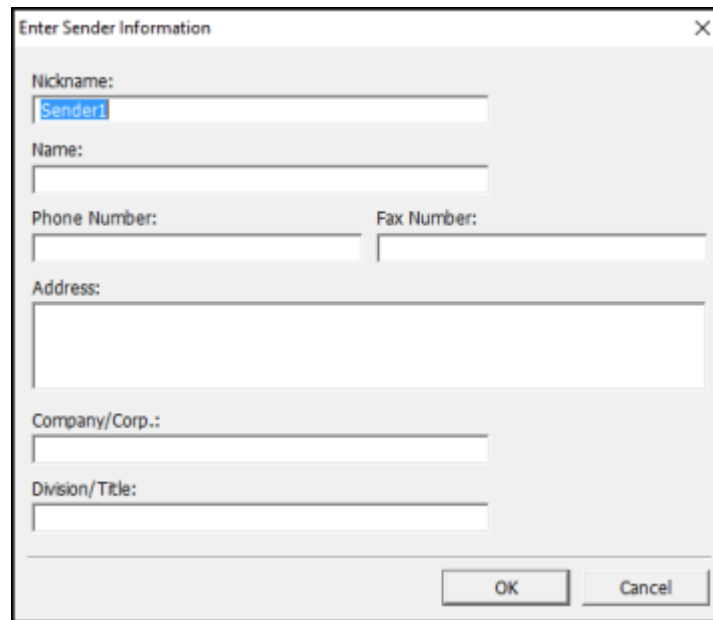

The image shows a dialog box titled "Enter Sender Information" with a close button (X) in the top right corner. The dialog contains the following fields and labels:

- Nickname: [Sender1]
- Name: []
- Phone Number: []
- Fax Number: []
- Address: []
- Company/Corp.: []
- Division/Title: []

At the bottom of the dialog are two buttons: "OK" and "Cancel".

6. Enter your sender information so that recipients can identify the origin of the fax. Then click **OK** to save the sender information.

You see a window like this:

Recipient Settings (1 / 3)

Recipient List: Recipient Total: 0

Name/Group Name	Fax Number	Company/Corp.	Division/Title
-----------------	------------	---------------	----------------

Add Delete

Phone Book Manual Dial

Name: Fax Number:

Title:

Company/Corp.: Division/Title:

Save to Phone Book... Clear

< Back Next > Cancel Help

7. Enter the recipient's name and fax number or select a recipient from the phone book, then click **Next**.

Note: For detailed instructions on using the Epson FAX Utility, click **Help**.

8. Select a cover sheet and enter a subject and message, then click **Next**.
9. Click **Send** to transmit your fax.

Parent topic: [Sending Faxes](#)

Sending Faxes Using the Fax Utility - Mac

You can send a fax from a Mac printing program using the FAX Utility. You can fax up to 100 pages at a time, including a cover sheet.

1. Open the file you want to fax.
2. Select the print command in your application.

Note: You may need to select a print icon on your screen, the **Print** option in the **File** menu, or another command. See your application's help utility for details.

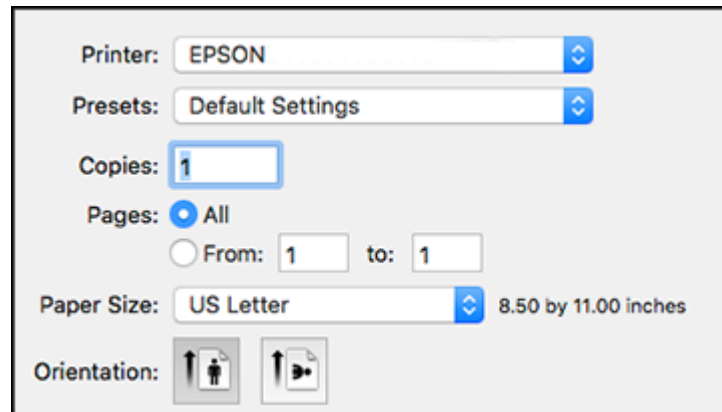

Note: The print window may look different, depending on the Mac OS version and the application you are using.

3. Select your product **FAX** option as the **Printer** setting.
4. If necessary, click the arrow next to the Printer setting or the **Show Details** button to expand the print window.
5. Select the number of pages you are faxing as the **Pages** setting.

Note: Leave the **Copies** setting set to 1.

6. Select **Recipient Settings** from the pop-up menu.

You see this window:

Recipient Settings

Recipient List:

Name	Company/Corp.	Fax Number
------	---------------	------------

Add:

Name:

Company/Corp.:

Fax Number:

A hyphen (-) is available only at the beginning of the phone number because it acts as a pause in dialing.

External Access Prefix:

Cancel Fax

7. Do one of the following to choose your recipient:
 - Select a name or group from the **Recipient List**.
 - Enter a name, company, and fax number and click the **+** button.
 - Click the  icon and select a recipient from your address book.
8. Select **Fax Settings** from the pop-up menu.

You see this window:

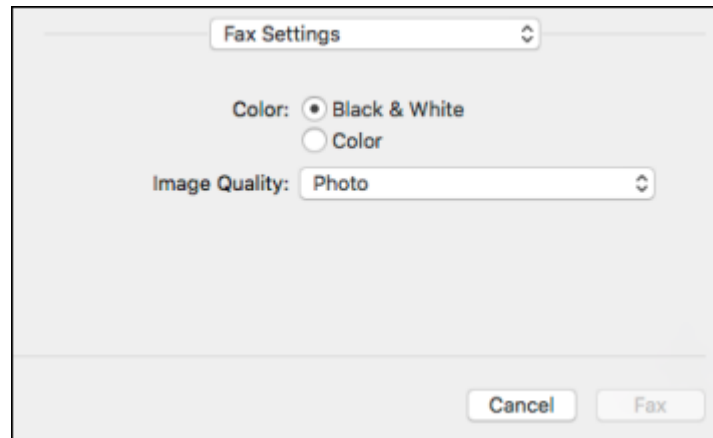

9. Select the **Color** and **Image Quality** settings you want to use for your fax.
10. Click **Fax**.

Parent topic: [Sending Faxes](#)

Receiving Faxes

See these sections to receive faxes with your product.

[Fax Reception](#)

[Receiving Faxes Automatically](#)

[Receiving Faxes Manually](#)

[Forwarding Received Faxes](#)

[Receiving a Fax by Polling](#)

[Saving Faxes to an External USB Device](#)

[Saving and Viewing Received Faxes](#)

Parent topic: [Faxing](#)

Fax Reception

Your product will automatically receive and print faxes when you set the Receive Mode to **Auto**.

If you connected a telephone to your product so you can use the same phone line for faxes and voice calls, you can also set your product to receive faxes manually. This allows you to check for a fax tone using the telephone and press a button on your product to receive the fax.

Make sure to load paper in your product and select your fax settings before receiving a fax.

Parent topic: [Receiving Faxes](#)

Receiving Faxes Automatically

To receive faxes automatically, make sure **Receive Mode** is set to **Auto** (the default setting for the product).

To change the Receive Mode if necessary, select **Settings > General Settings > Fax Settings > Basic Settings > Receive Mode**.

If an answering machine is connected, make sure the product's **Rings to Answer** setting is set higher than the number of rings your answering machine is set to answer a call. For example, if the answering machine is set to pick up on the fourth ring, set the product to pick up on the fifth ring or later.

Parent topic: [Receiving Faxes](#)

Related references

[Basic Settings - Fax](#)

Related tasks

[Receiving Faxes Manually](#)

Receiving Faxes Manually

You can set up your product to receive faxes manually by setting the Receive Mode to **Manual**. This lets you check for a fax tone on the connected telephone before receiving a fax.

1. To change the Receive Mode, select **Settings > General Settings > Fax Settings > Basic Settings > Receive Mode** and select **Manual**.
2. When the connected telephone rings, answer the call.
3. If you hear a fax tone, select **Fax** on the LCD screen.
4. Select **Send/Receive**.
5. Select **Receive**.
6. Select **Receive** again to start receiving the fax.
7. Hang up the telephone.

Parent topic: [Receiving Faxes](#)

Related references

[Basic Settings - Fax](#)

[Basic Settings - Fax](#)

Forwarding Received Faxes

You can forward received faxes to another fax machine, or convert the faxes into PDF documents and forward them to a shared folder on the network or to an email address. Forwarded faxes are deleted from the product's memory.

Before using this feature, make sure the date and time are set correctly, the forwarding destination is set up in the contact list, and the email server settings are configured.

1. Press the  home button, if necessary.
2. Select **Settings** > **General Settings** > **Fax Settings** > **Receive Settings** > **Save/Forward Settings** > **Unconditional Save/Forward** > **Forward**.
3. Select **Yes**.

Note: If you want to print the fax automatically before forwarding it, select **Yes and Print**.



4. Select **Add Entry**, select the forwarding destination from the contacts list, and select **Close**.
5. Confirm the displayed forwarding destinations and select **Close**.
6. Under Options When Forwarding Failed, select whether you want to print the faxes or save them in the printer's inbox if forwarding the received fax fails.

Parent topic: [Receiving Faxes](#)

Receiving a Fax by Polling

You can use polling to receive a fax from another fax machine (such as a fax information service).

Note: You cannot use polling to receive a fax from a fax information service that uses audio guidance.

1. Press the  home button, if necessary.
2. Select **Fax**.
3. Select the  icon.
4. Select **Extended Fax**.
5. Select **Polling Receive** to turn on the setting and select **Close**.

6. Select **Close**.
7. Enter the fax number you expect to receive the fax from.
8. Select **Polling** to start receiving the fax.

Parent topic: [Sending Faxes from the Product Control Panel](#)
[Receiving Faxes](#)

Saving Faxes to an External USB Device

You can save incoming faxes to an external USB device connected to your product.



1. Insert an external USB device into the product's USB port.
2. Press the  home button, if necessary.
3. Select **Settings > General Settings > Fax Settings > Receive Settings > Save/Forward Settings > Unconditional Save/Forward**.
4. Select **Save to Memory Device**
5. Select **Yes** to save the fax or **Yes and Print** to save and print the fax.

Parent topic: [Receiving Faxes](#)

Saving and Viewing Received Faxes

You can save received faxes in your product's memory and view them on the LCD screen. The inbox and confidential boxes can hold a maximum of 200 faxes in total.

Note: The inbox can be locked by an administrator. If you cannot access the inbox, contact your administrator for assistance.

1. Press the  home button, if necessary.
2. Select **Settings > General Settings > Fax Settings**.
3. To save received faxes, select **Receive Settings > Save/Forward Settings > Unconditional Save/Forward**.
4. Select **Save to Inbox** to turn on the setting.
5. Press the  home button again.
6. Select **Fax Box**.

7. Do one of the following to view stored faxes:
 - Select **Inbox/Confidential** to view received faxes.
 - Select **Stored Documents** to view saved faxes that have not been sent (available only when **Store Fax Data** is turned on).
 - Select **Polling Send/Board** to view faxes that are stored for fax polling or stored in a bulletin board.
8. Select the fax you want to view.



The LCD screen displays the fax contents.
9. If you want to print or forward a stored fax, select the  icon.
10. Select one of the printing or forwarding options, and follow the on-screen instructions.



Note: Delete faxes after you print or view them to free up the product's memory. When the memory is full, you can only forward or print incoming faxes.

Parent topic: [Receiving Faxes](#)

Checking Fax Status

You can check the status of fax jobs on the product control panel.

1. Press the  home button, if necessary.
2. Select **Fax**.
3. Select the  icon.
4. To check the history of faxes that have been sent or received, select **Transmission Log** and select the job you want to check.



Note: If you see a numbered icon above the  icon on your product's LCD screen or the  received fax light is flashing, received faxes have been temporarily saved to the product's memory.

5. To check the status of a fax in progress, press the  **Job/Status** button.

Parent topic: [Faxing](#)

Printing Fax Reports

You can print several types of fax reports whenever necessary. You can also print the fax log automatically by turning on **Fax Log Auto Print**.

1. Press the  home button, if necessary.
2. Select **Fax**.
3. Press the  icon.
4. Select **Fax Report**.
5. Select the fax report you want to print.

[Fax Report Options](#)

Parent topic: [Faxing](#)

Fax Report Options

Select the fax report or list you want to print.

Last Transmission

Print a report on the fax that was previously sent or received through polling.

Fax Log

Print a report on recent fax transmissions.

Stored Fax Documents

Print a list of the fax jobs currently stored in the product's memory.

Fax Settings List

Print a list of the current fax communication settings.

Conditional Save/Forward List

Print a list of the current conditional save/forward settings.

Protocol Trace

Print a detailed report for the previously sent or received fax.

Parent topic: [Printing Fax Reports](#)

Using External USB Devices with Your Product

Follow the instructions here to work with an external USB device connected to your product.

[Connecting a USB Device](#)

[Viewing and Printing from the LCD Screen](#)

[Transferring Files on a USB Device](#)

Connecting a USB Device

Connect a USB device or its USB cable to the USB port on the front of the product.

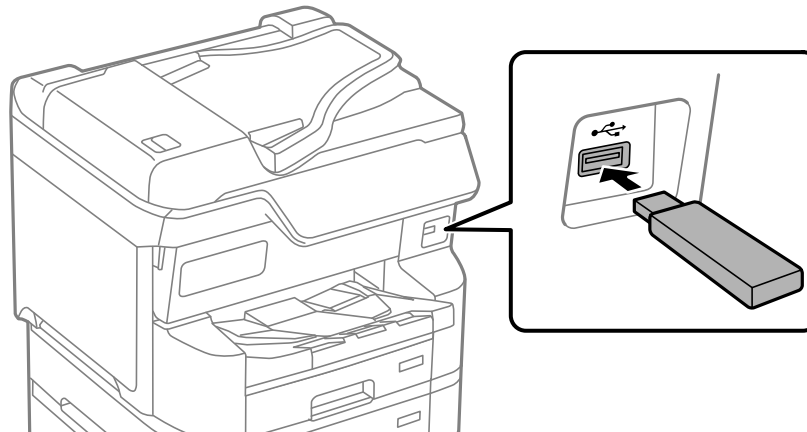

To view instructions on connecting a USB device or cable, select , then select **How To > USB memory connection**.

Perform the steps in reverse order to remove the external USB device.

Caution: If you remove the external USB device while operating the product, the data on the external USB device may be lost.

Note: Epson cannot guarantee the compatibility of your device. Make sure the files on the device are compatible with the product.

Parent topic: [Using External USB Devices with Your Product](#)

Viewing and Printing from the LCD Screen

See these sections to view and print photos or other files displayed on your product's LCD screen.

[Printing JPEG Photos](#)

[Printing TIFF and PDF Files](#)



Parent topic: [Using External USB Devices with Your Product](#)

Printing JPEG Photos

You can select JPEG photos for printing as you view them on the LCD screen.

1. Press the  home button, if necessary.
2. Select **Memory Device > JPEG**.

Note: If you have more than 999 JPEG images on your device, the images are divided into groups, and you must first select the group you want to display.

3. Do one of the following to select your photos:
 - In **Tile View**, select the thumbnail images of the photos you want to print.
 - In **Single View**, select the image of the photo you want to print, then select the left or right arrow buttons to scroll through and select additional photos, or select **Tile View** to return to the thumbnail image view and select additional photos.
 - To select all photos, select the  menu icon and select **Select All Images**.
4. Select **Proceed to Print**.
5. To change the print settings, select **Basic Settings** and select the necessary settings.
6. To adjust the photos (adjustments modify only your printed copies, not the original files), select **Advanced** and make the necessary adjustments.
7. Use the numeric keypad on the control panel or select **Copies** on the LCD screen and use the numeric keypad on the screen to select the number of copies (up to 99).
8. When you are ready to print, select the  **Print** icon.

Note: To cancel printing, press the  stop button or select **Cancel** on the LCD screen, then select **Cancel** again to confirm.

[Print Setting Options - JPEG Mode](#)

Parent topic: [Viewing and Printing from the LCD Screen](#)

Print Setting Options - JPEG Mode

Select the print settings you want to use when printing from a USB device.

Note: Not all options or settings may be available, depending on the file format.

Basic Settings

Print settings	Available options	Description
Paper Setting	Various paper size and type settings	Indicates the source that contains the paper size and type you want to print on
Color Mode	B&W	Prints the photo in black and white
	Color	Prints the photo in color

Advanced settings



Print settings	Available options	Description
Layout	1-up	Print one photo per page
	20-up	Print 20 photos per page
	Index	Print numbered photo thumbnails with date information
Fit Frame	On	Automatically crops the photo to fit into the selected photo layout
	Off	Turns off automatic cropping
Quality	Standard	Provides good quality for most prints
	Best	Provides the highest quality for special prints
Date	Various date formats	Prints the date the photo was taken on the photo in the format you select

Print settings	Available options	Description
Fix Photo	Auto	Optimizes the Fix Photo adjustments for specific types of photos; select the option that best matches your photo content
	People	
	Landscape	
	Night Scene	
	Enhance Off	
Fix Red-Eye	On	Automatically fixes the red-eye effect in photos
	Off	

Parent topic: [Printing JPEG Photos](#)

Printing TIFF and PDF Files

You can select and print TIFF or PDF files from a USB flash drive.

1. Press the  home button, if necessary.
2. Select **Memory Device**.
3. Select **TIFF** or **PDF**.
You see a list of the available files.
4. Select the file you want to print.
You see information about the file.
5. Do the following as necessary:
 - To print more than one copy, use the numeric keypad on the control panel or select **Copies** on the LCD screen and use the numeric keypad on the screen to select the number of copies (up to 99).
 - To change the print settings, select **Basic Settings** or **Advanced** and select the necessary settings.
6. When you are ready to print, select the  **Print** icon.

Note: To cancel printing, press the  stop button or select **Cancel** on the LCD screen, then select **Cancel** again to confirm.

[Print Setting Options - TIFF Mode](#)

[Print Setting Options - PDF Mode](#)

Parent topic: [Viewing and Printing from the LCD Screen](#)

Print Setting Options - TIFF Mode

Select the print settings you want to use when printing a TIFF from a USB device.

Note: Not all options or settings may be available, depending on the file format.

Basic Settings

Print settings	Available options	Description
Paper Setting	Various paper size and type settings	Select the paper source that you want to use.
Color Mode	B&W	Prints the photo in black and white
	Color	

Advanced settings

Print settings	Available options	Description
Layout	1-up	Print one photo per page
	20-up	Print 20 photos per page
	Index	Print numbered photo thumbnails with date information
Fit Frame	On	Automatically crops the photo to fit into the selected photo layout
	Off	Turns off automatic cropping
Quality	Standard	Provides good quality for most prints
	Best	Provides the highest quality for special prints
Print Order	—	Select the printing order for multi-page documents
Date	Various date formats	Prints the date the photo was taken on the photo in the format you select

Parent topic: [Printing TIFF and PDF Files](#)

Print Setting Options - PDF Mode

Select the print settings you want to use when printing a PDF from a USB device.

Note: Not all options or settings may be available, depending on the file format.

Basic Settings

Print settings	Available options	Description
Paper Setting	Various paper size and type settings	Indicates the source that contains the paper size and type you want to print on
Color Mode	B&W	Prints the photo in black and white
	Color	Prints the photo in color

Advanced settings

Print settings	Available options	Description
2-Sided	Off	Two-sided printing is off.
	On	Two-sided printing is on.
	Binding Position	Select the binding position for the document.
Print Order	—	Select the printing order for multi-page documents.

Parent topic: [Printing TIFF and PDF Files](#)

Transferring Files on a USB Device

You can transfer files to and from a USB device inserted into the USB port on the front of your product.

[Setting Up USB Device Access](#)

Parent topic: [Using External USB Devices with Your Product](#)

Setting Up USB Device Access

Before you can access a USB device inserted into the USB port on the front of your product, you may need to enable the access setting.

Caution: Remove the USB device before you change this setting or you may lose data from the device.

Note: These settings can be locked by an administrator. If you cannot access these settings, contact your administrator for assistance.

1. Press the  home button, if necessary.
2. Select **Settings > General Settings > Printer Settings > Memory Device Interface**.
3. Make sure **Memory Device** is set to **Enable**.
4. Select **File Sharing**.
5. Select the way your computer is connected to the product: either **USB** or **Network**.

Parent topic: [Transferring Files on a USB Device](#)

Replacing Ink Cartridges, Maintenance Boxes, and Cassette Rollers

When ink is expended, or the maintenance box and cassette rollers are at the end of their service life, you need to replace them. The maintenance box stores ink that gets flushed from the system during print head cleaning.

Note: Please dispose of your used Epson branded ink cartridges and maintenance boxes responsibly and in accordance with local requirements. If you would like to return your used ink cartridges and maintenance boxes to Epson for proper disposal, please go to epson.com/recycle for more information.

[Check Cartridge and Maintenance Box Status](#)

[Purchase Epson Ink Cartridges and Maintenance Box](#)

[Removing and Installing Ink Cartridges](#)

[Maintenance Box Replacement](#)

[Replacing the Rollers for Paper Cassette 1](#)

[Replacing the Rollers for Paper Cassettes 2 to 4](#)

[Resetting the Roller Counter on the LCD Screen](#)

[Printing with Black Ink and Expended Color Cartridges](#)

[Conserving Low Black Ink with Windows](#)

Check Cartridge and Maintenance Box Status

Your product and its software will let you know when an ink cartridge is low or expended, or when the maintenance box needs to be replaced.

Note: When using the Epson Universal Print Driver or PostScript (PS3) printer software with the product, you can check ink cartridge and maintenance box status by using the printer buttons or the utilities included with the standard Epson printer software. To download the standard Epson printer software, visit epson.com/support (U.S.), epson.ca/support (Canada), or latin.epson.com/support (Latin America) and select your product.

[Ink Safety Precautions](#)

[Checking Ink Status on the LCD Screen](#)

[Checking Ink and Maintenance Box Status with Windows](#)

[Checking Cartridge and Maintenance Box Status - Mac](#)

Ink Safety Precautions

- Keep ink cartridges and maintenance box out of the reach of children and do not drink the ink.
- Keep the ink cartridges and maintenance box out of direct sunlight.
- Store ink cartridges in a cool, dark place; do not store the ink cartridges or maintenance box in high or freezing temperatures.
- Be careful when you handle used ink cartridges; there may be ink remaining around the ink supply port. If ink gets on your skin, wash it off with soap and water. If it gets in your eyes, flush them immediately with water. If you experience discomfort or vision problems after flushing your eyes, see a doctor immediately. If ink gets in your mouth, see a doctor immediately.
- Do not dismantle an ink cartridge. This could damage the print head.
- Do not disassemble or modify the ink cartridge or maintenance box; otherwise ink may get into your eyes or on your skin or you may not be able to print normally.
- Do not shake cartridges too vigorously; this can cause them to leak.
- Do not drop or knock ink cartridges or the maintenance box against hard objects; this can cause leakage.
- Do not remove or tear the label on the cartridge; this can cause leakage.
- Use an ink cartridge before the date printed on its package or within six months of opening the package, whichever is earlier.
- After bringing an ink cartridge inside from a cold storage site, allow it to warm up at room temperature for at least three hours before using it.
- Do not open the ink cartridge package until you are ready to install it in the printer. The cartridge is vacuum packed to maintain its reliability. Leaving a cartridge unpacked for a long time before using it may prevent normal operation.
- Do not break the hooks on the side of the cartridge when removing it from the packaging.
- Do not shake cartridges after opening their packages; this can cause them to leak.
- Do not remove the transparent seal from the bottom of the cartridge. This may cause the cartridge to become unusable.
- Do not touch the green IC chip on the side of the cartridge. This may prevent normal operation.
- Make sure to install all ink cartridges. The printer only works when all ink cartridges are properly installed.

- Do not turn off the product during ink charging. If ink charging is incomplete, you may not be able to print.
- If you remove an ink cartridge for later use, protect the ink supply area from dirt and dust and store it in the same environment as the product. Note that there is a valve in the ink supply port, making covers or plugs unnecessary, but care is needed to prevent the ink from staining items that the cartridge touches. Do not touch the ink cartridge ink supply port or surrounding area.
- Install a new ink cartridge immediately after removing an expended one. Leaving cartridges uninstalled can dry out the print head and may prevent the product from printing.
- Do not turn off the printer during cartridge replacement. Otherwise, ink remaining in the print head nozzles will dry out and you may not be able to print.
- Do not put your hands inside the product or touch any cartridges during printing.
- Removed ink cartridges may have ink around the ink supply port, so be careful not to get any ink on the surrounding area when removing the cartridges.
- Do not remove and reinstall an ink cartridge except when necessary. Ink may get on the surrounding area if a cartridge is repeatedly removed and reinstalled.
- Even if some ink cartridges are dented due to the vacuum packing process, the quality and quantity of ink are guaranteed, and they can be used safely. Do not open the ink cartridge package until you are ready to replace an old cartridge.
- The specifications and appearance of the ink cartridge may be modified for improvement without prior notice.

Ink Consumption

- This printer uses ink cartridges equipped with a green chip that monitors information such as the amount of remaining ink for each cartridge. This means that even if the cartridge is removed from the printer before it is expended, you can still use the cartridge after reinserting it back into the printer. However, when reinserting a cartridge, some ink may be consumed to guarantee printer performance.
- To ensure you receive premium print quality and to help protect your print head, a variable ink safety reserve remains in the cartridge when your printer indicates that it is time to replace the cartridge. Quoted ink yields do not include this reserve.
- Quoted yields may vary depending on the images that you are printing, the paper type that you are using, the frequency of your prints and environmental conditions such as temperature.
- Do not use the cartridges that came with the printer for the replacement. The ink in the ink cartridges supplied with your printer is partly used during initial setup. In order to produce high quality printouts, the print head in your printer needs to be fully charged with ink. This process consumes a quantity of ink and, therefore, these cartridges may print fewer pages compared to subsequent ink cartridges.

- To maintain optimum print head performance, some ink is consumed from all ink cartridges during maintenance operations. Ink may also be consumed when you replace an ink cartridge or turn the printer on.
- When printing in monochrome or grayscale, color inks may be used instead of black ink depending on the paper type or print quality settings you are using. This is because a mixture of color inks is used to create black.



Parent topic: [Check Cartridge and Maintenance Box Status](#)

Checking Ink Status on the LCD Screen

When one of your ink cartridges is low or expended, you see a message on the LCD screen. Tap **How To** and follow the steps on the LCD screen to replace the ink cartridge.

You can also check the status of the ink cartridges and maintenance box from the product control panel.

Note: You can still print when you see the low ink warning message. Replace the ink cartridges when required.

1. Press the  home button, if necessary.
2. Select the  icon.

Note: The displayed ink and maintenance box levels are approximate.

You see a screen like this:

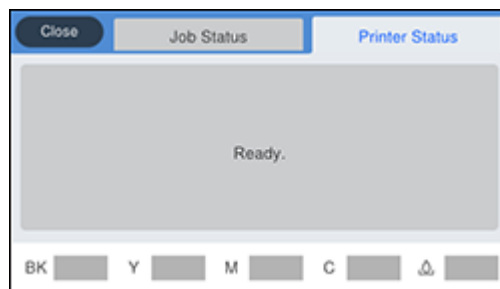

The ink and maintenance box levels are displayed at the bottom of the screen.

3. For more information, select the ink images at the bottom of the screen.

Parent topic: [Check Cartridge and Maintenance Box Status](#)

Related concepts

[Maintenance Box Replacement](#)



Related tasks

[Removing and Installing Ink Cartridges](#)

Checking Ink and Maintenance Box Status with Windows

You can check your ink cartridge or maintenance box status at any time using a utility on your Windows computer.

Note: You can continue printing while the low ink message is displayed. Replace the ink when required.

1. To check your status, do one of the following:
 - **Windows 11:** Click , search for **Settings** and select it. Select **Bluetooth & devices > Printers & scanners**. Select your product name and select **Printer preferences**.
 - **Windows 10:** Click  and select  (Settings) > **Devices > Printers & scanners**. Select your product name and select **Manage > Printer preferences**.
 - **Windows 8.x:** Navigate to the **Apps** screen and select **Control Panel > Hardware and Sound > Devices and Printers**. Right-click your product and select **Printer preferences**.
2. Select the **Maintenance** tab and select **EPSON Status Monitor 3**.
3. Replace or reinstall the ink cartridge or maintenance box as indicated on the screen. Select **Details** if necessary.

Note: If any ink cartridge installed in the product is broken, incompatible with the product model, or improperly installed, Epson Status Monitor will not display an accurate ink status.

Parent topic: [Check Cartridge and Maintenance Box Status](#)

Checking Cartridge and Maintenance Box Status - Mac

You can check your ink cartridge or maintenance box status at any time using a utility on your Mac.

Note: You can continue printing while the low ink message is displayed. Replace the ink when required.

1. In the Apple menu or the Dock, select **System Preferences** or **System Settings**. Select **Print & Fax**, **Print & Scan**, or **Printers & Scanners**, select your product, and select **Options & Supplies**. Select **Utility** and select **Open Printer Utility**.
2. Select **EPSON Status Monitor**.
3. Do the following as necessary:
 - You can update the ink cartridge and maintenance box status by clicking **Update**.
 - Replace or reinstall the maintenance box or any ink cartridge as indicated on the screen.

Note: If any ink cartridge installed in the product is broken, incompatible with the product model, or improperly installed, Epson Status Monitor will not display an accurate cartridge status.

Parent topic: [Check Cartridge and Maintenance Box Status](#)

Purchase Epson Ink Cartridges and Maintenance Box

You can purchase genuine Epson ink, maintenance boxes, and paper at epson.com (U.S. sales), epson.ca (Canadian sales), or latin.epson.com (Latin American sales). You can also purchase supplies from an Epson authorized reseller. To find the nearest one, call 800-GO-EPSON (800-463-7766) in the U.S. or 800-807-7766 in Canada.

Note: Your printer is designed to work only with genuine Epson-brand ink cartridges. Other brands of ink cartridges and ink supplies are not compatible and, even if described as compatible, may not function properly or at all. Epson periodically provides firmware updates to address issues of security, performance, minor bug fixes and ensure the printer functions as designed. These updates may affect the functionality of third-party ink. Non-Epson branded or altered Epson cartridges that functioned prior to a firmware update may not continue to function.

The included initial cartridges are designed for reliable printer setup and cannot be used as replacement cartridges or resold. After setup, the remaining ink is available for printing. Yields are based on ISO 24711 in default mode, printing continuously. Yields vary due to print images, settings, and temperatures. Printing infrequently or primarily with one color reduces yields. All cartridges must be installed with ink for printing and printer maintenance. For print quality, some ink remains in replaced cartridges.

[Ink Cartridge Part Numbers](#)

Parent topic: [Replacing Ink Cartridges, Maintenance Boxes, and Cassette Rollers](#)

Ink Cartridge Part Numbers

Use these part numbers when you order or purchase new ink cartridges.

Maintenance box part number: T6714

Ink color	Part number		
	Standard-capacity	High-capacity	Extra High-capacity
Black	T13S1	T13U1	T13V1
Cyan	T13S2	T13U2	T13V2
Magenta	T13S3	T13U3	T13V3
Yellow	T13S4	T13U4	T13V4

Parent topic: [Purchase Epson Ink Cartridges and Maintenance Box](#)

Removing and Installing Ink Cartridges

Make sure you have your replacement cartridges handy before you begin. You must install new cartridges immediately after removing the old ones.

Caution: Leave your old cartridges in the printer until you are ready to replace them to prevent the print head nozzles from drying out. Do not open ink cartridge packages until you are ready to install the ink. Cartridges are vacuum packed to maintain reliability.

1. Turn on your product.
2. If an ink cartridge is low or expended, a message appears on your product and on your computer screen. Note which cartridges need to be replaced.

3. Open the front cover.
4. Push the ink cartridge in, then pull it out of the slot.

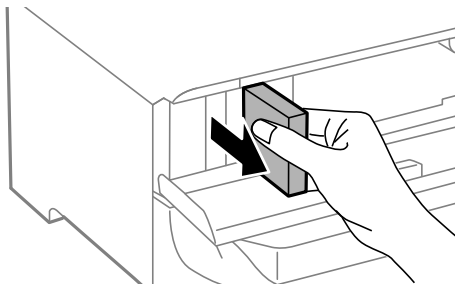
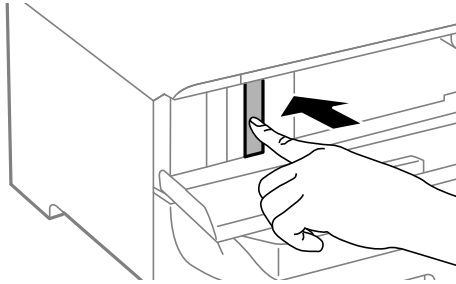

Note: Dispose of used cartridges carefully. Do not take the used cartridge apart or try to refill it.

Warning: If ink gets on your skin, wash it thoroughly with soap and water. If ink gets into your eyes, flush them immediately with water. If ink gets into your mouth, spit it out and see a doctor right away. Keep ink cartridges out of the reach of children.

5. Remove the new cartridge from the package.

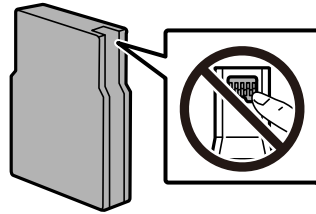
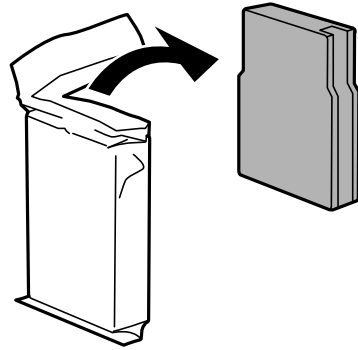

Caution: Do not touch the green chip on the cartridge. Install the new cartridge immediately after removing the old one; if you do not, the print head may dry out and be unable to print.

6. Gently shake the ink cartridge horizontally about fifteen times.

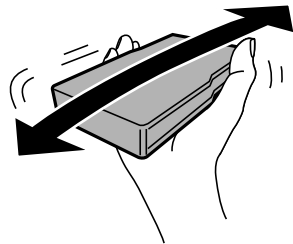

Caution: Do not remove any labels or seals, or ink will leak.

7. Insert the new cartridge into the holder and push it in until it clicks into place.

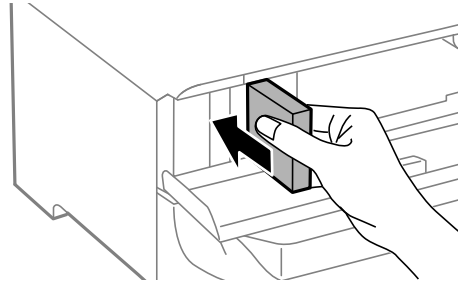

8. When you are finished, close the front cover.

The product starts charging the ink and returns to its previous state when finished.

Note: Do not turn off the printer during ink replacement.

Caution: If you remove an ink cartridge for later use, protect the ink supply area from dirt and dust and store it in the same environment as the printer. The valve in the ink supply port is designed to contain any excess ink, but do not touch the ink supply port or surrounding area. Always store ink cartridges with the label facing up; do not store cartridges upside-down.

Parent topic: [Replacing Ink Cartridges, Maintenance Boxes, and Cassette Rollers](#)

Related concepts

[Purchase Epson Ink Cartridges and Maintenance Box](#)

Maintenance Box Replacement

The maintenance box stores surplus ink that gets collected during printing or print head cleaning. When you see a message on the LCD screen, follow the on-screen instructions to replace the maintenance box.

Note the following precautions when replacing the maintenance box:

- Do not touch the green chip on the side of the maintenance box.
- Do not remove the film on the top of the box or ink may leak.
- Do not tilt the maintenance box after removing it or ink may leak.

- Keep the maintenance box out of direct sunlight.
- Do not remove the maintenance box during printing or ink may leak.

Caution: Do not reuse a maintenance box that has been removed and left uninstalled for a long period. Keep the maintenance box away from direct sunlight.

Note: The maintenance box is a user-replaceable part and is not covered by the product warranty.

Parent topic: [Replacing Ink Cartridges, Maintenance Boxes, and Cassette Rollers](#)

Replacing the Rollers for Paper Cassette 1

When the rollers in paper cassette 1 need to be replaced, you see a message on the LCD screen. There are three rollers for paper cassette 1: two on the back of the product and one on the cassette.

Note: Check that the arrows on the rollers point clockwise before installing them in paper cassette 1. There are different rollers for paper cassette 1 and the other paper cassettes.

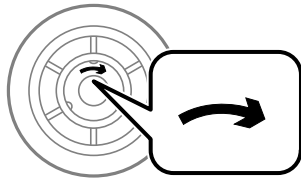

1. Turn off the product.
2. Wait for the  power light to turn off, then unplug the power cord.
3. Remove the replacement rollers from their package.

Caution: If there is any dirt or dust on the rollers, clean them with a soft, moist cloth. Using a dry cloth can damage the surface of the roller.

4. Pull out paper cassette 1.

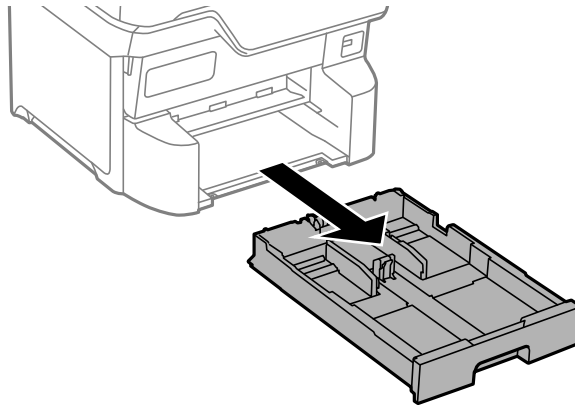

5. Open rear cover 1 (D1).

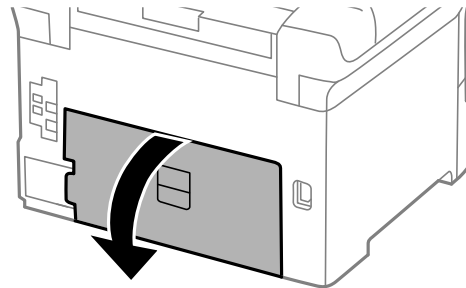

6. Pull out rear cover 2 (D2).

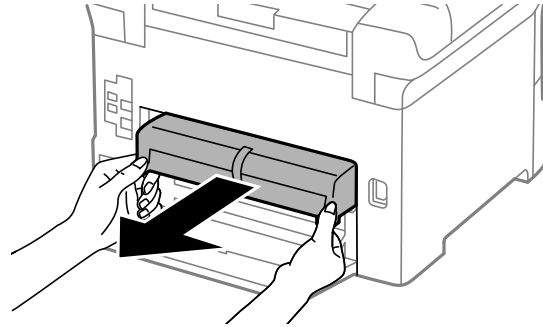

7. Remove the roller cover inside the product.

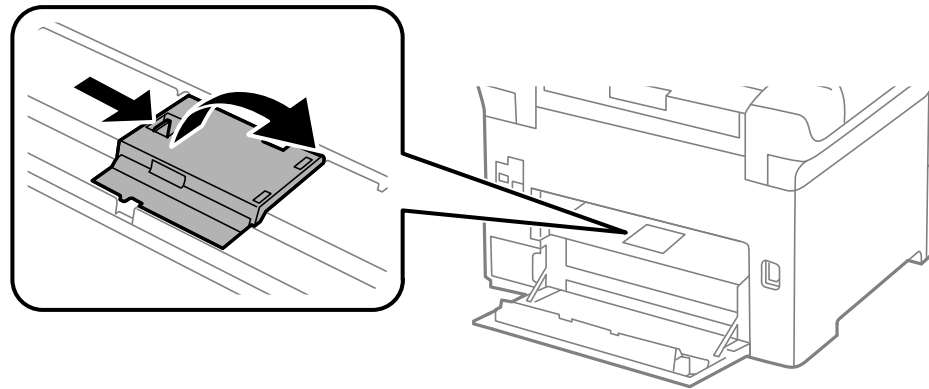

8. Pull up the roller tabs and slide the rollers to the left to remove them.

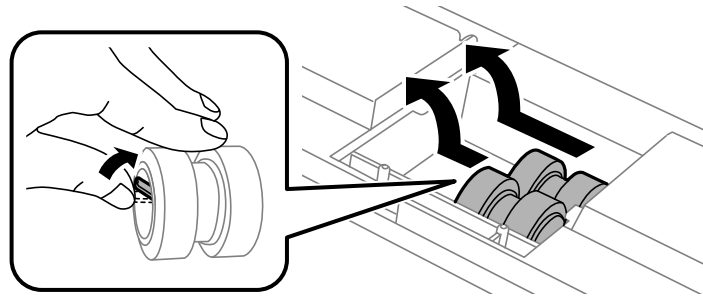

9. Insert the replacement rollers and slide them to the right until they click into place.

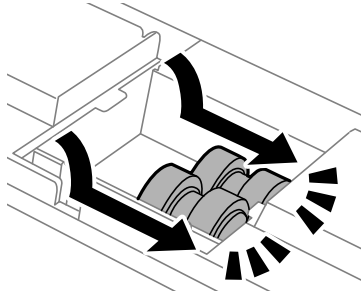

10. Replace the roller cover as shown and press it down until it clicks into place.

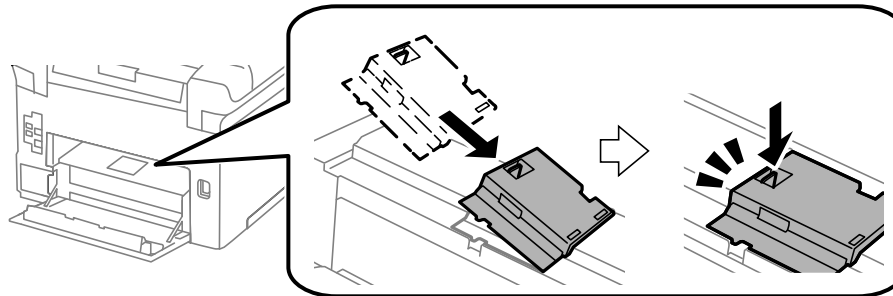

11. Insert rear cover 2 (D2).

12. Close the rear cover 1 (D1).

13. On paper cassette 1, pull up on the lever as shown to release the roller.

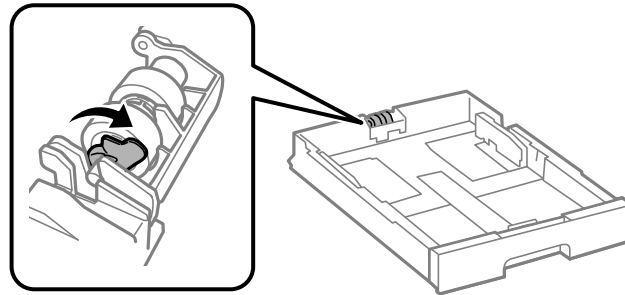

14. Slide the roller towards the lever and lift it out of the cassette.

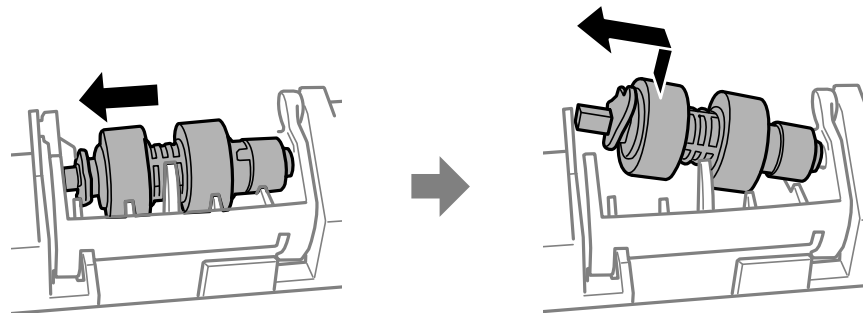

15. Insert the pointed end of the replacement roller's shaft into the hole in the cassette and gently slide the roller into the slot with the flat side of the shaft facing toward the front of the cassette.

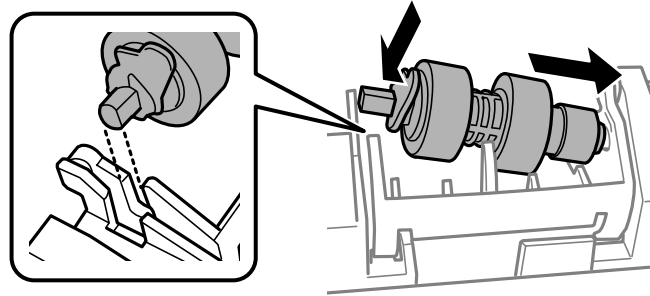

16. Press down on the lever as shown to lock the roller in place.

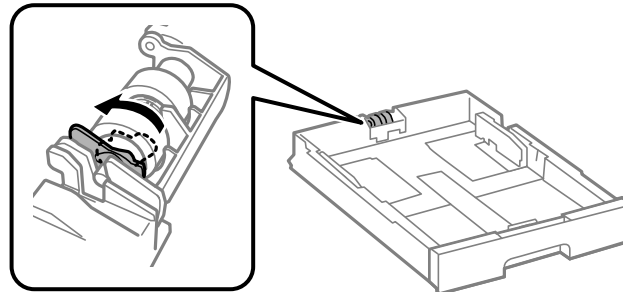

17. Insert the paper cassette all the way into the product.

Reset the maintenance roller counter for paper cassette 1 to keep track of roller usage.

Parent topic: [Replacing Ink Cartridges, Maintenance Boxes, and Cassette Rollers](#)

Replacing the Rollers for Paper Cassettes 2 to 4

When the rollers in paper cassettes 2 to 4 need to be replaced, you see a message on the LCD screen. There are three rollers for each paper cassette: two on the back of the product and one on the cassette.

Note: Check that the arrows on the rollers point counterclockwise before installing them in paper cassettes 2 to 4. There are different rollers for paper cassette 1 and the other paper cassettes.

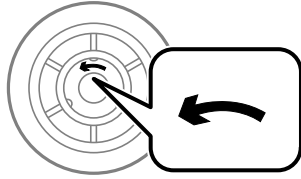

1. Turn off the product.
2. Wait for the  power light to turn off, then unplug the power cord.
3. Remove the replacement rollers from their package.

Caution: If there is any dirt or dust on the rollers, clean them with a soft, moist cloth. Using a dry cloth can damage the surface of the roller.

4. Pull out the paper cassette.

5. Open the rear cover (E) that matches with the paper cassette you removed.

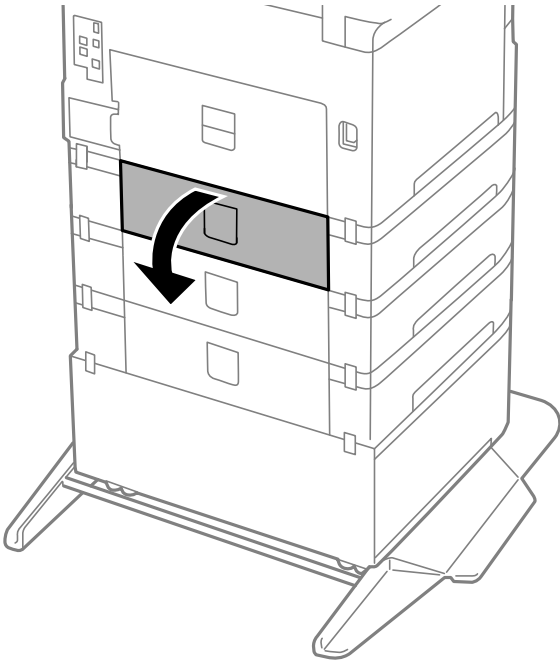

6. Use a screwdriver to remove the three screws on the inner cover and remove the cover.

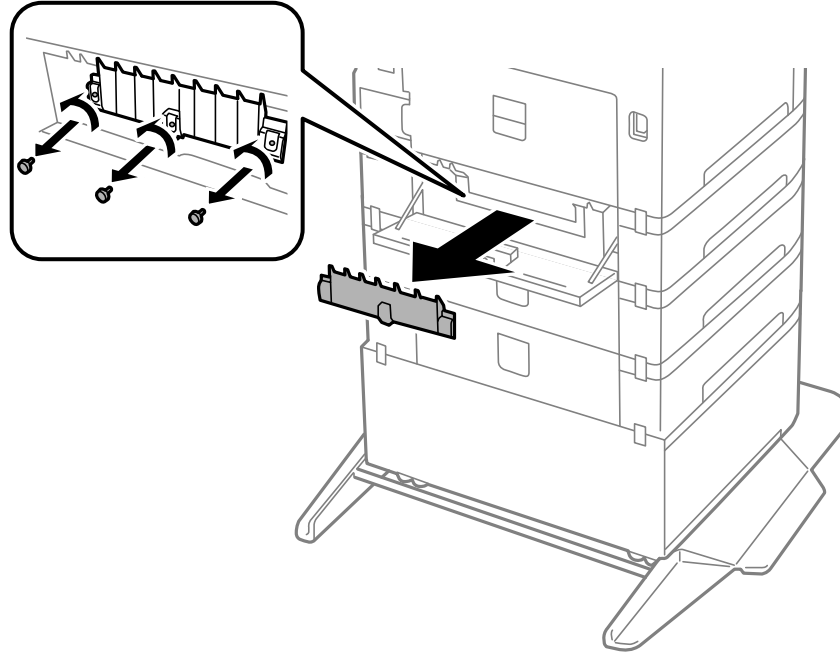

7. Pull down the roller tabs and slide the rollers to the right to remove them.

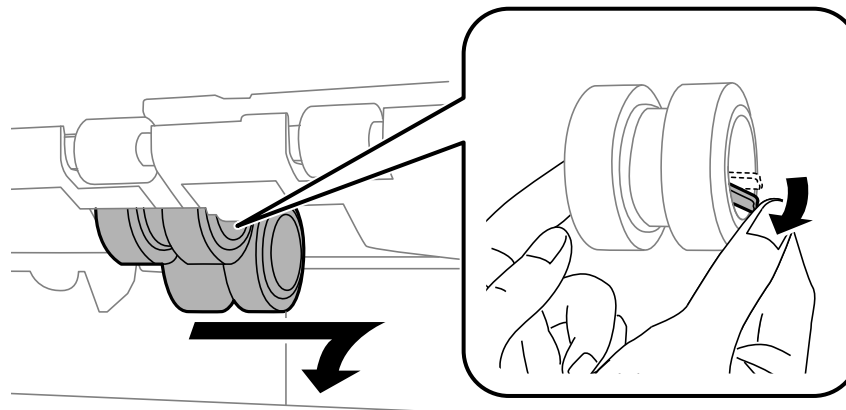

8. Insert the replacement rollers and slide them to the left until they click into place.

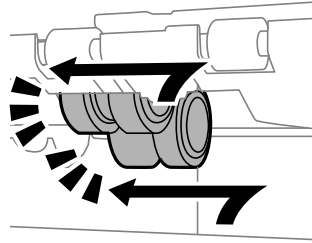

9. Use a screwdriver to secure the inner cover to the printer with the three screws you removed.
10. Close the rear cover (E).
11. On the paper cassette you removed, pull up on the lever as shown to release the roller.

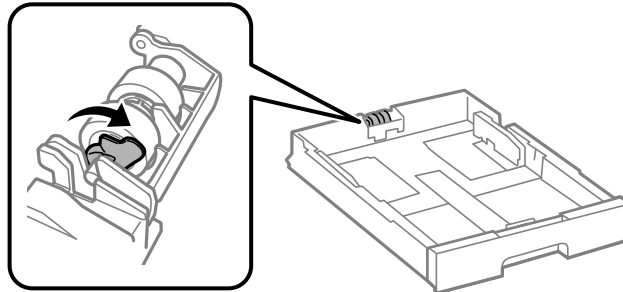

12. Slide the roller towards the lever and lift it out of the cassette.

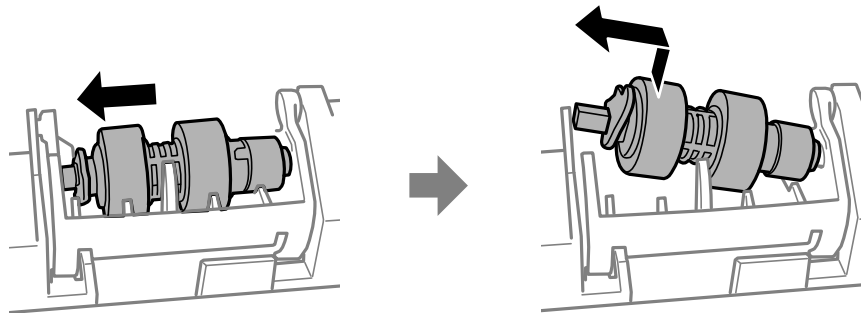

13. Insert the pointed end of the replacement roller's shaft into the hole in the cassette and gently slide the roller into the slot with the flat side of the shaft facing toward the front of the cassette.

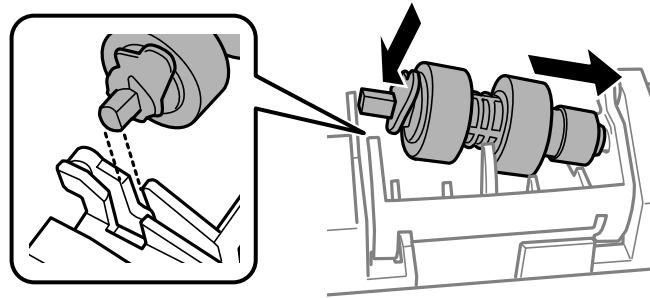

14. Press down on the lever as shown to lock the roller in place.

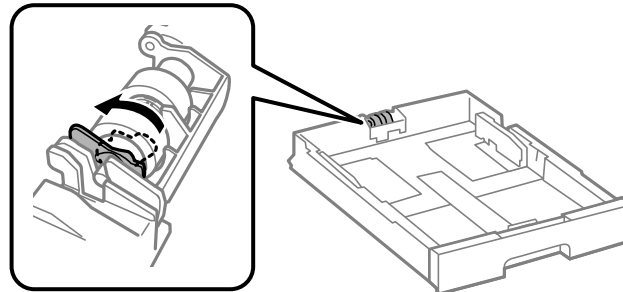

15. Insert the paper cassette all the way into the product.

Reset the maintenance roller counter for the paper cassette to keep track of roller usage.

Parent topic: [Replacing Ink Cartridges, Maintenance Boxes, and Cassette Rollers](#)

Resetting the Roller Counter on the LCD Screen

You must reset the roller counter after replacing the cassette rollers to clear the roller replacement message and to keep track of roller usage correctly.

1. Press the  home button, if necessary.
2. Select **Settings** > **Maintenance** > **Pickup roller information** > **Reset Counter**.

3. Select the paper cassette in which you replaced the rollers.
4. Select **Yes**.
5. Select **Yes** again to confirm the reset.
6. If you want to feed a sheet of paper to check the roller installation, select **Yes**. (Otherwise, select **No**.)
7. Press the  home button to exit.

Parent topic: [Replacing Ink Cartridges, Maintenance Boxes, and Cassette Rollers](#)

Printing with Black Ink and Expended Color Cartridges

When a color ink cartridge is expended, you can temporarily continue printing from your computer using black ink. Replace the expended color cartridge as soon as possible for future printing.

Note: You cannot print with expended color ink cartridges using your product's control panel.

[Printing with Expended Color Ink Cartridges - Control Panel](#)

[Printing with Expended Color Cartridges - Windows](#)

[Printing with Expended Color Cartridges - Mac](#)

Parent topic: [Replacing Ink Cartridges, Maintenance Boxes, and Cassette Rollers](#)

Printing with Expended Color Ink Cartridges - Control Panel

If printing stops, you can cancel your print job and select settings to temporarily print with only black ink on plain paper or on an envelope.

1. When a message is displayed prompting you to replace the ink supply units, press the **Proceed** button.
2. If you see a message telling you that you can temporarily print with only black ink, click the **Proceed** button.
3. If you want to print in monochrome, select **No, remind me later**. The ongoing job is canceled, and you can print on plain paper with margins around the edges.

Parent topic: [Printing with Black Ink and Expended Color Cartridges](#)

Printing with Expended Color Cartridges - Windows

If you see a message during printing telling you that you can temporarily print in black ink with an expended color cartridge, you can cancel your print job and select settings to print on plain paper or on an envelope.

Note: If you are using your Epson product with the Windows 10 S operating system, you cannot use the software described in this section. You also cannot download and install any Epson product software from the Epson website for use with Windows 10 S; you must obtain software only from the Windows Store.

Note: To use this feature, Epson Status Monitor must be enabled.

1. Click **Cancel** or **Cancel Print** to cancel your print job.

Note: If the message screen appears on another computer on a network, you may need to cancel the print job using the product control panel.

2. Load plain paper or an envelope in your product.
3. Access the print settings in your print application.
4. Click the **Main** tab.
5. Select **Plain Paper/Bright White Paper** or **Envelope** as the paper type setting.
6. Select the **Black/Grayscale** checkbox.
7. Click **OK**.
8. Print your document.

Epson Status Monitor 3 displays a print message.

9. Click **Print in Black** to print your document.

Parent topic: [Printing with Black Ink and Expended Color Cartridges](#)

Printing with Expended Color Cartridges - Mac

If printing stops, you can cancel your print job and select settings to temporarily print with only black ink on plain paper or on an envelope.

The following paper types support printing with expended color cartridges:

- Plain paper

- Pre-printed paper
- Letterhead
- Color paper
- Recycled paper
- High-quality plain paper
- Thick paper
- Envelopes

1. Click the printer icon in the Dock.
2. If you see a message telling you that you can temporarily print with only black ink, click the **Delete** or  button to cancel your print job. If you see an error message, click **OK**.

Note: If the message screen appears on another computer on a network, you may need to cancel the print job using the product control panel.

3. In the Apple menu or the Dock, select **System Preferences** or **System Settings**.
4. Select **Print & Fax**, **Print & Scan**, or **Printers & Scanners**, select your product, and select **Options & Supplies**.
5. Select **Driver** or **Options**.
6. Select **On** as the **Permit temporary black printing** setting.
7. Click **OK**.
8. Close the utility window.
9. Load a paper type compatible with temporary black printing in your product.
10. Select **Print Settings** from the pop-up menu.
11. Select a non-borderless paper size as the **Paper Size** setting.
12. Select a paper type that supports **Permit temporary black printing** as the media type setting.
13. Select the **Grayscale** option as the color setting.
14. Click **Print** to print your document.

Parent topic: [Printing with Black Ink and Expended Color Cartridges](#)

Conserving Low Black Ink with Windows

The following window appears when black ink runs low and there is more color ink.

Note: The window appears only when you have selected **Plain Paper/Bright White Paper** as the paper type setting, and depends on other selected print settings. To use this feature, Epson Status Monitor must be enabled.

- Click **Yes** to use a mixture of color inks to create black, or **No** to continue using the remaining black ink for the document you are printing.
- Click **Disable this feature** to continue using the remaining black ink.

Note: If you disable this feature, it remains disabled until you install a new black ink cartridge.

Parent topic: [Replacing Ink Cartridges, Maintenance Boxes, and Cassette Rollers](#)

Adjusting Print Quality

If your print quality declines, you may need to run a utility to clean or align the printhead.

Note: If you are using your Epson product with the Windows 10 S operating system, you cannot use the software described in this section. You also cannot download and install any Epson product software from the Epson website for use with Windows 10 S; you must obtain software only from the Windows Store.

If running these utilities does not solve the problem, you may need to replace the ink cartridges.

[Print Quality Adjustment](#)

[Printhead Maintenance](#)

[Print Head Alignment](#)

[Cleaning the Paper Guide](#)

Print Quality Adjustment

If your printouts become grainy or blurry, you notice misalignment of vertical lines, or you see dark or light horizontal bands, you may need to adjust the print quality.

Note: Banding may also occur if your print head nozzles need cleaning.

[Adjusting the Print Quality Using the Product Control Panel](#)

[Adjusting the Quality for Each Paper Type](#)

Parent topic: [Adjusting Print Quality](#)

Adjusting the Print Quality Using the Product Control Panel

You can adjust the print quality using the control panel on your product.

1. Make sure there are no errors on the LCD screen.
2. Load a few sheets of plain paper in the product.
3. Press the  home button, if necessary.
4. Select **Settings** > **Maintenance** > **Print Quality Adjustment**.

5. Follow the on-screen instructions to print an alignment sheet.

Note: Do not cancel printing while you are printing head alignment patterns.

6. Check the printed patterns on the alignment sheet and select the following on the LCD screen:

- For patterns 1 and 2, select the number representing the pattern with the least misaligned vertical line.

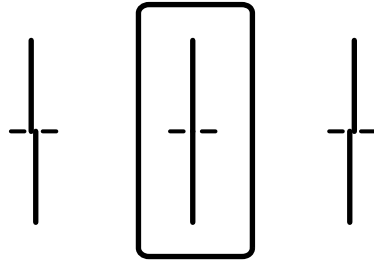

- For patterns 3 and 4, select the number representing the pattern with the least amount of separation or overlap.

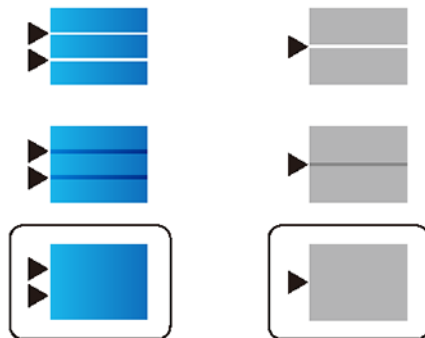

7. Select **Done**.

Parent topic: [Print Quality Adjustment](#)

Related topics

[Loading Paper](#)

Adjusting the Quality for Each Paper Type

If you still notice dark or light bands in your printouts after adjusting the print quality, you can adjust the quality for each paper type.

1. Make sure there are no errors on the LCD screen.
2. Load the paper type you want to adjust the quality for into the printer.
3. Press the  home button, if necessary.
4. Select **Settings** > **Maintenance** > **Print Quality Adjustment per Paper**.
5. Select one of the following options:
 - **Print Pattern** to adjust the paper type for your printer
 - **Enter Set Value** to enter paper type alignment information for use on multiple printers of the same model
6. Select the paper type you loaded into the printer.
7. If you printed a pattern, check the printed patterns on the alignment sheet and select the number representing the pattern with the least amount of separation or overlap.

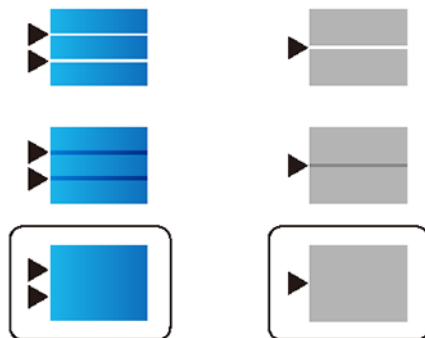

8. Select **Done**.

Parent topic: [Print Quality Adjustment](#)

Related topics

[Loading Paper](#)

Printhead Maintenance

If your printouts become too light, or you see dark or light bands across them, you may need to clean the printhead nozzles. Cleaning uses ink, so clean the nozzles only if print quality declines.

You can check for clogged nozzles before you clean them so you don't clean them unnecessarily.

Note: You cannot clean the print head if an ink cartridge is expended, and may not be able to clean it when a cartridge is low. You must replace the cartridge first.

[Print Head Nozzle Check](#)

[Print Head Cleaning](#)

Parent topic: [Adjusting Print Quality](#)

Related topics

[Replacing Ink Cartridges, Maintenance Boxes, and Cassette Rollers](#)

Print Head Nozzle Check

You can print a nozzle check pattern to check for clogged nozzles.

[Checking the Nozzles Using the Product Control Panel](#)

[Checking the Nozzles Using a Computer Utility](#)

Parent topic: [Printhead Maintenance](#)

Checking the Nozzles Using the Product Control Panel

You can check the print head nozzles using the control panel on your product.

1. Make sure there are no errors on the LCD screen.
2. Load a few sheets of plain paper in the product.
3. Press the  home button, if necessary.
4. Select **Settings** > **Maintenance** > **Print Head Nozzle Check** > **Start**.

The nozzle pattern prints.

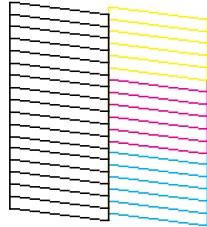

5. Check the printed pattern to see if there are gaps in the lines.

Print head is clean

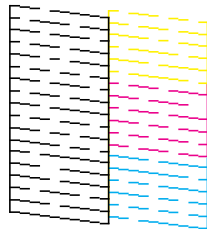

Print head needs cleaning



6. Do one of the following:
 - If there are no gaps, select .
 - If there are gaps or the pattern is faint, select  and continue.
7. Follow the instructions on the screen to clean the print head, check the nozzles, and repeat the process as necessary.

Caution: Never turn off the product or open the front cover during a cleaning cycle or you may not be able to print.

If you don't see any improvement after cleaning the print head up to 4 times, turn the product off using the  power button and wait at least 6 hours. Then run a nozzle check and try cleaning the print head again, if necessary. If quality still does not improve, contact Epson support.

Parent topic: [Print Head Nozzle Check](#)

Related concepts



[Print Head Cleaning](#)

Related topics

[Loading Paper](#)

Checking the Nozzles Using a Computer Utility

You can check the print head nozzles using a utility on your Windows or Mac computer.

1. Load a few sheets of plain paper in the product.
2. Do one of the following:
 - **Windows:** Access the Windows Desktop and right-click the  icon for your product in the right side of the Windows taskbar, or click the up arrow and right-click .
 - **Mac:** In the Apple menu or the Dock, select **System Preferences** or **System Settings**. Select **Print & Fax**, **Print & Scan**, or **Printers & Scanners**, select your product, and select **Options & Supplies**. Select **Utility** and select **Open Printer Utility**.
3. Select **Nozzle Check** or **Print Head Nozzle Check**.

You see a window like this:

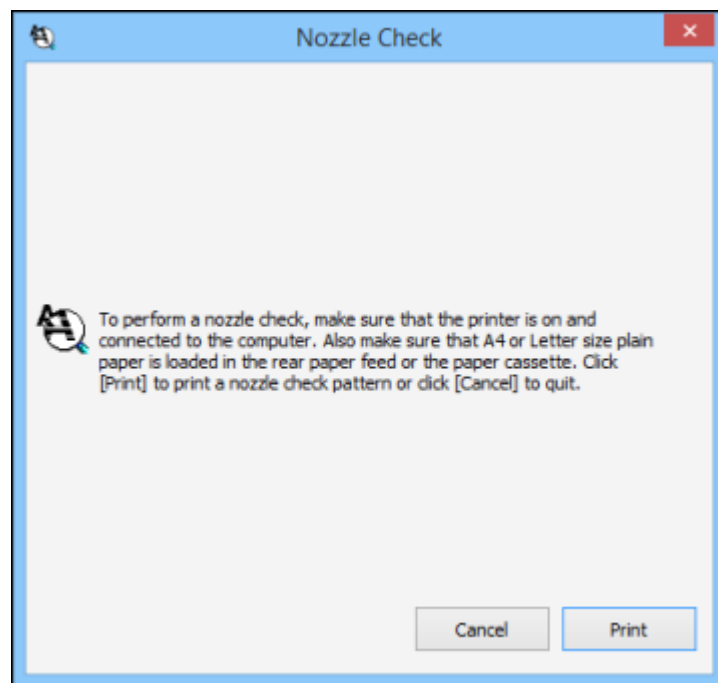

4. Click **Print**.

5. Check the printed pattern to see if there are gaps in the lines.

Print head is clean

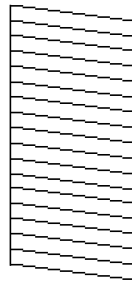
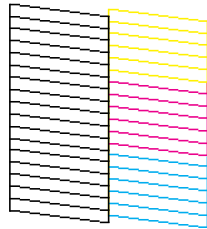

Print head needs cleaning

6. Do one of the following:
 - If there are no gaps, click **Finish**.
 - If there are gaps or the pattern is faint, clean the print head.

If you don't see any improvement after cleaning the print head up to 4 times, turn the product off using the  power button and wait at least 6 hours. Then run a nozzle check and try cleaning the print head again, if necessary. If quality still does not improve, contact Epson support.

Parent topic: [Print Head Nozzle Check](#)

Related concepts

[Print Head Cleaning](#)

Related topics

[Loading Paper](#)

Print Head Cleaning

If print quality has declined and the nozzle check pattern indicates clogged nozzles, you can clean the print head.

Note: You cannot clean the print head if an ink cartridge is expended, and may not be able to clean it when a cartridge is low. You must replace the cartridge first.

[Cleaning the Print Head Using the Product Control Panel](#)

[Cleaning the Print Head Using a Computer Utility](#)

Parent topic: [Printhead Maintenance](#)

Related tasks

[Removing and Installing Ink Cartridges](#)

Cleaning the Print Head Using the Product Control Panel

You can clean the print head using the control panel on your product.

1. Make sure there are no errors on the LCD screen.
2. Load a few sheets of plain paper in the product.
3. Press the  home button, if necessary.
4. Select **Settings** > **Maintenance** > **Print Head Cleaning** > **Start** to clean the print head.

When the cleaning cycle is finished, you see a message on the screen.

Caution: Never turn off the product or open the front cover during a cleaning cycle or you may not be able to print.

5. Follow the on-screen instructions to load to print a nozzle check pattern and confirm that the print head is clean.

6. Check the printed pattern to see if there are gaps in the lines.

Print head is clean

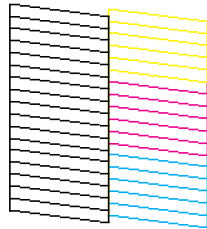

Print head needs cleaning

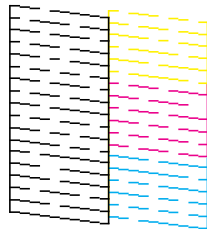

If you don't see any improvement after cleaning the print head up to 4 times, turn the product off using the  power button and wait at least 6 hours. Then run a nozzle check and try cleaning the print head again, if necessary. If quality still does not improve, contact Epson support.

Parent topic: [Print Head Cleaning](#)



Related topics

[Loading Paper](#)

Cleaning the Print Head Using a Computer Utility

You can clean the print head using a utility on your Windows or Mac computer.

1. Make sure there are no errors on the LCD screen.
2. Load a few sheets of plain paper in the product.

3. Do one of the following:
 - **Windows:** Access the Windows Desktop and right-click the  icon for your product in the right side of the Windows taskbar, or click the up arrow and right-click .
 - **Mac:** In the Apple menu or the Dock, select **System Preferences** or **System Settings**. Select **Print & Fax**, **Print & Scan**, or **Printers & Scanners**, select your product, and select **Options & Supplies**. Select **Utility** and select **Open Printer Utility**.
4. Select **Head Cleaning** or **Print Head Cleaning**.

You see a window like this:

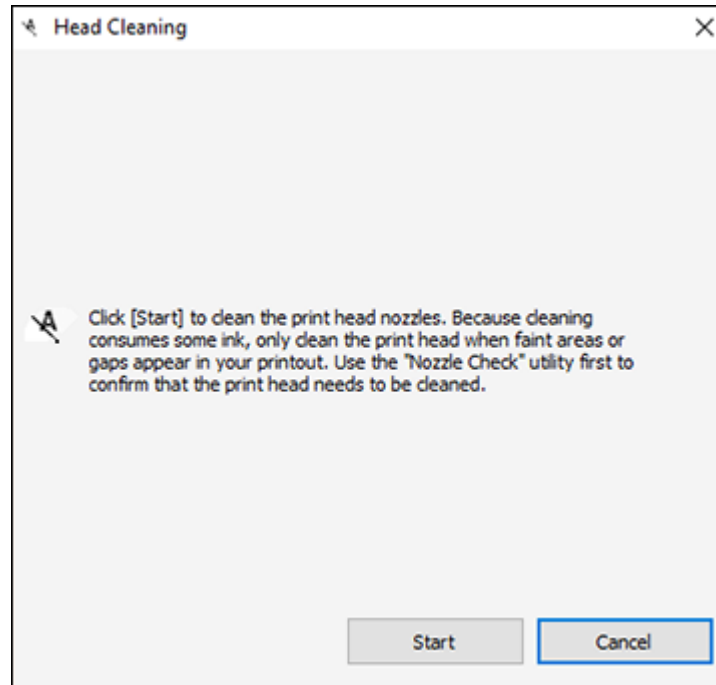

5. Click **Start** to begin the cleaning cycle.
The  power light flashes throughout the cleaning cycle and stays on when the cleaning cycle is finished.

Caution: Never turn off the product or open the front cover during a cleaning cycle or you may not be able to print.

6. When the cleaning cycle is finished, you can check to see if the nozzles are clean; click **Print Nozzle Check Pattern** and click **Print**.
7. Check the printed pattern to see if there are gaps in the lines.

Print head is clean

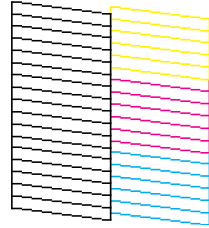

Print head needs cleaning

- If there are no gaps, click **Finish**.
- If there are gaps or the pattern is faint, click **Clean** to clean the print head again.

If you don't see any improvement after cleaning the print head up to 4 times, turn off the product and wait at least 6 hours. Then check the print head nozzles and try cleaning the print head again, if necessary. If quality still does not improve, contact Epson.

Parent topic: [Print Head Cleaning](#)

Related topics

[Loading Paper](#)

Print Head Alignment

If your printouts become grainy or blurry or you notice misalignment of vertical lines, you may need to align the print head.

Note: Banding may also occur if your print head nozzles need cleaning.

[Aligning the Print Head Using the Product Control Panel](#)

Parent topic: [Adjusting Print Quality](#)

Aligning the Print Head Using the Product Control Panel

You can align the print head using the control panel on your product.

1. Make sure there are no errors on the LCD screen.
2. Load a few sheets of plain paper in the product.
3. Press the  home button, if necessary.
4. Select **Settings > Maintenance > Ruled Line Alignment**.
5. Follow the on-screen instructions to print an alignment sheet.

Note: Do not cancel printing while you are printing head alignment patterns.

6. Check the printed patterns on the alignment sheet and select the number representing the pattern with the least misaligned vertical line on the LCD screen:

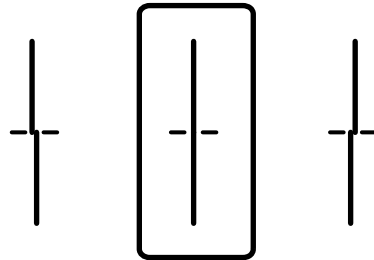

7. Select **Done**.

Parent topic: [Print Head Alignment](#)

Related topics

[Loading Paper](#)

Cleaning the Paper Guide

If you see ink on the back of a printout, you can clean the paper guide roller to remove any excess ink. If paper does not feed correctly from the rear paper feed slot, you can use a cleaning sheet to clean the rollers.

1. If printouts are smeared or scuffed, load plain paper in the paper source that you want to clean in this size: A4 (8.3 × 11.7 inches [210 × 297 mm]).

2. Press the  home button, if necessary.
3. Select **Settings** > **Maintenance** > **Paper Guide Cleaning**.
4. Select the paper source you want to clean then select **Start**.
5. Repeat these steps as necessary until the paper comes out clean. If you are using a cleaning sheet, repeat these steps up to 3 times.

Note: If the paper is not clean after cleaning several times, try cleaning the other paper sources.

Parent topic: [Adjusting Print Quality](#)

Related topics

[Loading Paper](#)

Cleaning and Transporting Your Product

See these sections if you need to clean or transport your product.

[Cleaning Your Product](#)

[Cleaning the Scanner Glass](#)

[Cleaning the Automatic Document Feeder](#)

[Transporting Your Product](#)

Cleaning Your Product

To keep your product working at its best, you should clean it several times a year.

Caution: Do not use a hard brush, alcohol, or paint thinner to clean the product or you may damage it. Do not use oil or other lubricants inside the product or let water get inside it.

1. Turn off the product.
2. Wait for the  power light to turn off, then unplug the power cord.
3. Disconnect any connected cables.
4. Remove all the paper from the product.
5. Pull out the paper cassette.

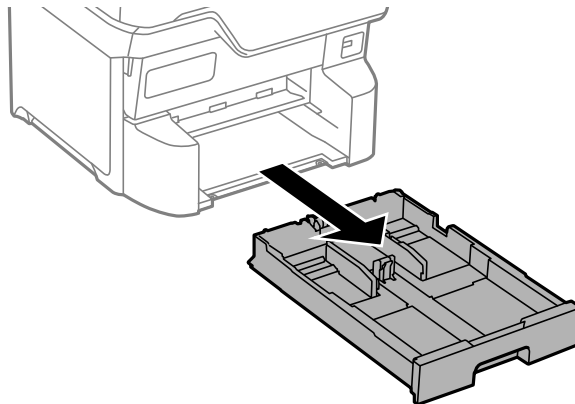

6. Use a soft, moist cloth to clean the cassette roller.

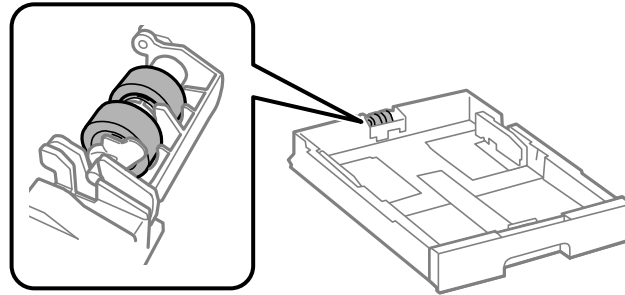

Caution: Using a dry cloth can damage the surface of the roller.

7. Insert the paper cassette all the way into the printer.
8. Repeat steps 5 through 7 for any additional paper cassettes.
9. Clean the outer case and control panel with a soft, dry cloth. Do not use liquid or chemical cleansers.

Parent topic: [Cleaning and Transporting Your Product](#)

Cleaning the Scanner Glass

You can clean the scanner glass if your copies or scanned images are smeared.

Caution: Do not use a hard brush, alcohol, or paint thinner to clean the product or you may damage it. Do not use oil or other lubricants inside the product or let water get inside it.

Warning: Do not trap your fingers when opening or closing the document cover or you may be injured.

1. Open the document cover.
2. Use a soft, dry, clean cloth to clean the surface of the scanner glass.

Note: If the glass is stained with grease or dirt, use a small amount of glass cleaner on a soft, dry cloth to remove it. Wipe off all remaining liquid after removing the dirt.

Caution: Do not spray glass cleaner directly on the glass and do not press the glass surface with any force. Be careful not to scratch or damage the glass; this can affect scan quality.

3. Close the document cover.

Parent topic: [Cleaning and Transporting Your Product](#)

Cleaning the Automatic Document Feeder

You can clean the ADF if you see lines or streaks in your copies or scanned images.

Caution: Do not use a hard brush, alcohol, or paint thinner to clean the product or you may damage it. Do not use oil or other lubricants inside the product or let water get inside it.

1. Open the ADF cover.

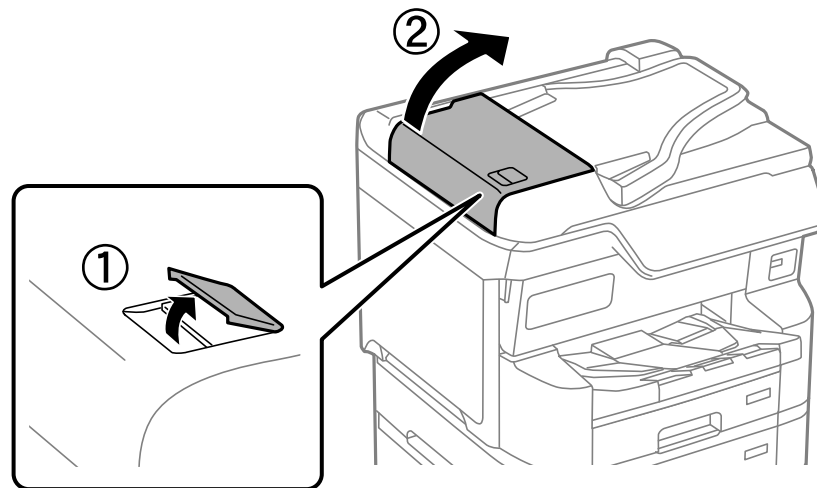

2. Use a soft, lint-free cloth (microfiber is recommended) moistened with a little water to clean the rollers and the interior of the ADF.

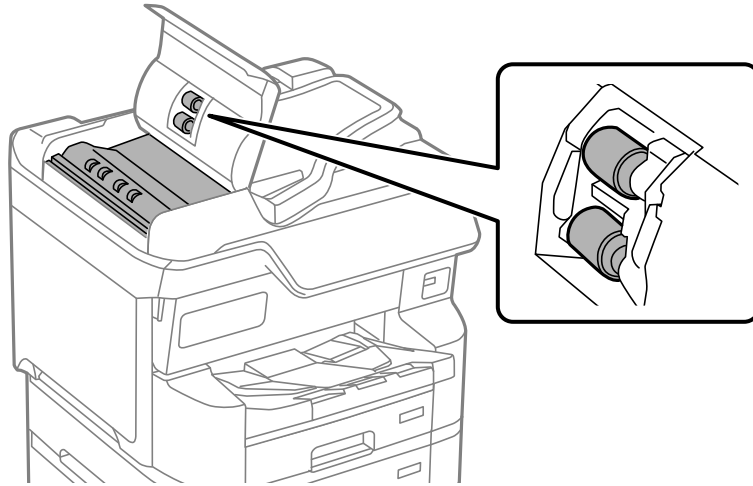

Caution: Do not use a dry cloth; you may damage the ADF rollers. Do not use the ADF until the rollers have dried.

3. Close the ADF cover and open the document cover.

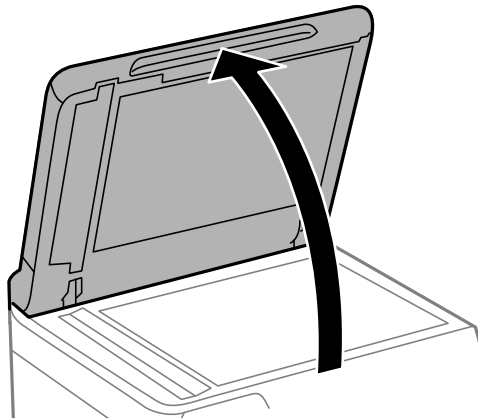

4. Clean the areas indicated in the image:

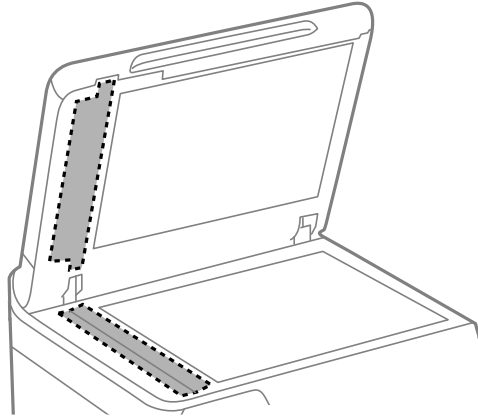

Caution: Do not spray glass cleaner directly on the glass and do not press the glass surface with any force. Be careful not to scratch or damage the glass; this can affect scan quality.

Note: If the glass is stained with grease or dirt, use a small amount of glass cleaner on a soft, dry cloth to remove it. Wipe off all remaining liquid after removing the dirt.

Parent topic: [Cleaning and Transporting Your Product](#)

Transporting Your Product

If you need to store your product or transport it a long distance, prepare it for transportation as described here.

Caution: During transportation and storage, follow these guidelines:

- Because the product is heavy, two or more people should lift and carry it using the hand position shown:

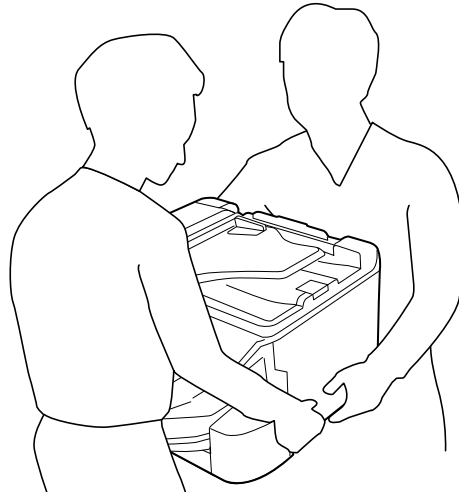

- Avoid tilting the product, positioning it vertically, or turning it upside down; otherwise ink may leak.
- Leave the ink cartridges installed. Removing the cartridges can dry out the print head and may prevent the product from printing.
- Leave the maintenance box installed; otherwise ink may leak.

Note: Before storing your product for a long period, replace low, expended, or expired ink to help prevent the print head from drying out. Store your product in a cool, dry place.

1. Turn off the product.
2. Wait for the  power light to turn off, then unplug the power cord.
3. Remove all the paper from the product.
4. Disconnect any connected cables and external storage devices.

5. Close the rear paper support and remove the output tray.

Note: Do not place the output tray on top of the product. The output tray can fall while the product is being moved and you can be injured.

6. Remove the optional cabinet and paper cassettes (if they are installed) before lifting the product.

Note: If the optional cabinet is installed, you can use the casters on the cabinet to roll the product instead of lifting it. Remove the cabinet stands and unlock the casters before moving the product. Do not roll the product over uneven or rough surfaces to avoid harsh impacts to the product.

7. Place the product in its original packing materials, if possible, or use equivalent materials with cushioning around the product. Make sure the box adequately protects the product control panel.

Parent topic: [Cleaning and Transporting Your Product](#)

Related concepts

[Print Head Cleaning](#)

[Print Quality Adjustment](#)

Related tasks

[Removing and Installing Ink Cartridges](#)

Administering Your Product

Follow the instructions in these sections to configure your product's administrator settings using the Web Config software.

Note: Before you can configure system administration settings, you must connect the product to a network.

[Accessing the Web Config Utility](#)

[Changing the Administrator Password in Web Config](#)

[Configuring Product Settings](#)

[Configuring Security Settings](#)

[Using Your Product on a Secure Network](#)

[Setting Up Universal Print \(Microsoft\)](#)

[Using Epson Device Admin Configuration Software](#)

Accessing the Web Config Utility

You can select your product's network settings and confirm its operating status using a web browser. You do this by accessing your product's built-in Web Config utility from a computer or other device that is connected to the same network as your product.

Note: You can also access the Web Config utility from the product information area in the Epson Smart Panel app.

1. Print a network status sheet.
2. Locate the IP address for your product that is listed on the network status sheet.
3. On a computer or other device connected to the same network as your product, open a web browser.
4. Enter your product's IP address into the address bar.

Note: The printer uses a self-signed certificate when accessing HTTPS. This may cause a warning message when you access Web Config. This does not indicate a problem and can be ignored.

5. Select **Log In** and enter the administrator password. The administrator password is required to access the full capabilities of the Web Config utility.

You see the available Web Config utility options.

Parent topic: [Administering Your Product](#)

Changing the Administrator Password in Web Config

You can set an administrator password using your product's control panel, Web Config, or EpsonNet Config. You can change the administrator password using your product's control panel, Web Config, or Epson Device Admin. You use the same administrator password in all cases.

Note: If you forget your administrator password, contact Epson for support.

1. Access Web Config as an administrator and select the **Product Security** tab.
2. Select **Change Administrator Password**.
3. Enter a user name, if necessary.
4. Enter the current password, then enter and confirm the new password in the fields provided.

Note: The default password is the product's serial number. Check the label on the back of the product to locate the serial number. The default user name is blank.

5. Click **OK**.

Note: To restore the administrator password to the default value, select **Restore Default Settings** on the **Change Administrator Password** screen.

Parent topic: [Administering Your Product](#)

Configuring Product Settings

Follow the instructions in these sections to configure your product's control panel settings using the Web Config software.

[Checking Status Information](#)

[Managing the Network Connection](#)

[Setting Control Panel Options](#)

[Sending Email Notifications](#)

[Adjusting Power Saving Settings](#)

[Adjusting Control Panel Sounds](#)

[Importing and Exporting Product Settings](#)
[Updating Firmware Using Web Config](#)
[Synchronizing the Date and Time with a Time Server](#)
[Clearing the Internal Memory](#)
[Adjusting the Contact List View Options](#)
[Powering Off or Rebooting the Product Remotely](#)
[Restoring Default Product Settings](#)

Parent topic: [Administering Your Product](#)

Checking Status Information

You can check information about the printer using the Web Config interface.

Note: Depending on the features of your product, not all of the options below may be available. Some options are not available unless you are logged in to the Web Config interface.

1. Enter the IP address of the printer to access Web Config and log in as an administrator, if necessary.
2. Select the **Status** tab and choose one of the following options:
 - Select **Product Status** to view information such as ink level and maintenance box status.
 - Select **Network Status** to view network information such as the IP address and network connection status.
 - Select **Usage Status** to view information about the number of prints and historical information about the product.
 - Select **Hardware Status** to view information about the product functions.
 - Select **Job History** to view information about the jobs completed on the product.
 - Select **Panel Snapshot** to view a image of the current LCD screen.

Parent topic: [Configuring Product Settings](#)

Managing the Network Connection

You can check or update the network information for your product using the Web Config interface.

1. Enter the IP address of the product in a web browser and log in as an administrator.
2. Select the **Network** tab, then select **Basic**.
3. Check or update the settings as necessary.

4. Select **Next** to see a summary of the network settings.
5. Select **OK** to accept the changes.

Note: The network connection will be temporarily interrupted to enable the new settings.

6. Select the other network options as necessary:
 - **Wi-Fi:** Displays the current wireless network connection information. Select **Setup** to run the wireless setup again or **Disable Wi-Fi** to turn off Wi-Fi.
 - **Wired LAN:** Displays the current settings for the wired connection. Change the settings as necessary and then select **Next** to view the changes. Confirm the information and select **OK** to apply the changes.
 - **Wi-Fi Direct:** Displays the current settings for the Wi-Fi Direct network. Adjust the settings as necessary and select **Next** to view the changes. Confirm the information and select **OK** to apply the changes.

[Network Settings](#)

Parent topic: [Configuring Product Settings](#)

Network Settings

The following network settings are available under the **Network** tab in the Web Config interface.

Basic

Setting	Description
Device Name	Displays the Device Name. You can enter a new name to change the name of the device.
Location	Displays a user-entered location for the printer
Obtain IP Address	Sets the IP Address; if set to Manual , enter the information in the appropriate fields
Set using BOOTP	Enables IP addressing using BOOTP
Set using Automatic Private IP Addressing (APIPA)	Enables IP addressing using APIPA

Setting	Description
IP Address	Displays the IP address. If you are manually entering the IP address, enter it in the format xxx.xxx.xxx.xxx (where xxx is a number between 0 and 255). Make sure the address is unique and does not conflict with any other device on your network.
Subnet Mask	Displays the subnet mask. If you are manually entering the subnet mask, enter it in the format xxx.xxx.xxx.xxx (where xxx is a number between 0 and 255).
Default Gateway	Displays the default gateway address. If you are manually setting the default gateway, enter it in the format xxx.xxx.xxx.xxx (where xxx is a number between 0 and 255).
DNS Server Setting	Selects the DNS server setting. If the Obtain IP Address setting is set to Manual , this setting is also set to Manual .
Primary DNS Server	Enter the address of the primary DNS server in the format xxx.xxx.xxx.xxx (where xxx is a number between 0 and 255).
Secondary DNS Server	Enter the address of the secondary DNS server in the format xxx.xxx.xxx.xxx (where xxx is a number between 0 and 255).
DNS Host Name Setting	Sets the DNS Host Name selection method.
DNS Host Name	Displays the current DNS Host Name.
DNS Domain Name Setting	Sets the DNS Domain Name selection method
DNS Domain Name	<p>Specifies the DNS domain name. The name must conform to the following format:</p> <ul style="list-style-type: none"> • Enter between 2 and 249 characters using only the characters "A-Z", "a-z", "0-9", hyphen "-", and a period "." • The first character cannot be a "0-9", hyphen "-", or a period "." • The last character cannot be a hyphen "-" or a period "." • Each label in the domain name must be between 1 and 63 characters and separated by a period. • The total number of characters in the host and domain name must not exceed 251.

Setting	Description
Register the network interface address to DNS	Allows you to register the host and domain names through a DHCP server that supports Dynamic DNS
Proxy Server Setting	Enables the use of a proxy server
Proxy Server	Specifies the name of the proxy server in either IPv4 or FQDN format
Proxy Server Port Number	Specifies the port number for the proxy server (between 1 and 65535)
Proxy Server User Name	Specifies the user name for the proxy server (0-255 ASCII characters [0x20-0x7E])
Proxy Server Password	Specifies the password for the proxy server (0-255 ASCII characters [0x20-0x7E])
IPv6 Setting	Enables the use of IPv6 addressing
IPv6 Privacy Extension	Enables the use of private IPv6 addresses
IPv6 DHCP Server Setting	Enables the use of a IPv6 DHCP server
IPv6 Address	<p>Specifies the IPv6 address. The address must conform to the following format:</p> <ul style="list-style-type: none"> • xxxx: xxxx: xxxx: xxxx: xxxx: xxxx: xxxx: xxxx / prefix • xxxx is a hexadecimal number from 1 to 4 digits, and the prefix is a decimal number from 1 to 128. • If there are consecutive blocks where xxxx is all zeros, it can be omitted as ::. (Only one block can be omitted.)
IPv6 Address Default Gateway	<p>Specifies the IPv6 address of the default gateway. The address must conform to the following format:</p> <ul style="list-style-type: none"> • xxxx: xxxx: xxxx: xxxx: xxxx: xxxx: xxxx: xxxx • xxxx is a hexadecimal number from 1 to 4 digits • If there are consecutive blocks where xxxx is all zeros, it can be omitted as ::. (Only one block can be omitted.)
IPv6 Link-Local Address	Displays the valid IPv6 Link-Local Address
IPv6 Stateful Address	Displays the valid IPv6 Stateful Address
IPv6 Stateless Address 1	Displays the valid IPv6 Stateless Address 1

Setting	Description
IPv6 Stateless Address 2	Displays the valid IPv6 Stateless Address 2
IPv6 Stateless Address 3	Displays the valid IPv6 Stateless Address 3
IPv6 Primary DNS Server	Specifies the address for the IPv6 primary DNS server. The address must conform to the following format: <ul style="list-style-type: none"> • xxxx: xxxx: xxxx: xxxx: xxxx: xxxx: xxxx: xxxx • xxxx is a hexadecimal number from 1 to 4 digits • If there are consecutive blocks where xxxx is all zeros, it can be omitted as ::. (Only one block can be omitted)
IPv6 Secondary DNS Server	Specifies the address for the IPv6 secondary DNS server. The address must conform to the following format: <ul style="list-style-type: none"> • xxxx: xxxx: xxxx: xxxx: xxxx: xxxx: xxxx: xxxx • xxxx is a hexadecimal number from 1 to 4 digits • If there are consecutive blocks where xxxx is all zeros, it can be omitted as ::. (Only one block can be omitted.)
IEEE802.11k/v	Enables the use of IEEE802.11k/v network environments
IEEE802.11r	Enables the use of IEEE802.11r network environments

Wired LAN

Setting	Description
Link Speed and Duplex	Selects the communication mode for the wired connection
IEEE 802.3az	Enables the use of IEEE 802.3az network environments

Wi-Fi Direct

Setting	Description
Wi-Fi Direct	Enables the product's Wi-Fi Direct network
SSID	You can change part of the SSID for the product.

Setting	Description
Password	Specifies the password for the Wi-Fi Direct network. Note: Changing the password will disconnect any devices currently connected to the network.
Frequency Range	Selects the frequency range used by the Wi-Fi Direct network.
IP Address	Specifies the IP address for the Wi-Fi Direct network. If set to Manual , enter the IP address in the provided fields.

Parent topic: [Managing the Network Connection](#)

Setting Control Panel Options

You can configure the behavior of the product control panel using the Web Config interface or the menus on the control panel.

1. Enter the IP address of the product in a web browser and log into Web Config as an administrator.
2. Select **Device Management > Control Panel** and set the following items as necessary:
 - **Language:** Sets the display language
 - **Panel Lock:** Requires an administrator login to access some menu settings on the control panel. The administrator password must be set to enable this feature.
 - **Operation Timeout:** Cancels operations and automatically logs out users after a selected time period. You can select a time period between 10 seconds and 240 minutes.

Parent topic: [Configuring Product Settings](#)

Sending Email Notifications

You can set up email notifications that will be sent when an event occurs on the product. You can register up to five destinations.

Note: You must have configured a mail server before setting up notifications.

1. Enter the IP address of the product in a web browser and log into Web Config as an administrator.
2. Select the **Device Management** tab, then select **Email Notification**.

3. Set the contents of the email subject line by selecting items from the drop-down menus.

Note: You cannot select the same item in both menus. If the Location setting is longer than 32 bytes, it will be truncated in the Subject line.

4. Enter up to five email addresses to receive the notification emails, and select the language of the notification email.
5. In the Notification Settings area, select one or more email addresses to receive a notification for each event.
6. Click **OK** to apply the settings.

Note: To clear the email notification settings, select **Restore Default Settings**. This clears all email notification settings, not just the changes made in the current session.

Parent topic: [Configuring Product Settings](#)

Adjusting Power Saving Settings

The product can automatically enter sleep mode or turn off after it has not been used for a while. You can set the delay before the product enters sleep mode or turns off.

1. Log in to the Web Config interface as an administrator.
2. Select the **Device Management** tab, then select the **Power Saving** setting.
3. Set **Sleep Timer** to the number of minutes before the product enters a low-power mode.
4. Select **Power Off Timer** to set the amount to time of inactivity before the product turns off.

Note: If you are using a printer with the fax feature enabled, select **None**.

5. Click **OK**.

Note: You can also configure the power saving settings using the control panel by selecting **Settings > General Settings > Basic Settings** and selecting the feature you want to change.

Parent topic: [Configuring Product Settings](#)

Adjusting Control Panel Sounds

You can adjust the sound level heard when you press buttons on the control panel.

1. Log in to the Web Config interface as an administrator.
2. Select the **Device Management** tab, then select the **Sound** setting.
3. Select volume and sound settings as necessary for **Normal Mode** and **Quiet Mode**. You can also create different sound settings for fax operations.
4. Click **OK**.

Note: You can also configure the sound settings using the control panel by selecting **Settings > General Settings > Basic Settings > Sounds**.

Parent topic: [Configuring Product Settings](#)

Importing and Exporting Product Settings

Follow the instructions in these sections to import and export your product's settings using the Web Config software.

[Exporting Settings Using Web Config](#)

[Importing Settings Using Web Config](#)

Parent topic: [Configuring Product Settings](#)

Exporting Settings Using Web Config

You can export your product's settings and optionally encrypt the settings file with a password.

1. Log in to the Web Config interface as an administrator.
2. Select the **Device Management** tab, then select **Export** under **Export and Import Setting Value**.
3. Select the settings you want to export.

Note: If you select a parent category, the child categories are also selected. By default, items that are unique on the network, such as IP address, cannot be selected. If you want to export these items, select **Enable to select the individual settings of device**. It is recommended that you export only unique items when replacing a product on the network, otherwise you may encounter conflicts on the network.

4. Enter an encryption password, if desired.
5. Click **Export** and save the file.

Parent topic: [Importing and Exporting Product Settings](#)

Importing Settings Using Web Config

You can import settings to your product that you have exported previously. If encryption was used when the settings were exported, obtain the necessary password before you import.

Note: When importing values that include individual information such as a printer name or IP address, make sure the same IP address does not already exist on the same network.

1. Log in to the Web Config interface as an administrator.
2. Select the **Device Management** tab, then select **Import** under **Export and Import Setting Value**.
3. Click **Browse** and select the exported settings file.
4. If necessary, enter the decryption password.
5. Click **Next**.
6. Select the settings to import and click **Next**.
7. Click **OK**.

The selected settings are imported to the product.

Parent topic: [Importing and Exporting Product Settings](#)

Updating Firmware Using Web Config

If your product is connected to the Internet, you can update the product firmware using Web Config.

1. Log in to the Web Config interface as an administrator.
2. Select **Device Management > Firmware Update**.
3. Click **Start** to check for the latest firmware.
4. If there is a firmware update, click **Start** to begin the update.

Note: Make sure the product is not in use and clear any errors on the LCD screen before starting the update. You can also schedule a firmware update by selecting **Automatic Firmware Update** from the menu.

Parent topic: [Configuring Product Settings](#)

Synchronizing the Date and Time with a Time Server

You can synchronize the product with an NTP time server to set the date and time on the product.

Note: If you are using a CA certificate or Kerberos authentication, it is recommended to use a time server to set the date and time.

1. Log in to the Web Config interface as an administrator.
2. Select the **Device Management** tab, then select the **Date and Time > Time Server** setting.
3. Set **Use Time Server** to **Use**.
4. Enter the time server address in **Time Server Address**. You can use the IPv4, IPv6, or FQDN format for the address. You are limited to 252 characters.

Note: If you do not specify the address, leave it blank.

5. Enter an update interval (up to 10080 minutes) in **Update Interval (min)**.
6. Click **OK** to update the settings.

Note: You can see the time server connection status next to **Time Server Status**.

Parent topic: [Configuring Product Settings](#)

Clearing the Internal Memory

You can delete the contents of the product's internal memory, such as password-protected print jobs and downloaded PCL fonts and macros using the Web Config interface. You cannot select individual items to delete.

1. Log in to the Web Config interface as an administrator.
2. Select the **Device Management** tab, then select the **Clear Internal Memory Data** setting.
3. Select **Delete** and confirm your selection.

Parent topic: [Configuring Product Settings](#)

Adjusting the Contact List View Options

You can adjust the way contacts are listed on the product's LCD screen. You can also configure the way searches are performed when searching the contact list.

1. Log in to the Web Config interface as an administrator.
2. Select the **Device Management** tab, then select the **Contacts Manager** setting.
3. Select either **Tile View** or **List View** to control how the contacts are displayed on the product's LCD screen.

4. Select a search option from the **Search Options** drop-down list.
5. Select **OK** to apply your changes.

Parent topic: [Configuring Product Settings](#)

Powering Off or Rebooting the Product Remotely

You can power off or reboot the product using the Web Config interface.

1. Log in to the Web Config interface as an administrator.
2. Select the **Device Management** tab, then select the **Power** setting.
3. Select a power option from the drop down menu and select **Execute**.

Note: After turning off the product, you cannot access Web Config until the product is turned on again.

Parent topic: [Configuring Product Settings](#)

Restoring Default Product Settings

You can reset the product to the default settings using the Web Config interface.

1. Log in to the Web Config interface as an administrator.
2. Select the **Device Management** tab, then select the **Restore Default Settings** setting.
3. Select an option from the drop-down list. You can either restore network settings or all data and settings.
4. Select **Execute** and confirm your selection to restore the product settings.

Parent topic: [Configuring Product Settings](#)

Configuring Security Settings

Follow the instructions in these sections to configure internal security features for your product using the Web Config software.

[Connecting an Authentication Device](#)

[Restricting Features Available for Users](#)

[Disabling the External Interface](#)

[Setting Up Password Encryption](#)

[Working with Audit Logs](#)

[Restricting PDL File Operations](#)

Enabling Program Verification on Start Up
Restricting Domain Access

Parent topic: [Administering Your Product](#)

Connecting an Authentication Device

You can connect an authentication device such as an IC card reader using a USB cable, and check the functionality of the reader using the Web Config interface.

1. Remove the sticker covering the service port on the rear of the product.

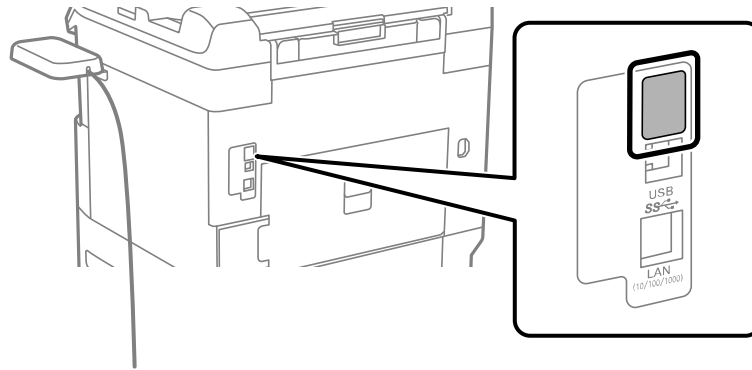

2. Connect the card reader's USB cable to the service port on the product.

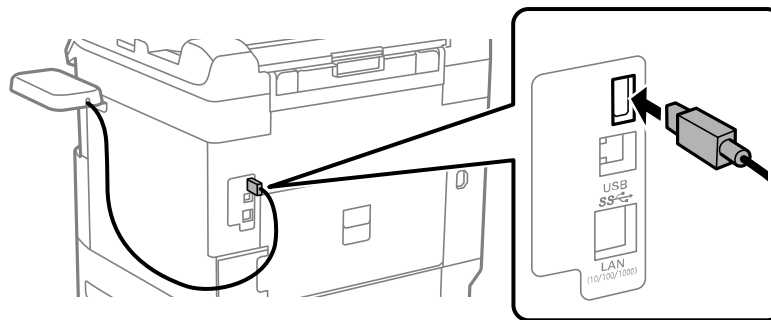

3. Access Web Config and log in using the administrator name and password.

Note: You can also check the card reader status on the product control panel by selecting **Settings > Authentication Device Status**.

4. Select **Device Management > Card Reader**.
5. Set the card reader parameters as necessary.
6. Select **Check** to verify the connection status of the authentication device.

Note: To confirm that the authentication device can recognize an authentication card, hold the card over the reader while you select **Check**.

7. Click **Next**.
8. Click **OK** to confirm the settings.

Parent topic: [Configuring Security Settings](#)

Restricting Features Available for Users

Follow the instructions in these sections to restrict users from using certain product features and create an administrator password to lock the restrictions using the Web Config software.

[User Feature Restriction](#)

[Configuring User Feature Restrictions](#)

Parent topic: [Configuring Security Settings](#)

User Feature Restriction

You can restrict available product features for individual users, with different features available to each user. This requires users to log into the product control panel with their user name and password before they can use control panel features.

With Windows, you can also restrict printing and scanning from the product software. This requires users to log into the printing or scanning software, and allows the software to authenticate the users before printing or scanning proceeds. For instructions on setting up software restrictions, see the help utility in the printing or scanning software.

Parent topic: [Restricting Features Available for Users](#)

Configuring User Feature Restrictions

You can create up to 10 user accounts and restrict access to control panel features separately for each one.

Note: If you are using an authentication system, it uses the number one user account. If you create other user accounts, use the number two to number 10 user accounts.

1. Access Web Config as an administrator and select the **Product Security** tab.

2. Select the **Enables Access Control** checkbox.
3. If you have configured the product for an LDAP server, you can deselect the **Allows printing and scanning without authentication information from a computer** checkbox to prevent the product from receiving jobs sent from these sources:
 - The default operating system driver
 - A PCL or PostScript printer driver
 - Web services such as Epson Connect
 - Smartphones and other mobile devices
4. Click **OK**.
5. Select **User Settings**.
6. Click **Add**.
7. Enter a name for a user in the User Name field following the guidelines on the screen. Use ASCII (0x20-0x7E) characters.
8. Enter a password for the user in the Password field following the guidelines on the screen.

Note: If you need to reset a password, leave the password field blank.

9. Select the checkbox for each function you want the user to be able to perform, and deselect the checkbox for each function you want to restrict access to.
10. Click **Apply**.

Note: When you edit a completed user account, you see a **Delete** option. Click it to delete a user, if necessary.

Note: You can import and export a list of user features using EpsonNet Config. See the help utility in the software for instructions.

Parent topic: [Restricting Features Available for Users](#)

Disabling the External Interface

You can restrict the ability to connect from a computer using a USB connection or accessing a connected USB device or memory card.

Note: Depending on your product features, not all of the options listed below may be available.

1. Access Web Config as an administrator and select **Product Security > External Interface**.
2. Select **Memory Device** and do one of the following:
 - Select **Disable** to prevent access to a USB device or memory card.
 - Select **Enable** to allow access to a USB device or memory card.
3. Select **PC Connection via USB** and do one of the following:
 - Select **Disable** to prevent a computer from connecting to the product over a USB connection.
 - Select **Enable** to allow a computer to connect to the product over a USB connection.
4. Click **OK** to save your setting.

Parent topic: [Configuring Security Settings](#)

Setting Up Password Encryption

You can set up password encryption to protect confidential information stored in the product.

1. Log in to the Web Config interface as an administrator.
2. Select the **Product Security** tab and select **Password Encryption**.
3. Select **On** and select **OK**.

A message appears about restarting the product. Select **OK**.

4. Turn the product off and then on again to apply the password encryption setting.

Note: The product may take longer than usual to turn on. This is normal.

Parent topic: [Configuring Security Settings](#)

Working with Audit Logs

You can enable the Audit Log feature or export audit log data using the Web Config interface. Audit logs can be used to track security issues or identify improper usage.

1. Log in to the Web Config interface as an administrator.
2. Select the **Product Security** tab, then select the **Audit Log** setting.
3. Select **ON** and then click **OK** to enable the audit log feature.
4. Select **Export** to export the audit log data to a CSV file, or select **Delete** to delete all audit logs.

Parent topic: [Configuring Security Settings](#)

Restricting PDL File Operations

You can protect files from unauthorized PDL operations using the Web Config interface.

1. Log in to the Web Config interface as an administrator.
2. Select the **Product Security** tab, then select the **File Operations from PDL** setting.
3. Select **Allowed** or **Not Allowed** to enable or disable PDL file operations and select **OK** to apply your setting.

Parent topic: [Configuring Security Settings](#)

Enabling Program Verification on Start Up

Your product automatically checks whether unauthorized third parties have tampered with the program when the product starts up. If it detects that the product has been rewritten with invalid firmware, it will stop and update the firmware.

If you enable **Do not start if tampering is detected**, the printer will display an error and stop booting. It is not recommended to enable the **Do not start if tampering is detected** setting as the default setting.

1. Log in to the Web Config interface as an administrator.
2. Select the **Product Security** tab, then select **Program Verification on Start Up**.
3. Enable the **Do not start if tampering is detected** setting.

Parent topic: [Configuring Security Settings](#)

Restricting Domain Access

You can set up restrictions on the email domains that can be used for email notifications using the Web Config interface.

1. Log in to the Web Config interface as an administrator.
2. Select the **Product Security** tab, then select the **Domain Restrictions** setting.
3. Select a restriction method for the **Restriction Rule** setting. Select **Allow Sending** to limit sending emails to the listed domains or select **Deny Sending** to prevent emails from being sent to the listed domains.
4. Add the necessary domains to the list by entering them in the **Domain Name** field and selecting **Add**.

The domain is added to the list. To delete a domain, select the checkbox next to the domain name and select **Delete**.

5. Select **OK** to apply your changes.

Parent topic: [Configuring Security Settings](#)

Using Your Product on a Secure Network

Follow the instructions in these sections to configure security features for your product on the network using the Web Config software.

[Configuring Protocols and Services in Web Config](#)

[Configuring SSL/TLS Communication](#)

[Configuring IPsec/IP Filtering](#)

[Connecting the Product to an IEEE 802.1X Network](#)

[Using a Digital Certificate](#)

Parent topic: [Administering Your Product](#)

Configuring Protocols and Services in Web Config

You can enable or disable protocols using Web Config.

1. Access Web Config as an administrator, select **Network Security**, and select **Protocol**.
2. Select or deselect the checkbox next to the service name to enable or disable a protocol.
3. Configure any other available protocol settings.
4. Click **Next**.
5. Click **OK**.
6. Select and configure services and protocol settings as necessary.

After the protocols restart, the changes are applied.

[Protocol Settings](#)

Parent topic: [Using Your Product on a Secure Network](#)

Protocol Settings

Protocols

Name	Description
Bonjour	Bonjour is used to search for devices and AirPrint
SLP	SLP is used for push-scanning and network searching in EpsonNet Config

Name	Description
WSD	Add WSD devices, or print and scan from the WSD port
LLTD	Displays the product on the Windows network map
LLMNR	Use name resolution without NetBIOS even if you cannot use DNS
LPR	Print from to the LPR port
RAW(Port9100)	Print from the RAW port (Port 9100)
IPP	Print over the Internet, including AirPrint
FTP	Print over FTP
SNMPv1/v2c	Remotely set up and monitor your product
SNMPv3	Remotely set up and monitor your product with the SNMPv3 protocol

Bonjour Settings

Setting	Options/Description
Use Bonjour	Search for or use devices through Bonjour
Bonjour Name	Displays the Bonjour name
Bonjour Service Name	Displays the Bonjour service name
Location	Displays the Bonjour location name
Top Priority Protocol	Selects the protocol that is the top priority for Bonjour printing

SLP Settings

Setting	Options/Description
Enable SLP	Enable the SLP function to use the Push Scan function and network searching in EpsonNet Config

WSD Settings

Setting	Options/Description
Enable WSD	Enable adding devices using WSD, and printing and scanning from the WSD port
Printing Timeout (sec)	Enter the communication timeout value for WSD printing between 3 and 3,600 seconds
Scanning Timeout (sec)	Enter the communication timeout value for WSD scanning between 3 and 3,600 seconds
Device Name	Displays the WSD device name
Location	Displays the WSD location name

LLTD Settings

Setting	Options/Description
Enable LLTD	Enable LLTD to display the product in the Windows network map
Device Name	Displays the LLTD device name

LLMNR Settings

Setting	Options/Description
Enable LLMNR	Enable LLMNR to use name resolution without NetBIOS, even if you cannot use DNS

LPR Settings

Setting	Options/Description
Allow LPR Port Printing	Allow printing from the LPR port
Printing Timeout (sec)	Enter the timeout value for LPR printing between 0 and 3,600 seconds

RAW (Port9100) Settings

Setting	Options/Description
Allow RAW (Port9100) Printing	Allow printing from the RAW port (Port 9100)
Printing Timeout (sec)	Enter the timeout value for RAW port (Port 9100) printing between 0 and 3,600 seconds

IPP Settings

Setting	Options/Description
Enable IPP	Enable IPP communication for products that support IPP are displayed (you cannot use AirPrint if disabled)
Allow Non-secure Communication	Allow the printer to communicate without any security measures (IPP)
Communication Timeout (sec)	Enter the timeout value for IPP printing between 0 and 3,600 seconds
URL(Network)	Displays IPP URLs (http and https) when the product is connected using wired LAN or Wi-Fi (the URL is a combined value of the product's IP address, Port number, and IPP printer name)
URL(Wi-Fi Direct)	Displays IPP URLs (http and https) when the product is connected using Wi-Fi Direct (the URL is a combined value of the product's IP address, Port number, and IPP printer name)
Printer Name	Displays the IPP printer name
Location	Displays the IPP location

FTP Settings

Setting	Options/Description
Enable FTP Server	Enable FTP printing for products that support FTP printing
Communication Timeout (sec)	Enter the timeout value for FTP communication between 0 and 3,600 seconds

SNMPv1/v2c Settings

Setting	Options/Description
Enable SNMPv1/v2c	Enable SNMPv1/v2c for products that support SNMPv3
Access Authority	Set the access authority when SNMPv1/v2c is enabled to Read Only or Read/Write
Community Name (Read Only)	Enter 0 to 32 ASCII characters
Community Name (Read/Write)	Enter 0 to 32 ASCII characters

SNMPv3 Settings

Setting	Options/Description
Enable SNMPv3	Enable SNMPv3 for products that support SNMPv3
User Name	Enter 1 to 32 characters
Authentication Settings	Select an algorithm and set a password for authentication
Encryption Settings	Select an algorithm and set a password for encryption
Context Name	Enter 1 to 32 characters in Unicode (UTF-8)

Parent topic: [Configuring Protocols and Services in Web Config](#)

Configuring SSL/TLS Communication

Follow the instructions in these sections to configure SSL/TLS communication using Web Config.

[Configuring SSL/TLS Settings](#)

[Configuring a Server Certificate for the Product](#)

Parent topic: [Using Your Product on a Secure Network](#)

Configuring SSL/TLS Settings

If your product supports HTTPS, you can configure SSL/TLS to encrypt communications with your product.

1. Log in to the Web Config interface as an administrator.
2. Select **SSL/TLS > Basic**.
3. Select one of the options for the **Encryption Strength** setting.

4. Select **Enable** or **Disable** for the **Redirect HTTP to HTTPS** setting as necessary.
5. If necessary, enable a TLS version.
6. Click **Next**.
You see a confirmation message.
7. Click **OK**.

Parent topic: [Configuring SSL/TLS Communication](#)

Configuring a Server Certificate for the Product

You can configure a server certificate for your product.

1. Access Web Config as an administrator and select the **Network Security** tab.
2. Under **SSL/TLS**, select **Certificate**.
3. Select one of the following options:
 - **CA-signed Certificate:** Select **Import** if you have obtained a CA-signed certificate. Choose the file to import and click **OK**.
 - **Self-signed Certificate:** Select **Update** if you have not obtained a CA (Certificate Authority)-signed certificate and want the product to generate a self-signed certificate.
4. Click **Next**.
You see a confirmation message.
5. Click **OK**.

Parent topic: [Configuring SSL/TLS Communication](#)

Configuring IPsec/IP Filtering

Follow the instructions in these sections to configure IPsec/IP traffic filtering using Web Config.

[About IPsec/IP Filtering](#)

[Configuring the Default IPsec/IP Filtering Policy](#)

[Configuring the Group IPsec/IP Filtering Policies](#)

[IPsec/IP Filtering Policy Settings](#)

[IPsec/IP Filtering Configuration Examples](#)

[Configuring an IPsec/IP Filtering Certificate](#)

Parent topic: [Using Your Product on a Secure Network](#)

About IPsec/IP Filtering

You can filter traffic to the product over the network based on IP address, service, and port by configuring a default policy that applies to every user or group connecting to the product. For control of individual users or user groups, you can configure group policies.

Note: IPsec is supported only by computers running Windows Vista or later, or Windows Server 2008 or later.

Parent topic: [Configuring IPsec/IP Filtering](#)

Configuring the Default IPsec/IP Filtering Policy

You can configure the default policy for IPsec/IP traffic filtering using Web Config.

1. Access Web Config as an administrator and select the **Network Security** tab.
2. Under **IPsec/IP Filtering**, select **Basic**.
3. Select **Enable** to enable IPsec/IP filtering.
4. Select the filtering options you want to use for the default policy.
5. Click **Next**.
You see a confirmation message.
6. Click **OK**.

Parent topic: [Configuring IPsec/IP Filtering](#)

Configuring the Group IPsec/IP Filtering Policies

You can configure group policies for IPsec/IP traffic filtering using Web Config.

1. Access Web Config as an administrator and select the **Network Security** tab.
2. Under **IPsec/IP Filtering**, select **Basic**.
3. Click a tab number for the policy number you want to configure.
4. Select the **Enable this Group Policy** checkbox.
5. Select the filtering options you want to use for this group policy.
6. Click **Next**.
You see a confirmation message.
7. Click **OK**.

8. If you want to configure additional group policies, click the next tab number and repeat the configuration steps as necessary.

Parent topic: [Configuring IPsec/IP Filtering](#)

IPsec/IP Filtering Policy Settings

Default Policy Settings

Setting	Options/Description
Access Control	<p>Permit Access to permit IP packets to pass through</p> <p>Refuse Access to prevent IP packets from passing through</p> <p>IPsec to permit IPsec packets to pass through</p>
Authentication Method	Select an authentication method, or select Certificate if you have imported a CA-signed certificate
Pre-Shared Key	If necessary, enter a pre-shared key between 1 and 127 characters long
Encapsulation	<p>If you selected IPsec as the Access Control option, select one of these encapsulation modes:</p> <p>Transport Mode: if you are using the product on the same LAN; IP packets of layer 4 or later are encrypted</p> <p>Tunnel Mode: if you are using the product on an Internet-capable network, such as IPsec-VPN; the header and data of IP packets are encrypted</p>
Remote Gateway(Tunnel Mode)	If you selected Tunnel Mode as the Encapsulation option, enter a gateway address between 1 and 39 characters long
Security Protocol	<p>If you selected IPsec as the Access Control option, select one of these security protocols:</p> <p>ESP: to ensure the integrity of authentication and data, and encrypt data</p> <p>AH: to ensure the integrity of authentication and data; if data encryption is prohibited, you can use IPsec</p>

Group Policy Settings

Setting	Options/Description
Access Control	<p>Permit Access to permit IP packets to pass through</p> <p>Refuse Access to prevent IP packets from passing through</p> <p>IPsec to permit IPsec packets to pass through</p>
Local Address(Printer)	Select an IPv4 or IPv6 address that matches your network environment; if the IP address is assigned automatically, select Use auto-obtained IPv4 address
Remote Address(Host)	Enter the device's IP address (between 0 and 43 characters long) to control access, or leave blank to control all addresses; if the IP address is assigned automatically, such as by DHCP, the connection may be unavailable, so configure a static address instead
Method of Choosing Port	Select the method you want to used for specifying ports
Service Name	If you selected Service Name as the Method of Choosing Port option, select a service name option here; see the next table for more information
Transport Protocol	<p>If you selected Port Number as the Method of Choosing Port option, select one of these encapsulation modes:</p> <p>Any Protocol</p> <p>TCP</p> <p>UDP</p> <p>ICMPv4</p> <p>See the Group Policy Guidelines table for more information.</p>
Local Port	If you selected Port Number as the Method of Choosing Port option, and TCP or UDP for the Transport Protocol option, enter the port numbers that control receiving packets (up to 10 ports), separated by commas, for example 20,80,119,5220 ; leave this setting blank to control all ports; see the next table for more information

Setting	Options/Description
Remote Port	If you selected Port Number as the Method of Choosing Port option, and TCP or UDP for the Transport Protocol option, enter the port numbers that control sending packets (up to 10 ports), separated by commas, for example 25,80,143,5220 ; leave this setting blank to control all ports; see the next table for more information
Authentication Method	If you selected IPsec as the Access Control option, select an authentication method here
Pre-Shared Key	If you selected Pre-Shared Key as the Authentication Method option, enter a pre-shared key between 1 and 127 characters long here and in the Confirm Pre-Shared Key field
Encapsulation	If you selected IPsec as the Access Control option, select one of these encapsulation modes: Transport Mode: if you are using the product on the same LAN; IP packets of layer 4 or later are encrypted Tunnel Mode: if you are using the product on an Internet-capable network, such as IPsec-VPN; the header and data of IP packets are encrypted
Remote Gateway(Tunnel Mode)	If you selected Tunnel Mode as the Encapsulation option, enter a gateway address between 1 and 39 characters long
Security Protocol	If you selected IPsec as the Access Control option, select one of these security protocols: ESP: to ensure the integrity of authentication and data, and encrypt data AH: to ensure the integrity of authentication and data; if data encryption is prohibited, you can use IPsec

Group Policy Guidelines

Service name	Protocol type	Local/Remote port number	Controls these operations
ENPC	UDP	3289/Any port	Searching for a product from applications such as printer or scanner drivers, or EpsonNet Config
SNMP	UDP	161/Any port	Acquiring and configuring MIB from applications such as printer or scanner drivers, or EpsonNet Config
LPR	TCP	515/Any port	Forwarding LPR data
RAW (Port9100)	TCP	9100/any port	Forwarding RAW data
IPP/IPPS	TCP	631/Any port	Forwarding AirPrint data (IPP/IPPS printing)
WSD	TCP	Any port/5357	Controlling WSD
WS-Discovery	UDP	3702/Any port	Searching for a product from WSD
Network Scan	TCP	1865/Any port	Forwarding scan data from Document Capture Pro
Network Push Scan	TCP	Any port/2968	Acquiring job information on push scanning from Document Capture Pro
Network Push Scan Discovery	UDP	2968/Any port	Searching for a computer during push scanning from Document Capture Pro
FTP Data (Local)	TCP	20/Any port	Forwarding FTP printing data to FTP server
FTP Control (Local)	TCP	21/Any port	Controlling FTP printing to FTP server
FTP Data (Remote)	TCP	Any port/20	Forwarding scan data and received fax data to FTP client; controls only an FTP server that uses remote port 20
FTP Control (Remote)	TCP	Any port/21	Forwarding scan data and received fax data to FTP client

Service name	Protocol type	Local/Remote port number	Controls these operations
CIFS (Local)*	TCP	445/Any port	Sharing a network folder on CIFS server
CIFS (Remote)*	TCP	Any port/445	Forwarding scan data and received fax data to a folder on CIFS server
NetBIOS Name Service (Local)	UDP	137/Any port	Sharing a network folder on CIFS server
NetBIOS Datagram Service (Local)	UDP	138/Any port	
NetBIOS Session Service (Local)	TCP	139/Any port	
NetBIOS Name Service (Remote)	UDP	Any port/137	Forwarding scan data and received fax data to a folder on CIFS server
NetBIOS Datagram Service (Remote)	UDP	Any port/138	
NetBIOS Session Service (Remote)	TCP	Any port/139	
HTTP (Local)	TCP	80/Any port	Forwarding Web Config and WSD data to a HTTP or HTTPS server
HTTPS (Local)	TCP	443/Any port	
HTTP (Remote)	TCP	Any port/80	Communicating with Epson Connect, firmware update, and root certificate update on a HTTP or HTTPS client
HTTPS (Remote)	TCP	Any port/443	

* To control forwarding of scan and received fax data, share a network folder, or receive fax data from PC-Fax, select **Port Number** as the **Method of Choosing Port** option and specify the port numbers for CIFS and NetBIOS.

Parent topic: [Configuring IPsec/IP Filtering](#)

IPsec/IP Filtering Configuration Examples

You can configure IPsec and IP filtering in a variety of ways, as shown in the examples here.

Receiving IPsec Packets Only

Use this example only for configuring a default policy.

- **IPsec/IP Filtering: Enable**
- **Access Control: IPsec**
- **Authentication Method: Pre-Shared Key**
- **Pre-Shared Key:** Enter a key up to 127 characters long

Receiving Printing Data and Printer Settings

Use this example to allow communication of printing data and printer settings from specified services.

Default policy:

- **IPsec/IP Filtering: Enable**
- **Access Control: Refuse Access**

Group policy:

- **Access Control: Permit Access**
- **Remote Address(Host):** Client IP address
- **Method of Choosing Port: Service Name**
- **Service Name:** Select **ENPC**, **SNMP**, **HTTP (Local)**, **HTTPS (Local)**, and **RAW (Port9100)**

Receiving Access from Only a Specified Address for Product Access

In these examples, the client will be able to access and configure the product in any policy configuration.

Default policy:

- **IPsec/IP Filtering: Enable**
- **Access Control: Refuse Access**

Group policy:

- **Access Control: Permit Access**
- **Remote Address (Host):** Administrator's client IP address

Parent topic: [Configuring IPsec/IP Filtering](#)

Configuring an IPsec/IP Filtering Certificate

You can configure a certificate for IPsec/IP traffic filtering using Web Config.

1. Access Web Config as an administrator and select the **Network Security** tab.
2. Under **IPsec/IP Filtering**, select **Client Certificate**.
3. Click **Import** to add a new client certificate and enter any necessary settings.
4. Click **OK**.

Parent topic: [Configuring IPsec/IP Filtering](#)

Connecting the Product to an IEEE 802.1X Network

Follow the instructions in these sections to connect the product to an IEEE 802.1X network using Web Config.

[Configuring an IEEE 802.1X Network](#)

[IEEE 802.1X Network Settings](#)

[Configuring a Certificate for an IEEE 802.1X Network](#)

[IEEE 802.1X Network Status](#)

Parent topic: [Using Your Product on a Secure Network](#)

Configuring an IEEE 802.1X Network

If your product supports IEEE 802.1X, you can use it on a network with authentication provided by a RADIUS server with a hub as an authenticator using Web Config.

Note: TLS version 1.3 does not support this function.

1. Access Web Config as an administrator and select the **Network Security** tab.
2. Under **IEEE802.1X**, select **Basic**.
3. Select **Enable** as the **IEEE802.1X (Wired LAN)** setting.
4. To use the product on a Wi-Fi network, enable your product's Wi-Fi settings.
The status of the connection is shown as the **IEEE802.1X (Wi-Fi)** setting.

Note: You can share the network settings for Ethernet and Wi-Fi networking.

5. Select the IEEE 802.1X setting options you want to use.
6. Click **Next**.
You see a confirmation message.
7. Click **OK**.

Parent topic: [Connecting the Product to an IEEE 802.1X Network](#)

IEEE 802.1X Network Settings

You can configure these IEEE 802.1X network settings in Web Config.

Setting	Options/Description
IEEE802.1X (Wired LAN)	Enable or disable settings (IEEE802.1X > Basic)
IEEE802.1X (Wi-Fi)	Displays the IEEE802.1X (Wi-Fi) connection status
Connection Method	Displays the current network connection method
EAP Type	Select one of these authentication methods for connections between the product and a RADIUS server: EAP-TLS or PEAP-TLS : You must obtain and import a CA-signed certificate PEAP/MSCHAPv2 or EAP-TTLS : You must configure a password
User ID	Enter an ID between 1 and 128 ASCII characters for authentication on a RADIUS server
Password	Enter a password between 1 and 128 ASCII characters for authentication of the product. If you are using Windows as a RADIUS server, enter up to 127 ASCII characters.
Confirm Password	Enter the authentication password again
Server ID	Enter a server ID between 1 and 128 ASCII characters for authentication on a specified RADIUS server; server ID is verified in the subject/subjectAltName field of a server certificate sent from the RADIUS server
Certificate Validation	Select a valid certificate regardless of the authentication method; import the certificate using the CA Certificate option
Anonymous Name	If you selected EAP-TTLS , PEAP-TLS or PEAP/MSCHAPv2 as the Authentication Method setting, you can configure an anonymous name between 1 and 128 ASCII characters instead of a user ID for phase 1 of a PEAP authentication

Setting	Options/Description
Encryption Strength	Select one of the following encryption strengths: High for AES256/3DES Middle for AES256/3DES/AES128/RC4

Parent topic: [Connecting the Product to an IEEE 802.1X Network](#)

Configuring a Certificate for an IEEE 802.1X Network

If your product supports IEEE 802.1X, you can configure a certificate for the network using Web Config.

1. Access Web Config as an administrator and select the **Network Security** tab.
2. Under **IEEE802.1X**, select **Client Certificate**.
3. Click **Import** to add a new client certificate.

Note: If you have already imported a certificate published by a Certification Authority, you can copy the certificate and use it in IEEE802.1X. To copy, select **Copy From**, select the certificate, and then click **Copy**.

4. Click **OK**.

Parent topic: [Connecting the Product to an IEEE 802.1X Network](#)

IEEE 802.1X Network Status

You can check the status of the IEEE 802.1X network settings by printing a status sheet from your product.

The network status sheet displays the information in this table for IEEE 802.1X networks.

Status ID	Status description
Disable	IEEE 802.1X is disabled
EAP Success	IEEE 802.1X authentication is confirmed and the network connection is available
Authenticating	IEEE 802.1X authentication in progress
Config Error	Authentication failed because the user ID was not set
Client Certificate Error	Authentication failed because the client certificate is out of date

Status ID	Status description
Timeout Error	Authentication failed because there is no answer from the RADIUS server and/or authenticator
User ID Error	Authentication failed because the product's user ID and/or certificate protocol is incorrect
Server ID Error	Authentication failed because the server ID on the server certificate and the server's ID do not match
Server Certificate Error	Authentication failed because the server certificate is out of date or the chain of the server certificate is incorrect
CA Certificate Error	Authentication failed because the CA certificate is incorrect, not imported, or out of date
EAP Failure	Authentication failed because the client certificate is incorrect (EAP-TLS or PEAP-TLS), or the user ID or password is incorrect (PEAP/MSCHAPv2 or EAP-TTLS)

Parent topic: [Connecting the Product to an IEEE 802.1X Network](#)

Using a Digital Certificate

Follow the instructions in these sections to configure and use digital certificates using Web Config.

[About Digital Certification](#)

[Obtaining and Importing a CA-signed Certificate](#)

[CSR Setup Settings](#)

[CSR Import Settings](#)

[Deleting a CA-signed Certificate](#)

[Updating a Self-signed Certificate](#)

[Importing a CA Certificate](#)

[Deleting a CA Certificate](#)

Parent topic: [Using Your Product on a Secure Network](#)

About Digital Certification

You can configure the following digital certificates for your network using Web Config:

CA-signed Certificate

You can ensure secure communications using a CA-signed certificate for each security feature. The certificates must be signed by and obtained from a CA (Certificate Authority).

CA Certificate

A CA certificate indicates that a third party has verified the identity of a server. You need to obtain a CA certificate for server authentication from a CA that issues it.

Self-signed Certificate

A self-signed certificate is issued and signed by the product itself. You can use the certificate for only SSL/TLS communication, however security is unreliable and you may see a security alert in the browser during use.

Parent topic: [Using a Digital Certificate](#)

Obtaining and Importing a CA-signed Certificate

You can obtain a CA-signed certificate by creating a CSR (Certificate Signing Request) using Web Config and submitting it to a certificate authority. The CSR created in Web Config is in PEM/DER format. You can import one CSR created from Web Config at a time.

1. Access Web Config as an administrator and select **Network Security**.
2. Select one of the available network security options and select a certificate option.
3. In the CSR section, select **Generate**.
4. Select the CSR setting options you want to use.
5. Click **OK**.
You see a completion message.
6. Select **Network Security**, select your network security option, and select **Certificate** again.
7. In the CSR section, click the **Download** option that matches the format specified by your certificate authority to download the CSR.

Caution: Do not generate another CSR or you may not be able to import a CA-signed certificate.

8. Submit the CSR to the certificate authority following the format guidelines provided by that authority.
9. Save the issued CA-signed certificate to a computer connected to the product.
Before proceeding, make sure the time and date settings are correct on your product.
10. Select **Network Security**, select your network security option, and select **Certificate** or **Client Certificate** as necessary.
11. In the CA Certificate section, click **Import**.
12. Select the format of the certificate as the **Server Certificate** setting.

13. Select the certificate import settings as necessary for the format and the source from which you obtained it.

14. Click **OK**.

You see a confirmation message.

15. Click **Confirm** to verify the certificate information.

Parent topic: [Using a Digital Certificate](#)

CSR Setup Settings

You can select these settings when setting up a CSR in Web Config.

Note: The available key length and abbreviations vary by certificate authority, so follow the rules of that authority when entering information in the CSR.

Setting	Options/Description
Key Length	Select a key length for the CSR
Common Name	Enter a name or static IP address from 1 to 128 characters long; for example, Reception printer or https://10.152.12.225 (you can enter up to five IPv4 addresses, IPv6 addresses, host names, or FQDNs by separating them with commas)
Organization, Organizational Unit, Locality, State/Province	Enter information in each field as necessary, from 0 to 64 characters long in ASCII; separate any multiple names with commas
Country	Enter a two-digit country code number as specified by the ISO-3166 standard
Sender's Email Address	Enter the sender's email address for the mail server setting (enter the same email address as the Sender's Email Address in Network > Email Server > Basic)

Parent topic: [Using a Digital Certificate](#)

CSR Import Settings

You can configure these settings when importing a CSR in Web Config.

Note: The import setting requirements vary by certificate format and how you obtained the certificate.

Certificate format	Setting descriptions
PEM/DER format obtained from Web Config	<p>Private Key: Do not configure because the product contains a private key</p> <p>Password: Do not configure</p> <p>CA Certificate 1/CA Certificate 2: Optional</p>
PEM/DER format obtained from a computer	<p>Private Key: Configure a private key</p> <p>Password: Do not configure</p> <p>CA Certificate 1/CA Certificate 2: Optional</p>
PKCS#12 format obtained from a computer	<p>Private Key: Do not configure</p> <p>Password: Optional</p> <p>CA Certificate 1/CA Certificate 2: Do not configure</p>

CA-signed Certificate Import Settings

Setting	Description
Server Certificate or Client Certificate	<p>Select the certificate format.</p> <p>For an SSL/TLS connection, the Server Certificate is displayed.</p> <p>For an IPsec/IP Filtering, IEEE802.1x, or S/MIME connection, the Client Certificate is displayed.</p> <p>Note: Depending on your product, not all connection types may be available.</p>
Private Key	<p>If you obtain a certificate of the PEM/DER format by using a CSR created from a computer, specify a private key file that matches the certificate.</p>
Password	<p>If the file format is Certificate with Private Key (PKCS#12), enter the password for encrypting the private key that is set when you obtain the certificate.</p>

Setting	Description
CA Certificate 1	If your certificate's format is Certificate (PEM/DER) , import a certificate from a certificate authority that issues a CA-signed Certificate to be used as the server certificate. Specify a file if necessary.
CA Certificate 2	If your certificate's format is Certificate (PEM/DER) , import a certificate from the same certificate authority that issued CA Certificate 1. Specify a file if necessary.

Parent topic: [Using a Digital Certificate](#)

Deleting a CA-signed Certificate

You can delete an imported CA-signed certificate with Web Config when the certificate expires or if you have no more need for an encrypted connection.

Note: If you obtained a CA-signed certificate from Web Config, you cannot import a deleted certificate; you must obtain and import a new certificate.

1. Access Web Config as an administrator and select **Network Security**.
2. Select one of the following network security options and corresponding certificate:
 - **SSL/TLS** and select **Certificate**
 - **IPsec/IP Filtering** and select **Client Certificate**
 - **IEEE802.1X** and select **Client Certificate**
3. Click **Delete**.
You see a completion message.
4. Click **OK**.

Parent topic: [Using a Digital Certificate](#)

Updating a Self-signed Certificate

If your product supports the HTTPS server feature, you can update a self-signed certificate using Web Config.

1. Access Web Config as an administrator and select **Network Security**.
2. Click **Update**.

3. Enter an identifier for your product from 1 to 128 characters long in the **Common Name** field.
4. Select a validity period for the certificate as the **Certificate Validity (year)** setting.
5. Click **Next**.
You see a completion message.
6. Click **OK**.
7. Click **Confirm** to verify the certificate information.

Parent topic: [Using a Digital Certificate](#)

Importing a CA Certificate

You can import a CA certificate using Web Config.

1. Access Web Config as an administrator and select **Network Security**.
2. Select **CA Certificate**.
3. Select **Import**.
4. Select the CA certificate you want to import.
5. Click **OK**.

When you see the **CA Certificate** page and the imported certificate is displayed, the import is finished.

Parent topic: [Using a Digital Certificate](#)

Deleting a CA Certificate

You can delete an imported CA certificate with Web Config when the certificate expires or if you have no more need for an encrypted connection.

1. Access Web Config as an administrator and select **Network Security** .
2. Select **CA Certificate**.
3. Locate the certificate you want to remove and click the **Delete** button next to it.
4. Click **OK** to confirm the deletion.
5. Click **Reboot Network**, and then check that the deleted CA Certificate is not listed on the updated screen.

Parent topic: [Using a Digital Certificate](#)

Setting Up Universal Print (Microsoft)

You can set up your product for use with Universal Print if you are using Microsoft 365 and Azure Active Directory.

Note: This feature is supported on Windows 10 2004 (20H1) or later. Visit the Microsoft website for more information.

1. Access Web Config as an administrator and select the **Network** tab.
2. Select **Universal Print**.
3. Select **Register**.
4. Follow the on-screen instructions to register your product.

If Web Config shows **Registered** as the registration status, then setup is complete.

Parent topic: [Administering Your Product](#)

Using Epson Device Admin Configuration Software

With Windows, you can discover and monitor remote devices, and configure network settings in a batch operation. See the Epson Device Admin help for instructions.

To install Epson Device Admin, download the software from the support page at [epson.com/support](https://www.epson.com/support) (U.S.) or [epson.ca/support](https://www.epson.ca/support) (Canada) and follow the on-screen instructions.

Parent topic: [Administering Your Product](#)

Solving Problems

Check these sections for solutions to problems you may have using your product.

[Viewing the Help Screen](#)

[Product Status Messages](#)

[Job Status Error Codes](#)

[Running a Product Check](#)

[Resetting Control Panel Defaults](#)

[Solving Setup Problems](#)

[Solving Network Problems](#)

[Solving Copying Problems](#)

[Solving Paper Problems](#)

[Solving Problems Printing from a Computer](#)

[Solving Page Layout and Content Problems](#)

[Solving Print Quality Problems](#)

[Solving Scanning Problems](#)

[Solving Scanned Image Quality Problems](#)

[Solving Faxing Problems](#)

[Solving USB Device Problems](#)

[Uninstall Your Product Software](#)

[Where to Get Help](#)

Viewing the Help Screen

You can view troubleshooting or how-to topics on the LCD screen at any time.

1. Select the  help icon.
2. Select a **Troubleshooting** or **How To** option to view instructional images or animations.

Parent topic: [Solving Problems](#)

Product Status Messages

You can often diagnose problems with your product by checking the messages and status icons on its LCD screen. You can also check for errors by pressing the  **Job/Status** button and selecting **Printer Status**.

Note: If the screen is dark, press the screen to wake the product from sleep mode.

LCD screen message	Condition/solution
Printer error. For details, see your documentation.	<p>Turn the product off and then back on again. If the error persists, check for and remove any jammed paper or protective materials from the product. If the error still persists, contact Epson for support.</p> <p>If you see any of the following error codes, make sure you have not exceeded the loading capacity for any paper source:</p> <ul style="list-style-type: none"> • 000181 • 000184 • 000201 • 000204 • 000221 • 000224
Printer error. Contact Epson Support. Non-printing features are available.	The product may be damaged, but non-printing features are still available. Contact Epson for support.
Paper out in XX. Load paper. Paper Size: XX/Paper Type: XX	Load the size and type of paper in the paper source indicated.
Too many paper cassette units are installed. Turn the power off and uninstall. For details, see your documentation.	You can install up to three optional paper cassette units. Remove any extra units.
Unsupported Paper Cassette Units have been installed. Turn the power off and uninstall. For details, see your documentation.	Unsupported optional paper cassette units are installed. Remove the unsupported units.
Cannot print because XX is out of order. You can print from another cassette.	Turn the product off and then back on again. Reinsert the indicated paper cassette. If the error persists, contact Epson for support.

LCD screen message	Condition/solution
The pickup roller in XX is nearing the end of its service life.	The maintenance rollers need to be replaced periodically for optimal performance. (Paper may not feed correctly from the paper cassette or rear paper feed when a maintenance roller is near the end of its service life.)
The pickup roller in XX has reached the end of its service life. Replace the pickup roller, and then perform a counter reset.	Replace the maintenance rollers and reset the maintenance roller counter for the paper cassette for which you replaced the maintenance rollers.
The pickup roller in XX has reached the end of its service life.	Contact Epson for support.
You need to replace Ink Cartridge(s).	Replace the indicated ink cartridges.
The time for maintenance is approaching. Contact Epson Support.	Do not attempt to perform maintenance on your own. Contact Epson for support.
This printer may need a service to maintain good print quality. Contact Epson Support.	Do not attempt to perform maintenance on your own. Contact Epson for support.
Paper Setup Auto Display is set to Off. Some features may not be available. For details, see your documentation.	AirPrint is not available when the Paper Setup Auto Display setting is disabled. Set the Paper Setup Auto Display setting to On .
No dial tone is detected.	Make sure the phone cable is connected correctly and the phone line works. If you connected the product to a PBX (Private Branch Exchange) phone line or Terminal Adapter, change the Line Type setting to PBX . If you still cannot send a fax, turn off the Dial Tone Detection setting. (Turning off the Dial Tone Detection setting may cause the product to drop the first digit of a fax number.)
Failed to receive faxes because the fax data capacity is full. Touch the Job/Status at the bottom of the Home Screen for details.	Press the  Job/Status button, select Printer Status , and resolve any printer errors that prevented faxes from printing. Make sure the product is connected to a computer or that a USB device is connected to the product.

LCD screen message	Condition/solution
The combination of the IP address and the subnet mask is invalid. See your documentation for more details.	There is a problem with the network connection to your product. Set up your product on the network again.
To use cloud services, update the root certificate from the Epson Web Config utility.	Access the Web Config utility and update the cloud service root certificate.
Check that the printer driver is installed on the computer and that the port settings for the printer are correct.	Make sure the printer port is correctly configured. In Windows, make sure the port is set to a USBXXX setting for a USB connection or EpsonNet Print Port for a network connection.
Check that the printer driver is installed on the computer and that the USB port settings for the printer are correct.	
Recovery mode Update Firmware	An error has occurred during firmware updating. Connect your product using a USB cable and try downloading the Firmware Update from the Epson support site. If you still need help, contact Epson for support.

Parent topic: [Solving Problems](#)

Related references

[Where to Get Help](#)

Related tasks

[Removing and Installing Ink Cartridges](#)

[Selecting the Line Type](#)

[Accessing the Web Config Utility](#)

[Connecting a Telephone or Answering Machine](#)

Related topics

[Wi-Fi or Wired Networking](#)

Job Status Error Codes

If a job does not complete successfully, you can check the error code for the reason. Press the  **Job/Status** button, select **Job Status > Log**, and select the incomplete job to display the error code and additional information.

Code	Condition/solution
001	The product was turned off by a power failure.
101	Memory is full. Reduce the size of the print job.
102	Collated printing has failed due to a lack of available memory. Clear fonts and macros from the product's memory using the PDL Font, Macro option from the Settings > General Settings > System Administration > Clear Internal Memory Data menu, reduce the size of the print job, or print one copy at a time.
103	Print quality was decreased due to a lack of available memory. If the quality of the printout is unacceptable, try changing the format setting or simplifying the page by reducing the number of graphics or the number and size of the fonts.
104	Reverse printing has failed due to a lack of available memory. Clear fonts and macros from the product's memory using the PDL Font, Macro option from the Settings > General Settings > System Administration > Clear Internal Memory Data menu or reduce the data size of the print job.
106	Cannot print from the computer due to access control settings. Contact your product administrator.
107	User authentication failed and the job has been canceled. Contact your product administrator.
108	Confidential job data was deleted when the product was turned off.
109	The received fax was already deleted.
110	The job was printed 1-sided because the loaded paper does not support 2-sided printing. Load paper that supports 2-sided printing.
111	Available memory is running low. Reduce the size of the print job.
120	Cannot communicate with a server using an open platform. Check the server or network for errors.
130	Collated printing has failed due to a lack of available memory. Reduce the size of the print job or try printing one copy at a time.

Code	Condition/solution
131	Reverse printing has failed due to a lack of available memory. Reduce the size of the print job.
132	Cannot print due to a lack of available memory. Reduce the size of the print data.
133	Cannot print on 2-sides due to a lack of available memory; only one side will be printed. Reduce the size of the print data.
151	Printing is not performed because the login user name and the user name associated with the confidential job do not match. Make sure you login with the same user name as the user name associated with the confidential job.
201	The product's memory is full. You can send pages individually, or print received faxes and delete them to free up memory space.
202	The line was disconnected by the recipient's fax machine. Wait a moment, then try again.
203	<p>The product cannot detect a dial tone.</p> <p>Make sure the phone cable is connected correctly and the phone line works. If you connected the product to a PBX (Private Branch Exchange) phone line or Terminal Adapter, change the Line Type setting to PBX. If you still cannot send a fax, turn off the Dial Tone Detection setting. (Turning off the Dial Tone Detection setting may cause the product to drop the first digit of a fax number.)</p>
204	The recipient's fax machine is busy. Confirm the recipient's fax number, wait a moment, then try again.
205	The recipient's fax machine does not answer. Wait a moment, then try again.
206	The phone cable is incorrectly connected to the product's LINE and EXT. ports. Connect the phone cable correctly.
207	The phone cable is not connected. Connect the phone cable.
208	<p>The fax could not be sent to some of the specified recipients.</p> <p>Print a fax log or Last Transmission report to check which recipients failed to receive the fax. If the Save Failure Data setting is turned on, you can resend a fax from Job Status in the Job/Status Menu.</p>
301 401	There is not enough storage space available to save the data in the external memory device. Clear space on the device, reduce the number of documents, or use a different device.

Code	Condition/solution
302 402	The external memory device is write-protected. Disable write protection.
303	No folder is available for saving the scanned file. Create a folder or use a different memory device.
304 404	An external memory device has been removed. Reinsert the device.
305 405	An error occurred while saving data to an external memory device. Reinsert the memory device or use a different device.
306 327	The product's memory is full. Wait until current jobs are finished processing.
307	The scanned image size exceeds the maximum limit (Scan to a Memory Device). Lower the scanning resolution or increase the compression ratio to reduce scanned image size.
311 321 411 421	A DNS error has occurred. Check the DNS settings for the server, computer, or access point. DNS settings for the server can be checked from the DNS Server option in the Setup menu. If you cannot clear the problem, contact your product administrator.
312 412	An authentication error has occurred. Check the Server Settings in the Settings menu. If you cannot clear the problem, contact your product administrator.
313 413	A communication error has occurred. Print a network connection report to check if the product is connected to the network. Check the email server settings. The authentication method of the settings and email server may not match. If the authentication method is disabled, set the authentication method of the email server to None .
314	The data size exceeds the maximum size for the attached files. Increase the Attached File Max Size setting in the scan settings or lower the file size of the scanned image.
315	The memory is full. Retry after other ongoing jobs have finished.
316	A mail encryption error has occurred. Make sure the encryption setting and printer's time setting are correct.
317	A mail signature error has occurred. Make sure the encryption setting and printer's time setting are correct.

Code	Condition/solution
318	A domain restriction error has occurred. Contact your administrator to check if the domain of your email destination is restricted.
321	A DNS error has occurred. Check the DNS settings for the server, the computer, or the access point.
322	An authentication error occurred. Check the Location settings.
323	A communication error has occurred. Check the Location settings or the network connection.
324	A file with the same name already exists in the specified folder. Delete the duplicate file or change the file name prefix in File Settings .
325 326	There is not enough storage space available in the specified folder. Increase the storage space in the specified folder, delete unnecessary files, or lower the file size of the scanned image.
328	The destination was wrong or the destination does not exist. Check the Location settings.
331	A communication error occurred. Print a network status report to check the product's network connection.
332	There is not enough space available for saving the scanned files in the specified folder. Reduce the number of documents or delete unnecessary files from the specified folder.
333	The destination could not be found because the destination information was uploaded to the server before sending the scanned data. Select the destination again.
334	An error occurred while sending the scanned data.
341	A communication error has occurred. Make sure the product is connected to the computer or network correctly. Make sure you have installed Document Capture Pro or Document Capture. If you cannot clear the problem, contact your product administrator.
350	An FTPS/HTTPS certificate error has occurred. Make sure the date/time and time difference settings are correct; run Web Config to update the root certificate or import and update the CA certificate.
422	An authentication error has occurred. Make sure the settings are correct for the Destination folder selected in Save/Forward Settings in the Receive Settings menu.

Code	Condition/solution
423	A communication error has occurred. It is also possible that a file with the same name is open or the file is a read-only file. Check the network connection, make sure the settings are correct for the Destination folder selected in Save/Forward Settings in the Receive Settings menu. If you cannot clear the problem, contact your product administrator.
425	There is not enough storage space available in the forwarding destination folder. Increase the storage space in the destination folder.
428	The destination was wrong or the destination does not exist. Make sure the settings are correct for the Destination folder selected in Save/Forward Settings in the Settings menu.

Parent topic: [Solving Problems](#)

Related tasks

[Connecting a Telephone or Answering Machine](#)

[Selecting the Line Type](#)

[Entering a User ID and Password for Printing](#)

[Saving and Viewing Received Faxes](#)

[Selecting Advanced Fax Settings](#)

[Setting User Feature Restrictions \(Access Control\)](#)

Related topics

[Sending Faxes](#)

[Wi-Fi or Wired Networking](#)

Running a Product Check

Running a product check helps you determine if your product is operating properly.

1. Disconnect any interface cables connected to your product.
2. Load plain paper in the product.
3. Press the  home button, if necessary.
4. Select **Settings** > **Maintenance** > **Print Head Nozzle Check** > **Start**.
The nozzle pattern prints.

5. Do one of the following, depending on the results of the product check:
 - If the page prints and the nozzle check pattern is complete, the product is operating properly. Any operation problem you may have could be caused by your computer, cable, software, or selected settings. Check the other solutions in this book or try uninstalling and reinstalling your printer software.
 - If the page prints but the nozzle check pattern has gaps, clean the print head.
 - If the page does not print, the product may have a problem. Check the other solutions in this manual. If they do not work, contact Epson.

Parent topic: [Solving Problems](#)

Related concepts

[Print Head Cleaning](#)

[Print Quality Adjustment](#)

[Uninstall Your Product Software](#)

Related references

[Where to Get Help](#)

Resetting Control Panel Defaults

If you have a problem with settings on the product control panel, you can reset them to their factory defaults. You can choose which settings to reset or reset them all.

Note: This setting can be locked by an administrator. If you cannot access or change this setting, contact your administrator for assistance.

1. Press the  home button, if necessary.
2. Select **Settings > General Settings**.
3. Scroll down and select **System Administration**. Enter the administrator password, if necessary.
4. Scroll down and select **Restore Default Settings**.

You see a screen like this:



5. Select one of these options:
 - **Network Settings:** Resets all network settings
 - **Copy Settings:** Resets all settings for copying
 - **Scan Settings:** Resets all settings for scanning
 - **Fax Settings:** Resets all settings for faxing
 - **Clear All Data and Settings:** Resets all control panel settings including the contacts list

You see a confirmation screen.

6. Select **Yes** to reset the selected settings. (Select **No** if you want to cancel the operation.)

Parent topic: [Solving Problems](#)

Solving Setup Problems

Check these sections if you have problems while setting up your product.

[Product Does Not Turn On or Off](#)

[Noise After Ink Installation](#)

[Software Installation Problems](#)

Parent topic: [Solving Problems](#)

Product Does Not Turn On or Off

If you cannot turn the product on or off, try these solutions:

- If you cannot turn on your product, make sure the power cord is securely connected and hold down the power button a little longer.

- If you cannot turn off your product, hold down the power button a little longer. If you still cannot turn off your product, unplug the power cord, plug the power cord back in, then turn your product on and off again using the power button.

Parent topic: [Solving Setup Problems](#)

Noise After Ink Installation

If you hear noises from your product after installing ink, check the following:

- The first time you install ink, the product must charge its print head. Wait until charging finishes before you turn off the product, or it may charge improperly and use excess ink the next time you turn it on.
- If the product's print head stops moving or making noise, and the charging process has not finished after approximately 5 minutes, turn off your product. Turn it back on and check to see if charging is still in progress. If it is still in progress, contact Epson for help.

Parent topic: [Solving Setup Problems](#)

Software Installation Problems

If you have problems while installing your product software, try these solutions:

- Make sure your product is turned on and any necessary cables are securely connected at both ends. If you still have problems installing software, disconnect the cable and carefully follow the instructions on the *Start Here* sheet. Also make sure your system meets the requirements for your operating system.
- Close any other programs, including screen savers and virus protection software, and install your product software again.
- In Windows, make sure your product is selected as the default printer and the correct port is shown in the printer properties.
- If you see any error message or your software does not install correctly in Windows, you may not have software installation privileges. Contact your system administrator.
- If you are printing over a network, make sure your product is set up properly on the network.

Parent topic: [Solving Setup Problems](#)

Related references

[Windows System Requirements](#)

[Mac System Requirements](#)

Solving Network Problems

Check these solutions if you have problems setting up or using your product on a network.

Note: Breakdown or repair of this product may cause loss of fax and network data and settings. Epson is not responsible for backing up or recovering data and settings during or after the warranty period. We recommend that you make your own backup or print out your fax and network data and settings.

[Product Cannot Connect to a Wireless Router or Access Point](#)

[Network Software Cannot Find Product on a Network](#)

[Product Does Not Appear in Mac Printer Window](#)

[Cannot Print Over a Network](#)

[Cannot Scan Over a Network](#)

Parent topic: [Solving Problems](#)

Product Cannot Connect to a Wireless Router or Access Point

If your product has trouble finding or connecting to a wireless router or access point, try these solutions:

- If you are connecting the product via Wi-Fi Protected Setup (WPS) and the Wi-Fi icon on your product's LCD screen is not lit or does not appear, make sure you select one of the WPS options from the product control panel within 2 minutes of pressing the WPS button on your router.
- Verify that your router or access point is operating correctly by connecting to it from your computer or another device.
- You may need to disable the firewall and any anti-virus software on your wireless router or access point.
- Try restarting your router following the instructions in your router documentation.

Note: If you are reading these instructions online, you will lose your Internet connection when you restart your router.

- Check to see if access restrictions, such as MAC address filtering, are set on the router or access point. If access restrictions are set, add your product's MAC address to your router's address list. To obtain your product's MAC address, print a network status sheet. Then follow the instructions in your router or access point documentation to add the address to the list.
- If your router or access point does not broadcast its network name (SSID), follow the instructions that came with your product to enter your wireless network name manually.
- If your router or access point has security enabled, determine the kind of security it is using and any required password or passphrase for connection. Then make sure to enter the exact WEP key or WPA passphrase correctly.

- Check if your computer is restricting the available wireless channels. If so, verify that your wireless access point is using one of the usable channels and change to a usable channel, if necessary.
- If you are using a Wi-Fi Direct connection that suddenly disconnects, the Wi-Fi Direct password on your device may have been changed. If necessary, delete the existing **DIRECT-xxxxxxxx** connection settings from your device and enter a new password. See your device documentation for instructions.
- If you connected your product to a Windows computer using Wi-Fi Direct and it automatically selected Access Point Mode, you may have trouble accessing a low-priority Internet connection. Check the network connection or adapter settings in the Windows Control Panel and set the **Internet metric** setting to **100** for your version of the Internet Protocol.

Parent topic: [Solving Network Problems](#)

Related concepts

[Wi-Fi Direct Mode Setup](#)

Related tasks

[Selecting Wireless Network Settings from the Control Panel](#)

[Printing a Network Status Sheet](#)

Related topics

[Wi-Fi or Wired Networking](#)

Network Software Cannot Find Product on a Network

If EpsonNet Setup cannot find your product on a network, try these solutions:

- Make sure your product is turned on and connected to your network. Verify the connection using your product control panel.
- Check if your network name (SSID) contains non-ASCII characters. Your product cannot display non-ASCII characters.
- Make sure your product is not connected to a guest network.
- If necessary, reinstall your product software and try running EpsonNet Setup again:
 1. Reset your product's network settings to their factory defaults.
 2. **Windows only:** Uninstall your product software.
 3. Restart your router following the instructions in your router documentation.

Note: If you are reading these instructions online, you will lose your Internet connection when you restart your router, so note the next step before restarting it.

4. Download your product software from the Epson website using the instructions on the *Start Here* sheet.
- If you have replaced your router, reinstall your product software to connect to the new router.

Note: If you are using a 5 GHz wireless router, set the router to operate in dual band (2.4 GHz and 5 GHz) mode. If your router uses a single network name (SSID) for both the 2.4 GHz and 5 GHz band, give each band its own network name (SSID) instead, such as Home Network 2.4 GHz and Home Network 5 GHz. See your router documentation or contact your internet service provider for instructions.

- Check to see if your wireless router or access point has an enabled Privacy Separator function that is preventing detection of your device over the network. See your router or access point documentation for instructions on disabling the Privacy Separator function.
- Try accessing any website from your computer or smart device to make sure that your device's network settings are correct. If you cannot access any website, there is a problem on the computer or smart device. Check the network connection of the computer or smart device. See the documentation provided with the computer or smart device for details.

Parent topic: [Solving Network Problems](#)

Related concepts

[Uninstall Your Product Software](#)

Related topics

[Wi-Fi or Wired Networking](#)

Product Does Not Appear in Mac Printer Window

If your product does not appear in the Mac printer window, try these solutions:

- Turn your product off, wait 30 seconds, then turn it back on again.
- If you are connecting the product via Wi-Fi Protected Setup (WPS) and the Wi-Fi icon on your product's LCD screen is not lit, make sure you select one of the WPS options from the product control panel within 2 minutes of pressing the WPS button on your router.
- If you are connecting the product wirelessly via EpsonNet Setup and you do not see the Wi-Fi antenna icon with connection bars on your LCD screen, make sure your product software was installed correctly. If necessary, reinstall your software.

Note: If you are using a 5 GHz wireless router, set the router to operate in dual band (2.4 GHz and 5 GHz) mode. If your router uses a single network name (SSID) for both the 2.4 GHz and 5 GHz band,

give each band its own network name (SSID) instead, such as Home Network 2.4 GHz and Home Network 5 GHz. See your router documentation or contact your internet service provider for instructions.

Parent topic: [Solving Network Problems](#)

Related concepts

[Uninstall Your Product Software](#)

Cannot Print Over a Network

If you cannot print over a network, try these solutions:

- Make sure that your product is turned on.
- Make sure you install your product's network software as described in your product documentation.
- Print a network status sheet and verify that the network settings are correct. If the network status is **Disconnected**, check any cable connections and turn your product off and then on again.
- If you are using TCP/IP, make sure the product's IP address is set correctly for your network. If your network does not assign IP addresses using DHCP, set the IP address manually.
- Make sure your computer and product are both using the same wireless network.
- If network printing is slow, print a network status sheet and check the signal strength. If it is poor, place your product closer to your router or access point. Avoid placing your product near a microwave oven, cordless phone, or large metal object, such as a filing cabinet.

Note: If you are using a 5 GHz wireless router, set the router to operate in dual band (2.4 GHz and 5 GHz) mode. If your router uses a single network name (SSID) for both the 2.4 GHz and 5 GHz band, give each band its own network name (SSID) instead, such as Home Network 2.4 GHz and Home Network 5 GHz. See your router documentation or contact your internet service provider for instructions.

- Try restarting your router following the instructions in your router documentation.

Note: If you are reading these instructions online, you will lose your Internet connection when you restart your router.

- Check if there are any paused print jobs.
- Make sure your printer is selected as the default printer.
- Check if the selected printer port is correct.

- Check to see if your wireless router or access point has an enabled Privacy Separator function that is preventing printing from a device over the network. See your router or access point documentation for instructions on disabling the Privacy Separator function.
- If you are connecting the product via Wi-Fi Protected Setup (WPS) and the Wi-Fi icon on your product's LCD screen is not lit, make sure you select one of the WPS options from the product control panel within 2 minutes of pressing the WPS button on your router.
- Check your wired LAN router or access point to see if the LED for the port to which your product is connected is on or flashing. If the link LED is off, try the following:
 - Make sure the Ethernet cable is securely connected to your product and to your router, access point, switch, or hub.
 - Try connecting your product to a different port or a different router, access point, switch, or hub.
 - Try connecting with a different Ethernet cable.
 - Try printing to your product from another computer on the network.

Note: If you are using a 5 GHz wireless router, set the router to operate in dual band (2.4 GHz and 5 GHz) mode. If your router uses a single network name (SSID) for both the 2.4 GHz and 5 GHz band, give each band its own network name (SSID) instead, such as Home Network 2.4 GHz and Home Network 5 GHz. See your router documentation or contact your internet service provider for instructions.

- If you are connecting the product via EpsonNet Setup and the Wi-Fi icon does not appear lit on the LCD screen, make sure your product software was installed correctly. If necessary, reinstall your software.

Parent topic: [Solving Network Problems](#)

Related concepts

[Uninstall Your Product Software](#)

Related tasks

[Printing a Network Status Sheet](#)

Related topics

[Wi-Fi or Wired Networking](#)

Cannot Scan Over a Network

If you have problems scanning over a network, try these solutions:

- If you cannot scan from your product control panel, make sure you restarted your computer after installing the product software. Make sure the Event Manager program is not being blocked by your firewall or security software.

Note: If you are using a 5 GHz wireless router, set the router to operate in dual band (2.4 GHz and 5 GHz) mode. If your router uses a single network name (SSID) for both the 2.4 GHz and 5 GHz band, give each band its own network name (SSID) instead, such as Home Network 2.4 GHz and Home Network 5 GHz. See your router documentation or contact your internet service provider for instructions.

- If you are scanning a large original at a high resolution, a network communication error may occur. Try scanning again at a lower resolution.
- If network communication was interrupted while starting Epson Scan 2, exit Epson Scan 2, wait a few seconds, and restart it. If Epson Scan 2 cannot restart, turn off your product, turn it back on, and try restarting Epson Scan 2 again.
- Check the scanner setting and reset the connection if necessary using Epson Scan 2 Utility:

Windows 11: Click , then search for **Epson Scan 2 Utility** and select it. Make sure your product is selected. If necessary, select the **Other** tab and click **Reset**.

Windows 10: Click  and select **EPSON > Epson Scan 2 Utility**. Make sure your product is selected. If necessary, select the **Other** tab and click **Reset**.

Windows 8.x: Navigate to the **Apps** screen, select **EPSON**, and select **Epson Scan 2 Utility**. Make sure your product is selected. If necessary, select the **Other** tab and click **Reset**.

Windows (other versions): Click  or **Start > All Programs** or **Programs > EPSON > Epson Scan 2 > Epson Scan 2 Utility**. Make sure your product is selected. If necessary, select the **Other** tab and click **Reset**.

Mac: Open the **Applications** folder, click **Epson Software**, and click **Epson Scan 2 Utility**. Make sure your product is selected. If necessary, select the **Other** tab and click **Reset**.

- You may need to disable the firewall and any anti-virus software on your wireless router or access point.

Parent topic: [Solving Network Problems](#)

Related tasks

[Entering a User ID and Password for Scanning](#)

[Starting a Scan Using the Epson Scan 2 Icon](#)

[Starting a Scan Using the Product Control Panel](#)

Solving Copying Problems

Check these solutions if you have problems copying with your product.

[Product Makes Noise, But Nothing Copies](#)

[Product Makes Noise When It Sits for a While](#)

[Originals Do Not Feed From the Automatic Document Feeder](#)

Parent topic: [Solving Problems](#)

Product Makes Noise, But Nothing Copies

If your product makes a noise, but nothing copies, try these solutions:

- Run a nozzle check to see if any of the print head nozzles are clogged. Then clean the print head, if necessary.
- If the nozzle check page does not print, but the product's power is on, make sure your product software is installed correctly.
- Make sure your product is level (not tilted).

Parent topic: [Solving Copying Problems](#)

Related concepts

[Print Head Cleaning](#)

[Print Head Nozzle Check](#)

Product Makes Noise When It Sits for a While

Your product is performing routine maintenance. This is normal.

Parent topic: [Solving Copying Problems](#)

Originals Do Not Feed From the Automatic Document Feeder

If your originals do not feed when placed in the ADF, try these solutions:

- Make sure the **ADF** icon lights up on the Copy, Fax, or Scan screen on the LCD screen. If not, reload the originals.

- Make sure the size, weight, and number of your originals are supported by the ADF.
- Make sure the originals are loaded correctly.
- Make sure the document is not curled or creased.
- Try cleaning the inside of the ADF.
- Do not load originals above the arrow mark on the ADF edge guide.

Parent topic: [Solving Copying Problems](#)

Related references

[Paper Feeding Problems](#)

[Paper Jams Inside the Product](#)

Related tasks

[Placing Originals in the Automatic Document Feeder](#)

[Cleaning Your Product](#)

Solving Paper Problems

Check these sections if you have problems using paper with your product.

[Paper Feeding Problems](#)

[Paper Jams Inside the Product](#)

[Paper Ejection Problems](#)

Parent topic: [Solving Problems](#)

Paper Feeding Problems

If you have problems feeding paper, try these solutions:

- If paper does not feed for printing, remove it from the rear feed slot or cassette. Reload it, then adjust the edge guides. Make sure the paper stack is not above the arrow mark on the edge guides inside the cassette or rear feed slot.
- Place the product on a flat surface and operate it in the recommended environmental conditions.
- Be sure to insert the paper cassette all the way into your product.
- If multiple pages feed at once, remove the paper, fan the edges to separate the sheets, and reload it.
- Do not load more than the recommended number of sheets. For plain paper, do not load paper above the arrow mark on the edge guides.
- Make sure your paper meets the specifications for your product.

- If paper jams when you print on both sides of the paper, try loading fewer sheets.
- Run the paper guide cleaning utility to clean the paper path.
- If paper does not feed correctly after replacing the maintenance rollers, make sure you installed the maintenance rollers correctly.
- If you installed an optional paper cassette unit, be sure to enable the cassette unit in the printing software.
- If your product pauses during printing, make sure the front cover is closed.
- The maintenance rollers may be at the end of their service life. Check the maintenance roller status and replace them if necessary.
- Do not use short-grain paper with a width less than .413 inches (105 mm).
- For best results, follow these guidelines:
 - Use new, smooth, high-quality paper that is not curled, creased, old, too thin, or too thick.
 - Load paper in the cassette printable side down.
 - Do not load binder paper with holes in the cassette.
 - Follow any special loading instructions that came with the paper.
 - Use long-grain paper. If you are not sure what type of paper you are using, check the paper packaging or contact the manufacturer to confirm the paper specifications.

Parent topic: [Solving Paper Problems](#)

Related references

[Paper Jams Inside the Product](#)

[Paper Loading Capacity](#)

[Paper Specifications](#)

Related tasks

[Cleaning the Paper Guide](#)

Related topics

[Loading Paper](#)

Paper Jams Inside the Product

If you see a message that paper has jammed in the product, follow the on-screen instructions to locate and remove the jammed paper.

Take the following precautions when removing jammed paper from the product:

- Remove the jammed paper carefully. Using too much force may damage the product.
- Unless specifically instructed, avoid tilting the product, placing it on its side, or turning it upside down, as ink may spill.

Warning: Never touch the buttons on the control panel while your hand is inside the product. If the product starts operating, it may cause an injury. Do not touch any protruding parts inside the product.

Parent topic: [Solving Paper Problems](#)

Related topics

[Loading Paper](#)

Paper Ejection Problems

If you have problems with paper ejecting properly, try these solutions:

- If paper does not eject fully, you may have set the wrong paper size. Cancel printing to eject the paper. Select the correct paper size when you reprint.
- If paper is wrinkled when it ejects, it may be damp or too thin. Load new paper and be sure to select the correct paper type setting when you reprint.

Parent topic: [Solving Paper Problems](#)

Related references

[Paper or Media Type Settings - Printing Software](#)

Related tasks

[Cancelling Printing Using a Product Button](#)

Related topics

[Loading Paper](#)

Solving Problems Printing from a Computer

Check these sections if you have problems while printing from your computer.

Note: For problems while printing with the Epson Universal Print Driver or PostScript (PS3) printer software, see the sections covering that software in this manual.

[Nothing Prints](#)

[Product Icon Does Not Appear in Windows Taskbar](#)

[Printing is Slow](#)

Parent topic: [Solving Problems](#)

Nothing Prints

If you have sent a print job and nothing prints, try these solutions:

- Make sure your product is turned on and connected to your computer.
- Make sure any interface cables are connected securely at both ends.
- If you connected your product to a USB hub, make sure it is a first-tier hub. If it still does not print, connect your product directly to your computer instead of the hub.
- Make sure the printer status is not offline or pending.
- Run a product check to see if a test page prints. If the test page prints, check to see if your product software is installed correctly.
- Make sure your system meets the requirements for your operating system. If you are printing a high-resolution image, you may need more than the minimum requirements. Print the image at a lower resolution or if necessary, increase your system's memory.
- In Windows, make sure your product is selected as the default printer and the printer port setting matches the printer connection port.
- In Windows, delete all jobs from the Windows Spooler. Click **Print Queue** on the Maintenance tab in the printer settings window, and cancel any stalled print jobs.
- On a Mac, make sure the printer is added to the printer list and the printer is not paused.
- Make sure your product is selected as the printer in your printing program.
- You can try to clear the problem by updating the product software to the latest version. If the problem persists, try uninstalling and reinstalling the printer driver.

Parent topic: [Solving Problems Printing from a Computer](#)

Related tasks





[Running a Product Check](#)

[Entering a User ID and Password for Printing](#)

[Using AirPrint](#)

Product Icon Does Not Appear in Windows Taskbar

If you do not see your product icon in the Windows taskbar, first try restarting your computer. If that does not work, try this solution:

1. Do one of the following:
 - **Windows 11:** Click , search for **Settings** and select it. Select **Bluetooth & devices > Printers & scanners**. Select your product name and select **Printing preferences**.
 - **Windows 10:** Click  and select  (Settings) > **Devices > Printers & scanners**. Select your product name and select **Manage > Printing preferences**.
 - **Windows 8.x:** Navigate to the **Apps** screen and select **Control Panel > Hardware and Sound > Devices and Printers**. Right-click your product name, select **Printing Preferences**, and select your product name again if necessary.
 - **Windows 7:** Click  and select **Devices and Printers**. Right-click your product name, select **Printing Preferences**, and select your product name again if necessary.
2. Click the **Maintenance** tab.
3. Click the **Extended Settings** button.
4. Select **Enable EPSON Status Monitor 3** and click **OK**.
5. Click the **Monitoring Preferences** button.
6. Click the checkbox for the option that adds the shortcut icon to the taskbar.
7. Click **OK** to close the open program windows.

Parent topic: [Solving Problems Printing from a Computer](#)

Printing is Slow

If printing becomes slow, try these solutions:

- Make sure your system meets the requirements for your operating system. If you are printing a high-resolution image, you may need more than the minimum requirements. If necessary, increase your system's memory.
- If you are using Windows 7, close the **Devices and Printers** window before you print.
- Make sure **Quiet Mode** is turned off.
- Clear space on your hard drive or run a defragmentation utility to free up existing space.
- Close any programs you are not using when you print.

- If your product is connected to a USB hub, connect it directly to your computer instead.
- If printing becomes slower after printing continuously for a long time, the product may have automatically slowed down to protect the print mechanism from overheating or becoming damaged. Let the product rest with the power on for 30 minutes, then try printing again.
- If you are printing over a wireless network, factors such as interference, network traffic, or weak signal strength may affect your printing speed.

Note: If you are using a 5 GHz wireless router, set the router to operate in dual band (2.4 GHz and 5 GHz) mode. If your router uses a single network name (SSID) for both the 2.4 GHz and 5 GHz band, give each band its own network name (SSID) instead, such as Home Network 2.4 GHz and Home Network 5 GHz. See your router documentation or contact your internet service provider for instructions.

- If using the PostScript printer driver, set the **Print Quality** setting to **Fast**.

For the fastest printing, select the following settings in your product software:

- Make sure the paper type setting matches the type of paper you loaded.
- Turn on any high speed settings in your product software.
- Select a lower print quality setting.
- Make sure the ink drying time has not been increased for double-sided printing.
- **Windows:** Click the **Maintenance** or **Utility** tab, select **Extended Settings** or **Speed and Progress**, and select the following settings:
 - **Always Spool RAW Datatype**
 - **Page Rendering Mode**
 - **Print as Bitmap**
- **Windows:** Select **Printing preferences**, click the **More Options** tab, and make sure the **Bidirectional printing** setting is enabled.
- **Mac:** Select **System Preferences** or **System Settings**, select **Printers & Scanners**, and select your product. Select **Options & Supplies**, select **Options** (or **Driver**), and enable the **Bidirectional printing** setting.

If printing is still slow and you are using Windows 7 or Windows Vista, try the following:

1. Click  and select **Computer** or **My Computer**. Double-click the **C:** drive and open these folders: **ProgramData > EPSON > PRINTER**.

Note: If you do not see the ProgramData folder, open the **Organize** menu and select **Folder and search options**. In the window that appears, click the **View** tab, select **Show hidden files, folders, and drives** in the Advanced settings list, and click **OK**.

2. Right-click the **EPAUDF01.AUD** file and select **Delete**.
3. Restart your computer and try printing again.

Parent topic: [Solving Problems Printing from a Computer](#)

Related references

[Windows System Requirements](#)

[Mac System Requirements](#)

[Paper or Media Type Settings - Printing Software](#)

Related tasks

[Selecting Basic Print Settings - Windows](#)

[Selecting Basic Print Settings - Mac](#)

[Selecting Extended Settings - Windows](#)

Solving Page Layout and Content Problems

Check these sections if you have problems with the layout or content of your printed pages.

[Inverted Image](#)

[Too Many Copies Print](#)

[Blank Pages Print](#)

[Incorrect Margins on Printout](#)

[Incorrect Characters Print](#)

[Incorrect Image Size or Position](#)

[Slanted Printout](#)

Parent topic: [Solving Problems](#)

Inverted Image

If your printed image is inverted unexpectedly, try these solutions:

- Turn off any mirror or inversion settings in your printing application.
- Turn off the **Mirror Image**, **Flip horizontally**, or **Reverse page orientation** settings in your printer software. (This option has different names, depending on your operating system version.)

Parent topic: [Solving Page Layout and Content Problems](#)

Related tasks

[Selecting Additional Layout and Print Options - Windows](#)

[Selecting Basic Print Settings - Mac](#)

Too Many Copies Print

Make sure that the **Copies** setting in your printing program or printer software is not set for multiple copies.

Parent topic: [Solving Page Layout and Content Problems](#)

Related tasks

[Selecting Basic Print Settings - Windows](#)

[Selecting Basic Print Settings - Mac](#)

Blank Pages Print

If blank pages print unexpectedly, try these solutions:

- Make sure you selected the correct paper size settings in your printing program and printer software.
- If a blank page exists in a document you are printing and you want to skip printing it, select the **Skip Blank Page** setting in your printer software, if available.
- Run a print head nozzle check to see if any of the nozzles are clogged. Then clean the print head, if necessary.
- Make sure your product is selected as the printer in your printing program.

Parent topic: [Solving Page Layout and Content Problems](#)

Related concepts

[Print Head Cleaning](#)

[Print Head Nozzle Check](#)

Related tasks

[Selecting Basic Print Settings - Windows](#)

[Selecting Basic Print Settings - Mac](#)

[Selecting Extended Settings - Windows](#)

[Selecting Printing Preferences - Mac](#)

Incorrect Margins on Printout

If your printed page has incorrect margins, try these solutions:

- Make sure you selected the correct paper size settings in your printing program and printer software.
- Make sure you selected the correct margins for your paper size in your printing program.
- Make sure your paper is positioned correctly for feeding into the product.
- When placing originals on the scanner glass, align the corner of the original with the corner indicated by the arrow. If the edges of the copy are cropped, move the original slightly away from the corner.
- Clean the scanner glass and the document cover. If there is dust or stains on the glass, the copy area may extend to include the dust or stains.

You can use the preview option in your printer software to check your margins before you print.

Parent topic: [Solving Page Layout and Content Problems](#)

Related tasks

[Selecting Basic Print Settings - Windows](#)

[Selecting Basic Print Settings - Mac](#)

Related topics

[Loading Paper](#)

Incorrect Characters Print

If incorrect characters appear in your prints, try these solutions before reprinting:

- Make sure any cables are securely connected at both ends.
- In Windows, delete all jobs from the Windows Spooler. Click **Print Queue** on the Maintenance tab in the printer settings window, and cancel any stalled print jobs.
- If your product is connected to a USB hub, connect it directly to your computer instead.
- If your computer entered sleep mode the last time you printed, the next print job after your computer exits sleep mode may contain garbled characters. Print your document again.

Parent topic: [Solving Page Layout and Content Problems](#)

Incorrect Image Size or Position

If your printed image is the wrong size or in the wrong position, try these solutions:

- Make sure you selected the correct paper size and layout settings in your printing program and printer software.

- Make sure you selected the correct paper size on the control panel.
- Make sure your paper is positioned correctly for feeding into the printer.
- Slide the edge guides against the edges of the paper.
- Clean the scanner glass and document cover.
- Make sure you selected the correct margins for your paper size in your printing program.
- Be sure to select the appropriate original size setting for your original in the copy settings.

You can use the preview option in your printer software to check your margins before you print.

Parent topic: [Solving Page Layout and Content Problems](#)

Related tasks

[Selecting Basic Print Settings - Windows](#)

[Selecting Basic Print Settings - Mac](#)

[Selecting Additional Layout and Print Options - Windows](#)

[Cleaning Your Product](#)

[Selecting Page Setup Settings - Mac](#)

Slanted Printout

If your printouts are slanted, try these solutions:

- Slide the edge guides against the edges of the paper.
- Select a higher print quality setting in your printer software.
- Turn off any high speed settings in your product software.
- Align the print head.
- Adjust the print quality.
- Make sure the product is not printing while tilted or at an angle.

Parent topic: [Solving Page Layout and Content Problems](#)

Related tasks

[Selecting Basic Print Settings - Windows](#)

[Selecting Basic Print Settings - Mac](#)

Related topics

[Loading Paper](#)

Solving Print Quality Problems

Check these sections if your printouts have problems with print quality, but your image looks fine on your computer screen.

[White or Dark Lines in Printout](#)

[Blurry or Smearred Printout](#)

[Faint Printout or Printout Has Gaps](#)

[Grainy Printout](#)

[Incorrect Colors](#)

Parent topic: [Solving Problems](#)

White or Dark Lines in Printout

If you notice white or dark lines in your prints (also called banding), try these solutions before you reprint:

- Run a nozzle check to see if any of the print head nozzles are clogged. Then clean the print head, if necessary.
- Make sure the paper type setting matches the type of paper you loaded.
- Make sure you loaded the printable side of the paper correctly for your product.
- Turn off any high speed settings in your product software.
- Align the print head. If print quality does not improve after aligning the print head, disable the bidirectional (high speed) setting.
- Adjust the print quality in the product software.
- If you continue to see horizontal bands or streaks in your printouts after cleaning the print head and adjusting the print quality, make print quality adjustments for each paper type.
- If you are copying from the ADF, copy from the scanner glass instead or use a higher quality setting.
- You may need to replace the ink cartridges.

Parent topic: [Solving Print Quality Problems](#)

Related concepts

[Print Quality Adjustment](#)

[Print Head Cleaning](#)

[Print Head Nozzle Check](#)

Related references

[Paper or Media Type Settings - Printing Software](#)

Related tasks

[Selecting Additional Layout and Print Options - Windows](#)

[Selecting Printing Preferences - Mac](#)

Related topics

[Loading Paper](#)

[Replacing Ink Cartridges, Maintenance Boxes, and Cassette Rollers](#)

Blurry or Smearred Printout

If your printouts are blurry or smearred, try these solutions:

- Make sure your paper is not damp, curled, old, or loaded incorrectly in your product.
- Slide the edge guides to the edges of the paper.
- Use a support sheet with special paper, or load special paper one sheet at a time.
- Make sure your paper meets the specifications for your product.
- Use Epson papers to ensure proper saturation and absorption of genuine Epson inks.
- Do not load more than the recommended number of sheets. For plain paper, do not load above the line indicated by the triangle symbol on the edge guide.
- Make sure the paper type setting in your product software matches the type of paper you loaded.
- Make sure you loaded the printable side of the paper correctly for your product.
- If you are printing on thick paper or envelopes, turn on the **Thick Paper** setting from the control panel or select **Thick Paper and Envelopes** in the Extended Settings of the printer software. (Turning this setting on will decrease print speed.)
- In Windows, if the paper is still smearred after selecting the **Thick Paper and Envelopes** setting, select the **Short Grain Paper** setting in the Extended Settings of the printer software.
- Remove each sheet from the output tray as it is printed.
- Avoid handling printouts on glossy paper right after printing to allow the ink to set.
- Turn off any high speed settings in your product software.
- If you print on both sides of a sheet of paper, smudges may appear on the reverse side of heavily saturated or dark images. If one side of a sheet will contain a lighter image or text, print that side first. Make sure the ink has dried before reloading the paper to print on the other side. Adjust the density and/or ink drying time settings.
- Run a nozzle check to see if any of the print head nozzles are clogged. Then clean the print head, if necessary.

- Align the print head. If print quality does not improve, disable the bidirectional setting.
- Adjust the print quality in the product software.
- Clean the paper path.
- Do not press too hard on the original or the document cover when you are scanning originals on the scanner glass.
- Clean the scanner glass.
- If you are copying from the ADF, place your originals on the scanner glass instead.
- Clean the ADF.

Note: Your product will not operate properly while tilted at an angle. Place it on a flat, stable surface that extends beyond the base of the product in all directions.

Parent topic: [Solving Print Quality Problems](#)

Related concepts

[Print Quality Adjustment](#)

[Print Head Cleaning](#)

Related references

[Paper Specifications](#)

[Compatible Epson Papers](#)

Related tasks

[Selecting Basic Print Settings - Windows](#)

[Selecting Double-sided Printing Settings - Windows](#)

[Selecting Additional Layout and Print Options - Windows](#)

Faint Printout or Printout Has Gaps

If your printouts are faint or have gaps, try these solutions:

- Run a nozzle check to see if any of the print head nozzles are clogged. Then clean the print head, if necessary.
- The ink cartridge(s) may be old or low on ink, and you may need to replace them.
- Make sure the paper type setting matches the type of paper you loaded.
- Make sure your paper is not damp, curled, old, or loaded incorrectly in your product.
- Align the print head.

- Adjust the print quality in the product software.

Parent topic: [Solving Print Quality Problems](#)

Related concepts

[Print Head Cleaning](#)

[Print Quality Adjustment](#)

[Print Head Nozzle Check](#)

Related references

[Paper or Media Type Settings - Printing Software](#)

Related tasks

[Selecting Basic Print Settings - Windows](#)

[Selecting Basic Print Settings - Mac](#)

[Cleaning the Paper Guide](#)

Related topics

[Loading Paper](#)

[Replacing Ink Cartridges, Maintenance Boxes, and Cassette Rollers](#)

Grainy Printout

If your printouts are grainy, try these solutions:

- Make sure you loaded the printable side of the paper correctly for your product.
- Select a higher print quality setting and turn off any high speed settings in your product software.
- Run a nozzle check to see if any of the print head nozzles are clogged. Then clean the print head, if necessary.
- Align the print head.
- Adjust the print quality in the product software.
- You may need to increase the image resolution or print a smaller size; see your software documentation.

Note: Images from the Internet may be low resolution and not result in a high quality printout.

- If you enlarged the image size in an image-editing program, you need to increase the image resolution setting to retain a high image quality. Increase the image resolution by the same amount you increase the image size. For example, if the image resolution is 300 dpi (dots per inch) and you will double the image size for printing, change the resolution setting to 600 dpi.

Note: Higher resolution settings result in larger file sizes, which take longer to process and print. Consider the limitations of your computer system when selecting a resolution, and select the lowest possible resolution that produces acceptable quality to keep file sizes manageable.

Parent topic: [Solving Print Quality Problems](#)

Related concepts

[Print Head Cleaning](#)

[Print Quality Adjustment](#)

[Print Head Nozzle Check](#)

[Print Head Alignment](#)

Related tasks

[Selecting Basic Print Settings - Mac](#)

[Selecting Basic Print Settings - Windows](#)

[Selecting Additional Layout and Print Options - Windows](#)

[Selecting Printing Preferences - Mac](#)

Related topics

[Loading Paper](#)

Incorrect Colors

If your printouts have incorrect colors, try these solutions:

- Make sure the paper type setting matches the paper you loaded.
- Make sure the **Black/Grayscale** or **Grayscale** setting is not selected in your printer software.
- Run a nozzle check to see if any of the print head nozzles are clogged. Then clean the print head, if necessary.
- The ink cartridges may be old or low on ink, and you may need to replace them.
- After you print, the colors in your printout need time to set as the ink dries. During this time, the colors may look different than you expect. To speed up drying time, do not stack your printouts on top of each other.
- Your printed colors can never exactly match your on-screen colors. However, you can use a color management system to get as close as possible. Try using the color management options in your printer software.
- Select **Custom** as the **Color Correction** setting on the More Options tab of the printer software, then click **Advanced**. Try changing the **Scene Correction** setting to something other than **Automatic**. If

changing that setting does not work, change the **Color Management** setting to any color correction method other than **PhotoEnhance**.

- If you are using the Windows PostScript printer software, try adjusting the **Color Mode** setting on the Advanced tab of the printer software.
- For best results, use genuine Epson paper.
- Remove any dust or dirt on the originals and clean the scanner glass.
- Do not press with too much force on the original or the document cover.

Parent topic: [Solving Print Quality Problems](#)

Related concepts

[Print Head Nozzle Check](#)

[Print Head Cleaning](#)

Related references

[Compatible Epson Papers](#)

Related tasks

[Selecting Basic Print Settings - Windows](#)

[Selecting Basic Print Settings - Mac](#)

[Selecting Additional Layout and Print Options - Windows](#)

[Managing Color - Mac](#)

Solving Scanning Problems

Check these solutions if you have problems scanning with your product.

[Scanning Software Does Not Operate Correctly](#)

[Cannot Start Epson Scan 2](#)

Parent topic: [Solving Problems](#)

Scanning Software Does Not Operate Correctly

If your scanning software does not operate correctly, try these solutions:

- Make sure your computer has adequate memory and meets the system requirements for your operating system.
- Make sure your computer is not running in a power-saving mode, such as sleep or standby. If so, wake your system and restart your scanning software.

- If you upgraded your operating system but did not reinstall your scanning software, try reinstalling it.
- In Windows, make sure your product is listed as a valid device in the **Scanners and Cameras** control panel.
- Try scanning at a lower resolution or increase the free space on the computer's hard disk. Scanning stops if the total data size reaches the limit.

Parent topic: [Solving Scanning Problems](#)

Related concepts

[Uninstall Your Product Software](#)

Related tasks

[Uninstalling Product Software - Windows](#)

[Uninstalling Product Software - Mac](#)

Cannot Start Epson Scan 2

If you cannot start Epson Scan 2, try these solutions:

- Make sure your product is turned on and any interface cables are securely connected at both ends.
- If your product is connected to a USB hub, connect it directly to your computer instead.
- If you scan at a high resolution over a network, a communication error may occur. Lower the resolution.
- If you are scanning with the ADF, check that the document cover and ADF cover are closed.
- Make sure Epson Scan 2 is selected as your scanning program.
- Make sure your computer is not running in a power-saving mode, such as sleep or standby. If so, wake your system and restart Epson Scan 2.
- Check the connection setting and test the connection using Epson Scan 2 Utility:

Windows 11: Click , search for **Epson Scan 2 Utility** and select it. Make sure the correct product is selected. If necessary, select the **Other** tab and click **Reset**.

Windows 10: Click  and select **EPSON > Epson Scan 2 Utility**. Make sure the correct product is selected. If necessary, select the **Other** tab and click **Reset**.

Windows 8.x: Navigate to the **Apps** screen and select **Epson Scan 2 Utility**. Make sure the correct product is selected. If necessary, select the **Other** tab and click **Reset**.

Windows (other versions): Click  or **Start > All Programs** or **Programs > EPSON > Epson Scan 2 > Epson Scan 2 Utility**. Make sure the correct product is selected. If necessary, select the **Other** tab and click **Reset**.

Mac: Open the **Applications** folder, click **Epson Software**, and click **Epson Scan 2 Utility**. Make sure the correct product is selected. If necessary, select the **Other** tab and click **Reset**.

- Make sure you do not have multiple versions of Epson Scan 2 installed. If you do, uninstall both versions and install one version.
- If you upgraded your operating system but did not reinstall Epson Scan 2, try reinstalling it.
- If the user restriction feature (Access Control) is enabled, a user ID and password are required to scan. If you do not know the user ID or password, contact your administrator for assistance.

Parent topic: [Solving Scanning Problems](#)

Related tasks

[Entering a User ID and Password for Scanning](#)

[Starting a Scan Using the Epson Scan 2 Icon](#)

Solving Scanned Image Quality Problems

Check these sections if a scanned image on your computer screen has a quality problem.

Note: For solutions when using Document Capture Pro (Windows) or Document Capture (Mac) software, see the Document Capture Pro (Windows) or Document Capture (Mac) help utility.

[Image Consists of a Few Dots Only](#)

[Line of Dots Appears in All Scanned Images](#)

[Straight Lines in an Image Appear Crooked](#)

[Image is Distorted or Blurry](#)

[Image Colors are Patchy at the Edges](#)

[Image is Too Dark](#)

[Back of Original Image Appears in Scanned Image](#)

[Ripple Patterns Appear in an Image](#)

[Scanned Image Colors Do Not Match Original Colors](#)

[Scanned Image Edges are Cropped](#)

Parent topic: [Solving Problems](#)

Image Consists of a Few Dots Only

If your scanned image consists only of a few dots, try these solutions:

- Make sure you placed your original for scanning facing the correct way.
- If the **Image Type** setting is **Black & White**, adjust the **Threshold** and scan again.
- Remove any lint or dirt from your original.
- Clean the scanner glass.
- Do not press on the original or the document cover with too much force.

Parent topic: [Solving Scanned Image Quality Problems](#)

Related references

[Additional Scanning Settings - Advanced Settings Tab](#)

Related topics

[Placing Originals on the Product](#)

Line of Dots Appears in All Scanned Images

If a line of dots appears in all your scanned images, try these solutions:

- Clean the scanner glass with a soft, dry, lint-free cloth or use a small amount of glass cleaner on the cloth, if necessary. Paper towels are not recommended.

Caution: Do not spray glass cleaner directly on the scanner glass.

- Make sure any interface cables are securely connected at both ends.
- Remove any dust or dirt that may have adhered to your original.
- Do not press with too much force on the original or the document cover.
- Keep the document cover closed to prevent dirt or dust from getting inside.

If you are scanning from the ADF, make sure the ADF edge guides fit against the loaded originals. You can also try cleaning the ADF and scanning again.

Parent topic: [Solving Scanned Image Quality Problems](#)

Related tasks

[Cleaning Your Product](#)

Straight Lines in an Image Appear Crooked

If straight lines in an original appear crooked in a scanned image, make sure to place your original straight when you scan it.

If you are scanning from the ADF, make sure the ADF edge guides fit against the loaded originals. You can also try cleaning the ADF and scanning again.

Parent topic: [Solving Scanned Image Quality Problems](#)

Related topics

[Placing Originals on the Product](#)

Image is Distorted or Blurry

If a scanned image appears distorted or blurry, try these solutions:

- Make sure your original is not wrinkled or warped. This may prevent the original from laying flat on the scanner glass.
- Do not move your original or your product during scanning.
- Your product will not operate properly while tilted at an angle. Place your product on a flat, stable surface that extends beyond its base in all directions.
- Adjust these Epson Scan 2 settings (if available) and try scanning again:
 - Increase the **Resolution** setting.
 - If the **Image Type** setting is **Black & White**, adjust the **Threshold** setting.
 - If the **Image Type** setting is **Color** or **Grayscale**, select the **Unsharp Mask** setting.
 - If the **Image Type** setting is **Black & White**, select **Text Enhancement**. If the **Image Type** setting is **Color** or **Grayscale**, change the **Text Enhancement** setting to **High**.

Parent topic: [Solving Scanned Image Quality Problems](#)

Related references

[Additional Scanning Settings - Advanced Settings Tab](#)

Image Colors are Patchy at the Edges

If you are scanning a thick or warped original, cover its edges with paper to block external light as you scan it.

Parent topic: [Solving Scanned Image Quality Problems](#)

Image is Too Dark

If your scanned image is too dark, try these solutions:

- If the **Image Type** is set to **Color** or **Grayscale**, adjust the **Brightness** setting.
- Check the brightness and contrast settings of your computer monitor.

Parent topic: [Solving Scanned Image Quality Problems](#)

Related references

[Additional Scanning Settings - Advanced Settings Tab](#)

Back of Original Image Appears in Scanned Image

If an image from the back of a thin original appears in your scanned image, try these solutions:

- Place a piece of black paper on the back of the original and scan it again.
- Adjust these Epson Scan 2 settings (if available) and try scanning again:
 - Select the **Advanced Settings** tab and adjust the **Brightness** setting.
 - If the **Image Type** is set to **Black & White**, select **Text Enhancement**. If the **Image Type** is set to **Color** or **Grayscale**, change the **Text Enhancement** setting to **High**.

Parent topic: [Solving Scanned Image Quality Problems](#)

Related references

[Additional Scanning Settings - Advanced Settings Tab](#)

Ripple Patterns Appear in an Image

You may see a ripple pattern (called a moiré) in scanned images of printed documents. This is caused by interference from differing pitches in the scanner's screen and your original's halftone screen. To reduce this effect, adjust these Epson Scan 2 settings (if available) and try scanning again:

- Select the **Descreening** setting.
- Select a lower **Resolution** setting.

Parent topic: [Solving Scanned Image Quality Problems](#)

Related references

[Additional Scanning Settings - Main Settings Tab](#)

Scanned Image Colors Do Not Match Original Colors

Printed colors can never exactly match the colors on your computer monitor because printers and monitors use different color systems: monitors use RGB (red, green, and blue) and printers typically use CMYK (cyan, magenta, yellow, and black).

Check the color matching and color management capabilities of your computer, display adapter, and the software you are using to see if they are affecting the palette of colors you see on your screen.

To adjust the colors in your scanned image, adjust these Epson Scan 2 settings (if available) and try scanning again:

- If the **Image Type** setting is **Color** or **Grayscale**, adjust the **Contrast** setting.
- If the **Image Type** setting is **Black & White** or **Grayscale**, adjust the **Color Enhance** setting.

Parent topic: [Solving Scanned Image Quality Problems](#)

Related references

[Additional Scanning Settings - Main Settings Tab](#)

Scanned Image Edges are Cropped

If the edges of a scanned image are cropped, make sure your original is placed correctly for scanning. If necessary, move your original away from the edges of the scanner glass slightly.

Parent topic: [Solving Scanned Image Quality Problems](#)

Related topics

[Placing Originals on the Product](#)

Solving Faxing Problems

Check these solutions if you have problems faxing with your product.

[Cannot Send or Receive Faxes](#)

[Cannot Receive Faxes with a Telephone Connected to Your Product](#)

[Fax Memory Full Error Appears](#)

[Sent Fax is Received in an Incorrect Size](#)

[Received Fax is Not Printed](#)

Parent topic: [Solving Problems](#)

Cannot Send or Receive Faxes

If you cannot send or receive faxes, try these solutions:

- If an error code is displayed on the control panel, try the solutions suggested in the error code list.
- If you are faxing from a computer, use the Epson FAX Utility to send your fax.
- Make sure the recipient's fax machine is turned on and working.
- Make sure paper is loaded correctly in your product.
- Make sure you have set up your header information and have not blocked your caller ID. Otherwise, your faxes might be rejected by the recipient's fax machine.
- If you did not connect a telephone to your product, set the Receive Mode setting to **Auto** so you can receive faxes automatically.
- Check that the cable connecting your telephone wall jack to your product's **LINE** port is secure.
- Print a fax connection report using your product control panel or fax software to help diagnose the problem.
- Verify that the telephone wall jack works by connecting a phone to it and testing it.
- If there is no dial tone and you connected the product to a PBX (Private Branch Exchange) phone line or Terminal Adapter, change the **Line Type** setting to **PBX**. If you still cannot send a fax, turn off the product's dial tone detection setting. (Turning off the dial tone setting may cause the product to drop the first digit of a fax number.)
- If you connected your product to a DSL phone line, you must connect a DSL filter to the phone jack to enable faxing over the line. Contact your DSL provider for the necessary filter.
- If your telephone line has static, turn off your product's error correction mode fax communication setting and try faxing again.
- Try lowering your product's fax speed setting.
- Make sure the error correction mode (ECM) setting is turned on if you are trying to send or receive a color fax.
- If your telephone line uses call waiting and you have trouble receiving faxes, turn off call waiting to prevent disruption of incoming faxes.
- If you have subscribed to a call forwarding service, the product may not be able to receive faxes. Contact your service provider for assistance.
- Check your inbox and delete faxes after reading or printing them. If the inbox is full, the product cannot receive faxes.

- When you have made settings to save received faxes to a computer, turn on the computer. The received fax is deleted once it has been saved to the computer.
- When sending faxes using the subaddress feature, ask the recipient if their fax machine can receive faxes using this feature. Check that the subaddress and password are correct, and that they match with the recipient subaddress and password. Check this when receiving faxes as well.
- When receiving faxes using the subaddress feature, make sure the fax rejection settings are not rejecting the fax.
- If you cannot receive A3-size faxes, make sure you selected the correct paper size setting for the paper source containing the A3-size paper. Also, be sure to enable the paper source to receive faxes as the **Auto Select Settings** option.
- If you are receiving faxes using the Epson FAX Utility, check that your product is registered as a fax product in your operating system:

Windows: Make sure the product appears in **Devices and Printers**, **Printer**, or **Printers and Other Hardware**. If the product does not appear, uninstall and re-install the Epson FAX Utility.

Mac: Select **System Preferences** or **System Settings** > **Printers & Scanners** (or **Print & Scan** or **Print & Fax**) and make sure your product appears. If your product does not appear, click **+** and add your product. If the product does appear, double-click it and make sure it is not paused.

Note: If your product is connected to a VoIP (Voice over Internet Protocol) phone line, keep in mind that fax machines are designed to work over analog phone lines. Epson cannot guarantee that fax transmission will work when using VoIP.

If your phone line includes voice mail answering services, calls or faxes may be inadvertently received by your voice mail service.

Parent topic: [Solving Faxing Problems](#)

Related references

[Job Status Error Codes](#)

Related tasks

[Selecting the Line Type](#)

[Printing Fax Reports](#)

[Receiving Faxes Automatically](#)

[Connecting a Telephone or Answering Machine](#)

[Selecting Advanced Fax Settings](#)

[Saving and Viewing Received Faxes](#)

[Setting Up the Fax Utility - Windows](#)

Related topics

[Loading Paper](#)

Cannot Receive Faxes with a Telephone Connected to Your Product

If you cannot receive faxes when a telephone is connected to your product, try these solutions:

- Make sure your telephone is connected to your product's **EXT** port.
- Make sure the Receive Mode is set to **Manual**.

Note: When answering a call that is a fax, wait until the product's LCD screen displays a message that a connection has been made before you hang up.

Parent topic: [Solving Faxing Problems](#)

Fax Memory Full Error Appears

If you see an error message telling you that the product's fax memory is full, try these solutions:

- If you set the product to save received faxes in the product's memory or inbox, delete any faxes you have already read.

Note: Your product can store up to 200 faxes before its inbox is full.

- If you set the product to save received faxes on a computer, turn on the selected computer. Once the faxes are saved on the computer, they are deleted from the product's memory.
- If you set the product to save received faxes on a USB device, connect the selected USB device containing the save fax folder to the product. Once the faxes are saved on the USB device, they are deleted from the product's memory.

Note: Make sure the USB device has enough available memory and is not write protected.

- If the memory is full, try the following:
 - Send a monochrome fax using the direct sending feature
 - Send your fax using the on hook feature
 - Send your faxes in smaller batches

- If the product cannot print a received fax due to a product error, such as a paper jam, the memory full error may appear. Clear any product errors, then ask the sender to resend the fax.

Parent topic: [Solving Faxing Problems](#)

Related references

[Fax Sending Options](#)

Related tasks

[Saving and Viewing Received Faxes](#)

Sent Fax is Received in an Incorrect Size

If your recipient receives a fax in an incorrect size, try these solutions:

- If you are trying to fax an A3-size document, make sure the recipient's fax machine supports the paper size. If the message **OK (Reduced Size)** appears in the fax transmission report, the recipient's fax machine does not support A3-size documents.
- If you are sending a fax using the scanner glass, make sure your original is placed correctly and that the correct paper size is selected on the control panel.
- Clean the scanner glass and document cover.

Parent topic: [Solving Faxing Problems](#)

Related tasks

[Cleaning Your Product](#)

[Placing Originals on the Scanner Glass](#)

Received Fax is Not Printed

If a received fax is not printed, try these solutions:

- Make sure the product is free of errors. The product cannot print received faxes if an error has occurred with the product, such as a paper jam.
- If the product has been set to save received faxes in the product's memory or inbox, received faxes are not automatically printed. Check the **Receive Settings** options on the product control panel and change them, if necessary.

Parent topic: [Solving Faxing Problems](#)

Related references

[Receive Settings - Fax](#)

Solving USB Device Problems

Check these solutions if you have problems using USB devices with your product.

[Cannot View or Print from a USB Device](#)

[Cannot Save Files on a USB Device](#)

[Cannot Transfer Files To or From a USB Device](#)

Parent topic: [Solving Problems](#)

Cannot View or Print from a USB Device

If you cannot view or print photos or documents from a USB device connected to your product, try these solutions:

- Make sure memory devices are enabled on the product.
- Make sure your device is compatible with the product.
- Make sure the files on your device are in the correct format.

Parent topic: [Solving USB Device Problems](#)

Related references

[External USB Device Specifications](#)

[Interface Specifications](#)

Related topics

[Transferring Files on a USB Device](#)

[Viewing and Printing from the LCD Screen](#)

Cannot Save Files on a USB Device

If you cannot save files on a USB device connected to your product, try these solutions:

- To save faxes on a USB device, create a folder in the **Fax Output** settings on the product control panel.
- Make sure the device is not write-protected.
- Make sure the device has enough available space.
- Make sure memory devices are enabled on your product.
- Make sure the device is compatible with the product.

Parent topic: [Solving USB Device Problems](#)

Related references

[Interface Specifications](#)
[Receive Settings - Fax](#)

Related topics

[Transferring Files on a USB Device](#)

Cannot Transfer Files To or From a USB Device

If you have problems transferring files to or from a USB device connected to your product, try these solutions:

- Make sure your device is compatible with the product.
- Make sure the device is not write-protected.
- Make sure your product is securely connected to your computer.
- Make sure that the file sharing setting for your product is enabled.

Parent topic: [Solving USB Device Problems](#)

Related references

[Interface Specifications](#)

Related topics

[Transferring Files on a USB Device](#)

Uninstall Your Product Software

If you have a problem that requires you to uninstall and re-install your software, follow the instructions for your operating system.

[Uninstalling Product Software - Windows](#)

[Uninstalling Product Software - Mac](#)



Parent topic: [Solving Problems](#)

Uninstalling Product Software - Windows

You can uninstall and then re-install your product software to solve certain problems.

1. Turn off the product.
2. Close any open programs or applications.
3. Disconnect any interface cables.

4. Do one of the following:

- **Windows 11:** Click , then search for **Settings** and select it. Select **Apps** or **System > Apps & features**. Then select the program you want to uninstall and select **Uninstall**.
- **Windows 10:** Click  and select  (Settings) > **Apps** or **System > Apps & features**. Then select the program you want to uninstall and select **Uninstall**.
- **Windows 8.x:** Navigate to the **Apps** screen and select **Control Panel > Programs > Programs and Features**. Select the uninstall option for your Epson product, then select **Uninstall/Change**.

Note: If you see a **User Account Control** window, click **Yes** or **Continue**.

Select your product again, if necessary, then select **OK**, and click **Yes** to confirm the uninstallation.

- **Windows (other versions):** Click  or **Start**, and select **All Programs** or **Programs**. Select **EPSON**, select your product, then click **EPSON Printer Software Uninstall**.

Note: If you see a **User Account Control** window, click **Yes** or **Continue**.

In the next window, select your product and click **OK**. Then follow any on-screen instructions.

5. Do one of the following to uninstall Epson Scan 2, then follow any on-screen instructions:

- **Windows 11/Windows 10:** Select **Epson Scan 2** and click **Uninstall**.
- **Windows 8.x/Windows 7/Windows Vista:** Select **Epson Scan 2** and click **Uninstall/Change**.
- **Windows 8.x/Windows 7:** Select **Epson Scan 2** and click **Uninstall/Change**.

6. Do one of the following to uninstall Epson ScanSmart, then follow any on-screen instructions:

- **Windows 11/Windows 10:** Select **Epson ScanSmart** and click **Uninstall**.
- **Windows 8.x/Windows 7:** Select **Epson ScanSmart** and click **Uninstall/Change**.

7. Restart your computer, then re-install your software.

Note: If you find that re-installing your product software does not solve a problem, contact Epson.

Parent topic: [Uninstall Your Product Software](#)

Uninstalling Product Software - Mac

In most cases, you do not need to uninstall your product software before re-installing it. However, you can download the Uninstaller utility from the Epson support website to uninstall your product software as described here.

Note: If you find that re-installing your product software does not solve a problem, contact Epson.

1. To download the Uninstaller utility, visit epson.com/support (U.S.) or epson.ca/support (Canada) and select your product.
2. Click **Downloads**.
3. Select your operating system, click **Utilities**, locate the Uninstaller utility, and click **Download**.
4. Run the file you downloaded.
5. Double-click the **Uninstaller** icon.
6. In the Epson Uninstaller screen, select the checkbox for each software program you want to uninstall.
7. Click **Uninstall**.
8. Follow the on-screen instructions to uninstall the software.
9. Reinstall your product software.

Note: If you uninstall the printer driver and your product name remains in the **Print & Fax**, **Print & Scan**, or **Printers & Scanners** window, select your product name and click the – (remove) icon to remove it.

Parent topic: [Uninstall Your Product Software](#)

Where to Get Help

If you need to contact Epson for technical support services, use the following support options.

Internet Support

Visit Epson's support website at epson.com/support (U.S.) or epson.ca/support (Canada) and select your product for solutions to common problems. You can download drivers and documentation, get FAQs and troubleshooting advice, or e-mail Epson with your questions.

Speak to a Support Representative

Before you call Epson for support, please have the following information ready:

- Product name
- Product serial number (located on a label on the product)
- Proof of purchase (such as a store receipt) and date of purchase
- Computer configuration
- Description of the problem

Then call:

- U.S.: (562) 276-4382, 7 a.m. to 4 p.m., Pacific Time, Monday through Friday
- Canada: (905) 709-3839, 7 a.m. to 4 p.m., Pacific Time, Monday through Friday

Days and hours of support are subject to change without notice. Toll or long distance charges may apply.

Purchase Supplies and Accessories

You can purchase genuine Epson ink and paper at epson.com (U.S. sales) or epson.ca (Canadian sales). You can also purchase supplies from an Epson authorized reseller. To find the nearest one, call 800-GO-EPSON (800-463-7766) in the U.S. or 800-807-7766 in Canada.

Parent topic: [Solving Problems](#)

Technical Specifications

These sections list the technical specifications for your product.

Note: Epson offers a recycling program for end of life Epson products. Please go to [this site](#) (U.S.) or [this site](#) (Canada) for information on how to return your Epson products for proper disposal.

[Windows System Requirements](#)

[Mac System Requirements](#)

[Paper Specifications](#)

[Printable Area Specifications](#)

[Automatic Document Feeder \(ADF\) Specifications](#)

[Scanning Specifications](#)

[Fax Specifications](#)

[Ink Cartridge Specifications](#)

[Dimension Specifications](#)

[Electrical Specifications](#)

[Environmental Specifications](#)

[Interface Specifications](#)

[External USB Device Specifications](#)

[Network Interface Specifications](#)

[Safety and Approvals Specifications](#)

[PostScript Fonts](#)

[PCL Fonts](#)

[PCL Mode 5 Symbol Sets](#)

Windows System Requirements

To use your product and its software, your computer should use one of these Microsoft operating systems:

- Windows 11
- Windows 10
- Windows 8.x
- Windows 7

- Windows Server 2022
- Windows Server 2019
- Windows Server 2016
- Windows Server 2012 R2
- Windows Server 2012
- Windows Server 2008 R2
- Windows Server 2008

Note: For the latest product software available for your operating system, visit the Epson support site at [epson.com/support](https://www.epson.com/support) (U.S.) or [epson.ca/support](https://www.epson.ca/support) (Canada), select your product, and select **Downloads**.

Parent topic: [Technical Specifications](#)

Mac System Requirements

To use your product and its software, your Mac should use one of these operating systems:

- macOS 14.x
- macOS 13.x
- macOS 12.x
- macOS 11.x
- macOS 10.15.x
- macOS 10.14.x
- macOS 10.13.x
- macOS 10.12.x
- OS X 10.11.x
- OS X 10.10.x
- OS X 10.9.5.x

Note: For the latest product software available for your operating system, visit the Epson support site at [epson.com/support](https://www.epson.com/support) (U.S.) or [epson.ca/support](https://www.epson.ca/support) (Canada), select your product, and select **Downloads**.

Parent topic: [Technical Specifications](#)

Paper Specifications

Note: Since the quality of any particular brand or type of paper may be changed by the manufacturer at any time, Epson cannot guarantee the quality of any non-Epson brand or type of paper. Always test a sample of paper stock before purchasing large quantities or printing large jobs.

Single-sheets

Size	A6 (4.1 × 5.8 inches [105 × 148 mm]) A5 (5.8 × 8.2 inches [148 × 210 mm]) A4 (8.3 × 11.7 inches [210 × 297 mm]) A3 (11.7 × 16.5 inches [297 × 420 mm]) 13 × 19 inches (330 × 483 mm) B6 (5 × 7.2 inches [128 × 182 mm]) B5 (7.2 × 10.1 inches [182 × 257 mm]) B4 (13.9 × 9.84 inches [353 × 250 mm]) Half Letter (5.5 × 8.5 inches [140 × 216 mm]) Executive (7.25 × 10.5 inches [184 × 267 mm]) Oficio 9 (8.46 × 12.4 inches [215 × 315 mm]) Letter (8.5 × 11 inches [216 × 279 mm]) 8.5 × 13 inches (216 × 330 mm) Mexico-Oficio (8.5 × 13.4 inches [216 × 340 mm]) Legal (8.5 × 14 inches [216 × 356 mm]) 11 × 17 inches (279 × 432 mm)
Paper types	Plain paper and paper distributed by Epson
Weight	Plain paper: 17 lb (64 g/m ²) to 24 lb (90 g/m ²) Thick paper: 25 lb (91 g/m ²) to 68 lb (256 g/m ²)

Envelopes

Size	No. 10 (4.1 × 9.5 inches [105 × 241 mm]) DL (8.66 × 4.33 inches [110 × 220 mm]) C6 (4.5 × 6.4 inches [114 × 162 mm])
Paper types	Plain bond paper
Weight	20 lb (75 g/m ²) to 27 lb (100 g/m ²)

Parent topic: [Technical Specifications](#)

Related references
[Paper Loading Capacity](#)

Printable Area Specifications

Single sheets

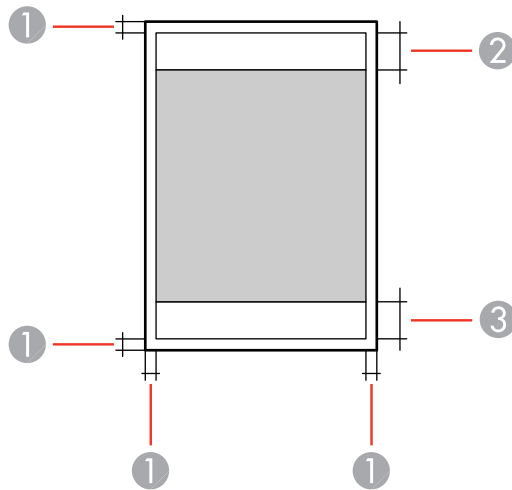

- 1 Top/bottom/right/left: 0.12 inch (3 mm) minimum
- 2 Reduced print quality area/top: 1.81 inches (46 mm) minimum
- 3 Reduced print quality area/bottom: 2.00 inches (51 mm) minimum

Envelopes

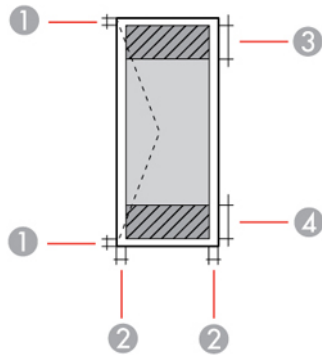

- 1 Left/right: 0.12 inch (3 mm) minimum
Top/bottom margins: 0.12 inch (3 mm) minimum
- 3 Reduced print quality area/left: 0.71 inches (18 mm) minimum
- 4 Reduced print quality area/right: 1.81 inches (46 mm) minimum

Parent topic: [Technical Specifications](#)

Automatic Document Feeder (ADF) Specifications

Paper size	A6 (4.1 × 5.8 inches [105 × 148 mm]) landscape size ¹ A5 (5.8 × 8.2 inches [148 × 210 mm]) landscape size A4 (8.3 × 11.7 inches [210 × 297 mm]) A3 (11.7 × 16.5 inches [297 × 420 mm]) B5 (7.2 × 10.1 inches [182 × 257 mm]) B4 (13.9 × 9.84 inches [353 × 250 mm]) Executive (7.25 × 10.5 inches [184 × 267 mm]) Letter (8.5 × 11 inches [216 × 279 mm]) 8.5 × 13 inches (216 × 330 mm) Legal (8.5 × 14 inches [216 × 356 mm]) (Maximum size 11 × 17 inches (279 × 432 mm))
Paper type	Plain paper, high-quality paper, or recycled paper
Paper weight	14 lb (52 g/m ²) to 34 lb (128 g/m ²)
Sheet feeding capacity	Total thickness: 0.20 inch (5.0 mm) Approximately 50 sheets

¹Single-sided scanning only

Parent topic: [Technical Specifications](#)

Scanning Specifications

Scanner type	Flatbed
Photoelectric device	CIS
Effective pixels	14040 × 20400 pixels (1200 dpi)
Document size	Maximum: 11.7 × 17 inches (297 × 431.8 mm) Scanner glass: A3 or Legal

Scanning resolution	1200 dpi (main scan) 2400 dpi (sub scan)
Output resolution	50 to 9600 in 1 dpi increments
Image data	Color: 30 bits per pixel (10 bits per pixel per color) internal 24 bits per pixel (8 bits per pixel per color) external Grayscale: 10 bits per pixel internal 8 bits per pixel external
Light source	LED

Parent topic: [Technical Specifications](#)

Fax Specifications

Fax type	Walk-up black-and-white and color fax capability (ITU-T Super Group 3)
Support lines	Standard analog phone lines PBX (Private Branch Exchange) telephone systems
Speed	Up to 33.6 kbps
Resolution	Monochrome Standard: 203 pixels per inch × 98 lines per inch (8 pixels per mm × 3.85 lines per mm) Fine: 203 pixels per inch × 196 lines per inch (8 pixels per mm × 7.7 lines per mm) Super Fine: 203 pixels per inch × 392 lines per inch (8 pixels per mm × 15.4 lines per mm) Ultra Fine: 406 pixels per inch × 392 lines per inch (16 pixels per mm × 15.4 lines per mm) Color 200 × 200 dpi

Compression method	Monochrome MH/MR/MMR Color JPEG
Communication standards	G3 SuperG3
Sending paper size	Scanner A5 (5.8 × 8.2 inches [148 × 210 mm]) A4 (8.3 × 11.7 inches [210 × 297 mm]) A3 (11.7 × 16.5 inches [297 × 420 mm]) 11 × 17 inches (279 × 432 mm) ADF A5 (5.8 × 8.2 inches [148 × 210 mm]) A4 (8.3 × 11.7 inches [210 × 297 mm]) A3 (11.7 × 16.5 inches [297 × 420 mm]) 11 × 17 inches (279 × 432 mm)
Recording paper size	A5 (5.8 × 8.2 inches [148 × 210 mm]) A4 (8.3 × 11.7 inches [210 × 297 mm]) A3 (11.7 × 16.5 inches [297 × 420 mm]) B5 (7.2 × 10.1 inches [182 × 257 mm]) B4 (13.9 × 9.84 inches [353 × 250 mm]) Half Letter (5.5 × 8.5 inches [140 × 216 mm]) Letter (8.5 × 11 inches [216 × 279 mm]) Legal (8.5 × 14 inches [216 × 356 mm]) 11 × 17 inches (279 × 432 mm)
Transmission speed¹	Approximately 3 seconds (A4 ITU-T chart No.1 Standard MMR 33.6 kbps)

Page memory²	Up to 550 pages (when an ITU-T No. 1 chart is received in monochrome standard mode)
Contacts	Number of Contacts Up to 2000
	Number of Grouped Contacts Up to 200
Redial³	2 times (with 1 minute intervals)
Interface	RJ-11 Phone Line RJ-11 Telephone set connection

¹ Actual speed depends on the document, recipient's device, and the status of the phone line

² Retained during a power outage

³ Specifications may differ by country or region

Parent topic: [Technical Specifications](#)

Ink Cartridge Specifications

Note: Your printer is designed to work only with genuine Epson-brand ink cartridges. Other brands of ink cartridges and ink supplies are not compatible and, even if described as compatible, may not function properly or at all. Epson periodically provides firmware updates to address issues of security, performance, minor bug fixes and ensure the printer functions as designed. These updates may affect the functionality of third-party ink. Non-Epson branded or altered Epson cartridges that functioned prior to a firmware update may not continue to function.

The included initial cartridges are designed for reliable printer setup and cannot be used as replacement cartridges or resold. After setup, the remaining ink is available for printing. Yields are based on ISO 24711 in default mode, printing continuously. Yields vary due to print images, settings, and temperatures. Printing infrequently or primarily with one color reduces yields. All cartridges must be installed with ink for printing and printer maintenance. For print quality, some ink remains in replaced cartridges.

Color	Black, Cyan, Magenta, Yellow
--------------	------------------------------

Cartridge life	Opened package: 6 months Unopened package: do not use if the date on the package has expired
Temperature	Storage: -4 to 104 °F (-20 to 40 °C) 1 month at 104 °F (40 °C) Ink freezes at -9.4 °F (-23 °C) ¹ Ink thaws and is usable after 3 hours at 77 °F (25 °C)

¹ Depending on the color, ink may partially freeze at 0 °C or lower. Can store for one month at 104 °F (40 °C)

Note: For best printing results, use up a cartridge within 6 months of opening the package.

Parent topic: [Technical Specifications](#)

Related references

[Ink Cartridge Part Numbers](#)

Dimension Specifications

Height	Storage: 19.4 inches (493 mm) Stored with one optional paper cassette installed: 24.4 inches (620 mm) Stored with two optional paper cassettes installed: 29.4 inches (748 mm) Stored with three optional paper cassettes and cabinet installed: 45.7 inches (1162 mm) Printing: 22.5 inches (571 mm) Printing with one optional paper cassette installed: 27.5 inches (698 mm) Printing with two optional paper cassettes installed: 32.5 inches (826 mm) Printing with three optional paper cassettes and cabinet installed: 48.8 inches (1240 mm)
---------------	---

Width	Storage: 24.1 inches (613 mm)
	Printing: 24.1 inches (613 mm)
	With three optional paper cassettes and cabinet installed: 30.4 inches (772 mm)
Depth	Storage: 25.6 inches (650 mm)
	Stored with three optional paper cassettes and cabinet installed: 31.4 inches (797 mm)
	Printing: 33.9 inches (862 mm)
	Printing with three optional paper cassettes and cabinet installed: 34.2 inches (869 mm)
Weight (without ink cartridges or power cord)	101.6 lb (46.1 kg)
	With one optional paper cassette installed: 127.4 lb (57.8 kg)
	With two optional paper cassettes installed: 153.0 lb (69.4 kg)
	With three optional paper cassettes and cabinet installed: 231.7 lb (105.1 kg)

Parent topic: [Technical Specifications](#)

Electrical Specifications

Power supply rating	AC 100 to 240 V
Rated frequency range	50 to 60 Hz
Rated current	1.6 to 0.8 A
Power consumption (with USB Connection)¹	Standalone copying: Approximately 39 W (ISO/IEC24712)
	Ready mode: Approximately 18 W
	Sleep mode: Approximately 1.0 W
	Power off mode: Approximately 0.1 W

¹ When four optional paper cassettes (C1 to C4) are installed

Parent topic: [Technical Specifications](#)

Environmental Specifications

Temperature	Operating: 50 to 95 °F (10 to 35 °C) Storage: –4 to 104 °F (–20 to 40 °C) ¹ 1 month at 104 °F (40 °C) ¹
Humidity (without condensation)	Operating: 20 to 80% RH Storage: 5 to 85% RH

¹ Can store for one month at 104 °F (40 °C)

Parent topic: [Technical Specifications](#)

Interface Specifications

Interface type	SuperSpeed USB Hi-Speed USB (for external USB devices)
-----------------------	---

Note: Epson cannot guarantee all operations of externally connected devices.

Parent topic: [Technical Specifications](#)

Related references

[External USB Device Specifications](#)

External USB Device Specifications

Do not use devices with the following requirements:

- Dedicated driver
- Security settings, such as password or encryption, etc.
- Built-in USB hub

Hard disk drive¹	2TB
USB memory device	Formatted in FAT, FAT32, or exFAT
Multi-card reader²	

¹ We do not recommend using external USB devices that are powered by USB. Use only external USB devices with independent AC power sources.

² Only insert one memory card into the multi-card reader. Multi-card readers with more than two memory cards inserted are not supported.

Note: Epson cannot guarantee all operations of externally connected devices.

Parent topic: [Technical Specifications](#)

Network Interface Specifications

Wi-Fi

Standards	IEEE 802.11 b/g/n ¹ /ac
Frequency ranges	IEEE802.11b/g/n: 2.4 GHz IEEE802.11a/n/ac: 5.0 GHz
Channels	Wi-Fi 2.4 GHz: 1/2/3/4/5/6/7/8/9/10/11/12/13 5.0 GHz: W52 (36/40/44/48), W53 (52/56/60/64), W56 (100/104/108/112/116/120/124/128/132/136/140), W58 (149/153/157/161/165) Wi-Fi Direct 2.4 GHz: 1/2/3/4/5/6/7/8/9/10/11/12/13 5.0 GHz: W52 (36/40/44/48), W58 (149/153/157/161/165)
Connection modes	Infrastructure mode Wi-Fi Direct (Simple AP) ² ; not supported for IEEE 802.11b
Security protocols	WEP (64/128bit), WPA2-PSK (AES), WPA3-SAE (AES), WPA2/WPA3-Enterprise
Wi-Fi Direct only supports WPA2-PSK (AES)	(Complies with WPA2 standards with support for WPA/WPA2 Personal)

¹ Only available for the HT20

² Infrastructure and Wi-Fi Direct modes or an Ethernet connection can be used simultaneously

Ethernet

Standards	IEEE802.3i (10BASE-T) ¹ IEEE802.3u (100BASE-TX) ¹ IEEE802.3ab (1000BASE-T) ¹ IEEE802.3az (Energy Efficient Ethernet); the connected device should be IEEE802.3az compliant
Communication mode	Auto, 10Mbps Full duplex, 10Mbps Half duplex, 100Mbps Full duplex, 100Mbps Half duplex
Connector	RJ-45

¹ Use a category 5e or higher STP (Shielded twisted pair) cable to prevent risk of radio interference

Network Functions and IPv4/IPv6

Network Printing	EpsonNet Print (Windows): IPv4 Standard TCP/IP (Windows): IPv4, IPv6 WSD Printing (Windows): IPv4, IPv6 Bonjour Printing (Mac OS): IPv4, IPv6 IPP Printing (Windows, Mac OS): IPv4, IPv6 FTP Printing: IPv4, IPv6 Epson Connect (Email Print, Remote Print): IPv4 AirPrint (iOS 5 or later, Mac OS) ¹ : IPv4, IPv6
Network Scanning	Epson Scan 2: IPv4, IPv6 Document Capture Pro (Windows): IPv4 Epson Connect (Scan to Cloud): IPv4 AirPrint (Scan) ¹ : IPv4, IPv6
Fax	Send a fax: IPv4 Receive a fax: IPv4 Epson Connect (Fax to Cloud): IPv4 AirPrint (Faxout) ¹ : IPv4, IPv6

¹ OS X Mavericks (10.9.5) or later

Security

IEEE802.1X; requires the connected device to comply with IEEE802.1x

IPsec/IP Filtering

SSL/TLS; either HTTPS Server/Client or IPPS

TLS Version; 1.3, 1.2, 1.1 (disabled by default), or 1.0 (disabled by default)

SMTPS (STARTTLS, SSL/TLS)

SNMPv3

Parent topic: [Technical Specifications](#)

Safety and Approvals Specifications

United States

Safety: UL62368-1

EMC: FCC Part 15 Subpart B Class B

Canada

Safety: CAN/CSA C22.2 No. 62368-1

EMC: CAN ICES-3 (B)/NMB-3 (B)

This equipment contains the following wireless module:

- Manufacturer: Seiko Epson Corporation.
- Type: J26H005

This product conforms to Part 15 of FCC Rules and RSS-210 of the IC Rules. Epson cannot accept responsibility for any failure to satisfy the protection requirements resulting from a non-recommended modification of the product. Operation is subject to the following two conditions: (1) this device may not cause harmful interference, and (2) this device must accept any interference received, including interference that may cause undesired operation of the device.

To prevent radio interference to the licensed service, this device is intended to be operated indoors and away from windows to provide maximum shielding. Equipment (or its transmit antenna) that is installed outdoors is subject to licensing.

This equipment complies with FCC/IC radiation exposure limits set forth for an uncontrolled environment and meets the FCC radio frequency (RF) Exposure Guidelines in Supplement C to OET65 and RSS-102 of the IC radio frequency (RF) Exposure rules. This equipment should be installed and operated so that

the radiator is kept at least 7.9 inches (20 cm) or more away from a person's body (excluding extremities: hands, wrists, feet and ankles).

Parent topic: [Technical Specifications](#)

PostScript Fonts

Font name	Family	HP equivalent
Nimbus Mono	Medium, Bold, Italic, Bold Italic	Courier
Letter Gothic	Medium, Bold, Italic,	Letter Gothic
Nimbus Mono PS	Regular, Bold, Oblique, Bold Oblique	CourierPS
Nimbus Roman No4	Medium, Bold, Italic, Bold Italic	CG Times
URW Classico	Medium, Bold, Italic, Bold Italic	CG Omega
URW Coronet	—	Coronet
URW Clarendon Condensed	—	Clarendon Condensed
URW Classic Sans	Medium, Bold, Italic, Bold Italic	Univers
URW Classic Sans Condensed	Medium, Bold, Italic, Bold Italic	Univers Condensed
Antique Olive	Medium, Bold, Italic	Antique Olive
Garamond	Antiqua, Halbfett, Kursiv, Kursiv Halbfett	Garamond
Mauritius	—	Marigold
Algiers	Medium, Extra Bold	Albertus
NimbusSansNo2	Medium, Bold, Italic, Bold Italic	Arial
Nimbus Roman No9	Medium, Bold, Italic, Bold Italic	Times New Roman
Nimbus Sans	Medium, Bold, Oblique, Bold Oblique	Helvetica
Nimbus Sans Narrow	Medium, Bold, Oblique, Bold Oblique	Helvetica Narrow
Palladio	Roman, Bold, Italic, Bold Italic	Palatino

Font name	Family	HP equivalent
URW Gothic	Book, Demi, Book Oblique, Demi Oblique	ITC Avant Garde
URW Bookman	Light, Demi, Light Italic, Demi Italic	ITC Bookman
URW Century Schoolbook	Roman, Bold, Italic, Bold Italic	New Century Schoolbook
Nimbus Roman	Medium, Bold, Italic, Bold Italic	Times
URW Chancery Medium Italic	—	ITC Zapf Chancery Italic
Symbol	—	Symbol
URW Dingbats	—	Wingdings
Dingbats	—	ITC Zapf Dingbats
Standard Symbol	—	SymbolPS

Parent topic: [Technical Specifications](#)

PCL Fonts

Scalable Fonts

Font name	Family	HP equivalent	Symbol set
Nimbus Mono	Medium, Bold, Italic, Bold Italic	Courier	1
Letter Gothic	Medium, Bold, Italic,	Letter Gothic	1
Nimbus Mono PS	Regular, Bold, Oblique, Bold Oblique	CourierPS	3
Nimbus Roman No4	Medium, Bold, Italic, Bold Italic	CG Times	2
URW Classico	Medium, Bold, Italic, Bold Italic	CG Omega	3
URW Coronet	—	Coronet	3
URW Clarendon Condensed	—	Clarendon Condensed	3

Font name	Family	HP equivalent	Symbol set
URW Classic Sans	Medium, Bold, Italic, Bold Italic	Univers	2
URW Classic Sans Condensed	Medium, Bold, Italic, Bold Italic	Univers Condensed	3
Antique Olive	Medium, Bold, Italic	Antique Olive	3
Garamond	Antiqua, Halbfett, Kursiv, Kursiv Halbfett	Garamond	3
Mauritius	—	Marigold	3
Algiers	Medium, Extra Bold	Albertus	3
NimbusSansNo2	Medium, Bold, Italic, Bold Italic	Arial	3
Nimbus Roman No9	Medium, Bold, Italic, Bold Italic	Times New	3
Nimbus Sans	Medium, Bold, Oblique, Bold Oblique	Helvetica	3
Nimbus Sans Narrow	Medium, Bold, Oblique, Bold Oblique	Helvetica Narrow	3
Palladio	Roman, Bold, Italic, Bold Italic	Palatino	3
URW Gothic	Book, Demi, Book Oblique, Demi Oblique	ITC Avant Garde Gothic	3
URW Bookman	Light, Demi, Light Italic, Demi Italic	ITC Bookman	3
URW Century Schoolbook	Roman, Bold, Italic, Bold Italic	New Century Schoolbook	3
Nimbus Roman	Medium, Bold, Italic, Bold Italic	Times	3
URW Chancery Medium Italic	—	ITC Zapf Chancery Medium Italic	3
Symbol	—	Symbol	4

Font name	Family	HP equivalent	Symbol set
URW DingBats	—	Wingdings	5
Dingbats	—	ITC Zapf Dingbats	6
Standard Symbol	—	SymbolPS	4
URW David	Medium, Bold	HP David	7
URW Narkis	Medium, Bold	HP Narkis	7
URW Miryam	Medium, Bold, Italic	HP Miryam	7
URW Koufi	Medium, Bold	Koufi	8
URW Naskh	Medium, Bold	Naskh	8
URW Ryadh	Medium, Bold	Ryadh	8

Bitmap Font

Line Printer, Symbol set 9

OCR/Barcode Bitmap Font (PCL5 Mode Only)

Font name	Family	Symbol set
OCR A	—	10
OCR B	—	11
Code 39	9.37cpi, 4.68cpi	12
EAN/UPC	Medium, Bold	13

Note: Depending on the print density, or quality and color of the paper, the OCR/Barcode Bitmap fonts may not be readable. Print a sample and check for readability before printing large quantities.

Parent topic: [Technical Specifications](#)

PCL Mode 5 Symbol Sets

Your product can access a variety of symbol sets. Many of these symbol sets differ only in the international characters specific to each language.

Note: Since most software handles fonts and symbols automatically, you may never need to adjust your product settings. However, if you write your own product control programs, or if you use older software that cannot control fonts, refer to these tables for details on the symbol sets.

When you consider which font to use, also consider which symbol set to combine with the font.

Symbol set name	Attribute	Font classification
Norweg1	0D	1, 2, 3
Roman Extension	0E	9
Italian	0I	1, 2, 3
EMC94-1	0N	1, 2, 3, 9
Swedis2	0S	1, 2, 3
ANSI ASCII	0U	1, 2, 3, 7, 8
UK	1E	1, 2, 3
French2	1F	1, 2, 3
German	1G	1, 2, 3
Legal	1U	1, 2, 3, 9
8859-2 ISO	2N	1, 2, 3, 9
Spanish	2S	1, 2, 3
ISO 8859/4 Latin 4	4N	1, 2, 3
Roman-9	4U	1, 2, 3
PsMath	5M	1, 2, 3, 7, 8
8859-9 ISO	5N	1, 2, 3, 9
WiTurkish	5T	1, 2, 3
MsPublishin	6J	1, 2, 3
VeMath	6M	1, 2, 3
8859-10ISO	6N	1, 2, 3, 9
DeskTop	7J	1, 2, 3
Math-8	8M	1, 2, 3, 7, 8

Symbol set name	Attribute	Font classification
Roman-8	8U	1, 2, 3, 9
WiE.Europe	9E	1, 2, 3
Pc1004	9J	1, 2, 3
8859-15ISO	9N	1, 2, 3, 9
PcTk437	9T	1, 2, 3
Windows	9U	1, 2, 3
PsText	10J	1, 2, 3
IBM-US	10U	1, 2, 3, 9
IBM-DN	11U	1, 2, 3, 9
McText	12J	1, 2, 3
PcMultiling	12U	1, 2, 3, 9
VeInternati	13J	1, 2, 3
PcEur858	13U	1, 2, 3
VeUS	14J	1, 2, 3
PiFont	15U	1, 2, 3
PcE.Europe	17U	1, 2, 3
Unicode 3.0	18N	1, 2, 3, 7, 8
WiBALT	19L	1, 2, 3
WiAnsi	19U	1, 2, 3
PcBlt775	26U	1, 2, 3
Pc866Cyr	3R	1, 2
Greek8	8G	1, 2
WinGrk	9G	1, 2
WinCyr	9R	1, 2
Pc851Grk	10G	1, 2
ISOCyr	10N	1, 2, 9

Symbol set name	Attribute	Font classification
Pc8Grk	12G	1, 2
ISOGrk	12N	1, 2
Pc866Ukr	14R	1, 2
Hebrew7	0H	1, 7
8859-8 ISO	7H	1, 7
Hebrew8	8H	1, 7
Pc862Heb	15H	1, 7
PC-862, Hebrew	15Q	1, 7
Arabic8	8V	8
HPWARA	9V	8
Pc864Ara	10V	8
Symbol	19M	4
Wingdings	579L	5
ZapfDigrbats	14L	6
OCR A	0O	10
OCR B	1O	11
OCR B Extension	3Q	11
Code3-9	0Y	12
EAN/UPC	8Y	13

Parent topic: [Technical Specifications](#)

Notices

Check these sections for important notices about your product.

Note: Epson offers a recycling program for end of life Epson products. Please go to [this site](#) (U.S.) or [this site](#) (Canada) for information on how to return your Epson products for proper disposal.

[Important Safety Instructions](#)

[FCC Compliance Statement](#)

[Binding Arbitration and Class Waiver](#)

[Trademarks](#)

[Copyright Notice](#)

Important Safety Instructions

Before using your Epson product, read and follow these safety instructions.

[General Product Safety Instructions](#)

[Ink Cartridge Safety Instructions](#)

[Wireless Connection Safety Instructions](#)

[LCD Screen Safety Instructions](#)

[Telephone Equipment Safety Instructions](#)

Parent topic: [Notices](#)

General Product Safety Instructions

- Be sure to follow all warnings and instructions marked on the product.
- Use only the type of power source indicated on the product's label.
- Use only the power cord that comes with the product. Do not use the cord with any other equipment. Using another cord or using the provided cord with other equipment may cause fires or shock.
- Make sure the AC power cord meets the relevant local safety standard.
- Place the product near a wall outlet where the plug can be easily unplugged.
- Avoid plugging the product into an outlet on the same circuit as a photo copier or air control system that regularly switches on and off, or on an outlet controlled by a wall switch or timer.

- Do not let the power cord become damaged or frayed. Place it to avoid abrasions, cuts, fraying, crimping, and kinking. Do not place objects on top of it and do not allow it to be stepped on or run over. Be careful to keep the cord straight at each end.
- If you use an extension cord with the product, make sure the total ampere rating of the devices plugged into the extension cord does not exceed the cord's ampere rating. Also, make sure the total ampere rating of all devices plugged into the wall outlet does not exceed the wall outlet's ampere rating.
- Always turn off the product using the power button, and wait until the power light stops flashing before unplugging the product or cutting off power to the electrical outlet.
- If you will not be using the product for a long period, unplug the power cord from the electrical outlet.
- Place the product on a flat, stable surface that extends beyond its base in all directions. It will not operate properly if it is tilted or at an angle.
- Allow space behind the product for the cables, and space above the product so that you can fully raise the document cover.
- Leave enough space in front of the product for the paper to be fully ejected.
- Avoid locations that are subject to rapid changes in heat or humidity, shocks or vibrations, or dust.
- Do not place or store the product outdoors.
- Do not place the product near excessive heat sources or in direct sunlight.
- Leave enough room around the product for sufficient ventilation. Do not block or cover openings in the case or insert objects through the slots.
- Keep the product away from potential sources of electromagnetic interference, such as loudspeakers or the base units of cordless telephones.
- When connecting the product to a computer or other device with a cable, ensure the correct orientation of the connectors. Each connector has only one correct orientation. Inserting a connector in the wrong orientation may damage both devices connected by the cable.
- Do not sit or lean on the product. Do not place heavy objects on the product.
- Do not move the printhead by hand; this may damage the product.
- Do not put your hands inside the product while it is printing.
- Do not spill liquid on the product or use the product with wet hands.
- Do not use aerosol products that contain flammable gases inside or around the product. Doing so may cause fire.
- Do not press too hard on the scanner glass when placing originals.

- Do not open the scanner section while the product is copying, printing, scanning, or performing any other functions.
- Except as specifically explained in your documentation, do not attempt to service or disassemble the product yourself.
- Unplug the product and refer servicing to qualified service personnel under the following conditions: if the power cord or plug is damaged; if liquid has entered the product; if the product has been dropped or the case damaged; if the product does not operate normally or exhibits a distinct change in performance. Adjust only those controls that are covered by the operating instructions.
- When storing or transporting the product, do not tilt it, stand it on its side, or turn it upside down; otherwise, ink may leak.

Parent topic: [Important Safety Instructions](#)

Ink Cartridge Safety Instructions

- Keep ink cartridges and maintenance box out of the reach of children and do not drink the ink.
- Be careful when you handle used ink cartridges; there may be ink remaining around the ink supply port. If ink gets on your skin, wash it off with soap and water. If it gets in your eyes, flush them immediately with water. If you experience discomfort or vision problems after flushing your eyes, see a doctor immediately. If ink gets in your mouth, see a doctor immediately.
- Do not put your hand inside the product or touch any cartridges during printing.
- Do not turn off the product during ink charging. If ink charging is incomplete, you may not be able to print.
- Install a new ink cartridge immediately after removing an expended one. Leaving cartridges uninstalled can dry out the print head and may prevent the product from printing.
- Do not remove or tear the label on the cartridge; this can cause leakage.
- Do not drop or knock ink cartridges against hard objects; this can cause leakage.
- Do not remove the transparent seal from the bottom of the cartridge. This may cause the cartridge to become unusable.
- Do not disassemble or modify the ink cartridge; you may not be able to print normally.
- Do not break the hooks on the side of the cartridge when removing it from the packaging.
- Do not touch the green IC chip on the side of the cartridge. This may prevent normal operation.
- Do not shake cartridges too vigorously; this can cause them to leak.
- If you remove an ink cartridge for later use, protect the ink supply area from dirt and dust and store it in the same environment as the product. Note that there is a valve in the ink supply port, making covers

or plugs unnecessary, but care is needed to prevent the ink from staining items that the cartridge touches. Do not touch the ink cartridge ink supply port or surrounding area.

- Use an ink cartridge before the date printed on its package or within six months of opening the package, whichever is earlier.
- Do not dismantle an ink cartridge. This could damage the print head.
- Keep the ink cartridges out of direct sunlight.
- Store ink cartridges in a cool, dark place; do not store the ink cartridges in high or freezing temperatures.
- Make sure to install all ink cartridges. The printer only works when all ink cartridges are properly installed.
- After bringing an ink cartridge inside from a cold storage site, allow it to warm up at room temperature for at least three hours before using it.

Parent topic: [Important Safety Instructions](#)

Wireless Connection Safety Instructions

Radio waves from this product may adversely affect the operation of medical equipment or automatically controlled devices, such as pacemakers, automatic doors or fire alarms. When using this product near such devices or inside a medical facility, follow the directions from authorized staff members at the facility, and follow all posted warnings and directions on the device to avoid causing an accident.

Do not connect this product to the internet directly. Connect it to a network protected by a router or firewall.

Parent topic: [Important Safety Instructions](#)

LCD Screen Safety Instructions

- Use only a dry, soft cloth to clean the LCD screen. Do not use liquid or chemical cleansers.
- If the LCD screen is damaged, contact Epson. If the liquid crystal solution gets on your hands, wash them thoroughly with soap and water. If the liquid crystal solution gets into your eyes, flush them immediately with water. If discomfort or vision problems remain after a thorough flushing, see a doctor immediately. If liquid enters your mouth, see a doctor immediately.
- Do not press too hard on the LCD screen or subject it to heavy impacts.
- Do not use a pointy or sharp object, such as a pen or your fingernail, to operate the LCD screen.
- If the LCD screen chips or cracks, do not touch or attempt to remove the broken pieces; contact Epson for support.

- Do not subject your product to sudden changes in temperature or humidity; this may cause condensation to develop inside the LCD screen and degrade its performance.
- The LCD screen may contain a few small bright or dark spots, and may display uneven brightness. These are normal and do not indicate that the screen is damaged in any way.

Parent topic: [Important Safety Instructions](#)

Telephone Equipment Safety Instructions

When using telephone equipment, you should always follow basic safety precautions to reduce the risk of fire, electric shock, and personal injury, including the following:

- Do not use the Epson product near water.
- Avoid using a telephone during an electrical storm. There may be a remote risk of electric shock from lightning.
- Do not use a telephone to report a gas leak in the vicinity of the leak.

Caution: To reduce the risk of fire, use only a No. 26 AWG or larger telecommunication line cord.

Parent topic: [Important Safety Instructions](#)

FCC Compliance Statement

For United States Users

This equipment complies with Part 68 of the FCC rules and the requirements adopted by the Administrative Council for Terminal Attachments ("ACTA"). On the surface of this equipment is a label that contains, among other information, a product identifier in the format US:AAAEQ##TXXXX. If requested, this number must be provided to the telephone company.

Applicable certification jack Universal Service Order Codes ("USOC") for the equipment: RJ11C.

A plug and jack used to connect this equipment to the premises wiring and telephone network must comply with the applicable FCC Part 68 rules and requirements adopted by the ACTA. A compliant telephone cord and modular plug is provided with this product. It is designed to be connected to a compatible modular jack that is also compliant. See installation instructions for details.

The REN is used to determine the number of devices that may be connected to a telephone line. Excessive RENs on a telephone line may result in the devices not ringing in response to an incoming call. In most but not all areas, the sum of RENs should not exceed five (5.0). To be certain of the number of devices that may be connected to a line, as determined by the total RENs, contact the local telephone company. For products approved after July 23, 2001, the REN for this product is part of the product

identifier that has the format US:AAAEQ##TXXXX. The digits represented by ## are the REN without a decimal point (e.g., 03 is a REN of 0.3). For earlier products, the REN is separately shown on the label.

If this equipment causes harm to the telephone network, the telephone company will notify you in advance that temporary discontinuance of service may be required. But if advance notice isn't practical, the telephone company will notify the customer as soon as possible. Also, you will be advised of your right to file a complaint with the FCC if you believe it is necessary.

The telephone company may make changes in its facilities, equipment, operations, or procedures that could affect the operation of the equipment. If this happens the telephone company will provide advance notice in order for you to make necessary modifications to maintain uninterrupted service.

If you have problems with this product and require technical or customer support, please visit www.epson.com for more information.

This product is not intended to be repaired by the customer. If you experience trouble connecting this equipment to a telephone line, please contact:

Name: Epson America, Inc.

Address: 3131 Katella Ave., Los Alamitos, CA 90720 U.S.A.

Telephone: (562) 981-3840

If the equipment is causing harm to the telephone network, the telephone company may request that you disconnect the equipment until the problem is resolved.

This equipment may not be used on coin service provided by the telephone company. Connection to party line service is subject to state tariffs. Contact the state public utility commission, public service commission or corporation commission for information.

If your home has specially wired alarm equipment connected to the telephone line, ensure the installation of this equipment does not disable your alarm equipment. If you have questions about what will disable alarm equipment, consult your telephone company or a qualified installer.

The Telephone Consumer Protection Act of 1991 makes it unlawful for any person to use a computer or other electronic device, including fax machines, to send any message unless such message clearly contains in a margin at the top or bottom of each transmitted page or on the first page of the transmission, the date and time it is sent and an identification of the business or other entity, or other individual sending the message and the telephone number of the sending machine or such business, other entity, or individual. (The telephone number provided may not be a 900 number or any other number for which charges exceed local or long-distance transmission charges.)

To comply with this law, you must enter the following information in your fax unit. Click the link below or see the Faxing section of this guide for instructions on doing this.

- Date and time

- Name and telephone number which identify the source of your fax transmission

According to the FCC's electrical safety advisory, we recommend that you may install an AC surge arrester in the AC outlet to which this equipment is connected. Telephone companies report that electrical surges, typically lightning transients, are very destructive to customer terminal equipment connected to AC power sources and that this is a major nationwide problem.

This equipment has been tested and found to comply with the limits for a Class B digital device, pursuant to Part 15 of the FCC Rules. These limits are designed to provide reasonable protection against harmful interference in a residential installation. This equipment generates, uses, and can radiate radio frequency energy and, if not installed and used in accordance with the instructions, may cause harmful interference to radio communications. However, there is no guarantee that interference will not occur in a particular installation. If this equipment does cause harmful interference to radio or television reception, which can be determined by turning the equipment off and on, the user is encouraged to try to correct the interference by one or more of the following measures:

- Reorient or relocate the receiving antenna.
- Increase the separation between the equipment and receiver.
- Connect the equipment into an outlet on a circuit different from that to which the receiver is connected.
- Consult the dealer or an experienced radio/TV technician for help.

WARNING

The connection of a non-shielded equipment interface cable to this equipment will invalidate the FCC Certification or Declaration of this device and may cause interference levels which exceed the limits established by the FCC for this equipment. It is the responsibility of the user to obtain and use a shielded equipment interface cable with this device. If this equipment has more than one interface connector, do not leave cables connected to unused interfaces. Changes or modifications not expressly approved by the party responsible for compliance could void the user's authority to operate this equipment.

For Canadian Users

1. This product meets the applicable Innovation, Science and Economic Development Canada technical specifications.
2. The Ringer Equivalence Number indicates the maximum number of devices allowed to be connected to a telephone interface. The termination of an interface may consist of any combination of devices subject only to the requirement that the sum of the RENs of all the devices does not exceed five.

CAN ICES-3(B)/NMB-3(B)

Le présent produit est conforme aux spécifications techniques applicables d'Innovation, Sciences et Développement économique Canada.

L'indice d'équivalence de la sonnerie (IES) sert à indiquer le nombre maximal de dispositifs qui peuvent être raccordés à une interface téléphonique. La terminaison d'une interface peut consister en une combinaison quelconque de dispositifs, à la seule condition que la somme des IES de tous les dispositifs n'excède pas cinq.

CAN ICES-3(B)/NMB-3(B)

Parent topic: [Notices](#)

Binding Arbitration and Class Waiver

1. DISPUTES, BINDING INDIVIDUAL ARBITRATION, AND WAIVER OF CLASS ACTIONS AND CLASS ARBITRATIONS

1.1 Disputes. The terms of this Section 1 shall apply to all Disputes between you and Epson. The term "Dispute" is meant to have the broadest meaning permissible under law and includes any dispute, claim, controversy or action between you and Epson arising out of or relating to this Agreement, Epson branded products (hardware and including any related software), or other transaction involving you and Epson, whether in contract, warranty, misrepresentation, fraud, tort, intentional tort, statute, regulation, ordinance, or any other legal or equitable basis. "DISPUTE" DOES NOT INCLUDE IP CLAIMS, or more specifically, a claim or cause of action for (a) trademark infringement or dilution, (b) patent infringement, (c) copyright infringement or misuse, or (d) trade secret misappropriation (an "IP Claim"). You and Epson also agree, notwithstanding Section 1.6, that a court, not an arbitrator, may decide if a claim or cause of action is for an IP Claim.

1.2 Binding Arbitration. You and Epson agree that all Disputes shall be resolved by binding arbitration according to this Agreement. **ARBITRATION MEANS THAT YOU WAIVE YOUR RIGHT TO A JUDGE OR JURY IN A COURT PROCEEDING AND YOUR GROUNDS FOR APPEAL ARE LIMITED.** Pursuant to this Agreement, binding arbitration shall be administered by JAMS, a nationally recognized arbitration authority, pursuant to its code of procedures then in effect for consumer related disputes, but excluding any rules that permit joinder or class actions in arbitration (for more detail on procedure, see Section 1.6 below). You and Epson understand and agree that (a) the Federal Arbitration Act (9 U.S.C. §1, et seq.) governs the interpretation and enforcement of this Section 1, (b) this Agreement memorializes a transaction in interstate commerce, and (c) this Section 1 shall survive termination of this Agreement.

1.3 Pre-Arbitration Steps and Notice. Before submitting a claim for arbitration, you and Epson agree to try, for sixty (60) days, to resolve any Dispute informally. If Epson and you do not reach an agreement to resolve the Dispute within the sixty (60) days, you or Epson may commence an arbitration. Notice to Epson must be addressed to: Epson America, Inc., ATTN: Legal Department, 3131 Katella Ave., Los Alamitos, CA 90720 (the "Epson Address"). The Dispute Notice to you will be sent to the most recent address Epson has in its records for you. For this reason, it is important to notify us if your address changes by emailing us at EAILEgal@ea.epson.com or writing us at the Epson Address above. Notice of

the Dispute shall include the sender's name, address and contact information, the facts giving rise to the Dispute, and the relief requested (the "Dispute Notice"). Following receipt of the Dispute Notice, Epson and you agree to act in good faith to resolve the Dispute before commencing arbitration.

1.4 Small Claims Court. Notwithstanding the foregoing, you may bring an individual action in the small claims court of your state or municipality if the action is within that court's jurisdiction and is pending only in that court.

1.5 WAIVER OF CLASS ACTIONS AND CLASS ARBITRATIONS. YOU AND EPSON AGREE THAT EACH PARTY MAY BRING DISPUTES AGAINST THE OTHER PARTY ONLY IN AN INDIVIDUAL CAPACITY, AND NOT AS A PLAINTIFF OR CLASS MEMBER IN ANY CLASS OR REPRESENTATIVE PROCEEDING, INCLUDING WITHOUT LIMITATION FEDERAL OR STATE CLASS ACTIONS, OR CLASS ARBITRATIONS. CLASS ACTION LAWSUITS, CLASS-WIDE ARBITRATIONS, PRIVATE ATTORNEY-GENERAL ACTIONS, AND ANY OTHER PROCEEDING WHERE SOMEONE ACTS IN A REPRESENTATIVE CAPACITY ARE NOT ALLOWED. ACCORDINGLY, UNDER THE ARBITRATION PROCEDURES OUTLINED IN THIS SECTION, AN ARBITRATOR SHALL NOT COMBINE OR CONSOLIDATE MORE THAN ONE PARTY'S CLAIMS WITHOUT THE WRITTEN CONSENT OF ALL AFFECTED PARTIES TO AN ARBITRATION PROCEEDING.

1.6 Arbitration Procedure. If you or Epson commences arbitration, the arbitration shall be governed by the rules of JAMS that are in effect when the arbitration is filed, excluding any rules that permit arbitration on a class or representative basis (the "JAMS Rules"), available at <http://www.jamsadr.com> or by calling 1-800-352-5267, and under the rules set forth in this Agreement. All Disputes shall be resolved by a single neutral arbitrator, and both parties shall have a reasonable opportunity to participate in the selection of the arbitrator. The arbitrator is bound by the terms of this Agreement. The arbitrator, and not any federal, state or local court or agency, shall have exclusive authority to resolve all disputes arising out of or relating to the interpretation, applicability, enforceability or formation of this Agreement, including any claim that all or any part of this Agreement is void or voidable. Notwithstanding this broad delegation of authority to the arbitrator, a court may determine the limited question of whether a claim or cause of action is for an IP Claim, which is excluded from the definition of "Disputes" in Section 1.1 above. The arbitrator shall be empowered to grant whatever relief would be available in a court under law or in equity. The arbitrator may award you the same damages as a court could, and may award declaratory or injunctive relief only in favor of the individual party seeking relief and only to the extent necessary to provide relief warranted by that party's individual claim. In some instances, the costs of arbitration can exceed the costs of litigation and the right to discovery may be more limited in arbitration than in court. The arbitrator's award is binding and may be entered as a judgment in any court of competent jurisdiction.

You may choose to engage in arbitration hearings by telephone. Arbitration hearings not conducted by telephone shall take place in a location reasonably accessible from your primary residence, or in Orange County, California, at your option.

a) Initiation of Arbitration Proceeding. If either you or Epson decides to arbitrate a Dispute, both parties agree to the following procedure:

(i) Write a Demand for Arbitration. The demand must include a description of the Dispute and the amount of damages sought to be recovered. You can find a copy of a Demand for Arbitration at <http://www.jamsadr.com> ("Demand for Arbitration").

(ii) Send three copies of the Demand for Arbitration, plus the appropriate filing fee, to: JAMS, 500 North State College Blvd., Suite 600 Orange, CA 92868, U.S.A.

(iii) Send one copy of the Demand for Arbitration to the other party (same address as the Dispute Notice), or as otherwise agreed by the parties.

b) Hearing Format. During the arbitration, the amount of any settlement offer made shall not be disclosed to the arbitrator until after the arbitrator determines the amount, if any, to which you or Epson is entitled. The discovery or exchange of non-privileged information relevant to the Dispute may be allowed during the arbitration.

c) Arbitration Fees. Epson shall pay, or (if applicable) reimburse you for, all JAMS filings and arbitrator fees for any arbitration commenced (by you or Epson) pursuant to provisions of this Agreement.

d) Award in Your Favor. For Disputes in which you or Epson seeks \$75,000 or less in damages exclusive of attorney's fees and costs, if the arbitrator's decision results in an award to you in an amount greater than Epson's last written offer, if any, to settle the Dispute, Epson will: (i) pay you \$1,000 or the amount of the award, whichever is greater; (ii) pay you twice the amount of your reasonable attorney's fees, if any; and (iii) reimburse you for any expenses (including expert witness fees and costs) that your attorney reasonably accrues for investigating, preparing, and pursuing the Dispute in arbitration. Except as agreed upon by you and Epson in writing, the arbitrator shall determine the amount of fees, costs, and expenses to be paid by Epson pursuant to this Section 1.6d).

e) Attorney's Fees. Epson will not seek its attorney's fees and expenses for any arbitration commenced involving a Dispute under this Agreement. Your right to attorney's fees and expenses under Section 1.6d) above does not limit your rights to attorney's fees and expenses under applicable law; notwithstanding the foregoing, the arbitrator may not award duplicative awards of attorney's fees and expenses.

1.7 Opt-out. You may elect to opt-out (exclude yourself) from the final, binding, individual arbitration procedure and waiver of class and representative proceedings specified in this Agreement by sending a written letter to the Epson Address within thirty (30) days of your assent to this Agreement (including without limitation the purchase, download, installation of the Software or other applicable use of Epson Hardware, products and services) that specifies (i) your name, (ii) your mailing address, and (iii) your request to be excluded from the final, binding individual arbitration procedure and waiver of class and representative proceedings specified in this Section 1. In the event that you opt-out consistent with the procedure set forth above, all other terms shall continue to apply, including the requirement to provide notice prior to litigation.

1.8 Amendments to Section 1. Notwithstanding any provision in this Agreement to the contrary, you and Epson agree that if Epson makes any future amendments to the dispute resolution procedure and class action waiver provisions (other than a change to Epson's address) in this Agreement, Epson will obtain your affirmative assent to the applicable amendment. If you do not affirmatively assent to the applicable amendment, you are agreeing that you will arbitrate any Dispute between the parties in accordance with the language of this Section 1 (or resolve disputes as provided for in Section 1.7, if you timely elected to opt-out when you first assented to this Agreement).

1.9 Severability. If any provision in this Section 1 is found to be unenforceable, that provision shall be severed with the remainder of this Agreement remaining in full force and effect. **The foregoing shall not apply to the prohibition against class or representative actions as provided in Section 1.5. This means that if Section 1.5 is found to be unenforceable, the entire Section 1 (but only Section 1) shall be null and void.**

Parent topic: [Notices](#)

Trademarks

EPSON® is a registered trademark, the EPSON logo is a registered logomark, Epson Connect™ and Epson Remote Print™ are trademarks of Seiko Epson Corporation.

Apple, App Store, AirPrint, iPad, iPhone, iPod touch, Mac, macOS, OS X, and the AirPrint logo are trademarks of Apple Inc., registered in the U.S. and other countries.

Use of the Works with Apple badge means that an accessory has been designed to work specifically with the technology identified in the badge and has been certified by the developer to meet Apple performance standards.

The Mopria™ wordmark and the Mopria™ Logo are registered and/or unregistered trademarks of Mopria Alliance, Inc. in the United States and other countries. Unauthorized use is strictly prohibited.

Android, Chromebook, and Google are registered trademarks and Gmail, Google Drive, and Google Play are trademarks of Google LLC.

Microsoft is a trademark of the Microsoft group of companies.

Wi-Fi Direct® is a registered trademark of Wi-Fi Alliance®.

General Notice: Other product names used herein are for identification purposes only and may be trademarks of their respective owners. Epson disclaims any and all rights in those marks.

EPSON®

Parent topic: [Notices](#)

Copyright Notice

All rights reserved. No part of this publication may be reproduced, stored in a retrieval system, or transmitted in any form or by any means, electronic, mechanical, photocopying, recording, or otherwise, without the prior written permission of Seiko Epson Corporation. The information contained herein is designed only for use with this Epson product. Epson is not responsible for any use of this information as applied to other products.

Neither Seiko Epson Corporation nor its affiliates shall be liable to the purchaser of this product or third parties for damages, losses, costs, or expenses incurred by purchaser or third parties as a result of: accident, misuse, or abuse of this product or unauthorized modifications, repairs, or alterations to this product, or (excluding the U.S.) failure to strictly comply with Seiko Epson Corporation's operating and maintenance instructions.

Seiko Epson Corporation shall not be liable for any damages or problems arising from the use of any options or any consumable products other than those designated as Original Epson Products or Epson Approved Products by Seiko Epson Corporation.

Seiko Epson Corporation shall not be held liable for any damage resulting from electromagnetic interference that occurs from the use of any interface cables other than those designated as Epson approved Products by Seiko Epson Corporation.

This information is subject to change without notice.

[A Note Concerning Responsible Use of Copyrighted Materials](#)
[Default Delay Times for Power Management for Epson Products](#)
[Copyright Attribution](#)

Parent topic: [Notices](#)

A Note Concerning Responsible Use of Copyrighted Materials

Epson encourages each user to be responsible and respectful of the copyright laws when using any Epson product. While some countries' laws permit limited copying or reuse of copyrighted material in certain circumstances, those circumstances may not be as broad as some people assume. Contact your legal advisor for any questions regarding copyright law.

Parent topic: [Copyright Notice](#)

Default Delay Times for Power Management for Epson Products

This product will enter sleep mode after a period of nonuse. This is to ensure that the product meets Energy Star standards of energy efficiency. More energy savings can be achieved by setting the time to sleep to a shorter interval.

Parent topic: [Copyright Notice](#)

Copyright Attribution

© 2025 Epson America, Inc.

8/25

CPD-64783R2

Parent topic: [Copyright Notice](#)