



# MOBIUZ

LCD Monitor  
**User Manual**

EX Series

## Copyright

Copyright © 2024 by BenQ Corporation. All rights reserved. No part of this publication may be reproduced, transmitted, transcribed, stored in a retrieval system or translated into any language or computer language, in any form or by any means, electronic, mechanical, magnetic, optical, chemical, manual or otherwise, without the prior written permission of BenQ Corporation.

## Disclaimer

BenQ Corporation makes no representations or warranties, either expressed or implied, with respect to the contents hereof and specifically disclaims any warranties, merchantability or fitness for any particular purpose. Further, BenQ Corporation reserves the right to revise this publication and to make changes from time to time in the contents hereof without obligation of BenQ Corporation to notify any person of such revision or changes.

BenQ flicker-free technology maintains a stable backlight with a DC dimmer that eliminates the primary cause of monitor flicker, making it easier on the eyes. The performance of flicker-free may be affected by external factors such as poor cable quality, unstable power supply, signal interference, or poor grounding, and not limited to the above mentioned external factors. (Applicable for flicker-free models only.)

## BenQ ecoFACTS

BenQ has been dedicated to the design and development of greener product as part of its aspiration to realize the ideal of the "Bringing Enjoyment 'N Quality to Life" corporate vision with the ultimate goal to achieve a low-carbon society. Besides meeting international regulatory requirement and standards pertaining to environmental management, BenQ has spared no efforts in pushing our initiatives further to incorporate life cycle design in the aspects of material selection, manufacturing, packaging, transportation, using and disposal of the products. BenQ ecoFACTS label lists key eco-friendly design highlights of each product, hoping to ensure that consumers make informed green choices at purchase. Check out BenQ's CSR Website at <http://csr.BenQ.com/> for more details on BenQ's environmental commitments and achievements.

## Product carbon footprint (PCF)

The carbon footprint of a product is the estimated carbon emission throughout its entire life cycle. The information may be available on the package or [online](#).

The carbon footprint stated for this product is the current estimate and the actual result may be subject to change due to unforeseen conditions. This means the actual product carbon footprint may be different from the declared statement.

You may not find your product's carbon footprint as it was not available at the time the product was shipped. The information should be online once it's available.



# Product support

This document aims to provide the most updated and accurate information to customers, and thus all contents may be modified from time to time without prior notice. Please visit the website for the latest version of this document and other product information. Available files vary by model.

1. Make sure your computer is connected to the Internet.
2. Visit the local website from [Support.BenQ.com](https://Support.BenQ.com). The website layout and content may vary by region/country.
  - User manual and related document
  - Drivers and applications
  - (EU only) Dismantled information: Available on the user manual download page. This document is provided based on Regulation (EU) 2019/2021 to repair or recycle your product. Always contact the local customer service for servicing within the warranty period. If you wish to repair an out-of-warranty product, you are recommended to go to a qualified service personnel and obtain repair parts from BenQ to ensure compatibility. Do not disassemble the product unless you are aware of the consequences. If you cannot find the dismantled information on your product, contact the local customer service for assistance.

## Firmware upgrade

You are recommended to upgrade the product to the latest firmware version (if available) and refer to the most up-to-date user manual to make best use of the product.

To upgrade your monitor, download and install the **Display QuickKit** software from the BenQ website.

- [Support.BenQ.com](https://Support.BenQ.com) > model name > **Software & Driver** > **Display QuickKit** (available only when your monitor is compatible)
- [Support.BenQ.com](https://Support.BenQ.com) > **Display QuickKit** (availability may vary by region)

The software utility checks the compatibility of your monitor automatically once launched. Refer to the user manual of the software utility for instructions.

If your monitor is not compatible with **Display QuickKit**, and you wonder if there is an updated firmware version available, please contact BenQ customer service.

## Advanced software

Apart from the built-in technologies and features available on this product, you are provided with more software applications to enhance and extend the product functionality.

Download the software and its user guide (if available) as instructed from the BenQ website.

### • Color Shuttle

Color Shuttle is a utility software that allows users to apply, save, and globally share monitor settings. It also offers a curated collection of settings from color experts, game developers, and content creators worldwide.



# Q&A index

Start with the topics that you are interested in.

## Setup

### How to set up the monitor and turn it on?

Safety precautions	7
Assembling your monitor hardware	23

### How to adjust the monitor viewing angle?

Adjust the viewing angle.	26
---------------------------	----

### How to wall mount the monitor?

Using the monitor wall mounting kit (purchased separately)	29
--	----

## Input source and image display

### How to switch inputs quickly?

Switching the inputs quickly	39
The control panel	30

### How to use scenario mapping and how it works?

Setting up your monitor for different scenarios	36
Customizing the Quick Menu for a scenario	37

### How to optimize the gaming experience?

Choosing a color mode	40
Choosing an audio mode	40
Initial higher refresh rate for your device	41

### How to obtain the best HDR effect?

Enabling HDR function	40
-----------------------	----

## I/O ports and accessories

### What devices can be connected to my monitor?

Connections	19
-------------	----

### How to use the remote control?

Getting to know your remote control	20
The remote control and its effective range	30

## Menus and accessories

### How to control my monitor?

Monitor controls	30
------------------	----

### How to use the OSD menu?

Menu introduction	31
-------------------	----

5-way controller and basic menu operations 35

Navigating the main menu 42

**What menu options are available to each color mode?**

Available menu options to each Color Mode 47

**Maintenance and product support**

**How to clean the monitor?**

Care and cleaning 10

**How to keep the monitor not in use for a long time?**

How to detach the stand and the base 28

Care and cleaning 10

**I need more support.**

Product support 4

Servicing 10

# Safety precautions

## Power safety



Please follow these safety instructions for best performance, and long life for your monitor.

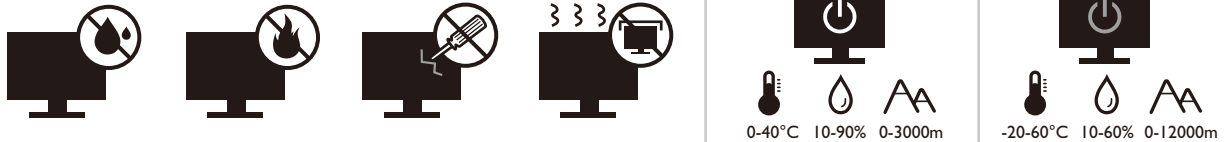

- The AC plug isolates this equipment from the AC supply.
- The power supply cord serves as a power disconnect device for pluggable equipment. The socket outlet should be installed near the equipment and be easily accessible.
- This product should be operated from the type of power indicated on the marked label. If you are not sure of the type of power available, consult your dealer or local power company.
- The Class I pluggable equipment Type A must be connected to protective earth.
- An approved power cord greater or equal to H03VV-F or H05VV-F, 2G or 3G, 0.75mm<sup>2</sup> must be used.
- Use only the power cord provided by BenQ. Never use a power cord that appears to be damaged or frayed.
- To avoid possible damage to the monitor, do not use it in a region where power supply is unstable.
- Ensure that the power cord is connected to a grounded power outlet before turning on the monitor.
- To avoid possible danger, observe the total electric load when using the monitor with a (multi-outlet) extension cord.
- Always turn off the monitor before unplugging the power cord.

For Germany only:

- (If the weight of the product is less than or equal to 3 kg) An approved power cord greater or equal to H03VV-F, 3G, 0.75mm<sup>2</sup> must be used.
- (If the weight of the product is more than 3 kg) An approved power cord greater or equal to H05VV-F or H05RR-F, 3G, 0.75mm<sup>2</sup> must be used.
- (If a remote control is provided) RISK OF EXPLOSION IF BATTERY IS REPLACED BY AN INCORRECT TYPE. DISPOSE OF USED BATTERIES ACCORDING TO THE INSTRUCTIONS.

For models with adapter:

- Use only the power adapter supplied with your LCD Monitor. Use of another type of power adapter will result in malfunction and/or danger.
- Allow adequate ventilation around the adapter when using it to operate the device or charge the battery. Do not cover the power adapter with paper or other objects that will reduce cooling. Do not use the power adapter while it is inside a carrying case.
- Connect the power adapter to a proper power source.

- Do not attempt to service the power adapter. There are no service parts inside. Replace the unit if it is damaged or exposed to excess moisture.

## Installation

- Do not use your monitor under any of the following environmental conditions:
  - Extremely high or low temperature, or in direct sunlight
  - Dusty places
  - Highly humid, exposed to rain, or close to water
  - Exposed to vibrations or impacts in places such as cars, buses, trains, and other rail vehicles
  - Near heating appliances such as radiators, heaters, fuel stoves, and other heat-generating items (including audio amplifiers)
  - An enclosed place (such as a closet or bookcase) without appropriate ventilation
  - An uneven or sloping surface
  - Exposed to chemical substances or smoke
- Carry the monitor carefully.
- Do not place heavy loads on the monitor to avoid possible personal injury or damage to the monitor.
- Ensure that children do not hang or climb onto the monitor.
- Keep all packing bags out of reach of children.

## Operation

- To protect your eyesight, please refer to the user manual to set the optimal screen resolution and the viewing distance.
- To reduce eye fatigue, take a break on a regular basis while using the monitor.
- Avoid taking either one of the following actions for a long time. Otherwise, burn marks may occur.
  - Play images that cannot occupy the screen entirely.
  - Place a still image on the screen.
- To avoid possible damage to the monitor, do not touch the monitor panel by finger tip, pen, or any other sharp objects.
- Excessively frequent plug and unplug of video connectors may cause damage to the monitor.
- This monitor is designed mainly for personal use. If you want to use the monitor in a public place or a harsh environment, contact your nearest BenQ service center for assistance.
- To avoid possible electric shock, do not disassemble or repair the monitor.
- If a bad smell or an abnormal sound appears to come from the monitor, contact your nearest BenQ service center for assistance immediately.

## Caution

- The distance between you and the monitor should be 2.5 to 3 times the diagonal width of the screen.

- Looking at the screen for an extended period of time causes eye fatigue and may deteriorate your eyesight. Rest your eyes for 5 ~ 10 minutes for every 1 hour of product use.
- Reduce your eye strain by focusing on objects far way.
- Frequent blinking and eye exercise help keep your eyes from drying out.

## Safety notice for remote control (applicable if a remote control is provided)

- Do not put the remote control in the direct heat, humidity, and avoid fire.
- Do not drop the remote control.
- Do not expose the remote control to water or moisture. Failure to do so could result in malfunction.
- Confirm there is no object between the remote control and the remote sensor of the product.
- When the remote control will not be used for an extended period, remove the batteries.

## Battery safety notice (applicable if a remote control is provided)

The use of the wrong type of batteries may cause chemical leaks or explosion. Please note the following:

- Always ensure that the batteries are inserted with the positive and negative terminals in the correct direction as shown in the battery compartment.
- Different types of batteries have different characteristics. Do not mix different types.
- Do not mix old and new batteries. Mixing old and new batteries will shorten battery life or cause chemical leaks from the old batteries.
- When batteries fail to function, replace them immediately.
- Chemicals which leak from batteries may cause skin irritation. If any chemical matter seeps out of the batteries, wipe it up immediately using a dry cloth, and replace the batteries as soon as possible.
- Due to varying storage conditions, the battery life for the batteries included with your product may be shortened. Replace them within 3 months or as soon as you can after initial use.
- There may be local restrictions on the disposal or recycling of batteries. Consult your local regulations or waste disposal provider.

If the supplied remote control contains a coin / button cell battery, pay attention to the following notice as well.

- Do not ingest battery. Chemical Burn Hazard.
- The remote control supplied with this product contains a coin / button cell battery. If the coin / button cell battery is swallowed, it can cause severe internal burns in just 2 hours and can lead to death.
- Keep new and used batteries away from children. If the battery compartment does not close securely, stop using the product and keep it away from children.
- If you think batteries might have been swallowed or placed inside any part of the body, seek immediate medical attention.

## Care and cleaning

- Do not place the monitor face down on the floor or a desk surface directly. Otherwise, scratches on the panel surface may occur.
- The equipment is to be secured to the building structure before operation.
- (For models that support wall or ceiling mounting)
  - Install your monitor and monitor mounting kit on a wall with flat surface.
  - Ensure that the wall material and the standard wall mount bracket (purchased separately) are stable enough to support the weight of the monitor.
  - Turn off the monitor and the power before disconnecting the cables from the LCD monitor.
- Always unplug the product from the power outlet before cleaning. Clean the LCD monitor surface with a lint-free, non-abrasive cloth. Avoid using any liquid, aerosol or glass cleaners.
- Slots and openings on the back or top of the cabinet are for ventilation. They must not be blocked or covered. Your monitor should never be placed near or over a radiator or heat sources, or in a built-in installation unless proper ventilation is provided.
- Do not place heavy loads on the monitor to avoid possible personal injury or damage to the monitor.
- Consider keeping the box and packaging in storage for use in the future when you may need to transport the monitor.
- Refer to the product label for information on model name, power rating, manufacturing date, barcode, serial number, and identification markings. The locations of labels vary by model. See the illustration below for where the labels can be.

Possible label location:

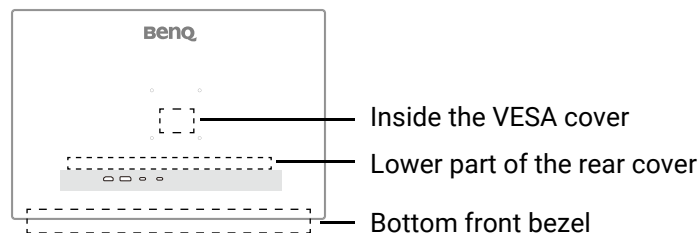

## Servicing

- Do not attempt to service this product yourself, as opening or removing covers may expose you to dangerous voltages or other risks. If any of the above mentioned misuse or other accident such as dropping or mishandling occurs, contact qualified service personnel for servicing.
- For replacement of power cord, connection cables, remote control or power adapter, please contact BenQ customer service.
- Contact your place of purchase or visit the local website from [Support.BenQ.com](https://Support.BenQ.com) for more support.





Support.BenQ.com

# General warranty information

Note that the monitor warranty may be void if any of the following conditions occurs:

- Documents required for warranty services have been altered by unauthorized use or is illegible.
- The model number or production number on the product has been altered, deleted, removed or made illegible.
- Repairs, modifications, or alterations have been made by unauthorized service organizations or persons.
- Damage caused by improper storage of the monitor (including but not limited to force majeure, direct exposure to sunlight, water, or fire).
- Reception problems occurred due to external signals (such as antenna, Cable TV) outside the monitor.
- Defects caused by abuse or misuse of the monitor.
- Before using the monitor, it is the sole responsibility of the user to check whether the monitor is compatible with local technical standards if the user brings the monitor out of its intended sales area. Failure to do so may cause product breakdown and the user will have to pay the repairing costs.
- It is the sole responsibility of the user if problems (such as data loss and system failure) occurred due to non-factory provided software, parts, and/or non-original accessories.
- Please use the original accessories (e.g. power cable) only with the device to avoid possible dangers such as electric shock and fire.

## Typographics

Icon / Symbol	Item	Meaning
	Warning	Information mainly to prevent the damage to components, data, or personal injury caused by misuse and improper operation or behavior.
	Tip	Useful information for completing a task.
	Note	Supplementary information.

In this document, the steps needed to reach a menu may be shown in condensed form, for example: **Menu > System > Information.**

# Table of Contents





Copyright .....	2
Product support .....	4
Firmware upgrade.....	4
Advanced software.....	4
Q&A index .....	5
Safety precautions .....	7
Power safety .....	7
Installation.....	8
Operation .....	8
Safety notice for remote control (applicable if a remote control is provided).....	9
Battery safety notice (applicable if a remote control is provided) .....	9
Care and cleaning .....	10
Servicing .....	10
General warranty information .....	11
Getting started .....	14
Getting to know your monitor .....	16
Front view .....	16
Back view .....	17
Power delivery of USB-C™ ports on your monitor .....	18
Connections .....	19
Getting to know your remote control .....	20
Overview .....	20
Getting the remote control ready.....	21
Assembling your monitor hardware .....	23
How to detach the stand and the base .....	28
Using the monitor wall mounting kit (purchased separately) .....	29
Monitor controls .....	30
The remote control and its effective range.....	30
The control panel .....	30
Menu introduction .....	31
FPS counter.....	31
Hotkey menus .....	31
Quick Menu.....	33
Main menu .....	34
Monitor adjustments .....	35
5-way controller and basic menu operations.....	35
Setting up your monitor for different scenarios.....	36
Switching a scenario.....	37
Customizing the <b>Quick Menu</b> for a scenario.....	37
Adjustable OSD settings.....	38

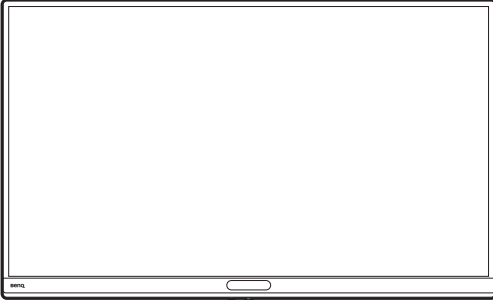
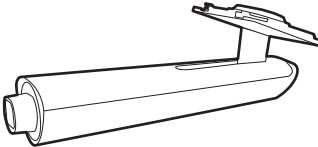
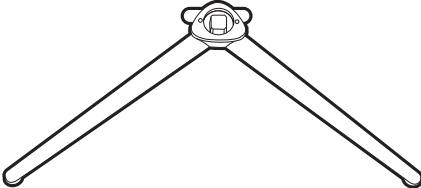

Switching the inputs quickly.....	39
Adjusting screen brightness automatically (Brightness Intelligence Plus) .....	39
Enabling HDR function.....	40
Choosing an audio mode .....	40
Choosing a color mode .....	40
Checking current refresh rate .....	40
Enabling color vision accessibility ( <b>Color Weakness</b> ) .....	41
Initial higher refresh rate for your device .....	41
Sharing a set of keyboard, mouse, and other USB peripherals with KVM.....	41
<b>Navigating the main menu .....</b>	<b>42</b>
<b>Color Mode</b> menu .....	<b>43</b>
Available menu options to each <b>Color Mode</b> .....	<b>47</b>
<b>Eye Care</b> menu .....	<b>49</b>
<b>Audio</b> menu .....	<b>51</b>
<b>Input</b> menu .....	<b>53</b>
<b>Quick Menu</b> .....	<b>55</b>
<b>System</b> menu .....	<b>57</b>
<b>Troubleshooting .....</b>	<b>61</b>
Frequently asked questions (FAQ) .....	<b>61</b>
Need more help? .....	<b>63</b>

# Getting started

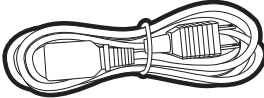
When unpacking please check you have the following items. If any are missing or damaged, please contact the place of purchase for a replacement.

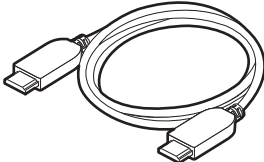
BenQ LCD Monitor	
Monitor Stand	
Monitor Base	
User Documents <ul style="list-style-type: none"><li>• Quick Start Guide</li><li>• Safety Instructions</li><li>• Regulatory Statements</li></ul>	
Power Cord (Supplied item may differ by model or region.)	
Remote Control (RC-0013. Availability of CR2032 battery may vary due to regulations.)	
Video Cable: HDMI	

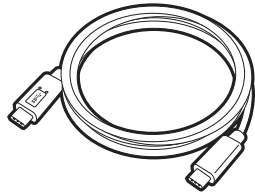
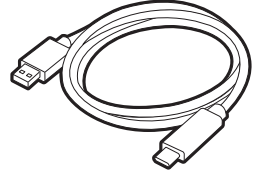
USB Cable: USB-C	
USB Cable: USB-C™ to USB-A	



- Available accessories and the pictures shown here may differ from the actual contents and the product supplied for your region. And the package contents may subject to change without prior notice. For cables that are not supplied with your product, you can purchase them separately.
- Consider keeping the box and packaging in storage for use in the future when you may need to transport the monitor. The fitted foam packing is ideal for protecting the monitor during transport.
- Accessories and cables may be included or sold separately depending on the product supplied for your region.



Always keep the product and accessories out of reach of small children.

# Getting to know your monitor

## Front view

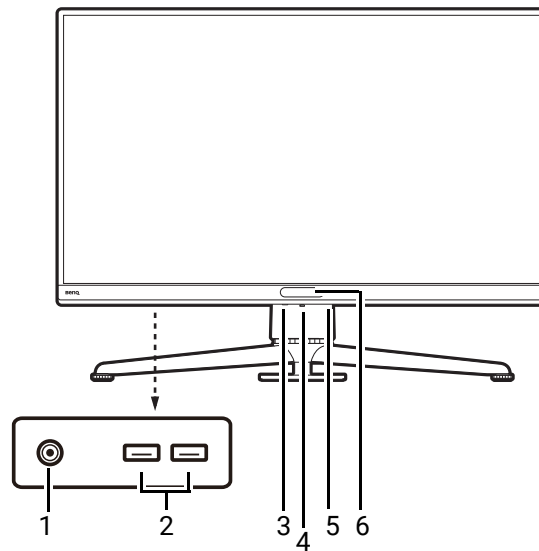

1. Headphone jack
2. USB port (downstream; connecting to USB devices, with 1.5A power supply)
3. Input hotkey
4. 5-way controller
5. Power button / Power LED indicator
6. Light sensor

# Back view

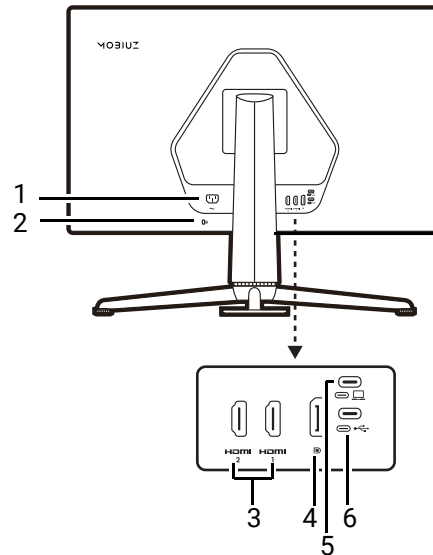

1. Power input jack
2. Kensington lock slot
3. HDMI socket x 2
4. DisplayPort socket
5. USB-C™ port (for video, data transmission and power delivery up to 65W)
6. USB-C™ port (upstream; for data transmission)



- The USB data transmission speed varies according to your selection in [USB-C Configuration on page 59](#).
- Above diagram may vary depending on the model.
- Picture may differ from product supplied for your region.
- (Applicable for products with white case) The case of the product may turn yellow in about 3 years due to the photo-oxidation reactions induced by light. This is a normal phenomenon and should not be considered as manufacturing defect.

## Power delivery of USB-C™ ports on your monitor

With the power delivery function, your monitor helps supply power to the connected USB-C™ devices. Available power varies by port. Make sure the devices are connected to the appropriate ports to be activated properly with sufficient power.

EX271Q
USB-C™ 65W
5V / 3A
9V / 3A
12V / 3A
15V / 3A
20V / 3.25A

- A connected device needs to be equipped with a USB-C™ connector that supports charging function via USB power delivery.
- The connected device can be charged via USB-C™ port even when the monitor is in power saving mode.(\*)
- The USB power delivery is up to 65W. If the connected device requires more than the delivered power for operation or for boot up (when the battery is drained), use the original power adapter that came with the device.

The information is based on the standard testing criteria and is provided for reference. The compatibility is not guaranteed as the user environments vary. If a separately purchased USB-C™ cable is used, make sure the cable is certified by USB-IF and is full-featured, with power delivery and video / audio / data transmission functions.



\*: Charging via USB-C™ in monitor power saving mode is available when the **USB-C Awake** function is enabled. Go to **System > USB-C Awake** and select **ON**.

---

# Connections

The following connection illustrations are for your reference only. For cables that are not supplied with your product, you can purchase them separately.



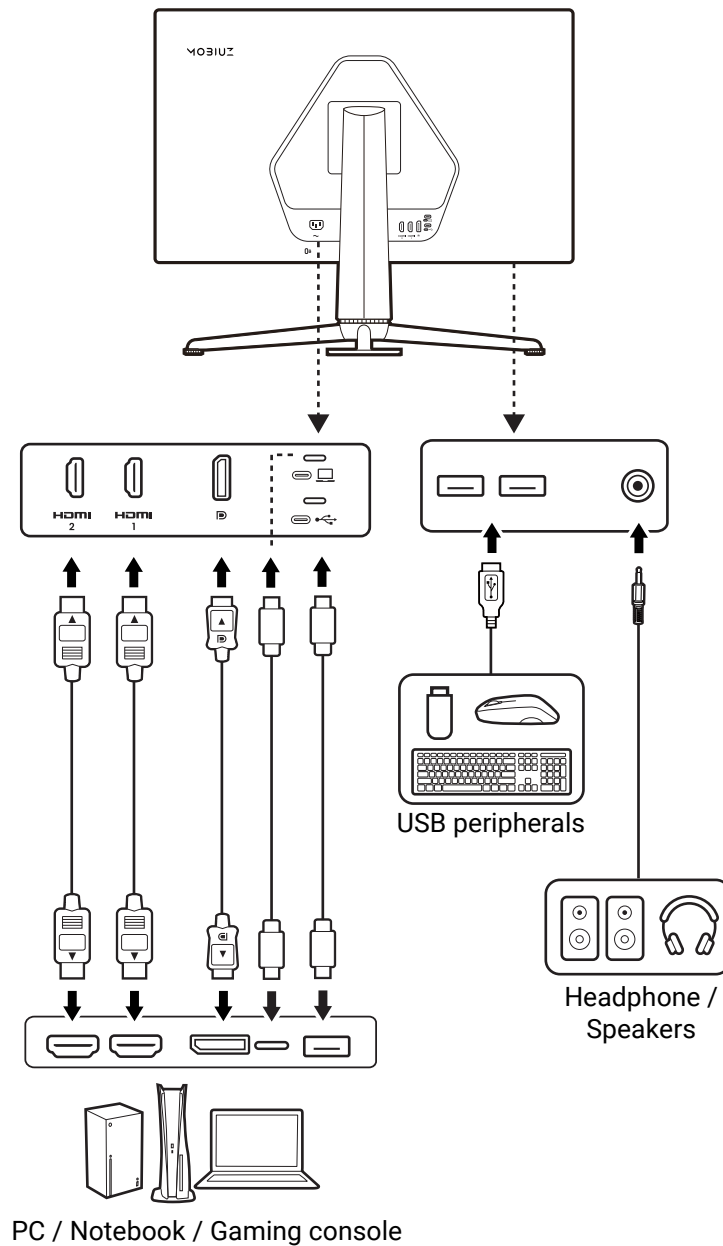



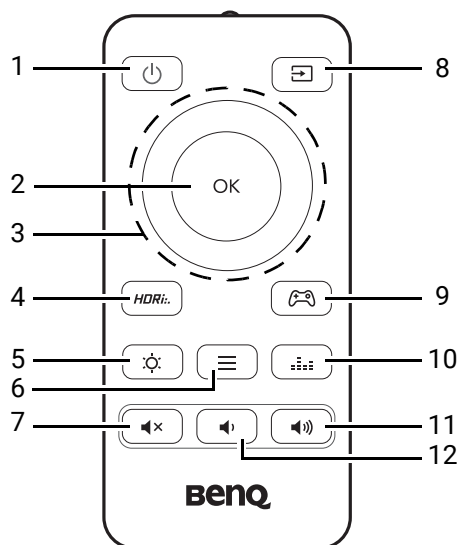

For detailed connection methods, see page [24](#) - [25](#).









# Getting to know your remote control

## Overview



No.	Name	Key	Description
1	Power key		Turns the power on or off.
2	OK key		<ul style="list-style-type: none"> <li>Activates the <b>Quick Menu</b>. See <a href="#">Quick Menu on page 33</a> for more information.</li> <li>Confirms the selection.</li> </ul>
3	Navigation keys		<ul style="list-style-type: none"> <li>Activates the volume menu.</li> <li>Goes to the previous menu item.</li> <li>For up / increase adjustment</li> </ul>
			Activates the <b>Quick Menu</b> . See <a href="#">Quick Menu on page 33</a> for more information.
			<ul style="list-style-type: none"> <li>Activates the volume menu.</li> <li>Goes to the next menu item.</li> <li>For down / decrease adjustment.</li> </ul>
			<ul style="list-style-type: none"> <li>Activates the <b>Quick Menu</b>. See <a href="#">Quick Menu on page 33</a> for more information.</li> <li>Returns to the previous menu.</li> <li>Exits OSD menu.</li> </ul>
4	<b>HDR Mode</b> key		Accesses a list of HDR options. Press repeatedly to cycle through these options. See <a href="#">Game mode/HDR mode menu on page 32</a> for more information.
5	<b>Brightness</b> key		Adjusts the brightness.



No.	Name	Key	Description
6	Menu key		Activates the main menu. See <a href="#">Navigating the main menu on page 42</a> for more information.
7	Mute key		Mutes / unmutes the volume.
8	Input source key		Accesses a list of available input sources. Press repeatedly to cycle through these options.
9	<b>Game Mode</b> key		Accesses a list of <b>Game Mode</b> options. Press repeatedly to cycle through these options. See <a href="#">Color Mode on page 43</a> for more information.
10	<b>Audio Mode</b> key		Accesses a list of <b>Audio Mode</b> options. Press repeatedly to cycle through these options. See <a href="#">Audio mode on page 51</a> for more information.
11	Volume up key		Increases the volume of the connected CEC audio device.
12	Volume down key		Decreases the volume.



OSD = On Screen Display.

## Getting the remote control ready

Make sure a battery has been installed properly before use. Availability of remote control battery may vary due to regional regulations and may not be included in the package.

### Removing battery insulation sheet (if a battery is included)

Turn over the remote control. Remove the battery insulation sheet. The remote control is ready to use now.

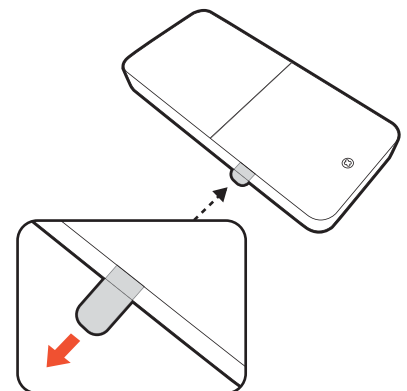

## Installing the remote control battery (if a battery is not included or drained out)

Prepare a CR2032 battery for the remote control.

1. Turn over the remote control. Use a cross-pointed screwdriver to release the screw that fixing the cover to the remote control, and then detach the cover as illustrated. The use of a magnetic-head screwdriver is recommended to avoid of losing the screw.

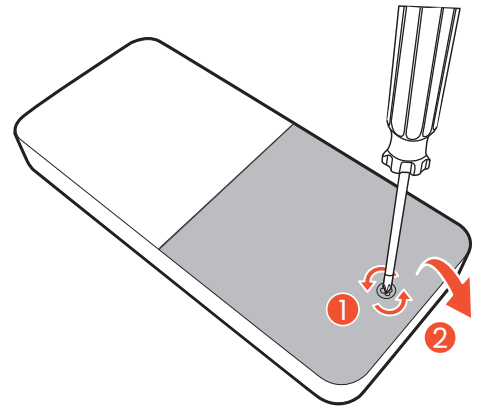

2. Install a new battery (CR2032) onto the battery holder properly. Make sure that the positive terminal (+) faces upward.

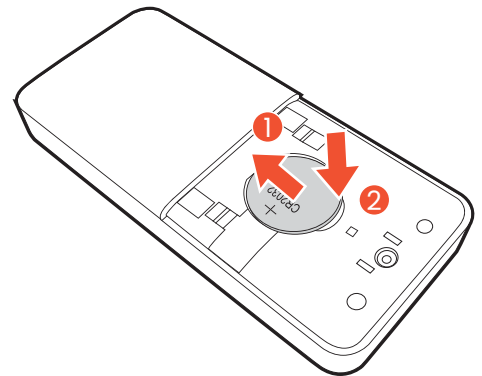

3. Replace the battery cover and secure the screw. The remote control is ready to use now.

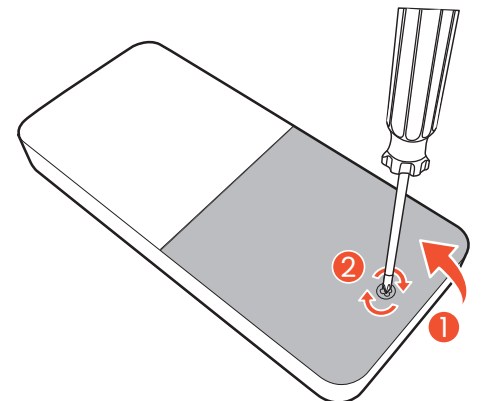

- 
- Keep the remote control and the battery out of reach of children.
  - The remote control supplied with this product uses a coin / button cell battery. If the coin / button cell battery is swallowed, it can cause severe internal burns in just 2 hours and can lead to death.
  - If the remote control will not be used for an extended period of time, remove the battery.
-

# Assembling your monitor hardware

- If the computer is turned on you must turn it off before continuing. Do not plug-in or turn-on the power to the monitor until instructed to do so.
- The following illustrations are for your reference only. The packaging, the location and available input and output jacks may vary depending on the purchased model.
- The supported timing may vary by input signal. Download **Resolution file** from the website (see [Product support on page 4](#)). Refer to "**Preset display modes**" in Resolution file for more information.
- Avoid finger pressure on the screen surface.



Be careful when handling the sharp monitor base and protect yourself from any physical harm.



Never stand your monitor on a desk or floor without its stand arm and base. The controls on the bottom of the front bezel are not designed to hold the weight of the monitor and may be damaged.

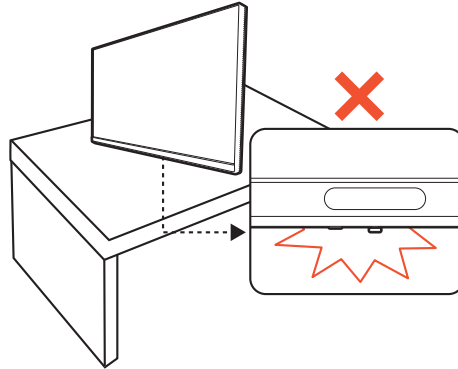

## 1. Attach the monitor base.



Please be careful to prevent damage to the monitor. Placing the screen surface on an object like a stapler or a mouse will crack the glass or damage the LCD substrate voiding your warranty. Sliding or scraping the monitor around on your desk will scratch or damage the monitor surround and controls.

Open the box, remove the cushion that protects the back of the monitor. And take out the monitor stand and base. Packaging may differ by model.

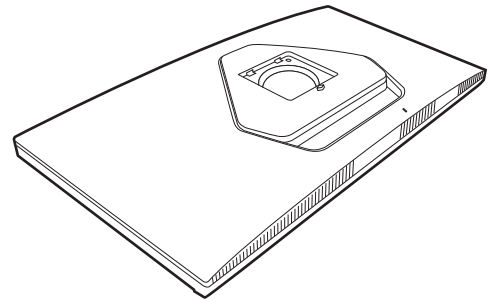

Attach the monitor stand to the monitor base as illustrated.

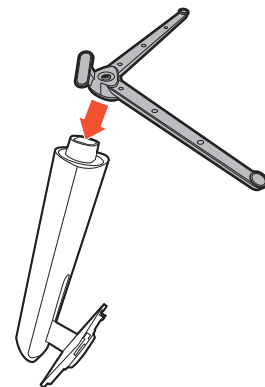

Raise the thumbscrew lid and tighten the thumbscrew as illustrated. Then push the lid back.

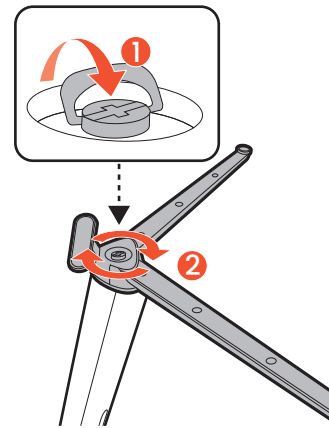

Orient and align the stand arm with the monitor, then push them together until they click and lock into place.

Carefully lift the monitor, turn it over and place it upright on its stand on a flat even surface.

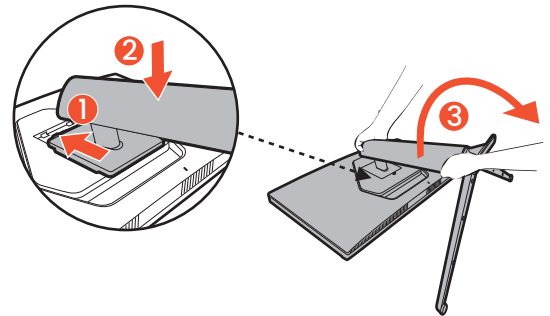

## 2. Connect the video cable.



The video cables included in your package and the socket illustrations in this document may vary depending on the product supplied for your region.

1. Establish a video cable connection. Connect the monitor to your video source(s) via HDMI/DP/USB-C™ cable(s) as illustrated.

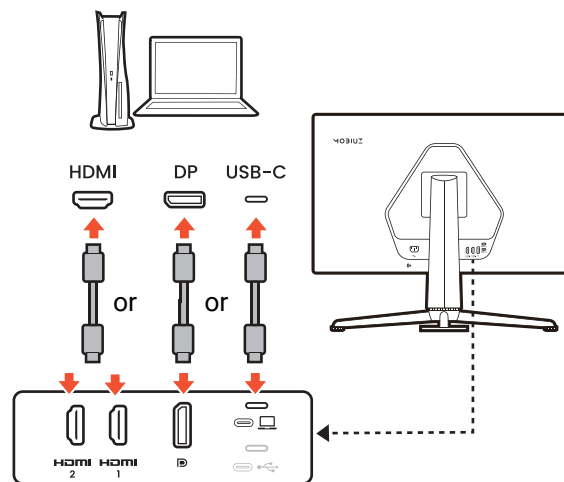

### 3. Connect the audio cable.

You may connect headphones/speakers to the headphone jack found on the bottom of the monitor.

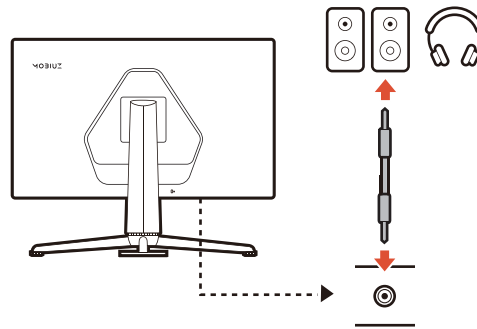

### 4. Connect USB devices.

1. Connect the USB cable between the PC and the monitor (via the upstream USB port at the back). This upstream USB port transmits data between the PC and the USB devices connected to the monitor.
2. Connect USB devices via other USB ports (downstream) on the monitor. These downstream USB ports transmit data between connected USB devices and the upstream port.

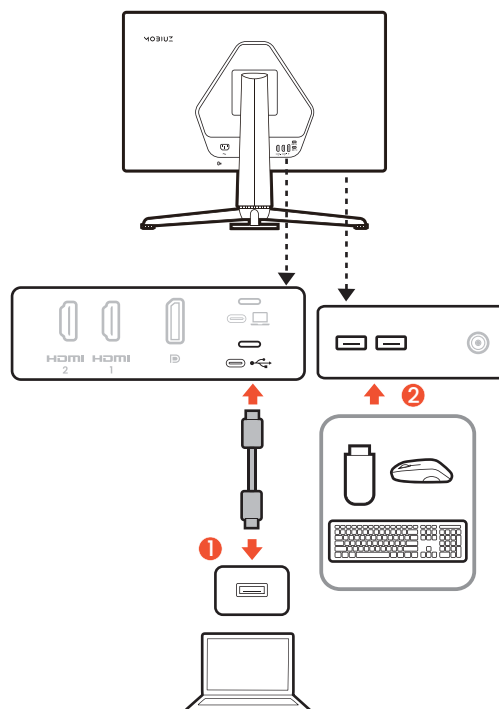

## 5. Place the monitor properly.

Place the monitor as desired after the cables have been connected properly. Move the monitor carefully by holding the lower part of monitor, the base or the stand arm.

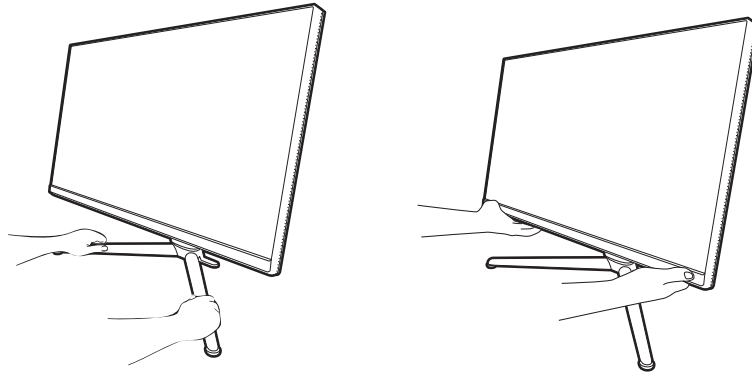

Finger pressure on the screen surface is prohibited. The screen may be damaged by excessive force.



## 6. Adjust the viewing angle.

You may position the screen to the desired angle with monitor tilt, swivel, and height adjustment functions. Check the product specifications on the website for details.

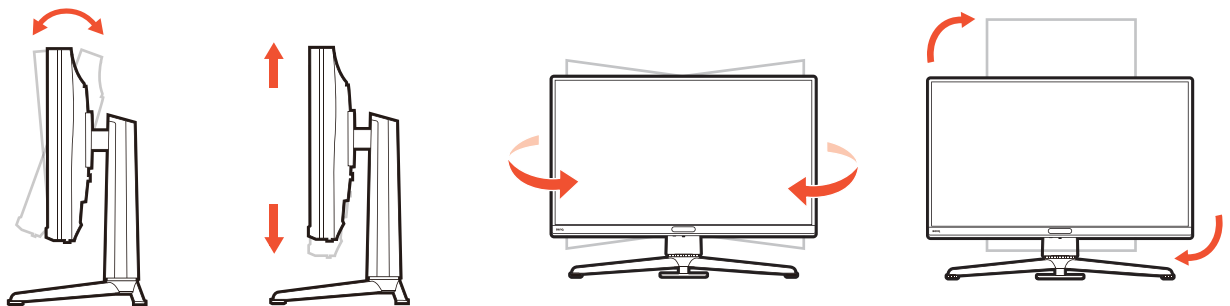

Your monitor is an edge-to-edge monitor and should be handled with care. Avoid finger pressure on the screen surface. Excessive force on the display is prohibited.

## 7. Connect to power.

Connect the power cord to the monitor and a power outlet.

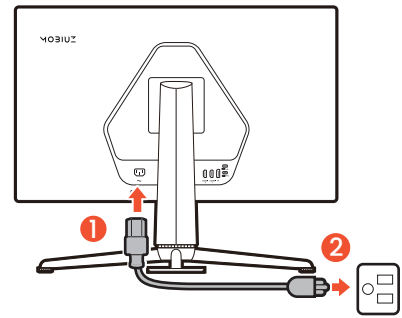

## 8. Turn-on the power.

Turn on the computer too. If you have multiple video sources, press the Input key and the 5-way controller to select an input source.



To extend the service life of the product, we recommend that you use your computer's power management function.

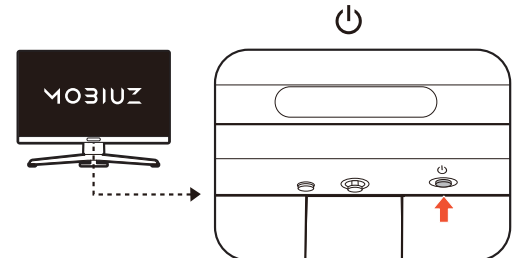

## 9. Setting up the monitor ready for gaming.

You are prompted to start the monitor with three color modes that are tailored to distinct game arts styles. Press the 5-way controller to proceed. Proceed to set a color mode for the current input or navigate the menu for other settings. See [5-way controller and basic menu operations on page 35](#) for details.

You can set the monitor to work in specific scenarios with preferred set of settings. See [Setting up your monitor for different scenarios on page 36](#) to complete the configuration.

# How to detach the stand and the base

## 1. Power off the monitor.

Turn off the monitor and the power before unplugging the power cable. Turn off the computer before unplugging the monitor signal cable.

## 2. Prepare the monitor and area.

Lay the screen face down on a clean and well-padded surface. Or put the monitor back to the box that used to ship the product in the first place.



Please be careful to prevent damage to the monitor. Placing the screen surface on an object like a stapler or a mouse will crack the glass or damage the LCD substrate voiding your warranty. Sliding or scraping the monitor around on your desk will scratch or damage the monitor surround and controls.

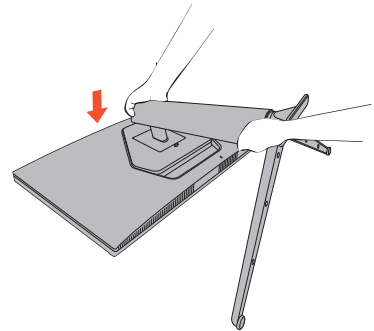

## 3. Remove the monitor stand.

While pressing and holding the VESA mount release button (1), detach the stand from the monitor (2) and (3).

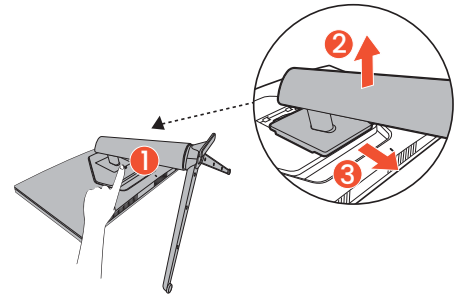

## 4. Remove the monitor base.

Release the screw on the bottom of the monitor base and detach the monitor base as illustrated.



In case you intend to use your monitor on the stand in the future, please keep the monitor base and monitor stand somewhere safe for future use.

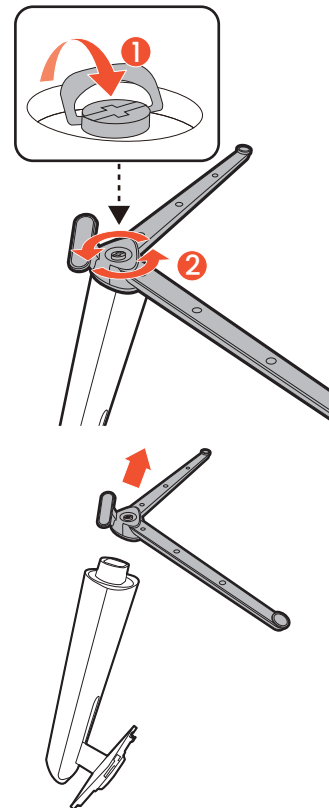



# Using the monitor wall mounting kit (purchased separately)

The back of your LCD monitor has a VESA standard mount with 100mm pattern, allowing the installation of a wall mount bracket. Before starting to install a monitor wall mounting kit, please read the precautions carefully.

## Precautions

- Install your monitor and monitor mounting kit on a wall with flat surface.
- Ensure that the wall material and the standard wall mount bracket (purchased separately) are stable enough to support the weight of the monitor. Refer to the product specifications on the website for weight information.
- Turn off the monitor and the power before disconnecting the cables from the LCD monitor.

### 1. Remove the monitor stand.

Detach the monitor stand as instructed in [How to detach the stand and the base on page 28](#).

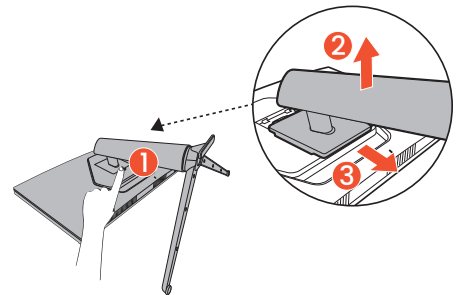

### 2. Remove the screws on the back cover.

Use a cross-pointed screwdriver to release the screws on the back cover. The use of a magnetic-head screwdriver is recommended to avoid losing the screws.

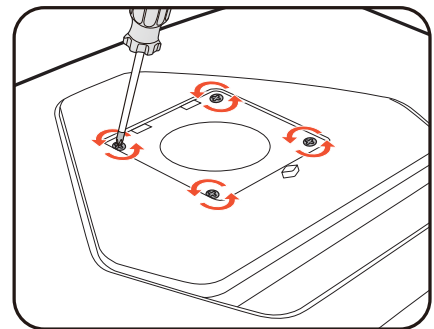

### 3. Follow the instruction manuals of the wall mount bracket you purchased to complete the installation.



Use four M4 x 10 mm screws to fix a VESA standard wall mount bracket to the monitor. Make sure that all screws are tightened and secured properly. Consult a professional technician or BenQ service for wall mount installation and safety precautions.

# Monitor controls

## The remote control and its effective range

1. Follow the instructions in [Getting the remote control ready on page 21](#) to get the remote control ready.
2. Aim the remote control at the monitor. The IR remote control sensor is located at the front of the monitor with a range of 6 meters approximately at an angle of 30 degrees (left and right) and 30 degrees (up and down). Make sure that there are not obstacles between the remote control and the IR sensor on the monitor.
3. To operate with the remote control, see [Getting to know your remote control on page 20](#) for more information.

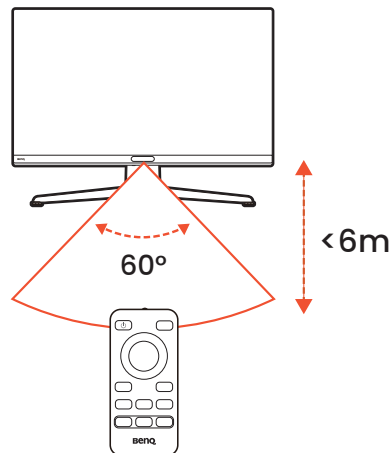

## The control panel

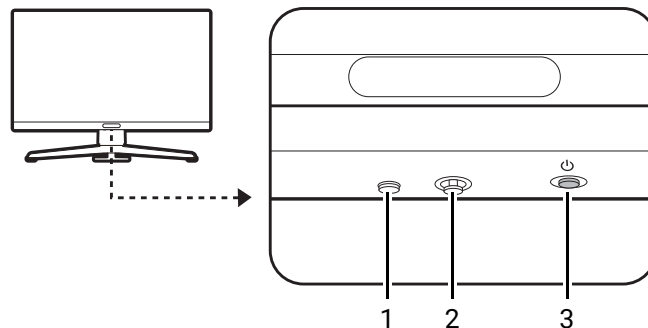

No.	Name	Description
1	Input key	Accesses video source selection menu.
2	5-way controller	Accesses the functions or menu items as instructed by the on-screen icons. See <a href="#">5-way controller and basic menu operations on page 35</a> for more information.
3	Power key	Turns the power on or off.

# Menu introduction

## FPS counter

FPS counter shows the current refresh rate. It changes with the video input from console/computer in real-time.

If enabled, FPS counter is displayed on the upper-right corner of the screen. See [Checking current refresh rate on page 40](#).

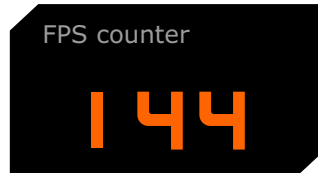

## Hotkey menus

Press a hotkey to bring up the corresponding menu.

### Volume menu

Press  /  to bring up the volume menu.

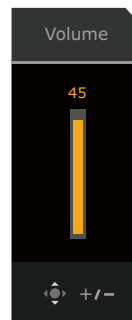

## Audio mode menu



Available to an audio output device connected to 3.5mm headphone jack.

Press  on the remote control to bring up a list of **Audio mode** options. See [Audio mode on page 51](#) for more information.

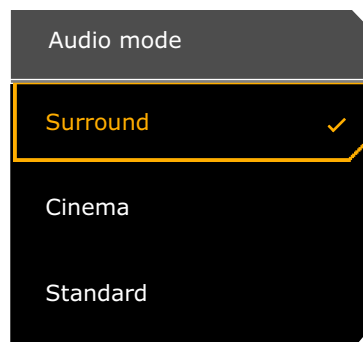

## Input selection menu

Press the Input key on the monitor or the  key on the remote control to bring up input selection menu.

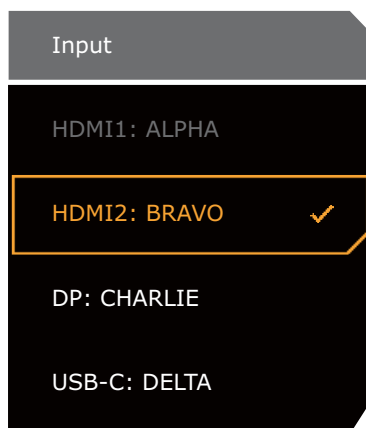

## Game mode/HDR mode menu

Press the game mode key () on the remote control to bring up a list of game mode options. See [Color Mode on page 43](#) for more information.

If the content is HDR-compatible, press the **HDRi** key () on the remote control to bring up a list of HDR options.

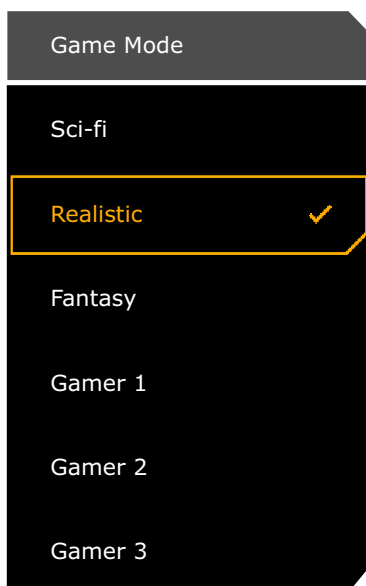

Game modes for SDR content



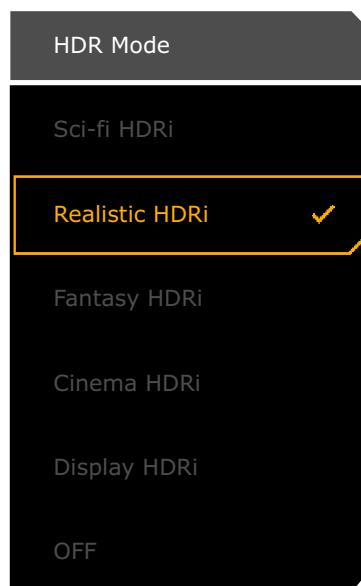





Color modes for HDR content

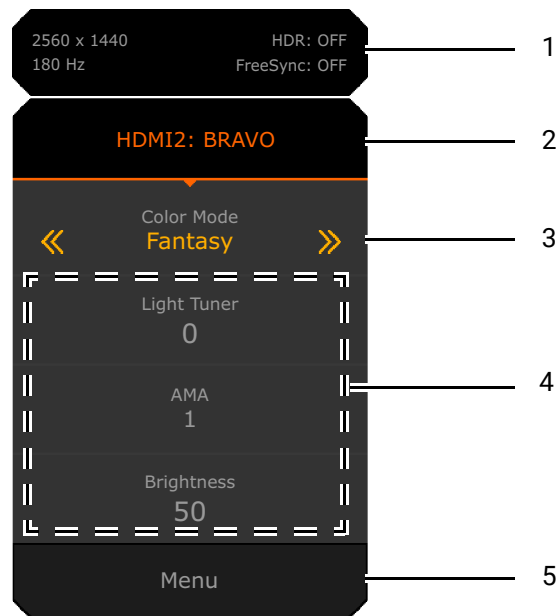

# Quick Menu



Press  /  /  to bring up the **Quick Menu**.



No.	Item	Description
1	System information	Displays current system information, including resolution, refresh rate, HDR status, and Adaptive-Sync status. See <a href="#">Activating the FreeSync™ function on page 40</a> for more information on Adaptive-Sync status.
2	Input source and the preset scenario	Displays the current video source / scenario. Press  /  to cycle through all scenarios. See <a href="#">Setting up your monitor for different scenarios on page 36</a> for more information.
3	Color mode	Press  /  to cycle through the available color modes. See <a href="#">Color Mode on page 43</a> for more information.
4	Quick settings	Press  /  to make adjustments. The default setting menus vary by scenario and may not be adjustable on certain color modes. See <a href="#">Available menu options to each Color Mode on page 47</a> for available options on each color mode. To customize the setting menus that can be accessed from the <b>Quick Menu</b> , see <a href="#">Customizing the Quick Menu for a scenario on page 37</a> .
5	Main menu	Accesses the main menu. See <a href="#">Main menu on page 34</a> for more information.

# Main menu

Access the main menu to adjust all the settings on your monitor

- Press the menu key (☰) on the remote control to bring up the main menu.
- Press  /  /  for the **Quick Menu > Menu**.

See [Navigating the main menu on page 42](#) for more information.

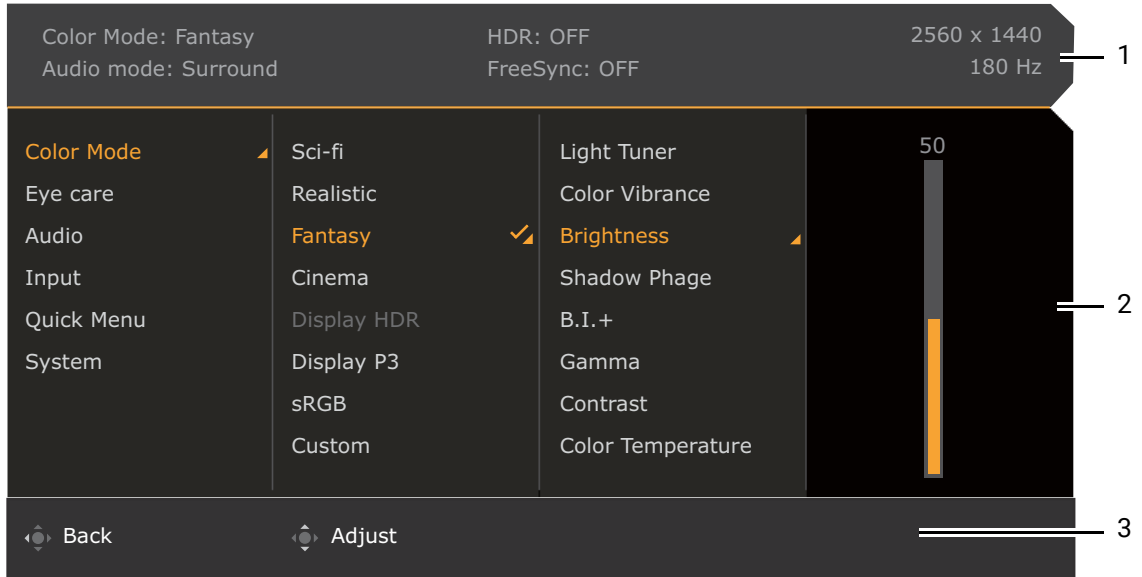

No.	Item	Description
1	System information	Displays current system information, including input source, scenario, audio output, and color mode.
2	Menus and options	Displays menus and options.
3	Operation tips	Displays operations that can be done by 5-way controller or navigation keys on the remote control.





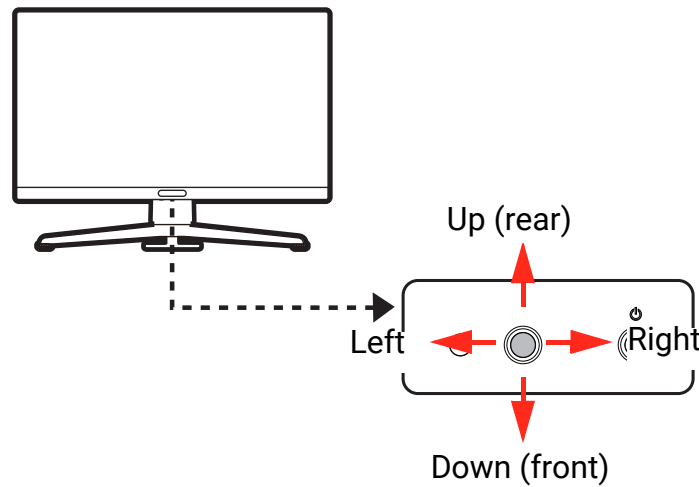

# Monitor adjustments

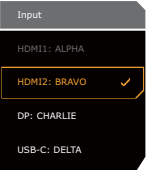
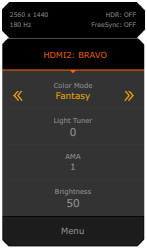
## 5-way controller and basic menu operations

The 5-way controller is located below the lower part of the front bezel. While sitting in front of the monitor, move the controller to the directions instructed by the on-screen icons for menu navigation and operations.





OSD icon	5-way controller operation	Function
(With an available video input but no menu has been activated)		
N/A	Press center or move to the right / left	Activates the <b>Quick Menu</b> .
N/A	Move up / down	Activates the volume menu.
(When the video source selection menu has been activated)		
	Move up / down	Switches to the desired input source.
(When the <b>Quick Menu</b> has been activated)		
	Move up / down	Goes to the previous / next menu setting.
	Move to the right / left	<ul style="list-style-type: none"> <li>Goes to the next / previous menu item.</li> <li>(When <b>Menu</b> is highlighted) Move to the left to close the <b>Quick Menu</b>; move to the right to access the main menu.</li> </ul>
	Press center	<ul style="list-style-type: none"> <li>Closes the <b>Quick Menu</b>.</li> <li>(When <b>Menu</b> is highlighted) Accesses the main menu.</li> </ul>
(When the volume menu has been activated)		

OSD icon	5-way controller operation	Function
	Move up / down	Adjusts volume.
(When the main menu has been activated)		
	Press center	Confirms the selection.
	Move to the right	<ul style="list-style-type: none"> <li>• Enters sub menus.</li> <li>• Confirms the selection.</li> </ul>
	Move up	<ul style="list-style-type: none"> <li>• Goes to the previous menu item.</li> <li>• For up / increase adjustment.</li> </ul>
	Move down	<ul style="list-style-type: none"> <li>• Goes to the next menu item.</li> <li>• For down / decrease adjustment.</li> </ul>
	Move to the left	<ul style="list-style-type: none"> <li>• Returns to the previous menu.</li> <li>• Exits OSD menu.</li> </ul>

## Setting up your monitor for different scenarios

Your monitor may be used to connect with multiple devices for various game types and tasks. In such case, different settings may be required to best suit the media content. Save a set of preferred settings as a scenario and apply to a specific input or content.

The scenario changes with the input source by default. When the **Quick Menu** is launched by pressing  /  / , you can change the scenario for the current input or adjust certain settings from the **Quick Menu**. The scenario mapping is updated accordingly.

[Switching a scenario on page 37](#)

[Customizing the Quick Menu for a scenario on page 37](#)



To find out settings that can be saved and applied by scenario, see [Adjustable OSD settings on page 38](#).

You can save up to 4 scenarios. Feel free to do the following:

A. Keep consistent settings (i.e., same scenario) for the same content across different devices.

[Switching the inputs quickly on page 39](#)

B. Apply different sets of settings (i.e., different scenarios) for various content from the same device.

[Switching a scenario on page 37](#)



## Scenario mapping example

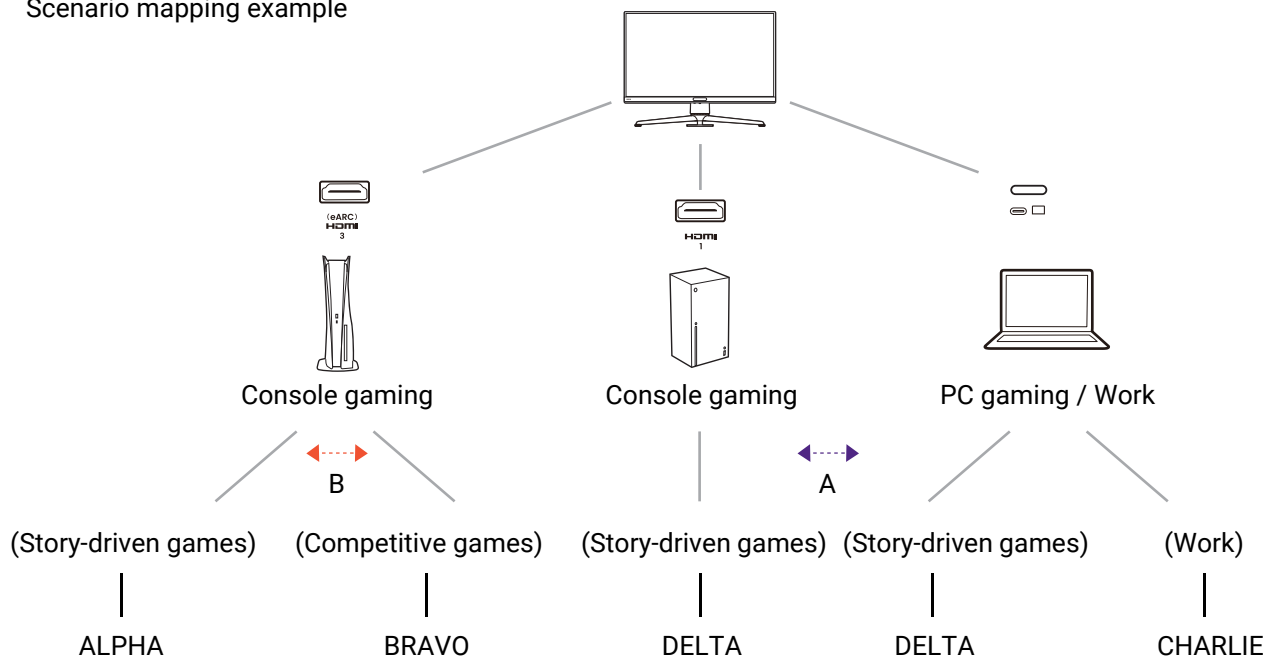

## Switching a scenario

1. Press / / to bring up the **Quick Menu**.
2. When the scenario name is selected, press / to change the scenario for the current input/content. Next time when the same input is selected, the selected scenario will be applied.

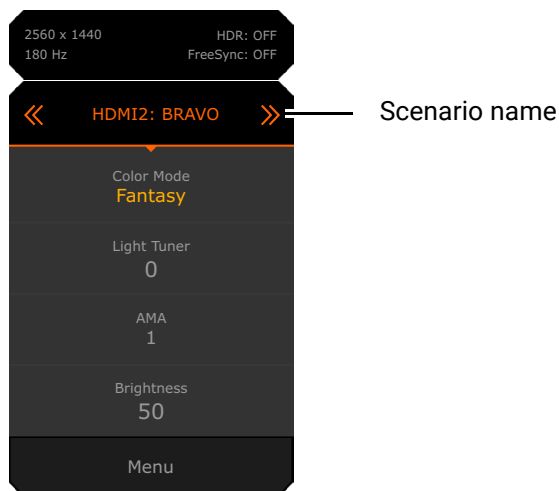





Alternatively, go to **Menu > Input** to preset the scenario that changes with each input. The scenario mapping will be updated whenever it is changed from the **Quick Menu** though.

## Customizing the **Quick Menu** for a scenario

By default, there are 3 quick settings that could be customized to go with each scenario on the **Quick Menu**. Change the setting items if desired.

1. Press / / to bring up the **Quick Menu**.
2. Go to **Menu > Quick Menu**.

3. Select a scenario and press  for further selection.
4. Select one available item and press  for further selection.
5. Scroll to one item and press  /  for confirmation. A setting menu is grayed out on the **Quick Menu** if the it is not supported by a color mode.

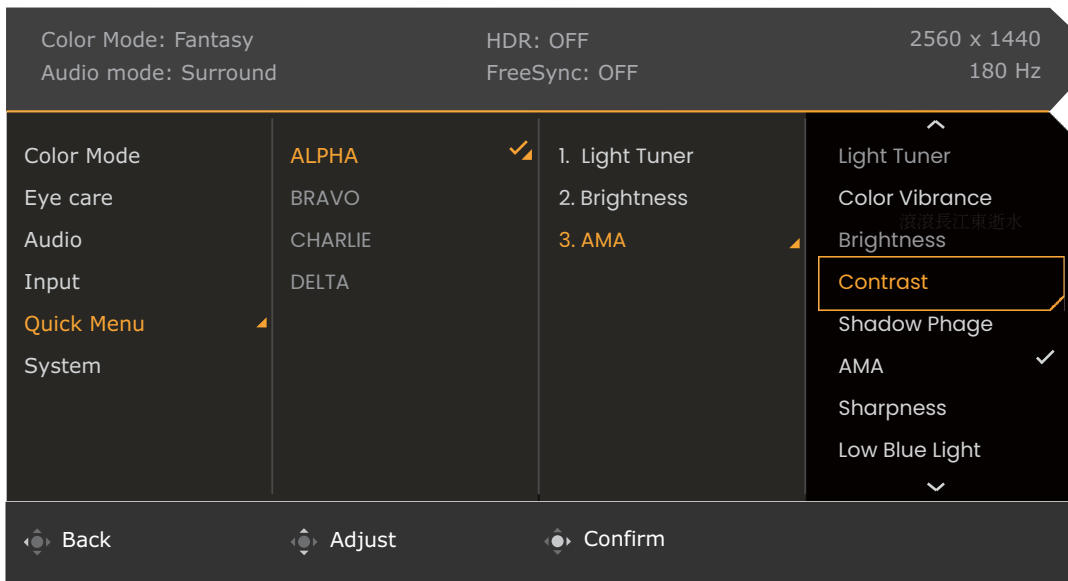

## Adjustable OSD settings

While some settings (e.g., OSD language) are changed and take effect immediately regardless of other monitor settings or input, most OSD settings can be adjusted and saved to go with inputs, color modes, or scenarios. As an input, a color mode, or a scenario is selected, the desired settings are applied.

Items	Description
<b>Display Mode</b>	Saved and applied by input switch.
<b>Overscan</b>	
<b>RGB PC Range</b>	
<b>4K Compatible</b>	
<b>Color Mode</b> (All except Gamer 1/2/3)	Saved and applied by scenario switch.
<b>Low Blue Light</b>	
<b>Color Weakness</b>	
<b>Audio mode</b>	
<b>Volume</b>	

Items	Description
<b>Light Tuner</b>	Saved and applied by scenario and color mode switch.
<b>Color Vibrance</b>	
<b>Shadow Phage</b>	
<b>Brightness</b>	
<b>Contrast</b>	
<b>Gamma</b>	
<b>Color Temperature</b>	
<b>AMA</b>	
<b>Blur Reduction</b>	
<b>Sharpness</b>	
<b>B.I.+</b>	
<b>Backlight Control</b>	

## Switching the inputs quickly

Press the Input key on the monitor or the  key on the remote control repeatedly to cycle through available video sources.



Each source is preset for a scenario. The scenario changes with the input source. You can change the setting from the **Quick Menu** or **Menu > Input** as desired.

## Adjusting screen brightness automatically (Brightness Intelligence Plus)



The Brightness Intelligence Plus function works with certain picture modes (color modes) only. If it is not available, its menu options will become grayed out.

The built-in light sensor works with Brightness Intelligence Plus technology to detect the ambient light, image brightness and contrast, and then balance the screen automatically. It helps keep image details as well as to reduce eye strain.

1. Press  /  /  to bring up the **Quick Menu**.
1. Go to **Menu**.
2. Go to **Color Mode > a mode > B.I.+ (Brightness Intelligence Plus) > ON**. It takes a few seconds to complete the adjustment.



The performance of Brightness Intelligence Plus may be impacted by the light sources and the monitor tilt angle. You can increase the light sensor sensitivity from **Eye Care > B.I.+ > Sensor Sensitivity** when **B.I.+** is enabled. See [Sensor Sensitivity on page 49](#) for more information.



## Enabling HDR function

To enable HDR function, make sure the source device, video cable, and media content are HDR-compatible.

When the input content is HDR-compatible, the OSD message **HDR: On** is displayed on the screen. The HDR function is properly enabled.

You can switch color modes as desired. In this case, all the available options under **Color Mode** support HDR content. Each HDR mode comes with certain default screen settings that are adjustable. Refer to [Available menu options to each Color Mode on page 47](#) for available menu options.



## Choosing an audio mode

1. Press  /  /  to bring up the **Quick Menu**.
2. Go to **Menu > Audio > Audio mode**.
3. Select one audio equalizer from the list. See [Audio mode on page 51](#) for more information.

The selected audio mode goes with current scenario. Switch the scenario and the preset audio mode is applied as well.

## Choosing a color mode

Your monitor comes with three color modes: **Sci-fi**, **Fantasy**, and **Realistic**, tailored to distinct game art styles to enhance in-game ambiance. See [Color Mode on page 43](#) for all the available options.

1. Press  /  /  to bring up the **Quick Menu**.
2. Go to **Menu > Color Mode** for a desired color mode.
3. Under each mode, adjust and save the settings to suit your needs.





- Download **Color Shuttle** from [www.BenQ.com](http://www.BenQ.com) to share game mode settings and manage color modes for game titles. See [Product support on page 4](#) for the access to the software.
- (When HDR content is available) Press the **HDRi** key () on the remote control for a list of color modes that support HDR content. Press the same key repeatedly to cycle through the options to the desired one.

## Checking current refresh rate



Refresh rate is displayed on FPS counter.

If you prefer to keep updated with the refresh rate, you can choose to show FPS counter all the time on the upper-right corner of the screen.

1. Press  /  /  to bring up the **Quick Menu**.
2. Go to **Menu > System > FPS Counter > ON**. See [FPS Counter on page 58](#) for options.

## Enabling color vision accessibility (**Color Weakness**)

**Color Weakness** is accessibility that helps people with color vision deficiency to distinguish colors. You are provided with **Red Filter** and **Green Filter** on this monitor. Choose one as needed.

1. Press  /  /  to bring up the **Quick Menu**.
2. Go to **Menu > Eye Care > Color Weakness**.
3. Choose either **Red Filter** or **Green Filter**.
4. Adjust the value of the filter. A stronger effect is produced as the value increases.

## Initial higher refresh rate for your device

You can set the monitor to a higher refresh rate to enhance your gaming experience.



Available timings vary by model and input source. Download **Resolution file** from the website (see [Product support on page 4](#)). Refer to "**Preset display modes**" in **Resolution file** for more information.

1. Set the monitor to a higher refresh rate. Go to the display settings of your device and look for refresh rate option. Set it to the featured maximum refresh rate.
2. Go to the setup menu in your game, and change the frame rate or refresh rate.
3. Check if the refresh rate has been changed from your monitor. See [Checking current refresh rate on page 40](#).



- If the featured maximum refresh rate is not available on your menus, check the following:
  - make sure the HDMI cable or DisplayPort cable is properly connected to your computer and the monitor.
  - make sure your device supports the monitor-featured maximum refresh rate.
  - make sure your game supports the monitor-featured maximum refresh rate.
- Procedures to adjust refresh rate vary by device/game. Refer to the Help document that came with your device and game for details.

## Sharing a set of keyboard, mouse, and other USB peripherals with KVM



You can shift the control devices (i.e., keyboard and mouse) and other USB peripherals among multiple video sources through KVM.

With appropriate connections, the display is switched to the available inputs while the keyboard and mouse control is switched as well.

1. Connect at least 2 video sources to the monitor. Make USB-C™ connection properly. See [Connect the video cable. on page 24](#) for reference.
2. Make HDMI or DP connection properly.
  - HDMI and USB upstream connections
  - DisplayPort and USB upstream connections
3. Connect the control devices and other USB peripherals to the USB ports on the monitor.
4. After multiple sets of connections are made properly, the **KVM** function is enabled automatically. You can switch the display and control by the  key on the remote control.

# Navigating the main menu

You can use the OSD (On Screen Display) menu to adjust all the settings on your monitor.

Press  /  /  to bring up the **Quick Menu** and select **Menu** to access the main menu. See [5-way controller and basic menu operations on page 35](#) for details.

Available menu options may vary depending on the input sources, functions and settings. Menu options that are not available will become grayed out. And keys that are not available will be disabled and the corresponding OSD icons will disappear. For models without certain functions, their settings and related items will not appear on the menu.



The OSD menu languages may differ from the product supplied to your region, see [Language on page 58](#) under **System** and **OSD Settings** for more details.

---

For more information on each menu, please refer to the following pages:

- [Color Mode menu on page 43](#)
- [Eye Care menu on page 49](#)
- [Audio menu on page 51](#)
- [Input menu on page 53](#)
- [Quick Menu on page 55](#)
- [System menu on page 57](#)

## Color Mode menu

Available menu options may vary depending on the input sources, functions and settings. Menu options that are not available will become grayed out. And keys that are not available will be disabled and the corresponding OSD icons will disappear. For models without certain functions, their settings and related items will not appear on the menu.

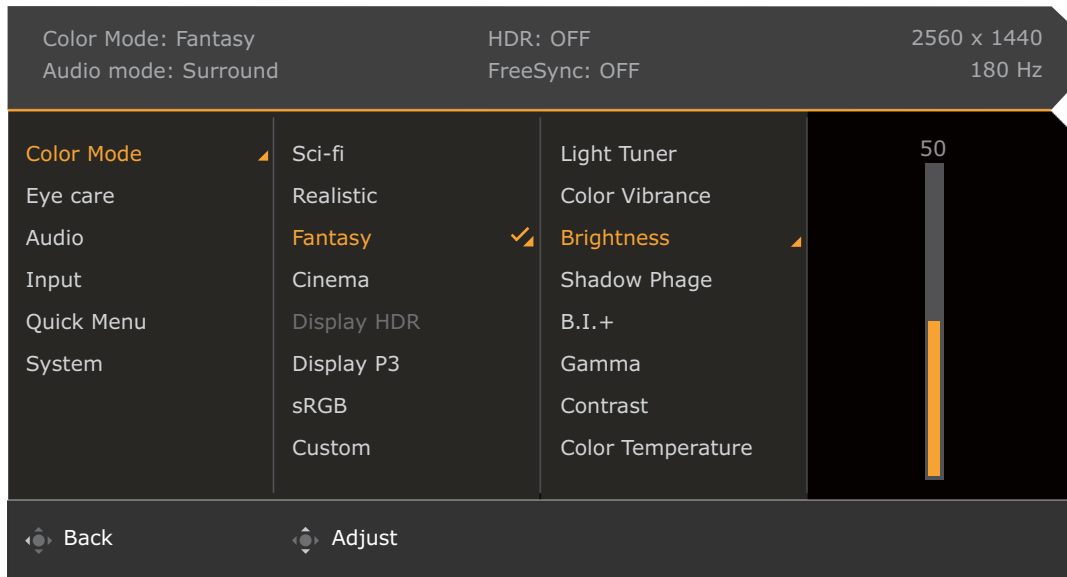

1. Press / / to bring up the **Quick Menu**.
2. Select **Menu** from the **Quick Menu**.
3. Use or to select **Color Mode**.
4. Select to go to a sub menu, and then use or to select a menu item.
5. Use or to make adjustments, or use to make selection.
6. To return to the previous menu, select .
7. To exit the menu, select .

Item	Function	Range
<b>Color Mode</b>	Select a color mode that best suits the type of images shown on the screen. You can adjust the selected mode as desired. Available menu options may vary depending on the input sources, functions and settings.	

Item	Function		Range
	<b>Sci-fi</b>	Enhances metallic texture, encompassing a futuristic atmosphere.	<ul style="list-style-type: none"> <li>• <a href="#">Light Tuner</a></li> <li>• <a href="#">Color Vibrance</a></li> <li>• <a href="#">Brightness</a></li> <li>• <a href="#">Shadow Phage</a></li> <li>• <a href="#">B.I.+</a></li> <li>• <a href="#">Gamma</a></li> <li>• <a href="#">Contrast</a></li> <li>• <a href="#">Color Temperature</a></li> <li>• <a href="#">AMA</a></li> <li>• <a href="#">Blur Reduction</a></li> <li>• <a href="#">Sharpness</a></li> <li>• <a href="#">Backlight Control</a></li> <li>• <a href="#">Save As</a></li> <li>• <a href="#">Reset Color</a></li> </ul>
	<b>Realistic</b>	Reproduces exceptional lifelike contrast and natural saturation.	
	<b>Fantasy</b>	Emphasizes textured leather, solid stone, and flickering fire.	
	<b>Cinema</b>	For viewing videos.	
	<b>Display HDR</b>	Enables HDR function for content complied with DisplayHDR™ standards (VESA certified).	
	<b>Display P3</b>	For better color matching representation with Standard Display P3.	
	<b>sRGB</b>	For better color matching representation with sRGB compatible peripherals.	
	<b>Custom</b>	Applies a combination of color settings defined by users.	
	<b>Gamer 1</b>	Saves a new set of customized display settings.	
	<b>Gamer 2</b>		
	<b>Gamer 3</b>		
	<b>A.I.</b>	The monitor identifies the game screen and provides the most suitable color settings. Please download <b>Color Shuttle</b> from BenQ website to enable A.I. function.	<ul style="list-style-type: none"> <li>• <a href="#">Brightness</a></li> <li>• <a href="#">AMA</a></li> <li>• <a href="#">Reset Color</a></li> </ul>

Available menu options may vary depending on the input sources, functions and settings. See [Available menu options to each Color Mode on page 47](#) for more information.

Item	Function	Range
<b>Light Tuner</b> (selected modes only)	Brings out the dark shades by increasing the brightness, contrast, and saturation all together.	-10 ~ 10
<b>Color Vibrance</b> (selected modes only)	Provides different sets of color settings. Once applied, you can adjust some of the color settings in the corresponding menus.	0 ~ 20
<b>Brightness</b>	Adjusts the balance between light and dark shades.	0 ~ 100



Item	Function		Range
<b>Shadow Phage</b> (selected modes only)	<p>Real-time auto contrast adjustment technology ensured optimal detail presentation across different in-game environmental conditions.</p>  You can work with <b>Light Tuner</b> to determine the level of contrast.		<ul style="list-style-type: none"> <li>• <b>ON</b></li> <li>• <b>OFF</b></li> </ul>
<b>B.I.+</b> (selected modes only)	<p>Turns the Brightness Intelligence Plus function on or off. The built-in light sensor works with Brightness Intelligence technology to detect the ambient light, image brightness and contrast, and then balance the screen automatically. See <a href="#">Adjusting screen brightness automatically (Brightness Intelligence Plus)</a> on page 39 for more information.</p>		<ul style="list-style-type: none"> <li>• <b>ON</b></li> <li>• <b>OFF</b></li> </ul>
<b>Gamma</b> (selected modes only)	Adjusts the tone luminance.		1 ~ 5
<b>Contrast</b>	Adjusts the degree of difference between darkness and lightness.		0 ~ 100
<b>Color Temperature</b> (selected modes only)	<b>Normal</b>	Allows video and still photographs to be viewed with natural coloring. This is the factory default color.	
	<b>Bluish</b>	Applies a cool tint to the image and is factory pre-set to the PC industry standard white color.	
	<b>Reddish</b>	Applies a warm tint to the image and is factory pre-set to the news print standard white color.	
	<b>User Define</b>	<p>The blend of the Red, Green and Blue primary colors can be altered to change the color tint of the image. Go to the succeeding <b>R</b> (red), <b>G</b> (green), and <b>B</b> (blue) menus to change the settings.</p> <p>Decreasing one or more of the colors will reduce their respective influence on the color tint of the image. (e.g. if you reduce the Blue level the image will gradually take on a yellowish tint. If you reduce Green, the image will become a magenta tint.)</p>	<ul style="list-style-type: none"> <li>• <b>R</b> (0 ~ 100)</li> <li>• <b>G</b> (0 ~ 100)</li> <li>• <b>B</b> (0 ~ 100)</li> </ul>
<b>AMA</b>	Improves the gray level response time of the LCD panel.		0 ~ 3

Item	Function	Range
<b>Blur Reduction</b> (Motion Blur Reduction)	Reduces motion blur in games or during video playback.   Note the impacts of the Blur Reduction function once activated. - Brightness is decreased. - Flicker-free is disabled. - Available only when the fresh rate is above 100 Hz.	
<b>Sharpness</b>	Adjusts the clarity and visibility of the edges of the subjects in the image.	0 ~ 10
<b>Backlight Control</b> (selected modes only)	(Available only when the input is HDR-compatible.) Once enabled, the monitor may flicker when playing HDR content as the backlight changes dynamically with the content. This is a normal phenomenon. You can disable this function as desired.	<ul style="list-style-type: none"> <li>• <b>ON</b></li> <li>• <b>OFF</b></li> </ul>
<b>Save As</b> (selected modes only)	Saves a new set of customized display settings.	<ul style="list-style-type: none"> <li>• <b>Gamer 1</b></li> <li>• <b>Gamer 2</b></li> <li>• <b>Gamer 3</b></li> </ul>
<b>Reset Color</b>	Resets the custom color settings to the factory defaults.	<ul style="list-style-type: none"> <li>• <b>YES</b></li> <li>• <b>NO</b></li> </ul>

# Available menu options to each **Color Mode**

Depending on the **Color Mode** you just set, the available options for color adjustment may vary. The list is for reference only as available options also vary by input. Menu options that are not available will become grayed out.

## For SDR content

EX271Q	Sci-fi	Realistic	Fantasy	Cinema	Display P3	sRGB	Custom	Gamer 1 / Gamer 2 / Gamer 3	A.I.
Options									
Light Tuner	V	V	V	V	X	X	V	V	X
Color Vibrance	V	V	V	V	X	X	V	V	X
Shadow Phage	V	V	V	V	X	X	V	V	X
Brightness	V	V	V	V	V	V	V	V	V
Contrast	√ <sup>(1)</sup>	√ <sup>(1)</sup>	√ <sup>(1)</sup>	√ <sup>(1)</sup>	V	V	√ <sup>(1)</sup>	√ <sup>(1)</sup>	X
Sharpness	V	V	V	V	V	V	V	V	X
Gamma	√ <sup>(1)</sup>	√ <sup>(1)</sup>	√ <sup>(1)</sup>	√ <sup>(1)</sup>	X	X	√ <sup>(1)</sup>	√ <sup>(1)</sup>	X
Color Temperature	√ <sup>(2)</sup>	√ <sup>(2)</sup>	√ <sup>(2)</sup>	X	X	X	√ <sup>(1)</sup>	√ <sup>(1)</sup>	X
Blur Reduction	V	V	V	X	X	X	V	V	X
Backlight Control	X	X	X	X	X	X	X	X	X
B.I.+	V	V	V	V	X	X	V	V	X
Low Blue Light	V	V	V	V	X	X	V	V	X
Color Weakness	V	V	V	V	X	X	V	V	X

## For HDR content

EX271Q	Sci-fi HDRi	Realistic HDRi	Fantasy HDRi	Cinema HDRi	Display HDR	Gamer 1 HDRi / Gamer 2 HDRi / Gamer 3 HDRi	A.I. HDRi
Options							
Light Tuner	V	V	V	V	X	V	X
Color Vibrance	V	V	V	V	X	V	X
Shadow Phage	V	V	V	V	X	V	X
Brightness	V	V	V	V	V	V	V
Contrast	√ <sup>(1)</sup>	√ <sup>(1)</sup>	√ <sup>(1)</sup>	√ <sup>(1)</sup>	X	√ <sup>(1)</sup>	X
Sharpness	V	V	V	V	V	V	X
Gamma	X	X	X	X	X	X	X
Color Temperature	√ <sup>(2)</sup>	√ <sup>(2)</sup>	√ <sup>(2)</sup>	X	X	√ <sup>(1)</sup>	X
AMA	V	V	V	V	V	V	V
Blur Reduction	V	V	V	X	X	V	X
Backlight Control	X	X	X	X	V	X	X
B.I.+	V	V	V	V	X	V	X
Low Blue Light	V	V	V	V	X	V	X

EX271Q	Sci-fi HDRi	Realistic HDRi	Fantasy HDRi	Cinema HDRi	Display HDR	Gamer 1 HDRi / Gamer 2 HDRi / Gamer 3 HDRi	A.I. HDRi
Options							
<b>Color Weakness</b>	V	V	V	V	X	V	X

---

• V: Available.

• X: Not available.



• (1): Available only when **B.I.+** is disabled.

• (2): Available only when **B.I.+** is disabled and **Color Temperature** is set to **User Define**.

• (3): Available only when **Backlight Control** is disabled.

---

# Eye Care menu

Available menu options may vary depending on the input sources, functions and settings. Menu options that are not available will become grayed out. And keys that are not available will be disabled and the corresponding OSD icons will disappear. For models without certain functions, their settings and related items will not appear on the menu.

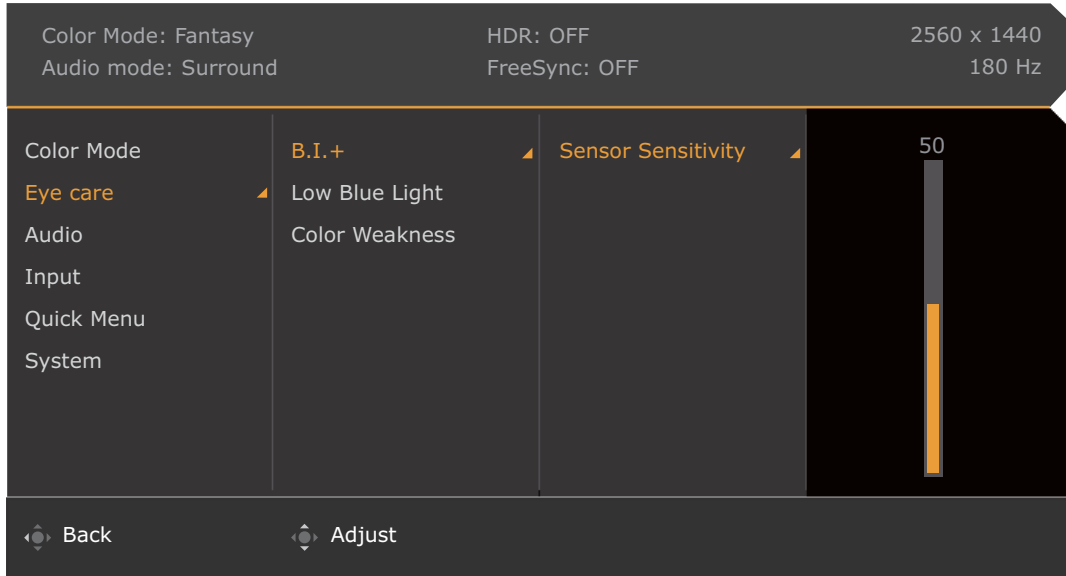

1. Press / / to bring up the **Quick Menu**.
2. Select **Menu** from the **Quick Menu**.
3. Use or to select **Eye Care**.
4. Select to go to a sub menu, and then use or to select a menu item.
5. Use or to make adjustments, or use to make selection.
6. To return to the previous menu, select .
7. To exit the menu, select .

Item	Function	Range
<b>B.I.+</b> (Brightness Intelligence Plus)	If the Brightness Intelligence Plus function has been enabled from a mode in the <b>Color Mode</b> menu, related settings are available here.	
	<b>Sensor Sensitivity</b>	Adjusts sensitivity of light sensor to change the brightness range to be detected. This may be helpful to correct uneven lighting in light detection.
<b>Low Blue Light</b>	Decreases the blue light emitted from the display to reduce the risk of blue light exposure to your eyes. The higher the value is, the more blue light has been decreased.	0 ~ 5

Item	Function		Range
<b>Color Weakness</b>	Adjusts color matching representation for people with color vision deficiency to distinguish colors easily.		
	<b>Red Filter</b>	Decides the effect produced by the red filter. A stronger effect is produced as the value increases.	0 ~ 20
	<b>Green Filter</b>	Decides the effect produced by the green filter. A stronger effect is produced as the value increases.	0 ~ 20

# Audio menu

Available menu options may vary depending on the input sources, functions and settings. Menu options that are not available will become grayed out. And keys that are not available will be disabled and the corresponding OSD icons will disappear. For models without certain functions, their settings and related items will not appear on the menu.

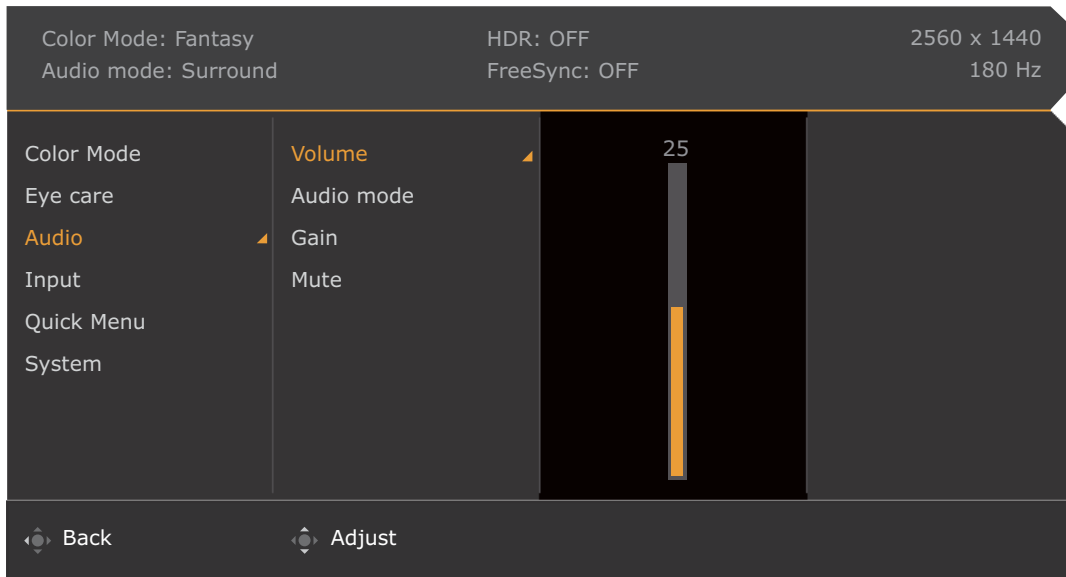

1. Press / / to bring up the **Quick Menu**.
2. Select **Menu** from the **Quick Menu**.
3. Use or to select **Audio**.
4. Select to go to a sub menu, and then use or to select a menu item.
5. Use or to make adjustments, or use to make selection.
6. To return to the previous menu, select .
7. To exit the menu, select .

Item	Function	Range	
<b>Volume</b>	Adjusts the audio volume.	0 ~ 50	
<b>Audio mode</b>	Selects one of the equalizers to obtain the best audio effect in certain scenarios.		
	<b>Surround</b>	This mode simulates immersive, multi-directional audio for the headphone, and it's Ideal for enriching an immersive gaming audio experience.	
	<b>Cinema</b>	Enhances the bass while keeps the vocal clear.	
	<b>Standard</b>	Balances all settings for use without a specific scenario.	

Item	Function	Range
<b>Gain</b>	<p>Your monitor comes with a built-in DAC. You need to adjust gain setting to drive your headphone properly for better sound reproduction.</p> <p>For high-impedance headphones, select <b>High</b>.</p> <p>For low-impedance headphones, select <b>Low</b>.</p> <p> Please use the <b>High</b> setting only with high-impedance audio equipment. Do not use the <b>High</b> setting with low-impedance devices, as it poses a risk of damage. Choose safely to ensure optimal performance and equipment safety.</p>	<ul style="list-style-type: none"> <li>• <b>High</b></li> <li>• <b>Low</b></li> </ul>
<b>Mute</b>	Mutes the audio input.	<ul style="list-style-type: none"> <li>• <b>ON</b></li> <li>• <b>OFF</b></li> </ul>



# Input menu

Available menu options may vary depending on the input sources, functions and settings. Menu options that are not available will become grayed out. And keys that are not available will be disabled and the corresponding OSD icons will disappear. For models without certain functions, their settings and related items will not appear on the menu.

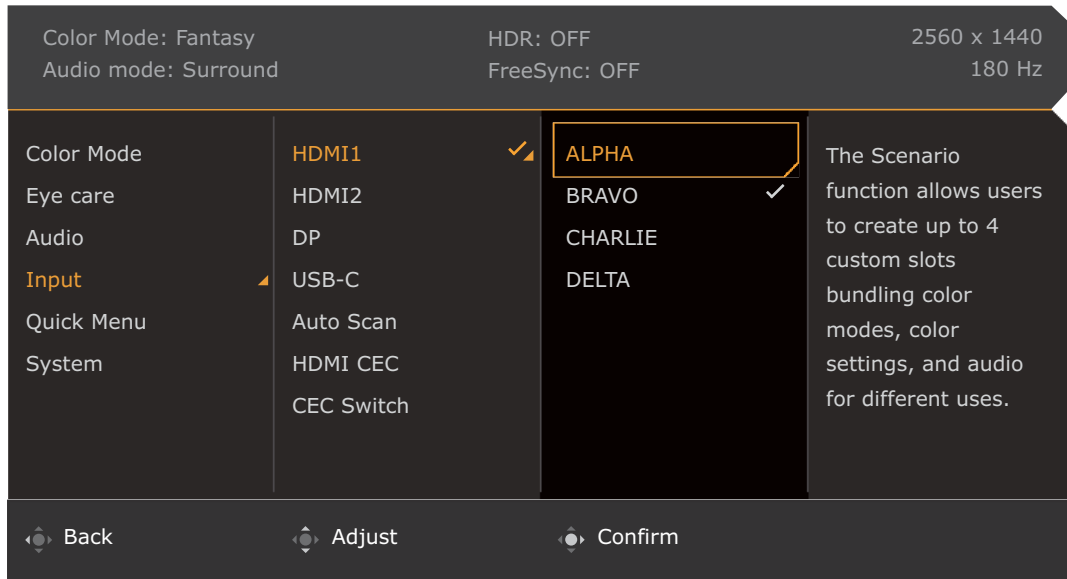

1. Press / / to bring up the **Quick Menu**.
2. Select **Menu** from the **Quick Menu**.
3. Use or to select **Input**.
4. Select to go to a sub menu, and then use or to select a menu item.
5. Use or to make adjustments, or use to make selection.
6. To return to the previous menu, select .
7. To exit the menu, select .









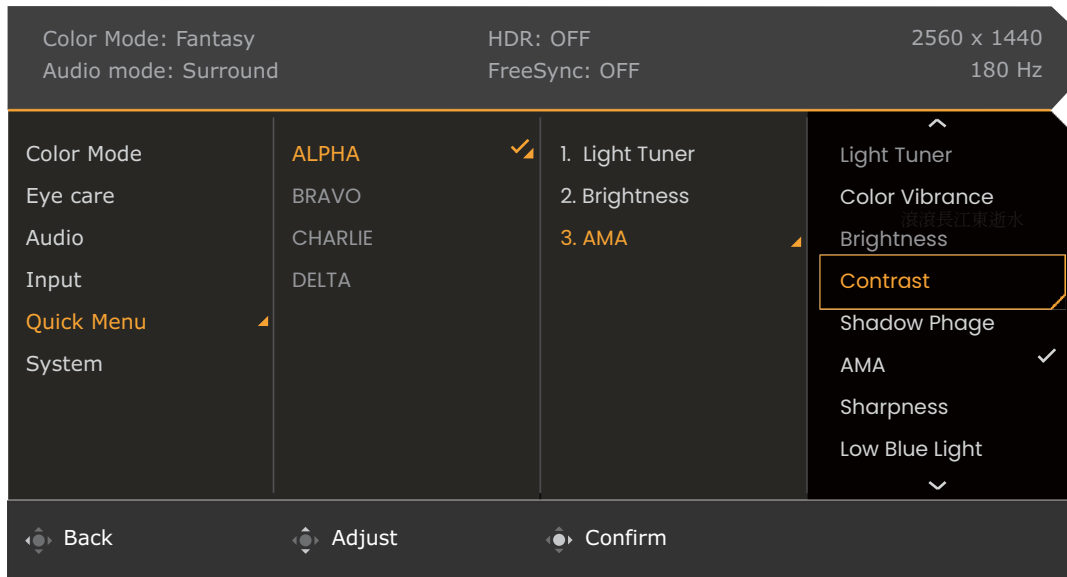



Item	Function	Range
<b>HDMI1</b>	Use this to change the input to that appropriate to your video cable connection type. A scenario could be designated for an input. See <a href="#">Setting up your monitor for different scenarios on page 36</a> for more information.	<ul style="list-style-type: none"> <li>• <b>ALPHA</b></li> <li>• <b>BRAVO</b></li> <li>• <b>CHARLIE</b></li> <li>• <b>DELTA</b></li> </ul>
<b>HDMI2</b>		
<b>DP</b>		
<b>USB-C</b>		
<b>Auto Scan</b>	When this function is activated, all ports will be in the input auto select loop.	<ul style="list-style-type: none"> <li>• <b>ON</b></li> <li>• <b>OFF</b></li> </ul>

Item	Function	Range						
<b>HDMI CEC</b>	<p>Once enabled, it allows you to control your monitor and HDMI CEC (Consumer Electronics Control)-compatible devices via HDMI connection. Available controls vary by device.</p> <p>Currently tested compatible devices are as follows:</p> <ul style="list-style-type: none"> <li>• • PS5, PS4</li> <li>• • Xbox One/Xbox Series X/S</li> <li>• • Switch</li> </ul>	<ul style="list-style-type: none"> <li>• <b>ON</b></li> <li>• <b>OFF</b></li> </ul>						
<b>CEC Switch</b>	<p>(Available when <b>HDMI CEC</b> is enabled)</p> <p>Decides the way to switch to a new input from a CEC-compatible device if detected.</p> <table border="1" data-bbox="352 667 1257 992"> <tbody> <tr> <td data-bbox="352 667 520 736"><b>Full Auto</b></td> <td data-bbox="520 667 1257 736">Switches to the new input automatically.</td> </tr> <tr> <td data-bbox="352 736 520 846"><b>Semi Auto</b></td> <td data-bbox="520 736 1257 846">Pops up a message and switches to the new input once confirmed.</td> </tr> <tr> <td data-bbox="352 846 520 992"><b>OFF</b></td> <td data-bbox="520 846 1257 992">The switch function is turned off. You have to manually switch to the input from a CEC-compatible device.</td> </tr> </tbody> </table>	<b>Full Auto</b>	Switches to the new input automatically.	<b>Semi Auto</b>	Pops up a message and switches to the new input once confirmed.	<b>OFF</b>	The switch function is turned off. You have to manually switch to the input from a CEC-compatible device.	
<b>Full Auto</b>	Switches to the new input automatically.							
<b>Semi Auto</b>	Pops up a message and switches to the new input once confirmed.							
<b>OFF</b>	The switch function is turned off. You have to manually switch to the input from a CEC-compatible device.							

# Quick Menu

Available menu options may vary depending on the input sources, functions and settings. Menu options that are not available will become grayed out. And keys that are not available will be disabled and the corresponding OSD icons will disappear. For models without certain functions, their settings and related items will not appear on the menu.



1. Press  /  /  to bring up the **Quick Menu**.
2. Select **Menu** from the **Quick Menu**.
3. Use  or  to select **Quick Menu**.
4. Select  to go to a sub menu, and then use  or  to select a menu item.
5. Use  or  to make adjustments, or use  to make selection.
6. To return to the previous menu, select .
7. To exit the menu, select .



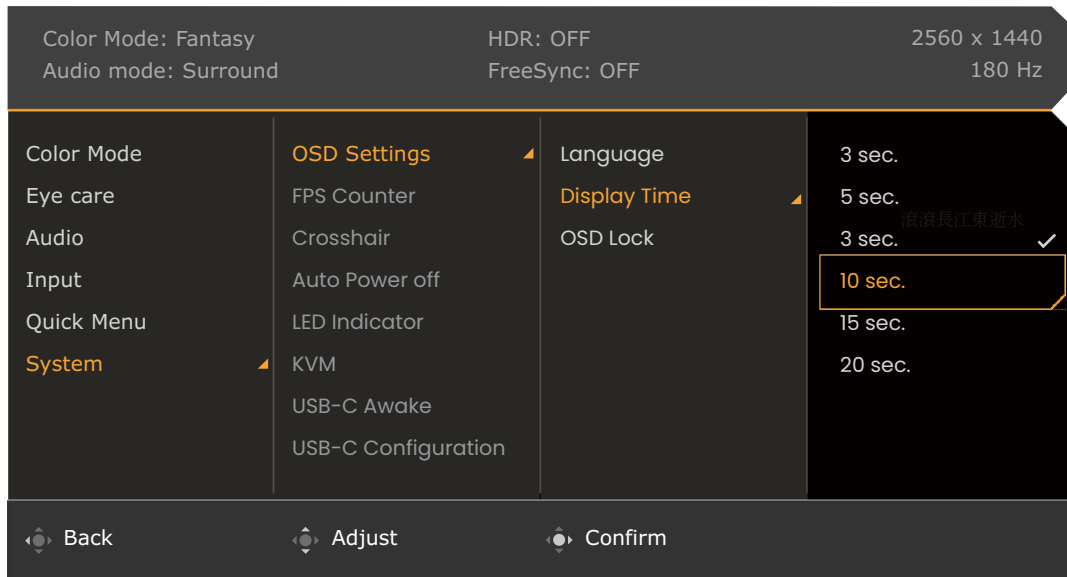

Item	Function	Range
<b>ALPHA</b>	Sets 3 settings that could be frequently adjusted from the <b>Quick Menu</b> for each scenario. See <a href="#">Quick Menu on page 33</a> and <a href="#">Customizing the Quick Menu for a scenario on page 37</a> for more information.	<ul style="list-style-type: none"> <li>• <a href="#">Light Tuner</a></li> <li>• <a href="#">Color Vibrance</a></li> <li>• <a href="#">Brightness</a></li> <li>• <a href="#">Contrast</a></li> <li>• <a href="#">Shadow Phage</a></li> <li>• <a href="#">AMA</a></li> <li>• <a href="#">Sharpness</a></li> <li>• <a href="#">Low Blue Light</a></li> <li>• <a href="#">Crosshair</a></li> <li>• <a href="#">Blur Reduction</a></li> </ul>
<b>BRAVO</b>		
<b>CHARLIE</b>		
<b>DELTA</b>		

# System menu



Available menu options may vary depending on the input sources, functions and settings. Menu options that are not available will become grayed out. And keys that are not available will be disabled and the corresponding OSD icons will disappear. For models without certain functions, their settings and related items will not appear on the menu.



1. Press / / to bring up the **Quick Menu**.
2. Select **Menu** from the **Quick Menu**.
3. Use or to select **System**.
4. Select to go to a sub menu, and then use or to select a menu item.
5. Use or to make adjustments, or use to make selection.
6. To return to the previous menu, select .
7. To exit the menu, select .

Item	Function	Range	
<b>OSD Settings</b>	<b>Language</b>	<p>Sets the OSD menu language.</p> <p> The language options displayed on your OSD may differ from those shown on the right, depending on the product supplied in your region.</p>	<ul style="list-style-type: none"> <li>• <b>English</b></li> <li>• <b>Français</b></li> <li>• <b>Deutsch</b></li> <li>• <b>Italiano</b></li> <li>• <b>Español</b></li> <li>• <b>Polski</b></li> <li>• <b>Česky</b></li> <li>• <b>Magyar</b></li> <li>• <b>Română</b></li> <li>• <b>Nederlands</b></li> <li>• <b>Русский</b></li> <li>• <b>Svenska</b></li> <li>• <b>Português</b></li> <li>• العربية</li> <li>• 日本語</li> <li>• 한국어</li> <li>• 繁體中文</li> <li>• 简体中文</li> </ul>
	<b>Display Time</b>	Adjusts the display time of the OSD menu.	<ul style="list-style-type: none"> <li>• <b>3 sec.</b></li> <li>• <b>5 sec.</b></li> <li>• <b>10 sec.</b></li> <li>• <b>15 sec.</b></li> <li>• <b>20 sec.</b></li> </ul>
	<b>OSD Lock</b>	<p>Prevents all the monitor settings from being accidentally changed. When this function is activated, the OSD controls and hotkey operations will be disabled.</p> <p> To unlock the OSD controls, press and hold any key for 10 seconds.</p>	
<b>FPS Counter</b>	Determines whether to show real-time refresh rate on the upper-right corner of the screen.	<ul style="list-style-type: none"> <li>• <b>ON</b></li> <li>• <b>OFF</b></li> </ul>	
<b>Crosshair</b>	Sets to display a crosshair on the screen for aiming at targets.	<ul style="list-style-type: none"> <li>• <b>OFF</b></li> <li>• </li> <li>• </li> </ul>	

Item	Function	Range	
<b>Auto Power Off</b>	Sets the time to power off the monitor automatically in power saving mode.	<ul style="list-style-type: none"> <li>• <b>OFF</b></li> <li>• <b>10 min.</b></li> <li>• <b>20 min.</b></li> <li>• <b>30 min.</b></li> </ul>	
<b>LED Indicator</b>	Switches the power key's LED indicator on or off.	<ul style="list-style-type: none"> <li>• <b>ON</b></li> <li>• <b>OFF</b></li> </ul>	
<b>KVM</b>	Switches the keyboard and mouse control over different inputs.		
	<b>Auto</b>	Switches the keyboard and mouse control over an available input.	
	<b>Upstream</b>	Switches the keyboard and mouse control over the input source / display connected to USB upstream port.	
	<b>USB-C</b>	Switches the keyboard and mouse control over the input source / display connected to USB-C™ port.	
<b>USB-C Awake</b>	<p>If this function is disabled, the USB-C™ port/USB hub is not supplied with power while the monitor is in standby mode.</p> <p>To keep supplying power to the USB-C™ port/USB hub in monitor's standby mode, change the setting to <b>ON</b>.</p>	<ul style="list-style-type: none"> <li>• <b>ON</b></li> <li>• <b>OFF</b></li> </ul>	
<b>USB-C Configuration</b>	Sets the refresh rate of the input video via USB-C™ port. The USB transmission speed changes accordingly due to USB-C™ technology limitation.		
	<b>USB 2.0</b>	Refresh rate: 2560 x 1440 @ 180Hz USB transmission speed: 480 Mbps	
	<b>USB 3.1 Gen1</b>	Refresh rate: 2560 x 1440 @ 60Hz USB transmission speed: 5 Gbps	
<b>FreeSync</b>	<p>Switches <b>FreeSync</b> on or off.</p> <p>Monitors featuring with the FreeSync will eliminate screen tearing, stuttering, and juddering during gaming. If this function is enabled, the FreeSync and HDR functions are activated, with the support of your monitor, the graphic card, and the input of HDR content. Available FreeSync function varies by content.</p> <p> For any questions related to FreeSync™ performance please refer to <a href="http://www.AMD.com">www.AMD.com</a>.</p>	<ul style="list-style-type: none"> <li>• <b>ON</b></li> <li>• <b>OFF</b></li> </ul>	













Item	Function	Range		
<b>4K Compatible</b>	Enable this function to show HDR content from Xbox.	<ul style="list-style-type: none"> <li>• <b>ON</b></li> <li>• <b>OFF</b></li> </ul>		
<b>Display</b>	<b>Display Mode</b>	This feature is provided to allow aspect ratios other than 16:9 to be displayed without geometric distortion.		
		<b>Full</b>	Scales the input image to fill the screen. Ideal for 16:9 aspect images.	
		<b>Aspect</b>	The input image is displayed without geometric distortion filling as much of the display as possible.	
		<b>1:1</b>	Displays the input image in its native resolution without scaling.	
	<b>Overscan</b>	<p>Slightly enlarges the input image. Use this feature to hide annoying edge noise if present around your image.</p> <p> Available only when the input is a video timing from HDMI.</p>	<ul style="list-style-type: none"> <li>• <b>ON</b></li> <li>• <b>OFF</b></li> </ul>	
<b>RGB PC Range</b>	Determines the range of color scales. Select an option that matches the RGB range setting on the connected device.	<ul style="list-style-type: none"> <li>• <b>Auto Detect</b></li> <li>• <b>RGB (0~255)</b></li> <li>• <b>RGB (16~235)</b></li> </ul>		
<b>Information</b>	Displays the product information.	<ul style="list-style-type: none"> <li>• <b>Input</b></li> <li>• <b>Current Resolution</b></li> <li>• <b>Optimum Resolution</b></li> <li>• <b>HDR</b></li> <li>• <b>Model Name</b></li> </ul>		
<b>Reset All</b>	<p>Resets all mode, color and geometry settings to the factory default values.</p> <p> You are prompted to set scenarios for available inputs after system reset. See <a href="#">Setting up your monitor for different scenarios on page 36</a> for more information.</p>	<ul style="list-style-type: none"> <li>• <b>YES</b></li> <li>• <b>NO</b></li> </ul>		



# Troubleshooting

## Frequently asked questions (FAQ)

### Imaging

-  The image is blurred.
-  Download **Resolution file** from the website (see [Product support on page 4](#)). Refer to "**Adjusting the Screen Resolution**". And then select the correct resolution, refresh rate and make adjustments based on these instructions.
-  Does the blurring only occur at resolutions lower than the native (maximum) resolution?
-  Download **Resolution file** from the website (see [Product support on page 4](#)). Refer to "**Adjusting the Screen Resolution**". Select the native resolution.
-  Pixel errors can be seen.
- One of several pixels is permanently black, one or more pixels are permanently white, one or more pixels are permanently red, green, blue or another color.
-  • Clean the LCD screen.  
• Cycle power on-off.  
• These are pixels that are permanently on or off and is a natural defect that occurs in LCD technology.
-  The image has a faulty coloration.
-  It has a yellow, blue or pink appearance.
- Go to the selected color mode from **Color Mode**. Select **Reset Color**, and then choose **YES** to reset the color settings to the factory defaults.
- If the image is still not correct and the OSD also has faulty coloration, this means one of the three primary colors is missing in the signal input. Now check the signal cable connectors. If any pin is bent or broken off, please contact your dealer to get necessary support.
-  The image is distorted, flashes or flickers.
-  Download **Resolution file** from the website (see [Product support on page 4](#)). Refer to "**Adjusting the Screen Resolution**". And then select the correct resolution, refresh rate and make adjustments based on these instructions.
-  You are running the monitor at its native resolution, but the image is still distorted.
-  Images from different input sources may appear distorted or stretched on the monitor running at its native resolution. To have the optimal display performance of each type of input sources, you can use the **Display Mode** function to set a proper aspect ratio for the input sources. See [Display Mode on page 60](#) for details.

- ⓪ The image is displaced in one direction.
- ✔ Download **Resolution file** from the website (see [Product support on page 4](#)). Refer to "**Adjusting the Screen Resolution**". And then select the correct resolution, refresh rate and make adjustments based on these instructions.
- ⓪ Faint shadow from the static image displayed is visible on the screen.
- ✔
  - Activate the power management function to let your computer and monitor go into a low power "sleep" mode when not actively in use.
  - Use a screensaver to prevent the occurrence of image retention.

## LED indicators

- ⓪ The power LED indicator is white or orange.
- ✔
  - If the LED lights up in solid white, the monitor is powered on.
  - If the LED is illuminated in white and there is a message **Out of Range** on the screen, this means you are using a display mode that this monitor does not support, please change the setting to one of the supported mode. Download **Resolution file** from the website (see [Product support on page 4](#)). Refer to "**Adjusting the Screen Resolution**". And then select the correct resolution, refresh rate and make adjustments based on these instructions.
  - If the LED is illuminated in orange, the power management mode is active. Press any button on the computer keyboard or move the mouse. If that does not help, check the signal cable connectors. If any pin is bent or broken off, please contact your dealer to get necessary support.
  - If the LED is off, check the power supply mains socket, the external power supply and the mains switch.

## OSD controls

- ⓪ The OSD controls are inaccessible.
- ✔ To unlock the OSD controls when it is preset to be locked, press and hold any key for 10 seconds.

## OSD messages

- ⓪ A message **Out of Range** on the screen during computer boot up process.
- ✔ If there is a message **Out of Range** on the screen during computer boot up process, this means computer compatibility caused by operating system or graphic card. The system will adjust the refresh rate automatically. Just wait until the operating system is launched.

## Audio

- ❓ No sound can be heard from the connected audio output.
- ✓
  - Check whether the device is properly connected.
  - Make sure the audio device is powered on.
  - Increase the volume (volume may be muted or too low) on the audio device.

## Sensors

- ❓ The light sensor of the monitor does not work well.
- ✓ The light sensor is located at the front bottom of the monitor. Please check:
  - If you have removed the sensor protection sticker.
  - If the Brightness Intelligence Plus function has been turned on. Check **Color Mode** > a mode > **B.I.+** (Brightness Intelligence Plus).
  - If there are any obstacles in front of the sensor that keep the sensor from detecting the light properly.
  - If there are any objects or clothing in bright colors in front of the sensor. Bright colors (especially white and fluorescent colors) reflect light and the sensor cannot detect the main light sources.

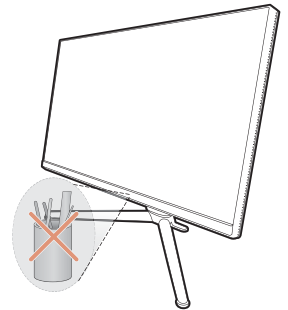

## Need more help?

If your problems remain after checking this manual, please contact your place of purchase or visit the local website from [Support.BenQ.com](https://support.benq.com) for more support and local customer service.