

# Lenovo 500e Chromebook Gen 4s User Guide





## **Read this first**

Before using this documentation and the product it supports, ensure that you read and understand the following:

- *Safety and Warranty Guide*
- *Setup Guide*
- [Generic Safety and Compliance Notices](#)

**First Edition (October 2024)**

**© Copyright Lenovo 2024.**

LIMITED AND RESTRICTED RIGHTS NOTICE: If data or software is delivered pursuant to a General Services Administration "GSA" contract, use, reproduction, or disclosure is subject to restrictions set forth in Contract No. GS-35F-05925.

---

# Contents

Discover your Chromebook . . . . .	ii	Connect to Bluetooth devices . . . . .	17
<b>Chapter 1. Meet your Chromebook . . . . .</b>	<b>1</b>	Get to know your Chromebook modes . . . . .	17
Front . . . . .	1	Set the power plan . . . . .	18
Base . . . . .	2	<b>Chapter 3. CRU replacement . . . . .</b>	<b>21</b>
Left . . . . .	3	What are CRUs . . . . .	21
Right . . . . .	4	Replace a CRU . . . . .	21
Bottom . . . . .	5	Pen dummy (for selected models) . . . . .	21
Features and specifications . . . . .	6	Battery door . . . . .	22
Statement on USB transfer rate . . . . .	7	Battery . . . . .	23
Operating environment . . . . .	7	Base cover assembly . . . . .	24
<b>Chapter 2. Get started with your Chromebook . . . . .</b>	<b>9</b>	<b>Chapter 4. Help and support . . . . .</b>	<b>25</b>
Charge your Chromebook . . . . .	9	Frequently asked questions . . . . .	25
Lock your Chromebook . . . . .	9	Lenovo Customer Support Center . . . . .	25
Connect to a cellular network (for selected models) . . . . .	10	Get help from Google . . . . .	26
Connect to Wi-Fi . . . . .	11	<b>Chapter 5. Safety instructions for teachers, parents and adult supervisors. . . . .</b>	<b>29</b>
Use the touch screen. . . . .	11	<b>Appendix A. Open source information. . . . .</b>	<b>31</b>
Use the keyboard shortcuts . . . . .	13	<b>Appendix B. Notices and trademarks. . . . .</b>	<b>33</b>
Use the touchpad . . . . .	14		
Use the camera . . . . .	15		
Use audio . . . . .	15		
Use the electronic pen (for selected models) . . . . .	16		
Connect to an external display . . . . .	16		

---

## Discover your Chromebook

Thank you for choosing a Lenovo® Chromebook™! We are dedicated to delivering the best solution to you.

Before starting your tour, please read the following information:

- This guide applies to Lenovo product model(s) listed below. Illustrations in this guide may look slightly different from your product model.

Model name	Machine type (MT)
Lenovo 500e Chromebook Gen 4s	83L4, 83L5, 83N8, 83N9

- For further compliance information, refer to the *Generic Safety and Compliance Notices* at [https://pcsupport.lenovo.com/docs/generic\\_notices](https://pcsupport.lenovo.com/docs/generic_notices).
- Depending on the model, some optional accessories, features, software programs, and user interface instructions might not be applicable to your Chromebook.
- Documentation content is subject to change without notice. To get the latest documentation, go to <https://pcsupport.lenovo.com>.



---

# Chapter 1. Meet your Chromebook

---

## Front

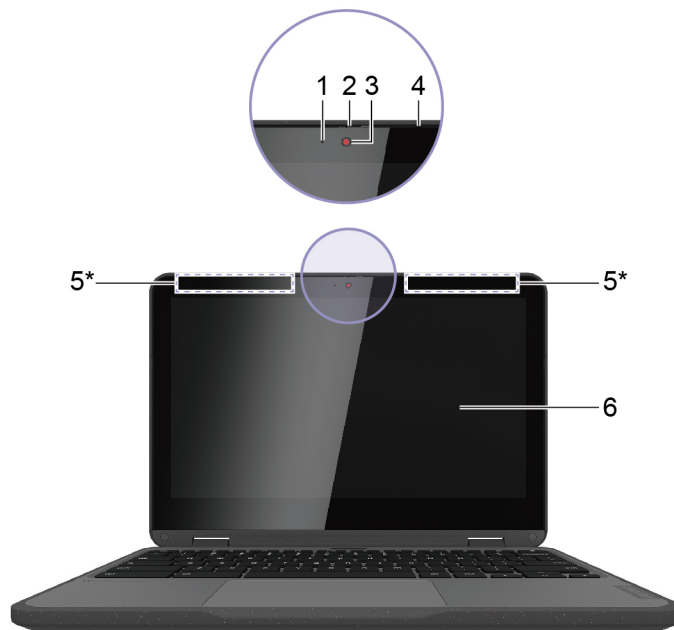

---

1. Camera light	If the light is on, the camera is in use.
2. Camera cover	Cover or uncover the camera lens. <b>Note:</b> The camera cover helps you better protect your privacy.
3. Camera	Capture still and moving images for taking photos, recording videos, and video chatting.
4. Microphone	Capture or record sound and voice.
5. Wireless WAN antennas*	Send and receive radio waves for the built-in wireless WAN (wide area network) and Bluetooth module. <b>Notes:</b> <ul style="list-style-type: none"><li>• The antennas are not visible from the outside of the Chromebook.</li><li>• The locations of wireless WAN antennas vary on different models.</li></ul>
6. Screen	Display text, graphics, and videos. Support multi-touch function.

---

\* for selected models

## Base



1. Keyboard	Enter characters and interact with programs. <b>Note:</b> The keyboard also includes function keys and key combinations for changing settings and performing tasks quickly.
2. Touchpad	Perform finger touch and all the functions of a traditional mouse. <b>Note:</b> The touchpad also supports multi-touch function.
3. Wireless LAN antennas	Send and receive radio waves for the built-in wireless LAN (local area network) and Bluetooth module. <b>Notes:</b> <ul style="list-style-type: none"><li>• The antennas are not visible from the outside of the Chromebook.</li><li>• The locations of wireless LAN antennas vary on different models.</li></ul>
4. Camera	Capture still and moving images for taking photos, recording videos, and video chatting.
5. Camera light	If the light is on, the camera is in use.
6. Microphone	Capture or record sound and voice.

## Left

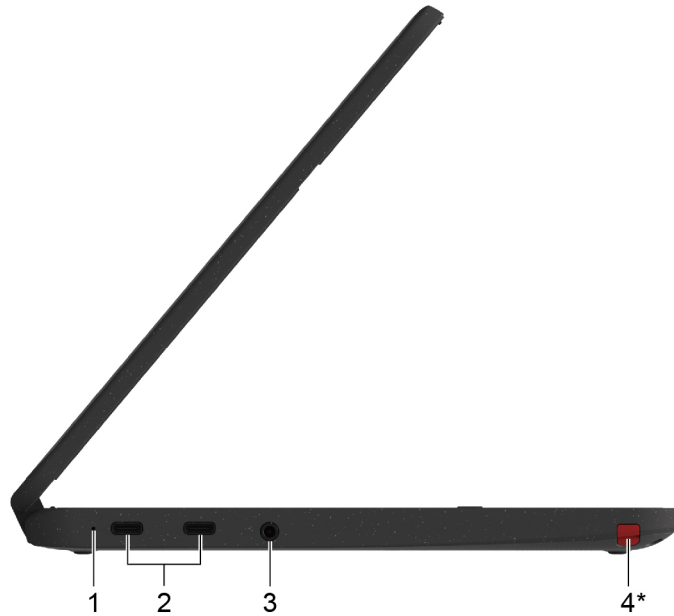

1. Charging light	Indicate the ac power status and the battery status. See “AC power status indicator behavior” on page 9.
2. Multi-purpose USB Type-C® connectors	<ul style="list-style-type: none"><li>This multi-purpose connector can be used to connect display devices and devices that utilize the USB data transfer technology. It also supports USB Power Delivery.</li></ul> <p><b>Note:</b> When connecting display devices, you need to use appropriate cables and adapters (if needed) according to the connection capabilities of the display device.</p> <ul style="list-style-type: none"><li>The USB Type-C connector with a plug icon  next to it also functions as the Chromebook’s power input connector.</li></ul>
3. Combo audio jack	Connect headphones or headsets with a 3.5 mm (0.14 inch), 4-pole plug. <p><b>Note:</b> This jack does not support standalone external microphones. If you use headsets, choose one with a single plug.</p>
4. Electronic pen*	Write or draw on the screen.

\* for selected models



---

## Right

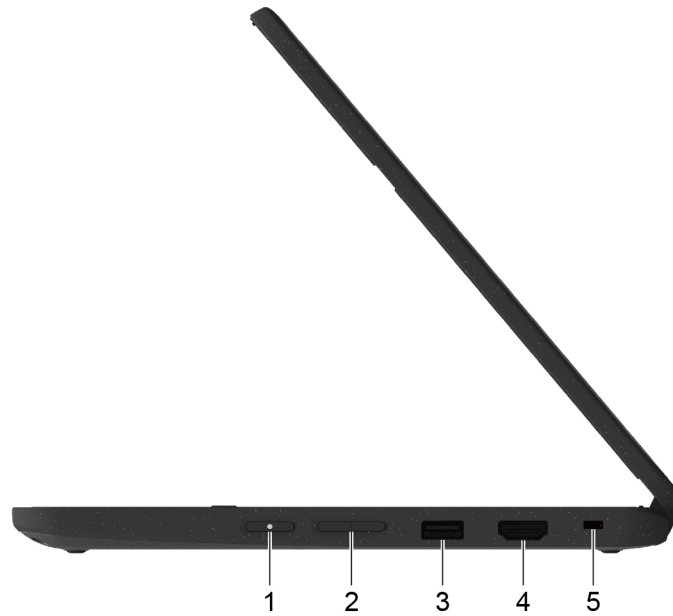

---

1. Power button	<p>Press the button to turn on the Chromebook or put the Chromebook into sleep mode.</p> <p><b>Notes:</b> When you finish working with your Chromebook, shut it down to save power.</p> <ul style="list-style-type: none"><li>• Click  in the system tray.</li><li>• Press the power button.</li></ul>
2. Volume buttons	<p>Press the button to increase or decrease the system volume.</p>
3. USB (3.2 Gen 1) Type-A connector	<p>Connect a USB-compatible device, such as a USB keyboard, a USB mouse, a USB storage device, or a USB printer.</p>
4. HDMI™ connector	<p>Connect to a compatible digital audio device or video monitor, such as an HDTV.</p>
5. Nano security-lock slot	<p>Lock your Chromebook to a desk, table, or other fixtures through a compatible security cable lock. See “Lock your Chromebook” on page 9.</p>

---

---

## Bottom

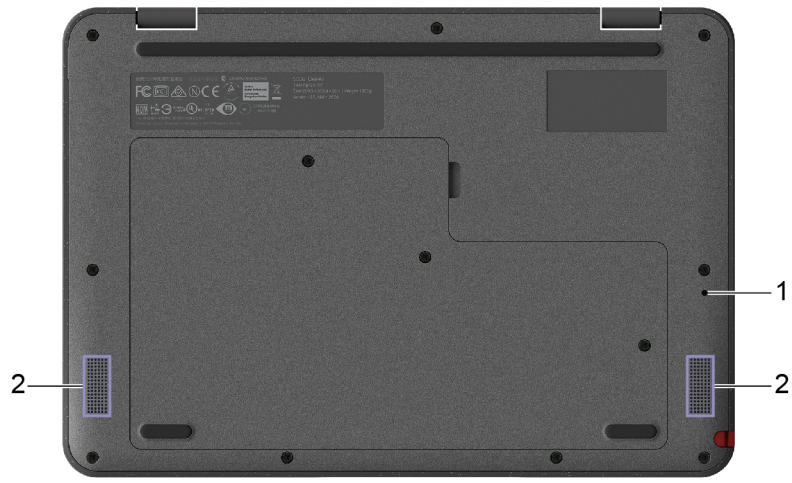

---

1. Keyboard drainage hole

Drain out liquid from your Chromebook if you accidentally spill liquid on the keyboard.

---

2. Speakers

Produce sound.

---

---

## Features and specifications

**Note:** Specifications might change without notice. Some specifications are model-specific and might not apply to the Chromebook model that you purchased.

---

Dimensions	<ul style="list-style-type: none"><li>• Width: 289.6 mm (11.4 inches)</li><li>• Depth: 202.4 mm (8 inches)</li><li>• Thickness: 20.4 mm (0.8 inches)</li></ul>
ac power adapter	<ul style="list-style-type: none"><li>• Input: 100 V ac–240 V ac, 50 Hz–60 Hz</li><li>• Output:<ul style="list-style-type: none"><li>– 15 V dc, 3 A, or</li><li>– 20 V dc, 3.25 A</li></ul></li><li>• Power:<ul style="list-style-type: none"><li>– 45 W, or</li><li>– 65 W</li></ul></li></ul> <p><b>Note:</b> Some models may not ship with ac adapter or power cords. Use only the certified adapters and power cords provided by Lenovo that comply with the requirements of relevant national standards to charge the product. It is recommended to use the Lenovo qualified adapters. You can refer to <a href="https://www.lenovo.com/us/en/compliance/eu-doc">https://www.lenovo.com/us/en/compliance/eu-doc</a>.</p>
Battery pack	<ul style="list-style-type: none"><li>• Capacity: 47 Wh</li><li>• Number of cells: 1</li></ul> <p><b>Note:</b> The battery capacity is the typical or average capacity as measured in a specific test environment. Capacities measured in other environments may differ but are no lower than the rated capacity (see product label).</p>
Microprocessor	To view the microprocessor information of your Chromebook, type system information in the search box and then press Enter.
Memory	<ul style="list-style-type: none"><li>• Type: On-board lower double data rate 5 (LPDDR5) /LPDDR5X</li><li>• Number of physical slots: 0</li></ul>
Secondary storage device	<ul style="list-style-type: none"><li>• Type: Embedded multi media card 5.1</li><li>• Bus: eMMC 5.1</li><li>• Capacity: 32 GB or 64 GB</li></ul> <p><b>Note:</b> The capacity of the storage device displayed in the operating system is typically lower than the nominal capacity.</p>
Screen	<ul style="list-style-type: none"><li>• Size: 294.6 mm (11.6 inches)</li><li>• Display resolution: 1366 × 768 pixels (HD model)</li></ul>
Keyboard	<ul style="list-style-type: none"><li>• Function keys</li><li>• Key combinations</li></ul>

---



---

#### Connectors and slots

- Combo audio jack
- USB Type-A connector
  - Support power output up to 4.5 W (5 V, 0.9 A)
- Multi-purpose USB Type-C connector × 2
  - Support power input up to 65 W using the included power adapter
  - Support USB 2.0 480 Mbps
  - Support SuperSpeed USB 5 Gbps
  - Support DisplayPort™ Alt Mode (DisplayPort 1.4 compliant)
  - Support USB Power Delivery
  - Support power output up to 7.5 W (5 V, 1.5 A)
  - Support power output up to 15 W (5 V, 3 A)
- HDMI connector
  - Support 3840 × 2160 at 30 Hz as specified in HDMI 1.4
- Memory card slot

**Note:** Data rates and performance ratings are dependent on connected devices and cables if they are used. For DisplayPort connection through a USB Type-C connector, the listed maximum output capacity is only available on external displays with a DisplayPort, a Mini DisplayPort, or a USB Type-C connector that supports DisplayPort Alternate Mode. For connections using a converter or an adapter, the actual output resolution may be lower.

---

#### Security

Security-lock slot

---

#### Network

- Bluetooth and Wi-Fi® combo adapter
- Wireless WAN adapter\*

---

\* for selected models

---

## Statement on USB transfer rate

Depending on many factors such as the processing capability of the host and peripheral devices, file attributes, and other factors related to system configuration and operating environments, the actual transfer rate using the various USB connectors on this device will vary and will be slower than the data rate listed below for each corresponding device.

USB device	Data rate (Gbit/s)
2.0	0.48
USB 3.2 Gen 1	5

---

## Operating environment

### Maximum altitude (without pressurization)

3048 m (10 000 ft)

### Temperature

- Operating: 5°C to 35°C (41°F to 95°F)
- Storage: 5°C to 43°C (41°F to 109°F)

**Note:** When you charge the battery, its temperature must be no lower than 10°C (50°F).

**Relative humidity**

- Operating: 8% to 95% at wet-bulb temperature 23°C (73°F)
- Storage: 5% to 95% at wet-bulb temperature 27°C (81°F)

---

## Chapter 2. Get started with your Chromebook

---

### Charge your Chromebook

The USB Type-C connector on your Chromebook works as the power connector. Plug in the ac power adapter to charge the built-in battery pack and provide power to the Chromebook.

#### Connect to ac power

##### CAUTION:

All plugs must be firmly and securely inserted into receptacles.

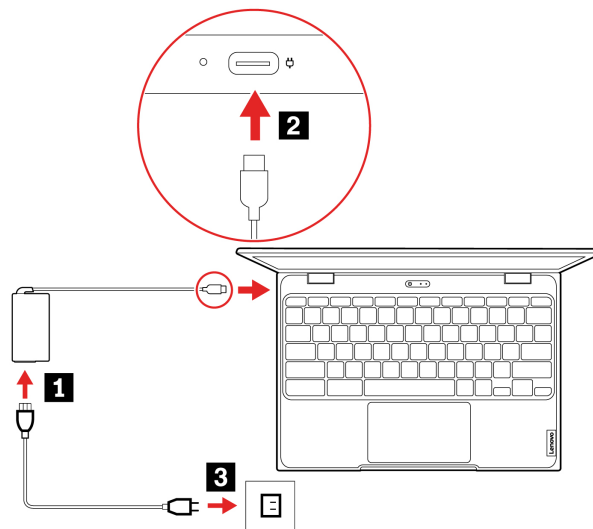

1. Connect the power cord to the ac power adapter.
2. Plug the power adapter into the USB Type-C connector of the Chromebook.
3. Plug the power cord into an electrical outlet.

#### AC power status indicator behavior

The ac power status indicator is next to the USB Type-C connector. The following table shows the indicator behaviors and the indicated power and battery status.

AC power status indicator	Power status	Battery status
on (red)	plugged in	being charged, remaining power is less than 5%
on (amber)	plugged in	being charged, remaining power is between 5% and 97%
on (green)	plugged in	fully charged (97% to 100%)
off	unplugged	discharging

---

### Lock your Chromebook

Lock your Chromebook to a desk, table, or other fixtures through a compatible security cable lock.



**Note:** The slot supports cable locks that conform to the Kensington NanoSaver® lock standards using Cleat™ locking technology. Do not attempt to use other types of cable locks that use a rotating T-bar™ locking mechanism. You are responsible for evaluating, selecting, and implementing the locking device and security feature. Lenovo makes no comments, judgments, or warranties about the function, quality, or performance of the locking device and security feature. Cable locks for your product are available from Lenovo at <https://www.lenovoquickpick.com/>.

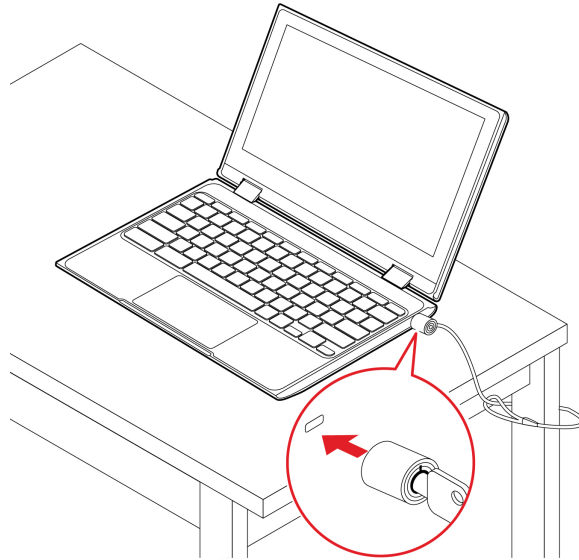

---

## Connect to a cellular network (for selected models)

If your Chromebook has a wireless wide area network (WAN) card and a nano-SIM card installed, you can connect to a cellular data network and get online everywhere.

**Note:** The cellular service is provided by authorized mobile service carriers in some countries or regions. You must have a cellular plan from a service carrier to connect to the cellular network.

To establish a cellular connection:

1. Turn off the Chromebook.
2. Locate the nano-SIM card slot and insert the nano-SIM card as shown. Note the orientation of the card and ensure that it is seated correctly.

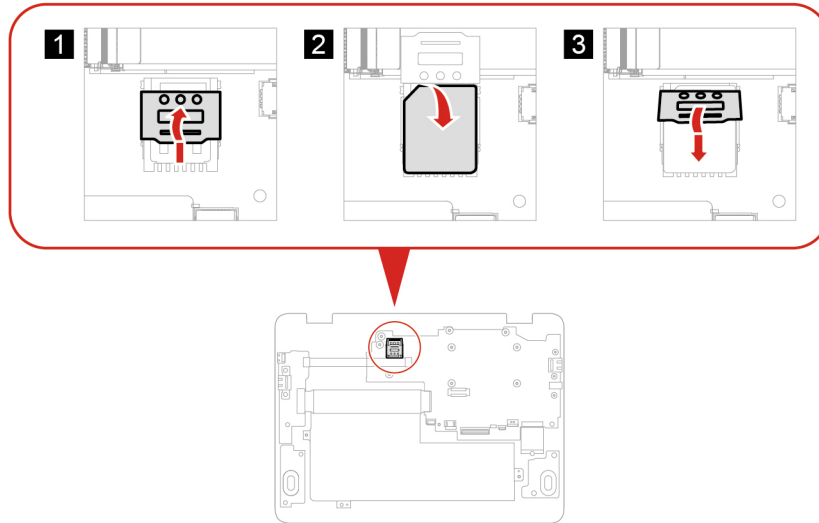

3. Turn on the Chromebook.
4. Click the network icon in the system tray, and then turn on **Mobile data**. Provide required information, if needed.

---

## Connect to Wi-Fi

To connect your Chromebook to Wi-Fi:

1. Click your system tray.
2. Click the network icon and turn on the wireless feature.
3. Select an available network to connect. Provide required information if needed.

---

## Use the touch screen

If your Chromebook display supports the multi-touch function, you can navigate the screen with simple touch gestures.

**Note:** Some gestures might not be available depending on the app you use.



Tap once to single click



Tap and hold to right-click

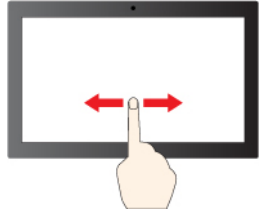

Slide to scroll through items



Drag

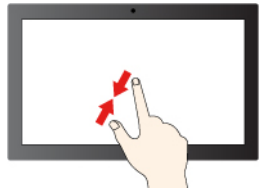

Zoom out

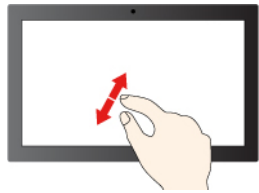

Zoom in

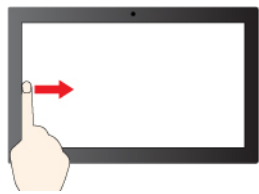

Swipe from the left: view all open windows

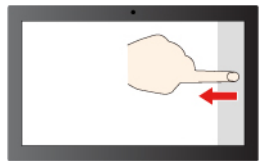

Swipe from the right: open action center



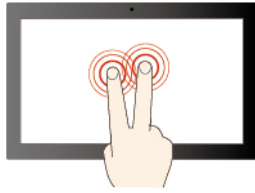

Tap with two fingers to open a shortcut menu

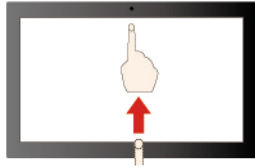

Swipe upwards to unfold the app Launcher











### Maintenance tips:

- Turn off the Chromebook before cleaning the multi-touch screen.
- Use a dry, soft, and lint-free cloth or a piece of absorbent cotton to remove fingerprints or dust from the multi-touch screen. Do not apply solvents to the cloth.
- The multi-touch screen is a glass panel covered with a plastic film. Do not apply pressure or place any metallic object on the screen, which might damage the touch panel or cause it to malfunction.
- Do not use fingernails, gloved fingers, or inanimate objects for input on the screen.
- Regularly calibrate the accuracy of the finger input to avoid a discrepancy.





---

## Use the keyboard shortcuts

The function keys on the keyboard help you work more easily and effectively.

	Go to the previous page
	Go to the next page
	Reload your current page
	Hide the tabs and the App Launcher in full-screen mode
	Show all windows in overview mode
	Decrease the brightness of the Chromebook screen
	Increase the brightness of the Chromebook screen
	Mute the speakers
	Decrease the volume
	Increase the volume
	Lock the Chromebook screen

Your Chromebook also supports some key combinations.

ctrl + 	Take a screenshot
alt + 	Switch the Caps Lock function
 + l	Lock your Chromebook screen
ctrl + alt + ?	View all keyboard shortcuts
*alt + 	Turn off the keyboard backlight and decrease the brightness
*alt + 	Turn on the keyboard backlight and increase the brightness

\* for selected models

To change the keyboard settings:

1. Click the setting icon in the system tray, and then click **Device → Keyboard**.
2. Follow the on-screen instructions to change the settings as you prefer.

---

## Use the touchpad

The entire touchpad surface is sensitive to finger touch and movement. You can use the touchpad to perform all the pointing, clicking, and scrolling functions of a traditional mouse.

### Use the touch gestures

#### Notes:

- When using two or more fingers, ensure that you position your fingers slightly apart.
- Some gestures are only available when you are using certain apps.
- If the touchpad surface is stained with oil, turn off the Chromebook first. Then, gently wipe the touchpad surface with a soft and lint-free cloth moistened with lukewarm water or Chromebook cleaner.

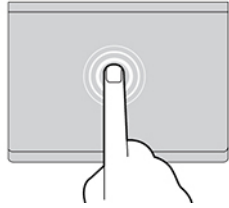

Tap once to select or open an item.

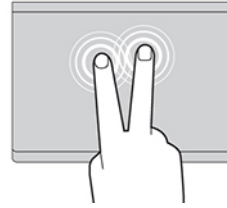

Tap twice quickly to display a shortcut menu.

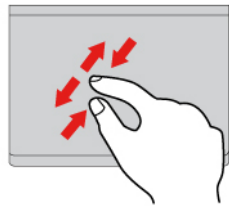

Two-finger zoom in or zoom out.

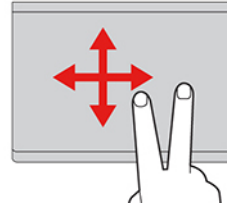

Scroll through items.

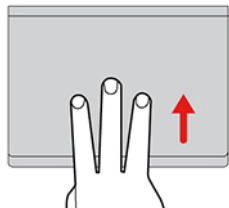

Open the task view.

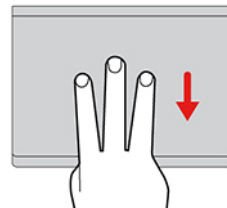

Show the current window.

To change the settings:

1. Click the setting icon in the system tray, and then click **Device → Touchpad**.
2. Follow the on-screen instructions to change the settings as you prefer.

If **Enable tap-to-click** is turned on, you can tap or press the touchpad. Otherwise, you can only press the touchpad to achieve the clicking function of a traditional mouse.

---

## Use the camera

The built-in camera can be used for video calling or video conferencing. The indicator next to the camera turns on when the camera is activated.

To take photos with the camera:

1. Click the Launcher button.
2. Click **Camera** and take photos.

---

## Use audio

You can connect headphones or a headset with a 3.5-mm (0.14-inch), 4-pole plug to the audio connector to listen to the sound from your Chromebook.

To play a saved audio or video:

1. Click the Launcher button, and then select **Files**.
2. Double-click a file to open it in the media player.

To adjust the volume, click the system tray, and then adjust the volume as you prefer.

---

## Use the electronic pen (for selected models)

Selected models are shipped with an electronic pen. To use the pen, slide it out of the pen slot. When not in use, put it back into its slot.

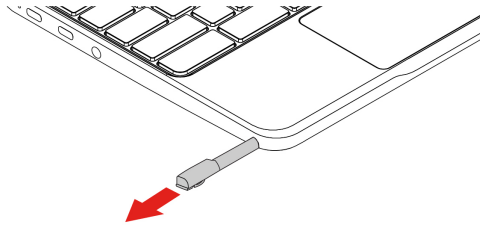

### Notes:

- You might need to install additional apps such as Google Keep for better use of the pen.
- For Chromebook models that come with a pen dummy, you can purchase an electronic pen to use. To purchase the pen, go to <https://www.lenovo.com/accessories>.

### Use the electronic pen

You can perform the following operations with the pen:

- To open an app or a Web page, tap the display once.
- To display the shortcut menu or make a selection, tap the display and hold the pen there for one second.

---

## Connect to an external display

Connect your Chromebook to a projector or a monitor to give presentations or expand your workspace.

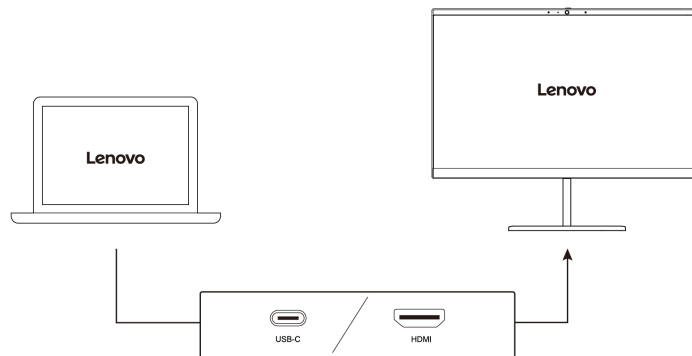

### Supported resolution

The following table lists the supported maximum resolution of the external display.

---

Connect the external display to	Supported resolution
Multi-purpose USB Type-C connector	Up to 3840 x 2160 pixels @ 30 Hz
HDMI connector	Up to 3840 x 2160 pixels @ 30 Hz

---

To change display settings:

1. Click the setting icon in the system tray, and then click **Device → Displays**.
2. Follow the on-screen instructions to change the display settings as you prefer.

---

## Connect to Bluetooth devices

Your Chromebook supports Bluetooth feature. You can connect your Chromebook to a Bluetooth keyboard, mouse, speakers, or other Bluetooth devices.

**Note:** The Bluetooth devices must be within a short distance, usually 10 meters (33 feet), from the Chromebook.

1. Click your system tray, and then click the Bluetooth icon.
2. Turn on **Bluetooth**.
3. Select the device you want to pair and follow the on-screen instructions.

---

## Get to know your Chromebook modes

Rotate the display to switch among different modes according to your preference. The keyboard is automatically disabled in the stand mode, tent mode, and tablet mode. Use the touch screen to control your Chromebook instead.

**Attention:** Do not rotate the Chromebook display with too much force, or apply too much force to the upper-right or upper-left corner of the Chromebook display. Otherwise, the display or hinges might get damaged.



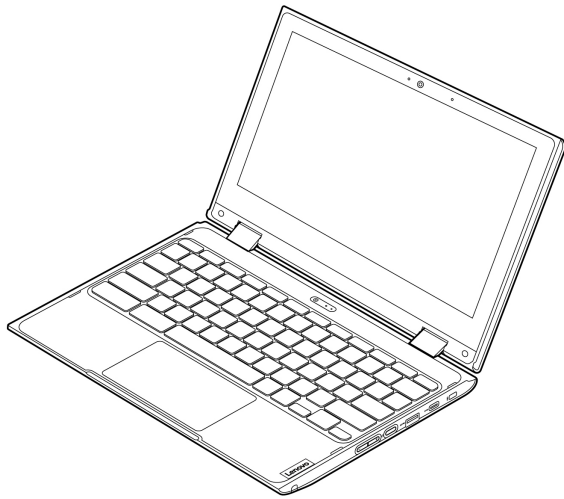

**Laptop mode**

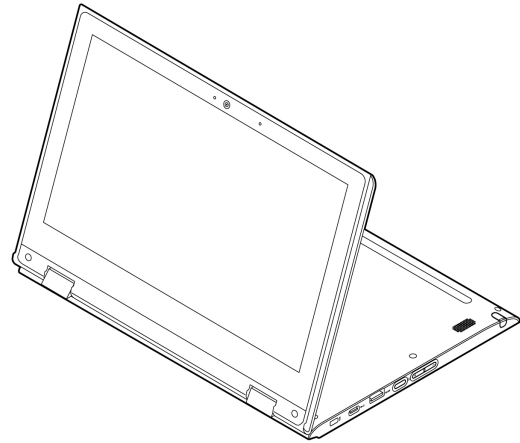

**Stand mode**

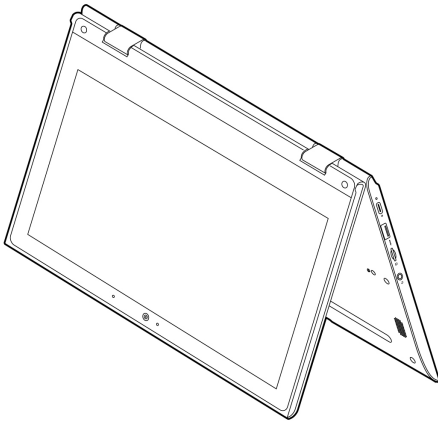

**Tent mode**

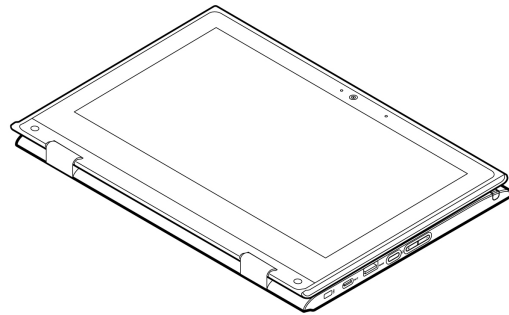

**Tablet mode**

**Warning:** When operating in the tablet mode with any external device connected, the upper case (keyboard's side) of the Chromebook may become hot. Avoid keeping your hands, lap, or any part of the body in contact with the upper case for over one minute.

---

## Set the power plan

For ENERGY STAR® compliant Chromebooks, the following power plan takes effect when your Chromebooks have been idle for a specified duration:

*Table 1. Default power plan (when plugged into ac power)*

- |  |
|--|
| <ul style="list-style-type: none"><li>• Turn off the display: After seven minutes and 30 seconds</li><li>• Put the Chromebook into sleep: After eight minutes and 30 seconds</li></ul> |
|--|

To reset the power plan to achieve the best balance between performance and power saving:

1. Click the setting icon in the system tray, and then click **Device → Power**.
2. Follow the on-screen instructions to change the settings as you prefer.



---

## Chapter 3. CRU replacement

Customer Replaceable Units (CRUs) are parts that can be replaced by the customer. The Chromebooks contain the following types of CRUs:

- **Self-service CRUs:** Refer to parts that can be replaced easily by customer themselves or by trained service technicians at an additional cost.
- **Optional-service CRUs:** Refer to parts that can be replaced by customers with a greater skill level. Trained service technicians can also provide service to replace the parts under the type of warranty designated for the customer's machine.

If you intend on installing a CRU, Lenovo will ship the CRU to you. CRU information and replacement instructions are shipped with your product and are available from Lenovo at any time upon request. You might be required to return the defective part that is replaced by the CRU. When return is required: (1) return instructions, a prepaid shipping label, and a container will be included with the replacement CRU; and (2) you might be charged for the replacement CRU if Lenovo does not receive the defective CRU within thirty (30) days of your receipt of the replacement CRU. For full details, see the Lenovo Limited Warranty documentation at [https://www.lenovo.com/warranty/llw\\_02](https://www.lenovo.com/warranty/llw_02).

---

### What are CRUs

Refer to the following CRU list for your Chromebook.

#### Self-service CRUs

- ac power adapter
- Electronic pen\*
- Pen dummy\*
- Power cord

#### Optional-service CRUs

- Battery
- Battery door
- Base cover assembly

\* for selected models

**Note:** Replacement of any parts not listed above, including the built-in rechargeable battery, must be done by a Lenovo-authorized repair facility or technician. Go to <https://support.lenovo.com/partnerlocation> for more information.

---

### Replace a CRU

Follow the replacement procedure to replace a CRU.

### Pen dummy (for selected models)

#### Prerequisite

Before you start, read [Generic Safety and Compliance Notices](#) and print the following instructions.

For access, do the following:

1. Ensure that your Chromebook is off or in sleep mode. Disconnect the Chromebook from ac power and all connected cables.
2. Close the Chromebook display and turn the Chromebook over.

### Removal procedure

Use a tool as shown to release the pen dummy **1** **2**, then remove it **3**.

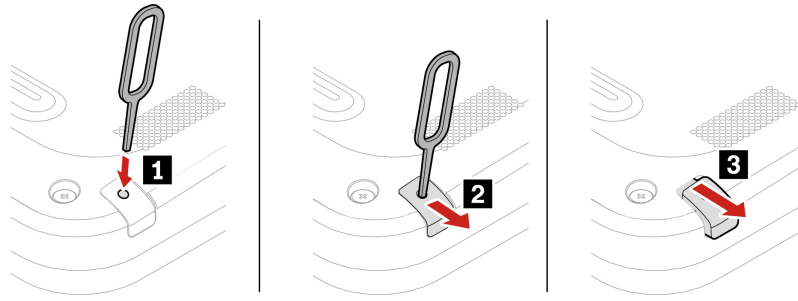

## Battery door

### Prerequisite

Before you start, read [Generic Safety and Compliance Notices](#) and print the following instructions.

**Note:** Do not remove the base cover assembly when your Chromebook is connected to ac power.

For access, do the following:

1. Disable the built-in battery. Press **C** together with the power button for about five seconds, and at the same time detach the ac power adapter from the Chromebook.

**Note:** Power supply from the built-in battery will resume after you reconnect the Chromebook to the ac power adapter.

2. Close the Chromebook display and turn over the Chromebook.

### Removal procedure

Loosen three screws. Then, use the pry up tool to remove the battery door from the location marked as **2**.

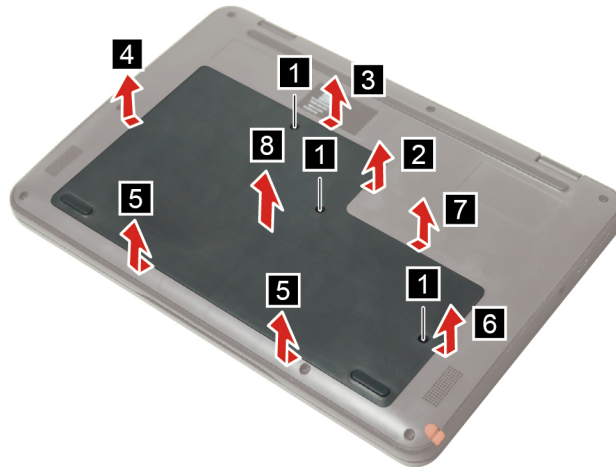

### Troubleshooting

If the Chromebook does not start up after you reinstall the battery door, disconnect the ac power adapter and then reconnect it to the Chromebook.

## Battery

### Prerequisite

Before you start, read [Generic Safety and Compliance Notices](#) and print the following instructions.

For access, remove the following:

- “Battery door” on page 22

### Removal procedure

Disconnect the battery pack cable from the system board, remove four screws, and remove the battery pack.

**Attention:** Use your fingernail to pull the connector to unplug it. Do not pull the cable.

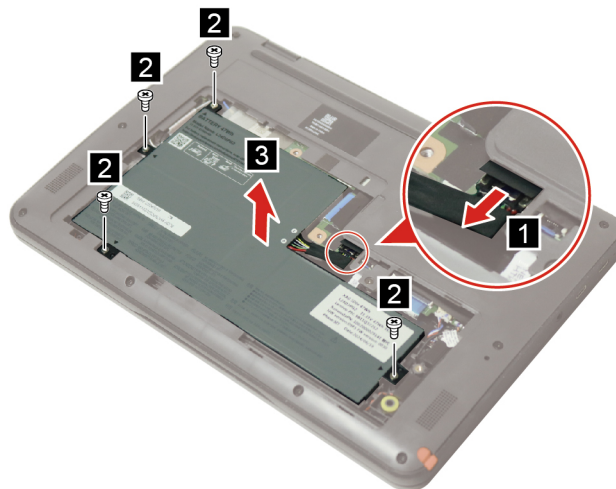

## Troubleshooting

If the Chromebook does not start up after you reinstall the battery door, disconnect the ac power adapter and then reconnect it to the Chromebook.

## Base cover assembly

### Prerequisite

Before you start, read [Generic Safety and Compliance Notices](#) and print the following instructions.

**Note:** Do not remove the base cover assembly when your Chromebook is connected to ac power.

For access, remove the following:

- “Battery door” on page 22

### Removal procedure

Loosen nine screws. Then, remove the base cover assembly.

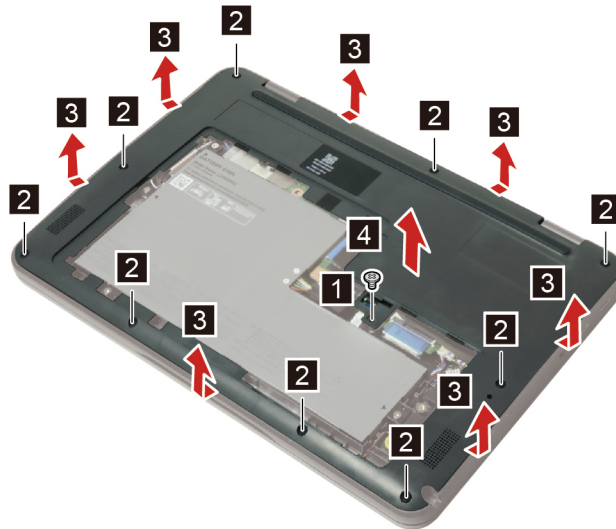

## Troubleshooting

If the Chromebook does not start up after you reinstall the battery door, disconnect the ac power adapter and then reconnect it to the Chromebook.



---

## Chapter 4. Help and support

---

### Frequently asked questions

---

What do I do if my Chromebook stops responding?

1. Press and hold the power button until the Chromebook turns off. Then, restart the Chromebook.
2. If step 1 does not work:
  - For models with an emergency reset hole: Insert a straightened paper clip into the emergency reset hole to cut off power supply temporarily. Then, restart the Chromebook with ac power connected.
  - For models without an emergency reset hole:
    - For models with the removable battery, remove the removable battery and disconnect all power sources. Then, reconnect to ac power and restart the Chromebook.
    - For models with the built-in battery, disconnect all power sources. Press and hold the power button for about seven seconds. Then, reconnect to ac power and restart the Chromebook.

---

What do I do if I spill liquid on the Chromebook?

1. Carefully unplug the ac power adapter and turn off the Chromebook immediately. The more quickly you stop the current from passing through the Chromebook the more likely you will reduce damage from short circuits.  
**Attention:** Although you might lose some data or work by turning off the Chromebook immediately, leaving the Chromebook on might make your Chromebook unusable.
2. Do not try to drain out the liquid by turning over the Chromebook. If your Chromebook has keyboard drainage holes on the bottom, the liquid will be drained out through the holes.
3. Wait until you are certain that all the liquid is dry before turning on your Chromebook.

---

How do I disinfect my Chromebook?

1. Squeeze out excess liquid from wipe or disinfecting cloth before using. Recommended wipes are hydrogen peroxide wipes and alcohol based wipes. Do not use wipes containing sodium hypochlorite (bleach).
2. Gently wipe the Chromebook thoroughly, being careful to ensure no liquid drips into the Chromebook. Do not wipe on connector pins.
3. After disinfecting, follow the cleaning procedure from the wipe supplier to minimize chemical buildup of disinfectant residue.
4. Always allow the Chromebook to completely dry prior to any use.

For more information about cleaning and disinfecting, go to <https://support.lenovo.com/in/en/solutions/ht035676>.

---

How do I find accessibility information?

<https://www.lenovo.com/accessibility>

---

## Lenovo Customer Support Center

If you have tried to correct the problem yourself and still need help, you can call Lenovo Customer Support Center.

## Before you contact Lenovo

Record product information and problem details before you contact Lenovo.

---

Product information	Problem symptoms and details
<ul style="list-style-type: none"><li>• Product name</li><li>• Machine type and serial number</li></ul>	<ul style="list-style-type: none"><li>• What is the problem? Is it continuous or intermittent?</li><li>• Any error message or error code?</li><li>• What operating system are you using? Which version?</li><li>• Which software applications were running at the time of the problem?</li><li>• Can the problem be reproduced? If so, how?</li></ul>

---

**Note:** The product name and serial number can usually be found on the bottom of the Chromebook, either printed on a label or etched on the cover.

### Telephone numbers

For a list of the Lenovo Support phone numbers for your country or region, go to <https://pcsupport.lenovo.com/supportphonenumber> for the latest phone numbers.

**Note:** Phone numbers are subject to change without notice. If the number for your country or region is not provided, contact your Lenovo reseller or Lenovo marketing representative.

### Services available during the warranty period

- Problem determination - Trained personnel are available to assist you with determining if you have a hardware problem and deciding what action is necessary to fix the problem.
- Lenovo hardware repair - If the problem is determined to be caused by Lenovo hardware under warranty, trained service personnel are available to provide the applicable level of service.
- Engineering change management - Occasionally, there might be changes that are required after a product has been sold. Lenovo or your reseller, if authorized by Lenovo, will make selected Engineering Changes (ECs) that apply to your hardware available.

### Services not covered

- Replacement or use of parts not manufactured for or by Lenovo or nonwarranted parts
- Identification of software problem sources
- Configuration of UEFI BIOS as part of an installation or upgrade
- Changes, modifications, or upgrades to device drivers
- Installation and maintenance of network operating systems (NOS)
- Installation and maintenance of programs

For the terms and conditions of the Lenovo Limited Warranty that apply to your Lenovo hardware product, go to:

- [https://www.lenovo.com/warranty/llw\\_02](https://www.lenovo.com/warranty/llw_02)
- <https://pcsupport.lenovo.com/warrantylookup>

---

## Get help from Google

After signing in to your Chromebook, start Get Help from the app Launcher. The Get Help app provides comprehensive instructions on using your Chromebook.

In addition, if you are interested in visiting the Chromebook Help Center and Community, go to <http://support.google.com/chromebook>.



---

## Chapter 5. Safety instructions for teachers, parents and adult supervisors

This Chromebook is intended for use as a child development tool primarily by children, 6 years of age or above. There must be supervision by an adult. It is a must to have a thorough explanation to children on safe and proper handling of the Chromebook, battery pack, and ac power adapter.



- For ITE with power supplies not intended to be handled by children: As with all electrical products, precautions should be observed handling and use to prevent electric shock. The ac power adapter should not be handled by children.
- The Chromebook should not be placed on the bare skin (lap) of the child for long periods. The Chromebook should be placed on a flat surface, like desktop, if your child intends to use it for more than a few minutes.
- The Chromebook (including the ac power adapter and the battery pack, as applicable) should not be left in the rain or subjected to exposure to water. If cleaning is necessary do not immerse it in water; wipe clean with damp cloth.
- The Chromebook (including the ac power adapter and the battery pack, as applicable) should not be dropped, crushed (stepped on) or otherwise abused.
- An adult should caution his or her child about the potential trip hazard as posed by the cable between a power source and the Chromebook.
- The power supply (adapter) should not be handled by the children.

### **Chocking Hazard — Small parts. Not suitable for children under age 3.**

An adult should inspect the Chromebook (including the ac power adapter and the battery pack, as applicable) periodically for damage. Similarly, if a child notices damaged/broken parts, this should be reported to the teacher/parents/adult supervisors immediately. Damaged parts may be replaced through service provided by Lenovo.



**ELECTRICALLY OPERATED PRODUCT.** Not recommended for children under 3 years of age (or other intended age range). As with all electrical products, precautions should be observed during handling and use of electrical products to reduce the risk of electric shock.



---

## Appendix A. Open source information

Your Chromebook may include software made publicly available by Google and other third parties, including software licensed under the General Public License and/or the Lesser General Public License (the “open source software”).

You may obtain a copy of the corresponding source code for any such open source software licensed under the General Public License and/or the Lesser General Public License (or any other license requiring us to make a written offer to provide corresponding source code to you) from Lenovo for a period of three years without charge except for the cost of media, shipping, and handling, upon written request to Lenovo. This offer is valid to anyone in receipt of this device. You may send your request in writing to the address below accompanied by a check or money order for \$5 to:

*Lenovo Legal Department  
Attn: Open Source Team / Source Code Requests  
8001 Development Dr.  
Morrisville, NC 27560*

As part of your request, please include a “UNAME” and a “CHROME VERSION” of this device available by typing: “Chrome://system” in a Chrome Browser’s address bar. Be sure to provide a return address.

The open source software is distributed in hope it will be useful, but WITHOUT ANY WARRANTY; without even the implied warranty of MERCHANTABILITY or FITNESS FOR A PARTICULAR PURPOSE. See for example the GNU General Public License and/or the Lesser General Public License for more information.

To view additional information regarding licenses, acknowledgments and required copyright notices for the open source software used in your device, type: “Chrome://credits” in the Chrome Browser’s address bar.

This device may include certain pre-installed application programs or pre-configured links for downloading application programs published by parties other than Lenovo. Such third-party application programs may include open source software made publicly available by the respective publishers of those application programs. You may obtain the corresponding source code for any such open source software directly from the publisher of the applicable application program, to the extent permitted under the relevant open source software license agreement. Additional information is provided by the publisher of each application program within the menu structure of its application program.





---

## Appendix B. Notices and trademarks

### Notices

Lenovo may not offer the products, services, or features discussed in this document in all countries. Consult your local Lenovo representative for information on the products and services currently available in your area. Any reference to a Lenovo product, program, or service is not intended to state or imply that only that Lenovo product, program, or service may be used. Any functionally equivalent product, program, or service that does not infringe any Lenovo intellectual property right may be used instead. However, it is the user's responsibility to evaluate and verify the operation of any other product, program, or service.

Lenovo may have patents or pending patent programs covering subject matter described in this document. The furnishing of this document does not give you any license to these patents. You can send license inquiries, in writing, to:

*Lenovo (United States), Inc.  
8001 Development Drive  
Morrisville, NC 27560  
U.S.A.  
Attention: Lenovo Director of Licensing*

LENOVO PROVIDES THIS PUBLICATION "AS IS" WITHOUT WARRANTY OF ANY KIND, EITHER EXPRESS OR IMPLIED, INCLUDING, BUT NOT LIMITED TO, THE IMPLIED WARRANTIES OF NON-INFRINGEMENT, MERCHANTABILITY OR FITNESS FOR A PARTICULAR PURPOSE. Some jurisdictions do not allow disclaimer of express or implied warranties in certain transactions, therefore, this statement may not apply to you.

Changes are made periodically to the information herein; these changes will be incorporated in new editions of the publication. To provide better service, Lenovo reserves the right to improve and/or modify the products and software programs described in the manuals included with your Chromebook, and the content of the manual, at any time without additional notice.

The software interface and function and hardware configuration described in the manuals included with your Chromebook might not match exactly the actual configuration of the Chromebook that you purchase. For the configuration of the product, refer to the related contract (if any) or product packing list, or consult the distributor for the product sales. Lenovo may use or distribute any of the information you supply in any way it believes appropriate without incurring any obligation to you.

The products described in this document are not intended for use in implantation or other life support applications where malfunction may result in injury or death to persons. The information contained in this document does not affect or change Lenovo product specifications or warranties. Nothing in this document shall operate as an express or implied license or indemnity under the intellectual property rights of Lenovo or third parties. All information contained in this document was obtained in specific environments and is presented as an illustration. The result obtained in other operating environments may vary.

Lenovo may use or distribute any of the information you supply in any way it believes appropriate without incurring any obligation to you.

Any references in this publication to non-Lenovo Web sites are provided for convenience only and do not in any manner serve as an endorsement of those Web sites. The materials at those Web sites are not part of the materials for this Lenovo product, and use of those Web sites is at your own risk.

Any performance data contained herein was determined in a controlled environment. Therefore, the result obtained in other operating environments may vary significantly. Some measurements may have been made on development-level systems and there is no guarantee that these measurements will be the same on generally available systems. Furthermore, some measurements may have been estimated through extrapolation. Actual results may vary. Users of this document should verify the applicable data for their specific environment.

This document is copyrighted by Lenovo and is not covered by any open source license, including any Linux® agreement(s) which may accompany software included with this product. Lenovo may update this document at any time without notice.

For the latest information or any questions or comments, contact or visit the Lenovo Web site:

<https://pcsupport.lenovo.com>

### **Trademarks**

Lenovo and Lenovo logo are trademarks of Lenovo. ENERGY STAR is a registered trademark of the U.S. Environmental Protection Agency. Google, Google Keep, and Chromebook are trademarks or registered trademarks of Google LLC. NanoSaver and Cleat are trademarks or registered trademarks of ACCO Brands. USB Type-C is a registered trademark of USB Implementers Forum. Wi-Fi is a registered trademark of Wi-Fi Alliance. Microsoft is a registered trademark of Microsoft Corporation. All other trademarks are the property of their respective owners.



**Lenovo**