

Lenovo N27p User Guide

Product No.

H24270UN0

67C3GAC4WW

Version 1 (April 2024)

© All rights reserved Lenovo 2024

LENOVO products, data, computer software, and services are developed on earmarked funds and are sold to government agencies as commodities as defined in 48 C.F.R. 2.101, with limited restricted rights of use, duplication, and disclosure granted to the government agencies.

Restricted limited rights statement: If products, data, computer software, or services are delivered under a General Services Manager "GSA" contract, their use, duplication, or disclosure is subject to the restrictions outlined in Contract No. GS-35F-05925.

Contents

Safety Matters.....	iv
General Safety Principles	iv
Chapter 1. New Member Guide	1-1
Items List	1-1
Precautions For Use	1-2
Product Overview	1-2
Set Up the Display	1-6
Chapter 2. Adjusting and Using the Display.....	2-1
Comfort and Assistance Functions	2-1
Arrange Your Working Area	2-1
Placing and Viewing the Display.....	2-1
Tips on Healthy Work Habits.....	2-2
Adjusting the Display Image	2-3
Select Supported Display Modes	2-8
Understanding Power Management	2-9
Maintaining the Display	2-10
Remove the Display Base and Support Arm	2-10
Wall-mounted (optional)	2-10
Chapter 3. Reference Information.....	3-1
Display Specifications	3-1
Troubleshooting	3-3
Manually Install the Driver for the Display	3-5
Appendix A. Services and Support	A-1
Register Your Option.....	A-1
Online Technical Support.....	A-1
Telephone Technical Support	A-1
Appendix B. Declaration	B-1
Recovery information	B-2
Trademark	B-2
Power Cord.....	B-3

Safety Matters

General Safety Principles

For tips on safe computer use, please go to:

<http://www.lenovo.com/safety>

Before installing this product, please read the safety matters.



Danger

To avoid collision dangers:

- Do not remove the cover.
- Do not use the product without the base installed.
- Do not connect or disconnect the product during thunderstorm conditions.
- The power cord plug must be connected to a properly wired and grounded electrical outlet.
- Any equipment connected to this product must also be connected to a properly wired and grounded electrical outlet.
- When disconnecting the display, the plug must be unplugged from the power outlet.

The power outlet should be easy to plug and unplug the power cord. To take special precautions against dangers when using, installing, servicing, transporting, or storing the equipment, prepare the necessary instructional notes.

To reduce the risk of electric shock, do not perform any maintenance not described in the operating instructions unless you are qualified to do so.

Handling:

- If the display weighs more than 18 kg (39.68 lbs.), it is recommended that two people move or lift the display.

Chapter 1. New Member Guide

This user guide provides detailed operation instructions. For Quick overview instructions, see the Quick Start Guide for brief information.

N27p Supports Lenovo Accessories and Display Manager- **Artery**.

Items List

The following items should be included in the package of this product:

- Quick Start Guide
- Display
- Stand
- Base
- Power Cord
- Signal Line (Subject to the practice)
- Package of screws (Screws *4PCS)



Precautions For Use

To set up your display, please refer to the following illustration.

Note: Do not touch the screen area of the display. The screen area is a glass product and can be easily damaged by friction or pressure.



1. Place the display screen down on a soft flat surface.
2. Align the support with the base and tighten the hand screws clockwise.
3. Insert the installed support base into the corresponding position on the back of the monitor, and then turn the hand screws clockwise.

Note: To install the VESA mount, see "Wall-mounted (optional)" on pages 2-10.

Product Overview

This section describes how to adjust the display position, set the user controls, and use the cable lock slot.

Adjustment Types

Tilt

See the figure below for an example of the tilt range.

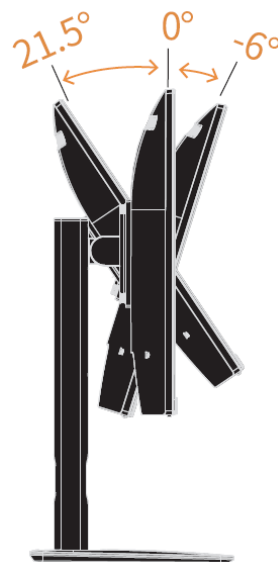

Height Adjustment

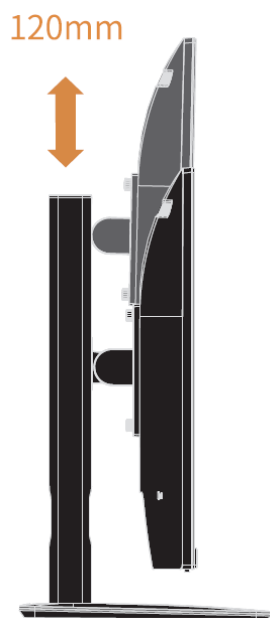

Pivot

Before the display is shown in the vertical direction, it should be fully lift up and fully tilted to avoid collisions.

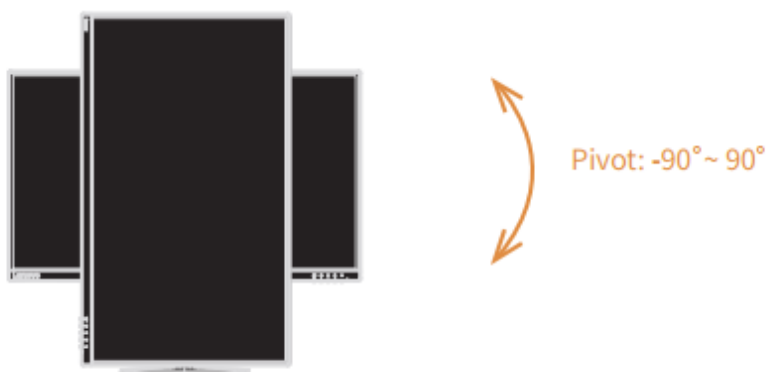

Swivel

With the built-in base, you can tilt and rotate the display to get the best viewing angle.

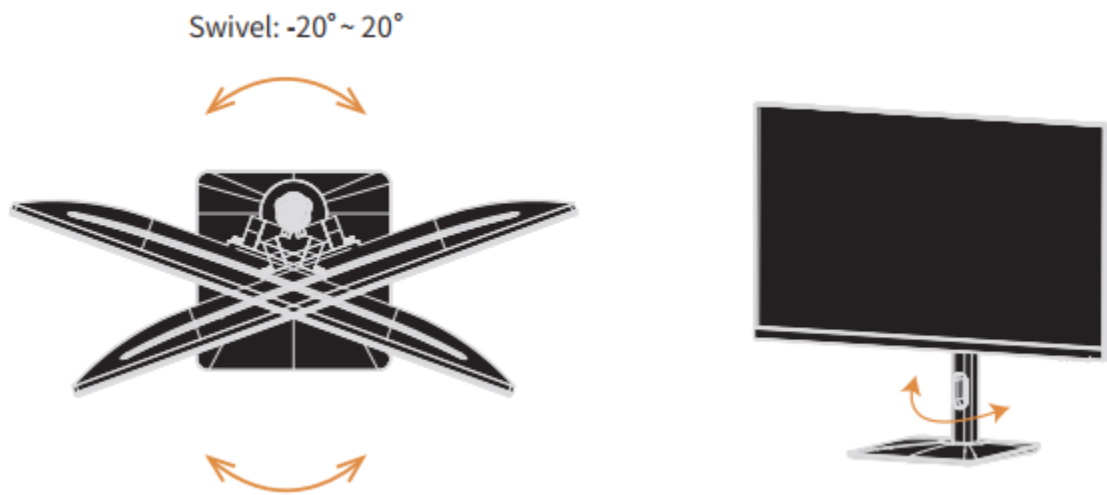

Display Control

Different functions can be used through the key controls on the panel frame.



For information on how to use these key controls, see "Adjusting the Display Image" on pages 2-3.

Kensington anti-theft lock

Your display is equipped with a Kensington anti-theft lock, which is located on the back of the display.

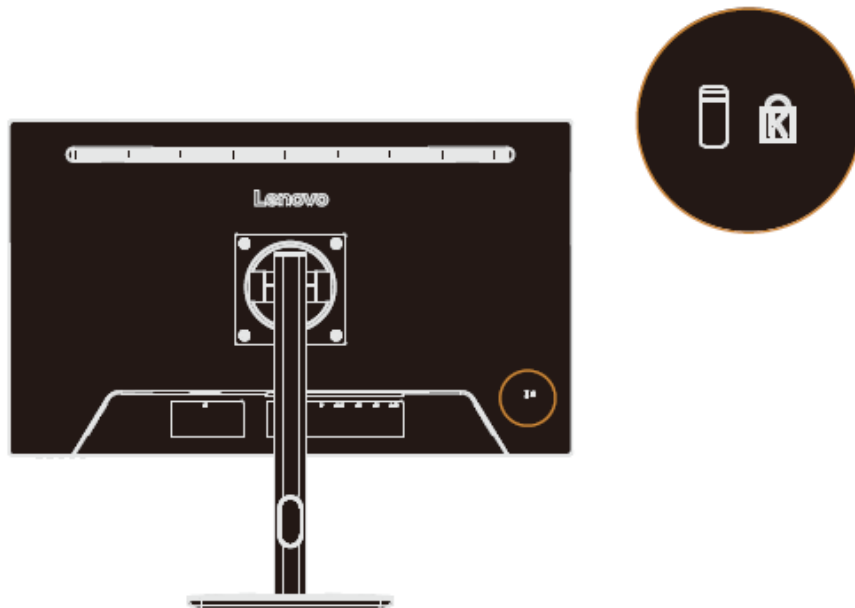

Set Up the Display

This section describes how to set up the display.

Connecting and Powering on the Display

Note: Before performing this procedure, be sure to read the "Safety Matters" on page iv.

1. Turn off the power to the computer and all connected devices, and then unplug the computer's power cord.



2. Connect the cables as shown in the figure below.

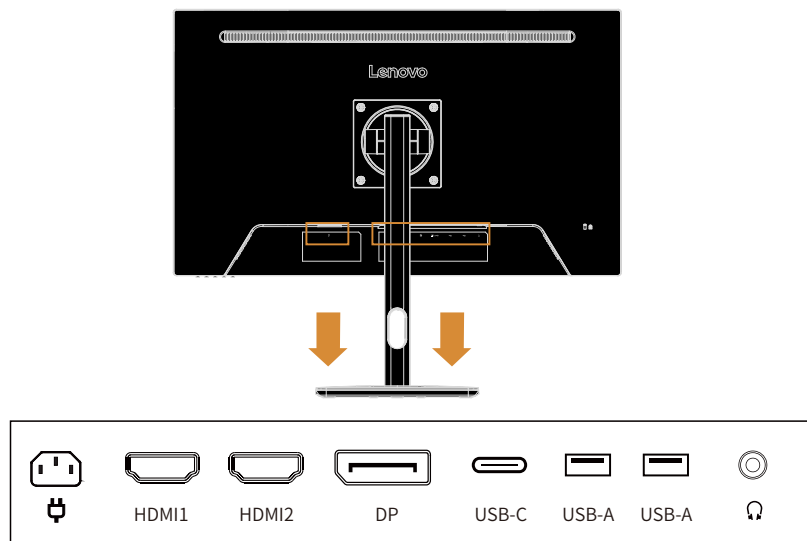

3. For computers with HDMI1/HDMI2 connections.

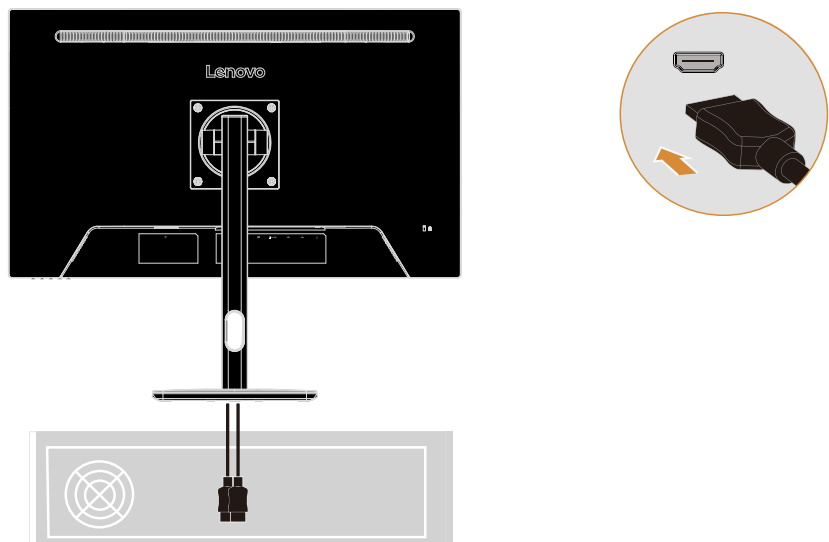

4. For computers with DP connections.

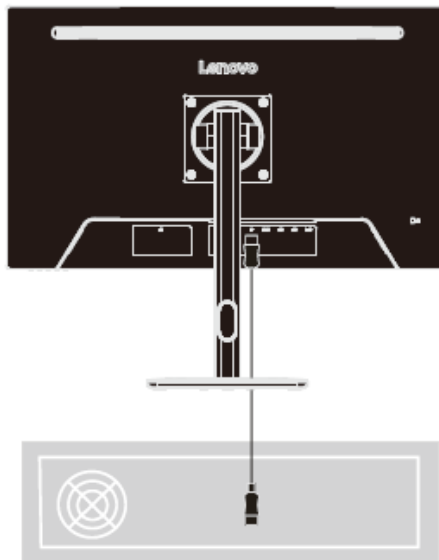

5. For computers with USB-C connections.

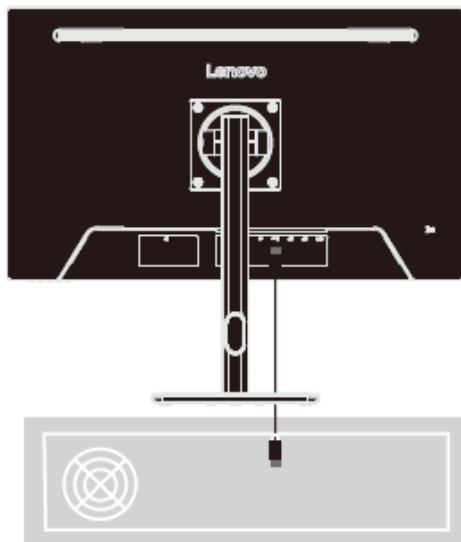

6. For computers with USB-A connections.

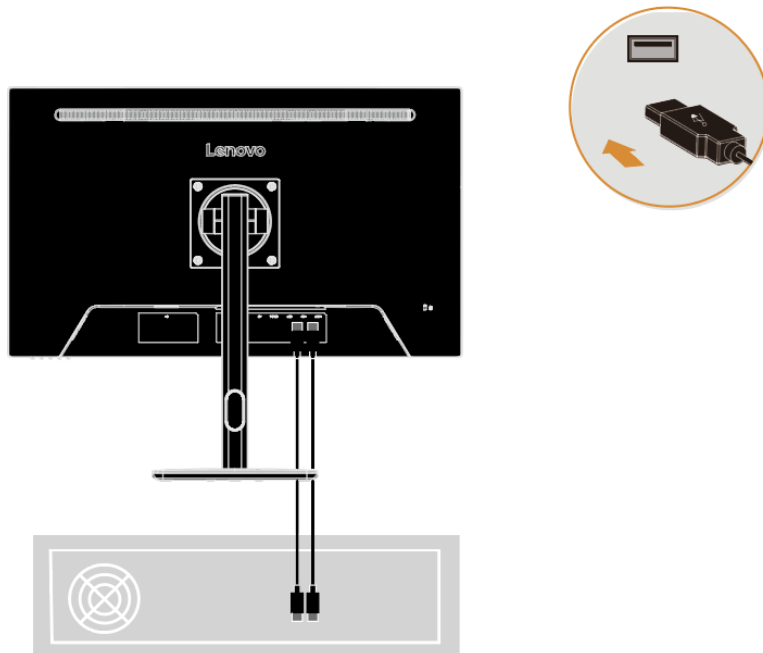

7. Connect the audio cable of the speaker and the audio jack of the monitor to transmit the audio source from HDMI.

Note: HDMI mode audio output.

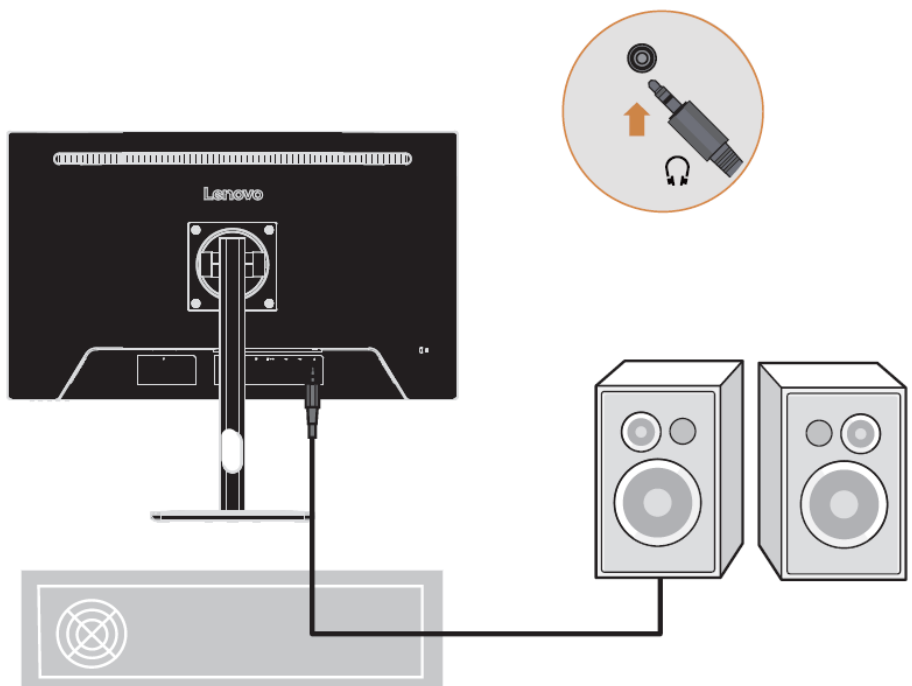

8. Plug the power cord into the display, and then plug the display power cord and computer cord into a grounded power outlet.

Note: A certified power cord must be used for this equipment. The installation and/or equipment regulations of the country concerned should be taken into account. The certified power cable used should not be lighter than the normal PVC cable (marked H05VV-F 3G 0.75mm² or H05VWH2-F2 3G 0.75mm²) as specified in IEC 60227. In addition, synthetic rubber cords as specified in IEC 60245 (marked H05RR-F 3G 0.75mm²) should be used.

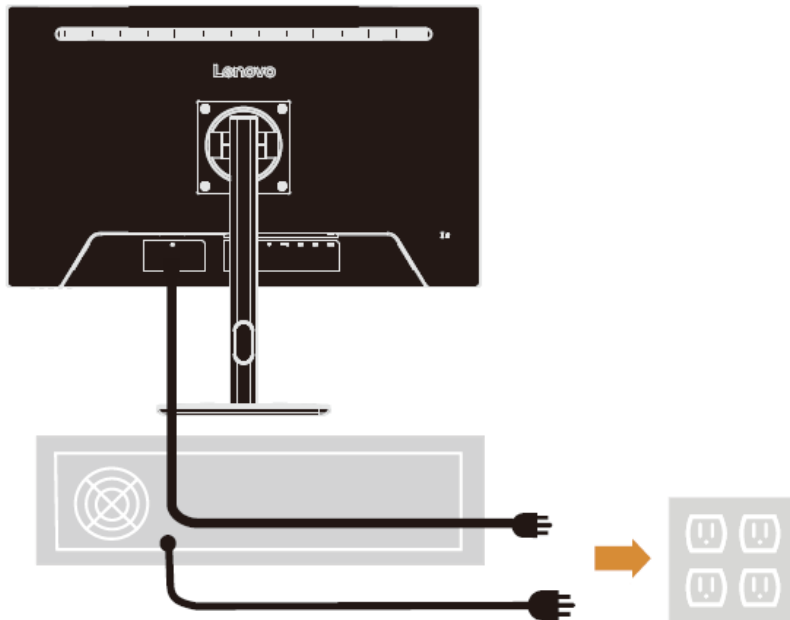

9. Cables can be connected using the cable management holes on the support.

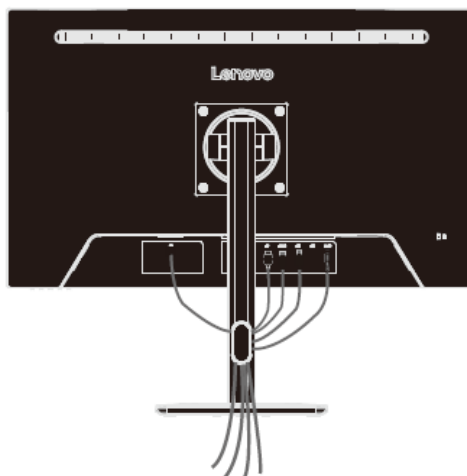

10. Turn on the power to the display and computer.



11. When you install the display driver, download the driver that corresponds to your display model from the Lenovo website at <http://support.lenovo.com.cn/>. To install the driver, see the "Manually Install the Driver for the Display" section on pages 3-5.



Chapter 2. Adjusting and Using the Display

This section describes how to adjust and use this display.

Comfort and Assistance Functions

Good ergonomic designs are important for the comfortable use of your personal computer. Your workplace and the equipment you use should be arranged appropriately for your personal needs and the type of work you do. In addition, healthy work habits can help you achieve optimal efficiency and comfort when using a computer.

Arrange Your Working Area

Use a work surface of the right height and enough work area so that you can work comfortably. Arrange your work area according to the way you use materials and equipment. Keep frequently used materials neatly organized in your work area, and place frequently used items (such as a computer mouse or telephone) in an easily accessible location. The placement and setup of equipment are very important to your work posture. The following topics describe how to optimize equipment settings to achieve and maintain a good working posture.

Placing and Viewing the Display

For comfortable viewing of the display, the following factors should be considered when placing and adjusting computer displays:

- **Viewing Distance:** The recommended viewing distance between your eyes and the display screen is 1.5X the screen diagonal. Solutions to meet this required distance in a small office include: keeping the desk a certain distance from the wall or partition to allow space for the display, using a flat panel or smaller display and keeping the display in the corner of the desk, or placing the keyboard in an adjustable drawer board to create a deeper work surface.
- **Display Height:** If your display is not height-adjustable, place your head and neck in a natural, comfortable (vertical or upright) position. If your display is not height-adjustable, you can place a book or other sturdy object under the base of the display to achieve the desired height. The general rule is to sit comfortably with the top of the display screen at eye level or slightly lower. However, it is important to optimize the height of the display so that the relative position between the eyes and the center of the display provides the right visual distance and a comfortable viewing experience when the eye muscles are relaxed.
- **Tilt:** Adjusting the tilt of your display optimizes the appearance of your screen content and keeps your head and neck in the best possible position.
- **Regular Location:** Place the display in such a way that overhead lighting or nearby windows do not cause glare or reflection on the screen.

Here are some additional tips for comfortable viewing of your display:

- Use adequate lighting for the type of work you do.
- Use display brightness, contrast, and image controls (if available) to optimize the image on the screen for your visual needs.
- Keep the display screen clean so that you can see the content clearly.

Long periods of focused visual activity tend to strain the eyes. Be sure to periodically move away from the display screen and gaze at a distant object to relax your eye muscles. If you have any questions about eye strain or visual discomfort, consult vision care professional for advice.

Tips on Healthy Work Habits

The following is a summary of some important factors that are useful to keep you comfortable and productive while using your computer.









- **Good posture comes from equipment placement:** The layout of your work area and the placement of your computer equipment can have a significant impact on your posture while using the computer. Be sure to follow the tips listed in " Arrange Your Working Area" on pages 2-1 to optimize the placement and orientation of your equipment so you can maintain comfortable posture and efficiency. In addition, be sure to use the adjustment features of your computer components and office furniture to meet your needs, and adjust them over time as your needs change.
- **Slight changes in posture help keep you comfortable:** the longer you sit in front of a computer, the more important it becomes to pay attention to your work posture. Avoid maintaining one posture for long periods. Regular slight changes in posture can help prevent possible discomfort. Use the adjustment function provided by office furniture or equipment to adapt to changes in posture.
- **Regular short breaks help ensure healthy computing:** Because computing is primarily a static activity, it is especially important to take short breaks during the workday. Take regular breaks to stand in front of your work area, stretch your limbs, walk around or have a drink, or otherwise take a short break from using the computer. Taking short breaks during work allows for changes in body posture that can help you stay comfortable and productive while working.

Adjusting the Display Image

This section describes the functions of the user controls used to adjust the display image.

Using Direct Access Controls

When On Screen Display (OSD) is not displayed, you can use direct access controls.

Icon	Control	Description
	Power	Power on/off
 	Menu/Confirm	Open the OSD Menu; Enter the next level menu; Press and hold for 10s to lock/unlock the menu.
 	Downward	Performs the OSD menu brightness shortcut function; When the OSD menu is opened, it serves to move the cursor downwards; In the adjustment bar, it acts as a value reduction.
 	Upward	Performs the OSD menu sound shortcut function; When the OSD menu is opened, it serves to move the cursor upwards; In the adjustment bar, it acts as a value increase.
 	Exit	Signal source selection switching shortcut function; Returns to the OSD upper level menu; When a signal is present, press and hold for 10 seconds to enable or disable the DDC-CI function.

Use the On-Screen Display (OSD) Control

When adjusting the settings, you can view the user controls through the OSD.

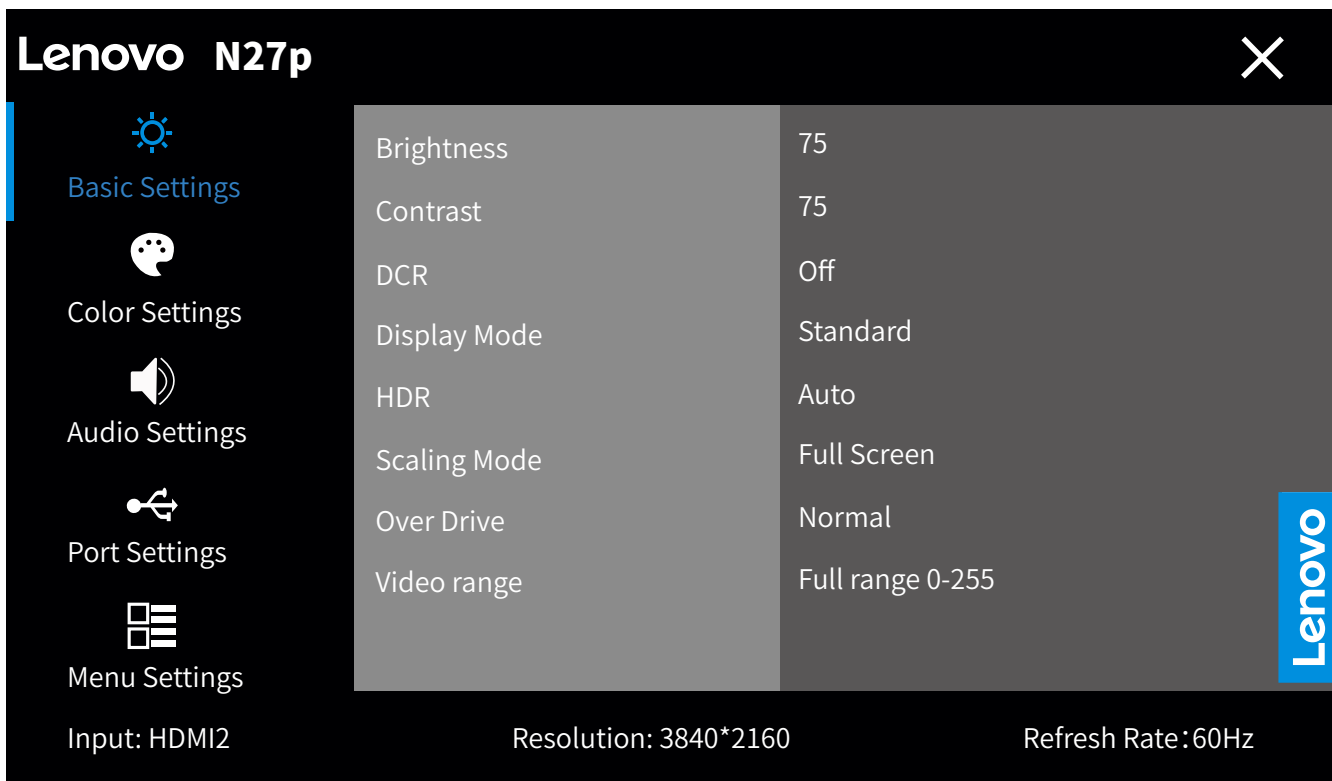

Use controls:







1. Press  to open the OSD Main Menu.
2. Use \uparrow or \downarrow to move between icons. Select an icon and press \leftarrow to access the feature. If there is a submenu, use \uparrow or \downarrow to move between options, and then press \leftarrow to select the feature. Use \uparrow or \downarrow to make adjustments, and then press \leftarrow to save.
3. Press \rightarrow to exit the submenu in sequence, and then exit the OSD.
4. When OSD is not displayed, press \leftarrow and hold for 10 seconds to lock the OSD. In this way, you can prevent accidental adjustment of the OSD. Press \leftarrow and hold for 10 seconds to unlock the OSD for OSD adjustment.
5. DDC/CI is enabled by default. Press \rightarrow and hold for 10 seconds to disable/enable the DDC/CI function. The message "DDC/CI disable (DDC/CI enable)" is displayed on the screen.

Table 2-1. OSD Functions

Main Menu	Submenu	Description	Controls and Adjustment	
 Basic Settings	Brightness	Adjust the overall brightness of the screen		
	Contrast	Adjust the screen contrast		
	DCR	On		Power consumption Changing this setting will increase the power consumption. Change/Cancle
		Off		
	Display Mode	Standard		
		Game		
		Movie		
		Web		
		Picture		
	HDR	Auto		
		HDR Photo		
		HDR Movie		
		HDR Game		
		HDR 400		
		HDR off		
Scaling Mode	Original AR		Non-16:9 signal adjustable	
	Full Screen			
Over Drive	Off			
	Normal			
	Extreme			
Video range	Auto		Note: Refers to RGB range of HDMI input.	
	Full range 0-255			
	Limited range 16-235			
 Color Settings	DCI-P3	/		
	sRGB	/		
	Warm	/		
	Neutral	/		
	Cool	/		
	Custom	Red		0-100
		Green		0-100
		Blue		0-100
Low Blue Light	/			

 Audio Settings	Volume	0-100	
	Mute	On	
		Off	
 Port Settings	Input Signal	Auto Switch Input	Switching the signal source
		USB-C	
		DP	
		HDMI2	
		HDMI1	
	USB Charging	On	
		Off	
	USB Select	USB 3.2	
		USB 2.0	
	DP Select	DP 1.2	
DP 1.4			
 Menu Settings	Information	Model Name: N27p Refresh Rate: 60Hz Firmware: Scaler L1.0 PD 8.20 USB Hub 1.00 Serial Number: UMA00001	
	Language	English	
		Français	
		Italiano	
		简体中文	
		Español	
		日本語	
		Deutsch	
		Русский	
		Українська	
	ไทย		
	Button Repeat Rate	Default	
		Slow	
		Off	
	LED Indicator	On	
		Off	
	OSD Timeout	5-60S	
Menu Position	Menu Horizontal Position 0-100		

		Menu Vertical Position 0-100	
	Transparency	0-100	
	DDC/CI	On	
		Off	
	Factory Reset	No	
		Reset	

Low Blue Light

Concerns about the effects of blue light on eye health have been growing for years. The wavelength of blue light is between 300 nanometers and 500 nanometers. This display reduces the emission of blue light in the default setting mode. The display meets the requirements for low blue light (software solution).

Select Supported Display Modes

The display mode used by the display is controlled by the computer. Therefore, you should refer to the computer's documentation for detailed information on how to change the display mode.

When the display mode is changed, the image size, position, and shape may change. This is normal and the image can be readjusted using the automatic image settings and image controls.

Unlike CRT displays, which require high refresh rates to minimize flicker, LCD or flat panel technology is inherently flicker-free.

Note: If the system has previously been used in conjunction with a CRT display and is currently configured for a display mode outside the range of that display, you may need to temporarily reconnect the CRT display until the system has been reconfigured; it is best to set it to 3840 x 2160 (60 Hz), the normal display mode.

The display modes shown below are factory optimized.

Table 2-2. Display modes set by the manufacturer

Timing sequence	Refresh rate	Signal Channel
640 x 480	60 Hz	HDMI1/HDMI2 DP/USB-C
640 x 480	75 Hz	
720 x 400	70 Hz	
800 x 600	60 Hz	
800 x 600	75 Hz	
832 x 624	75 Hz	
1024 x 768	60 Hz	
1024 x 768	70 Hz	
1024 x 768	75 Hz	
1152 x 864	75 Hz	
1280 x 1024	60 Hz	
1280 x 1024	75 Hz	
1440 x 900	60 Hz	
1600 x 900	60 Hz	
1680 x 1050	60 Hz	
1920 x 1080	60 Hz	
2560 x 1440	60 Hz	
3840 x 2160	60 Hz	

Understanding Power Management

The power management function is activated when the computer detects that the mouse or keyboard has not been used for a user-defined time interval. There are several states as described in the table below. For best performance, it is best to turn off the display at the end of the day, or when it is not in use for a longer period during the day.

Table 2-3. Power Indicators

Status	Power indicator	Screen	Recovery Operation
On	White	Normal	
Standby/Hang up	Amber	Blank	Press any key or move the mouse. The response time may be slightly delayed. Note: When there is no image output to the display, it will also enter standby mode.
Off	Off	Blank	Press the power button to power on. There may be a slight delay before the image is redisplayed.

Power Management Mode

VESA Mode	Horizontal Synchronization	Vertical Synchronization	Video	Power indicator	Power consumption
Normal Operation	Active	Active	Events	White	114.5 W (Max)* 26.5 W (Typical)
Active-Off Mode	Inactive	Inactive	Close	Amber	Less than 0.5 W
Off	-	-	-	Off	Less than 0.3 W

* Maximum power consumption for maximum brightness.

This document is for reference only and reflects laboratory performance. Your product performance will vary depending on the software, components, and peripherals you order, and it should not be your responsibility to update this information. Accordingly, customers should not rely on this information to make decisions regarding electronic fault tolerance or similar items. We make no express or implied warranties as to accuracy or completeness.

Maintaining the Display

Always turn off the power to the display before performing any maintenance work on the display.

Do not:

- Let water or liquids spill onto the display.
- Use solvents or abrasive substances.
- Use flammable cleaning materials to clean the display or any other electronic device.
- Touch the screen area of the display with sharp or abrasive objects. Such contact may cause permanent damage to the screen.
- Use any cleaner that contains an anti-static solution or similar additive. Otherwise, the coating of the screen area may be damaged.

Be sure to:

- Wipe the case and screen gently with a soft cloth lightly dampened in water.
- Use a damp cloth and a little flexible cleaner to remove fingerprints and grease.

Remove the Display Base and Support Arm

Step 1: Place the monitor on a flat surface.

Step 2: Turn the screws on the back of the support arm and the monitor counterclockwise to separate the support arm from the monitor.

Step 3: Rotate the screw at the connection between the support arm and the base counterclockwise to separate the base from the support arm.

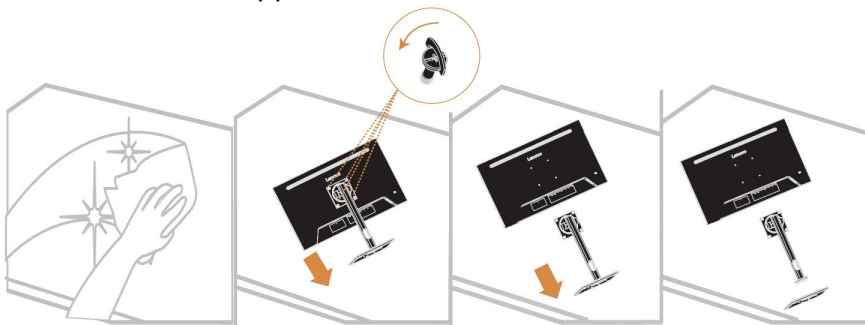

Wall-mounted (optional)

Refer to the instructions attached with the base assembly. To convert the LCD from a desktop to a wall mount, perform the following steps :

Step 1: Make sure the power button is off and unplug the power cord.

Step 2: Place the LCD face down on a towel or blanket.

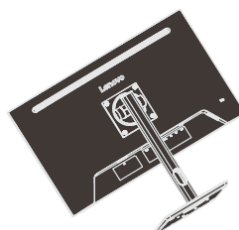

Step 3: Remove the base and stand from the display, see "Removing the Display Base and Support Arm" on pages 2-10.



Step 4: Install the assembly bracket for the VESA compatible wall mount (100mm x 100mm distance), VESA assembly screws M4 x 10 mm.

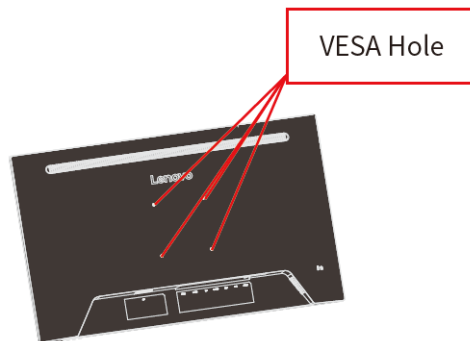

Step 5: Mount the LCD to the wall following the instructions for the wall mount. Only the lightest weight/weight-bearing wall mount from the UL list should be used: 8kg

Note: When using the flexible arm, the display should not be tilted downward by more than 5 degrees.

Chapter 3. Reference Information

This section provides display specifications, instructions for manual installation of the display driver, and troubleshooting information.

Display Specifications

Table 3-1. Display Specifications - Model H24270UN0

Size	Depth	228.9 mm (9.01 in.)
	Height	533.1~413.1 mm (20.99~16.26 in.)
	Width	615.0 mm (24.21 in.)
Support Arm	Tilt	Range : -6°~21.5°
	Swivel	Range : -20°~20°
	Pivot	Range : -90°~90°
	Lift	Range : 120 mm
VESA mount	Support	100 mm x 100 mm (3.94 in. x 3.94 in.)
Image	Viewable image size	684.7 mm (27 in.)
	Maximum height	335.664 mm (13.22 in.)
	Maximum width	596.736 mm (23.49 in.)
	Pixel pitch	0.1554(H) x 0.1554(V) mm
Power input	Supply voltage	100-240V AC 2.0A
	Max. power supply current	
Power Consumption Note: The power consumption value is the power consumption of both the display and the power supply.	Normal operation	<114.5 W (max) <26.5 W (typical)
	Standby/Hang Up	<0.5 W
	Off Note: No USB/camera/external speakers	<0.3 W
HDMI1/HDMI2	Input signal	HDMI1/HDMI2
	Horizontal addressing capability	3840 pixels (max)
	Vertical addressing capability	2160 pixels (max)
	Clock frequency	594 MHz (max)
DP	Input signal	DP
	Horizontal addressing capability	3840 pixels (max)
	Vertical addressing capability	2160 pixels (max)
	Clock frequency	594 MHz (max)

USB-C	Input signal	USB-C
	Horizontal addressing capability	3840 pixels (max)
	Vertical addressing capability	2160 pixels (max)
	Clock frequency	594 MHz (max)
Communication	VESA DDC/CI	
Supported display modes	Horizontal frequency	63.75 kHz - 138.9 kHz
	Vertical frequency	40 Hz - 62 Hz
	Self-resolution	3840 x 2160 @ 60 Hz
Temperature	At working time	0° ~ 40°C (32°F ~ 104°F)
	During storage	-20° ~ 60°C (-4°F ~ 140°F)
	During transport	-20° ~ 60°C (-4°F ~ 140°F)
Humidity	At working time	10% ~ 80% (non-condensing)
	During storage	5% ~ 95% (non-condensing)
	During transport	5% ~ 95% (non-condensing)

Troubleshooting

If you encounter problems setting up or using your display, you may be able to solve the problem. Before contacting your dealer or Lenovo, please try the following suggested actions depending on the problem you are experiencing.

Table 3-2. Troubleshooting

Problem	Possible Causes	Recommended Operations	Refer to
"Out of Range" is displayed on the screen and the power indicator flashes white.	This display does not support the display mode set by the system	<ul style="list-style-type: none"> •If you are replacing an old display, reconnect it and adjust the display mode to the range supported by the new display. •If you are using a Windows system, restart the system in safe mode and select a supported display mode for your computer. •If these options do not work, please contact Customer Support. 	"Select Support Display Mode" on pages 2-8.
Poor image quality	The video signal cable is not well connected to the display or the system.	Make sure the signal cable is securely plugged into the system and display.	"Connecting and Powering on the Display" on pages 1-6.
	The color setting may be incorrect.	Select another color setting in the OSD menu.	"Adjusting the Display Image" on pages 2-3.
	The automatic image setting function is not performed.	Perform automatic image setup.	"Adjusting the Display Image" on pages 2-3.
The power indicator does not light up and no images are displayed.	<ul style="list-style-type: none"> •The display's power switch is not turned on. •The power cord is loose or not connected. •The outlet has no electricity. 	<ul style="list-style-type: none"> •Make sure the power cord is well connected. •Make sure the outlet has power. •Power on the display. •Change the power cord. •Change the power outlet. 	"Connecting and Powering on the Display" on pages 1-6.
The screen is blank and the power indicator shows amber.	The display is in standby/hang-up mode	<ul style="list-style-type: none"> •Press any key on the keyboard or move the mouse to resume operation. •Check the power options settings on the computer. 	"Understanding Power Management" on pages 2-9.
The power indicator shows amber and no images are displayed	Video signal cable is loose or disconnected from the system or display.	Make sure the video cable is well connected to the system.	"Connecting and Powering on the Display" on pages 1-6.
	The display brightness and contrast are at their lowest settings.	Adjust the Brightness and Contrast settings in the OSD menu.	"Adjusting the Display Image" on pages 2-3.
One or more pixels change color	This is an inherent characteristic of LCD technology and is not an LCD defect.	If more than five pixels are missing, please contact Support Center	"Appendix A. Service and Support" on pages A-1.

Problem	Possible Causes	Recommended Operations	Refer to
<ul style="list-style-type: none"> •Blurred lines or images in text •Horizontal or vertical lines are present in the image. 	<ul style="list-style-type: none"> •Image settings are not optimized •The system's display property settings are not optimized. 	Adjust the system's resolution setting to the resolution of this display: 3840 x 2160 @ 60 Hz.	"Adjusting the Display Image" on pages 2-3.
		Perform the automatic image setting. If the automatic image setting does not work, perform the manual image setting.	"Select Support Display Mode" on pages 2-8.
		When using its resolution, adjusting the Dots Per Inch (DPI, dots per inch) setting on the system can further improve it.	See the Advanced section of System Display Properties.

Manually installing the monitor driver

Below are steps for manually installing the monitor driver in Microsoft Windows 10, Microsoft Windows 11.

1. Turn off the computer, all attached devices.
2. Ensure that the monitor is connected correctly.
3. Turn on the monitor and then the system unit. Allow your computer to start the Windows operating system.
4. From the Lenovo website <https://pcsupport.lenovo.com/solutions/N27p>, find the corresponding monitor driver and download it to a PC to which this monitor is connected (such as a desktop).
5. Right-click the **Windows Start** button on the desktop, then click **Device Manager**, and double click **Monitor**.
6. Double-click **Generic Monitor**.
7. Click the **Driver** tab.
8. Click **Update Driver**, and then click **Browse Computer to find the driver**.
9. Click **Let me pick from a list of available drivers on my computer**.
10. Click the **Have Disk...** button. By clicking the **Browse** button, browse and point to the following path:
X:\Monitor Drivers\Windows (where X indicates “the folder in which the downloaded driver is located” (such as a desktop)).
11. Select **N27p.inf** file, Click **Open** button. Click **OK** button.
12. In the new window, select **N27p** and click **Next**.
13. After the installation is complete, delete all downloaded files and close all Windows.
14. Restart the system. The system will automatically select the refresh rate and the corresponding color matching profile.

Note: Unlike CRTs, LCD displays do not improve display quality by increasing the refresh rate. Lenovo recommends using a 3840 x 2160 @ 60 Hz refresh rate.

Get further help

If you are still unable to resolve the issue, please contact Lenovo Support. For more information on contacting the Support Center, see "Appendix A. Service and Support" on page A-1.

Appendix A. Services and Support

The following information describes the technical support available to you during the warranty period or lifetime of the product. For a complete explanation of Lenovo's warranty terms, see the Lenovo Limited Warranty.

Register Your Option

Please register to receive product service and support updates as well as free and discounted computer accessories and content. Visit: <http://www.lenovo.com/support>

Online Technical Support

Enjoy lifetime online technical support for your product: <http://www.lenovo.com/support>

During the warranty period, the product is also covered by replacement assistance or defective component replacement services. In addition, if your option is installed in a Lenovo computer, you may be entitled to on-site service. Lenovo technical support representative can help you determine the best way to proceed.

Telephone Technical Support

The Customer Support Center will continue to provide installation and netting support for 90 days after the option is removed from the market. After this time, Lenovo will, at its discretion, no longer provide support or provide paid support. Other support services are charged at the published cost.

Before contacting the Lenovo Technical Support representative, please have the following information ready: option name and number, proof of purchase, computer manufacturer, model, serial number and manual, exact content of error messages, description of the problem, and hardware and software configuration information for your system.

A technical support representative may be available by phone to guide you through the problem while you are at the computer.

Phone numbers are subject to change without notice. For an updated list of telephone numbers for Lenovo support services, please visit: <http://www.lenovo.com/support>

Country or Region	Telephone Number
Argentina	0800-666-0011 (Spanish, English)
Australia	1-800-041-267 (English)

Austria	0810-100-65 (For local rate) (German)
Belgium	Warranty service and support: 02-339-36-11 (Dutch, French)
Bolivia	0800-10-0189 (Spanish)
Brazil	Calls made from within the Sao Paulo region: 11-3889-8986 Calls made from outside the Sao Paulo region: 0800-701-4815 (Portuguese)
Brunei Darussalam	Dial 800-1111 (English)
Chile	800-361-213 (Spanish)
China	400-990-8888
China (Hong Kong S.A.R.)	(852) 3516-8977 (Cantonese, English, Mandarin)
China (Macau S.A.R.)	0800-807 / (852) 3071-3559 (Cantonese, English, Mandarin)
Colombia	1-800-912-3021 (Spanish)
Costa Rica	0-800-011-1029 (Spanish)
Croatia	385-1-3033-120 (Croatian)
Cyprus	800-92537 (Greek)
Czech Republic	800-353-637 (Czech)
Denmark	Warranty service and support: 7010-5150 (Danish)
Dominican Republic	1-866-434-2080 (Spanish)
Ecuador	1-800-426911-OPCION 4 (Spanish)
Egypt	Primary: 0800-0000-850 Secondary: 0800-0000-744 (Arabic, English)
El Salvador	800-6264 (Spanish)
Estonia	372-66-0-800 (Estonian, Russian, English)
Finland	Warranty service and support: +358-800-1-4260 (Finnish)
France	Warranty service and support: 0810-631-213 (hardware) (French)
Germany	Warranty service and support: 0800-500-4618 (toll-free) (German)
Greece	Lenovo Business Partner (Greek)
Guatemala	Dial 999-9190, wait for operator, and request to reach 877-404-9661 (Spanish)

Honduras	Dial 800-0123 (Spanish)
Hungary	+36-13-825-716 (English, Hungarian)
India	Primary: 1800-419-4666 (Tata) Secondary: 1800-3000-8465 (Reliance) Email: commercialts@lenovo.com (English and Hindi)
Indonesia	1-803-442-425 62 213-002-1090 (Standard Charges Apply) (English, Bahasa Indonesia)
Ireland	Warranty service and support: 01-881-1444 (English)
Israel	Givat Shmuel Service Center: +972-3-531-3900 (Hebrew, English)
Italy	Warranty service and support: +39-800-820094 (Italian)
Japan	0120-000-817 (Japanese, English)
Kazakhstan	77-273-231-427 (Standard Charges Apply) (Russian, English)
Korea	080-513-0880 (Collect call) 02-3483-2829 (Toll Call) (Korean)
Latvia	371-6707-360 (Latvian, Russian, English)
Lithuania	370 5278 6602 (Italian, Russian, English)
Luxembourg	ThinkServer and ThinkStation: 352-360-385-343 ThinkCentre and ThinkPad: 352-360-385-222 (French)
Malaysia	1-800-88-0013 03-7724-8023 (Standard Charges Apply) (English)
Malta	356-21-445-566 (English, Italian, Maltese Arabic)
Mexico	001-866-434-2080 (Spanish)
Netherlands	020-513-3939 (Dutch)
New Zealand	0508-770-506 (English)
Nicaragua	001-800-220-2282 (Spanish)
Norway	8152-1550 (Norwegian)
Panama	Lenovo Customer Support Center: 001-866-434 (toll-free) (Spanish)

Peru	0-800-50-866 OPCION 2 (Spanish)
Philippines	1-800-8908-6454 (GLOBE subscribers) 1-800-1441-0719 (PLDT subscribers) (Tagalog, English)
Poland	Laptops and tablets branded with logo Think: 48-22-273-9777 ThinkStation and ThinkServer: 48-22-878-6999 (Polish, English)
Portugal	808-225-115 (Standard Charges Apply) (Portuguese)
Romania	4-021-224-4015 (Romanian)
Russia	+7-499-705-6204 +7-495-240-8558 (Standard Charges Apply) (Russian)
Singapore	1-800-415-5529 6818-5315 (Standard Charges Apply) (English, Mandarin, Bahasa Malaysia)
Slovakia	ThinkStation and ThinkServer: 421-2-4954-5555
Slovenia	386-1-2005-60 (Slovenian)
Spain	34-917-147-833 (Spanish)
Sri Lanka	9477-7357-123 (Sumathi Information systems) (English)
Sweden	Warranty service and support: 077-117-1040 (Swedish)
Switzerland	Warranty service and support: 0800-55-54-54 (German, French, Italian)
China Taiwan	0800-000-702 (Mandarin)
Thailand	001-800-4415-734 (+662) 787-3067 (Standard Charges Apply) (Thai, English)
Turkiye	444-04-26 (Turkish)
United Kingdom	Standard warranty support: 03705-500-900 (local rate) Standard warranty support: 08705-500-900 (English)
United States	1-800-426-7378 (English)
Uruguay	000-411-005-6649 (Spanish)
Venezuela	0-800-100-2011 (Spanish)
Vietnam	120-11072 (Toll Free) 84-8-4458-1042 (Standard Charges Apply) (Vietnamese, English)

Appendix B. Declaration

Lenovo may not offer the products, services, or features discussed in this document in all countries (regions). For information about products and services that may be available in your region, please consult your local Lenovo representative. Any reference to Lenovo products, programs, or services does not express or imply that only Lenovo's products, programs, or services may be used. Any product, program, or service with equivalent functionality may be used as long as it does not infringe any of Lenovo's intellectual property rights. However, it is the responsibility of the user to evaluate and verify the operation of any other product, program, or service.

Lenovo may own or be applying for patents on the items mentioned in this document. The distribution of this document does not give you a license to use these patents. You may make inquiries in writing by sending a license to the following address:

*Lenovo (United States), Inc.
1009 Think Place - Building One
Morrisville, NC 27560
U.S.A
Attention: Lenovo Director of Licensing*

Lenovo provides this publication "as is" without warranty of any kind, either express or implied, including, but not limited to, any implied warranties of non-infringement, merchantability, or fitness for a particular purpose. Some jurisdictions do not allow the exclusion of express or implied warranties in certain transactions, so this disclaimer may not apply to you.

The information in this publication may contain technical inaccuracies or typographical errors. The information in this manual is subject to periodic change; such changes will be included in subsequent editions of this publication. Lenovo may make improvements and/or changes to the products and/or procedures described in this publication at any time without notice.

The products described in this document are not suitable for use in applications such as porting or other life support. In these applications, personal injury or even death may result if they do not work properly. The information contained in this document does not affect or change Lenovo product specifications or warranties. No information in this document is intended as an express or implied license or disclaimer of Lenovo or third-party intellectual property rights. All information in this document has been obtained in a specific environment and is provided as an explanatory note only. Results obtained in other operating environments may differ.

Lenovo may use or publish any information you provide in any manner it deems appropriate that does not infringe your rights.

Any references to non-Lenovo websites in this publication are for convenience purposes only and do not in any way constitute an endorsement of those websites. The information on these sites is not part of this Lenovo product literature and the use of these sites is at your own risk.

The performance data provided herein was obtained in a controlled environment. Therefore, results obtained in other operating environments may vary significantly. Some measurements may have been obtained on development-level systems and therefore cannot be guaranteed to be identical on conventional systems. In addition, some measurements may have been obtained by inferential evaluation. Actual results may vary. Users of this document should verify the appropriate data for their particular environment.

Recycling Information

Lenovo encourages owners of information technology (IT) equipment to take responsibility for recycling the equipment they no longer need. For information on recycling Lenovo products, please visit: <http://www.lenovo.com/recycling>

環境配慮に関して

本機器またはモニターの回収リサイクルについて

企業のお客様が、本機器が使用済みとなり廃棄される場合は、資源有効利用促進法の規定により、産業廃棄物として、地域を管轄する県知事あるいは、政令市長の許可を持った産業廃棄物処理業者に適正処理を委託する必要があります。また、弊社では資源有効利用促進法に基づき使用済みパソコンの回収および再利用・再資源化を行う「PC 回収リサイクル・サービス」を提供しています。詳細は、https://www.lenovo.com/jp/ja/services_warranty/recycle/pcrecycle/ をご参照ください。

また、同法により、家庭で使用済みとなったパソコンのメーカー等による回収再資源化が 2003 年 10 月 1 日よりスタートしました。詳細は、https://www.lenovo.com/jp/ja/services_warranty/recycle/pcrecycle/ をご参照ください。

重金属を含む内部部品の廃棄処理について

本機器のプリント基板等には微量の重金属（鉛など）が使用されています。使用後は適切な処理を行うため、上記「本機器またはモニターの回収リサイクルについて」に従って廃棄してください。

Collect and Recycle Used Lenovo Computers or Displays

If you are a company employee and need to dispose of a Lenovo computer or display that is a company asset, it must be disposed of following the requirements of the Resource Efficient Use Promotion Act. Computers and displays are industrial waste and should be properly disposed of by a local government-approved industrial waste disposal facility. Lenovo Japan collects, reuses, and recycles used computers and monitors through its PC, collection, and recycling services, as required by the Resource Efficient Use Promotion Law. For more information, visit the Lenovo Web site: https://www.lenovo.com/jp/ja/services_warranty/recycle/pcrecycle. The collection and recycling of home computers and displays by the manufacturer began on October 1, 2003, following the provisions of the Resource Efficient Use Promotion Act. This service is available free of charge for home computers sold after October 1, 2003. For more information, please visit Lenovo's Web site: https://www.lenovo.com/jp/ja/services_warranty/recycle/personal.

Discarded Lenovo Computer Components

Some Lenovo computer products sold in Japan have components that may contain heavy metals or other environmentally sensitive substances. To properly dispose of used components (such as printed circuit boards or drives), you should collect and recycle used computers or displays using the methods described above.

Trademark

The following terms are trademarks of Lenovo in the United States and/or other countries (regions):

Lenovo

Lenovo Logo

ThinkCentre

ThinkPad

Think Vision

Microsoft, Windows, and Windows NT are trademarks of Microsoft Group, Inc.

Other company, product, or service names may be trademarks or service marks of other owners.

Power Cord

Only the power cord provided by the product manufacturer should be used. Do not use AC power cords from other devices.