

ASUS®

**VA27UCPS Series
LCD Monitor**

User Guide

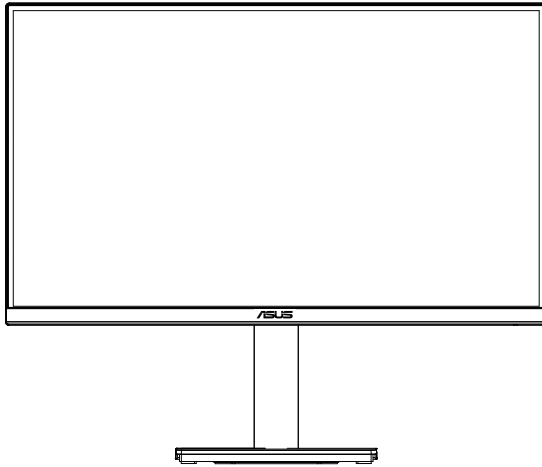

HDMI™
HIGH-DEFINITION MULTIMEDIA INTERFACE

Table of contents

- TCO certified iii
- Notices iv
- Care & Cleaning ix
- 1.1 Welcome! 1-1
- 1.2 Package contents..... 1-1
- 1.3 Assembling the monitor 1-2
- 1.4 Connect cables..... 1-3
 - 1.4.1 Rear of the LCD monitor 1-3
 - 1.4.2 Six sides figure..... 1-4
- 1.5 Monitor introduction 1-5
 - 1.5.1 Using the Controls button 1-5
- 2.1 Detaching the arm/stand (for VESA wall mount) 2-1
- 2.2 Adjusting the monitor..... 2-2
- 3.1 OSD (On-Screen Display) menu 3-1
 - 3.1.1 How to reconfigure..... 3-1
 - 3.1.2 OSD Function Introduction..... 3-2
- 3.2 Specifications..... 3-11
- 3.3 Troubleshooting (FAQ)..... 3-13
- 3.4 Supported Timing List..... 3-14

Copyright © 2024 ASUSTeK COMPUTER INC. All Rights Reserved.

No part of this manual, including the products and software described in it, may be reproduced, transmitted, transcribed, stored in a retrieval system, or translated into any language in any form or by any means, except documentation kept by the purchaser for backup purposes, without the express written permission of ASUSTeK COMPUTER INC. ("ASUS").

Product warranty or service will not be extended if: (1) the product is repaired, modified or altered, unless such repair, modification or alteration is authorized in writing by ASUS; or (2) the serial number of the product is defaced or missing.

ASUS PROVIDES THIS MANUAL "AS IS" WITHOUT WARRANTY OF ANY KIND, EITHER EXPRESS OR IMPLIED, INCLUDING BUT NOT LIMITED TO THE IMPLIED WARRANTIES OR CONDITIONS OF MERCHANTABILITY OR FITNESS FOR A PARTICULAR PURPOSE. IN NO EVENT SHALL ASUS, ITS DIRECTORS, OFFICERS, EMPLOYEES OR AGENTS BE LIABLE FOR ANY INDIRECT, SPECIAL, INCIDENTAL, OR CONSEQUENTIAL DAMAGES (INCLUDING DAMAGES FOR LOSS OF PROFITS, LOSS OF BUSINESS, LOSS OF USE OR DATA, INTERRUPTION OF BUSINESS AND THE LIKE), EVEN IF ASUS HAS BEEN ADVISED OF THE POSSIBILITY OF SUCH DAMAGES ARISING FROM ANY DEFECT OR ERROR IN THIS MANUAL OR PRODUCT.

SPECIFICATIONS AND INFORMATION CONTAINED IN THIS MANUAL ARE FURNISHED FOR INFORMATIONAL USE ONLY, AND ARE SUBJECT TO CHANGE AT ANY TIME WITHOUT NOTICE, AND SHOULD NOT BE CONSTRUED AS A COMMITMENT BY ASUS. ASUS ASSUMES NO RESPONSIBILITY OR LIABILITY FOR ANY ERRORS OR INACCURACIES THAT MAY APPEAR IN THIS MANUAL, INCLUDING THE PRODUCTS AND SOFTWARE DESCRIBED IN IT.

Products and corporate names appearing in this manual may or may not be registered trademarks or copyrights of their respective companies, and are used only for identification or explanation and to the owners' benefit, without intent to infringe.

TCO certified

A third-party certification according to ISO 14024



Toward sustainable IT products

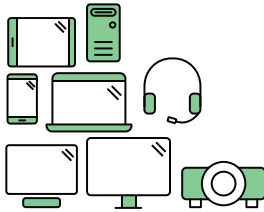

Say hello to a more sustainable product

IT products are associated with a wide range of sustainability risks throughout their life cycle. Human rights violations are common in the factories. Harmful substances are used both in products and their manufacture. Products can often have a short lifespan because of poor ergonomics, low quality and when they are not able to be repaired or upgraded.

This product is a better choice. It meets all the criteria in TCO Certified, the world's most comprehensive sustainability certification for IT products. Thank you for making a responsible product choice, that help drive progress towards a more sustainable future!

Criteria in TCO Certified have a life-cycle perspective and balance environmental and social responsibility. Conformity is verified by independent and approved verifiers that specialize in IT products, social responsibility or other sustainability issues. Verification is done both before and after the certificate is issued, covering the entire validity period. The process also includes ensuring that corrective actions are implemented in all cases of factory non-conformities. And last but not least, to make sure that the certification and independent verification is accurate, both TCO Certified and the verifiers are reviewed regularly.

Want to know more?

Read information about TCO Certified, full criteria documents, news and updates at tcocertified.com. On the website you'll also find our Product Finder, which presents a complete, searchable listing of certified products.

Notices



NOTE: This monitor is ENERGY STAR certified.

This product qualifies for ENERGY STAR in the factory default setting which can be restored by “Factory Reset” function in the OSD menu. Changing the factory default settings or enabling other features may increase power consumption that could exceed the ENERGY STAR specified limits.

Federal Communications Commission Statement

This device complies with Part 15 of the FCC Rules. Operation is subject to the following two conditions:

- This device may not cause harmful interference, and
- This device must accept any interference received including interference that may cause undesired operation.

This equipment has been tested and found to comply with the limits for a Class B digital device, pursuant to Part 15 of the FCC Rules. These limits are designed to provide reasonable protection against harmful interference in a residential installation. This equipment generates, uses and can radiate radio frequency energy and, if not installed and used in accordance with the instructions, may cause harmful interference to radio communications. However, there is no guarantee that interference will not occur in a particular installation. If this equipment does cause harmful interference to radio or television reception, which can be determined by turning the equipment off and on, the user is encouraged to try to correct the interference by one or more of the following measures:

- Reorient or relocate the receiving antenna.
- Increase the separation between the equipment and receiver.
- Connect the equipment to an outlet on a circuit different from that to which the receiver is connected.
- Consult the dealer or an experienced radio/TV technician for help.

Canadian Department of Communications Statement

This digital apparatus does not exceed the Class B limits for radio noise emissions from digital apparatus set out in the Radio Interference Regulations of the Canadian Department of Communications.

This class B digital apparatus complies with Canadian ICES-003.



Declaration of Conformity

This device complies with the requirements set out in the Council Directive on the Approximation of the Laws of the Member States relating to Electromagnetic Compatibility (2014/30/EU), Low-voltage Directive (2014/35/EU), ErP Directive (2009/125/EC) and RoHS directive (2011/65/EU). This product has been tested and found to comply with the harmonized standards for Information Technology Equipment, these harmonized standards published under Directives of Official Journal of the European Union.

WEEE Symbol Statement

This symbol on the product or on its packaging indicates that this product must not be disposed of with your other household waste. Instead, it is your responsibility to dispose of your waste equipment by handing it over to a designated collection point for the recycling of waste electrical and electronic equipment. The separate collection and recycling of your waste equipment at the time of disposal will help to conserve natural resources and ensure that it is recycled in a manner that protects human health and the environment. For more information about where you can drop off your waste equipment for recycling, please contact your local city office, your household waste disposal service or the shop where you purchased the product.



ASUS CONTACT INFORMATION		
<ul style="list-style-type: none"> ASUSTeK Computer Inc. Address 1F, No. 15, Lide Rd., Beitou Dist., Taipei City 112, Taiwan Telephone +886-2-2894-3447 Fax +886-2-2894-7798 E-mail info@asus.com.tw Website http://www.asus.com.tw 	<ul style="list-style-type: none"> ASUS Computer International (America) Address 48720 Kato Rd, Fremont, CA 94538, USA Telephone +1-510-739-3777 Fax +1-510-608-4555 Website http://usa.asus.com/ 	<ul style="list-style-type: none"> ASUS Computer GmbH (Germany and Austria) Address Harkortstr. 21-23 D-40880 Ratingen, Germany Telephone +49-1805-010920 Website http://www.asus.de/ Online Contact http://www.asus.de/sales
<ul style="list-style-type: none"> Technical Support Telephone +86-21-38429911 	<ul style="list-style-type: none"> Technical Support Telephone +1-812-282-2787 (English Only) +1-905-370-2787 (French Only) Online Support http://support.asus.com/ 	<ul style="list-style-type: none"> Technical Support Telephone +49-1805-010923 Support Fax +49-2102-959911 Online Support http://support.asus.com/

Safety information

- Before setting up the monitor, carefully read all the documentation that came with the package.
- To prevent fire or shock hazard, never expose the monitor to rain or moisture.
- Never try to open the monitor cabinet. The dangerous high voltages inside the monitor may result in serious physical injury.
- If the power supply is broken, do not try to fix it by yourself. Contact a qualified service technician or your retailer.
- Before using the product, make sure all cables are correctly connected and the power cables are not damaged. If you detect any damage, contact your dealer immediately.
- Slots and openings on the back or top of the cabinet are provided for ventilation. Do not block these slots. Never place this product near or over a radiator or heat source unless proper ventilation is provided.
- The monitor should be operated only from the type of power source indicated on the label. If you are not sure of the type of power supply to your home, consult your dealer or local power company.
- Use the appropriate power plug which complies with your local power standard.
- Do not overload power strips and extension cords. Overloading can result in fire or electric shock.
- Avoid dust, humidity, and temperature extremes. Do not place the monitor in any area where it may become wet. Place the monitor on a stable surface.
- Unplug the unit during a lightning storm or if it will not be used for a long period of time. This will protect the monitor from damage due to power surges.
- Never push objects or spill liquid of any kind into the slots on the monitor cabinet.
- To ensure satisfactory operation, use the monitor only with UL listed computers which have appropriate configured receptacles marked between 100 ~ 240V AC.
- The socket-outlet shall be installed near the equipment and shall be easily accessible
- If you encounter technical problems with the monitor, contact a qualified service technician.
- Provide an earthing connection before the mains plug is connected to the mains. And, when disconnecting the earthing connection, be sure to disconnect after pulling out the mains plug from the mains.

WARNING

Usage of other than specified head- or earphones can result in hearing loss due to excessive sound pressures.

Please confirm the distribution system in building installation shall provide the circuit breaker rated 120/240V, 20A (maximum).

If provided with a 3-pin attachment plug on the power cord, plug the cord into a grounded (earthed) 3-pin outlet. Do not disable the power cord grounding pin, for example, by attaching a 2-pin adapter. The grounding pin is an important safety feature.

To avoid electrical shock, always use the power cord and plug with a properly grounded power outlet.

Stability Hazard.

The product may fall, causing serious personal injury or death. To prevent injury, this product must be securely attached to the floor/wall in accordance with the installation instructions.

A product may fall, causing serious personal injury or death. Many injuries, particularly to children, can be avoided by taking simple precautions such as:

ALWAYS use cabinets or stands or installation methods recommended by the manufacturer of the product set.

ALWAYS use furniture that can safely support the product.

ALWAYS ensure the product is not overhanging the edge of the supporting furniture.

ALWAYS educate children about the dangers of climbing on furniture to reach the product or its controls.

ALWAYS route cords and cables connected to your product so they cannot be tripped over, pulled or grabbed.

NEVER place a product in an unstable location.

NEVER place the product on tall furniture (for example, cupboards or bookcases) without anchoring both the furniture and the product to a suitable support.

NEVER place the product on cloth or other materials that may be located between the product and supporting furniture.

NEVER place items that might tempt children to climb, such as toys and remote controls, on the top of the product or furniture on which the product is placed.

If the existing product is going to be retained and relocated, the same considerations as above should be applied.

Excessive sound pressure from earphones and headphones can cause hearing loss. Adjustment of the equalizer to maximum increases the earphones and headphones output voltage and therefore the sound pressure level.

Restriction on Hazardous Substances statement (India) This product complies with the "India E-Waste (Management) Rules, 2016" and prohibits use of Lead, Mercury, Hexavalent Chromium, polybrominated biphenyls(PBBs) and polybrominated diphenyl ethers(PBDEs) in concentration exceeding 0.1% by weight in homogenous materials and 0.01% by weight in homogenous materials for cadmium, except of exemptions listed in Schedule 2 of the Rule.

Care & Cleaning

- Before you lift or reposition your monitor, it is better to disconnect the cables and power cord. Follow the correct lifting techniques when positioning the monitor. When lifting or carrying the monitor, grasp the edges of the monitor. Do not lift the display by the stand or the cord.
- Cleaning. Turn your monitor off and unplug the power cord. Clean the monitor surface with a lint-free, non-abrasive cloth. Stubborn stains may be removed with a cloth dampened with mild cleaner.
- Avoid using a cleaner containing alcohol or acetone. Use a cleaner intended for use with the LCD. Never spray cleaner directly on the screen, as it may drip inside the monitor and cause an electric shock.

The following symptoms are normal with the monitor:

- The screen may flicker during the initial use due to the nature of the fluorescent light. Turn off the Power Switch and turn it on again to make sure that the flicker disappears.
- You may find slightly uneven brightness on the screen depending on the desktop pattern you use.
- When the same image is displayed for hours, an afterimage of the previous screen may remain after switching the image. The screen will recover slowly or you can turn off the Power Switch for hours.
- When the screen becomes black or flashes, or cannot work anymore, contact your dealer or service center to fix it. Do not repair the screen by yourself!

Conventions used in this guide



WARNING: Information to prevent injury to yourself when trying to complete a task.



CAUTION: Information to prevent damage to the components when trying to complete a task.



IMPORTANT: Information that you **MUST** follow to complete a task.



NOTE: Tips and additional information to aid in completing a task.

Where to find more information

Refer to the following sources for additional information and for product and software updates.

1. **ASUS websites**

The ASUS websites worldwide provide updated information on ASUS hardware and software products. Refer to <http://www.asus.com>

2. **Optional documentation**

Your product package may include optional documentation that may have been added by your dealer. These documents are not part of the standard package.

3. **Protect your eyes with ASUS EYE CARE Monitors**

The latest ASUS monitors feature exclusive Blue Light Filter and Flicker free technologies to keep your eyes healthy in today's digital world. Refer to

https://www.asus.com/Microsite/display/eye_care_technology/

Takeback Services

ASUS recycling and takeback programs come from our commitment to the highest standards for protecting our environment. We believe in providing solutions for our customers to be able to responsibly recycle our products, batteries and other components as well as the packaging materials.

Please go to <http://csr.asus.com/english/Takeback.htm> for detail recycling information in different region.

Product information for EU energy label



1.1 Welcome!

Thank you for purchasing the ASUS® LCD monitor!

The latest widescreen LCD monitor from ASUS provides a crisper, broader, and brighter display, plus a host of features that enhance your viewing experience.

With these features, you can enjoy the convenience and delightful visual experience that the monitor brings you!

1.2 Package contents

Check your package for the following items:

- ✓ LCD Monitor
- ✓ Monitor Stand
- ✓ Monitor Base
- ✓ Quick Start Guide
- ✓ Warranty Card
- ✓ Power Cord
- ✓ HDMI Cable (optional)
- ✓ USB-C Cable (optional)
- ✓ DP Cable (optional)
- ✓ Phone holder stickers



-
- If any of the above items is damaged or missing, contact your retailer immediately.
 - * Also the Replaceable parts required by the TCO Certified.
-

1.3 Assembling the monitor

To assemble the monitor:

1. Place the display on a cloth on the table, Then attach the base to the arm and fix with the screw to join them tightly. You can easily tighten the screw by fingers.
2. Adjust the monitor to the angle that is most comfortable for you.

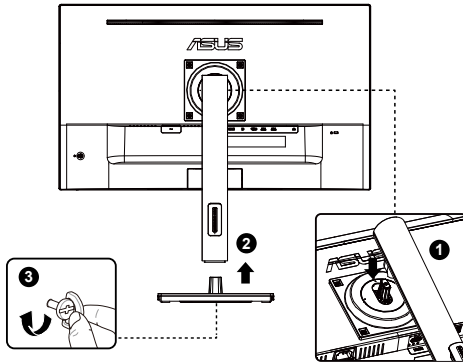

*Base screw size: M6 x 15mm

1.4 Connect cables

1.4.1 Rear of the LCD monitor

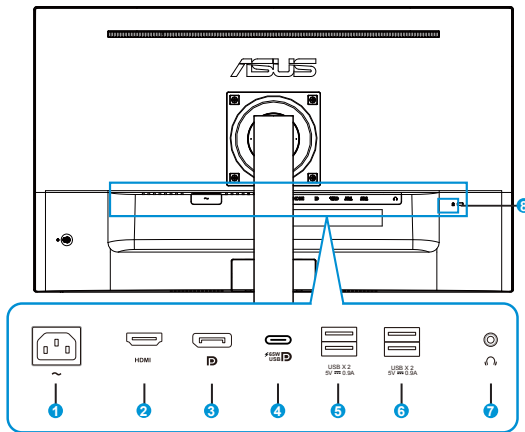

1. AC-IN Port
2. HDMI Port
3. DisplayPort
4. USB Type-C Port
5. USB3.2 Gen1 Type-A Port
6. USB3.2 Gen1 Type-A Port
7. Earphone - out
8. Kensington Lock



This monitor is Super-Speed USB 3.2 Gen 1 compatible (5 Gbps). The TypeC port offers Max. 65W or 96W power delivery with output voltage 5V/3A, 9V/3A, 12V/3A, 15V/3A, 20V/3.25A, or 20V/4.8A (96W only). User can select 65W or 96W from OSD menu “USB-C Charging”. Default USB-C power delivery (PD) setting is 65W, you can switch to PD 96W via “USB-C charging” setting (USB hub, audio features will be disabled).

1.4.2 Six sides figure

VA27UCPS

UNIT:mm [inch]

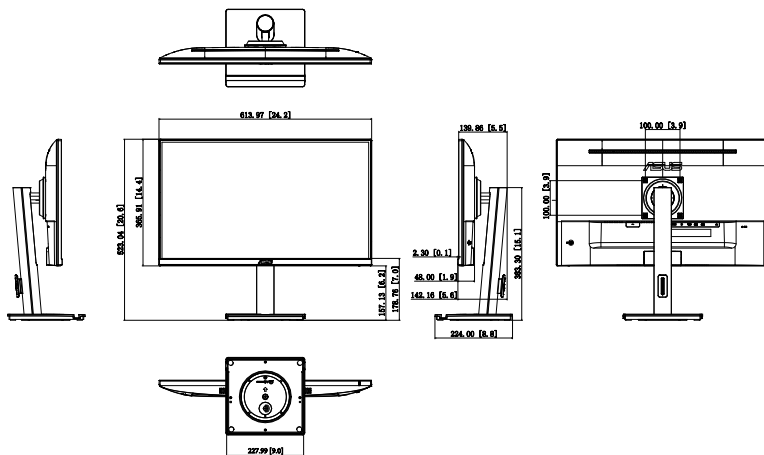

1.5 Monitor introduction

1.5.1 Using the Controls button

Use the control button on the back of the monitor to adjust the image settings.

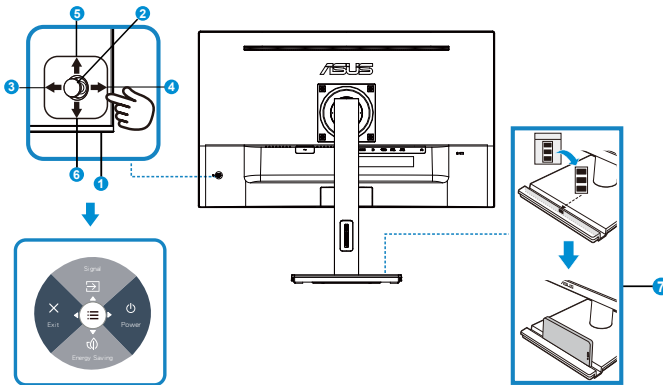

1. Power Indicator:

- The color definition of the power indicator is as the below table.

Status	Description
White	ON
Amber	Standby mode
OFF	OFF

2. Central button:

- Press this button to enter the OSD menu.

3. Left key:

- Exit the OSD menu or return to the previous layer.

4. Right key:

- Power Off shortcut key.
- Enter the option of the next layer.

5. Up key:
 - Signal shortcut key.
 - Move the option upwards or increase the option value.
6. Down key:
 - Energy Saving shortcut key.
 - Move the option downwards or decrease the option value.
 - Key Lock shortcut key. Press and hold it for 5 seconds to enable/disable Keys Lock.
7. Phone holder:
 - The size of the phone holder is 14.4 x 228.8 mm. Make sure your device fits into the groove.
 - You can paste the phone holder stickers on the inside of the front side of the groove to protect your device.



-
- You can press 5-way key any direction to turn on the monitor.
-

2.1 Detaching the arm/stand (for VESA wall mount)

The detachable stand of this monitor is specially designed for VESA wall mount.

To detach the arm/stand

1. Disconnect power and signal cables. Carefully put the front of the monitor face down on a clean table.
2. Remove the four (4) screws securing the arm to the rear of the monitor.
3. Detach the stand (arm and base) from the monitor.



- We recommend that you cover the table surface with soft cloth to prevent damage to the monitor.

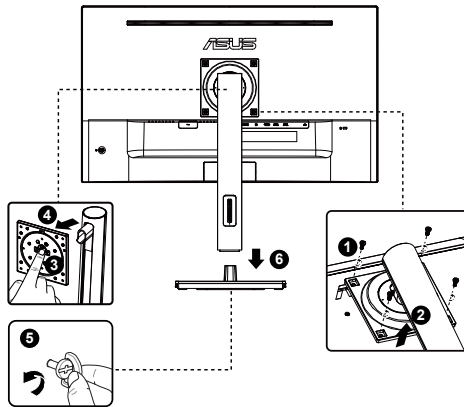

- The VESA wall mount kit (100 x 100 mm) is purchased separately.
- Use only the UL Listed Wall Mount Bracket with minimum weight/load 12 kg (Screw size: M4 x 10 mm).

2.2 Adjusting the monitor

- For optimal viewing, we recommend that you look at the full face of the monitor, then adjust the monitor to the angle that is most comfortable for you.
- Hold the stand to prevent the monitor from falling when you change its angle.
- You can adjust the monitor's angle from $+35^\circ$ to -5° and You can also adjust the monitor's height within $\pm 15\text{cm}$. Before rotating the display, lift it to the top position and then push it back to the utmost degree. Rotate clockwise or counter-clockwise until the monitor stops at $\pm 90^\circ$.

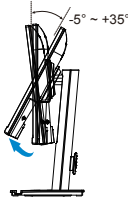

(Tilt)

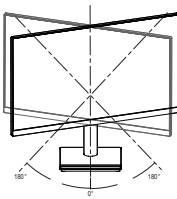

(Swivel)

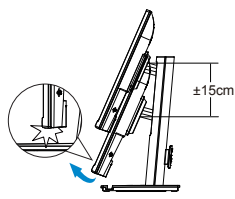

(Height adjustment)

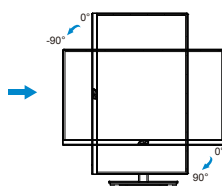
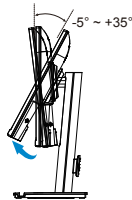
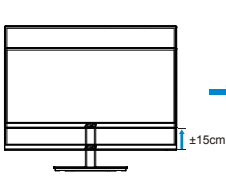

It is normal that the monitor slightly shakes while you adjust the viewing angle.

3.1 OSD (On-Screen Display) menu

3.1.1 How to reconfigure

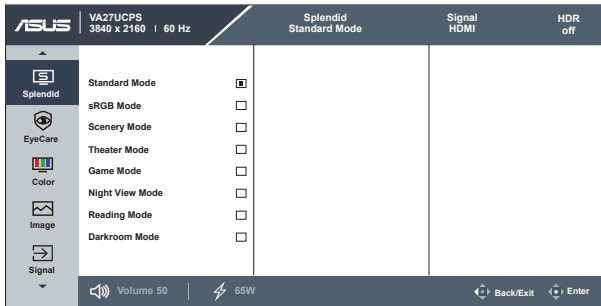

1. Press the MENU button to activate the OSD menu.
2. Press the ▼ and ▲ buttons to toggle between options in the Menu. As you move from one icon to another, the option name is highlighted.
3. To select the highlighted item on the menu press the Central key.
4. Press the ▼ and ▲ buttons to select the desired parameter.
5. Press the Central key to enter the slide bar and then use the ▼ or ▲ buttons, according to the indicators on the menu, to make your changes.

3.1.2 OSD Function Introduction

1. Splendid

This function contains eight sub-functions that you can select for your preference.

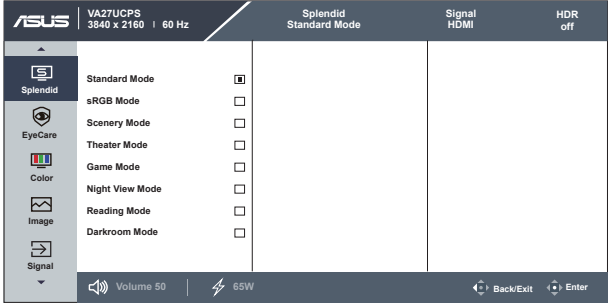

- **Standard Mode:** This is the best choice for document editing with SPLENDID™ Video Intelligence Technology.
- **sRGB Mode:** This is the best choice for viewing photos and graphics from PCs.
- **Scenery Mode:** This is the best choice for scenery photo displaying with SPLENDID™ Video Intelligence Technology.
- **Theater Mode:** This is the best choice for movie watching with SPLENDID™ Video Intelligence Technology.
- **Game Mode:** This is the best choice for game playing with SPLENDID™ Video Intelligence Technology.
- **Night View Mode:** This is the best choice for playing dark-scene game or watching dark-scene movie with SPLENDID™ Video Intelligence Technology.
- **Reading Mode :** This is the best choice for book reading.
- **Darkroom Mode :** This is the best choice for a weak ambient light environment.



- In the Standard Mode, the Saturation, ASCR functions are not user-configurable.
- In the sRGB, the Saturation, Color Temp., Contrast and ASCR functions are not user-configurable.
- In the Reading Mode, the Saturation, ASCR, contrast, and Color Temp functions are not user-configurable.

2. EyeCare

Adjust the energy level of Eye Care from LED backlight.

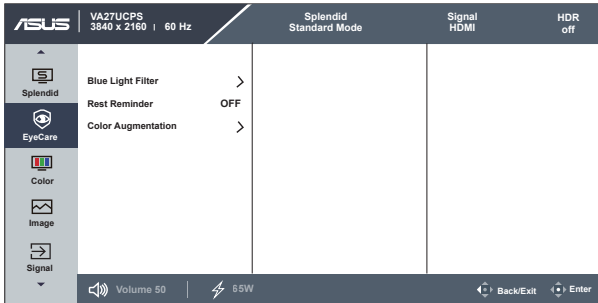

- **Blue Light Filter:** In this function, you can adjust the blue light filter from 0 to max. 0: no changes; Max: The higher the level, the less blue light is scattered. When blue light filter is activated, the default settings of Standard Mode will be automatically imported. Besides maximum level, the brightness is user-configurable. Maximum is the optimized setting. It is compliance with TUV low blue light certification*. The brightness function is not user configurable.



- When the user adjusts blue light filter bar to maximum level.
- *When color augmentation is in default value (50).

- **Rest Reminder:** This function provides you a rest reminder according to how long you set for your working time. For example, a user sets 30 minutes working time and there will be a pop up reminder appeared on the upper left corner of the monitor for 5 seconds. Press any key to make this reminder OSD disappeared.



- When this function is enable, the following functions are not available: GamePlus and QuickFit.

- **Color Augmentation:** The adjusting range of color enhancement is from 0 to 100.



- This function is not available in sRGB mode under Splendid.



Please refer to the following to alleviate eye strains:

- Users should take some time away from the display if working for long hours. It is advised to take short breaks (at least 5 mins) after around 1 hour of continuous working at the computer. Taking short and frequent breaks is more effective than a single longer break.
 - To minimize eye strain and dryness in your eyes, users should rest the eye periodically by focusing on objects that are far away.
 - Eye exercises can help to reduce eye strain. Repeat these exercises often. If eye strain continues please consult a physician. Eye exercises: (1) Repeating look up and down (2) Slowly roll your eyes (3) Move your eyes diagonal.
 - High energy blue light may lead to eye strain and AMD (Age-Related Macular Degeneration). Blue light filter to reduce 70% (max.) harmful blue light to avoid CVS (Computer Vision Syndrome).
-

3. Color

Select the image color you like from this function.

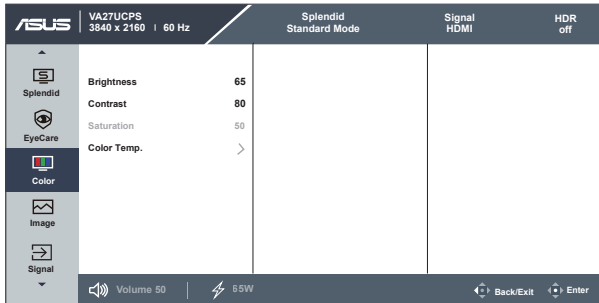

- **Brightness:** The adjusting range is from 0 to 100.
- **Contrast:** The adjusting range is from 0 to 100.
- **Saturation:** The adjusting range is from 0 to 100.
- **Color Temp.:** Contains three preset color modes (**Cool, Normal, Warm**) and **User Mode**.



-
- In the User Mode, colors of R (Red), G (Green), and B (Blue) are user-configurable; the adjusting range is from 0 ~ 100.
-

4. Image

You can adjust the image Sharpness, Trace Free, Aspect Control, ASCR, Adaptive-Sync, HDR, Dynamic Dimming from this main function.

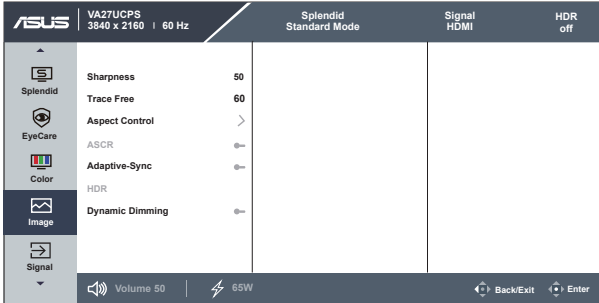

- **Sharpness:** Adjusts the picture sharpness. The adjusting range is from 0 to 100.
- **Trace Free:** Speeds up the response time by Over Drive technology. The adjusting range is from lower 0 to faster 100.
- **Aspect Control:** Adjusts the aspect ratio to “Full”, “1:1 Ratio”, “Dot to Dot”.
- **ASCR:** Select **ON** or **OFF** to enable or disable dynamic contrast ratio function.
- **Adaptive-Sync:** It can allow a Adaptive-Sync supported graphics source to dynamically adjust display refresh rate based on typical content frame rates for power efficient, virtually stutter free and low-latency display update.
- **HDR:** High Dynamic Range. Contains two HDR modes (Cinema HDR and Gaming HDR).
- **Dynamic Dimming:** Dynamic local dimming, turn on this feature to improve the dynamic contrast.

5. Signal

Select the input source: HDMI, DisplayPort, USB-C and Auto Detection.

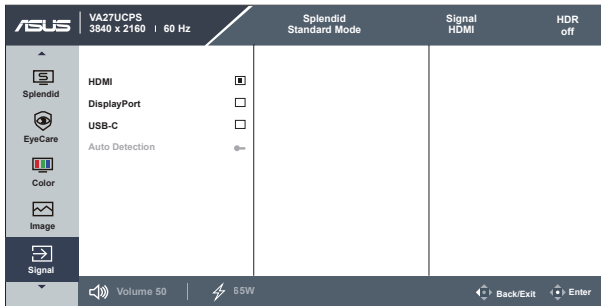

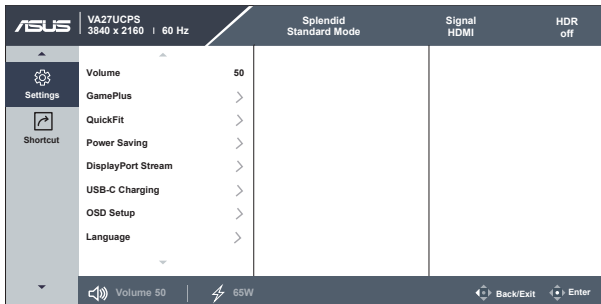

6. Settings

Adjusts the system configuration.



- **Volume:** Adjusts the output volume level.
- **GamePlus:** The GamePlus Function provides a toolkit and creates a better gaming environment for users when playing different types of games. Particularly, Crosshair function is specially designed for new gamers or beginners interested in First Person Shooter (FPS) games.

To active GamePlus:

- Press **GamePlus** Button to enter the GamePlus main menu.
- Activate Crosshair, Timer, FPS Counter or Display Alignment function.
- Move the  button up/down to select and press  to confirm the function needed. Press **X** to go off, and exit.
- Crosshair/Timer/FPS Counter is movable by pressing  5-way key.

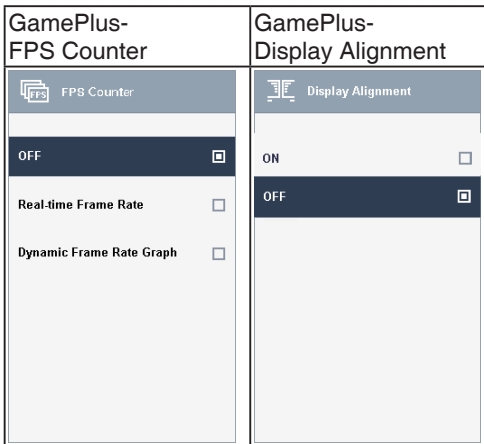
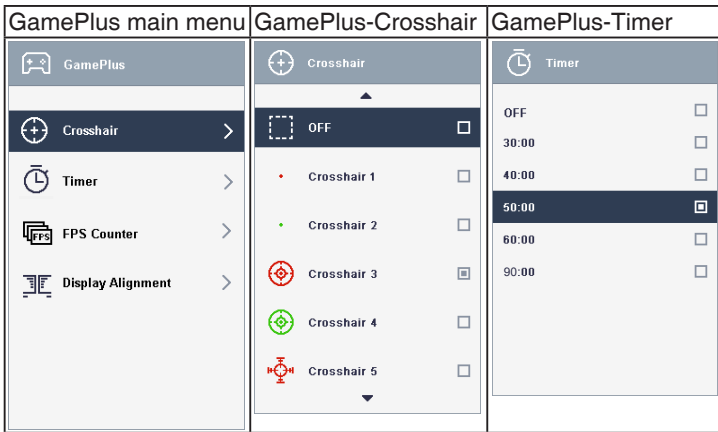

- **QuickFit:** contains three patterns: (1) Grid (2) Paper size (3) Photo size.
 1. Grid pattern: Facilitates designers and users to organize content and layout on one page and achieve a consistent look and feel.

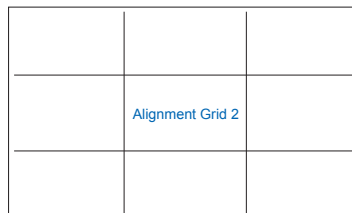
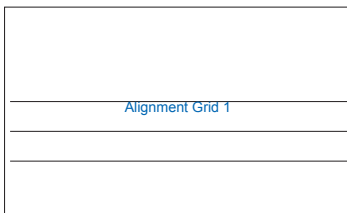

2. Paper size: Provides users to view their documents in real size on the screen.

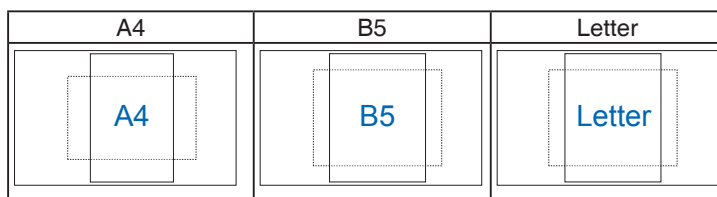

3. Photo size: Provides photographers and other users to accurately view and edit their photos in real size on the screen.

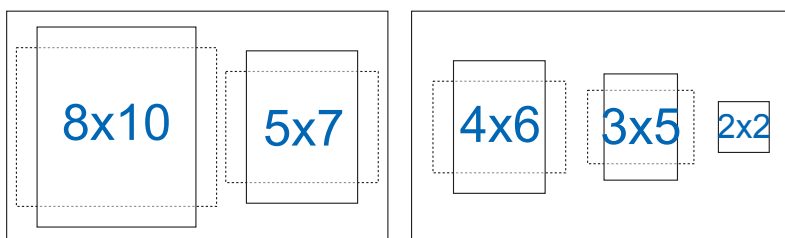

- **Power Saving:** Adjusts the “Normal Level” and “Deep Level” for the Power Saving function.
- **DisplayPort Stream:** Select DisplayPort 1.2 or DisplayPort 1.4 or DisplayPort 1.4+USB3.2 according to the graphic card DP version.
- **USB-C Charging:** Set charging power to 65W or 96W. When 96W is selected, USB hub will be turned off.
- **OSD Setup:** Adjusts the **OSD Timeout**, **DDC/CI**, and **Transparency** of the OSD screen.
- **Language:** Select OSD language. The selections are: **English, French, German, Spanish, Italian, Dutch, Russian, Poland, Czech, Croatia, Hungary, Romania, Portugal, Turkey, Simplified Chinese, Traditional Chinese, Japanese, Korean, Persian, Thai, Indonesian, Ukraine, and Vietnamese.**
- **Key Lock:** Disable all key functions. Pressing down key for more than five seconds to disable key lock function.
- **Information:** Displays the monitor information.
- **Power Indicator:** Turn the power LED indicator on/off.
- **Power Key Lock:** To disable / enable power key.
- **All Reset:** Selects “Yes” to revert all settings to the factory default mode.

7. Shortcut

Selecting this option allows you to set two shortcut keys.

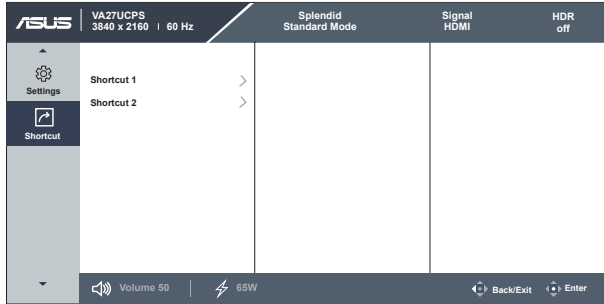

- **Shortcut 1:** User can select from “Blue Light Filter”, “Splendid”, “Brightness”, “Contrast”, “Signal”, “Color Temp.”, “Volume”, “QuickFit”, “GamePlus”, “Rest Reminder”, “Color Augmentation”, “Energy Saving” and set as shortcut key. The default setting is Signal.
- **Shortcut 2:** User can select from “Blue Light Filter”, “Splendid”, “Brightness”, “Contrast”, “Signal”, “Color Temp.”, “Volume”, “QuickFit”, “GamePlus”, “Rest Reminder”, “Color Augmentation”, “Energy Saving” and set as shortcut key. The default setting is Energy Saving.

3.2 Specifications

Model	VA27UCPS
Panel Size	27" W
Max. Resolution	3840 X 2160
Brightness (Typ.)	350cd/m ²
Contrast ratio (typical)	1000:1
Viewing Angle (CR>10)	178°(V) /178°(H)
Display Colors	1073.7M (8bit+FRC)
Response Time	5ms
Earphone Output	Yes
Sound from HDMI/DP/Type-c	Yes
Digital input	Displayport v1.4, HDMI v2.0, DisplayPort over Type C
USB Port	5V/0.9A (Downstream X4)
AC input voltage	AC 100~240V(Built-in)
Power On Consumption (max)	24W**
Power saving mode	< 0.5W
Power off mode	< 0.3W under ERP Lot5
Colors	Black
Tilt	+35°~ -5°
pivot	+90°~ -90°
Swivel	+180°~ -180°
Height Adjustment	150mm
Kensington lock	Yes
VESA Wall Mounting	Yes (100mm x 100mm)
Temperature (Operating)	0°C~ 40°C
Operating Humidity	10% ~ 80%
Altitude	16,404 feet(5,000m)

Phys. Dimension with stand (WxHxD)	614mm x (373mm~523mm) x 224mm
Phys. Dimension without stand (WxHxD) (For VESA Wall Mount)	614mm x 366mm x 48mm
Box Dimension (WxHxD)	684mm x 460mm x 146mm
Net Weight (Esti.)	6.9 kg
Gross Weight (Esti.)	9.3 kg

*** Specifications are subject to change without notice.**

**** Measuring a screen brightness of 200 nits without audio/USB/Card reader connection**

3.3 Troubleshooting (FAQ)

Problem	Possible Solution
Power LED is not ON	<ul style="list-style-type: none">• Press the  button to check if the monitor is in the ON mode.• Check if the power cord is properly connected to the monitor and the power outlet.• Check Power Indicator function in main menu OSD. And turn on this function to turn on the power LED light.
The power LED lights amber and there is no screen image	<ul style="list-style-type: none">• Check if the monitor and the computer are in the ON mode.• Make sure the signal cable is properly connected the monitor and the computer.• Inspect the signal cable and make sure none of the pins are bent.• Connect the computer with another available monitor to check if the computer is properly working.
Screen image is too light or dark	<ul style="list-style-type: none">• Adjust the Contrast and Brightness settings via OSD.
Screen image bounces or a wave pattern is present in the image	<ul style="list-style-type: none">• Make sure the signal cable is properly connected to the monitor and the computer.• Move electrical devices that may cause electrical interference.
Screen image has color defects (white does not look white)	<ul style="list-style-type: none">• Inspect the signal cable and make sure that none of the pins are bent.• Perform Reset via OSD.• Adjust the R/G/B color settings or select the Color Temperature via OSD.
No sound or sound is low	<ul style="list-style-type: none">• Make sure the audio cable is properly connected to the monitor.• Adjust the volume settings of both your monitor and computer.• Make sure the computer sound card driver is properly installed and activated..

3.4 Supported Timing List

Support Timing

Timing	Resolution	HDMI	DP	USBC
PC Timing	640x480-60Hz	√	√	√
PC Timing	800x600-60Hz	√	√	√
PC Timing	1024x768-60Hz	√	√	√
PC Timing	1280x960-60Hz	√	√	√
PC Timing	1280x720-60Hz	√	√	√
PC Timing	1280x1024-60Hz	√	√	√
PC Timing	1600x900-60Hz	√	√	√
PC Timing	1920x1080-60Hz	√	√	√
Video Timing	640x480-60Hz	√	√	√
Video Timing	720x480-60Hz	√	√	√
Video Timing	720x576-50Hz	√	√	√
Video Timing	1280x720-50Hz	√	√	√
Video Timing	1280x720-60Hz	√	√	√
Video Timing	1920x1080-24Hz	√	√	√
Video Timing	1920x1080-25Hz	√	√	√
Video Timing	1920x1080-30Hz	√	√	√
Video Timing	1920x1080-50Hz	√	√	√
Video Timing	1920x1080-60Hz	√	√	√
Video Timing	3840x2160-24Hz	√	√	√
Video Timing	3840x2160-25Hz	√	√	√
Video Timing	3840x2160-30Hz	√	√	√
Video Timing	3840x2160-50Hz	√	√	√
Video Timing	3840x2160-60Hz	√	√	√

16:9 Timing

Timing	Resolution	HDMI	DP	USBC
Detail Timing	1920x1080-60Hz	√	√	√
Detail Timing	2560x1440-60Hz	√	√	√
Detail Timing	3840x2160-60Hz	√	√	√

* The modes not listed in the above tables may not be supported. For optimal resolution, we recommend that you choose a mode listed in the above tables.