



# HP EliteDisplay E190i LED Backlit IPS Monitor

User Guide

© 2013 Hewlett-Packard Development  
Company, L.P.

Microsoft, Windows, and Windows Vista are either trademarks or registered trademarks of Microsoft Corporation in the United States and/or other countries.

The only warranties for HP products and services are set forth in the express warranty statements accompanying such products and services. Nothing herein should be construed as constituting an additional warranty. HP shall not be liable for technical or editorial errors or omissions contained herein.

This document contains proprietary information that is protected by copyright. No part of this document may be photocopied, reproduced, or translated to another language without the prior written consent of Hewlett-Packard Company.

First Edition (September 2013)

Document Part Number: 738186-001

## About This Guide

This guide provides information on setting up the monitor, installing drivers, using the on-screen display menu, troubleshooting and technical specifications.

 **WARNING!** Text set off in this manner indicates that failure to follow directions could result in bodily harm or loss of life.

 **CAUTION:** Text set off in this manner indicates that failure to follow directions could result in damage to equipment or loss of information.

 **NOTE:** Text set off in this manner provides important supplemental information.

---



---

# Table of contents

<b>1 Product Features</b> .....	<b>1</b>
HP LCD Monitors .....	1
<b>2 Setting Up the Monitor</b> .....	<b>3</b>
Attaching the Stand to the Monitor .....	3
Rear Components .....	4
Connecting the Cables .....	5
Front Panel Controls .....	7
Adjusting the Monitor .....	8
Turning on the Monitor .....	10
HP Watermark and Image Retention Policy .....	10
Connecting USB Devices .....	10
Removing the Monitor Pedestal Base .....	11
Mounting the Monitor .....	12
Locating the Rating Labels .....	12
Installing a Cable Lock .....	13
<b>3 Finding More Information</b> .....	<b>14</b>
Reference Guides .....	14
Product Support .....	14
<b>Appendix A Technical Specifications</b> .....	<b>15</b>
EliteDisplay E190i .....	15
Recognizing Preset Display Resolutions .....	16
EliteDisplay E190i .....	16
Entering User Modes .....	16
Energy Saver Feature .....	17



---

# 1 Product Features

## HP LCD Monitors

The LCD (liquid crystal display) monitors have an active matrix, thin-film transistor (TFT) panel. The monitor's features include:

- EliteDisplay E190i model, 47.99 cm (18.89-inch) diagonal viewable area display with 1280 x 1024 resolution, plus full-screen support for lower resolutions: includes custom scaling for maximum image size
- Non-glare panel with an LED backlight
- Wide viewing angle to allow viewing from a sitting or standing position, or moving from side-to-side
- Tilt capability
- Pivot capability to rotate display to portrait mode
- Swivel and height adjustment capabilities
- Removable stand for flexible monitor panel mounting solutions
- Video signal input to support VGA analog (cable provided)
- Video signal input to support DVI digital (cable provided)
- Video signal input to support DisplayPort digital (cable optional in some countries)
- USB 2.0 hub with one upstream port (connects to the computer) and two downstream ports (connects to USB devices)
- USB cable provided to connect the monitor's USB hub to the USB connector on the computer
- Supports an optional HP speaker bar
- Plug and play capability if supported by the system
- Privacy filter slots to insert filters (purchased separately) to block side screen viewing
- Security slot provision on rear of monitor for optional cable lock
- Cable management feature for placement of cables and cords
- On-Screen Display (OSD) adjustments in several languages for easy setup and screen optimization
- HP Display Assistant for adjusting monitor settings and enabling theft deterrence features
- HDCP copy protection on DVI and DisplayPort inputs
- Software and documentation disc that includes monitor drivers and product documentation
- Energy saver feature to meet requirements for reduced power consumption

- Intelligent Management AssetControl
- Compliant with the following regulated specifications (for additional certifications and agency notices, refer to the *HP LCD Monitors Reference Guide* on the disc included with this monitor):
  - European Union CE Directives
  - Swedish TCO Requirements



---

## 2 Setting Up the Monitor

To set up the monitor, ensure that the power is turned off to the monitor, computer system, and other attached devices, then follow the instructions below.

### Attaching the Stand to the Monitor

1. Lift the monitor from its box and place it face down on a flat surface.
2. Attach the base to the stand.



3. Tighten the screw on the bottom of the stand by hand.



# Rear Components

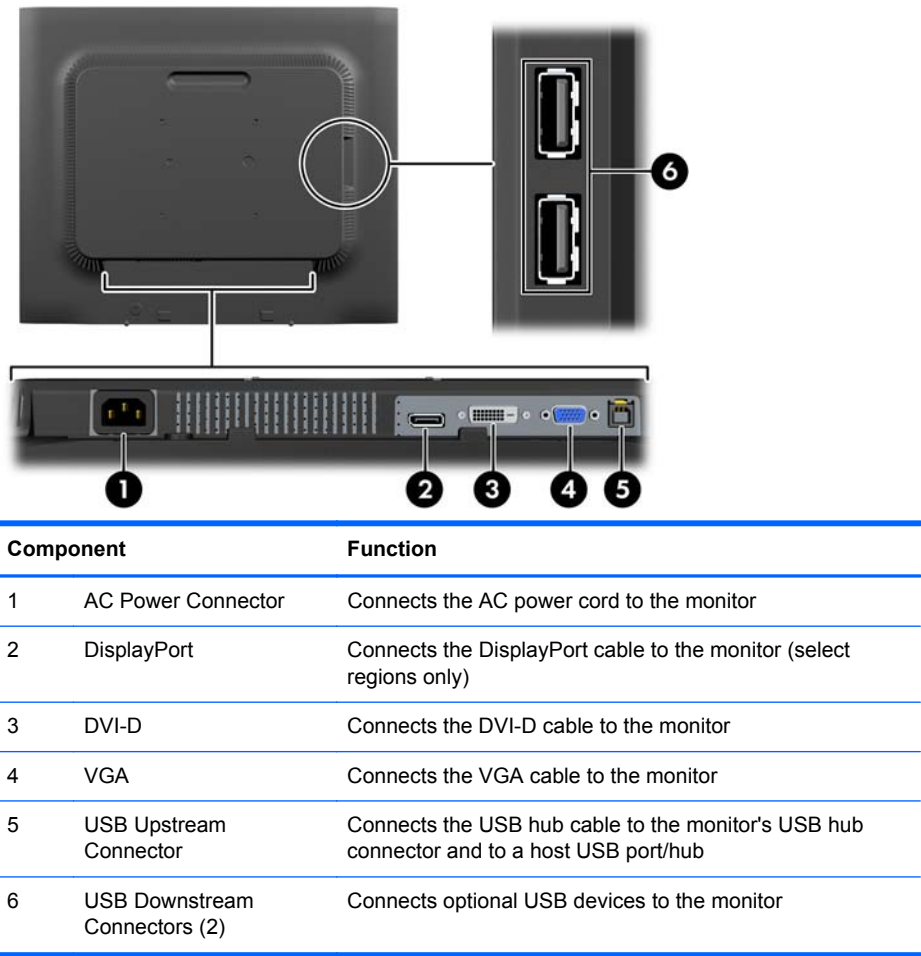

## Connecting the Cables

1. Place the monitor in a convenient, well-ventilated location near the computer.
2. Remove the cable management clip from the pedestal by pulling outward on the two sides of the clip (1) then lifting the clip off the pedestal (2).

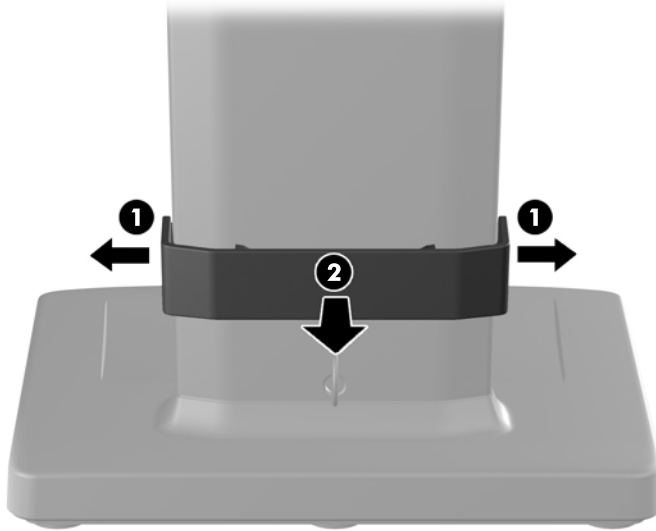

3. Connect a VGA signal cable, DVI-D signal cable, or DisplayPort signal cable.

 **NOTE:** The monitor is capable of supporting either analog or digital input. The video mode is determined by the video cable used. The monitor will automatically determine which inputs have valid video signals. The inputs can be selected by pressing the [Input](#) button on the front panel or through the On-Screen Display (OSD) feature by pressing the [Menu](#) button.

- For analog operation, connect the VGA signal cable to the VGA connector on the rear of the monitor and the other end to the VGA connector on the computer (cable provided).
  - For DVI digital operation, connect the DVI-D signal cable to the DVI connector on the rear of the monitor and the other end to the DVI connector on the computer (cable provided).
  - For DisplayPort digital operation, connect the DisplayPort signal cable to the DisplayPort connector on the rear of the monitor and the other end to the DisplayPort connector on the computer (cable is optional in some countries).
4. Connect one end of the provided USB cable to the USB hub connector on the rear panel of the computer, and the other end to the upstream USB connector on the monitor.

5. Connect one end of the power cord to the AC power connector on the back of the monitor, and the other end to an electrical wall outlet.

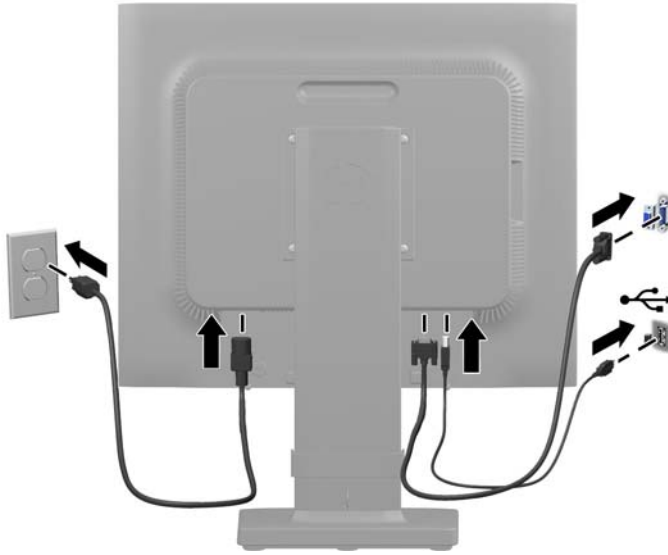

---

**⚠ WARNING!** To reduce the risk of electric shock or damage to the equipment:

Do not disable the power cord grounding plug. The grounding plug is an important safety feature.

Plug the power cord into a grounded (earthed) electrical outlet that is easily accessible at all times.

Disconnect power from the equipment by unplugging the power cord from the electrical outlet.

For your safety, do not place anything on power cords or cables. Arrange them so that no one may accidentally step on or trip over them. Do not pull on a cord or cable. When unplugging from the electrical outlet, grasp the cord by the plug.



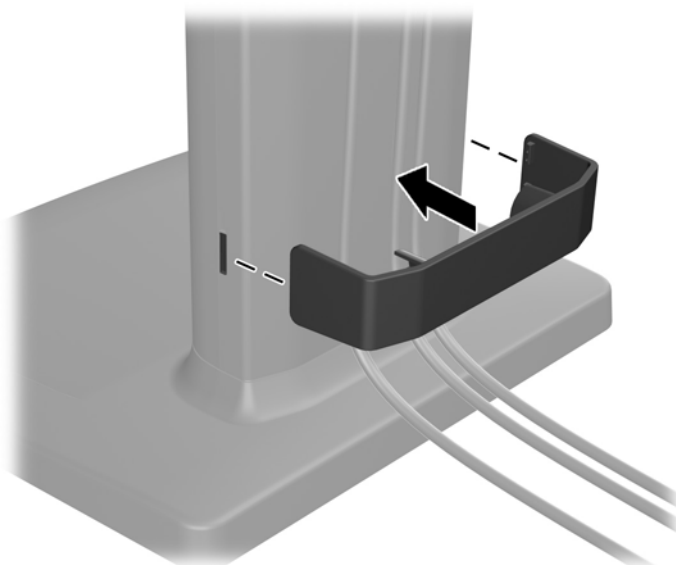

- 
6. Secure the cables in place with the cable management clip. Press the clip straight down on the curved neck of the pedestal ensuring that the tabs on the sides of the clip snap into the slots on the pedestal.

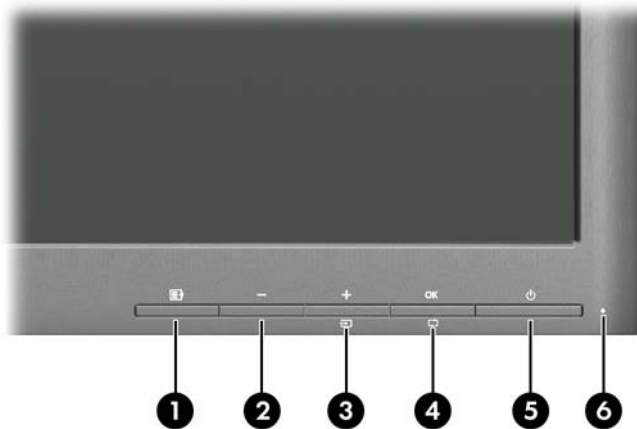

# Front Panel Controls



**Table 2-1** Monitor Front Panel Controls

Control	Function
1 	Menu Opens, selects or exits the OSD menu.
2 	Minus If the OSD menu is on, press to navigate backward through the OSD menu and decrease adjustment levels.
3 	Plus/Input If the OSD menu is on, press to navigate forward through the OSD menu and increase adjustment levels.  If the OSD menu is inactive, press to activate the Input button that chooses the video signal input (VGA, DVI, or DisplayPort)
4 	OK/auto If the OSD menu is on, press to select the highlighted menu item.  If the OSD menu is inactive, press to activate the auto adjustment feature to optimize the screen image.
5 	Power Turns the monitor on or off.
6	Power LED White = Fully powered. Amber = Sleep mode. Flashing Amber = Sleep Timer mode.

 **NOTE:** To view an OSD menu simulator, visit the HP Customer Self Repair Services Media Library at <http://www.hp.com/go/sml>.

## Adjusting the Monitor

 **NOTE:** Your monitor model may look different than the model in the following illustrations.

---

1. Tilt the monitor's panel forward or backward to set it to a comfortable eye level.



2. Swivel the monitor to the left or right for the best viewing angle.

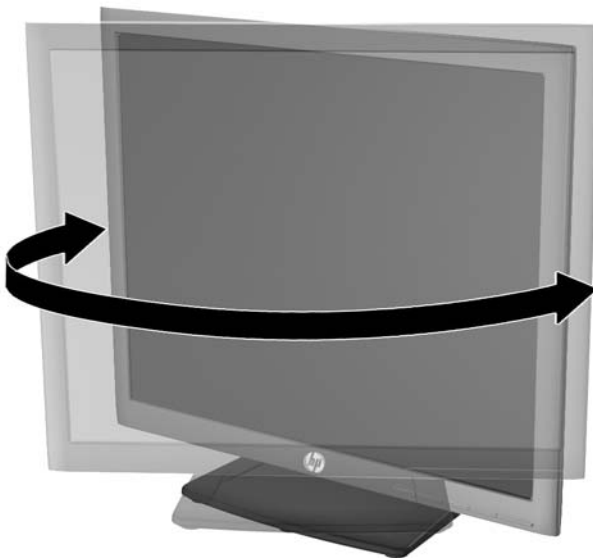

3. Adjust the monitor's height to a comfortable position for your individual workstation. The monitor's top bezel edge should not exceed a height that is parallel to your eye height. A monitor that is positioned low and reclined may be more comfortable for users with corrective lenses. The monitor should be repositioned as you adjust your working posture throughout the work day.

 **NOTE:** The monitor stand ships with the display head locked in the lowest height position. To adjust the display head to full height, remove the lock pin and then pull up on the display head to raise it to the full-height position.

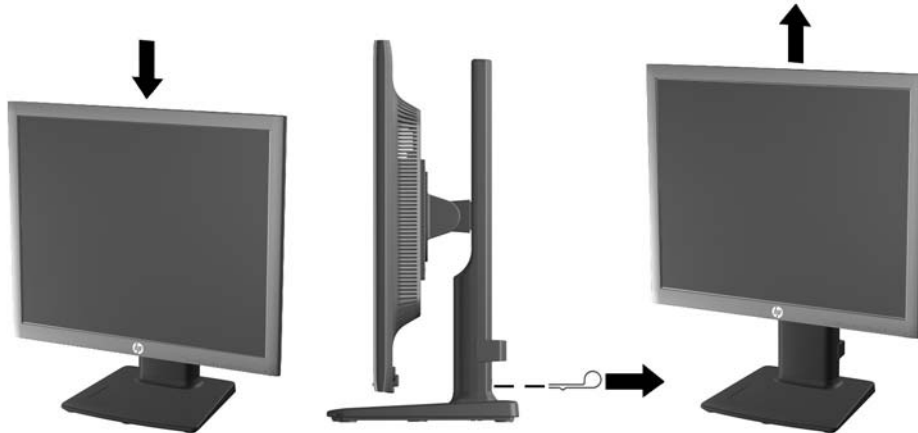

4. Pivot the monitor from landscape to portrait orientation viewing to adapt to your application.
  - a. Adjust the monitor to full height position and tilt the monitor back to full tilt position (1).
  - b. Pivot the monitor clockwise 90° from landscape to portrait orientation (2).

 **CAUTION:** If the monitor is not in full height and full tilt position when pivoting, the bottom right corner of the monitor panel will come in contact with the base and potentially cause damage to the monitor.

If you are adding an optional speaker bar to the monitor, install it after pivoting the monitor. The speaker bar will come in contact with the base when pivoting and potentially cause damage to the monitor or speaker bar.

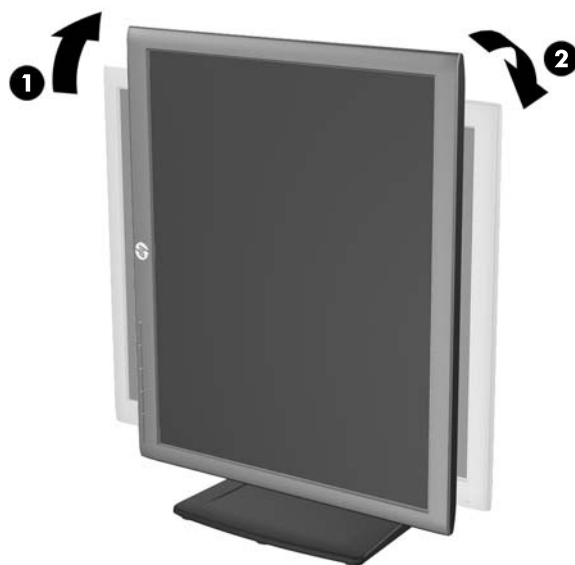

---

 **NOTE:** To view information on the screen in portrait mode, you can install the HP Display Assistant software included on the software and documentation disc. The position of the OSD menu can also be rotated to portrait mode. To rotate the OSD menu, access the OSD menu by pressing the **Menu** button on the front panel, select **OSD Control** from the menu, then select **Rotate OSD**.

---

## Turning on the Monitor

1. Press the power button on the computer to turn it on.
2. Press the power button on the front of the monitor to turn it on.

 **CAUTION:** Burn-in image damage may occur on monitors that display the same static image on screen for a prolonged period of time.\* To avoid burn-in image damage on the monitor screen, you should always activate a screen saver application or turn off the monitor when it is not in use for a prolonged period of time. Image retention is a condition that may occur on all LCD screens. Monitors with a “burned-in image” are not covered under the HP warranty.

\* A prolonged period of time is 12 consecutive hours of non-use.

 **NOTE:** If pressing the power button has no effect, the Power Button Lockout feature may be enabled. To disable this feature, press and hold the monitor power button for 10 seconds.

 **NOTE:** You can disable the power LED in the OSD menu. Press the **Menu** button on the front of the monitor, then select **Management > Bezel Power LED > Off**.

---

When the monitor is powered on, a Monitor Status message is displayed for five seconds. The message shows which input (DisplayPort, DVI, or VGA) is the current active signal, the status of the auto-switch source setting (On or Off; factory default is On), the default source signal (factory default is DisplayPort), the current preset display resolution, and the recommended preset display resolution.

The monitor automatically scans the signal inputs for an active input and uses that input for the display. If two or more inputs are active, the monitor will display the default input source. If the default source is not one of the active inputs, then the monitor will display the highest ranking priority input in the following order: DisplayPort, DVI, then VGA. You can change the default source in the OSD by pressing the front panel **Menu** button and selecting **Input Control > Default Input**.

## HP Watermark and Image Retention Policy

The IPS monitor models are designed with IPS (In-Plane Switching) display technology which provides ultra-wide viewing angles and advanced image quality. IPS monitors are suitable for a wide variety of advanced image quality applications. This panel technology, however, is not suitable for applications that exhibit static, stationary or fixed images for long periods of time without the use of screen savers. These types of applications may include camera surveillance, video games, marketing logos, and templates that are displayed on the screen for a prolonged period of time. Static images may cause image retention damage that could look like stains or watermarks on the monitor's screen.

Monitors in use for 24 hours per day that result in image retention damage are not covered under the HP warranty. To avoid image retention damage, always turn off the monitor when it is not in use or use the power management setting, if supported on your system, to turn off the display when the system is idle.

## Connecting USB Devices

USB connectors are used to connect devices such as a digital camera, USB keyboard, or USB mouse. Two USB connectors are located on the side panel of the monitor.



 **NOTE:** You must connect the USB hub cable from the monitor to the computer to enable the USB 2.0 ports on the monitor. Refer to Step 4 in [Connecting the Cables on page 5](#).

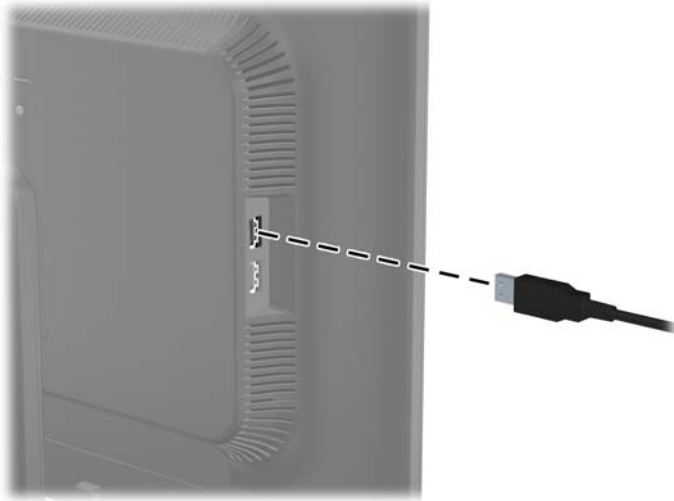

## Removing the Monitor Pedestal Base

You can remove the monitor panel from the pedestal base to install the panel on a wall, a swing arm, or other mounting fixture.

 **CAUTION:** Before beginning to disassemble the monitor, be sure the monitor is turned off and the power and signal cables are both disconnected. Also disconnect all USB cables connected to the monitor.

1. Disconnect and remove the signal, power, and USB cables from the monitor.
2. Lay the monitor face down on a flat surface covered by a clean, dry cloth.
3. Remove the four screws from the monitor stand.

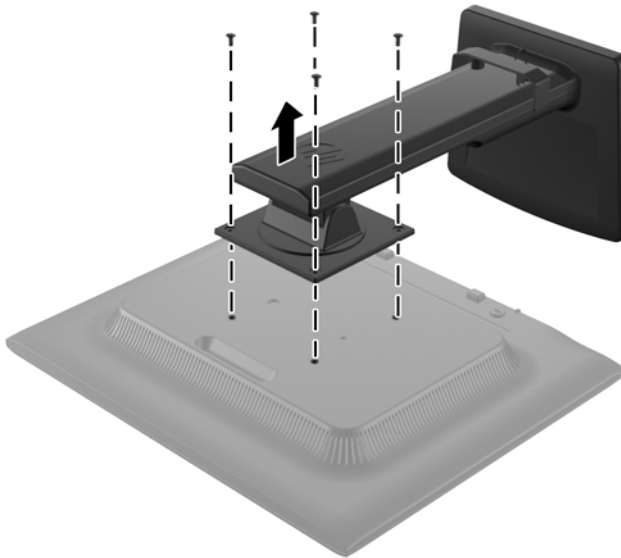

## Mounting the Monitor

The monitor panel can be attached to a wall, swing arm, or other mounting fixture.

 **NOTE:** This apparatus is intended to be supported by UL or CSA Listed wall mount bracket.

1. Remove the monitor panel from the pedestal base. Refer to [Removing the Monitor Pedestal Base on page 11](#).

 **CAUTION:** This monitor supports the VESA industry standard 100 mm mounting holes. To attach a third-party mounting solution to the monitor, four 4 mm, 0.7 pitch, and 10 mm long screws are required. Longer screws must not be used because they may damage the monitor. It is important to verify that the manufacturer's mounting solution is compliant with the VESA standard and is rated to support the weight of the monitor display panel. For best performance, it is important to use the power and video cables provided with the monitor.

2. To attach the monitor to a swing arm, insert four 10mm screws through the holes on the swing arm plate and into the mounting holes on the monitor.

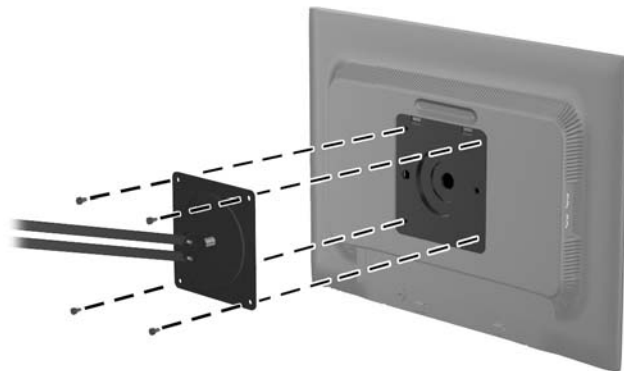

To attach the monitor to other mounting fixtures, follow the instructions included with the mounting fixture to ensure that the monitor is safely attached.

3. Reconnect the cables to the monitor panel.

## Locating the Rating Labels

The rating labels on the monitor provide the spare part number, product number, and serial number. You may need these numbers when contacting HP about the monitor model. The rating labels are located on the rear panel of the monitor display head.

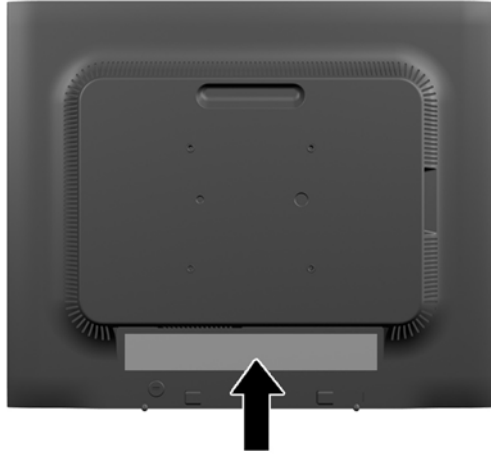

## Installing a Cable Lock

You can secure the monitor to a fixed object with an optional cable lock available from HP.



---

## 3 Finding More Information

### Reference Guides

Refer to the *HP LCD Monitors Reference Guide* included on the disc with your monitor for additional information on:

- Optimizing monitor performance
- Safety and maintenance guidelines
- Installing software from the disc
- Using the OSD menu
- Downloading software from the Web
- Agency regulatory information
- Troubleshooting and recommended solutions to common problems

For information on theft deterrence, refer to the *HP Display Assistant User Guide* included on the disc with your monitor.

### Product Support

For additional information on using and adjusting your monitor, go to <http://www.hp.com/support>. Select your country or region, select **Drivers and Downloads**, and then enter your monitor model in the Find by Product search field.

---

 **NOTE:** The monitor user guide, reference guide, and drivers are available at <http://www.hp.com/support>.

---

If the information provided in the guide or in the *HP LCD Monitors Reference Guide* do not address your questions, you can contact support. For U.S. support, go to <http://www.hp.com/go/contactHP>. For worldwide support, go to [http://welcome.hp.com/country/us/en/wwcontact\\_us.html](http://welcome.hp.com/country/us/en/wwcontact_us.html).

Here you can:

- Chat online with an HP technician

---

 **NOTE:** When support chat is not available in a particular language, it is available in English.

---

- E-mail support
- Find support telephone numbers
- Locate an HP service center

# A Technical Specifications

 **NOTE:** All specifications represent the typical specifications provided by HP's component manufacturers; actual performance may vary either higher or lower.

## EliteDisplay E190i

**Table A-1 EliteDisplay E190i Specifications**

Display Type	LED Backlit IPS	
Viewable Image Size	47.99 cm diagonal	18.89–inch diagonal
Aspect Ratio	5:4	
Tilt	-5 to 25°	
Swivel	-180 to 180°	
Pivot	90°	
Maximum Weight (Unpacked)	4.8 kg	10.58 lbs
Dimensions (include base)		
Height (highest position)	48.64 cm	19.15 inches
Height (lowest position)	36.53 cm	14.38 inches
Depth	19.21 cm	7.56 inches
Width	41.78 cm	16.45 inches
Maximum Graphic Resolution	1280 x 1024 (60 Hz)	
Optimum Graphic Resolution	1280 x 1024 (60 Hz)	
Text Mode	720 × 400	
Dot Pitch	0.2928 (H) × 0.2928 (W) mm	
Pixels Per Inch	86.9 PPI	
Horizontal Frequency	24 to 83 kHz	
Vertical Refresh Rate	50 to 76 Hz	
Environmental Requirements Temperature		
Operating Temperature	5 to 35° C	41 to 95° F
Storage Temperature	-20 to 60° C	-4 to 140° F
Relative Humidity	20 to 80%	
Power Source	100 – 240 VAC 50/60 Hz	
Altitude:		
Operating	0 to 5000 m	0 to 16,400 feet
Storage	0 to 12192 m	0 to 40,000 feet

**Table A-1 EliteDisplay E190i Specifications (continued)**

Measured Power Consumption:	
Full Power	28.0 watts
Typical Settings	26.0 watts
Sleep	<0.5 watts
Switch Off	<0.5 watts
Input Terminal	One VGA connector, one DVI connector, and one DisplayPort connector (cables included)



**NOTE:** For the latest specifications or additional specifications on this product, go to <http://www.hp.com/go/productbulletin/> and search for your specific display model to find the model-specific QuickSpecs.

## Recognizing Preset Display Resolutions

The display resolutions listed below are the most commonly used modes and are set as factory defaults. This monitor automatically recognizes these preset modes and they will appear properly sized and centered on the screen.

### EliteDisplay E190i

**Table A-2 Factory Preset Modes**

Preset	Pixel Format	Horz Freq (kHz)	Vert Freq (Hz)
1	640 × 480	31.469	59.94
2	720 × 400	31.469	70.087
3	800 × 600	37.879	60.317
4	1024 × 768	48.363	60.004
5	1280 × 1024	63.981	60.02

## Entering User Modes

The video controller signal may occasionally call for a mode that is not preset if:

- You are not using a standard graphics adapter.
- You are not using a preset mode.

If this occurs, you may need to readjust the parameters of the monitor screen by using the on-screen display. Your changes can be made to any or all of these modes and saved in memory. The monitor automatically stores the new setting, then recognizes the new mode just as it does a preset mode. In addition to the factory preset modes, there are at least 10 user modes that can be entered and stored.

## Energy Saver Feature

The monitors support a reduced power state. The reduced power state will be entered into if the monitor detects the absence of either the horizontal sync signal and/or the vertical sync signal. Upon detecting the absence of these signals, the monitor screen is blanked, the backlight is turned off, and the power light is turned amber. When the monitor is in the reduced power state, the monitor will utilize .5 watts of power. There is a brief warm up period before the monitor will return to its normal operating mode.

Refer to the computer manual for instructions on setting energy saver features (sometimes called power management features).



---

**NOTE:** The above power saver feature only works when connected to computers that have energy saver features.

---

By selecting the settings in the monitor's sleep timer utility, you can also program the monitor to enter into the reduced power state at a predetermined time. When the monitor's sleep timer utility causes the monitor to enter the reduced power state, the power light blinks amber.