

User's Manual

LCD TV

MODEL:

E328-2

Please find your model name on the label on the rear side of the monitor.

Table of Contents

Important Information	2	Recommended Use & Maintenance	9
-----------------------------	---	-------------------------------------	---

Chapter 1 Installation

Setup Overview	11	Ventilation Requirements.....	17
Mounting (for Customer)	14	Mounting on Walls or Ceilings.....	18
Mounting (for Trained Installers)	15	Installing and Removing the Optional Table Top Stand.....	19
Orientation	16		

Chapter 2 Parts Names and Functions

Control Panel	21	Wireless Remote Control.....	24
Terminal Panel.....	22		

Chapter 3 Connections

Wiring Diagram.....	26	HDMI-CEC Command	29
Headphones Connection	26	Internal Video Sources	30
Connecting to a Personal Computer	27	Media Player.....	30
Connecting to a Media Device with HDMI	28	Connecting a USB Device.....	31

Chapter 4 Basic Operation

Power On and Off Modes.....	33	Operating Range for the Remote Control.....	35
Power indicator status	33	Showing the Information OSD	36
Energy Mode	33	Switching Between Sound Modes.....	36
When [RS-232C] is selected for control, [Power supply] and [Quick Start] are set to [Off]	33	Switching Between Picture Modes.....	36
When [LAN] is selected for control, [Power supply] and [Quick Start] are set to [Off]	34	Setting the Aspect Ratio.....	37
		OSD (On-Screen Display) Controls.....	38
		Using the Media Player Menu	40

Chapter 5 Advanced Operation

Creating a Power Schedule.....	44	Setting Security and Locking the Monitor Controls	46
Using Picture Modes	45	Locking the Button Controls	47

Chapter 6 External Control

Controlling the Monitor via RS-232C	50	HTTP Browser.....	52
Controlling the Monitor via LAN.....	51	Commands	55

Chapter 7 Troubleshooting

When a problem occurs with the monitor.....	57	Others (remote control, speakers)	59
Nothing is displayed.....	57	Others (when connected via RS-232C or LAN)	60
The image is not displayed correctly.....	58	When using a media player.....	60
An instruction or caution screen is displayed.....	59	When using a video device	60
Others (when connected to a computer)	59		

Chapter 8 Specifications

Compatible Signal List	62	E328-2	64
------------------------------	----	--------------	----

Appendix A Trademark and Software License

Appendix B External Resources

Appendix C OSD Controls List

Video Settings	68	Control Settings	75
Audio Settings	70	Media Player.....	76
Channels	71	Schedule	77
Setup	72		

Appendix D Manufacturer's Recycling and Energy Information

Disposing of your old NEC product	79	About Conversion Cables Used with the AV Terminal.....	80
Energy Saving	79		

Appendix E About Crestron Connected

- NOTE:**
- (1) The contents of this manual may not be reprinted in part or whole without permission.
 - (2) The contents of this manual are subject to change without notice.
 - (3) Great care has been taken in the preparation of this manual; however, should you notice any questionable points, errors or omissions, please contact us.
 - (4) The image shown in this manual is indicative only. If there is inconsistency between the image and the actual product, the actual product shall govern.
 - (5) Notwithstanding articles (3) and (4), we will not be responsible for any claims on loss of profit or other matters deemed to result from using this device.
 - (6) This manual is commonly provided to all regions so they may contain descriptions that are pertinent for other countries.

Cable Information

CAUTION: Use the provided specified cables with this product so as not to interfere with radio and television reception.
For mini D-Sub 15-pin and USB, use shielded signal cables with ferrite core.
For the HDMI and AV cables, use shielded signal cables.
The use of other types of cables and adapters may cause reception problems.

FCC Information

CAUTION:

To assure continued compliance and prevent possible undesirable interference, ferrite cores may be used when connecting this LCD TV to video equipment; and maintain at least 400mm spacing to other peripheral device.

Use the attached specified cables with the E658 / E558 / E498 / E438 / E328 of LCD TV so as not to interfere with radio and television reception.

- (1) Please use the supplied power cord.
- (2) Please use the supplied shielded HDMI signal cable.
- (3) For AV, please use a shielded signal cable.
- (4) For mini D-Sub 15-pin and USB, please use a shielded signal cable with ferrite core.
- (5) For D-sub 9-pin and Coaxial, please use a shielded signal cable.
- (6) Connections to this device must be made with shielded cables with metallic RF / EMI connector hoods to maintain compliance with FCC Rules and Regulations.

WARNING: The Federal Communications Commission does not allow any modifications or changes to the unit EXCEPT those specified by Sharp NEC Display Solutions of America, Inc. in this manual. Failure to comply with this government regulation could void your right to operate this equipment.

This equipment has been tested and found to comply with the limits for a Class B digital device, pursuant to part 15 of the FCC Rules. These limits are designed to provide reasonable protection against harmful interference in a residential installation. This equipment generates, uses, and can radiate radio frequency energy, and, if not installed and used in accordance with the instructions, may cause harmful interference to radio communications. However, there is no guarantee that interference will not occur in a particular installation. If this equipment does cause harmful interference to radio or television reception, which can be determined by turning the equipment off and on, the user is encouraged to try to correct the interference by one or more of the following measures:

- Reorient or relocate the receiving antenna.
- Increase the separation between the equipment and receiver.
- Connect the equipment into an outlet on a circuit different from that to which the receiver is connected.
- Consult your dealer or an experienced radio/TV technician for help.

SUPPLIER'S DECLARATION OF CONFORMITY

This device complies with Part 15 of the FCC Rules. Operation is subject to the following two conditions. (1) This device may not cause harmful interference, and (2) this device must accept any interference received, including interference that may cause undesired operation.

	U.S. Responsible Party:	Sharp NEC Display Solutions of America, Inc.
	Address:	3250 Lacey Rd, Ste 500 Downers Grove, IL 60515 (630) 467-3000
	Tel. No.:	
	Type of Product:	LCD TV
	Equipment Classification:	Class B Peripheral
	Model:	E328-2

Canadian Notice

Cable-Compatible Analog and Digital Television Receiving Apparatus — Appareil de réception de télévision analogique et numérique câblcompatible, Canada BETS-7 / NTMR-7.



Important Information

Safety Precautions and Maintenance



FOR OPTIMUM PERFORMANCE, PLEASE NOTE
THE FOLLOWING WHEN SETTING UP AND
USING THE LCD TV:





About the Symbols

To ensure safe and proper use of the product, this manual uses a number of symbols to prevent injury to you and others as well as damage to property. The symbols and their meanings are described below. Be sure to understand them thoroughly before reading this manual.

 WARNING	Failing to heed this symbol and handling the product incorrectly could result in accidents leading to major injury or death.
 CAUTION	Failing to heed this symbol and handling the product incorrectly could result in personal injury or damage to surrounding property.







Examples of symbols

	This symbol indicates a warning or caution.
	This symbol indicates a prohibited action.
	This symbol indicates a mandatory action.

 WARNING	
 UNPLUG THE POWER CORD	Unplug the power cord if the product malfunctions. Should the product emit smoke or strange odors or sounds, or if the product has been dropped or the cabinet broken, turn off the product's power, then unplug the power cord from the power outlet. Contact your dealer for repairs. Never try to repair the product on your own. Doing so is dangerous.
 DO NOT MODIFY	Do not open or remove the product's cabinet. Do not disassemble the product. There are high voltage areas in the product. Opening or removing product covers and modifying the product may expose you to electric shock, fire, or other risks. Refer all servicing to qualified service personnel.
 PROHIBITED	Do not use the product if it has structural damage. If you notice any structural damage such as cracks or unnatural wobbling, please refer servicing to qualified service personnel. If the product is used in this condition, the product may fall or cause personal injury.

 **WARNING**

Handling the power cord.

 PROHIBITED	<p>Do not scratch or modify the cord.</p> <ul style="list-style-type: none"> • Do not place heavy objects on the cord. • Do not let the weight of the product rest on the cord. • Do not cover the cord with a rug, etc. • Do not bend, twist or pull the cord with excessive force. • Do not apply heat to the cord. <p>Handle the power cord with care. Damaging the cord could lead to fire or electric shock. If the cord gets damaged (exposed core wires, broken wires, etc.), turn off the product's power, then unplug the power cord from the power outlet. Ask your dealer to replace it.</p>
 DO NOT TOUCH	<p>Do not touch the power plug if you hear thunder. Doing so could result in electric shock.</p>
 DO NOT TOUCH WITH WET HANDS	<p>Do not connect or disconnect the power cord with wet hands. It may cause an electric shock.</p>
 REQUIRED	<p>Please use the power cord provided with this product in accordance with the power cord table. Do not exceed the product's specified power supply voltage where it is installed. Doing so could result in a fire or electric shock. Please refer to the power supply voltage information in the specification.</p> <p>If a power cord is not supplied with this product, please contact us. For all other cases, please use the power cord with the plug style that matches the power socket where the product is located. The compatible power cord corresponds to the AC voltage of the power outlet and has been approved by, and complies with, the safety standards in the country of purchase.</p>
 REQUIRED	<p>For proper installation it is strongly recommended to use a trained service person. Failure to follow the standard installation procedures could result in damage to the product or injury to the user or installer.</p>
 REQUIRED	<p>Please install the product in accordance with the following information. This product cannot be used or installed without the table top stand or other mounting accessory for support.</p> <p>When transporting, moving, or installing the product, please use as many people (two or more people) as necessary to be able to lift the product without causing personal injury or damage to the product.</p> <p>Please refer to the instructions included with the optional mounting equipment for detailed information about attaching or removing.</p> <p>Do not cover the vent on the product. Improper installation of the product may result in damage to the product, an electric shock or fire.</p> <p>Do not install the product in the locations below:</p> <ul style="list-style-type: none"> • Poorly ventilated spaces. • Near a radiator, other heat sources, or in direct sunshine. • Continual vibration areas. • Humid, dusty, steamy, or oily areas. • An environment where there are corrosive gases (sulfur dioxide, hydrogen sulfide, nitrogen dioxide, chlorine, ammonia, ozone, etc.). • Outdoors. • High-temperature environment where humidity changes rapidly and condensation is likely to occur. • A ceiling or wall that is not strong enough to support the product and mounting accessories. <p>Do not mount the product upside down.</p>

WARNING



REQUIRED

Prevent tipping and falling for earthquakes or other shocks.

To prevent personal injury or damage to the product caused by tipping over due to earthquakes or other shocks, make sure to install the product in a stable location and take measures to prevent falling.

The measures to prevent falling and tipping are intended for reducing the risk of injury, but may not guarantee the effectiveness against all earthquakes.

The product may tip causing personal injury.

- When using the product with the optional table top stand, fasten the product to a wall using a cord or chain that can support the weight of the product in order to prevent the product from falling.

Depending on the table top stand, the stand has the structure for preventing tipping. Please refer to the table top stand manual.



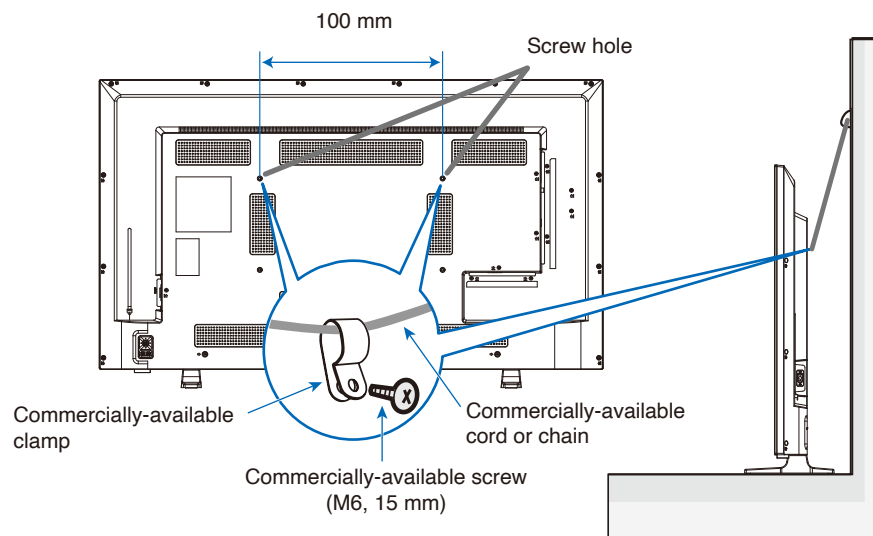



- Be sure to remove the cord or chain from the wall before moving the product to prevent personal injury or damage to the product.





The product may fall causing personal injury.

- Do not attempt to hang the product using an installation safety wire.
- Please install the product in an area on the wall or ceiling strong enough to support the weight of the product.
- Prepare the product using mounting accessories, such as hook, eyebolt, or mounting parts, and then secure the product with a safety wire. The safety wire must not be tight.
- Please make sure the mounting accessories are strong enough to support the product weight and size before installing it.













 **WARNING**

 REQUIRED	<p>Stability Hazard.</p> <p>The product may fall, causing serious personal injury or death. To prevent injury, this product must be securely attached to the floor/wall in accordance with the installation instructions.</p> <p>Many injuries, particularly to children, can be avoided by taking simple precautions such as:</p> <ul style="list-style-type: none"> • ALWAYS use stands or installation methods recommended by the manufacturer of the product set. • ALWAYS use furniture that can safely support the product. • ALWAYS ensure the product is not overhanging the edge of the supporting furniture. • ALWAYS educate children about the dangers of climbing on furniture to reach the product or its controls. • ALWAYS route cords and cables connected to your product so they cannot be tripped over, pulled or grabbed. • NEVER place a product in an unstable location. • NEVER place the product on tall furniture (for example, cupboards or bookcases) without anchoring both the furniture and the product to a suitable support. • NEVER place the product on cloth or other materials that may be located between the product and supporting furniture. • NEVER place items that might tempt children to climb, such as toys and remote controls, on the top of the product or furniture on which the product is placed. <p>If the existing product is going to be retained and relocated, the same considerations as above should be applied.</p>
 PROHIBITED	<p>Do not place this product on a sloping or unstable cart, stand or table. Doing so could lead to falling or tipping and cause personal injury.</p>
 PROHIBITED	<p>Do not insert objects of any kind into the cabinet slots. It may cause electric shock, fire, or product failure. Keep objects away from children and babies.</p> <p>If objects get into the cabinet slot, turn off the product's power, then unplug the power cord from the power outlet. Contact your dealer for repairs.</p>
 DO NOT WET	<p>Do not spill any liquids into the cabinet or use your product near water.</p> <p>Immediately turn off the power and unplug your product from the wall outlet, then refer servicing to qualified service personnel. It may cause an electric shock or start a fire.</p> <p>Do not install the product under equipment that discharges water, such as air conditioners.</p>
 PROHIBITED	<p>Do not use flammable gas sprays to remove dust when cleaning the product. Doing so could lead to a fire.</p>
 PROHIBITED	<p>Usage of the product must not be accompanied by fatal risks or dangers that, could lead directly to death, personal injury, severe physical damage or other loss, including nuclear reaction control in nuclear facility, medical life support system, and missile launch control in a weapon system.</p>









	WARNING	
<p>TO PREVENT FIRE OR SHOCK HAZARDS, DO NOT EXPOSE THIS UNIT TO RAIN OR MOISTURE. ALSO, DO NOT USE THIS UNIT'S POLARIZED PLUG WITH AN EXTENSION CORD RECEPTACLE OR OTHER OUTLETS UNLESS THE PRONGS CAN BE FULLY INSERTED.</p> <p>REFRAIN FROM OPENING THE CABINET AS THERE ARE HIGH VOLTAGE COMPONENTS INSIDE.</p> <p>REFER SERVICING TO QUALIFIED SERVICE PERSONNEL.</p>		

 **CAUTION**

Handling the power cord.

 REQUIRED	The monitor should be installed close to an easily accessible power outlet.
 REQUIRED	When connecting the power cord to the product's AC IN terminal, make sure the connector is fully and firmly inserted. An incomplete connection of the power cord may cause overheating of the plug; it allows dust to get on the plug connection, which can lead to a fire. Touching the pins of a partially inserted plug may lead to an electric shock. Fasten the power cord to the product by attaching the clamp to prevent loose connection. (Recommended Fasten Force: 120 - 190 N • cm).
 REQUIRED	Handling the power cord by following below to avoid fire or electric shock. <ul style="list-style-type: none"> • When connecting or disconnecting the power cord, pull the power cord out by holding onto its plug. • Unplug the power cord from the power outlet before cleaning the product or when not planning to use the product for an extended time. • When the power cord or plug is heat or damaged, unplug the power cord from the power outlet, and contact a qualified service person.
 REQUIRED	Regularly dust off the power cord by using a soft dry cloth.
 REQUIRED	Before moving the product, make sure the product power is off, then unplug the power cord from the power outlet and check that all cables connecting the product to other devices are disconnected.
 PROHIBITED	Do not use the power cord with a power tap. Adding an extension cord may lead to fire as a result of overheating.
 PROHIBITED	Do not bind the power cord and the USB cable. It may trap heat and cause a fire.
 PROHIBITED	Do not connect to a LAN with excessive voltage. When using a LAN cable, do not connect to a peripheral device with wiring that might have excessive voltage. Excessive voltage on the LAN port may cause an electric shock.
 PROHIBITED	Do not climb on the table where the product is installed. Do not install the product on a wheeled table if the wheels on the table have not been properly locked. The product may fall, causing damage to the product or personal injury.
 REQUIRED	Installation, removal, and height adjustment of the optional table top stand. <ul style="list-style-type: none"> • When installing the table top stand, handle the unit with care to avoid pinching your fingers. • Installing the product at the wrong height can cause tipping. Please install your product at proper height to prevent personal injury or damage to the product.
 PROHIBITED	Do not push or climb on the product. Do not grab or hang onto the product. Do not rub or tap the product with hard objects. The product may fall, causing damage to the product or personal injury.
 PROHIBITED	Do not hit or strike the screen. Do not push against the screen with a pointed object. It can cause serious damage to the product or personal injury.

 **CAUTION**

 REQUIRED	<p>Incorrect usage of batteries can result in leaks or bursting.</p> <ul style="list-style-type: none"> • Use the specified batteries only. • Insert batteries matching the (+) and (–) signs on each battery to the (+) and (–) signs of the battery compartment. • Do not mix battery brands. • Do not combine new and old batteries. This can shorten battery life or cause liquid leakage of batteries. • Remove dead batteries immediately to prevent battery acid from leaking into the battery compartment. If leaked battery fluid gets on your skin or clothing, rinse immediately and thoroughly. If it gets into your eye, bathe your eye well rather than rubbing and seek medical treatment immediately. Leaked battery fluid that gets into your eye or your clothing may cause a skin irritation or damage your eye. • If you will not use the remote control for a long time, remove the batteries. • Leaving a battery in an extremely high temperature surrounding environment, or a battery subject to extremely low air pressure, that can result in an explosion or the leakage of flammable liquid or gas. • Properly dispose of depleted batteries. Disposal of a battery into water, fire, or a hot oven, or mechanically crushing, cutting, or modifying a battery can result in an explosion. • Do not short-circuit the batteries. • Do not charge the batteries. The batteries provided are not rechargeable. • Contact your dealer or local authorities when disposing of batteries.
 PROHIBITED	<p>Do not stay in contact with the parts of the product that become hot for long periods of time. Doing so may result in low-temperature burns.</p>
 REQUIRED	<p>Suitable for entertainment purposes at controlled luminous environments, to avoid disturbing reflections from the screen.</p>
 REQUIRED	<p>We recommend wiping clean the ventilation holes a minimum of once a month. Failure to do so could lead to fire or electric shock or damage to the product.</p>
 REQUIRED	<p>To ensure the product's reliability, please clean the ventilation holes at the rear side of the cabinet at least once a year to remove dirt and dust. Failure to do so could lead to fire or electric shock or damage to the product.</p>
 REQUIRED	<p>Avoid locations with extreme temperatures and humidity. Failure to do so could lead to fire or electric shock or damage to the product. The usage environment for this product is as follows:</p> <ul style="list-style-type: none"> • The operating temperature: 0 °C to 40 °C/32 °F to 104 °F/ humidity: 20 to 80% (without condensation) • The storage temperature: -20 °C to 60 °C/-4 °F to 140 °F/ humidity: 10 to 80% (without condensation)
 REQUIRED	<p>If an outside antenna is connected to the receiver, confirm that the antenna system is grounded to protect against voltage surges and built up static charges. Section 810 of the National Electric Code, ANSI / NFPA No. 70-1984, provides information with respect to proper grounding for the mast and supporting structure, grounding of the lead-in wire to an antenna discharge unit, size of grounding connectors, location of antenna discharge unit, connection to grounding electrodes and requirements for the grounding electrode.</p> <p>The cable distribution system should be grounded (earthed) in accordance with ANSI/NFPA 70. the National Electrical Code (NEC), in particular Section 820.93, Grounding of Outer Conductive Shield of a Coaxial Cable.</p>
 REQUIRED	<p>Rest your eyes periodically by focusing on an object at least 5 feet away. Blink often.</p>

⚠ CAUTION



REQUIRED

To the TV system installer: This reminder is provided to call attention to Article 820-44 of the National Electric Code that provides guidelines for proper grounding and, in particular, specifies that the cable ground shall be connected to the grounding system of the facility, as reasonably close to the point of cable entry as possible.

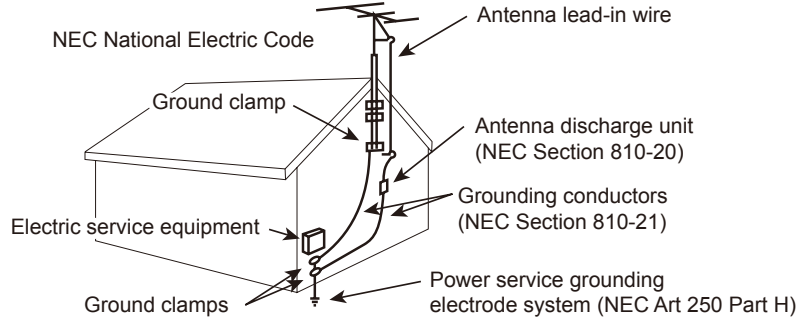

CAUTION



CAUTION: TO REDUCE THE RISK OF ELECTRIC SHOCK, MAKE SURE POWER CORD IS UNPLUGGED FROM WALL SOCKET. TO FULLY DISENGAGE THE POWER TO THE UNIT, PLEASE DISCONNECT THE POWER CORD FROM THE AC OUTLET. DO NOT REMOVE COVER (OR BACK). NO USER SERVICEABLE PARTS INSIDE. REFER SERVICING TO QUALIFIED SERVICE PERSONNEL.



This symbol warns user that uninsulated voltage within the unit may have sufficient magnitude to cause electric shock. Therefore, it is dangerous to make any kind of contact with any part inside this unit.



This symbol alerts the user that important literature concerning the operation and maintenance of this unit has been included. Therefore, it should be read carefully in order to avoid any problems.

CAUTION: Please use the power cord provided with this TV in accordance with the table below. If a power cord is not supplied with this equipment, please contact your supplier.

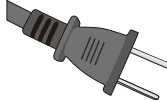
Plug Type	Plug Shape	Region	Voltage
North America		U.S.A./Canada	AC 120 V

Power source

This LCD TV operates on 120 volts 60 Hz, AC current. Insert the power cord into a 120 volts 60 Hz outlet. The mains plug is used as the disconnect device and shall remain readily operable.

To prevent electric shock from the TV, do not use with an extension cord, receptacle, or other outlet unless the blades and ground terminal can be fully inserted to prevent blade exposure.

Never connect the LCD TV to 50 Hz, direct current, or anything other than the specified voltage.

Recommended Use & Maintenance

Recommended Use

Ergonomics

To realize the maximum ergonomic benefits, we recommend the following:

- For optimum performance of the monitor, allow 20 minutes for warming up. Avoid reproduction of still patterns on the monitor for long periods of time to avoid image persistence (after image effects).
- Rest your eyes periodically by focusing on an object at least 5 feet away. Blink often.
- Position the monitor at a 90° angle to windows and other light sources to minimize glare and reflections.
- Adjust the monitor's brightness, contrast and sharpness controls to enhance readability.
- Get regular eye checkups.
- Use the preset Size and Position controls with standard input signals.
- Use the preset color settings.
- Use non-interlaced signals.
- Do not view the primary color blue on a dark background. It is difficult to see and may cause eye fatigue due to insufficient contrast.

Maintenance

Cleaning the LCD Screen

- When the LCD screen is dusty, please gently wipe with a soft cloth.
- Clean the LCD screen surface with a lint-free, non-abrasive cloth. Avoid using any cleaning solution or glass cleaner!
- Please do not rub the LCD screen with a hard or abrasive material.
- Please do not apply pressure to the LCD screen surface.
- Please do not use OA cleaner as it will cause deterioration or discoloration on the LCD screen surface.

Cleaning the Cabinet

- Unplug the power supply.
- Gently wipe the cabinet with a soft cloth.
- To clean the cabinet, dampen the cloth with a neutral detergent and water, wipe the cabinet and follow with a dry cloth.

NOTE: DO NOT clean with benzene thinner, alkaline detergent, alcoholic system detergent, glass cleaner, wax, polish cleaner, soap powder, or insecticide. Rubber or vinyl should not be in contact with the cabinet for an extended period of time. These types of fluids and materials can cause the paint to deteriorate, crack or peel.

NOTE: Continuous operating time and warranty.

This product is designed for a maximum daily use of 16 hours. Continual use in excess of 16 hours per day is not covered by the warranty.

Chapter 1 Installation

This Chapter Includes:

- ⇒ "Setup Overview" on page 11
- ⇒ "Mounting (for Customer)" on page 14
- ⇒ "Mounting (for Trained Installers)" on page 15
- ⇒ "Orientation" on page 16
- ⇒ "Ventilation Requirements" on page 17
- ⇒ "Mounting on Walls or Ceilings" on page 18
- ⇒ "Installing and Removing the Optional Table Top Stand" on page 19

Please read "[Important Information](#)" carefully before installation.

NOTE:

For box contents, please refer to the Setup Manual.

Product warranty does not cover damage caused by improper installation. Failure to follow these recommendations could result in voiding the warranty.

Setup Overview

1. Determine the installation location

NOTE: To avoid scratching the LCD panel, always place a soft cloth, such as a blanket that is larger than the monitor's screen area, on the table before laying the monitor face down when installing the monitor stand or mounting accessories.

2. Install the remote control batteries

The remote control is powered by two 1.5 V AAA batteries.

To install or replace batteries:

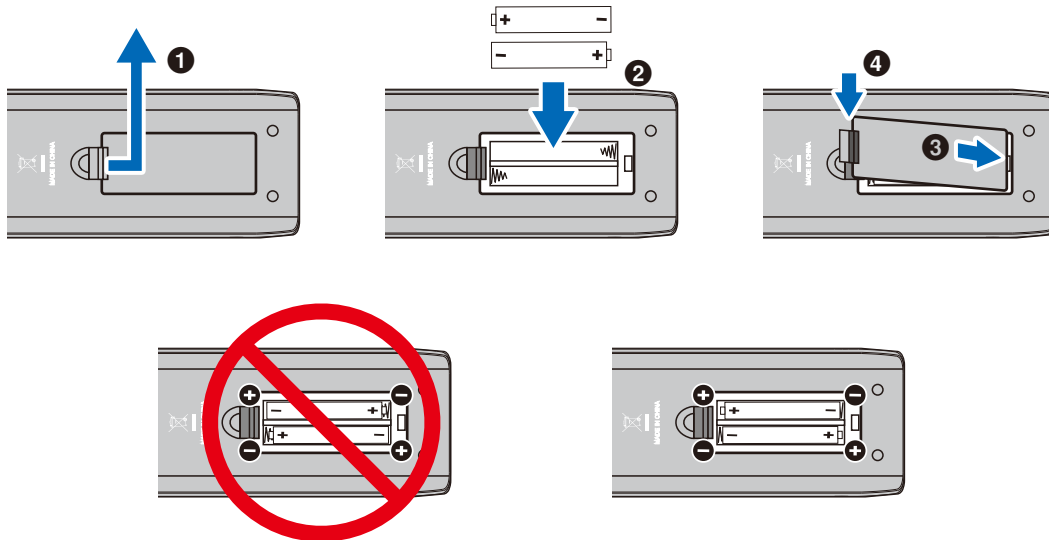

- NOTE:**
- The batteries supplied with the remote control may become empty quickly depending on their condition. Therefore, replace them with new batteries early.
 - If you do not intend to use the remote control for a long period of time, remove the batteries.
 - Use manganese or alkaline batteries only.

3. Connect external equipment

- To protect the external equipment, disconnect the power cord of the monitor before making connections.
- Refer to the user's manual of your equipment for further information.

NOTE: Do not connect/disconnect cables when turning on the monitor or other external equipment as this may result in loss of image.

4. Connect the supplied power cord

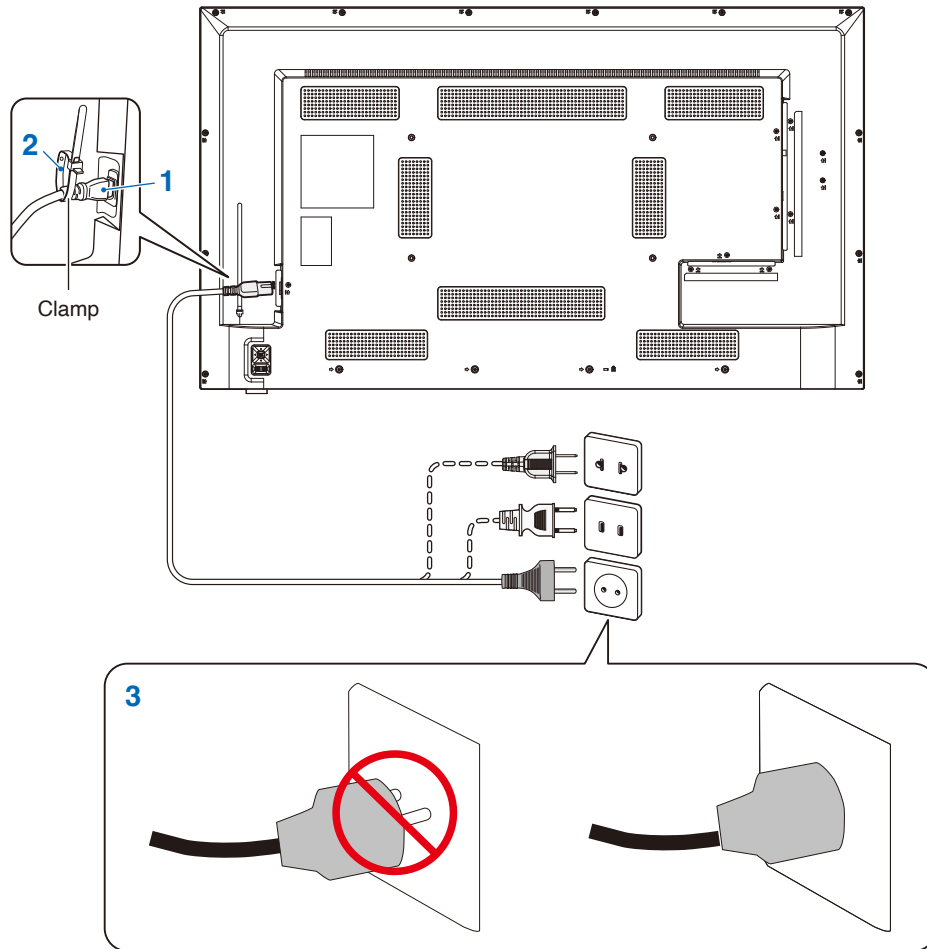

5. Cable information

CAUTION: Use the provided specified cables with this product so as not to interfere with radio and television reception. For mini D-Sub 15-pin and USB, use shielded signal cables with ferrite core. For the HDMI and AV cables, use shielded signal cables. The use of other types of cables and adapters may cause reception problems.

6. Turn the power button on

Switch on the monitor power before turning the computer or external equipment on.

7. Operate the connected external equipment

Select the input source for the monitor to display the video from the external equipment on the screen.

8. Adjust the sound

Make volume adjustments when required.

9. Adjust the picture settings

- When using video input terminals (HDMI1, HDMI2, HDMI3, Media Player), adjustment is not required.
- When using an HDMI input terminal, select the appropriate setting between [Mode 0], [Mode 1], and [Mode 2] in [EDID] under [HDMI Settings] in the [Setup] OSD menu.

10. Recommended adjustments

The backlight used for this monitor has a limited life and its brightness decreases with the usage time.

Also, if the same still image is shown for a long time, "Image Persistence" may occur. "Image Persistence" is a phenomenon in which the image of an LCD remains visible after the image has changed.

The "Image Persistence" is gradually eliminated by changing the screen, but if the same screen is shown for too long, the "Image Persistence" will not disappear.

To avoid shortening the monitor's lifetime, consider the following:

- Turn off the monitor's main power switch when not in use.
- Use the ⏻ button on the main unit or the ⏻ button on the remote control to put the monitor in standby mode.
- If using a cover made of glass or acrylic to protect the panel surface of the main unit, the panel is sealed and the internal temperature rises.
Reduce the monitor's brightness to prevent the internal temperature from rising. If the monitor is connected to a computer, use the computer's power management function to control the monitor's automatic power off.
- Use [Schedule] in the OSD menu to automatically control the monitor's on and standby power states as required.

NOTE: When using the schedule function, set [Current Time settings] in the [Schedule] OSD menu.

11. Remote control sensor

Be careful not to damage the remote control sensor during installation.

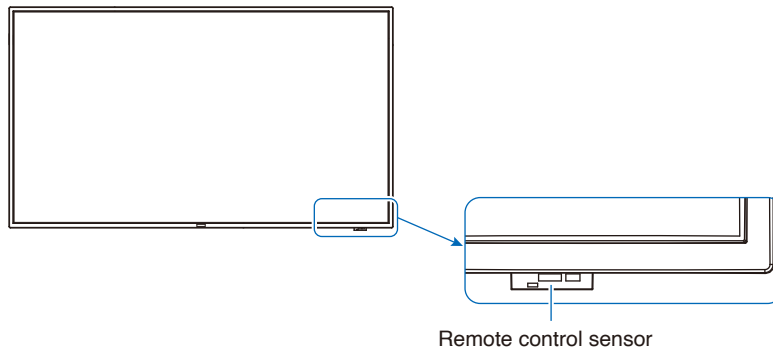

Mounting (for Customer)

Contact your supplier as they may be able to provide a list of qualified installation professionals. Mounting the product on a wall or ceiling and hiring a technician are the customer's responsibility.

Maintenance

- Periodically check for loose screws, gaps, distortions, or other problems that may occur with the mounting equipment. If a problem is detected, refer to a qualified personnel or the supplier for service.
- Depending on the environment, the mounting location may weaken due to natural degradation. Regularly ask a qualified personnel to inspect the mounting location and carry out maintenance.

Mounting (for Trained Installers)

Carefully inspect the location where the unit is to be mounted. Not all walls or ceilings are capable of supporting the weight of the monitor.

The weight of this monitor is provided in the specifications (see "E328-2" on page 64).

The product warranty does not cover damage caused by improper installation, re-modeling, or natural disasters.

Failure to comply with these recommendations could result in voiding the warranty.

To ensure safe installation, use two or more brackets to mount the unit. Mount the unit to at least two points on the installation location.

Allow for adequate ventilation or provide air conditioning around the monitor, so that heat can properly dissipate away from the monitor and from the mounting equipment.

Mounting bracket

Please note the following when mounting on a wall or ceiling:

- We recommend mounting interfaces that comply with UL1678 standard in North America.
- For detailed information, refer to the instructions included with the mounting equipment.

We strongly recommend using the screws as shown below.

If using screws longer than specified below, check the specifications for the depth of the bracket hole.

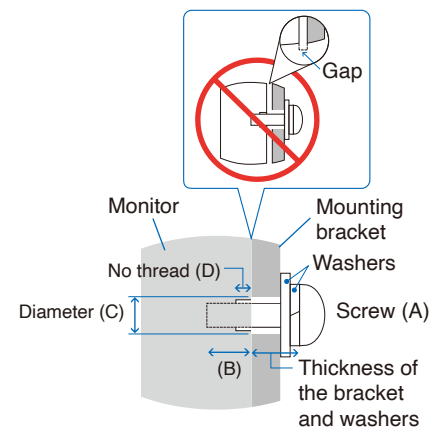

Screw Size		Bracket Hole	No Thread	Recommended Fasten Force
(A)	(B)	(C)	(D)	
M6 (4 pcs)	13-15 mm	$\leq \text{Ø } 8.5 \text{ mm}$	2.3 mm	390-520 N·cm

NOTE: When used in a video wall configuration for a long time, a slight expansion of the monitors may happen due to temperature changes. It is recommended that a gap of over one millimeter is kept between adjacent monitor edges.

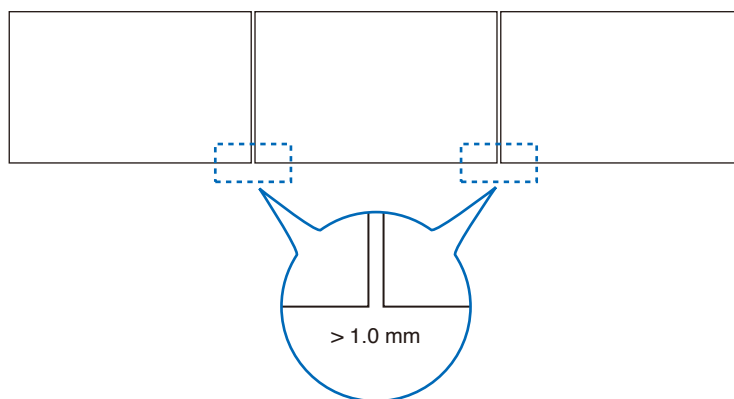

Installing a safety wire

When installing the monitor to a wall or a ceiling, use commercially-available wall or ceiling mounting brackets, but also a safety wire.

NOTE: When installing, do not apply pressure to the LCD panel or excessive force to any part of the monitor by pushing or leaning on it. This may cause the monitor to become distorted or damaged.

Orientation

The monitor cannot be used in the portrait orientation.

- Do not install it in the portrait orientation. Otherwise, it may cause a malfunction.

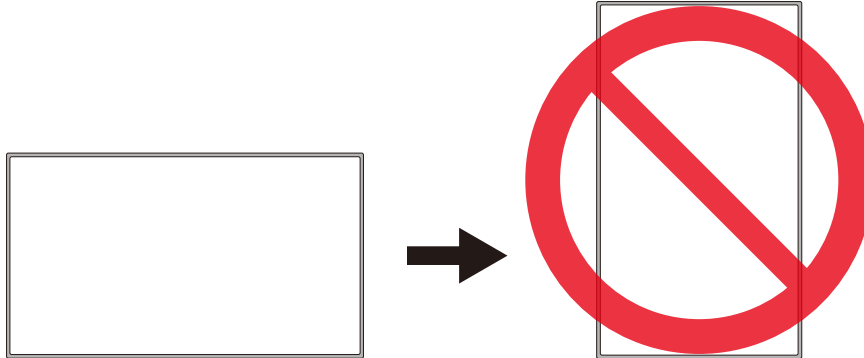

- It cannot be installed upside down.

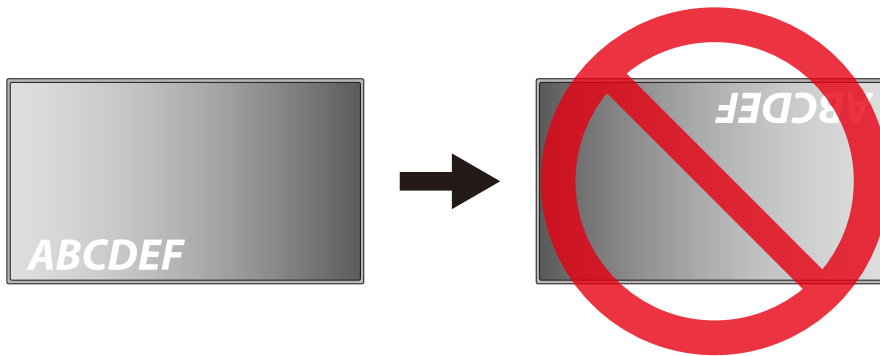

The monitor cannot be used when inclined 11° or more.

NOTE: Installing the monitor at an angle of 11° or more may cause a malfunction.

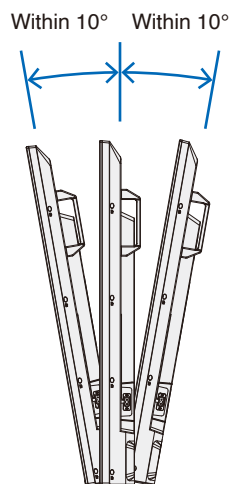

Ventilation Requirements

When mounting the monitor in an enclosed space or recessed area, leave adequate room between the monitor and the enclosure to allow heat to disperse, as shown below.

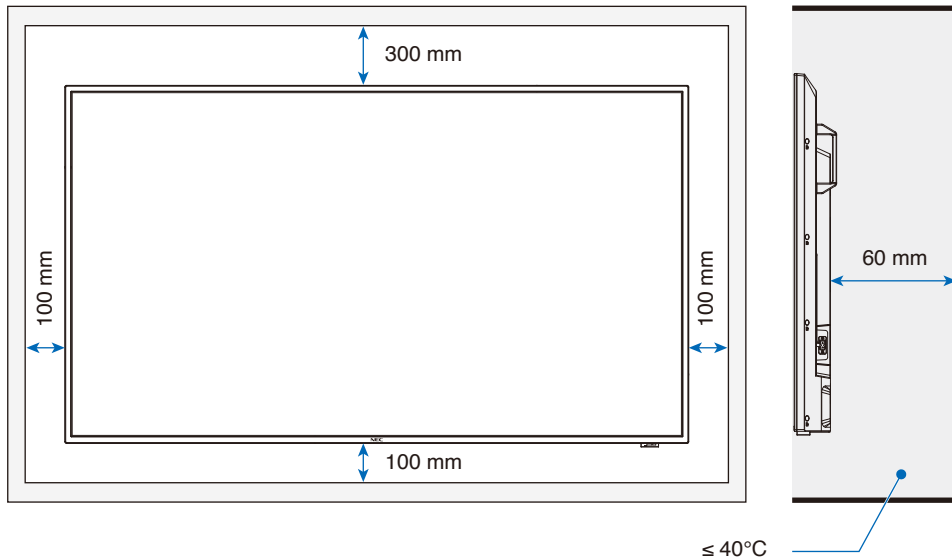

NOTE: The maximum environmental operating temperature of the monitor is 40°C . This monitor has internal temperature sensors.

NOTE: If the monitor overheats, a “Warning” appears. If a “Warning” appears, stop using the monitor, turn off the power and allow it to cool.
For more information on this function, see “Thermal Management” ([page 74](#)).
If the monitor is used in an enclosed area or if the LCD panel is covered with an acrylic protective sheet, check the temperature around the monitor.

Mounting on Walls or Ceilings

Precautions when mounting the monitor on a wall or a ceiling

Be sure to read this section before mounting the monitor on a wall or a ceiling to guarantee safety.

- It may not be possible to mount the monitor on some walls or ceilings depending on their structure or strength. Ask the qualified personnel or the supplier to check the mounting location.

Installation method

1. Place a soft cloth on the table or another flat location where the monitor will be laid.

- NOTE:**
- Make sure that the surface where you will lay the monitor is larger than the monitor screen.
 - When installing, do not apply excessive force to any part of the monitor by pushing or leaning on it. This may deform the monitor.

2. Place the monitor on top of the soft cloth.
3. Install the commercially-available mounting brackets.

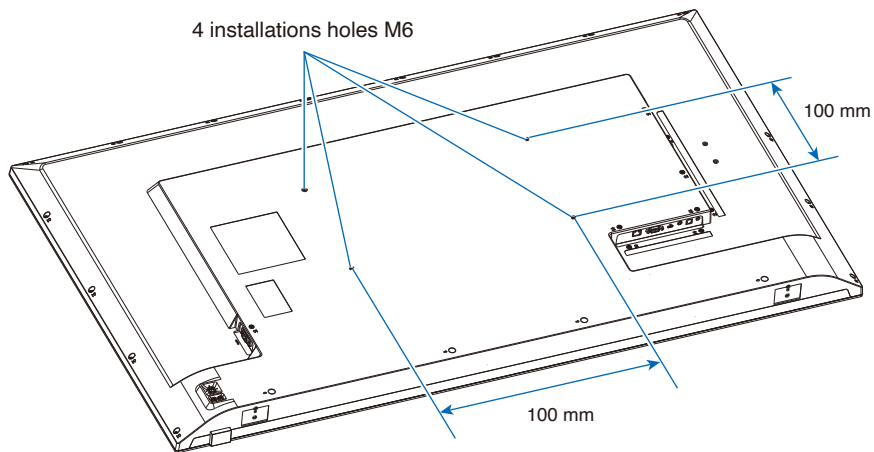

Installing and Removing the Optional Table Top Stand

Installing the table top stand

Lay the monitor down on a mat, a blanket, or another soft material so that the panel is facing downward.

NOTE: The monitor can only be used in the landscape orientation with the table top stand.

E328-2	ST-32E2 (screws are included)
--------	-------------------------------

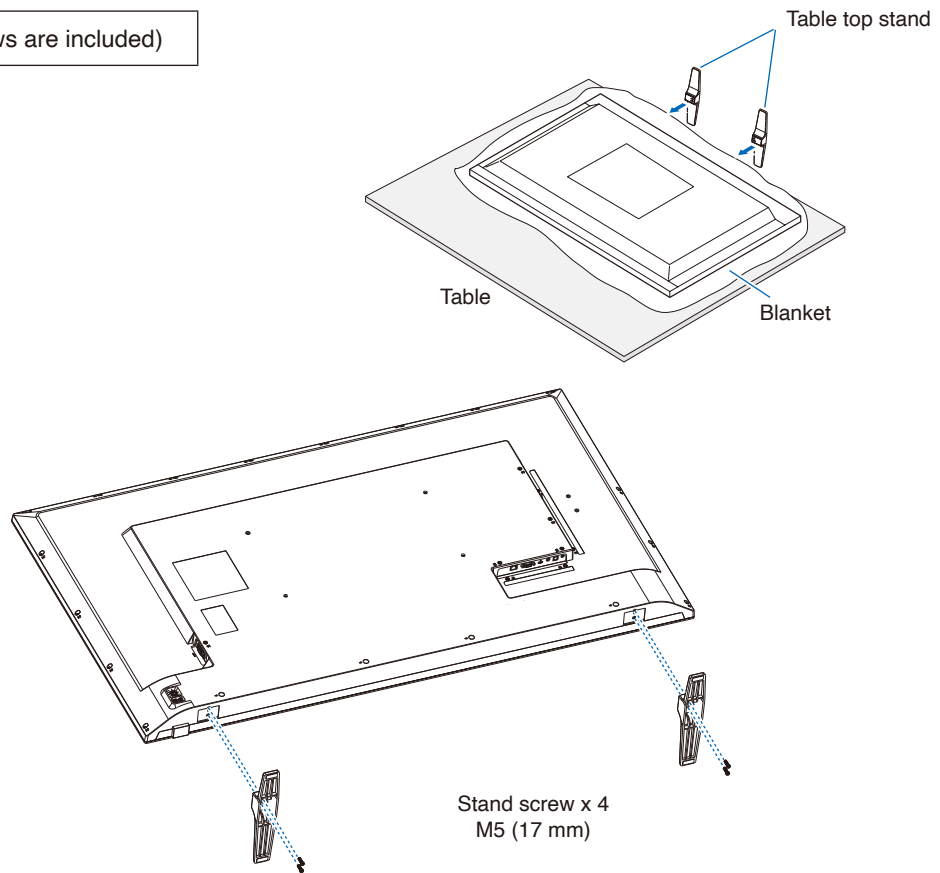

Chapter 2 Parts Names and Functions

This Chapter Includes:

- ⇒ "Control Panel" on page 21
- ⇒ "Terminal Panel" on page 22
- ⇒ "Wireless Remote Control" on page 24

Control Panel

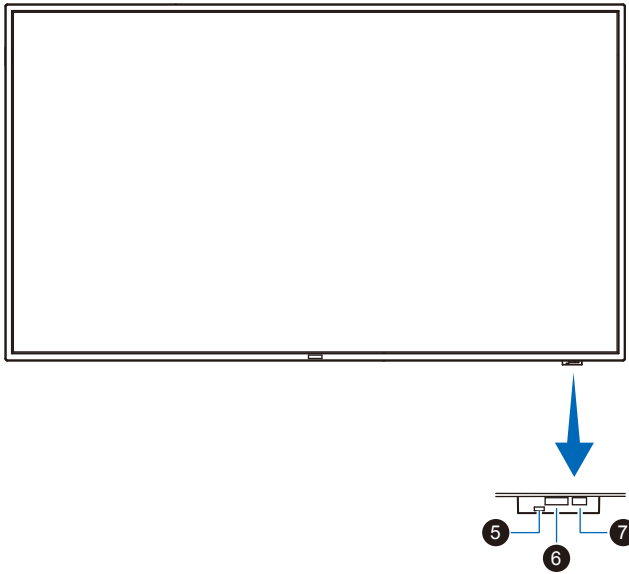
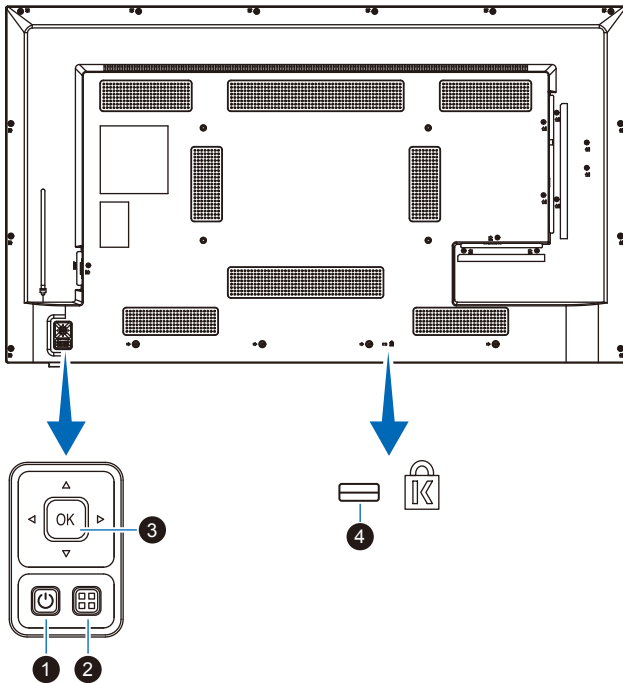

1 Button (power button)

Switches between power on and standby.

2 MENU/EXIT Button

Opens the OSD menu when the OSD menu is closed.

Acts as a back button within the OSD menu to move to the previous OSD menu.

Acts as an exit button to close the OSD menu when on the main menu.

3 Arrow Keys/SET Button (input switch button)

Central/SET: Operates as the setting button to execute the function selected when the OSD menu is open.

Left/Right: Move to the right or left of the OSD control menu.

Moving the left/right keys left and right increases or decreases the adjustment values.

Up/Down: Move up and down in the OSD control menu.

Pressing the left/right keys when the OSD menu is closed directly adjusts the volume.

4 Security Slot

Security and theft protection lock slot compatible with Kensington security cables/equipment.

NOTE: For products, visit Kensington's website.

5 Power Indicator

- Normal operation (On mode): Lit blue*
- Auto power save mode: Blinking red
- Auto standby mode: Lit red
- Turn off the monitor by the remote control: Glowing red

*: If [Off] is selected under the [LED indicator] in the [Other settings] of the [Setup] menu, the LED will not glow when the monitor is in active mode. See [page 74](#).

6 Remote Control Sensor

Receives the signal from the remote control (when using the wireless remote control). See [page 35](#).

7 Ambient light sensor

Detects the level of ambient light, allowing the monitor to make automatic adjustments to the backlight setting, resulting in a more comfortable viewing experience. Do not cover this sensor. See [page 69](#).

Terminal Panel

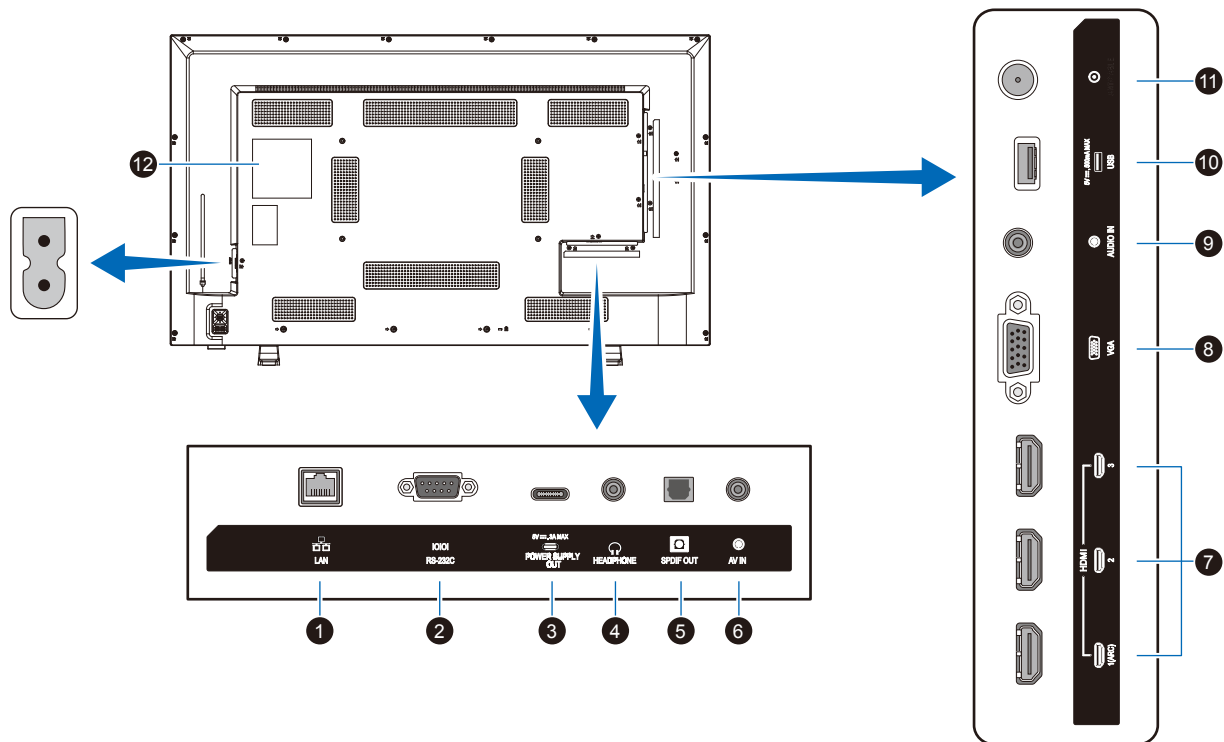

1 LAN port (RJ-45)

Use the HTTP server function and a Web browser on a computer to manage the LAN settings of the monitor.

NOTE: The LAN port of the monitor is not intended to be connected directly to a public network (including via routers rented by an Internet service provider). This is the reason why connecting the wired LAN port directly to a public network is forbidden according to the Telecommunications Business Act.

2 RS-232C input terminal (D-sub)

For connection to a computer. Receives control commands from the computer.

3 USB Type-C port (power supply 5 V/3 A)

Check the shape of the connectors when connecting a USB cable. When supplying power via the USB Type-C® port, use a USB cable supporting 3 A.

Do not tie the USB cable. Otherwise, it may cause overheating or fire.

4 HEADPHONE terminal (stereo mini jack)

Outputs the selected audio signal.

5 Digital audio output terminal

For connection to an audio device equipped with a digital audio input terminal.

6 AV input terminal

For connection to a video output terminal (composite) of a video player or other devices.

7 HDMI input terminals (HDMI1 (ARC)/HDMI2/HDMI3)

For connection to devices with digital video interface complying with the HDMI standard. HDMI1 terminal also supports ARC (Audio Return Channel) for audio output. Connect an HDMI cable supporting ARC to this terminal.

Connect audio devices supporting ARC to the HDMI1 (ARC) terminal.

NOTE: ARC sends the monitor's sound to the audio equipment from the HDMI1 ARC terminal. Use the included ARC-supported HDMI cable. The audio equipment supporting ARC, such as AV amplifiers, will output the monitor's audio. The volume and other functions of the audio equipment can be controlled with the included remote control.

8 VGA input terminal

For connection to the video output terminal (analog) of a computer.

When connecting the monitor to the video output terminal (component) of a video player or another device, go to [Setup] in the OSD menu -> [VGA Options] -> [VGA Mode], and select [YPbPr].

9 Audio input terminal (stereo mini jack)

For connection to the audio output terminal of a computer or another device.

10 USB Type-A port

Can be used to display photos (still images) and play video and music files stored in a USB storage device.

Check the shape of the connectors when connecting a USB storage device or USB cable.

NOTE: Check the USB flash drive for viruses as necessary.

11 ANT / CABLE

Connect to an RF antenna or Analog Cable system.

12 Label

Wireless Remote Control

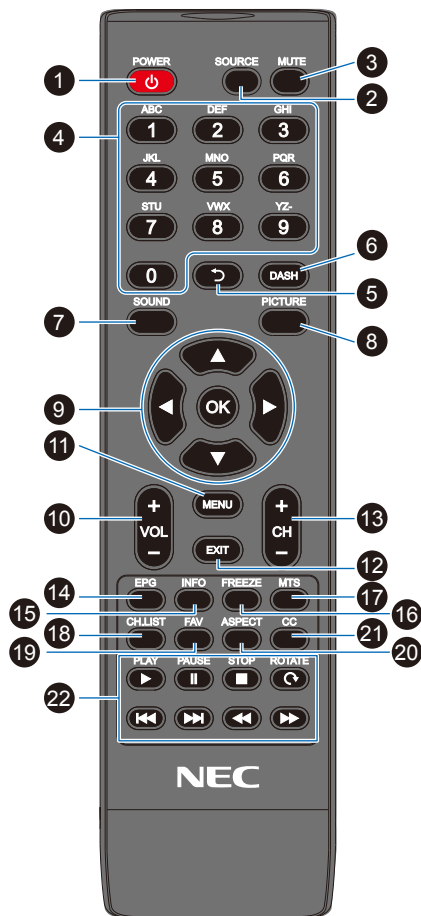

1 POWER Button

Switches between power on and off (standby).

NOTE: To completely turn the power off, disconnect the power plug from the outlet.

2 SOURCE Button

Cycles through the available inputs.

The input names are shown as their factory preset name.

3 MUTE Button

Silences the audio signal. Press the button again to restore the previous volume.

4 Keypad

Press the buttons to enter numerical values, such as the passwords.

5 Button

Return to previous channel.

6 DASH Button

Press to select different programs under the same channel.

7 SOUND Button

Selects the sound mode.

Available sound modes are [Standard], [Music], [Movie], and [Custom].

8 PICTURE Button

Selects the picture mode.

Available picture modes are [Dynamic], [Standard], [Energy Savings], [Conferencing], [HighBright], [Custom], and [HDR Video].

9 ▲, ▼, ◀, ▶, OK (cursor buttons)

Used to navigate inside and select the menus.

10 VOL- Button (volume minus button) VOL+ Button (volume plus button)

Increases or decreases the audio output level.

11 MENU Button

Opens and closes the OSD menu.

12 EXIT Button

Closes the OSD menu.

13 CH- Button CH+ Button

Press + or - to browse through the channels.

14 EPG Button

Show the program list in DTV source.

15 INFO Button

Shows/Hides the information OSD.

16 FREEZE Button (still image button)

Turns the still image function on/off.

17 MTS Button

Press to activate the NTSC tuner sounds such as Stereo, SAP, Monotone, and languages of the digital tuner.

18 CH.LIST Button

Press to display the Channel List.

19 FAV Button

Press to display the Favorite List.

20 ASPECT Button

Selects the aspect ratio of the image between [Normal], [1:1], [Full], and [Zoom].

21 CC Button

Press to activate the Closed Caption.

22 PLAY, PAUSE, STOP, ROTATE, ◀◀, ▶▶, ◀, ▶ (navigation buttons)

Used to operate the media player functions and the HDMI CEC function.

Chapter 3 Connections

This Chapter Includes:

- ⇒ "Wiring Diagram" on page 26
- ⇒ "Headphones Connection" on page 26
- ⇒ "Connecting to a Personal Computer" on page 27
- ⇒ "Connecting to a Media Device with HDMI" on page 28
- ⇒ "HDMI-CEC Command" on page 29
- ⇒ "Internal Video Sources" on page 30
- ⇒ "Media Player" on page 30
- ⇒ "Connecting a USB Device" on page 31

Connecting External Equipment

- NOTE:**
- Do not connect or disconnect cables when turning on the monitor's main power or other external equipment's power as this may result in loss of image.
 - Do not use an attenuating (built-in resistor) audio cable. Using an audio cable with a built-in resistor will lower the sound level.

Before making connections:

- Turn off the device's power before connecting it to the monitor.
- Refer to the device's user manual for available connection types and instructions for the device.
- We recommend turning off the monitor's main power before connecting or disconnecting a USB storage device to avoid data corruption.

Wiring Diagram

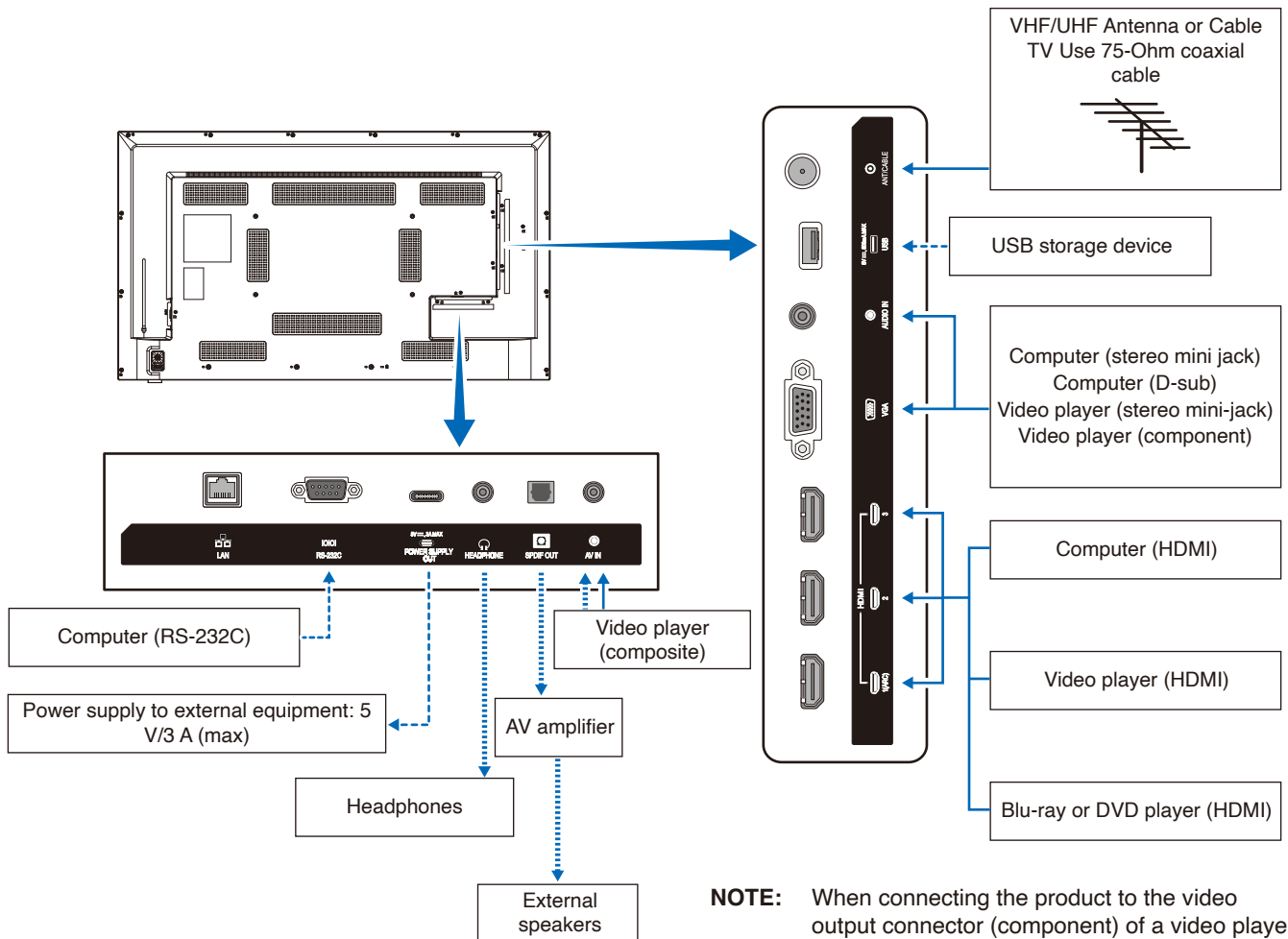

NOTE: When connecting the product to the video output connector (component) of a video player or another device, go to [Setup] in the OSD menu -> [VGA Options] -> [VGA Mode], and select [YPbPr].

Headphones Connection

When using headphones, connect them to the HEADPHONE terminal of the monitor.

CAUTION: Do not connect the headphones while wearing them. Otherwise, your ears may be injured depending on the sound volume.

- NOTE:**
- Headphones with a stereo mini jack plug can be connected to the monitor. If the plug of your headphones is too large to enter the connector, buy a 6.35 mm stereo jack plug to stereo mini jack plug adapter in your audio store.
 - The sound from the speakers is muted when headphones are connected.
 - Adjustment of the volume control as well as the equalizer to other settings than the center position may increase the ear-/headphones output voltage and therefore the sound pressure level.

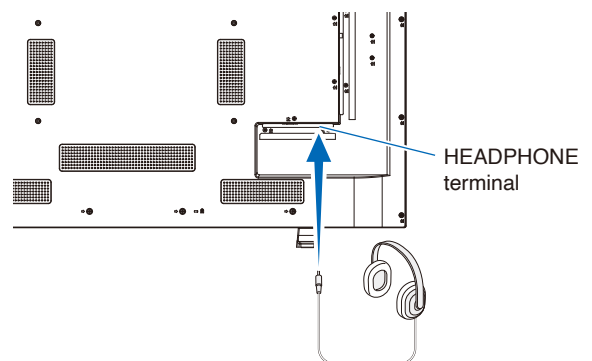

Connecting to a Personal Computer

Connecting to a Computer with HDMI

The monitor can be connected to and used with video players and computers equipped with an HDMI output. For more information, refer to the user's manual of the player or the other devices.

- Use an HDMI cable with the HDMI logo.
- It may take a moment for the signal to appear after turning on the device outputting the HDMI signal.
- Depending on the video card or driver used, the image may not be shown correctly.
- When you use a computer with HDMI, go to the OSD menu [Video] -> [Advanced Video] and set [Overscan] to [Auto] or [Off].
- If the monitor's main power is turned on after the connected computer has been turned on, the image may not be displayed. In this case, turn off the computer then turn it on again.
- If the source signal is 4K (50 Hz/60 Hz), HDCP 2.2 or HDR, go to the OSD menu [Setup] -> [HDMI Settings] -> [EDID] and set [Mode 2].
- When inputting a 4K signal, use a high-speed or premium high-speed HDMI cable.

Connecting to a Media Device with HDMI

The monitor can be connected using a single HDMI cable to Blu-ray players, streaming media players, or game consoles for the highest picture and audio quality. 4K UHD content is shown when the connected media player also supports 4K content.

Supports HDCP (High-bandwidth Digital Contents Protection) coding, a type of digital rights management that prevents high-definition content, in Blu-ray discs, DVDs and streaming media, from being copied or broadcast illegally.

- NOTE:**
- Connect the HDMI cable when both the media player and the monitor are powered off.
 - Use an HDMI cable with the HDMI logo.
 - Some HDMI cables and devices may not show the image correctly due to different HDMI specifications.
 - With the implementation of HDCP, there may be cases in which certain content is protected by HDCP and might not be displayed. This is not a malfunction.

Connecting to Audio Equipment with ARC Function

When audio equipment with the ARC function is connected to the HDMI1 (ARC) terminal of the monitor using the included ARC-supported HDMI cable, the speakers connected to the audio equipment outputs the monitor's sound.

- The sound output via HDMI1 (ARC) is not adjustable with the OSD menu.
- When the ARC function is activated, the monitor's internal speakers are muted.

HDMI-CEC (Consumer Electronics Control)

HDMI-CEC provides compatible video devices connected via HDMI with the ability to communicate and allows limited control between the device and the monitor. For example, turning on a Blu-ray player can immediately switch input to the Blu-ray player without using the remote control. Not all devices are fully compatible, and, in some cases, the media device manufacturer may only provide compatibility with its own monitors or TVs. See "HDMI-CEC Command" ([page 29](#)).

When supported, the monitor's remote control can be used to control the video device.

Enabling CEC

1. Connect an HDMI-CEC compatible device to the HDMI terminal.
Press the HDMI button on the remote control.
2. Press the MENU button to open the OSD menu.
3. In the OSD menu, go to [Setup] -> [HDMI Settings] -> and select [On] in [CEC].
4. In the OSD menu, go to [Setup] -> [HDMI Settings] -> [Device list] and press the OK button on the remote control.
When the device search is complete, connected devices are shown by their names.
5. In the OSD menu, select [Yes] under [Search device].
When the device search is complete, the HDMI terminals to which a device is connected are shown with the device name.

If no HDMI-CEC compatible device is found, make sure the device is connected, turned on, that it supports CEC, and that CEC is enabled. Depending on the manufacturer, the CEC feature may have a different name. Refer to the device's user manual.

6. Press the EXIT button on the remote control.

HDMI-CEC Command

Connect an HDMI-CEC compatible device to the HDMI terminal.

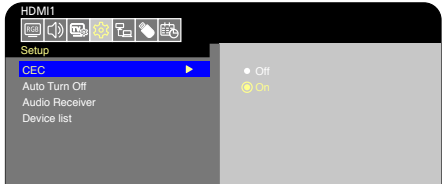
OSD menu	HDMI-CEC command name	Explanation	Setting
CEC (Consumer Electronics Control)	One Touch Play	When an HDMI-CEC compatible device is turned on, the monitor connected to the device with an HDMI cable also automatically turns on. After the monitor powers on, Input terminal automatically switches. If the monitor is already turned on when the HDMI-CEC compatible device is turned on, it only changes the Input terminal.	 <p>In the OSD menu, go to [Setup] -> [HDMI Settings] -> and select [On] in [CEC].</p>
	Remote Control Pass Through	The monitor's remote control button operation can function with HDMI-CEC compatible devices connected with an HDMI cable. For example, part of the HDMI-CEC compatible device menu can be operated using the remote control.	
	Power Status	The connected HDMI-CEC compatible devices can obtain the monitor's power status, such as if the monitor is in standby mode or on.	
	System Information	This function obtains information from a connected HDMI-CEC compatible device (CEC version, physical address, etc.).	
Auto Turn Off	System Standby	If the monitor is set to standby using the remote control, the HDMI-CEC compatible device connected with an HDMI cable also goes into standby at the same time. If the monitor goes into standby while an HDMI-CEC compatible device is recording, the device remains on. Refer to the user's manual supplied with the HDMI-CEC compatible device for further information.	In the OSD menu, go to [Setup] -> [HDMI Settings] -> [CEC] and select [Enable] in [Auto Turn Off].
Audio Receiver	System Audio Control	Connect audio equipment with the ARC function to the HDMI1 (ARC) terminal using the included ARC-supported HDMI cable. The Volume buttons on the remote control can control the volume of the connected HDMI ARC audio equipment. While this function is active, the monitor's internal speakers are automatically set to MUTE.	In the OSD menu, go to [Setup] -> [HDMI Settings] -> [CEC] and select [Enable] in [Audio Receiver].
Search device	Device OSD Name Transfer	This function is used to obtain the name of the connected devices.	In the OSD menu, go to [Setup] -> [HDMI Settings] -> [CEC] -> [Device list] and press the OK button on the remote control.
	Routing Control	By selecting a device name, the HDMI-CEC compatible device input switches to the input you selected. After selecting the device, the remote control operates for the selected device.	

NOTE: Depending on the connected device, sometimes the device does not work properly.

Internal Video Sources

Media Player

The internal Media Player will play audio and video files that are stored on a USB storage device. See page [page 40](#) for instructions on using the Media Player.

Compatible USB Storage Devices

If the USB storage device connected to the monitor is not recognized, check its format. The USB storage device used with the Media Player should be in the FAT32 or FAT16 format. For more information on how to format a storage device, see the manual or the help section of your Windows® computer.

Use a USB storage device of the correct size in accordance with the drawing below.

If the physical size of the USB storage device is larger than the supported size shown below, use a commercially-available USB extension cable.

Connect the USB storage device to the USB Type-A port of the monitor.

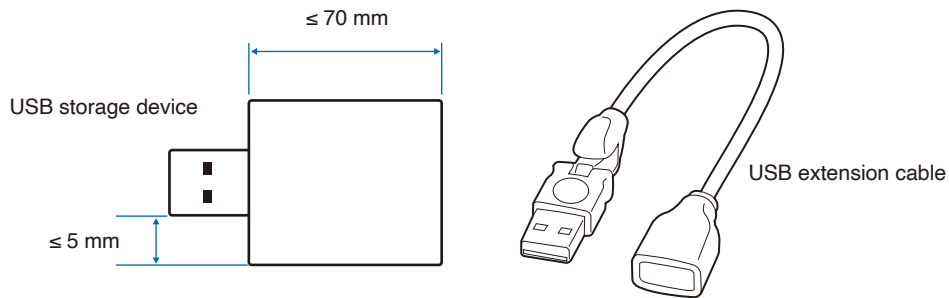

- NOTE:**
- The monitor is not guaranteed to work with all USB storage devices sold commercially.
 - Check that the USB storage device is connected to the USB Type-A port of the monitor.

Connecting a USB Device

Connect a USB storage device to the USB Type-A of the monitor as shown in the figure below to display images and videos using the Media Player function.

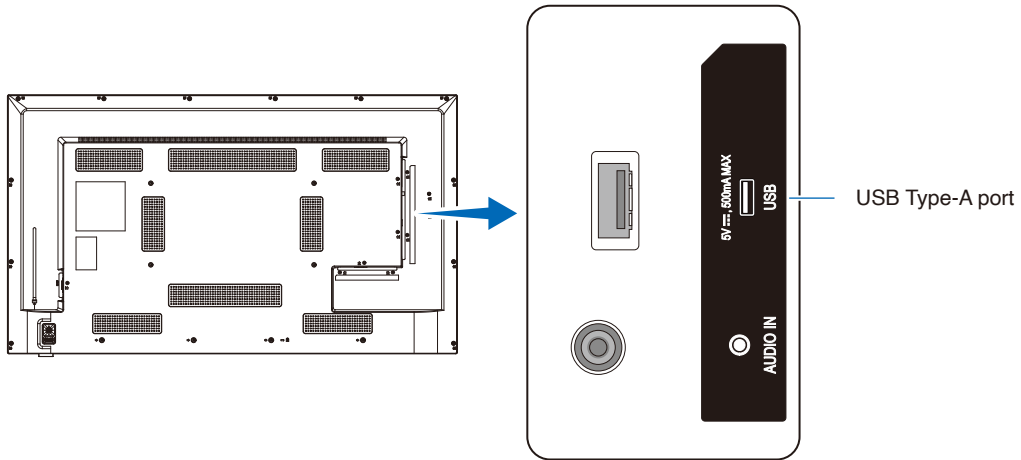

- NOTE:**
- Check the connector shape and orientation when connecting the USB device or cable.
 - Do not connect a USB storage device to the monitor when the monitor is turned on. To prevent damage to the monitor and possible corruption of the connected device's data files, the monitor's main power switch should be off before making connections.

Chapter 4 Basic Operation

This Chapter Includes:

- ⇒ "Power On and Off Modes" on page 33
- ⇒ "Operating Range for the Remote Control" on page 35
- ⇒ "Showing the Information OSD" on page 36
- ⇒ "Switching Between Sound Modes" on page 36
- ⇒ "Switching Between Picture Modes" on page 36
- ⇒ "Setting the Aspect Ratio" on page 37
- ⇒ "OSD (On-Screen Display) Controls" on page 38
- ⇒ "Using the Media Player Menu" on page 40

Power On and Off Modes

Power indicator status

The monitor operates as follows in On mode when no signal is input from an external device.

Mode	Normal operation (On mode)	Auto power save mode (energy-saving mode)	Auto standby mode (energy-saving mode)
Power indicator	Lit blue	Blinking red	Lit red

Energy Mode

The three following modes are available on the monitor.

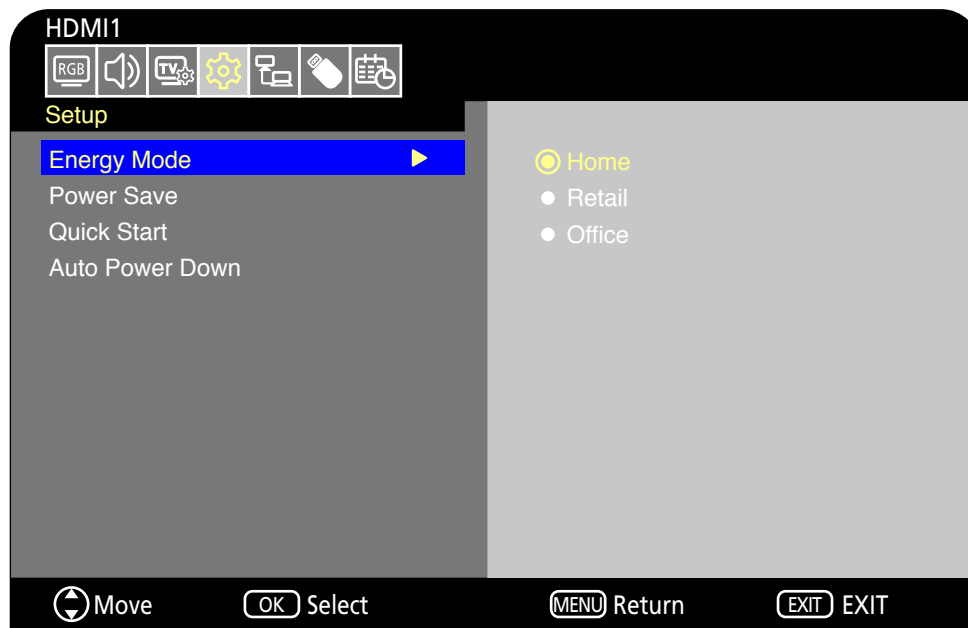

LAN and RS-232C can be selected for the monitor control. The way the energy modes operate varies depending on the selected control method.

When [RS-232C] is selected for control, [Power supply] and [Quick Start] are set to [Off]

Home/Office mode

- When no signal is input, “No signal” is displayed and the monitor enters the auto standby mode after a while.
- When a signal is input into the selected input terminal, the On mode is resumed.
When the AV terminal and VGA (YPbPr) terminal are selected, the On mode is not resumed even if a signal is input. In this case, enable the Quick Start function. (With this function enabled, the On mode is resumed.)

Retail mode

- The monitor does not enter the energy-saving mode when no signal is input. (The On mode is maintained.)

NOTE: During auto standby mode, if the power cord is disconnected and then plugged again, the monitor will be in the auto standby mode.

When [LAN] is selected for control, [Power supply] and [Quick Start] are set to [Off]

Home mode

- When no signal is input, “No signal” is displayed and the monitor enters the auto power save mode after a while.
- During auto power save mode, the monitor enters the auto standby mode if no LAN signal is received for 3 minutes. If a LAN signal is input during auto standby mode, the auto power save mode is not resumed. To maintain the auto power save mode, use the Office mode.
- When a signal is input into the selected input terminal, the On mode is resumed. When the AV terminal and VGA (YPbPr) terminal are selected, the On mode is not resumed even if a signal is input. In this case, enable the Quick Start function. (With this function enabled, the On mode is resumed.)

Retail mode

- The monitor does not enter the energy-saving mode when no signal is input. (The On mode is maintained.)

Office mode

- When no signal is input, “No signal” is displayed and the monitor enters the auto power save mode after a while. The auto power save mode is maintained regardless of LAN signal input.
- When a signal is input into the selected input terminal, the On mode is resumed. When the AV terminal and VGA (YPbPr) terminal are selected, the On mode is not resumed even if a signal is input. In this case, enable the Quick Start function. (With this function enabled, the On mode is resumed.)

NOTE: During auto power save mode and standby mode, if the power cord is disconnected and then plugged again, the On mode will not be resumed automatically when a signal is detected.

Operating Range for the Remote Control

Point the top on the remote control toward the monitor's remote control sensor during button operation.

Use the remote control within a distance of about 7 m (23 ft.) from the remote control sensor, or within a horizontal and vertical angle of 30° and within a distance of about 3.5 m (10 ft.).

NOTE: The remote control system may not function when direct sunlight or strong illumination strikes the remote control sensor, or near fluorescent lamps.

Handling the remote control

- Do not expose to strong shock.
- Do not allow water or other liquid to splash on the remote control. If the remote control gets wet, wipe it dry immediately.
- Avoid exposure to heat and steam.
- Ask your supplier or your municipality for information on how to dispose of the batteries.
- Do not open the remote control, except to install the batteries.

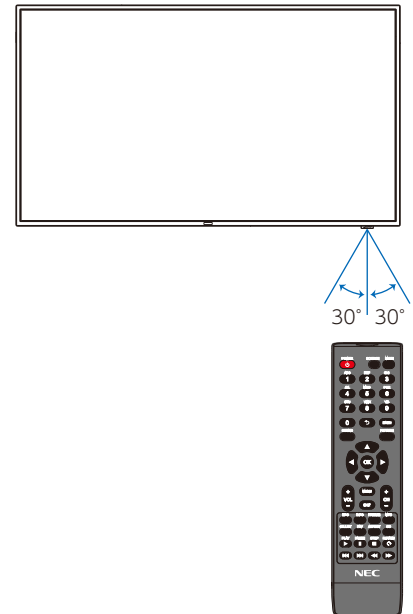

Showing the Information OSD

The Information OSD provides information such as the selected video input terminal, resolution, and IP address. Press the INFO button on the remote control to bring up the information OSD.

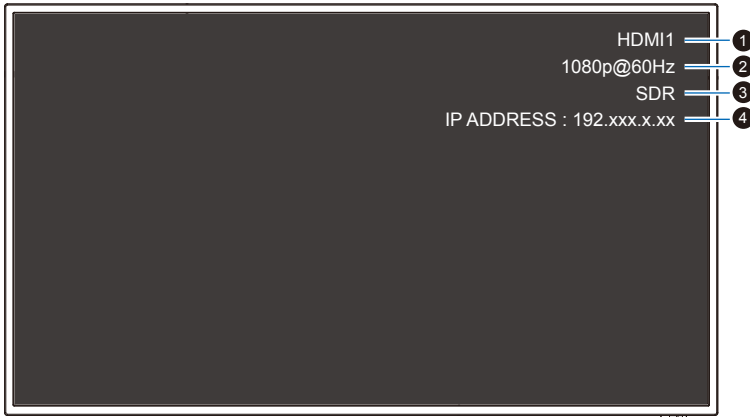

- ❶ Input name
- ❷ Resolution
- ❸ SDR / HDR information
- ❹ IP address*

* When [Information OSD] is set to [On]:
White: Connected to a LAN
Red: Not connected to a LAN

NOTE: When the input signal is [Media Player], the information OSD will not be displayed.

Switching Between Sound Modes

Press the SOUND button on the remote control to change the Sound Mode setting between Standard, Music, Movie, and Custom.

Switching Between Picture Modes

Press the PICTURE button on the remote control to change the Picture Mode setting between Dynamic, Standard, Energy Savings, Conferencing, HighBright, Custom, and HDR Video*.

* HDR Video can be selected only when an HDR signal is input.

Setting the Aspect Ratio

Press the ASPECT button on the remote control to change the Aspect Ratio setting between Normal, 1:1, Full, and Zoom.

NOTE: This setting cannot be changed when [Media Player] is selected for the input signal.

	Normal	1:1	Full	Zoom
Video signal	<p>The aspect ratio of the input signal is maintained and the image is enlarged/reduced.</p> <ul style="list-style-type: none"> Black bars are added vertically or horizontally. The screen is not cut, neither vertically nor horizontally. 	<p>The image is displayed with the number of panel pixels corresponding to the resolution of the input signal. When the input signal is larger than the number of the panel pixels, the aspect ratio is maintained and the image is reduced.</p>	<p>The aspect ratio of the input signal is ignored and the image is enlarged.</p> <ul style="list-style-type: none"> There are no black bars, neither vertically nor horizontally. The screen is not cut, neither vertically nor horizontally. 	<p>The aspect ratio of the input signal is maintained and the image is enlarged.</p> <ul style="list-style-type: none"> There are no black bars, neither vertically nor horizontally. Part of the image, vertically or horizontally, is not displayed.

NOTE: Note that changing the aspect ratio to compress or stretch an image and display it publicly or for commercial purposes in coffee shops, hotels, or other such places, may violate the rights of the copyright holder.

OSD (On-Screen Display) Controls

The monitor features an OSD (On-Screen Display) menu that allows the user to easily adjust the screen. By operating the menu displayed at the top of the screen, you will be able to adjust the brightness and the other screen settings.

OSD menu structure The OSD menu is composed of the following elements.

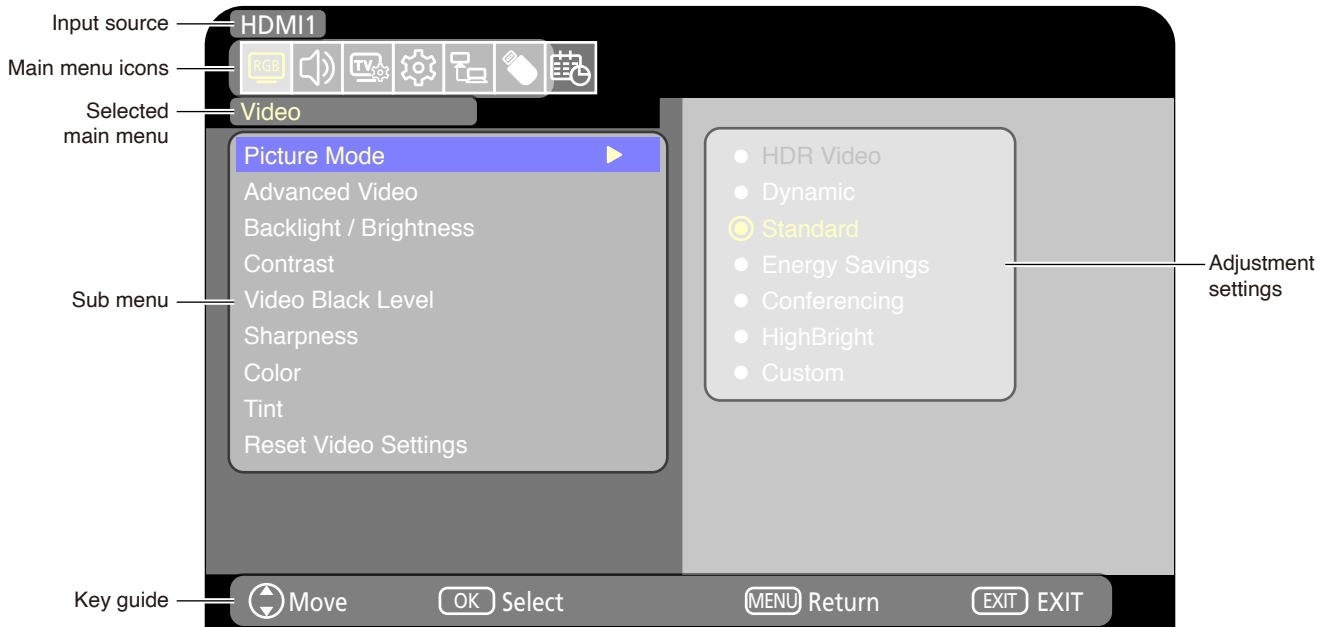

Press MENU to open and close the OSD menu. Press the EXIT button to close the OSD menu and stop OSD operations.

Press ▼ to navigate through the sub menus.

Press the OK button to select an item.

Press ▲, ▼, ◀, and ▶ to select an adjustment item and adjust the values.

Wireless Remote Control

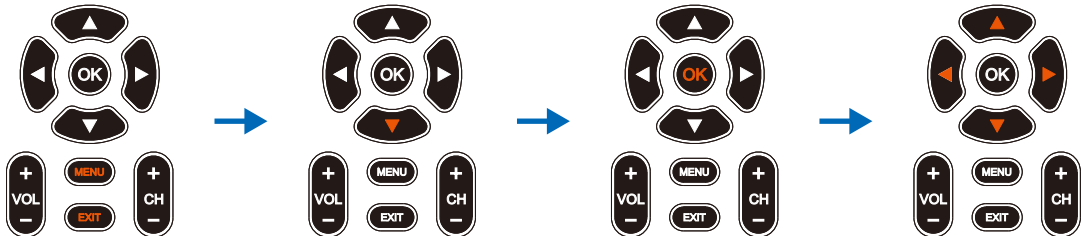

Monitor's control panel

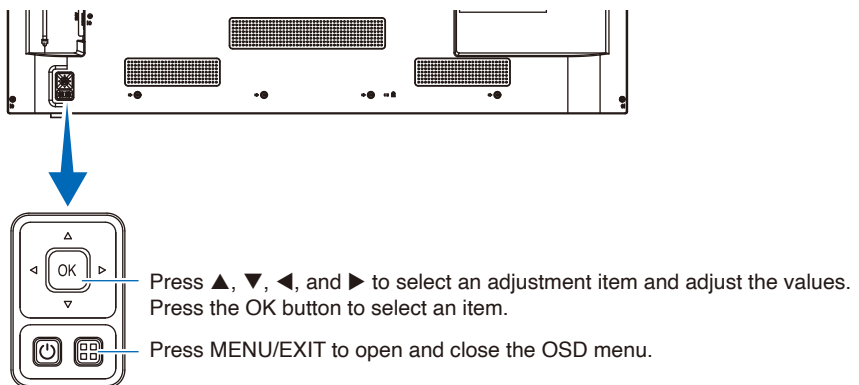

The function of each OSD menu element is briefly explained below. For more details on the content of the menu, see “OSD Controls List” ([page 67](#)).



Video settings: Select one of the default picture modes, manually adjust the color settings, adjust the aspect ratio, and adjust the other settings related to the image.



Audio settings: Adjust the volume, balance, equalizer, and the other settings related to the audio.



Channels settings: Configure the Channels and Time Zone settings.



Setup settings: Display the monitor information, select the language, or return the settings to their default values.



Control settings: Configure settings such as the network information.



Media Player settings: Configure the USB Demo Mode and other settings.



Schedule settings: Create auto power on/off schedules for the monitor and set the sleep timer.

Using the Media Player Menu

The Media Player plays image, video, and music files located on a USB storage device connected to the USB Type-A port of the monitor (page 23).

To open the Media Player menu, press the SOURCE button on the remote control and select [Media Player].

- NOTE:**
- Connect the USB storage device where the files are stored to the USB Type-A port of the monitor.
 - The Media Player does not auto-rotate content when changing the monitor's orientation from landscape to portrait and vice versa. Content must be created in the same orientation that matches the installed orientation of the monitor to display correctly.
 - The Media Player menu is always shown in the landscape orientation.

Media Player Menu

This function can be used to display photos (still images) and play video and music files stored in the USB storage device.

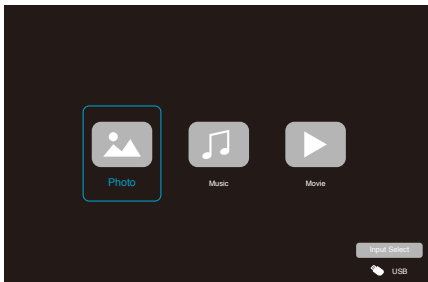

Select the type of the file you want to play between [Photo], [Music], and [Movie].

Selecting Files to Play

- Playing a file
Select a file using the ▲, ▼, ◀, and ▶ buttons on the remote control, and then press the ► button. Press the || button to pause the playback.
- Playing multiple files
 1. Select files using the ▲, ▼, ◀, and ▶ buttons on the remote control.
 2. Press the OK button on the remote control to add a checkmark next to each file.
 3. This saves the files as a playlist in the USB storage device.

- NOTE:**
- The selected files play in the order they are displayed in the folder.
 - File names must contain only alphanumeric characters.

Operation buttons

- Press the OK button on the remote control while playing a file to display the OSD operation menu on the screen.
- Press the ◀, ▶ buttons to highlight an item in the operation menu and then press the OK button to select it.
- Press the ▼ button on the remote control to close the operation menu.

Slideshow Operation

- Select files using the ▲, ▼, ◀, ▶ buttons and press the ► button to start a slideshow. Press the || button to pause the slideshow.
- To pause the slideshow using the OSD menu, select [Pause]. Select [Play] to resume the slideshow.
- Select [Previous] or press the ◀◀ button on the remote control to return to the previous image.
- Select [Next] or press the ▶▶ button on the remote control to go to the next image.
- Select [Stop] or press the ■ button on the remote control to stop the slideshow.

Repeat play

Repeat setting can be configured for file playback. The following modes can be selected.

[Repeat Off] - Repeat off

- No selected files.
 - All files in the folder are played once, in the sorted order.
- One or more selected files.
 - Any files you checked are played once, in the sorted order.



[Repeat One] - Repeat one file

- - A file is playing: the current file plays on a loop.
- - No file is playing: the highlighted file in the folder plays on a loop.
- One or more selected files.
 - The first checked file in the sorted order plays on a loop.







[Repeat All] - Repeat all files

- No selected files.
 - All files in the folder are played on a loop, in the sorted order.
- One or more selected files.
 - The selected files are played on a loop, in the sorted order.

Other functions

- Select  to view the playlist of files.
You can also select the files to play from the list.
- While a file is being played, select  to show information on the file being displayed.

Video and Music Operations

- Select files using the ▲, ▼, ◀, ▶ buttons on the remote control and press the ▶ button to start playback.
Press the || button to pause the playback.
- To pause the playback using the OSD menu, select .
Select  to resume the playback.
- Select  to start fast forward.
FF2X, FF4X, FF8X, FF16X, FF32X
(The sound is not output.)
(FF32X can be selected only when a video file is played.)
- Select  to start fast backward.
FB2X, FB4X, FB8X, FB16X, FB32X
(The sound is not output.)
(FB32X can be selected only when a video file is played.)
- Select  or press the ◀◀ button on the remote control to return to the previous file.
- Select  or press the ▶▶ button on the remote control to return to go to the next file.
- Select  or press the ■ button on the remote control to stop the playback.

Repeat play

Repeat setting can be configured for file playback. The following modes can be selected.

- Repeat off

- No selected files.
- All files in the folder are played once, in the sorted order.
- One or more selected files.
- Any files you checked are played once, in the sorted order.

- Repeat one file



- - A file is playing: the current file plays on a loop.
- No file is playing: the highlighted file in the folder plays on a loop.
- One or more selected files.
The first checked file in the sorted order plays on a loop.

- Repeat all files

- No selected files.
- All files in the folder are played on a loop, in the sorted order.

- One or more selected files.
- The selected files are played on a loop, in the sorted order.

Other functions

- Select  to view the playlist of files.
You can also select the files to play from the list.
- While a file is being played, select  to show information on the file being played.

NOTE: • Only use USB mass storage class devices.

- We cannot guarantee to support all commercially-available USB mass storage devices.
- Do not use a USB hub.
- Do not use a multi-partition USB storage device.
- The USB Type-A port of the monitor supports 5 V / 500 mA. When using a USB device of more than 500 mA, we recommend using the AC adapter supplied with the USB device.
- When connecting a USB device formatted as FAT16 or FAT32 to a computer, a message prompting you to scan and fix the USB device may appear. If that occurs, execute "Scan and fix".

Data Format for USB

Supported file system	FAT16 (max 2 GB), FAT32 (max 4 GB)		
Max folder level	9		
Max number of photos	997		
Photo mode			
File extension	Data format	Min resolution (H x V) of image	Max resolution (H x V) of image
JPEG, JPG, JPE	Baseline JPEG	75 x 75 pixels	15,360 x 8,640 pixels
Music mode			
File extension	Data format	Max bit rate	Max channel No.
MP3	MPEG1/2 Layer3 (MP3)	320 kbps	2 ch
Movie mode			
Container format	Supported video codec		Supported audio codec
MPG, MPEG	MPEG1, MPEG2, MPEG4		LPCM, MP3, AAC
TS	MPEG2, H.264, HEVC/H.265		LPCM, MP3, AAC
MP4	MPEG2, MPEG4, H.263, H.264, HEVC/H.265		LPCM, MP3, AAC
WMV	H.264, Windows Media Video 9		WMA 9, WMA 10 Pro
Video codec	Max bit rate of video* ²	Max resolution (H x V) of video	
MPEG1	40 Mbps	1920 x 1080 @30 Hz	
MPEG2	40 Mbps	1920 x 1080 @30 Hz	
MPEG4	40 Mbps	1920 x 1080 @30 Hz	
H.263	40 Mbps	1920 x 1080 @30 Hz	
H.264	135 Mbps	3840 x 2160 @60 Hz	
HEVC/H.265	100 Mbps	3840 x 2160 @60 Hz	
Windows Media Video 9 (WMV3)	40 Mbps	1920 x 1080 @30 Hz	
Audio codec	Max bit rate of audio* ²	Max channel No.	
LPCM	1.5 Mbps	5.1 ch* ¹	
MPEG1/2 Layer3 (MP3)	320 kbps	2 ch	
AAC	AAC-LC: 576 kbps HE-AAC v1: 288 kbps HE-AAC v2: 144 kbps	5.1 ch* ¹	
WMA 9 Standard	320 kbps	2 ch	
WMA 10 Pro M0	192 kbps	2 ch	
WMA 10 Pro M1	384 kbps	5.1 ch* ¹	
WMA 10 Pro M2	768 kbps	5.1 ch* ¹	

*1: It is played with down-converted to 2 ch.

*2: It may not play smoothly with a combination of max bit rate of video and audio.

NOTE: Sometimes, it may not be possible to play a video file even when the conditions above are met.
The file may not be played properly depending on the bit rate.
Video files made with a codec not supported by the monitor cannot be played.

Chapter 5 **Advanced Operation**

This Chapter Includes:

- ⇒ "Creating a Power Schedule" on page 44
- ⇒ "Using Picture Modes" on page 45
- ⇒ "Setting Security and Locking the Monitor Controls" on page 46
- ⇒ "Locking the Button Controls" on page 47

Creating a Power Schedule

The schedule function allows the monitor to automatically switch between power on and standby mode at different times.

To program the schedule: (Press the OK button on the remote control to switch between Enable (●) / Disable (●).)

1. Enter the [SCHEDULE] menu in the OSD menu.
 - a. Use the ▲/▼ buttons on the remote control to select [Current Time settings]. Press the OK button on the remote control.
 - b. Set date and time to the monitor:
Press the ◀/▶ buttons on the remote control to move between the fields.
 - c. Use the ▲/▼ buttons on the remote control to set the date and time.
2. After setting the time, press the MENU button on the remote control.
3. Use the ▲/▼ buttons on the remote control to select [Schedule settings].
 - a. Press the OK button on the remote control. Use the ◀/▶ buttons to navigate to the desired schedule number and press the OK button to enable (●) it.
 - b. Press the ▼ button on the remote control to navigate to the schedule setting field.
Press the ◀/▶ buttons to navigate through each setting field.
To return to the schedule number setting, press the MENU button.
 - c. Place the cursor on [Power On] and press the OK button on the remote control to enable (●) [Power On]. Press the ◀/▶ buttons on the remote control to move between the hours and minutes fields.
Use the ▲/▼ buttons on the remote control to set the time.
 - d. Use the ◀/▶ buttons on the remote control to place the cursor on [Power Off] and then press the OK button on the remote control to enable (●) [Power Off]. Press the ◀/▶ buttons on the remote control to move between the hours and minutes fields.
Use the ▲/▼ buttons on the remote control to set the time.
 - e. If a daily schedule is desired, choose [Every Day] using the ◀/▶ buttons and pressing the OK button to enable (●) it.
 - f. To set a schedule for a specific day, navigate the cursor to the desired day, [Mon - Sun], then press the OK button to enable (●) it. The schedule will run once on the selected day.
 - g. To repeat a schedule on the same day(s), place the cursor on [Every Week] and pressing the OK button to enable (●) it. The schedule will run every week on the selected day(s) [Mon - Sun].
4. After setting the schedule, press the MENU button on the remote control to return to the previous menu or press the EXIT button to close the OSD menu.

●: Enable ●: Disable

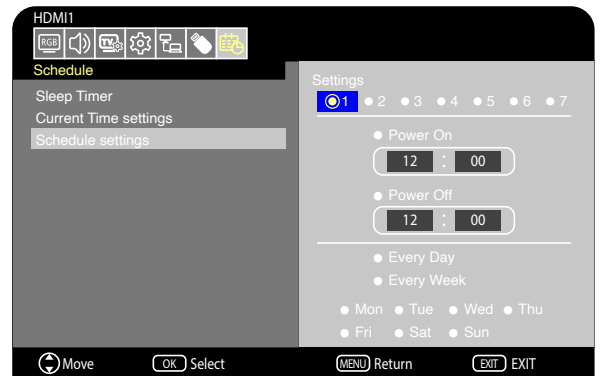
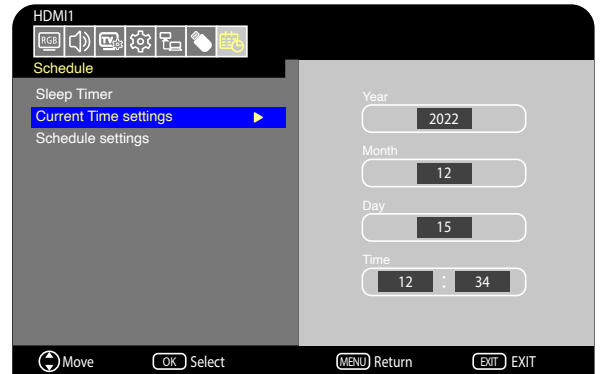

- NOTE:**
- The [Current Time Setting] needs to be set before adding schedules.
 - If multiple schedules are set, the monitor turns on or off according to the nearest time in the schedules.
 - If the time settings of [Power On] and [Power Off] are the same, power on is given priority.
 - When [Every Day] is selected, [Every Week] and [Mon - Sun] cannot be set.
 - If the monitor remains for about two weeks or more with the power cord unplugged, the clock will not show the correct time.
In this case, set the [Current Time settings] again.

Using Picture Modes

There are different picture modes available. They have been configured for different applications as described in the “Picture Mode Types” table below.

To change picture modes:

In the OSD menu, go the [Video] -> [Picture Mode], or press the PICTURE button on the remote control to select a mode.

HDR Video -> Dynamic -> Standard -> Energy Savings -> Conferencing -> HighBright -> Custom



Picture Mode Types

Picture Mode	Purpose
HDR Video	Setting for HDR format video (can be selected only when an HDR signal is input)
Dynamic	High-contrast video setting
Standard	Standard video setting
Energy Savings	Video settings suitable for energy saving.
Conferencing	Video setting suited for video conferences
HighBright	Video setting suited for brighter environments
Custom	Customizable settings

Setting Security and Locking the Monitor Controls

Under normal operation, the monitor can be controlled by any person using the remote control or the monitor control panel. You can prevent unauthorized use and changes to the monitor settings by enabling the security and lock settings.

The security and locking functions covered in this section are:

- Locking the monitor control panel buttons (See [page 21](#).)
- Locking the remote control buttons (See [page 24](#).)

Locking the Button Controls

The lock settings prevent the monitor from responding to button presses on the remote control or monitor control panel. When locking the button controls, some buttons can be configured to remain unlocked. Locking and unlocking the button controls do not require a password.

Locking the Control Panel Buttons

The [Key Lock Settings] prevent the monitor from being controlled using the buttons on the monitor control panel.

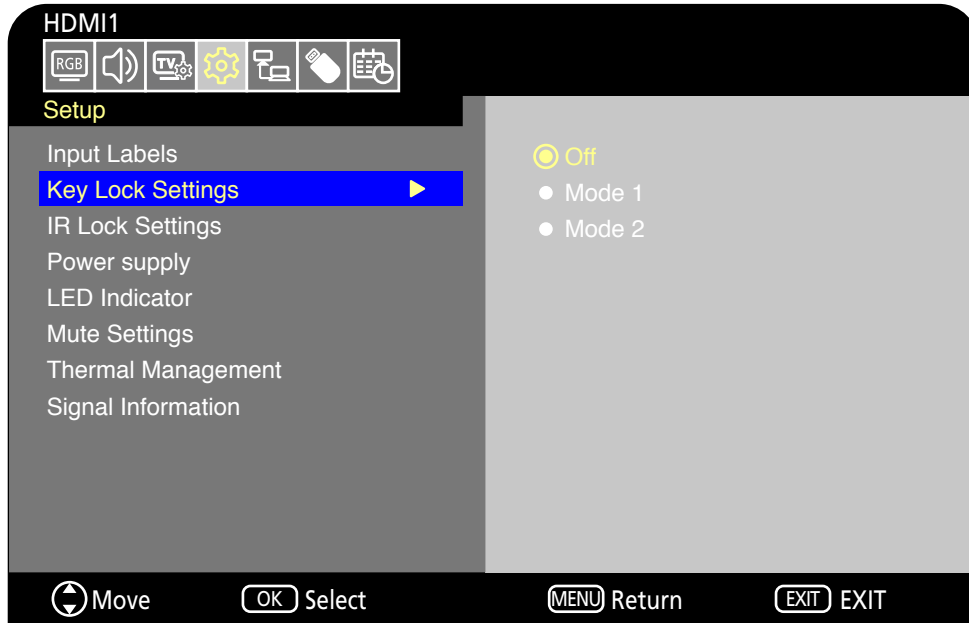

1. In the OSD menu, go to [Setup] -> [Other settings] and select [Key Lock Settings].
 2. Select the key lock range.
 - **Off:** All buttons operate normally.
 - **Mode1:** Only the power button and the input switching function operate.
 - **Mode2:** All buttons are locked. (Only the power button can be used during standby mode.)
- NOTE:** The buttons are locked 3 seconds after Mode1 or Mode2 has been selected.

Unlocking the Monitor Panel Button Controls

Carry out the following with the monitor in On mode.

- **OSD menu:** To remove the lock and restore normal button operation, set the [Key Lock Settings] to [Off] using the remote control.
- **Monitor buttons:** To remove the lock and restore normal button operation, hold the MENU button pressed for 5 seconds or more.

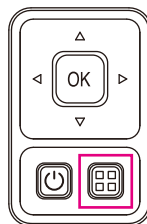

Locking the Remote Control Buttons

The [IR Lock Settings] prevent the monitor from being controlled using the remote control.



1. In the OSD menu, go to [Setup] -> [Other settings] and select [IR Lock Settings].
2. Select the key lock range.

- **Off:** All buttons operate normally.
- **Mode1:** Only the POWER and the SOURCE buttons operate.
- **Mode2:** All buttons are locked. (Only the power button can be used during standby mode.)

NOTE: The buttons are locked 3 seconds after Mode1 or Mode2 has been selected.



Unlocking the Remote Controls

Carry out the following with the monitor in On mode.

- **OSD menu:** To remove the lock and restore normal button operation, set the [IR Lock Settings] to [Off] using the monitor buttons.
- **Remote control:** To remove the lock and restore normal button operation, hold the EXIT button pressed for 5 seconds or more.



Chapter 6 External Control

This Chapter Includes:

- ⇒ "Controlling the Monitor via RS-232C" on page 50
- ⇒ "Controlling the Monitor via LAN" on page 51
- ⇒ "HTTP Browser" on page 52
- ⇒ "Commands" on page 55

Connecting an external device

There are two options to connect an external device to control the monitor.

- RS-232C Interface
Connecting an external device to the RS-232C terminal of the monitor.
- Network (LAN) Interface
Connecting a network to the LAN port of the monitor with a LAN cable.

Controlling the Monitor via RS-232C

This monitor can be controlled by connecting a personal computer with an RS-232C terminal to the RS-232C terminal of the monitor with a commercially-available RS-232C crossover cable. The following operations are possible.

- Turning the monitor on or putting it into standby.
- Switching between input signals.
- Switching between mute On and Off.

NOTE: Set [Control Interface] under [Control Settings] to [RS-232C] ([page 75](#)).

Connection

Monitor + computer.

- Turn off the monitor and the computer before connecting a computer to the monitor.
- First, turn the computer on, and then turn the monitor on.
- To control the monitor via commands sent from a computer connected with an RS-232C cable, use the control commands. Instructions for the control commands can be found in “Commands” in “External Control” in this manual or in “External_Control.pdf” (see “Appendix B External Resources” [page 66](#)).

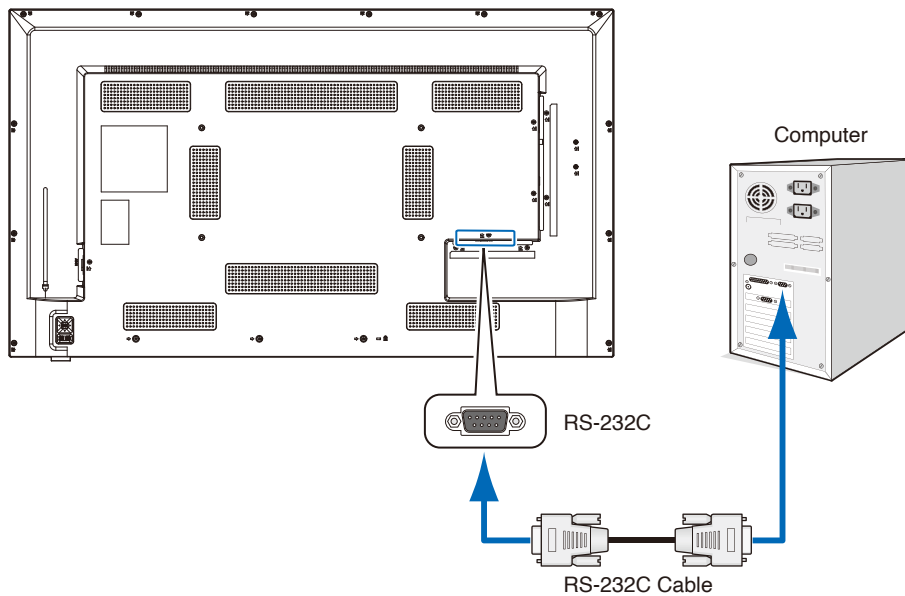

- NOTE:**
- If your computer is equipped only with a 25-pin serial port connector, a 25-pin serial port adapter is required.
 - Contact your supplier for details.
 - For the pin assignment, see “Pin Assignment RS-232C input/output”.

This monitor uses RXD, TXD and GND lines for RS-232C control.

A commercially-available crossover cable (not included) should be used for RS-232C control.

Pin Assignment

RS-232C input / output

Pin No.	Name
1	NC
2	RXD
3	TXD
4	NC
5	GND
6	NC
7	NC
8	NC
9	NC

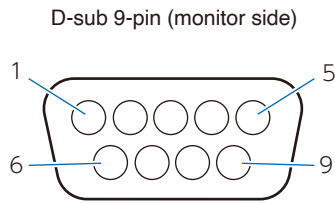

This monitor uses RXD, TXD and GND lines for RS-232C control.

Controlling the Monitor via LAN

The monitor is equipped with a LAN port (RJ-45). Connecting the monitor to a network allows you to receive email notifications from the monitor and control the monitor from a computer via a network. To use a LAN connection, you are required to assign an IP address to the monitor ([page 75](#)).

The monitor will obtain an IP address automatically when connected to a DHCP network.

NOTE: Set [Control Interface] under [Control Settings] to [LAN] ([page 75](#)).

Example of LAN connection

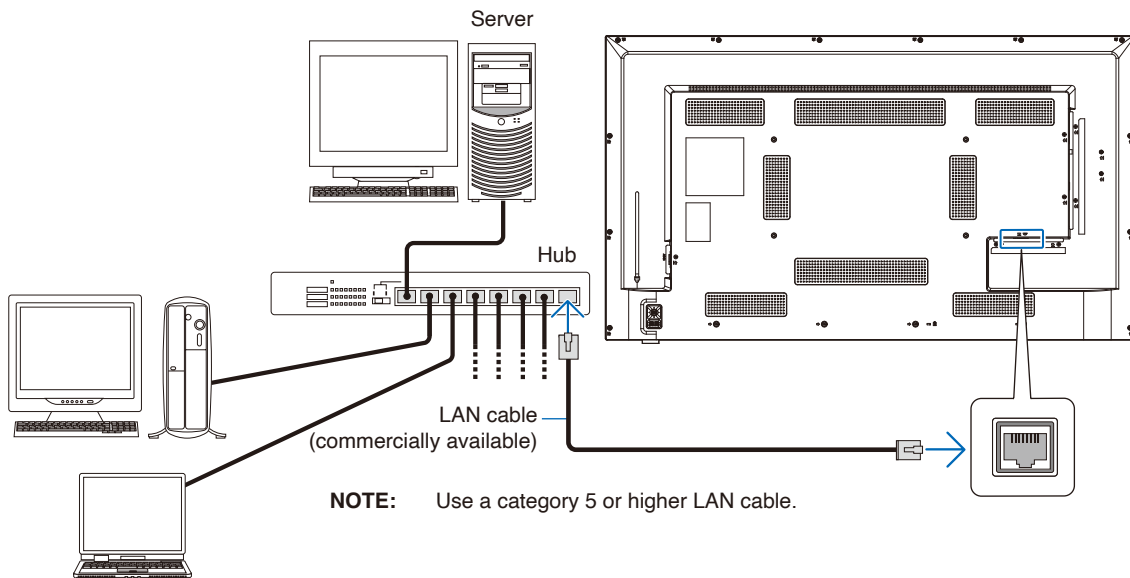

HTTP Browser

Overview

Connect the monitor with a commercially-available LAN cable to configure the LAN settings using the HTTP server function.

This monitor uses “JavaScript” and “Cookies” and the browser should be set to accept these functions. Refer to the help files for the Web browser to change the settings to use JavaScript and Cookies.

To access the HTTP server, launch a web browser on a computer connected to the same network as the monitor and enter the following URL in the Web address field.

Network Settings

http://<Address IP of the monitor>

- NOTE:**
- The control software can be downloaded from our website.
 - By default, the IP address of the monitor is set automatically. After a reset, the IP address is obtained automatically.
 - Depending on the network environment, the display speed and response to commands or clicks on buttons may be slow, or the operations may not be recognized. In such a case, consult your network administrator. The monitor may not respond if the buttons shown on the browser are repeatedly pressed in rapid intervals. In such a case, wait a moment and try again. If you still can't get a response, turn the monitor off and then back on.
 - If the monitor Network Settings screen does not appear in the Web browser, press the Ctrl+F5 keys to refresh your Web browser.
 - To control the monitor via a LAN, see “External_Control.pdf” in our Website (see “Appendix B External Resources” [page 66](#)). If the screen does not appear, clear the cache of the Web browser.

Preparation Before Use

Connect the monitor to the network using a commercially-available LAN cable before attempting to use browser operations.

Operation with a browser that uses a proxy server may not be possible depending on the type of proxy server and the setting method. Although the type of the proxy server will be a factor, it is possible that items that have been set will not be shown depending on the effectiveness of the cache, and the settings configured from the browser may not be reflected in operation. It is recommended that a proxy server is not used unless the network environment requires it.

Screen Adjustment Using a Browser

Access the following address to show HOME. Click the links on the left-hand column on the HOME screen to access the setting screens.

http://<Address IP of the monitor>

OSD Menu Settings in the Monitor Web Controls

The functions related to the network can be configured the same way as in the OSD menu using the links below.

INPUT SOURCE: HDMI1
Top

STATUS

OVERVIEW

PROTOCOL

TCP

Crestron CONTROL SYSTEM

AMX

NAME

Crestron Fusion On-Premises

Crestron Fusion in the Cloud

Crestron XiO Cloud

Crestron AUTO DISCOVERY

NETWORK

SYSTEM

LOGOUT

STATUS	
SYSTEM	
NAME	EXX8
SERIAL	XX4XXXXXX
FIRMWARE VERSION	Vx.x.x / Vx.x.x
LOCAL TIME	WWW MMM DD XX:XX:XX 20YY
UPTIME	XXh XXm XXs
NETWORK	
IP ADDRESS	192.168.0.10
SUBNET MASK	255.255.255.0
DEFAULT GATEWAY	0.0.0.0
DNS PRIMARY	0.0.0.0
DNS SECONDARY	0.0.0.0
MAC ADDRESS	XX:XX:XX:XX:XX:XX

Network Settings

Click on “NETWORK” on the left-hand column on the HOME screen to enter the setting screen.

INPUT SOURCE: HDMI1 Top

STATUS	NETWORK SETTINGS		
PROTOCOL	INTERFACE		
TCP	DHCP	Off	
Crestron CONTROL SYSTEM	IP ADDRESS	192.168.0.10	
AMX	SUBNET MASK	255.255.255.0	
NAME	DEFAULT GATEWAY	0.0.0.0	
Crestron Fusion On-Premises	DNS PRIMARY	0.0.0.0	
Crestron Fusion in the Cloud	DNS SECONDARY	0.0.0.0	
Crestron XiO Cloud	SAVE		
Crestron AUTO DISCOVERY			
NETWORK			
SYSTEM			
LOGOUT			

DHCP	<p>Select a method for setting the IP ADDRESS.</p> <p>Off: Sets fixed network settings.</p> <p>On: Obtains the network settings from the DHCP server on the network.</p> <p>Manual DNS: Obtains the network settings from the DHCP server on the network but the DNS is set manually.</p> <p>NOTE: Consult your network administrator if you have any trouble with the connection.</p>
IP ADDRESS	Set the IP address for the monitor connected to the network when [Off] is selected for [DHCP].
SUBNET MASK	Set the subnet mask for the network to which the monitor is connected when [Off] is selected for [DHCP].
DEFAULT GATEWAY	Set the default gateway for the network to which the monitor is connected when [Off] is selected for [DHCP]. Enter [0.0.0.0] to delete the setting.
DNS PRIMARY	Enter the IP address of the primary DNS server of the network connected to the monitor. NOTE: Enter [0.0.0.0] to delete the setting.
DNS SECONDARY	Enter the IP address of the secondary DNS server of the network connected to the monitor. NOTE: Enter [0.0.0.0] to delete the setting.

Crestron CONTROL SYSTEM Settings

Click on “Crestron CONTROL SYSTEM” on the left column below HOME.

For more information on this function, see “Appendix-E” ([page 81](#)).

AMX Settings

Click on “AMX” on the left-hand column on the HOME screen to enter the setting screen.

AMX BEACON	When the monitor is connected to a network supporting the NetLinX control system by AMX, enables or disables the function to send a beacon to the system from AMX Device Discovery.
------------	---

NOTE: When using a device that supports AMX Device Discovery, all AMX NetLinX control systems will recognize the device and download the appropriate Device Discovery Module from an AMX server.

Commands

Connecting the monitor to a computer via RS-232C or to a network via LAN allows for the transmission of commands to the monitor, providing remote control of the monitor from a connected device. Instructions for each command format can be found in “External_Control.pdf” in our Website (see “Appendix B External Resources” [page 66](#)).

RS-232C Interface

Item	Details
PROTOCOL	RS-232C
BAUD RATE	9600 [bps]
DATA LENGTH	8 [bits]
PARITY	NONE
STOP BIT	1 [bit]
FLOW CONTROL	NONE

Network (LAN) Interface

Item	Details
PROTOCOL	TCP
PORT NUMBER	7142
COMMUNICATION SPEED	AUTO setting (10/100 Mbps)

Chapter 7 Troubleshooting

This Chapter Includes:

- ⇒ "When a problem occurs with the monitor..." on page 57
- ⇒ "Nothing is displayed..." on page 57
- ⇒ "The image is not displayed correctly..." on page 58
- ⇒ "An instruction or caution screen is displayed..." on page 59
- ⇒ "Others (when connected to a computer)" on page 59
- ⇒ "Others (remote control, speakers)" on page 59
- ⇒ "Others (when connected via RS-232C or LAN)" on page 60
- ⇒ "When using a media player" on page 60
- ⇒ "When using a video device" on page 60

When a problem occurs with the monitor...

In such a case, refer to the following.

Nothing is displayed...

Symptom	Condition	Cause and solution	Reference
Nothing is displayed on the screen.	The power indicator is off In the OSD menu, [Setup] -> [Other Settings] -> [LED Indicator] is set to [On]	Check that the power cord is properly connected.	P.12
		Use another device to check that power is correctly supplied to the outlet.	
	The power indicator is lit blue	A terminal with no signal input may be selected. Press the input switch button to select a different input terminal.	P.21
		Open the OSD menu and check the following settings.	P.38
		<ul style="list-style-type: none"> If the OSD menu does not open, the monitor may be malfunctioning. Contact your supplier. 	
		<ul style="list-style-type: none"> If the OSD menu opens properly, the monitor is not malfunctioning. Adjust [Backlight / Brightness] and [Contrast] in the [Video] settings. 	P.69
	The power indicator is lit a color other than blue or it is flashing.	<ul style="list-style-type: none"> If the image is not displayed after adjusting [Backlight / Brightness] and [Contrast] in the OSD menu, check that the connected device operates correctly. If the monitor is connected to a computer, check the frequency, resolution, and type of output signal on the computer. 	P.27
		The monitor automatically goes into standby at the preset time period after the video signal is lost. Press the power on button on the remote control or press the  button on the monitor.	P.24, P.33
		Check that the signal cable is correctly connected to the input and output terminals of the monitor and the connected device.	P.26
		Check that the power adaptor is properly connected.	P.27
	Check that the connected computer or video device is turned on.		
The image on the screen disappeared.	The screen, on which the image was correctly displayed, turned black, started to blink, or did not display anything.*	The LCD panel needs to be replaced. Contact your supplier.	



* The lifespan of the backlight used in the monitor may end.

Check for HDCP (High-bandwidth Digital Content Protection) content. HDCP is a system for preventing illegal copying of video data sent over a digital signal. If you are unable to view material via the digital inputs, this does not necessarily mean that the monitor is not functioning properly. With the implementation of HDCP, there may be cases in which certain content is protected by HDCP and might not be shown due to the decision/intention of the HDCP community (Digital Content Protection, LLC).

The image is not displayed correctly...

Symptom	Cause and solution	Reference
Black dots (dots not lit) or bright dots (dots always lit) appear on the screen.	This is due to the characteristics of LCD panels and is not a malfunction.	
The brightness of the image is not even.	This may happen depending on the content displayed. This is due to the characteristics of LCD panels and is not a malfunction.	
The shadow of thin vertical lines appears on the screen.	This may happen depending on the content displayed. This is due to the characteristics of LCD panels and is not a malfunction.	
Moiré appears when detailed patterns are displayed.	This may happen when detailed patterns are displayed. This is due to the characteristics of LCD panels and is not a malfunction.	
The colors do not look correct depending on the viewing angle.	The tint may greatly vary depending on the viewing angle (the angle from which the screen is viewed).	
The display condition of the screen is changing gradually.	The display condition changes gradually while the monitor is being used. The ambient temperature may also have an impact on the display condition. This is due to the characteristics of LCD panels and is not a malfunction.	P.13
After changing the screen, the image of the previous screen remains slightly.	When the same still image is displayed for a long time, this phenomenon of persisting image may occur. You may press the POWER button on the remote control or the  of the monitor to put the monitor on standby, or display changing images for about one day until the persisting image disappears naturally. If the still image is displayed for a really long time, the persisting image may not disappear. This is not a malfunction. It is recommended to turn the monitor off when not using it.	
The colors are not displayed correctly.	Open the OSD menu and check the following settings.	P.38
	<ul style="list-style-type: none"> • If the OSD menu does not open properly, the monitor may be malfunctioning. Contact your supplier. 	P.69 , P.69
	<ul style="list-style-type: none"> • If the OSD menu opens properly, the monitor is not malfunctioning. Select [Color] and adjust the colors as needed, or execute [Reset Video Settings] under the [Video] settings to return the settings to their default values. 	P.69 , P.69
The image is not displayed correctly (problems not mentioned above) or the video is interrupted momentarily.	<ul style="list-style-type: none"> • If the OSD menu opens properly and the computer screen does not appear correctly after executing [Reset Video Settings] under [Video], check the connection to the computer as well as the frequency, resolution and output signal type setting on the computer. 	P.26 , P.62
	Open the OSD menu and check the following settings.	P.38
	<ul style="list-style-type: none"> • If the OSD menu does not open properly, the monitor may malfunction. Contact your supplier. • If the video is interrupted when an HDMI signal with the 3840 x 2160 or 4096 x 2160 resolution is input, use an HDMI cable supporting 4K. 	
The power turns off automatically.	Check the setting in [Setup] -> [Power save settings] -> [Auto Power Down]. Set the [CEC] setting under [Setup] -> [HDMI Settings] to [Off]. Check the setting in [Schedule] -> [Sleep Timer].	P.72 , P.77
The monitor does not operate according to the schedule function.	Check the setting in [Schedule] -> [Current Time settings]. Enable [Power On] under [Schedule] -> [Schedule settings]. Enable [Power Off] under [Schedule] -> [Schedule settings].	P.77
The display is disturbed.	The display may be disturbed when power is turned on or when the settings have been changed. This is not a malfunction.	

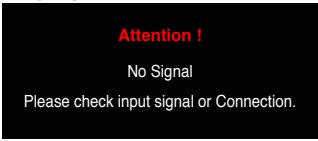
An instruction or caution screen is displayed...

Symptom	Cause	Solution	Reference
A caution message is displayed on the screen.*1 	The signal cable may not be connected properly to the input or output terminals of the monitor or the computer.	Check that the signal cable is securely connected between the input terminal of the monitor and the output terminal of the connected device.	P.26
	The HDMI input may have switched.	Set the [CEC] setting under [Setup] -> [HDMI Settings] to [Off].	P.73
	The signal cable may be damaged.	Check that the signal cable is not damaged.	
	The computer may be turned off.	Check that the computer is turned on.	
	The power management function of the computer may be functioning.	Move the mouse or press a key on the keyboard.	
	An improper signal may be input to the monitor.	Change the frequency of the input signal or the resolution of the computer.	P.62
	A signal with a resolution higher than the resolution supported by the monitor may be input.	Change the frequency of the input signal or the resolution of the computer.	P.62
A temperature warning is displayed on the screen. 	The ambient temperature exceeds the operation guaranteed temperature.	Turn off the power of the monitor since this problem may cause a malfunction.	P.74

*1 Depending on the computer, a proper signal may not be output immediately after changing the resolution or the frequency and the caution may be displayed for a while. In such a case, wait for a while. If the screen display returns to normal, it means the input signal is correct.

Others (when connected to a computer)

Symptom	Cause	Solution
Cannot change the resolution or the number of colors / The resolution or the number of colors is fixed.	Sometimes, the signal cannot be input and output.	Restart the monitor and the computer.
	The video card driver may not be correctly recognized by the OS.	Reinstall the video card driver. For more information on the reinstallation procedure, refer to the computer manual or the support service for the computer.

Others (remote control, speakers)

Symptom	Cause and solution	Reference
The remote control is not functioning.	<ul style="list-style-type: none"> The batteries may be drained. Check that the batteries are inserted correctly (check the + and - sides). The [IR Lock Settings] may be set to [Mode 1] or [Mode 2]. 	P.11, P.74
The video is displayed but there is no sound.	<ul style="list-style-type: none"> Check that the audio cable is correctly connected. Check also that the audio balance is not fully set to one side only. If the balance is set to one side only, set it to the center. The sound may be muted. Press the MUTE button on the remote control or the main unit and check that the sound is output. The volume may be set to the minimum. Adjust the volume using the + and - buttons on the main unit or the VOL + and - buttons on the remote control. 	P.22, P.24, P.70

Others (when connected via RS-232C or LAN)

Symptom	Cause and solution	Reference
Control via RS-232C is not available.	Check that the RS-232C crossover cable is correctly connected.	P.50
Control via LAN is not available.	Check that the LAN cable (Cat.5 or higher) is correctly connected.	P.51
	Check that the Network Settings are correctly configured.	P.51

When using a media player

Symptom	Cause and solution	Reference
The media player function does not recognize the USB storage device.	Check that a USB storage device is correctly connected to the USB port.	P.30

When using a video device

Symptom	Cause and solution	Reference
There is no image and no sound.	Check that the external device (video player, etc.) is correctly connected and operates properly. For more information, see the manual of the external device.	P.26
	The power management function of the monitor may be functioning. Check that the external device is operating (playing).	
There is no color or the colors are abnormal.	Adjust the [Color] setting.	P.69

Chapter 8 Specifications

This Chapter Includes:

- ⇒ "Compatible Signal List" on page 62
- ⇒ "E328-2" on page 64

Compatible Signal List

Resolution	Refresh rate (Hz)	Component	HDMI video
640 x 480p	60	•	•
720 x 480i	60	•	•
720 x 480p	60	•	•
720 x 576i	50	•	•
720 x 576p	50	•	•
1280 x 720p	50	•	•
1280 x 720p	60	•	•
1920 x 1080i	50	•	•
	60		
1920 x 1080p	24	•	•
	25		
	30		
	50		
	60		
3840 x 2160p	24	—	—
	25	—	—
	30	—	—
	50	—	—
	60	—	—
4096 x 2160p	24	—	—
	25	—	—
	30	—	—
	50	—	—
	60	—	—

Resolution	Refresh rate (Hz)	VGA	HDMI PC
720 x 400	70	•	•
640 x 480	60	•	•
800 x 600	56	•	•
	60	•	•
1024 x 768	60	•	•
1280 x 720	60	•	•
1280 x 800	60	•	•
1280 x 960	60	•	•
1280 x 1024	60	•	•
	75	•	•
1400 x 1050	60 (RB*)	•	•
1440 x 900	60	•	•
1600 x 1200	60	•	•
1680 x 1050	60	•	•
1920 x 1080	60	•	•
3840 x 2160	30	—	—
	60	—	—
1366 x 768	60	—	•
1920 x 1440	60	—	—
2560 x 1600	60	—	—

* RB: Reduced blanking signal

- NOTE:**
- Depending on the input signal's resolution, characters may look blurred or figures may be distorted.
 - Depending on the video card or driver used, the image may not be shown correctly.

E328-2

Size (display size)		32"/801.3 mm diagonal		
Type of LCD		Active Matrix Color TFT LCD		
Viewable Size		698.40 x 392.85 mm		
Resolution		1920 x 1080		
Pixel Pitch		0.364 mm		
Color		Approx. 16.77 million colors (depends on the video card)		
Brightness*5		400 cd/m ² (Max.)		
Frequency	Horizontal	31 - 83 kHz (analog input) 15.625/15.734 kHz, 31 - 136 kHz (digital input)		
	Vertical	56 Hz, 60 Hz, 70 Hz, 75 Hz (analog input) 24 Hz, 30 Hz, 50 Hz, 60 Hz, 70 Hz, 75 Hz (digital input)		
Pixel Clock		13.5 MHz, 25 MHz - 156 MHz (analog input) 25 MHz - 600 MHz (digital input)		
Input Terminals	TV	RF terminal	ATSC, NTSC	VHF/UHF Antenna or Cable TV Service
	VGA (RGB)*2	15 Pin D-sub	Analog RGB signal	0.7 Vp-p/75 Ω
	VGA (YPbPr)*2	15 Pin D-sub	Component signal	Luma Y: 1.0 Vp-p/75 Ω, Color Cb/Cr (Pb/Pr): 0.7 Vp-p/75 Ω
	Video	3.5φ Mini Jack	Composite signal	1.0 Vp-p/75 Ω
	HDMI	HDMI terminal	Digital YUV Digital RGB	HDCP 1.4/2.2
Audio Terminals	Audio input	Stereo Mini Jack 3.5 mm Ø	Analog audio signal	Stereo L/R 0.5 Vrms
		HDMI terminal	Digital audio signal	PCM 2 ch 32, 44.1, 48 kHz (16/20/24 bits)
	Audio output	Stereo Mini Jack 3.5 mm Ø	Analog audio signal	For headphones output
		S/PDIF terminal	Digital audio signal	For digital audio output
		HDMI (ARC) terminal*3	Digital audio signal	PCM 2 ch 32, 44.1, 48 kHz (16/20/24 bits)
Speaker Output		Internal Speakers 5 W + 5 W (Stereo)		
Control Terminals	RS-232C	9 Pin D-sub x1		
	LAN	RJ-45 10BASE-T / 100BASE-TX		
USB Terminal	USB Type-A port	For media player, DC 5 V / 500 mA (max)		
	USB Type-C port	For power supply, DC 5 V / 3 A (max)		
Operational Environment	Temperature	0 - 40 °C / 32 - 104 °F		
	Humidity	20 - 80 % (without condensation)		
	Altitude	3000 m or less (Brightness may decrease with altitude)		
Storage Environment	Temperature	-20 - 60 °C / -4 - 140 °F		
	Humidity	10 - 80 % (without condensation)		
Power Supply	Power input	AC 120 - 127 V 50/60Hz		
	Input current	0.8 A		
	Consumption	Full operation	80 W	
		During power save	2.0 W or less*1	
		During standby	0.5 W or less*1	
Weight	With the stand	Approx. 5.9 kg (13 lbs)		
	Without the stand	Approx. 5.7 kg (12.5 lbs)		
Inclination Angle		±10°		

Dimensions*4

*1 When used with the default settings.

*2 Common terminal.

*3 HDMI1 only.

*4 Measurements are of the monitor only and do not include removable parts that protrude.

*5 The Brightness level changes depending on the input settings, picture settings, installation environment, and individual product characteristics.

The overall Brightness decreases as the product ages due to deterioration over time. It does not maintain a permanent brightness level throughout the product's life.

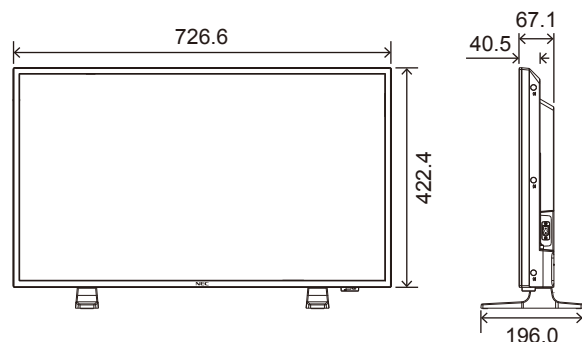

Technical specifications are subject to change without notice.

Unit: mm

Appendix A Trademark and Software License

Microsoft® and Windows® are either registered trademarks or trademarks of Microsoft Corporation in the United States and/or other countries.

The terms HDMI, HDMI High-Definition Multimedia Interface, HDMI Trade dress and the HDMI Logos are trademarks or registered trademarks of HDMI Licensing Administrator, Inc.

Manufactured under license from Dolby Laboratories.

Dolby, Dolby Audio, and the double-D symbol are trademarks of Dolby Laboratories Licensing Corporation.

Crestron™, the Crestron logo, Crestron Connected™, Crestron Fusion™, and XiO Cloud™ are either trademarks or registered trademarks of Crestron Electronics, Inc. in the United States and/or other countries.

Blu-ray is a trademark of Blu-ray Disc Association.

USB Type-C® and USB-C® are registered trademarks of USB Implementers Forum.

All other brands and product names are trademarks or registered trademarks of their respective owners.



[Notice] About the MPEG-4 AVC, MPEG-4 Visual license included in this product

1. MPEG AVC

THIS PRODUCT IS LICENSED UNDER THE AVC PATENT PORTFOLIO LICENSE FOR THE PERSONAL USE OF A CONSUMER OR OTHER USES IN WHICH IT DOES NOT RECEIVE REMUNERATION TO (i) ENCODE VIDEO IN COMPLIANCE WITH THE AVC STANDARD ("AVC VIDEO") AND/OR (ii) DECODE AVC VIDEO THAT WAS ENCODED BY A CONSUMER ENGAGED IN A PERSONAL ACTIVITY AND/OR WAS OBTAINED FROM A VIDEO PROVIDER LICENSED TO PROVIDE AVC VIDEO. NO LICENSE IS GRANTED OR SHALL BE IMPLIED FOR ANY OTHER USE. ADDITIONAL INFORMATION MAY BE OBTAINED FROM MPEG LA, L.L.C. SEE [HTTP://WWW.MPEGLA.COM](http://www.mpegla.com)

2. MPEG-4 Visual

THIS PRODUCT IS LICENSED UNDER THE MPEG-4 VISUAL PATENT PORTFOLIO LICENSE FOR THE PERSONAL AND NON-COMMERCIAL USE OF A CONSUMER FOR (i) ENCODING VIDEO IN COMPLIANCE WITH THE MPEG-4 VISUAL STANDARD ("MPEG-4 VIDEO") AND/OR (ii) DECODING MPEG-4 VIDEO THAT WAS ENCODED BY A CONSUMER ENGAGED IN A PERSONAL AND NONCOMMERCIAL ACTIVITY AND/OR WAS OBTAINED FROM A VIDEO PROVIDER LICENSED BY MPEG LA TO PROVIDE MPEG-4 VIDEO. NO LICENSE IS GRANTED OR SHALL BE IMPLIED FOR ANY OTHER USE. ADDITIONAL INFORMATION INCLUDING THAT RELATING TO PROMOTIONAL, INTERNAL AND COMMERCIAL USES AND LICENSING MAY BE OBTAINED FROM MPEG LA, LLC. SEE [HTTP://WWW.MPEGLA.COM](http://www.mpegla.com).

Appendix B External Resources

Additional specification documents and accessories, and optional software applications referenced in this product manual are listed below.

Regional websites

Global: <https://www.sharp-nec-displays.com/global/>

Asia-Pacific: <https://www.sharp-nec-displays.com/ap/contact/index.html>

North America: <https://www.sharpnecdisplays.us/>

Europe, Russia, Middle East and Africa: <https://www.sharpnecdisplays.eu/p/hq/en/home.xhtml>

Japan: <https://www.sharp-nec-displays.com/jp/>

Additional Documentation

External Control” PDF document

This document defines the communications protocol for externally controlling and querying the monitor via either RS-232C or LAN. The protocol uses encoded binary and requires calculation of checksums, and most functionality in the monitor can be controlled using these commands.

This document is available for download from our website in your region.

Software

Software is available for download on our website.

https://www.sharp-nec-displays.com/dl/en/dp_soft/lineup.html

NaViSet Administrator software



This free software is an advanced and powerful network-based control, monitoring and asset management system for NEC monitors and projectors. The software is available for Microsoft Windows and macOS.

The latest version of the NaViSet Administrator software is available on our website.

Appendix C OSD Controls List

This Chapter Includes:

- ⇒ "Video Settings" on page 68
- ⇒ "Audio Settings" on page 70
- ⇒ "Channels" on page 71
- ⇒ "Setup" on page 72
- ⇒ "Control Settings" on page 75
- ⇒ "Media Player" on page 76
- ⇒ "Schedule" on page 77

Default values can be provided on request.

Video Settings

Video	
Picture Mode	Provides pre-configured video settings suitable for various environments where this device may be used, or customize settings to your preference.
HDR Video	Video setting for the HDR format. (Can be selected only when an HDR signal is input.)
Dynamic	High-contrast video setting.
Standard	Standard setting.
Energy Savings	Video settings suitable for energy saving.
Conferencing	Video setting suited for video conferences.
HighBright	Maximum backlight brightness with higher color temperature for brighter ambient environments.
Custom	Customizable settings.
Advanced Video	Menu used to adjust detailed video settings.
Aspect Ratio	Select the aspect ratio of the screen image. For more information, see “Setting the Aspect Ratio” in this manual. NOTE: <ul style="list-style-type: none"> • [Zoom] cannot be used when a 4K signal is input • [Zoom] cannot be used when an FHD signal is input.
Normal	Maximizes the size without changing the aspect ratio.
1:1	Shows the image in a 1 by 1 pixel format. (If the input resolution is higher than the recommended resolution, the image will be scaled down to fit the screen).
Full	Fills the entire screen even if the aspect ratio needs to be changed.
Zoom	Fills the entire screen without changing the aspect ratio. NOTE: The areas of the image that are outside of the active screen area are not shown.
Overscan	Selects the image display area.
Auto	The image display area is set automatically.
On	Approximately 95 % of the image will be shown on the screen.
Off	The whole image is displayed within the screen area. This setting may cause noise at the edges of the screen depending on the signal. NOTE: When you use a computer with an HDMI output, set it to [OFF].
Dimming Setting	The brightness of the backlight is optimized, while the contrast can be increased and the power consumption reduced.
Off	The backlight is not controlled.
Dynamic Backlight	Automatically adjusts the brightness level of the entire screen according to the input signal.
Local Dimming	Automatically adjusts each of the clusters of the LCD backlight independently according to the input signal.

Video	
Color Temperature	Adjusts the color temperature of the entire screen. A low color temperature will result in a reddish screen. A high color temperature will make the screen bluish. If a temperature needs further adjustment, the individual R/G/B/ levels of the white point can be adjusted.
Cool	High color temperature setting. The screen will be bluish.
Normal	Intermediate setting.
Warm	Low color temperature setting. The screen will be reddish.
Native	Turns the color temperature adjustment off and displays the image with the panel characteristics.
Custom	Customizable settings.
Noise Reduction* ¹ , * ²	Reduces the image noise.
Adaptive Contrast* ¹ , * ²	Automatically adjusts the contrast according to the image. If [High] is set, the image is shown clearly but the brightness variation may appear unnatural.
Gamma	Adjusts the brightness of gray and other intermediate colors. (SDR)
Native	Gamma correction is handled by the LCD panel.
2.2	Typical monitor gamma for use with a computer.
2.4	Typical gamma settings for use with video devices, such as DVDs and Blu-rays.
Ambient Light Sensing	Automatically adjusts the brightness of the screen depending on ambient light within the room. When set to [On], the brightness of the screen is adjusted automatically according to the room brightness. NOTE: When set to [ON], [Backlight / Brightness] cannot be changed.
Color Enhance* ¹ , * ²	Changes the colors of the image and the saturation to create a more colorful image.
HDR Mode* ²	When the monitor detects an HDR signal, you can select preferred gamma correction from [Low], [Mid] and [High].
Backlight / Brightness	Adjusts the brightness of the image using the backlight. Press the ◀ and ▶ the buttons to adjust the brightness. In general, use this function to adjust the brightness. NOTE: When [On] is selected in [Ambient Light Sensing], this function cannot be changed.
Contrast	Adjusts the image brightness in relationship to the input signal. Press ◀ or ▶ button to adjust.
Video Black Level	Adjusts the black luminance.
Sharpness* ¹ , * ²	Adjusts the crispness of the image. Press ◀ or ▶ button to adjust. NOTE: The lines may appear as double lines depending on the setting. In such a case, lower the sharpness setting.
Color* ¹	Adjusts the color density of the screen. Press the ▶ button to increase the density, or the ◀ button to decrease it.
Tint* ¹	Adjusts the color tint of the monitor screen between R0-R50 and G0-G50.
Reset Video Settings	Returns all settings in the Video menu to their default values.

*1: Such as DVI signals through DVI/HDMI conversion cable, those signals with no InfoFrame information and analog RGB signals are not supported.

*2: RGB signals are not supported.

Audio Settings

Audio	
Sound Mode	Set pre-configured audio settings suitable for various environments where the monitor may be used, or customize settings to your preference.
Standard	Standard sound setting.
Music	Optimized settings for music playback or audio in conference rooms.
Movie	Surround sound for clarity in retail stores and other signage applications.
Custom	Customizable settings.
Balance	Press the ► button to move the audio signal to the right. Press the ◀ button to move the audio signal to the left.
Surround	Artificially produces surround sound audio.
Internal Speakers	Configures the settings for the internal speakers output.
Auto	The sound is not output from the speakers when a cable is connected to the HEADPHONE terminal.
Off	Sound is not output from the speakers.
On	Sound is always output from the speakers.
Digital Output	Select the optical digital audio format of the S/PDIF terminal. RAW: Outputs in the RAW format. PCM: Outputs in the PCM format.
Audio Input	Selects whether to use the audio signal of the Audio In terminal when the audio signal is not included in the HDMI signal (DVI signals, etc.). HDMI: The HDMI terminal is used. Audio in: The Audio in terminal is used.
Audio Delay	Adjusts the delay time until the audio is output.
Audio Source (MTS)	Select audio sources in analog channels.
Visually Impaired	Select to turn On/Off support methods for visual impaired. (Only available for digital channels)
Menu Speech (TTS)	Enable speech function for OSD menu and certain operations.
Audio Language	Select language options in digital channels. (Only available for digital TV programs)
Reset Audio Settings	Returns all settings in the Audio menu to their default values.

Channels

Channels	
Auto Channel Scan	Automatically search the available channels.
Add / Skip Channels	Manually add or skip channels to the channel list.
Favorite Channels	Add channels to your favorite channel list.
Channel Labels	Create labels to any channel.
Time Zone	Select the time zone area where your TV is installed. For NAFTA TV models only.

Setup

Setup	
OSD Settings	
Language	Select the language used in the OSD.
Transparency	Set the transparency level of the OSD menu between 30%, 50%, 70% and Off. The higher the percentage, the more transparent the OSD menu is.
Information OSD	Displays or hides the Information OSD. Information OSD contains the messages that are displayed on the screen when the input is switched or when the state of the input signal changes.
Parental Controls	
	Set TV parental controls. This function blocks out the picture and sound of the selected rating levels. The factory preset password to enter Parental Controls feature is a 4-digit number 0000.
Block Unrated TV	Block or unblock the unrated programs.
US	Set the parental control level using [Movie Ratings] memu or [US TV ratings lock] memu.
Canadian	Set the parental control level using [Canadian English] memu or [Canadian French] memu.
Change Password	Change the 4-digit password. You will have to enter the new password first, then enter again the new password to confirm. Make sure to keep your new password.
RRT5	Use Region 5 to block various types of movies and television programs based on ratings systems used in the USA that you feel may be inappropriate due to its content. The Region 5 option will operate for Digital Channels (ATSC) only.
Reset RRT5	Clear the downloaded RRT5 rating information and restore to the factory default settings.
Closed Caption	
	Adjust the Closed Caption settings. Caption Display / Analog Captions / Digital Captions / Digital CC Settings
Power save settings	
Energy Mode	Select a mode between Home, Retail, and Office. For more information, see "Energy Mode" page 33 .
Power Save*	Sets the time until the monitor enters the Power Save mode. When the set time has elapsed after the input signal has been lost, the Power Save function is activated.
Quick Start	When [On] is selected, the monitor will quickly return to the [On] state when a signal is detected. Enabling this option increases standby power consumption.
Auto Power Down*	When turned [On], the monitor turns off automatically after 4 hours without any operation.
Auto Input Change	
	This function automatically selects the input terminal with an input signal. When enabled, this option can detect and change inputs when a signal is applied or lost. Press the INFO button on the remote control to display the selected input terminal on the Information OSD.
None	The monitor does not search for video signal on the other input connections.
First	The monitor does not search for a video signal on the other input connections while the current input has a video signal. If the current input connection does not have video signal present, the monitor will search for video signal on the other video input connections. If a video signal is found, the monitor will switch from the current input to the input with the active video source automatically.
Custom	The input terminals included in the search performed by the monitor can be selected.

Setup	
HDMI Settings	
CEC	This function makes it possible to control a device supporting HDMI CEC connected to the HDMI terminal. When set to On, HDMI CEC is enabled.
EDID	Sets the HDMI mode. Mode 0: Max resolution is 1920 x 1080 (60 Hz). Mode 1: Max resolution is 3840 x 2160 (30 Hz). Mode 2: Max resolution is 3840 x 2160 (60 Hz), HDCP 2.2, or HDR.
Video Range	Adjust the gradation range to be shown according to the video signal to improve the whiteout and blackout of the image.
HPD Delay	This function makes it possible to control the time until the video from the HDMI terminal is displayed. When set to Off, the time until the video is output can be reduced but the video may not be output depending on the device. In such a case, set [HPD Delay] to On.
VGA Options	
This option is only enabled when a VGA signal is input.	
VGA Mode	Select [RGB] or [YPbPr] depending on the signal received into the VGA input terminal.
Auto Adjust	Automatically adjusts settings such as the image position.
H.Position	Adjusts the horizontal position of the screen. Press the ► button to move the screen to the right or the ◀ button to move it to the left.
V.Position	Adjusts the vertical position of the screen. Press the ► button to move the screen to the top or the ◀ button to move it to the bottom.
Clock	Adjust this setting when vertical lines appear on the screen or when the size differs at the right and left of the screen.
Phase	Adjust this setting when noise appears in the horizontal direction, when the characters are blurred, or when the contours are not sharp.
H.Resolution	The video can be enlarged/reduced in the horizontal direction using this function only when [Standard] is selected in [Aspect Ratio]. NOTE: This function may not operate depending on the input signal.
V.Resolution	The video can be enlarged/reduced in the vertical direction using this function only when [Standard] is selected in [Aspect Ratio]. NOTE: This function may not operate depending on the input signal.
Reset VGA Options	Resets the VGA Options settings to their default values.

Setup	
Other settings	
Input Labels	Renames the input terminal currently being displayed. Letters (A-Z), numbers (0-9), and some symbols can be used.
Key Lock Settings	Prevents the monitor from being controlled using the buttons on the monitor control panel. Off: All buttons operate normally. Mode 1: Only the power button and the input switching function operate. Mode 2: All buttons are locked. (Only the power button can be used during standby mode.)
IR Lock Settings	Prevents the monitor from being controlled using the remote control. Off: All buttons operate normally. Mode 1: Only the POWER and the SOURCE buttons operate. Mode 2: All buttons are locked. (Only the power button can be used during standby mode.)
Power supply	You can configure the power supply to the USB Type-C port. The power consumption increases when set to [On].
LED Indicator	Set it to Off to turn off the power indicator when the monitor is turned on (normally lit blue).
Mute Settings	Allows you to mute the monitor's audio and video output. Audio: Mutes the audio output when the remote control's MUTE button is pressed. Video: Mutes the video output when the remote control's MUTE button is pressed. Audio & Video: Mutes the audio and video output when the remote control's MUTE button is pressed.
Image Rotation	When [On] is selected, rotates the image 180 degree.
Thermal Management	The monitor is equipped with thermal sensors and displays a warning when the ambient temperature exceeds the operation guaranteed temperature. If a warning is displayed, turn the monitor off since using the monitor in such environment may cause a malfunction. Warning Message: A temperature warning is displayed on the screen when the internal temperature has exceeded the operation guaranteed temperature. Shutdown: The monitor turns off automatically when the internal temperature has exceeded the operation guaranteed temperature.
Signal Information	Displays the information regarding the input signal.
Monitor Information	Displays the information regarding the monitor.
Factory Reset	All settings except network are returned to factory default.

*: A countdown message appears before entering power save mode or power off.

Control Settings

Control Settings	
Control Interface	NOTE: Only one method, LAN or RS-232, can be used at a time.
LAN	Sets network (LAN) control.
RS-232C	Sets RS-232C control.
Network Settings	Configures the network settings of the monitor.
DHCP	On: Obtains the network settings from the DHCP server on the network. Off: Sets fixed networks settings. Manual DNS: Obtain the network settings from the DHCP server on the network but the DNS is set manually.
IP ADDRESS	Set the IP address of the monitor when [DHCP] is set to [Off].
SUBNET MASK	Set the subnet mask data for the monitor connected to the network when [Off] is selected for [DHCP].
DEFAULT GATEWAY	Set the default gateway for the monitor connected to the network when [Off] is selected for [DHCP].
DNS PRIMARY	Enter the IP address of the primary DNS server of the network connected to the monitor. NOTE: Enter [0.0.0.0] to delete the setting.
DNS SECONDARY	Enter the IP address of the secondary DNS server of the network connected to the monitor. NOTE: Enter [0.0.0.0] to delete the setting.
MAC ADDRESS	Shows the monitor's MAC ADDRESS. This cannot be changed.
SAVE	Saves the settings.
Monitor ID	Sets an ID number for control. The monitor ID number can be set between 1 and 100.
Reset Network Settings	Returns the network settings to their default values.

Media Player

Media Player	
USB Demo Mode	<p>Photos (still pictures), music and video files saved in the “NDS_DEMO” folder in the USB storage device can be played automatically. You can select the types of files to play in the USB Demo Mode.</p> <p>NOTE: Enabling USB Demo Mode To enable the USB Demo Mode, [Energy Mode] in the [Setup] menu must be set to [Retail].</p> <p>NOTE: Starting USB Demo Mode The playback of the files starts automatically under the following conditions.</p> <ul style="list-style-type: none"> • The USB Demo Mode has been enabled. • A folder named “NDS_DEMO” exists in the USB storage device. • No signal is being input in a terminal other than the USB port. • There was no user operation for 10 seconds or more. <p>NOTE: Memo</p> <ul style="list-style-type: none"> • The POWER, VOLUME, and MUTE buttons on the remote control operate normally. If other buttons are pressed, the playback stops and the input returns to the terminal used previously. • The playback is also stopped is the USB storage device is removed. • If the monitor is turned off during playback in USB Demo Mode, the next time the monitor is turned on, playback will start automatically if the USB storage device is still connected.
UnPlug USB Device	Select [Execute] before removing the USB device.
Caution Window	Sets whether to display a caution window (On) or not (Off) when a file with a format or a codec not supported by the monitor is played.

Schedule

Schedule	
Sleep Timer*	Sets the time until the monitor turns off automatically. Off, 10 minutes, 15 minutes, 30 minutes, 60 minutes, 90 minutes, 120 minutes, 180 minutes, 240 minutes can be selected.
Current Time settings	Sets the current date and time. NOTE: If the monitor remains for about two weeks or more with the power cord unplugged, the clock will not show the correct time. In this case, set the [Current Time settings] again.
Year	Sets the current year. Press the ▲ or ▼ button on the remote control to cycle to the current year. Press the OK button to apply the change.
Month	Sets the current month. Press the ▲ or ▼ button on the remote control to cycle to the current month. Press the OK button to apply the change.
Day	Sets the current day of the month. Press the ▲ or ▼ button on the remote control to cycle to the current day. Press the OK button to apply the change.
Time	Sets the current time. Select the hour field, then press the ▲ or ▼ button on the remote control to cycle to the current hour, then repeat this for the minutes field. Press the OK button to apply the change. NOTE: The monitor's clock is a 24-hour format.
Schedule settings*	Creates a working schedule for the monitor (see page 44). Press the ▲, ▼, ◀, ▶ buttons to navigate and change the schedule settings. Press the OK button on the remote control to select settings.
Settings	Select the number and press the OK button to activate the schedule. The circle next to the number has an outline when the schedule is enabled. Up to 7 schedules can be created and enabled. Press the ◀ or ▶ button to cycle through schedule numbers.
Power On Power Off	Sets the monitor's power state for the schedule. Select [Power On] if you want the schedule to turn the monitor on at the specified time. Select [Power Off] if you want the schedule to turn the monitor off at the specified time. Set the time for the schedule.
Every Day	Select this option to have the schedule repeat every day. NOTE: When [Every Day] is selected, [Every Week] and [Mon - Sun] cannot be set.
Every Week	Enable or disables the option to have the schedule repeat every week. Enable ● - Repeat the schedule every week on the same day(s) of the week that you select from [Mon - Sun]. Disable ● - Execute the schedule one time on the specific day(s) you select from [Mon - Sun].
Mon - Sun	Select this option if the schedule is only going to run on one day or it is an irregular schedule.

*: A countdown message appears before entering power save mode or power off.

Appendix D **Manufacturer's Recycling and Energy Information**

This Chapter Includes:

- ⇒ "Disposing of your old NEC product" on page 79
- ⇒ "Energy Saving" on page 79
- ⇒ "About Conversion Cables Used with the AV Terminal" on page 80

We are strongly committed to environmental protection and sees recycling as one of the company's top priorities in trying to minimize the burden placed on the environment. We are engaged in developing environmentally friendly products, and always strive to help define and comply with the latest independent standards from agencies such as ISO (International Organization for Standardization) and TCO (Swedish Trades Union).

Disposing of your old NEC product

The aim of recycling is to gain an environmental benefit by means of re-use, upgrading, reconditioning or reclamation of material. Dedicated recycling sites ensure that environmentally harmful components are properly handled and securely disposed. To ensure the best recycling of our products, we offer a variety of recycling procedures and gives advice on how to handle the product in an environmentally sensitive way, once it has reached the end of its life.

All required information concerning the disposal of the product and country-specific information on recycling facilities can be found on our following websites:

<https://www.sharpnecdisplays.eu/p/greenvision/en/greenvision.xhtml> (in Europe)

<https://www.sharp-nec-displays.com/jp/> (in Japan)

<https://www.sharpnecdisplays.us/> (in USA).

Securing personal information: Personally identifiable information, such as IP addresses, may be saved on the monitor. Before transferring or disposing of the monitor, clear this data by performing the network reset function.

Energy Saving

This monitor features an advanced energy saving capability. When a Display Power Management signal is sent to the monitor, the Energy Saving mode is activated. The monitor enters a single Energy Saving mode.

For additional information visit:

<https://www.sharpnecdisplays.us/> (in USA)

<https://www.sharpnecdisplays.eu/p/hq/en/home.xhtml> (in Europe)

<https://www.sharp-nec-displays.com/global/index.html> (Global)

For ErP requirement/For ErP (Network standby) requirement:

Except for conditions below:

[Energy Mode] is set to [Retail mode] or [Office mode].

[Quick Start] is set to [On].

[Auto Input Change] is set to [First] or [Custom].

[Power supply] is set to [On].

Power consumption (Blinking red): 2.0 W or less.

Time for power management function: 60 sec. (Default setting).

Power consumption (Lit red): 0.5 W or less.

Time for power management function: 3 min. (Default setting).

About Conversion Cables Used with the AV Terminal

Use a commercially-available video cable with a 4-contact mini jack ($\phi 3.5$ mm) at one extremity for conversion cables to connect to the AV terminal.

Check the wiring specification of the cable in advance and choose a proper cable.

NOTE: *Different wiring specifications may exist for 4-contact mini jack cables.

No.	Signal
1	Video
2	Audio (left)
3	Audio (right)
4	GND

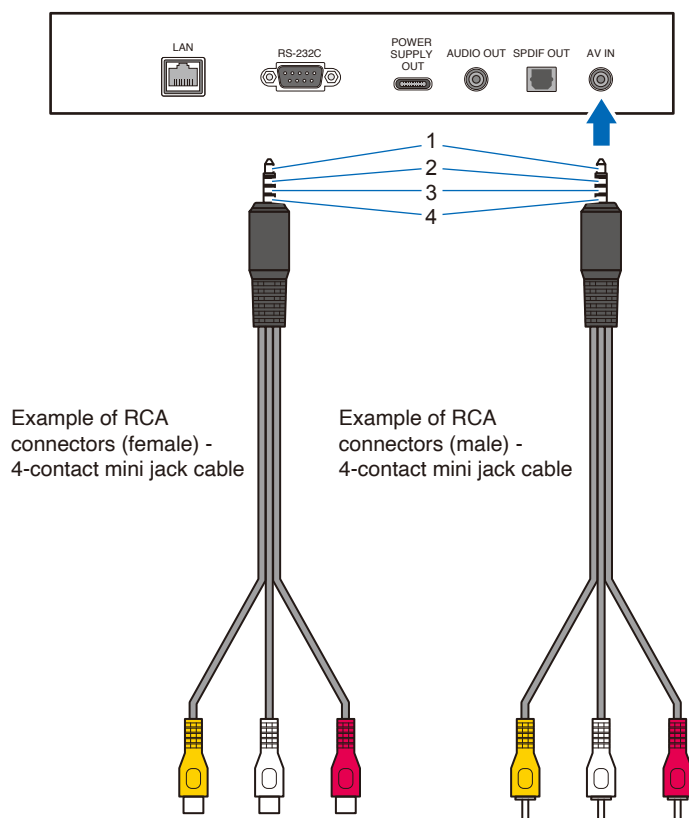

Appendix E About Crestron Connected

This monitor can be controlled via network using equipment and application software of Crestron Electronics, Inc.

This is a function to connect a system developed by Crestron Electronics, Inc. which manages and controls multiple system devices connected to the network.

For details, refer to the Crestron Electronics, Inc. website.

<https://www.crestron.com/>

This monitor supports “Crestron Fusion” and “Crestron XiO Cloud”, and is compatible with the Crestron XiO Cloud service.

For details, refer to the Crestron Electronics, Inc. website.

<https://www.crestron.com/Products/Featured-Solutions/Crestron-Fusion>

<https://www.crestron.com/Products/Featured-Solutions/XiO-Cloud>

Crestron CONTROL SYSTEM

INPUT SOURCE: HDMI1 Top

Crestron CONTROL SYSTEM	
CONTROL SYSTEM	<input type="radio"/> ENABLE <input checked="" type="radio"/> DISABLE
CONTROLLER IP ADDRESS	<input type="text" value="192.168.0.100"/>
PORT	<input type="text" value="41794"/> * from 1025 to 65535
IP ID	<input type="text" value="3"/> * from 3 to 254
VIRTUAL CONTROL ROOM ID	<input type="text"/>
USE TLS	<input type="radio"/> ENABLE <input checked="" type="radio"/> DISABLE
VERIFY CERTIFICATE	<input type="radio"/> ENABLE <input checked="" type="radio"/> DISABLE
MANAGE ROOT CERTIFICATE	select file : <input type="button" value="Choose File"/> No file chosen
	<input type="button" value="ADD CERTIFICATE"/>
	<input type="button" value="delete"/>
SECURE PORT	<input type="text" value="41796"/> * from 1025 to 65535
USER NAME	<input type="text" value="XXXXXXXX"/>
PASSWORD	<input type="password" value="....."/>

- CONTROL SYSTEM*1 Sets whether or not to use "Crestron Control System".
- IP ADDRESS Sets the IP address for "Control System".
- PORT Sets the port number to connect to "Control System".
- IP ID Sets the "IP ID" for "Control System".
- VIRTUAL CONTROL ROOM ID Sets the ID for "Virtual Control Room".
When not using "Virtual Control Room", leave this option empty.
- USE TLS Sets whether or not to use encrypted communication by TLS.
- VERIFY CERTIFICATE* Sets whether or not to authenticate with a certificate when using TLS.
- MANAGE ROOT CERTIFICATE* Import the root certificate for "Control System" to this monitor.
If the monitor has a different root certificate, remove it and then import the one you set.
The certification formats are: ".cer" and ".der".
- SECURE PORT* Sets the port number when using TLS.
- USER NAME Sets the username when using TLS.
- PASSWORD Sets the password when using TLS.

Apply the changed setting when pressing the SAVE button.

If the [Crestron Fusion On-Premises] or [Crestron Fusion in the Cloud] is set to [ENABLE], press the SAVE button to show a confirmation dialog box.

If the OK button in the dialog box is pressed, the setting for this function is saved and activated, and other functions are deactivated.

* This option is enabled when [USE TLS] is set to [ENABLE].

Crestron Fusion On-Premises

INPUT SOURCE: HDMI1 Top

STATUS	Crestron Fusion On-Premises	
PROTOCOL	Crestron Fusion On-Premises <input type="radio"/> ENABLE <input checked="" type="radio"/> DISABLE	
TCP	PORT	41794 * from 1025 to 65535
Crestron CONTROL SYSTEM	IP ID	4 * from 3 to 254
AMX	<input type="button" value="SAVE"/>	
NAME		
Crestron Fusion On-Premises		
Crestron Fusion in the Cloud		
Crestron XiO Cloud		

Crestron Fusion On-Premises*1 Sets whether or not to use "Crestron Fusion On-Premises".

PORT..... Sets the port number to connect to "Crestron Fusion On-Premises".

IP ID..... Sets the "IP ID" for "Crestron Fusion On-Premises".

Apply the changed setting when pressing the SAVE button.

If the [CONTROL SYSTEM] or [Crestron Fusion in the Cloud] is set to [ENABLE], press the SAVE button to show a confirmation dialog box.

If the OK button in the dialog box is pressed, the setting for this function is saved and activated, and other functions are deactivated.

* This option is enabled when [USE TLS] is set to [ENABLE].

Crestron Fusion in the Cloud

INPUT SOURCE: HDMI1 Top

STATUS	Crestron Fusion in the Cloud	
PROTOCOL	Crestron Fusion in the Cloud <input type="radio"/> ENABLE <input checked="" type="radio"/> DISABLE	
TCP	PORT	443 * from 1 to 65535
Crestron CONTROL SYSTEM	CLOUD URL	https://xxxxx
AMX	VERIFY CERTIFICATE	<input type="radio"/> ENABLE <input checked="" type="radio"/> DISABLE
NAME	MANAGE ROOT CERTIFICATE	select file : <input type="button" value="Choose File"/> No file chosen
Crestron Fusion On-Premises		<input type="button" value="ADD CERTIFICATE"/>
Crestron Fusion in the Cloud		<input type="button" value="delete"/>
Crestron XiO Cloud		
Crestron AUTO DISCOVERY		
NETWORK		
SYSTEM		
LOGOUT		
		<input type="button" value="SAVE"/>

Crestron Fusion in the Cloud*1..... Sets whether or not to use "Crestron Fusion in the Cloud".

CLOUD URL..... Sets the URL of Crestron Fusion.

PORT..... Sets the port number to connect to Crestron Fusion.

VERIFY CERTIFICATE* Sets whether or not to authenticate with a certificate when using TLS.

MANAGE ROOT CERTIFICATE* Import the root certificate for "Crestron Fusion in the Cloud" to this monitor.

If the monitor has a different root certificate, remove it and then import the one you set.

The certification formats are: ".cer" and ".der".

Apply the changed setting when pressing the SAVE button.

If the [CONTROL SYSTEM] or [Crestron Fusion On-Premises] is set to [ENABLE], press the SAVE button to show a confirmation dialog box.

If the OK button in the dialog box is pressed, the setting for this function is saved and activated, and other functions are deactivated.

* This option is enabled when [USE TLS] is set to [ENABLE].

Crestron AUTO DISCOVERY

INPUT SOURCE: HDMI1 Top

STATUS

PROTOCOL

TCP

Crestron CONTROL SYSTEM

AMX

NAME

Crestron Fusion On-Premises

Crestron Fusion in the Cloud

Crestron XiO Cloud

Crestron AUTO DISCOVERY

Crestron AUTO DISCOVERY

AUTO DISCOVERY ENABLE DISABLE

SAVE

AUTO DISCOVERY..... Sets whether or not to automatically detect this monitor.

Crestron XiO Cloud

INPUT SOURCE: HDMI1 Top

STATUS

PROTOCOL

TCP

Crestron CONTROL SYSTEM

AMX

NAME

Crestron Fusion On-Premises

Crestron Fusion in the Cloud

Crestron XiO Cloud

Crestron XiO Cloud

XiO Cloud	<input type="radio"/> ENABLE <input checked="" type="radio"/> DISABLE
CLOUD URL	<input type="text" value="https://xxxxx"/>
HOST NAME	EXX8-XX4XXXXXXXX
SERIAL NUMBER	XX4XXXXXXXX
MODEL NAME	NECConnectedDisplay
MAC ADDRESS	XX:XX:XX:XX:XX

SAVE

XiO Cloud Sets whether or not to use “XiO Cloud”.

XiO Cloud URL..... Sets the URL of “XiO Cloud”.

HOST NAME Displays the host name when connecting to “XiO Cloud”.

SERIAL NUMBER Displays the serial number when connecting to “XiO Cloud”.

MODEL NAME Displays the model name when connecting to “XiO Cloud”.

MAC ADDRESS Displays the MAC address when connecting to “XiO Cloud”.

Apply the changed setting when pressing the SAVE button.

Reset

*1: Cannot be used simultaneously. Only one of “Control System”, “Crestron Fusion On-Premises” and “Crestron Fusion in the Cloud” can be set to on.

