

acer



*Acer Chromebox Mini CXM1*

*Acer Chromebox Enterprise Mini CXM1*

**USER'S MANUAL**

© 2024. All Rights Reserved.

Acer Chromebox Mini CXM1 / Acer Chromebox Enterprise Mini CXM1

Covers: CXM1

This revision: September 2024



### Important

**This manual contains proprietary information that is protected by copyright laws. The information contained in this manual is subject to change without notice. Images provided herein are for reference only and may contain information or features that do not apply to your computer. Acer Group shall not be liable for technical or editorial errors or omissions contained in this manual.**

## Register your Acer product

Go to [www.acer.com/register-product](http://www.acer.com/register-product), and sign in or sign up your Acer ID to register your product.

Once it is done, you can review it under “My Products” page.

Model number: \_\_\_\_\_

Serial number: \_\_\_\_\_

Date of purchase: \_\_\_\_\_

Place of purchase: \_\_\_\_\_

Google and Google Play are trademarks of Google LLC.



The Adopted Trademarks HDMI, HDMI High-Definition Multimedia Interface, and the HDMI Logo are trademarks or registered trademarks of HDMI Licensing Administrator, Inc. in the United States and other countries.

# TABLE OF CONTENTS

---

<b>Getting started</b>	<b>4</b>	<b>Your Acer Chromebox tour</b>	<b>5</b>
Turn on your Chromebox.....	4	Front view .....	5
Select your language settings .....	4	Rear view .....	6
Connect to a network.....	4	.....	7
Accept the Terms of Service.....	4	<b>Assembling The VESA Mount</b>	<b>8</b>
First-time sign-in.....	4	<b>Frequently asked questions</b>	<b>14</b>
Create a new Google Account.....	4	Get help or more information .....	15
Browse as a guest .....	4		

# GETTING STARTED

---

## Turn on your Chromebox

On the Chromebox, press the power button. A "Welcome" screen will appear when the Chromebox first boots up.

## Select your language settings

Use the "Language" drop-down list to choose your default language setting. If there is more than one way to type in your language, you may be prompted to select a keyboard input method as well.

## Connect to a network

Select a network from the "Connect to network" list to connect to the Internet. If network access is protected, you will need an access password to connect to it.

## Accept the Terms of Service

Once connected to a network, accept the Terms of Service. Your Chromebox will then download any available system updates, so you automatically get the latest ChromeOS features.

## First-time sign-in

### Create a new Google Account

You can create a new Google Account if you don't already have one. Select **Create a Google Account** to set up a new account. A Google Account gives you access to useful web services developed by Google, such as Gmail, Google Drive, and Google Calendar.



### Browse as a guest

You can also use the Chromebox without a Google Account by selecting **Browse as a Guest**.

# YOUR ACER CHROMEBOX TOUR

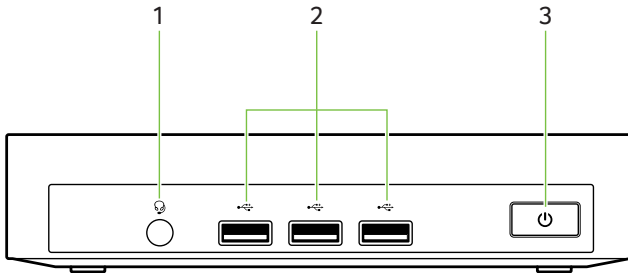



## Front view

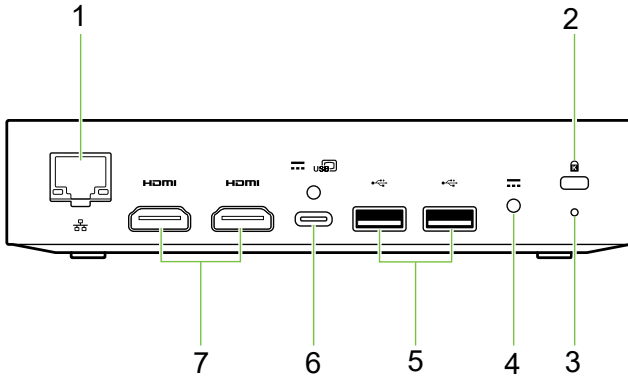

#	Icon	Item	Description
1		Headset/speaker jack	Connects to audio devices (e.g., speakers, headphones) or a headset with microphone.
2		USB port	Connects to USB devices.
3		Power button	Turns the computer on and off.

## Rear view



#	Icon	Item	Description
1		Ethernet (RJ-45) port	Connects to an Ethernet 10/100/1000Mbps/2.5Gbps-based network. (Specifications vary depending on configurations.)
2		Kensington lock slot	Connects to a Kensington-compatible security lock.
3		Recovery button	Insert a paperclip into the hole to reboot the computer.
4		DC-in jack	Connects to an AC adapter.
5		USB port	Connects to USB devices.
6		USB Type-C port	Connects to USB devices with a USB Type-C connector. Supports USB 3.2 Type-C, Gen 1 with transfer speeds up to 5 Gb/s. Supports Power Delivery / DisplayPort™ over USB-C™.

#	Icon	Item	Description
8		HDMI port	Supports high-definition digital video connections.

# ASSEMBLING THE VESA MOUNT

Your Chromebox can be fitted with a VESA-compatible mount that allows you to mount it behind a compatible monitor or TV.



## Note

*If a stand is currently installed to the VESA mounting holes on your monitor or TV, you will not be able to attach your Chromebox to the monitor or TV.*

1. Before assembling the VESA Mount, remove 2 mylar on the back of your Chromebox with a paper clip.

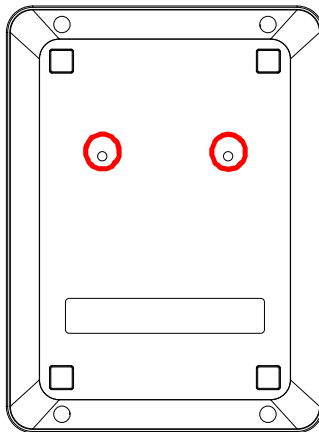



2. Attach the VESA lock clip to the VESA mounting bracket as illustrated (1).

3. Attach the velcro onto the adapter holder as illustrated (2).

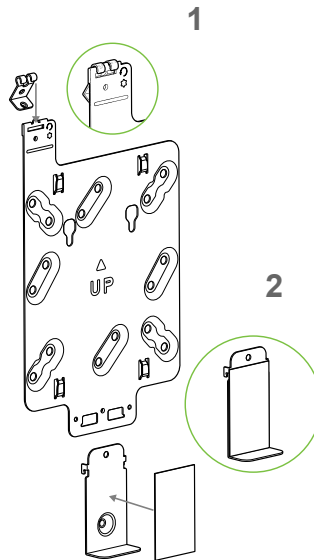

4. Attach the VESA mounting bracket to the back of your VESA display or Acer Monitor stand using the screws as illustrated.

- VESA display

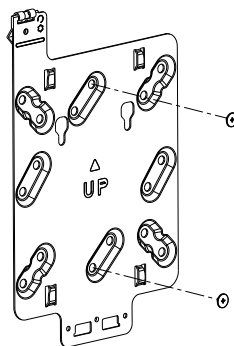

- Acer monitor with 75x75 mm or 100x100 mm square hole pattern

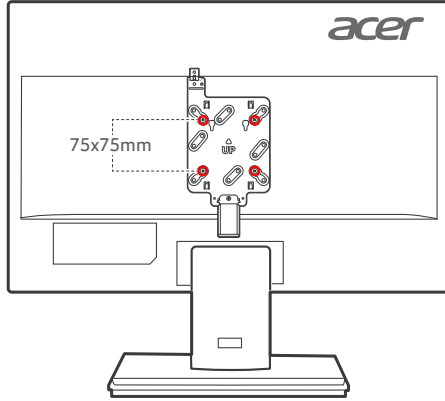

or

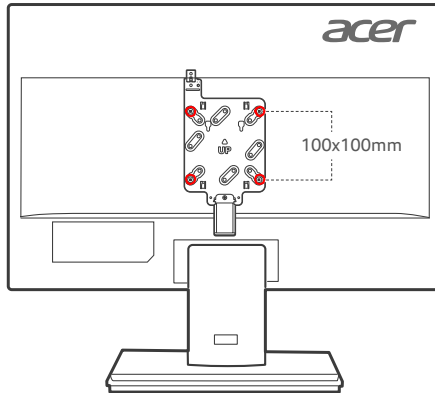

5. Attach the adapter holder to the VESA bracket using the screws as illustrated.

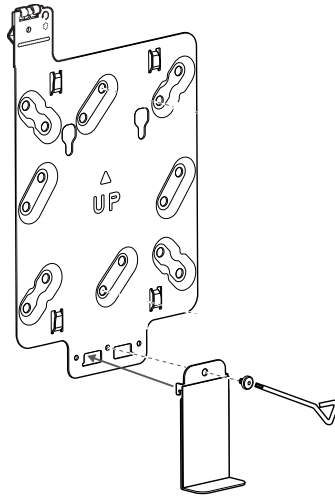

6. Fix the screws to the back of your Chromebox as illustrated.

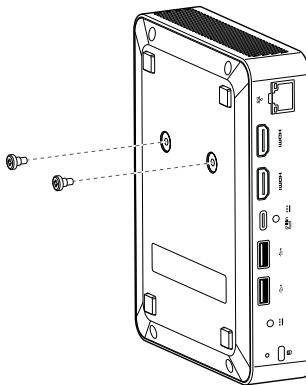

7. Align and insert the screw on the Chromebox into the holes on the VESA mounting bracket (1).
8. Fasten the VESA lock bracket and attach a screw into the screw hole on the mounting bracket to secure your Chromebox (2).

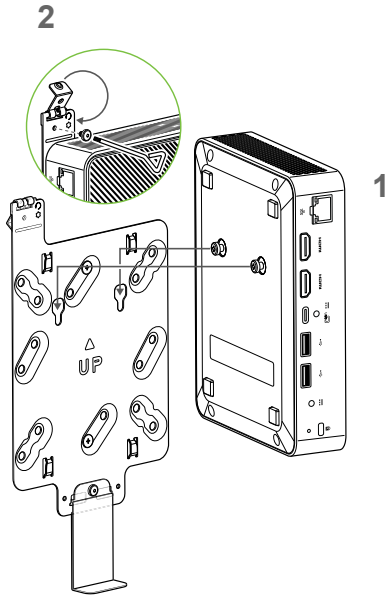

**Note**

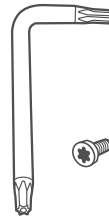

*Depending on the package contents, you can use a hexagon screw to secure the Chromebox to the mounting bracket.*



hexagon screw



# FREQUENTLY ASKED QUESTIONS

Question	Answer
What software works on a Chromebox?	Chromeboxes use apps from the Google Play Store and on the web. There are apps to be productive, get creative, enjoy movies and shows, play games and more.
How do I get more apps?	You can get more apps from the Google Play Store  or the web.
Can I use Microsoft Office software?	Chromeboxes work with Microsoft <sup>®</sup> Office. Whether it's Word, Excel <sup>®</sup> or PowerPoint <sup>®</sup> , you can easily find the apps on the web.
Where can I find my files?	All your files are stored in the Files app  . Find the app by clicking the Launcher icon  and searching "Files".
How do I transfer my local files?	Transfer your local files using a compatible storage device. Your Chromebox works with most external storage devices (e.g.: USB thumb drives, removable hard drives). You can also upload your files, photos, and videos to Google Drive. After setting up your Chromebox with your Google Account, you'll be able to access your files on Drive.
Why does my Chromebox need my Google Account information?	You'll use your Google Account to sign in to your Chromebox. It is the same account you use for Google services such as Gmail and Drive. Your Chromebox uses your account information to automatically sign you into apps and services.

Question	Answer
How do I set this up for my child?	If you want to set up parental controls for your child, it's important that you sign in using your child's personal Google Account. If they don't already have one, you can create one during the sign-in process on your Chromebox. You will be able to add your child's school account after you complete device onboarding.

## Get help or more information

For information on:	Refer to:
Chromebox Help	Open the <b>Explore</b> app  on your Chromebox.
ChromeOS	<a href="https://google.com/support/chromebox/">google.com/support/chromebox/</a>