

# X'TRA GO



## User' s Guide

### Table of Contents

<b>Introduction</b> .....	2
<b>X'TRA GO (GC515)</b> .....	3
Key Features .....	4
System Requirements .....	5
Specifications.....	6
Product Overview.....	7
Connection.....	8
LED Indicators .....	9
<b>Streaming Center Software</b> .....	10
<b>Download Streaming Center &amp; OBS plugin</b> .....	15
<b>Contact Us</b> .....	15
<b>About AVerMedia</b> .....	15
<b>AVerMediaCenter-1.0.24 (macOS)</b> .....	16
<b>AVerMediaCenter-1.0.24 (Win)</b> .....	17

# Introduction

This document is your User's Guide for the X'TRA GO (GC515). We have written this guide to provide you with the information you need to quickly and smoothly use the AVerMedia product.

After a quick introduction of the X'TRA GO and their target audience, we will dive into its key features, system requirements, and technical specs and show you how to set up and install the device. Lastly, this guide will finish with a link to our technical support team and with some brief information on AVerMedia's background.

Thank you for taking the time to use and try out our latest device, we hope you enjoy using it as much as we enjoyed making it. If you have any questions or suggestions on our products or need any further editorial assistance, please don't hesitate to contact us.

## X'TRA GO (GC515)



The **Premium Go Series** is a brand-new product line featuring three versatile products, each offering different levels of functionality. First to launch is the **X'TRA GO (GC515)**, a capture dock specifically engineered for Type-C mobile devices. The GC515 allows users to capture video content in up to **4K30 or 1080p120FPS** in just one click without a computer. In addition to its advanced capture capabilities, the GC515 also functions as a docking station, offering unparalleled connectivity and convenience, making it an essential tool for content creators, gamers, and professionals on the go.



Besides video capturing, the GC515 also features **Type-C DP Alt mode compatibility**, offering plug-and-play connectivity with a wide range of mobile devices, including handheld consoles, tablets, smartphones, and more. Supporting **4K60 HDMI output**, the GC515 ensures a superior viewing experience when connected to an external display, making it ideal for presentations, gaming, and entertainment. In its **PC-free mode**, users can directly **record content onto a microSD card** and easily access stored content with a single switch.

Beyond that, the GC515 also serves as a robust **docking station**, capable of securely holding a wide range of handheld consoles. This unique feature sets it apart in the market, providing users with an all-in-one solution that enhances content creation and device connectivity.

Tailored for those who demand performance and portability, the GC515 is a versatile tool that seamlessly integrates into the lives of creators, gamers, travelers, professionals, and educators.

## Key Features

 <p><b>Dock for Various Handheld Consoles</b></p>	<ul style="list-style-type: none"> <li>• <b>Universal Compatibility:</b> This dock supports a wide range of handheld consoles, making it a versatile addition to any gamer's setup.</li> <li>• <b>Seamless Integration:</b> Easily connect your console to the dock for hassle-free charging and gameplay.</li> <li>• <b>Compact and Portable:</b> Designed for convenience, it allows you to take your gaming on the go without sacrificing functionality.</li> </ul>
 <p><b>PC Free</b></p>	<ul style="list-style-type: none"> <li>• <b>Standalone Functionality:</b> Record your gameplay directly from the console without the need for a PC.</li> <li>• <b>Instant Capture:</b> Start capturing your gameplay instantly, making it perfect for spontaneous recording sessions.</li> <li>• <b>User-Friendly:</b> Simplifies the recording process, enabling gamers of all levels to capture their best moments effortlessly.</li> </ul>
 <p><b>One-Click Recording</b></p>	<ul style="list-style-type: none"> <li>• <b>Simplicity at Its Best:</b> Start recording with just a single click, ensuring you never miss a moment of action.</li> <li>• <b>Effortless Operation:</b> Designed for ease of use, allowing gamers to focus on their gameplay rather than complicated setups.</li> <li>• <b>Quick Access:</b> Provides immediate access to recording functions, making it ideal for capturing spontaneous gameplay highlights.</li> </ul>
<p><b>4K30</b></p> <p><b>4K30 Capture</b></p>	<ul style="list-style-type: none"> <li>• <b>High-Resolution Recording:</b> Capture your gameplay in stunning 4K at 30 frames per second or smooth 1080p at 120 frames per second.</li> <li>• <b>Professional Quality:</b> Ensures your recordings are of the highest quality, suitable for content creation and streaming.</li> <li>• <b>Flexible Options:</b> Choose between high resolution or high frame rate to match your recording needs.</li> </ul>

 <p><b>Charging, Displaying, Connecting</b></p>	<ul style="list-style-type: none"> <li>• <b>All-in-One Solution:</b> Combines charging, video output, and connectivity in a single, convenient device.</li> <li>• <b>Streamlined Setup:</b> Reduces the need for multiple cables and adapters, simplifying your gaming setup.</li> <li>• <b>Enhanced Productivity:</b> Ideal for multitasking, allowing you to charge, display, and connect your devices simultaneously.</li> </ul>
 <p><b>USB Power Delivery</b></p>	<ul style="list-style-type: none"> <li>• <b>Smart PD Chip Technology:</b> Utilizing a PD certified smart chip, this feature ensures the conversion of fluctuating voltage into a stable and reliable power supply.</li> <li>• <b>65W Fast Charging:</b> Supports up to 65W PD fast charging, allowing you to charge your device quickly while you continue to play.</li> </ul>

## System Requirements

### Windows® 10 x64 / 11 x64 or later

- **Desktop:**  
Intel® Core™ i5-6XXX / AMD Ryzen™ 3 XXX or above  
NVIDIA® GTX 1060 / AMD RX 5700 or above
- **Laptop:**  
Intel® Core™ i7-7700HQ+NVIDIA® GeForce® GTX 1050Ti or above
- **8 GB RAM recommended**



### macOS 13 / 14 or later

- Apple M1 or 3.6 GHz quad-core Intel Core i7
- Apple M1 or Radeon Pro 555 with 2 GB of VRAM
- 16 GB of 2400 MHz DDR4 memory / 14 or later

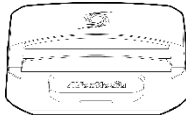
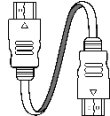
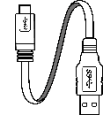
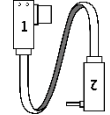

**Note:** Please note that the SD card should be formatted as **exFAT** and it is recommended to support **U3 and V30** to ensure video recording quality.

# Specifications

<b>Interface</b>	USB-A (USB 3.2 Gen 1) x 2, USB-C x 3, HDMI x 1
<b>Video Input (from console)</b>	USB-C DP Alt Mode*
<b>Video Output (Pass-through)</b>	HDMI 2.0
<b>Audio Output (Pass-Through)</b>	HDMI 2.0 / 3.5mm headphone jack (3-pole)
<b>Max. Pass-Through Resolution</b>	2160p60*, 1080p120
<b>Max. Recording Resolution</b>	2160p30, 1440p60, 1080p120
<b>Record Format</b>	MPEG4 (H.264/H.265)
<b>Record File Format</b>	fMP4 (Fragmented MP4)
<b>Supported Resolution</b>	2160p, 1440p, 1080p, 720p, 576p, 480p
<b>Micro SD Card Capacity (maximum)</b>	1TB (exFAT format)*, not included
<b>Dimensions (W x D x H)</b>	141 x 99.4 x 37.7 mm (5.55 x 3.91 x 1.48 in.)
<b>Weight</b>	176 g (6.21 oz.)
<b>What's in the Box</b>	<ul style="list-style-type: none"> <li>• X'TRA GO (GC515) </li> <li>• HDMI 2.0 Cable </li> <li>• Type-C to Type-A Cable (For connecting to PC/NB) </li> <li>• USB Type-C Cable (DP1.4, 10Gbps) (For connecting to video source) </li> <li>• Quick Start Guide </li> </ul>

Specifications are subject to change without prior notice. Please visit AVerMedia official website for the latest information.

**Note:** X'TRA GO does not support viewing, recording, or streaming of HDCP protected signals.

\*When passing through in 2160p60, the maximum recording resolution is capped at 1080p60.

\*DisplayPort 1.4 supports up to 4K60 pass-through, while DisplayPort 1.2 only supports up to 4K30 pass-through.

\*It is recommended to use a microSD card that supports "U3 and V30" to ensure high video recording quality.



**Caution:** Please use the supplied cables, especially the Type-C to Type-C cable for the source (handheld console) port. For optimal performance and safety, please use the official handheld console's power adapter when charging.

## Product Overview

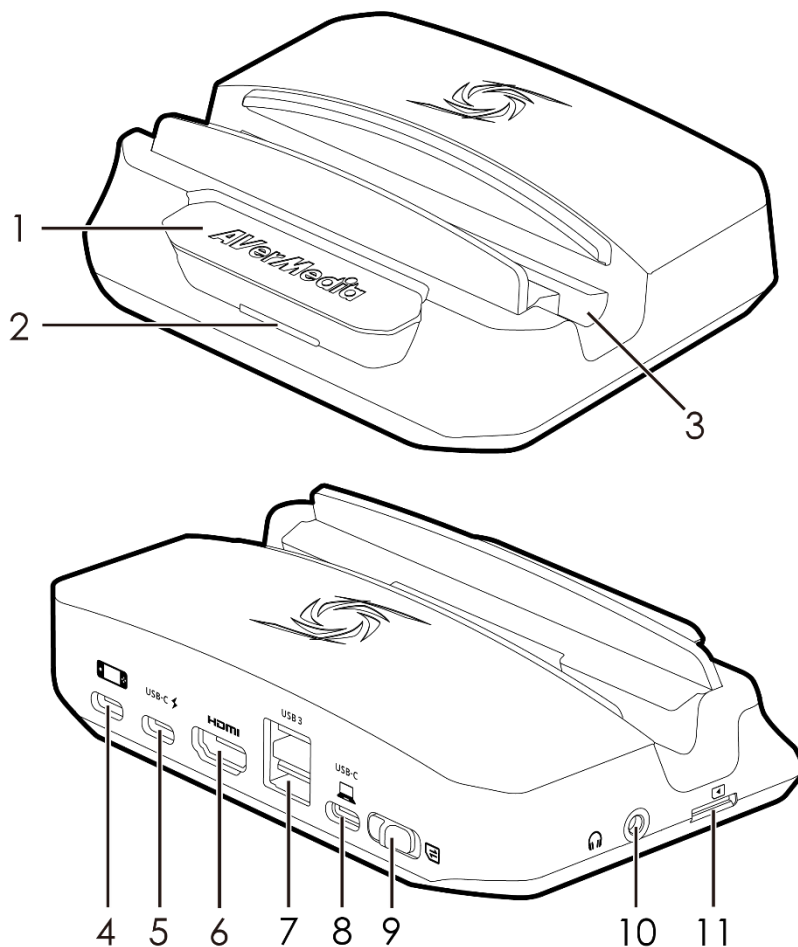

<b>1</b>	Hotkey Press: Start/Stop Recording, Start/Stop Streaming Press & Hold 3s: Close App	<b>7</b>	USB 3.2 Gen1 Ports (for mouse, keyboard, microphone, etc.)**
<b>2</b>	LED Indicator	<b>8</b>	USB-C Port (for Streaming PC)
<b>3</b>	Docking Slot	<b>9</b>	Mode Switch Left: Capture Mode Right  : Card Reader Mode
<b>4</b>	USB-C Port (for handheld or PC)	<b>10</b>	3.5mm Headphone Jack
<b>5</b>	USB-C Port (for PD charging only)*, **	<b>11</b>	SD Card Slot
<b>6</b>	HDMI Output for **		

\*The maximum output wattage for charging is capped at **65W**. For the best experience, a minimum wattage of **65W** is required.

\*\* The functionality of points No. 5 to No. 7 only works for devices connected to point No. 4.

# Connection

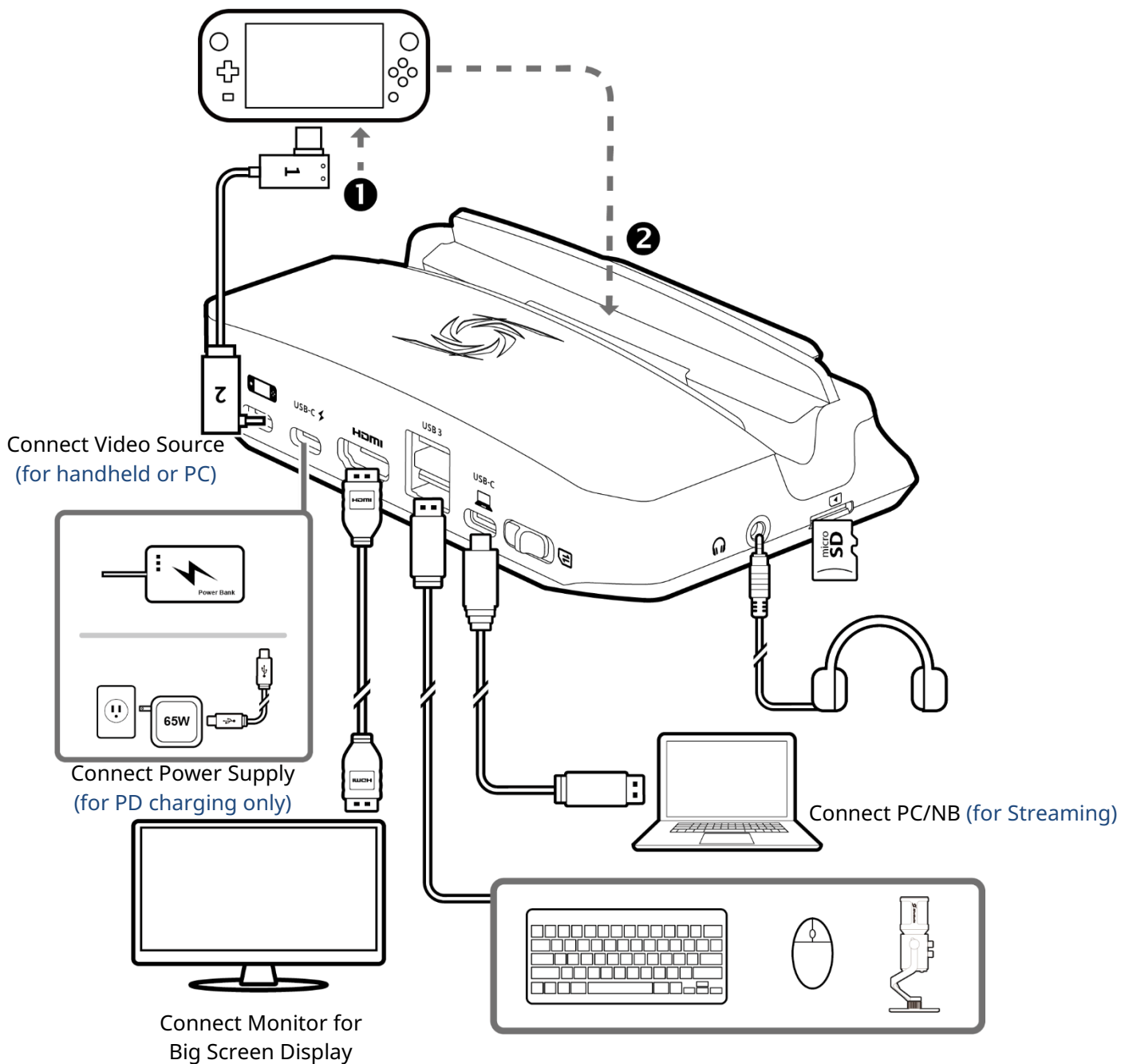

Ensure your device's thickness is within 21.5 mm (0.846 in).





## LED Indicators

<b>Solid Blue</b>	Ready
<b>Pulsing Red</b>	Recording
<b>Pulsing Blue</b>	Streaming
<b>Fast Flashing Red</b>	Disk almost full
<b>Flashing Blue</b>	Starting up / installing driver / updating firmware Card Reader Mode: Starting up / saving / copying files
<b>Solid Red</b>	<b>Capture Mode:</b> SD card full / SD card format not supported / SD card not formatted <b>Card Reader Mode:</b> No SD card detected
<b>Pulsing Blue &amp; Red</b>	Streaming and recording with Streaming Center
<b>Triple-Flashing Blue</b> → <b>Solid Blue/Red</b>	Switching Mode
<b>Solid Yellow</b>	The writing speed of the inserted memory card is too slow.

# Streaming Center Software

## Overview

Streaming Center is a powerful solution that provides a centralized platform for streaming devices such as capture cards, webcams, and microphones through an intuitive interface. Users can seamlessly manage multiple video and audio sources, customize scenes, and fine-tune production elements before going live using Streaming Center's advanced layout editing tools.

## Installation

Visit your AVerMedia product webpage and download Streaming Center. Install it by following the step-by-step instructions. Once installed, you'll be greeted with an interface as shown below.

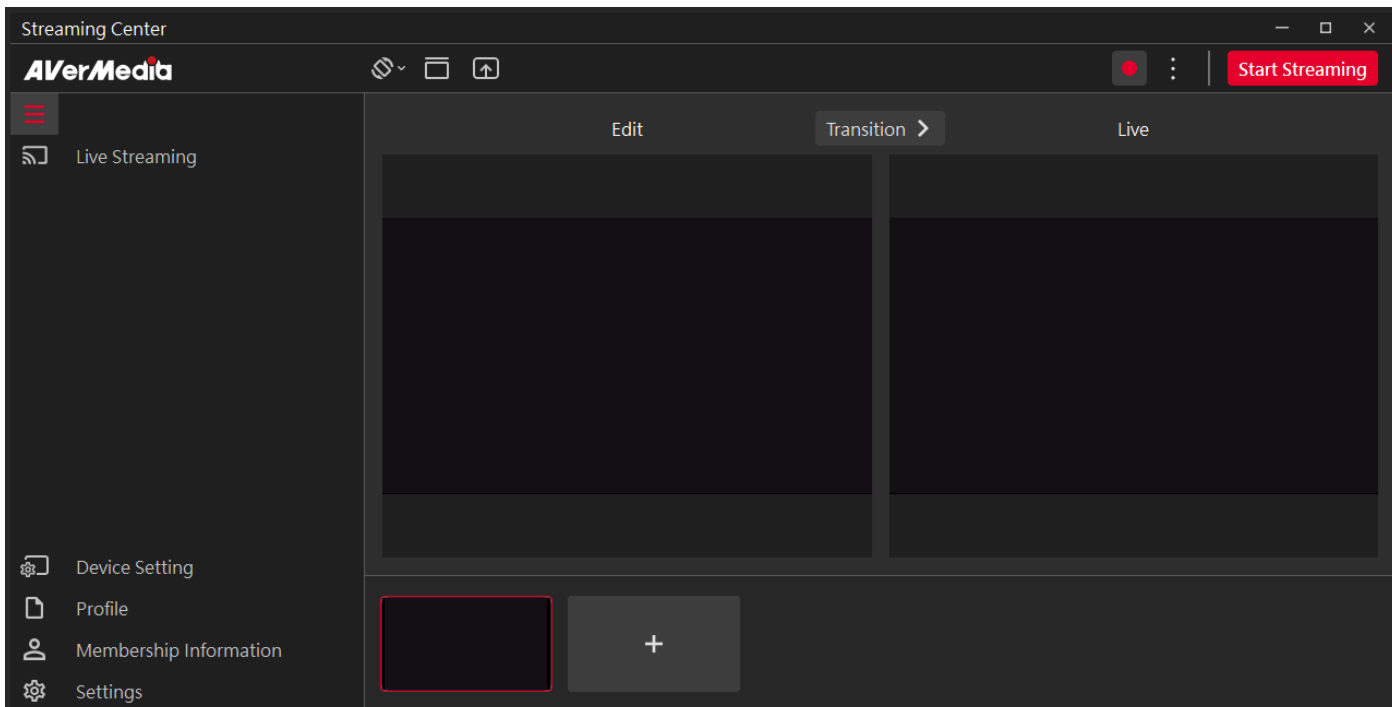

**Main UI**

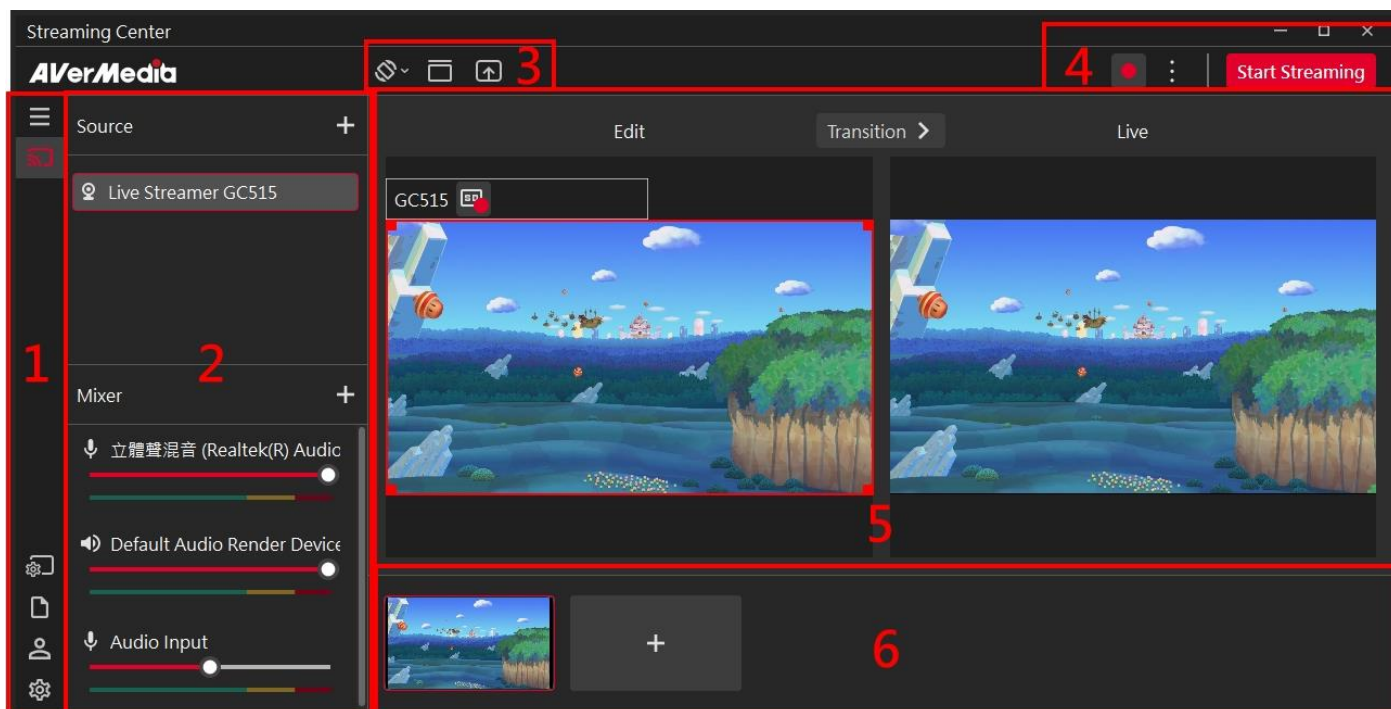

1. Function Bar: Expand it by clicking the 3-line icon. This section include the essential functions: Live Streaming. It also has other functions that allow quick access to Save Folder, Profile, and Settings.
2. Scene Device Panel: This area lets users add devices to the aforementioned three essential functions for each scene. For example, when a scene (from section 6) is selected, you can add cameras, capture cards to Source, and microphones to Mixer in this panel.
3. This section includes functions to change screen orientation, switch between Director Mode and Easy Mode, and open the Image Detection Preview Window.
4. Record and Start/Stop Streaming.
5. Left: Edit screen. Right: Live screen. Click Transition to switch whatever is currently in the Edit screen to the Live screen.
6. Scene panel: You can add/delete scenes here or select a scene to be edited in the Edit screen.

## Getting Started

Add your Source: Click the Live Streaming button in the Function Bar and start adding your source devices to the panel. Click the + button to add your source GC515 from camera/capture card.

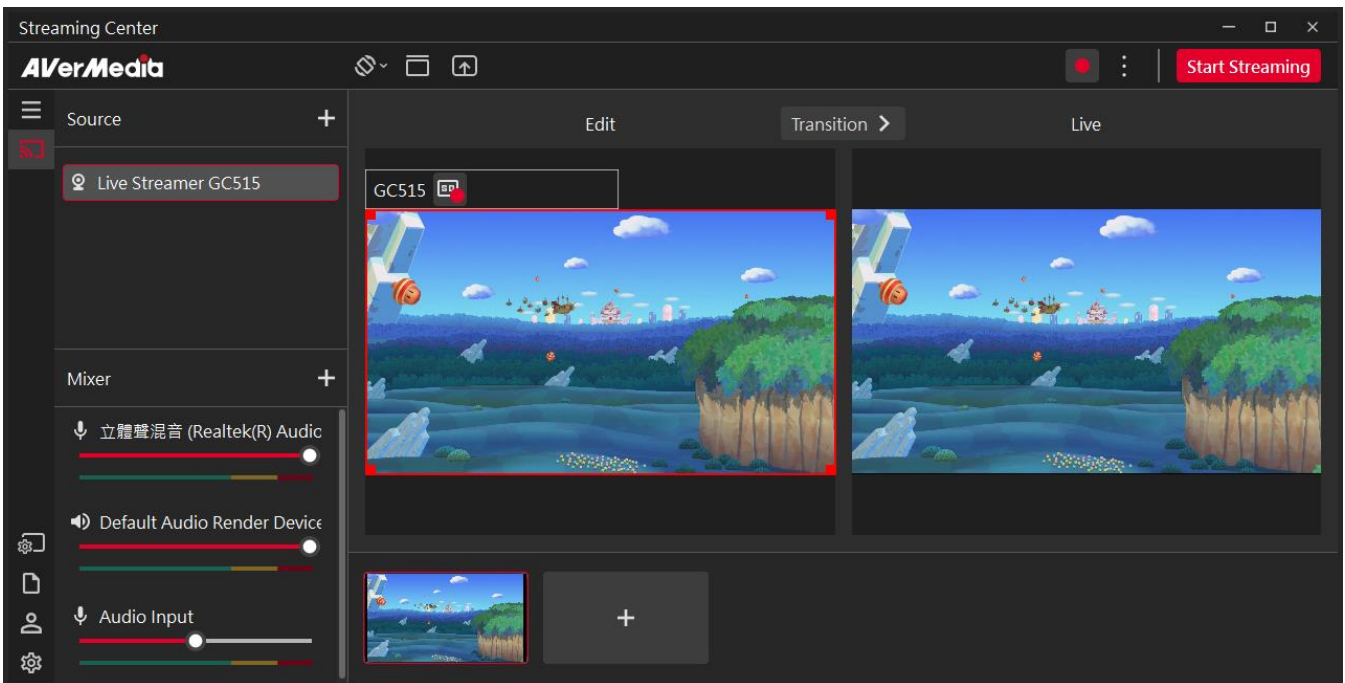
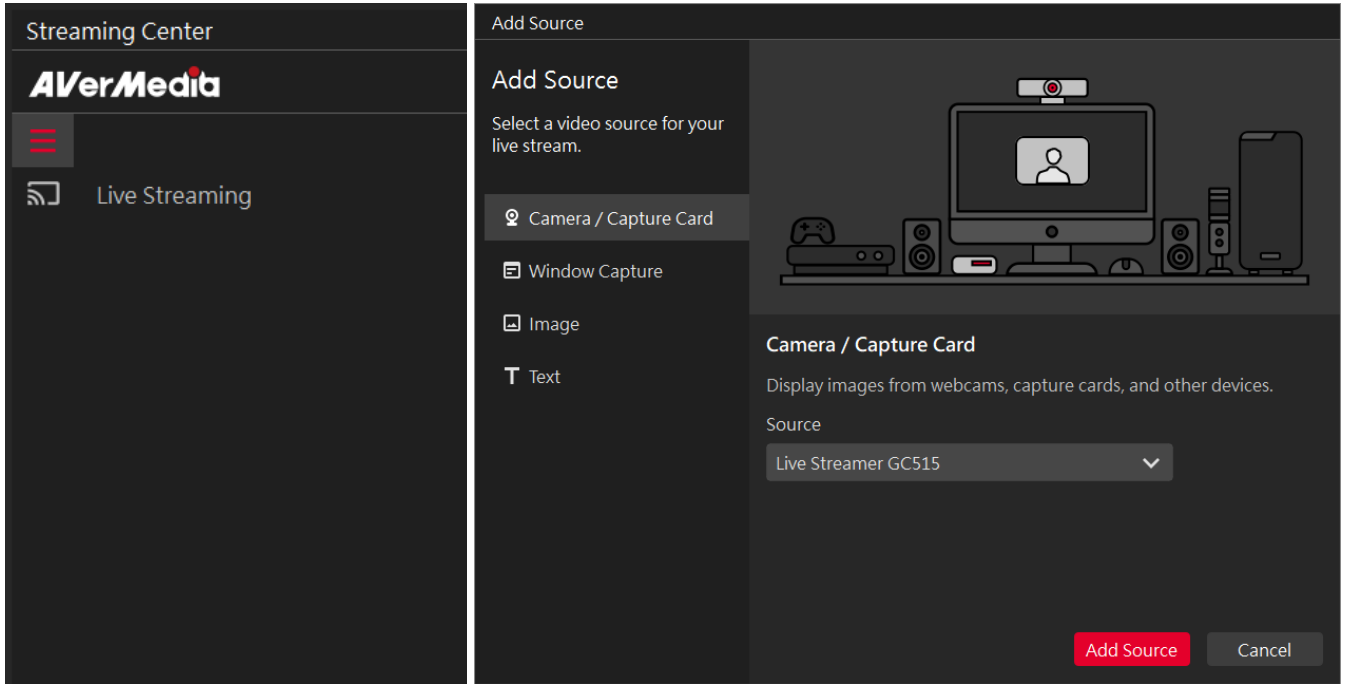

## Device Settings

Click the Device Setting  icon to enter the GC515 device setting pages. You can control the GC515 device on these pages.

Audio Volume setup:

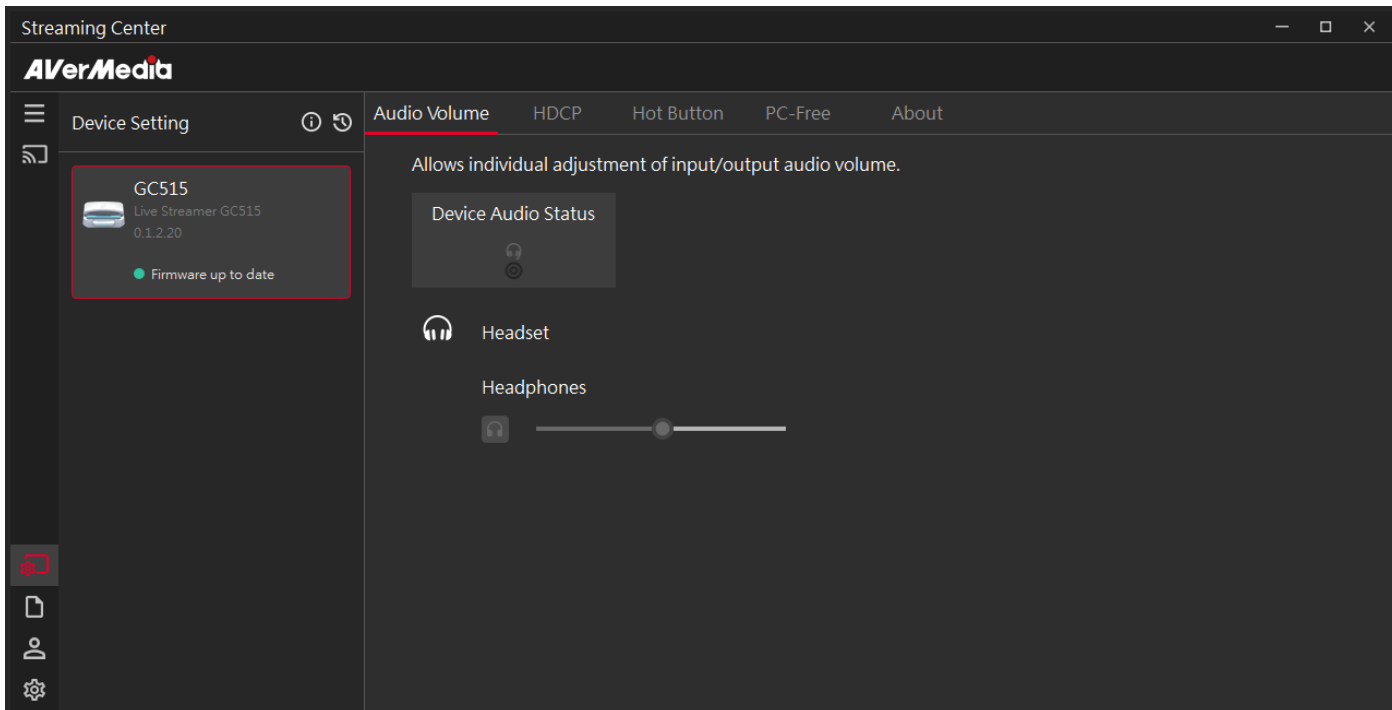

HDCP function setup:

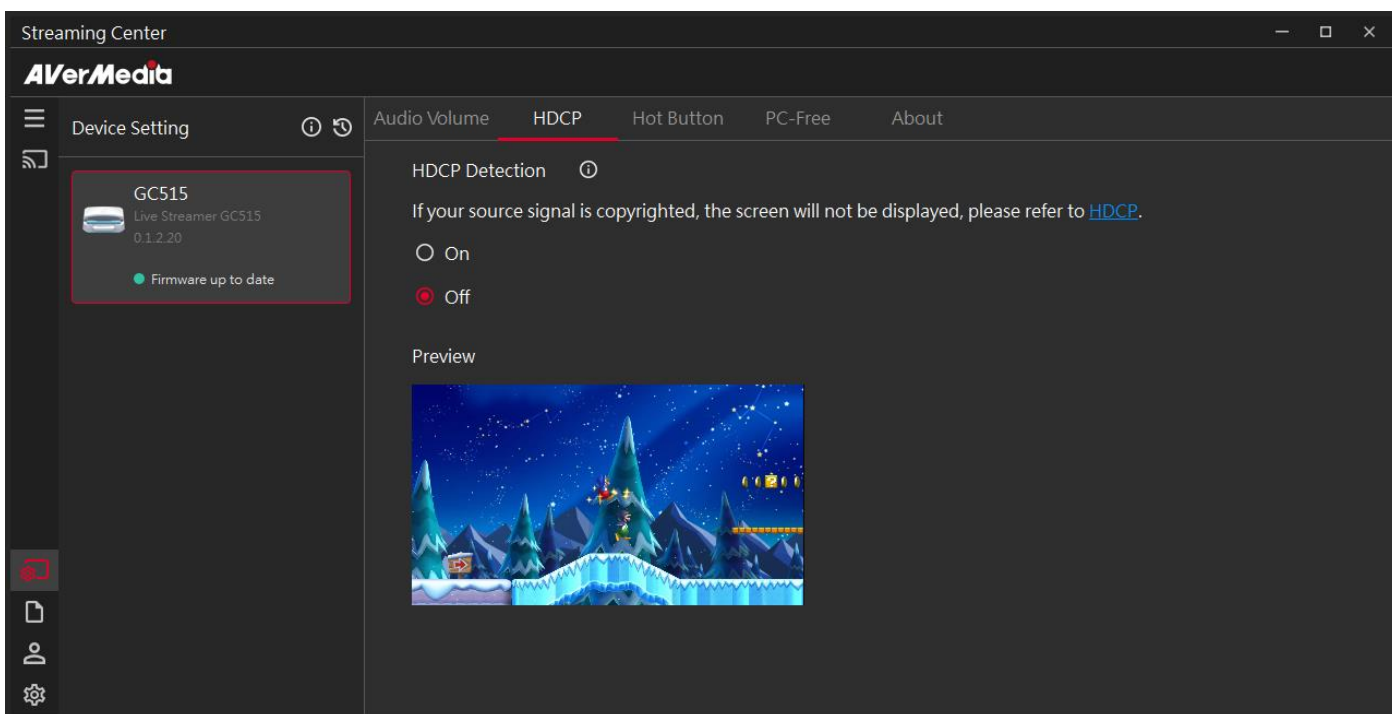

## Hot Button Setup:

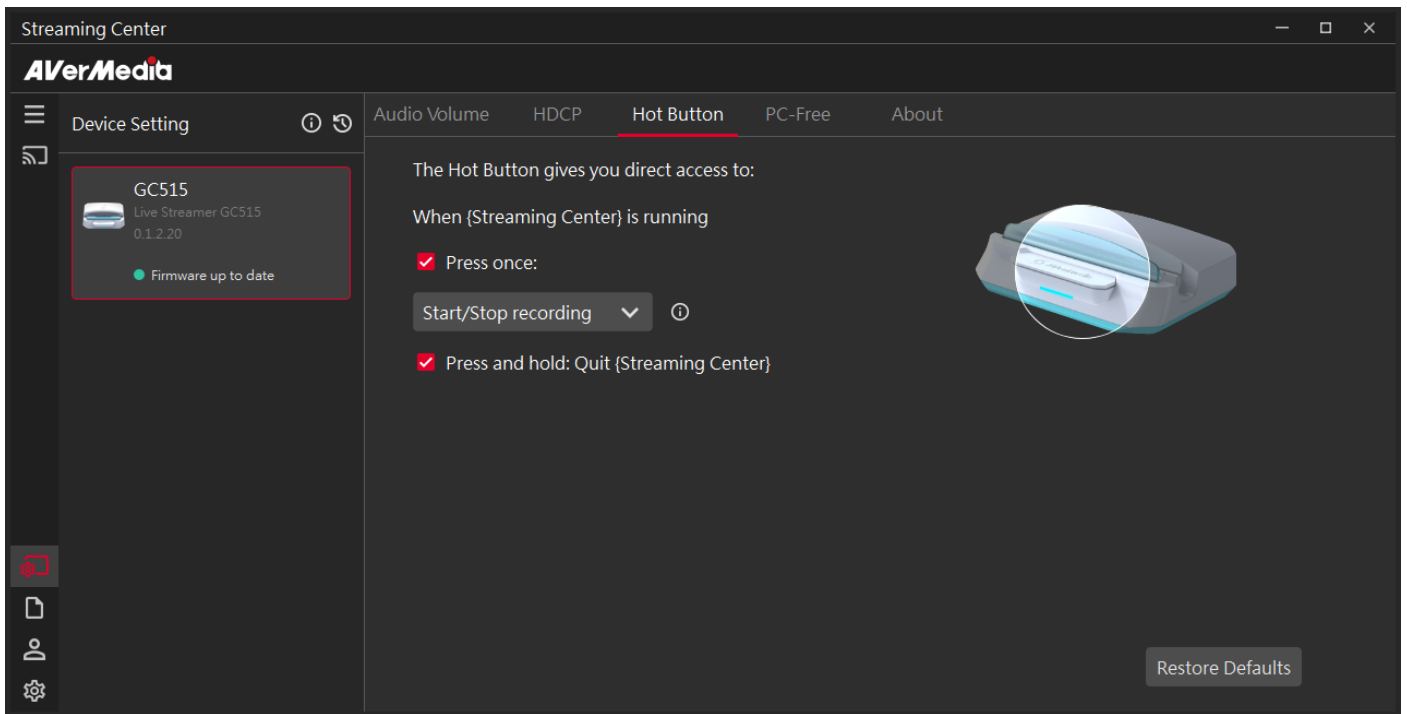

## PC-Free function setup:

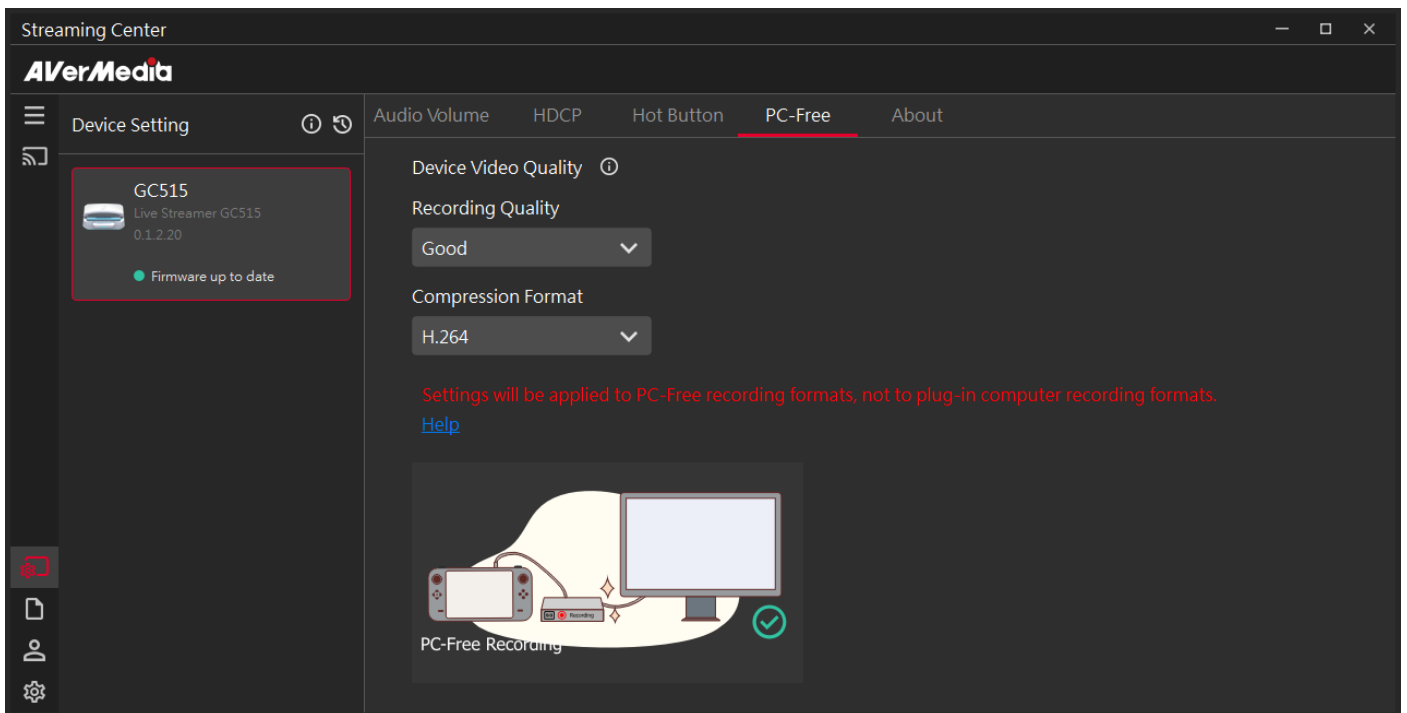

## Download Streaming Center & OBS plugin

<https://www.avermedia.com/product-detail/capture-dock-GC515#download>

## Contact Us

Please contact us [here](#) should you have any questions or suggestions.

## About AVerMedia

AVerMedia Technologies specializes in digital video and audio technology. We provide cutting-edge, high-quality audio and video peripherals, professional capturing and streaming solutions, Edge AI technology, video collaboration solutions, and more. Our mission is to provide an enriched user experience and effective communication in education, content creation, and video communication via innovative and eco-friendly solutions.

AVerMedia is guided by a philosophy of contributing to society- whether through products that change customers' lives for the better or by ensuring our operations are socially responsible.

Connect with AVerMedia:

Website: <https://www.avermedia.com/>

LinkedIn: <https://www.linkedin.com/company/avermedia-technologies>

## **AVerMediaCenter-1.0.24 (macOS)**

Operating System: macOS 13.x & macOS 14.x

Description: OBS Studio version 30.2 or later required

### 1. GC515 Settings

1-1. Select Recording Quality

1-2. Monitor Headphone Volume Control

1-3. HDCP Handshake Toggle

1-4. Notifications for Software/Firmware Upgrades

1-5. Software Version, GC515 Firmware Version

### 2. Help and Advice (Contact Technical Support)

Notes: Please make sure your GC515 is connected to your mac, switch to Capture card Mode, then you can install GC515 Setting on AVerMedia Center follow by below illustration:

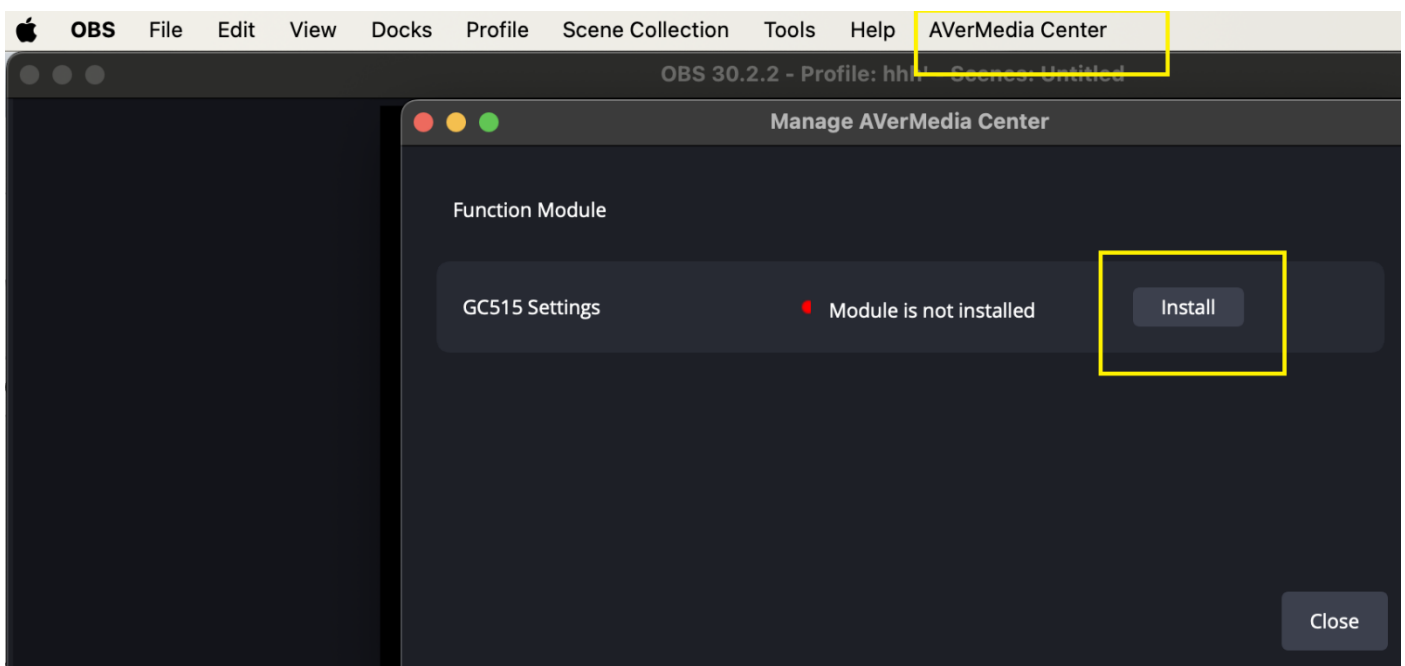

Please refer to the below tutorial video: <https://youtu.be/2MfkPzUTuyQ>



# AVerMediaCenter-1.0.24 (Win)

Operating System: Win10 x64; Win11

Description:

## 1. GC515 Settings

- 1-1. Select Recording Quality
- 1-2. Monitor Headphone Volume Control
- 1-3. HDCP Handshake Toggle
- 1-4. Notifications for Software/Firmware Upgrades
- 1-5. Software Version, GC515 Firmware Version
- 1-6. ISP Tool for Firmware Upgrade

## 2. AVerMediaHyperDecoder V1.0.8 (Windows)

- 2-1. Work with GC515 for use in OBS Studio (OBS Studio must be version 30.2 or later).
- 2-2. Reduce preview latency (Windows).

## 3. Help and Advice (Contact Technical Support)

Notes: Please make sure your **GC515 is connected to your PC, switch to Capture card Mode**, then you can install **GC515 Setting** and **AVerMediaHyperDecoder** on AVerMedia Center follow by below illustration:

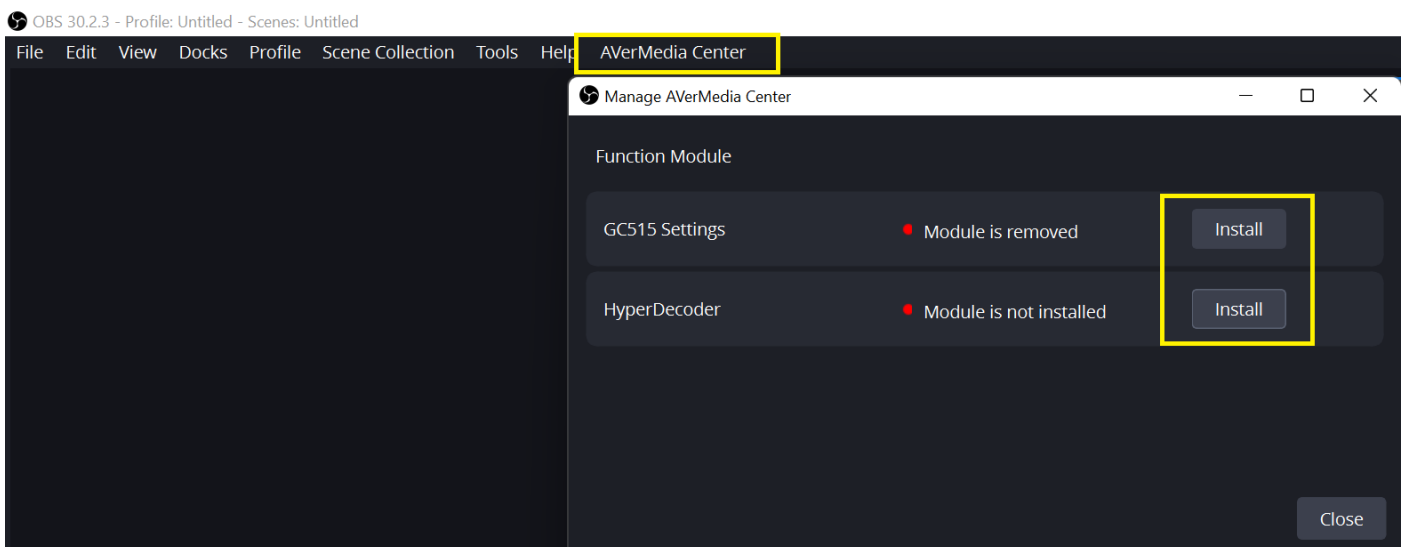

Please refer to the below tutorial video: <https://youtu.be/2MfkPzUTuyQ>