

**SAMSUNG**

# User Manual

---

VH55C-R VM55C-R VH55C-E VM55C-E

---

The color and the appearance may differ depending on the product, and the content in the manual is subject to change without prior notice to improve the performance.

---

# Table of contents

## Before Using the Product

---

Safety Precautions	5
Safety symbols	5
Electricity and Safety	6
Installation	7
Operation	9
Precautions when handling the panel	11
Cleaning	12

---

Storage and Maintenance	12
-------------------------	----

## Preparations

---

Checking the Components	13
Components	13

---

Parts	14
Reverse Side	14
Remote Control	15
Connection Using an IR Stereo Cable (sold separately)	17

---

Before Installing the Product (Installation Guide)	18
Switching between portrait and landscape	18
Ventilation	18

---

Installing the Wall Mount	19
Preparing before installing Wall-Mount	19
Installing the Wall Mount	19
Wall Mount Kit Specifications (VESA)	20

## Connecting and Using a Source Device

---

Before Connecting	21
Pre-connection Checkpoints	21

---

Connecting to a PC	21
Connection using a DVI cable (Digital type)	21
Connection Using an HDMI-DVI Cable	22
Connection Using an HDMI Cable	22
Connection Using an DP Cable	23

---

Connecting to a Video Device	24
Connection Using an HDMI-DVI Cable	24
Connection Using an HDMI Cable	25

---

Connecting to an Audio System	25
-------------------------------	----

---

Connecting the LAN Cable	26
--------------------------	----

---

Changing the Input source	27
Source	27

## Multiple Display Control

---

Cable Connection	28
RS232C Cable	28
LAN Cable	29
Connection	31
Control Codes	32

---

Using MDC	39
MDC Program Installation/Uninstallation	39

## Home feature

---

Video Wall	40
Video Wall	40
Horizontal x Vertical	40
Screen Position	41
Format	41

---

On/Off Timer	42
On Timer	42
Off Timer	42
Holiday Management	43

---

# Table of contents

---

Network Settings	44
ID Settings	45
Device ID	45
Device ID Auto Set	45
PC Connection Cable	45
More settings	46

## Screen Adjustment

---

Backlight / Brightness / Contrast / Sharpness / Picture Enhancer / Color / Tint (G/R)	47
Color Temperature	47
White Balance Settings	48
Gamma	48
Black Equalizer	48
Picture Options	48
Color Tone	48
HDMI Black Level	48
Input Signal Plus	48

---

Apply Picture Settings	49
Picture Size	49
Picture Size	49
Picture Off	49
Reset Picture	49

## OnScreen Display

---

Display Orientation	50
Onscreen Menu Orientation	50
Source Content Orientation	50
Aspect Ratio	50
Screen Protection	51
Pixel Shift	51
Timer	51
Immediate Display	51
Side Gray	51
Message Display	52
Source Info	52
No Signal Message	52
MDC Message	52
Menu Language	52
Reset OnScreen Display	52

## System

---

Setup	53
Time	54
Clock Set	54
DST	54
Sleep Timer	54
Power On Delay	54
Auto Source Switching	55
Auto Source Switching	55
Primary Source Recovery	55
Primary Source	55
Secondary Source	55
Power Control	55
Auto Power On	55
Standby Control	56
Remote Configuration	56
Power Button	56
Eco Solution	56
Energy Saving	56
Screen Lamp Schedule	56
No Signal Power Off	57
Auto Power Off	57

---

# Table of contents

---

Temperature Control	57
Change PIN	57
General	58
Security	58
HDMI Hot Plug	58
Frame Alignment	58
Reset System	58

## Sound Adjustment

---

HDMI Sound	59
Sound on Video Call	59
Reset Sound	59

## Support

---

Software Update	60
Updating via USB Device	60
Contact Samsung	60
Go to Home	61
Video Wall	61
On/Off Timer	61
Network Settings	61
ID Settings	61
More settings	61
Reset All	61

## Troubleshooting Guide

---

Requirements Before Contacting Samsung Customer Service Center	62
Testing the Product	62
Checking the Resolution and Frequency	62
Check the followings.	63

## Specifications

---

General	70
Preset Timing Modes	72

## Appendix

---

Responsibility for the Pay Service (Cost to Customers)	73
Not a product defect	73
A Product damage caused by customer's fault	73
Others	73
Prevention of Afterimage Burn-in	74
What is afterimage burn-in?	74
Recommended prevention practices	74
License	75





# Chapter 01







## Before Using the Product

### Safety Precautions

The following safety instructions are to ensure your personal safety and prevent property damage. Please read the following to ensure the proper use of the product.

#### Safety symbols

Symbol	Name	Meaning
	Warning	A serious or fatal injury may result if instructions are not followed.
	Caution	Personal injury or damage to properties may result if instructions are not followed.
	Prohibition	Do NOT attempt.
	Instruction	Follow directions.

CAUTION			
RISK OF ELECTRIC SHOCK. DO NOT OPEN.			
CAUTION: TO REDUCE THE RISK OF ELECTRIC SHOCK, DO NOT REMOVE COVER (OR BACK). THERE ARE NO USER SERVICEABLE PARTS INSIDE. REFER ALL SERVICING TO QUALIFIED PERSONNEL.			
	This symbol indicates that high voltage is present inside. It is dangerous to make any kind of contact with any internal part of this product.		AC voltage: Rated voltage marked with this symbol is AC voltage.
	This symbol indicates that this product has included important literature concerning operation and maintenance.		DC voltage: Rated voltage marked with this symbol is DC voltage.
	Class II product: This symbol indicates that a safety connection to electrical earth (ground) is not required. If this symbol is not present on a product with a mains lead, the product MUST have a reliable connection to protective earth (ground).		Caution. Consult instructions for use: This symbol instructs the user to consult the user manual for further safety related information.

## Electricity and Safety

— The following images are for reference only. Real-life situations may differ from what is shown in the images.

### Warning



Do not touch the power plug with wet hands.  
Otherwise, an electric shock may result.

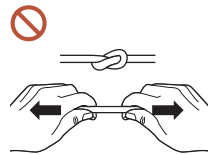



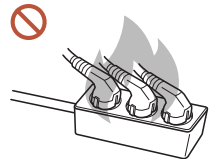

Do not bend or pull the power cord with force. Be careful not to leave the power cord under a heavy object.

Product failure, an electric shock or fire may result from a damaged cable.



Do not connect multiple products to a single power socket.  
Overheated power sockets may cause a fire.

-  Insert the power plug all the way in so it is not loose.  
An unsecure connection may cause a fire.
-  Clean any dust around the pins of the power plug or the power socket with a dry cloth.  
A fire may result.
-  Connect the power plug to a grounded power socket. (Except for devices that do not provide grounding)  
An electric shock or injury may result.
-  Do not use a damaged power plug or a loose power socket.  
An electric shock or fire may result.

## Caution

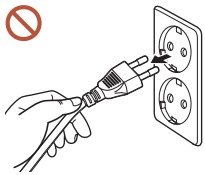

Hold the plug when disconnecting the power cord from the power socket.

An electric shock or fire may result.

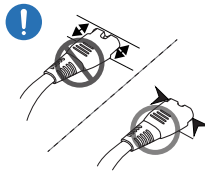

When connecting the power plug to the port, be sure to connect it completely.

If the power plug is not completely connected to the port, the plug may be unexpectedly disconnected, or there is a risk of overheating due to overcurrent, leading to safety accidents.

 Only use the power cord provided with your product by Samsung. Do not use the power cord with other products.

An electric shock or fire may result.

 Keep the power socket where the power cord is connected unobstructed.

When a problem occurs with the product, the power cord must be unplugged to completely cut off power to the product. Note that the product is not completely powered down by using only the power button on the remote.

 Do not disconnect the power cord while the product is being used.

The product may become damaged by an electric shock.

## Installation

### Warning

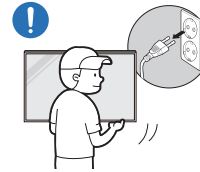

Before moving the product, turn off the power switch and disconnect the power cord and all other connected cables.

Damage to the cable may cause a fire or electric shock.

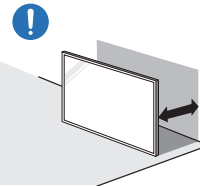

When installing the product, keep it at a distance from the wall so that it is well ventilated.

An increased internal temperature may cause a fire.



Do not install the product in a poorly ventilated space such as bookcase or closet.

An increased internal temperature may cause a fire.



Keep the plastic packaging out of the reach of children.

Children's misuse of the plastic packaging may cause suffocation.

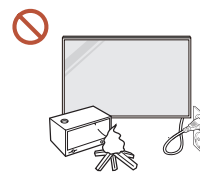

Do not install the power cord (DC power supply) and the product near heat sources.

(Candles, mosquito repellents, cigarettes, sprays, heating devices, places exposed to direct sunlight, and more)



**When installing the product, fix it firmly so that it does not fall.**

If the product is not fixed firmly and a child touches the product while playing, the product may fall, causing damage to the product or injury to the child.



**Do not install the product in a kitchen or near a kitchen counter.**

Edible oil or oil vapor can damage or deform the product.

**! Have a technician install the wall-mount hanger.**

Installation by an unqualified person can result in an injury. Only use approved cabinets.

**! If the product is installed in an unusual location, the surrounding environment may cause a serious quality problem. Therefore, be sure to contact Samsung Customer Service Center before installation.**

(Places where many fine dusts are generated, places where chemicals are used, places with too high or low temperatures, places with a lot of moisture or water, transportation equipment such as vehicles, airports and stations used continuously for a long time, and more)

**! Caution**

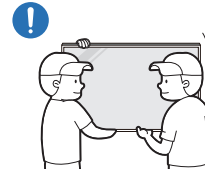

**When lifting and moving the product, do not touch the screen display, and make sure that at least two people work together.**

The product may fall, causing personal injury or product damage.

**! Do not lay down the product on its front.**  
The screen may become damaged.

**! Prolonged exposure to direct sunlight may discolor the surface of the screen display.**

## Operation

### Warning



If the product generates a strange noise, a burning smell, or smoke, unplug the power plug immediately and contact your Samsung Customer Service Center.

An electric shock or fire may result.

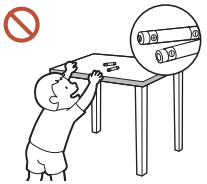

Keep the remote control batteries and the small accessories out of the reach of children. Ensure children do not swallow any of them.

If children have had the battery in their mouths, consult your doctor immediately.



If the product is dropped or its appearance is damaged, turn off the power switch and disconnect the power cord. Then contact Samsung Customer Service Center.

Continued use can result in an electric shock or a fire.



Do not move the product by pulling the power cord or any cable.

Product failure, an electric shock or fire may result from a damaged cable.

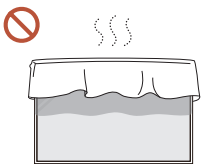

Ensure the vents are not blocked by tablecloths or curtains.

An increased internal temperature may cause a fire.

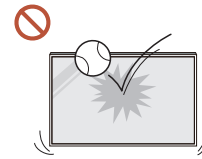

Do not apply an impact to the product.

- The screen display may be damaged.
- An electric shock or fire may result.

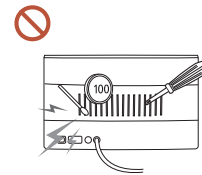

Do not insert metallic objects (chopsticks, coins, hairpins, etc) or objects that burn easily (paper, matches, etc) into the product (via the vent or input/output ports, etc).

- If foreign substances enter the product, be sure to power off the product and disconnect the power cord. Then contact Samsung Customer Service Center.
- Product failure, an electric shock or fire may result.

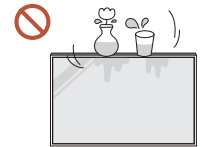

Do not place objects containing liquid (vases, pots, bottles, etc) or metallic objects on top of the product.

- If foreign substances such as water enter the product, be sure to disconnect the power cord. Then contact Samsung Customer Service Center.
- Product failure, an electric shock or fire may result.

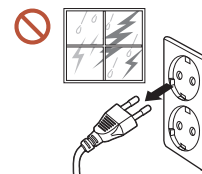

During a lightning or thunderstorm, power off the product and disconnect the power cord.

An electric shock or fire may result.



Do not leave heavy objects or items that children like (toys, sweets, etc.) on top of the product.

The product or heavy objects may fall as children try to reach for the toys or sweets resulting in a serious injury.



Do not hang on or climb on the product.

- The product may fall, causing personal injury or even death.
- Be especially careful that children do not hang on or climb on the product.

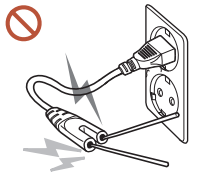

While the power plug is plugged into a power socket, do not insert a chopstick or other conductor into a remaining power socket. Also, after disconnecting the power plug from the power socket, do not touch the pins of the plug immediately.

Otherwise, an electric shock may result.



There is a high voltage inside the product. Never disassemble, repair or modify the product yourself.

- Contact Samsung Customer Service Center for repairs.
- An electric shock or fire may result.

**!** If a gas leakage is found, do not touch the product or the power plug, and ventilate the room immediately.

Sparks can cause an explosion or fire.

**⊘** Do not use humidifiers or stoves around the product.

An electric shock or fire may result.

## **!** Caution

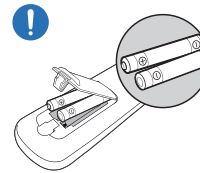

Insert each battery so that its polarity (+, -) is correct.

If the polarity is not correct, the battery may rupture or the internal fluid may leak, causing contamination and damage to the surroundings, fire, or personal injury.



Do not place heavy objects on the product.

Product failure or personal injury may result.

**!** When you do not use the product for a long time due to vacation or other reason, disconnect the power cord from the power socket.

Dust accumulation combined with heat can cause a fire, electric shock or electric leakage.

**!** Use the product at the recommended resolution and frequency.

Your eyesight may deteriorate.

**!** The batteries (and rechargeable batteries) are not ordinary refuse and must be returned for recycling purposes. The customer is responsible for returning the used or rechargeable batteries for recycling.

The customer can return used or rechargeable batteries to a nearby public recycling center or to a store selling the same type of the battery or rechargeable battery.

**!** Rest your eyes for more than 5 minutes for every 1 hour of product use.

Eye fatigue will be relieved.

**!** Leaving the screen fixed on a stationary image for an extended period of time may cause afterimage burn-in or defective pixels.

When you do not use the product for a long time, activate power-saving mode or set the screen saver to moving-picture mode.

**!** Do not use or keep combustible spray or an inflammable substance near the product.

An explosion or fire may result.

**⊘** Use only the specified standardized batteries, and do not use a new battery and a used battery at the same time.

Otherwise, the batteries may be damaged or cause fire, personal injury or damage due to a leakage of the internal liquid.

**⊘** Do not watch the product screen too closely and continuously for a long time.

Your eyesight may deteriorate.

**⊘** Do not lift or move the product when it is in operation.

**⊘** Do not touch the screen when the product has been turned on for an extended period of time as it will become hot.

**⊘** When using headphones or earphones, do not turn the volume too high or use them for a long time.

Damage to your hearing may result.

## Precautions when handling the panel

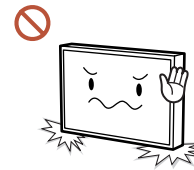

Do not stand the product as shown in the image. The panel is fragile and can get damaged.

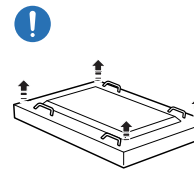

Lay the product down to handle it as shown in the image. (the packaging can be used).

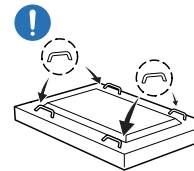

Ensure you use the handles on the back when moving the product.

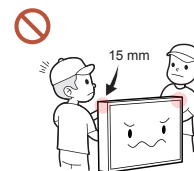

Do not hold or grasp any area of the product within 15 mm from the front.

## Cleaning

### Warning



Do not spray water or cleaner directly on the product.

- The product's surface may be damaged, or the markings may be erased.
- An electric shock or fire may result.

### Caution

- ❗ When cleaning, be sure to disconnect the power plug and wipe gently with a soft and dry cloth such as superfine fibers or cotton flannels to prevent scratches.  
The product's surface may be damaged, or the markings may be erased.
- ❗ Be sure to use a soft and dry cloth such as superfine fibers or cotton flannels because the surface of the product and the screen display are vulnerable to scratches.  
The product's surface or the screen display can be easily scratched with foreign substances.
- ❗ Do not apply chemicals containing alcohol, solvent, or surfactant such as wax, benzene, thinner, pesticide, air freshener, lubricant, or cleaner to the product.  
The product's exterior may be discolored or cracked, the surface of the panel may be peeled off, or the markings may be erased.

## Storage and Maintenance

### Cleaning the exterior and display

Wipe the surface with a slightly wet, soft cloth, and then wipe with a dry cloth.

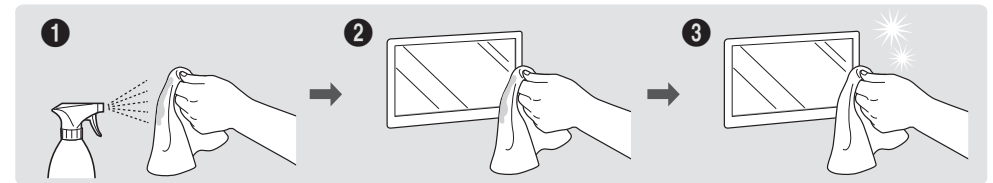

### Precautions



Do not scratch the screen with nails or sharp objects. Scratches may leave marks or damage the product.

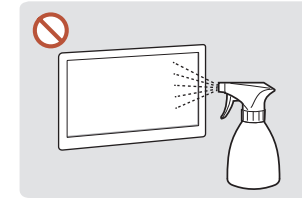

Do not spray water directly on any part of the product. Product failure, an electric shock or fire may result from water that enters the product.

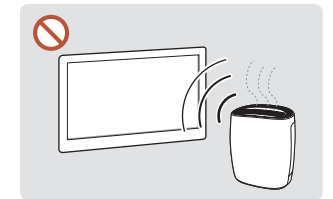

Due to the characteristics of high-glossy products, using a UV humidifier nearby may create white-colored stains on the product.

- Removing a sticker attached on the screen may leave residues. Clean the residues before watching the screen.
- Do not strongly press and rub the product. Damage to the product may result.
- Do not wipe the screen with chemicals. Product failure may result.
- Contact Samsung Customer Service Center if the inside of the product needs cleaning (service fee will be charged).
- We recommend wearing clean gloves when touching the front panel instead of bare hands.

# Chapter 02

## Preparations

### Checking the Components

- Contact the vendor where you purchased the product if any components are missing.
- The appearance of the components may differ from the images shown.
- A stand is not provided with the product. To install a stand, you can purchase one separately.
- The RS232C adapter can be used to connect to another monitor using the D-SUB (9-pin) type RS232C cable.

#### Components

- Components may differ in different locations.

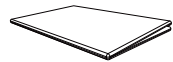

Quick Setup Guide



Warranty card  
(Not available in some locations)



Regulatory guide



Power cord

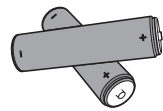

Batteries (AAA x 2)  
(Not available in some locations)



Remote Control

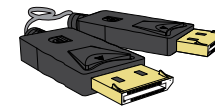

DP cable

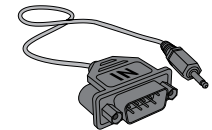

RS232C adapter



Wall Mount Adapter x 4 / Screw  
x 4

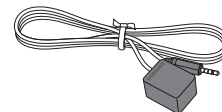

External IR cable  
(Not available in some locations)

# Parts

## Reverse Side

— The color and shape of parts may differ from what is shown. Specifications are subject to change without notice to improve quality.

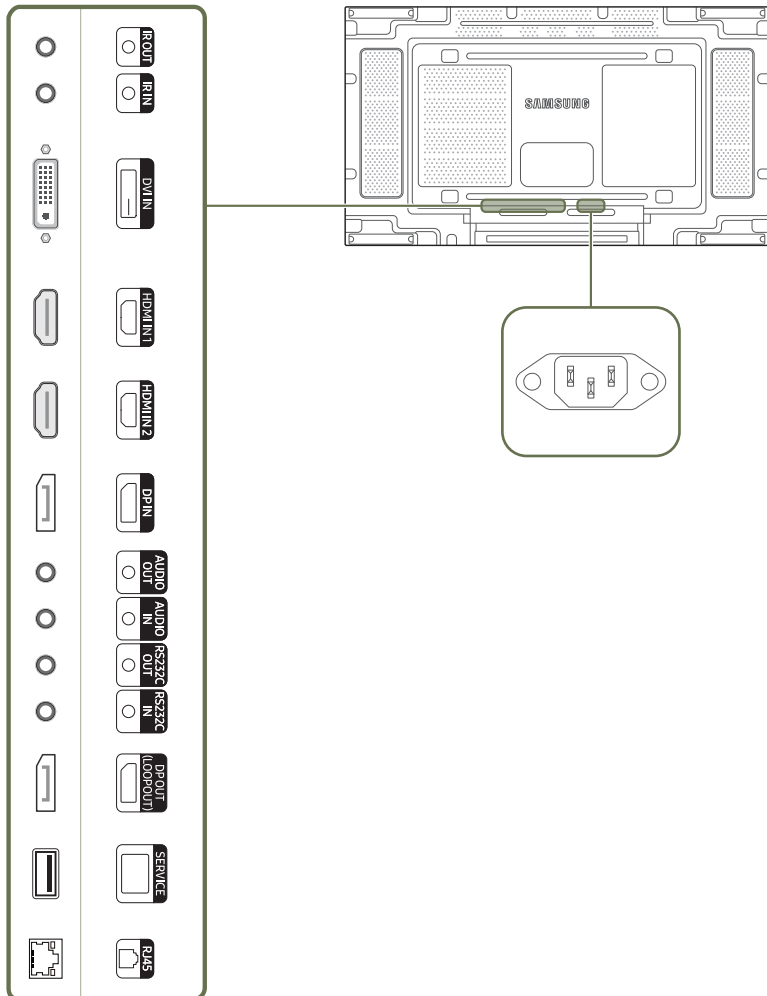

Port	Description
IR OUT	Receives the remote control signal via the external sensor board and outputs the signal via LOOP OUT.
IR IN	Supplies power to the external sensor board or receives the light sensor signal.
DVI IN	Connects to a source device using a DVI cable or HDMI-DVI cable.
HDMI IN1, HDMI IN 2	Connects to a source device using an HDMI cable.
DP IN	Connects to a PC using a DP cable.
AUDIO OUT	Outputs sound to an audio device via an audio cable.
AUDIO IN	Receives sound from a source device via an audio cable.
RS232C OUT	Connects to multiple products using a serial cable. — The serial cable is not provided with the product. Contact your vendor for purchase.
RS232C IN	Connects to MDC using an RS232C adapter.
DP OUT (LOOPOUT)	Connects to another product using a DP cable. — When connecting monitors through DP Loopout, using the DP cable that came with the package is recommended. — This port uses an algorithm that is specific to UHD resolution input and output. The port is not compatible with monitors that have FHD content-specific DP Loopout ports. Connecting Loopout ports between monitors of the same model is recommended.
SERVICE	Dedicated to service technicians.
RJ45	Connects to MDC using a LAN cable. (10/100 Mbps)

# Remote Control

- Using other display devices in the same space as the remote control of this product can cause the other display devices to be inadvertently controlled.
- A button without a description in the image below is not supported on the product.

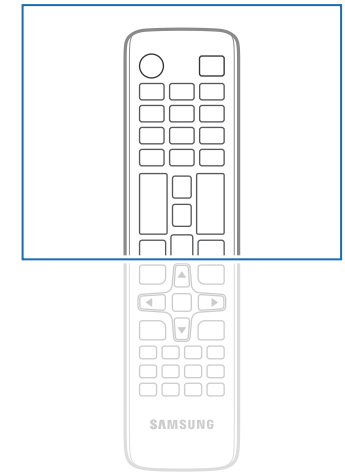
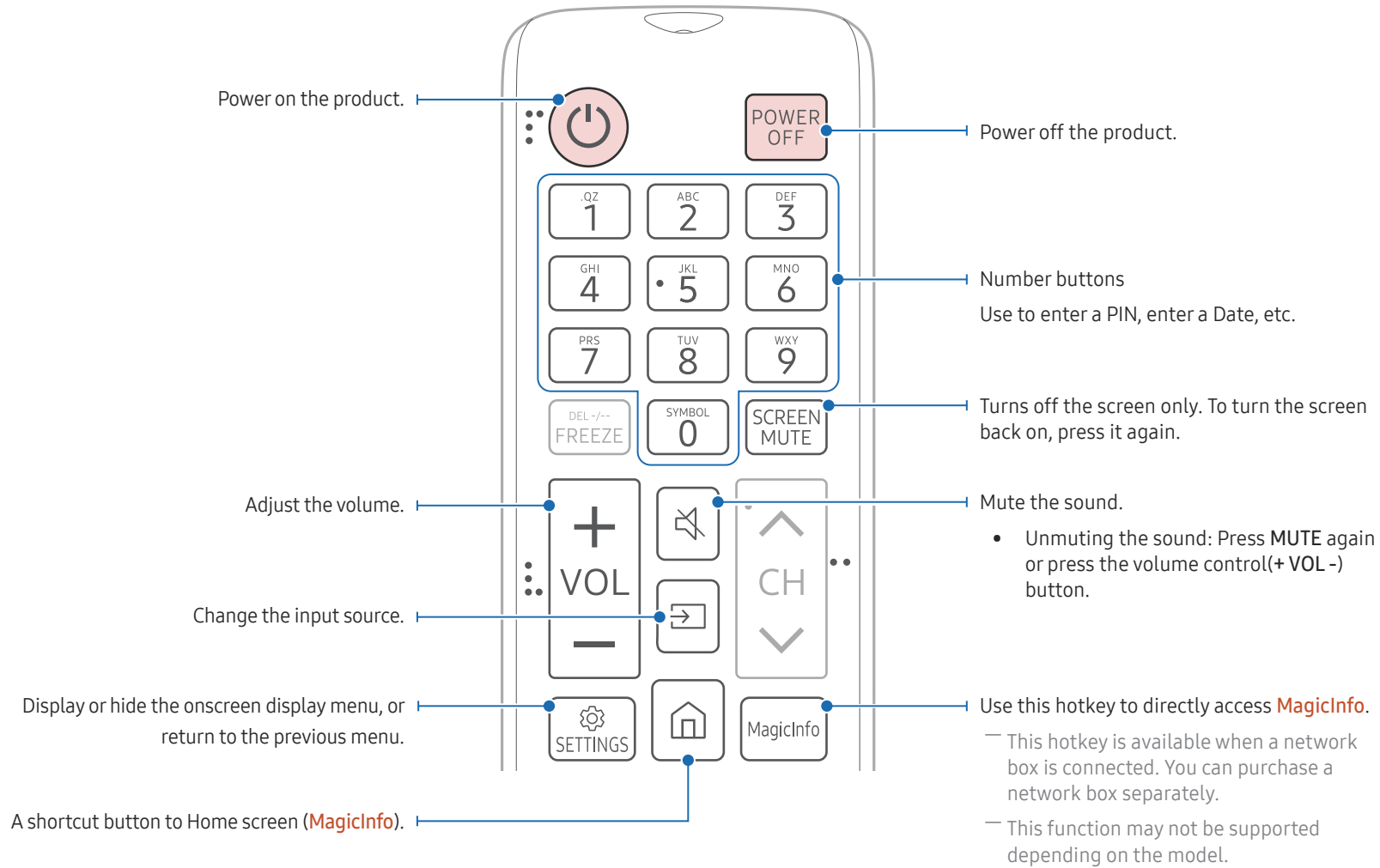

– Remote control button functions may differ for different products.

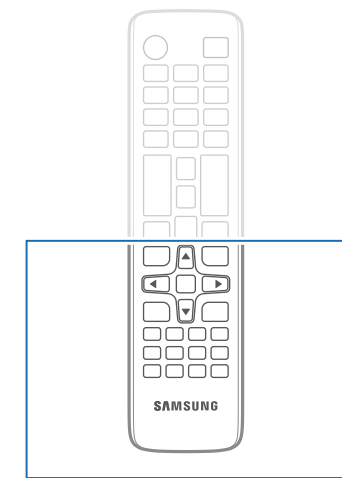
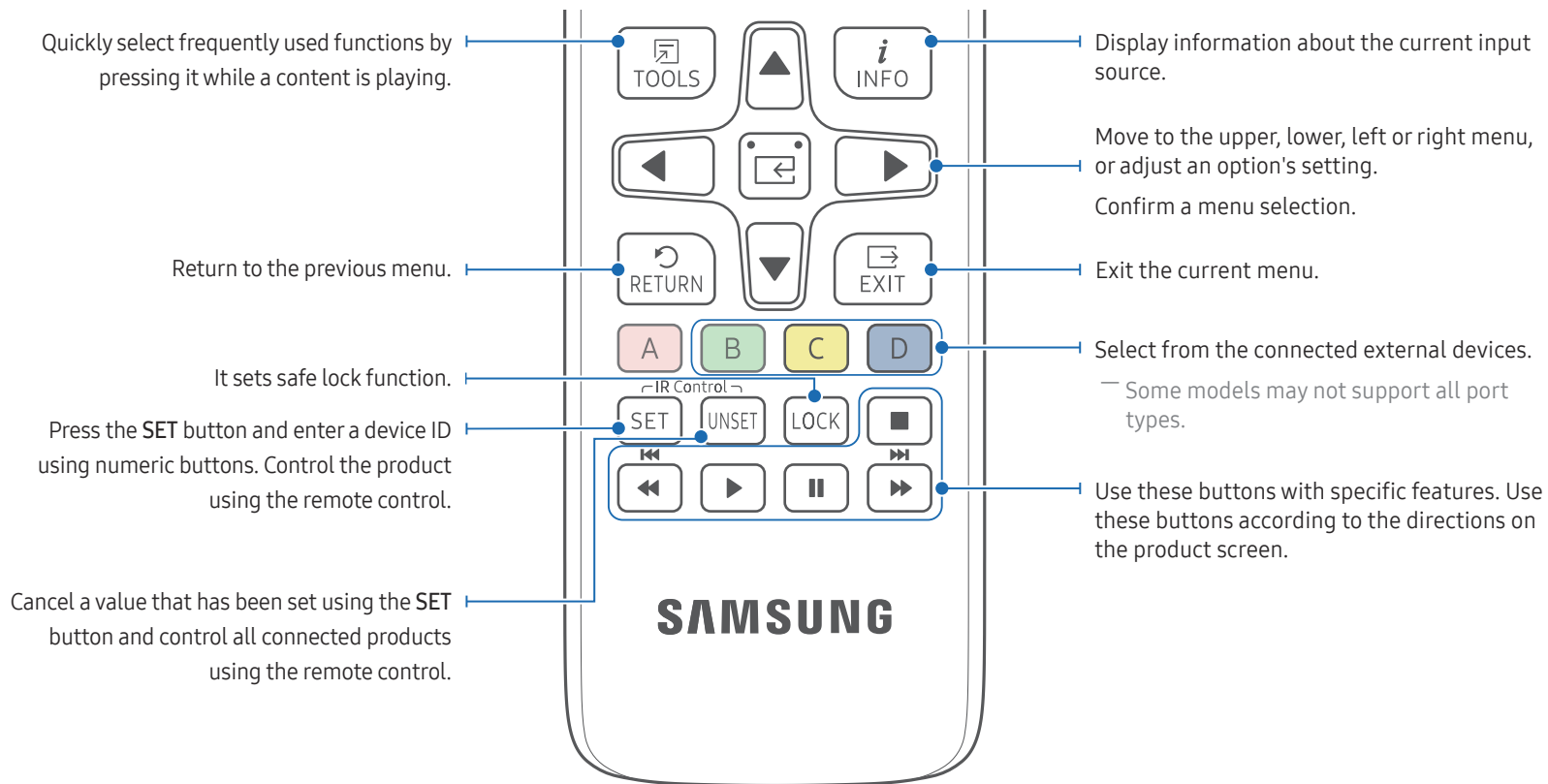

– Remote control button functions may differ for different products.

### To place batteries in the remote control (AAA x 2)

– Remove batteries when the remote control is not to be used for an extended period of time.

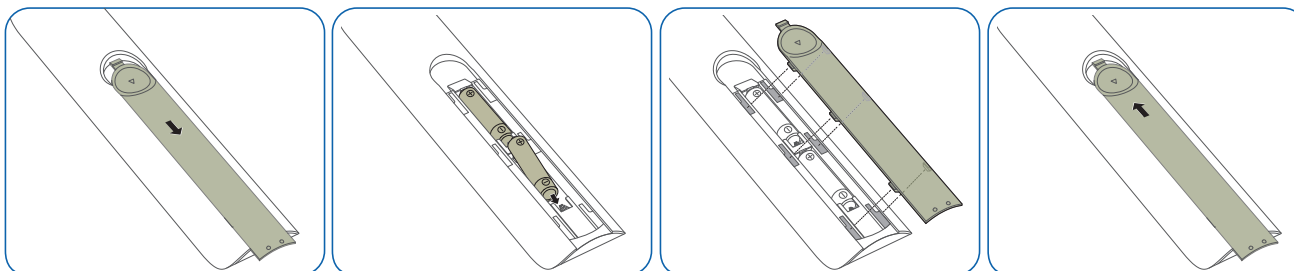

## Connection Using an IR Stereo Cable (sold separately)

Make sure to connect the External IR cable while the product is powered off. Then, power on the product.

### Controlling more than one display product using your remote control

- Connect the IR OUT port on the product to the IR IN port on the other display product using the dedicated stereo cable.
- A command sent from the remote control pointed at product ① will be received by both display products ① and ②.

— The appearance may differ depending on the product.

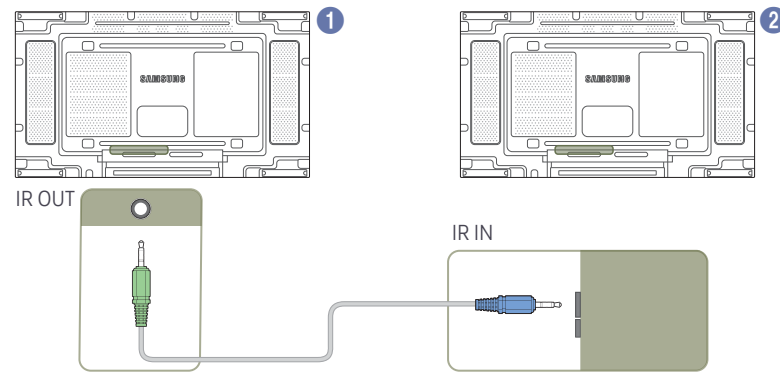

### Controlling more than one display product using an External IR cable

- A command sent from the remote control pointed at product ① (to which the External IR cable is connected) will be received by both display products ① and ②.

— The appearance may differ depending on the product.

— The external IR cable can be placed on the side of the product as long as the cable length permits.

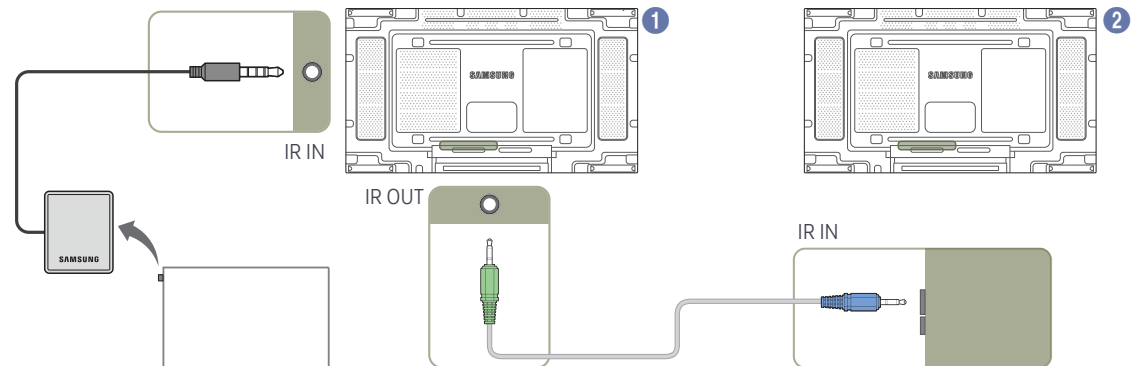

## Before Installing the Product (Installation Guide)

To prevent injury, this apparatus must be securely attached to the floor/wall in accordance with the installation instructions.

- Ensure that an authorized installation company installs the wall mount.
- Otherwise, it may fall and cause personal injury.
- Make sure to install the specified wall mount.

## Switching between portrait and landscape

— Contact Samsung Customer Service Center for further details.

- To use the product in portrait orientation, rotate it clockwise.

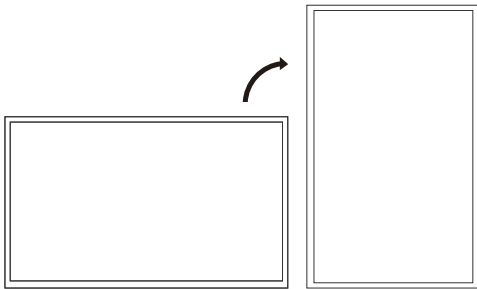

— Do not use this model installed on a ceiling, floor, or table.

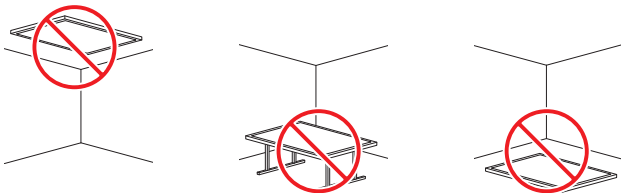

## Ventilation

— Contact Samsung Customer Service Center for further details.

### Installation on a Perpendicular Wall

A Minimum 40 mm

B Ambient temperature: Under 35°C

- When installing the product on a perpendicular wall, allow at least 40 mm of space between the product and wall surface for ventilation and ensure that the ambient temperature is kept below 35°C.

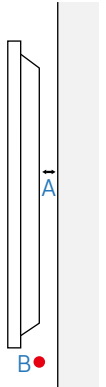

## Installing the Wall Mount

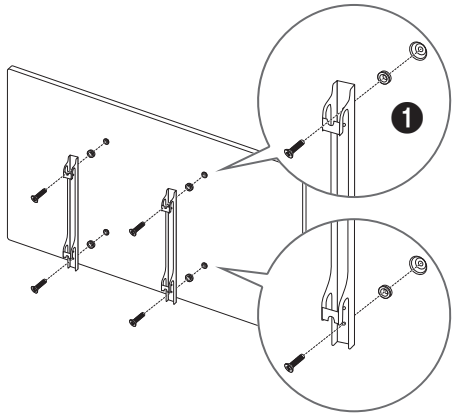

### Preparing before installing Wall-Mount

Use the Wall Mount Adapter (1) to install the wall mount.

### Installing the Wall Mount

The wall mount kit (sold separately) allows you to mount the product on the wall.

For detailed information on installing the wall mount, see the instructions provided with the wall mount.

We recommend you contact a technician for assistance when installing the wall mount bracket.

Samsung is not responsible for any damage to the product or injury to yourself or others if you select to install the wall mount on your own.

In order to respond to ADA compliance, it is necessary to use a wall mount that is compatible with our products and satisfies a thickness of 30 mm or less.

ex) RXT's \*\* product

SAMSUNG MAKES NO WARRANTIES OR REPRESENTATIONS AS TO THE PERFORMANCE OF ANY THIRD PARTY PRODUCTS, INCLUDING BUT NOT LIMITED TO WALL MOUNTS.

SAMSUNG EXPRESSLY DISCLAIMS ANY REPRESENTATION OR WARRANTY, TO PURCHASER OR ANY OTHER PERSON, WITH RESPECT TO THIRD PARTY PRODUCTS, INCLUDING BUT NOT LIMITED TO, THE IMPLIED WARRANTIES OF MERCHANTABILITY AND FITNESS FOR A PARTICULAR PURPOSE.

## Wall Mount Kit Specifications (VESA)

— Install your wall mount on a solid wall perpendicular to the floor. Before attaching the wall mount to surfaces other than plaster board, please contact your nearest dealer for additional information.

If you install the product on a slanted wall, it may fall and result in severe personal injury.

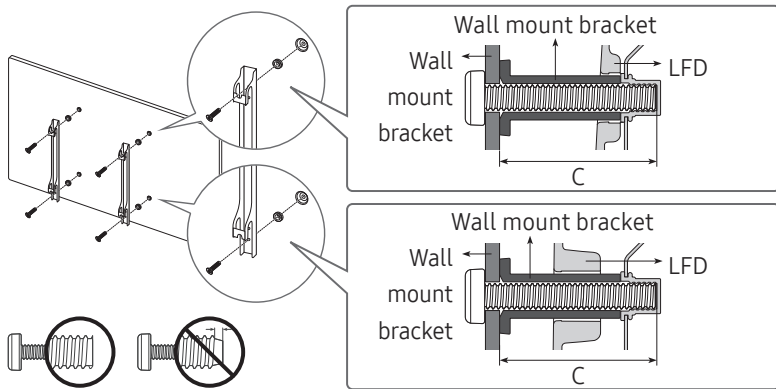

- Samsung wall mount kits contain a detailed installation manual and all parts necessary for assembly are provided.
- Do not use screws that are longer than the standard length or do not comply with the VESA standard screw specifications. Screws that are too long may cause damage to the inside of the product.
- For wall mounts that do not comply with the VESA standard screw specifications, the length of the screws may differ depending on the wall mount specifications.
- Do not fasten the screws too firmly. This may damage the product or cause the product to fall, leading to personal injury. Samsung is not liable for these kinds of accidents.
- Samsung is not liable for product damage or personal injury when a non-VESA or non-specified wall mount is used or the consumer fails to follow the product installation instructions.
- Always have two people mount the product on a wall.
- Do not mount the product at more than a 15 degree tilt.
- Standard dimensions for wall mount kits are shown in the table below.

Unit: mm

VESA screw hole specs (A \* B) C (mm) Standard Screw Quantity

600 x 400

8 ~ 15

M8

4

— Do not install your Wall Mount Kit while your product is turned on. It may result in personal injury due to electric shock.

# Chapter 03

## Connecting and Using a Source Device

### Before Connecting

#### Pre-connection Checkpoints

- Refer to the user guide for the source device you want to connect with.  
The number and location of ports available on the source device may vary.
- Do not connect the power cord until all connections are completed.  
Connecting the power cord during connection may damage the product.
- Check the types of ports at the back of the product you want to connect.
- We recommend using authorized cables for HDMI or DP cable connections.

### Connecting to a PC

- Do not connect the power cord before connecting all other cables.  
Ensure you connect a source device first before connecting the power cord.
- A PC can be connected to the product in a variety of ways.  
Select a connection method suitable for your PC.

#### Connection using a DVI cable (Digital type)

- Connecting parts may differ in different products.

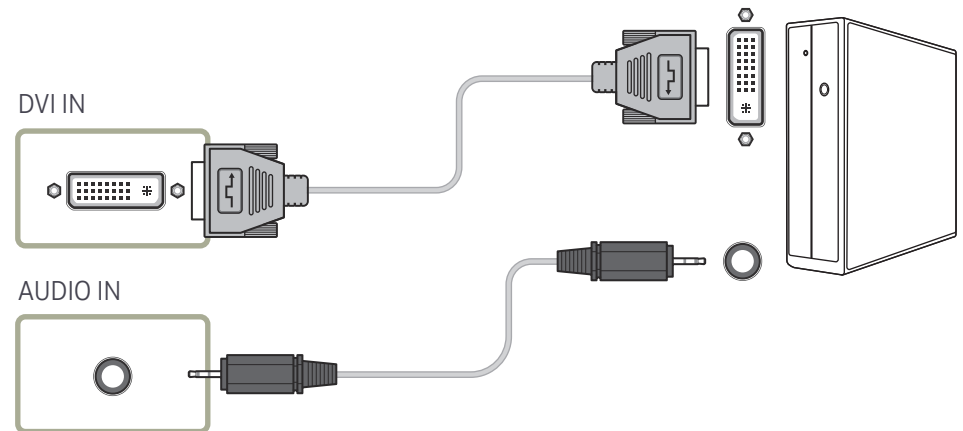

## Connection Using an HDMI-DVI Cable

— Connecting parts may differ in different products.

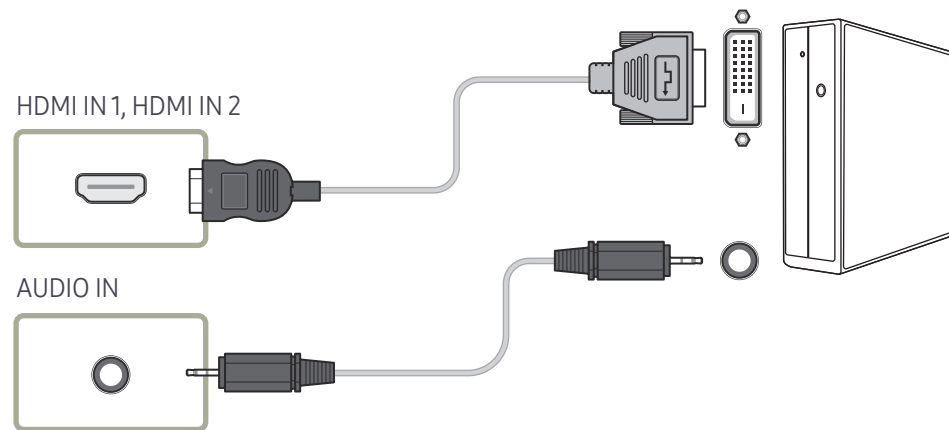

## Connection Using an HDMI Cable

— Connecting parts may differ in different products.

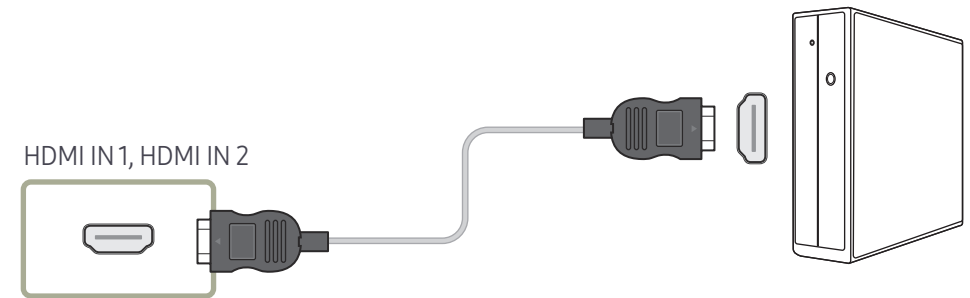

---

## Connection Using an DP Cable

— Connecting parts may differ in different products.

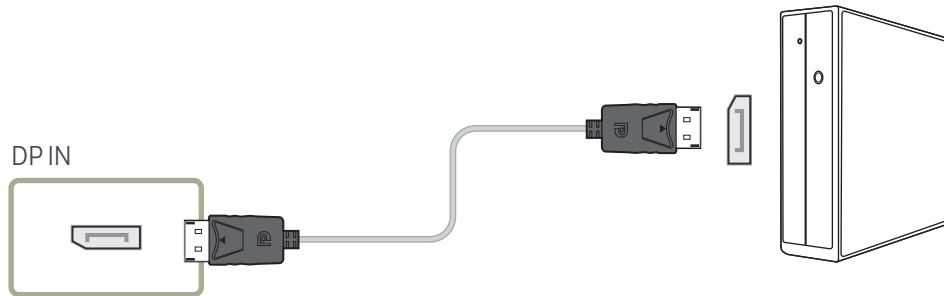

- Precautions for using DP

- To increase the standby power capacity, the product stops DP communication when it is turned off or in power-saving mode.
- If the product in dual monitor mode is turned off or goes into power-saving mode, monitor setting changes may not be updated. As a result, screen output may not be displayed properly.
- Some graphics cards that are not compliant with the DP standard may prevent the Windows Booting/Bios screen from being displayed when the product is in power-saving mode. If this is the case, make sure to turn on the product first before turning on your PC.
- The DisplayPort interface (DP IN) on the product and the provided DP cable are designed based on the VESA standards. Using a DP cable that is not VESA compliant may cause the product to function improperly. Samsung shall not be held responsible for any issues from using a cable that is not VESA compliant.  
Make sure to use a DP cable that is VESA compliant.

## Connecting to a Video Device

- Do not connect the power cord before connecting all other cables.  
Ensure you connect a source device first before connecting the power cord.
- You can connect a video device to the product using a cable.
  - Press the SOURCE button on the remote control to change the source.

## Connection Using an HDMI-DVI Cable

- Audio will not be enabled if the product is connected to a video device using an HDMI-DVI cable. To resolve this, additionally connect an audio cable to the audio ports on the product and video device.
- Supported resolutions include 1080p (50/60Hz), 720p (50/60Hz), 480p, and 576p.
- Make sure to connect the same color connectors together. (white to white, red to red, etc.)
- Connecting parts may differ in different products.

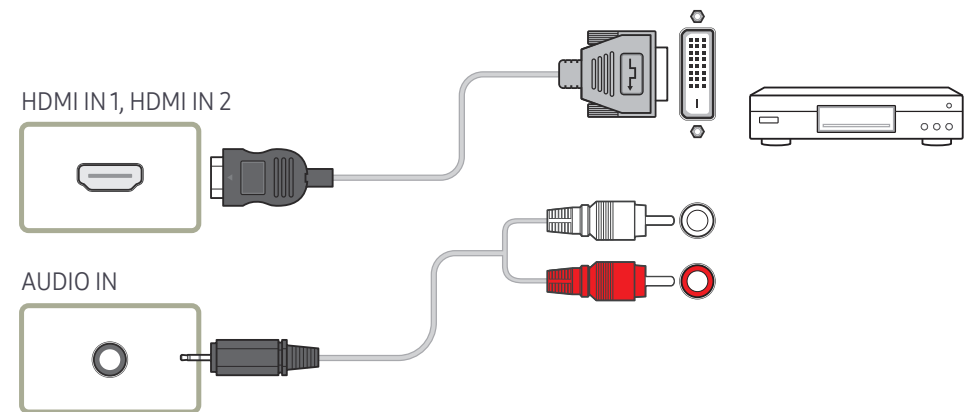

## Connection Using an HDMI Cable

— Connecting parts may differ in different products.

### Using an HDMI cable or HDMI to DVI Cable (up to 1080p)

- For better picture and audio quality, connect to a digital device using an HDMI cable.
- An HDMI cable supports digital video and audio signals, and does not require an audio cable.
  - To connect the product to a digital device that does not support HDMI output, use an HDMI-DVI and audio cables.
- The picture may not display normally (if at all) or the audio may not work if an external device that uses an older version of HDMI mode is connected to the product. If such a problem occurs, ask the manufacturer of the external device about the HDMI version and, if out of date, request an upgrade.
- Be sure to use an HDMI cable with a thickness of 14 mm or less.
- Be sure to purchase a certified HDMI cable. Otherwise, the picture may not display or a connection error may occur.
- A basic high-speed HDMI cable or one with ethernet is recommended.  
This product does not support the ethernet function via HDMI.

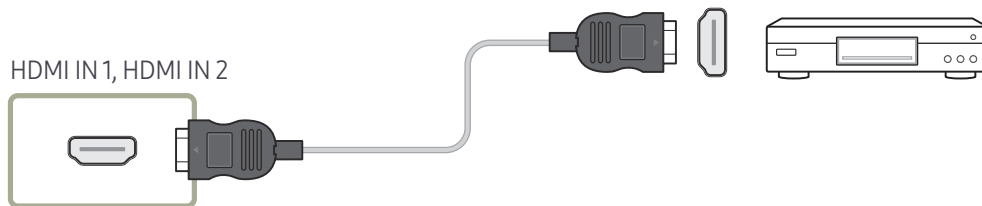

## Connecting to an Audio System

— Connecting parts may differ in different products.

— Make sure to connect the same color connectors together. (white to white, red to red, etc.)

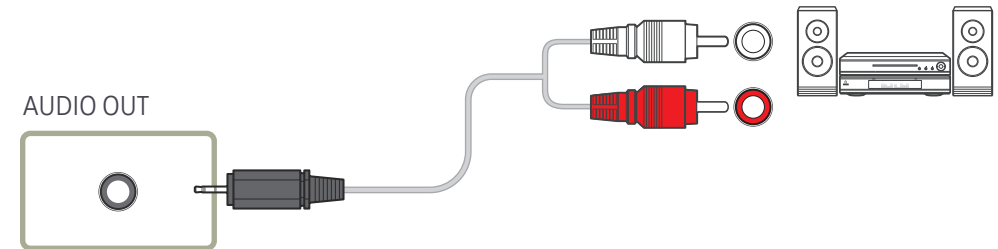

---

## Connecting the LAN Cable

— Connecting parts may differ in different products.

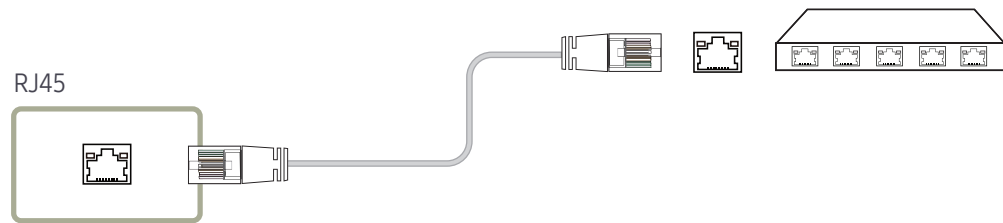

- Use Cat7(\*STP Type) cable for the connection.  
\*STP: Shielded Twisted Pair

# Changing the Input source

## Source

SOURCE → Source

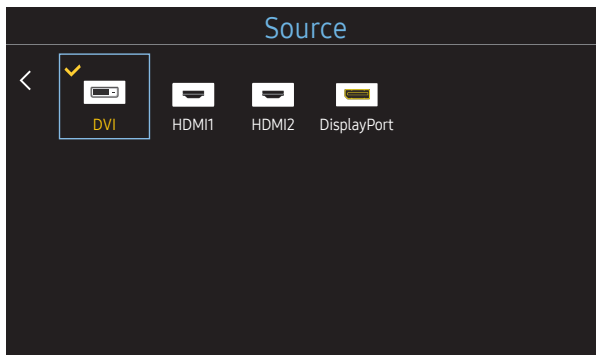

– The displayed image may differ depending on the model.

**Source** allows you to select a variety of sources and change source device names.

You can display the screen of a source device connected to the product. Select a source from source list to display the screen of the selected source.

- The input source can also be changed by using the **SOURCE** button on the remote control.
- The screen may not display correctly if an incorrect source is selected for the source device you want to convert to.

### Edit Name

SOURCE → Source → TOOLS → Edit Name → ENTER 

Sometimes the screen will not display properly unless the name of a source device is specified in **Edit Name**.

In addition, it is best to rename the source device in **Edit Name** to obtain optimal picture quality.

- The list can include the following source devices. **Source** devices on the list differ depending on the selected source.  
**VCR / DVD / Cable STB / HD STB / Satellite STB / AV Receiver / DVD Receiver / Game / Camcorder / DVD Combo / DHR / PC / DVI PC / DVI Devices**
- Available settings in the **Picture** menu depend on the current source and settings made in **Edit Name**.
  - When connecting a PC to the HDMI IN 1, HDMI IN 2 port, set **Edit Name** to **PC**. In other cases, set **Edit Name** to AV devices.
  - When connecting a PC to the HDMI IN 1, HDMI IN 2 port with HDMI to DVI cable, you should set the product to **DVI PC** mode under **Edit Name**.
  - When connecting an AV devices to the HDMI IN 1, HDMI IN 2 port with HDMI to DVI cable, you should set the product to **DVI Devices** mode under **Edit Name**.

# Chapter 04

## Multiple Display Control

Control multiple display devices connected to a PC simultaneously.

### Cable Connection

#### RS232C Cable

Interface	RS232C (9 pins)
Pin	TxD (No.2), RxD (No.3), GND (No.5)
Bit rate	9600 bps
Data bits	8 bit
Parity	None
Stop bit	1 bit
Flow control	None
Maximum length	15 m (only shielded type)

- Pin assignment

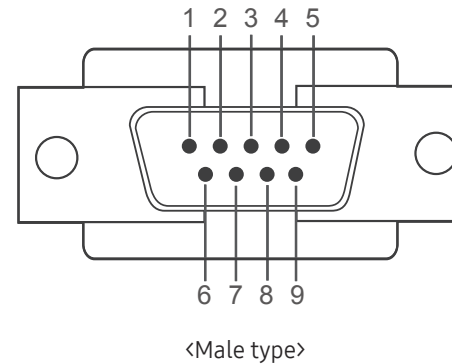

Pin	Signal
1	Detect data carrier
2	Received data
3	Transmitted data
4	Prepare data terminal
5	Signal ground

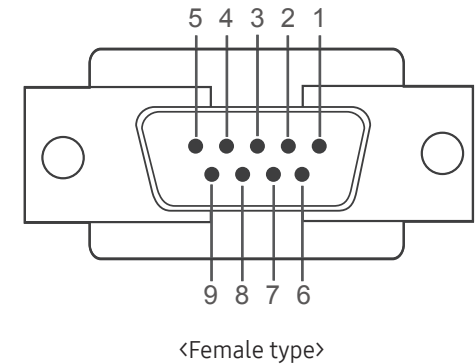

Pin	Signal
6	Prepare data set
7	Send request
8	Clear to send
9	Ring indicator

- RS232C cable  
Connector: 9-Pin D-Sub to Stereo Cable

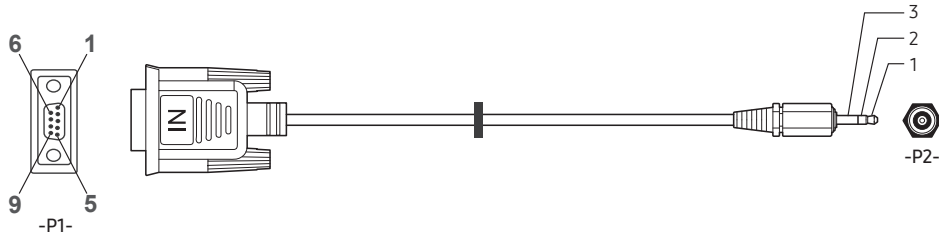

		-P1-		-P2-		-P2-
Male type	Rx	2	↔	1	Tx	STEREO
	Tx	3	↔	2	Rx	PLUG
	Gnd	5	↔	3	Gnd	(3.5ø)

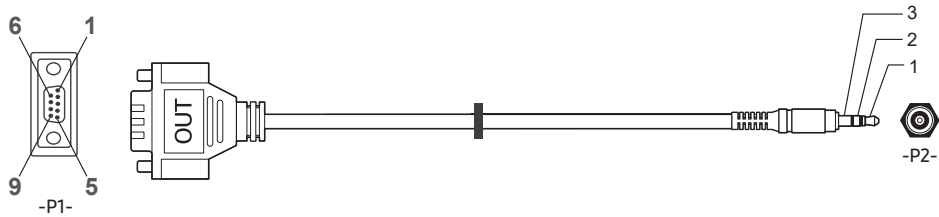

		-P1-		-P2-		-P2-
Female type	Rx	3	↔	1	Tx	STEREO
	Tx	2	↔	2	Rx	PLUG
	Gnd	5	↔	3	Gnd	(3.5ø)

## LAN Cable

- Pin assignment

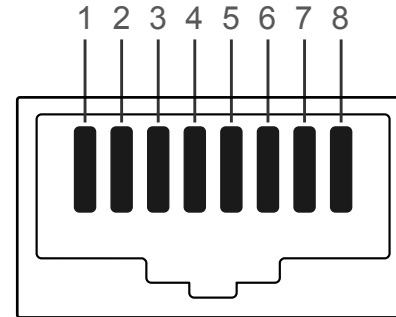

Pin No	Standard Color	Signal
1	White and orange	TX+
2	Orange	TX-
3	White and green	RX+
4	Blue	NC
5	White and blue	NC
6	Green	RX-
7	White and brown	NC
8	Brown	NC

— This function may differ depending on the model.

- Connector : RJ45

### Direct LAN cable (PC to HUB)

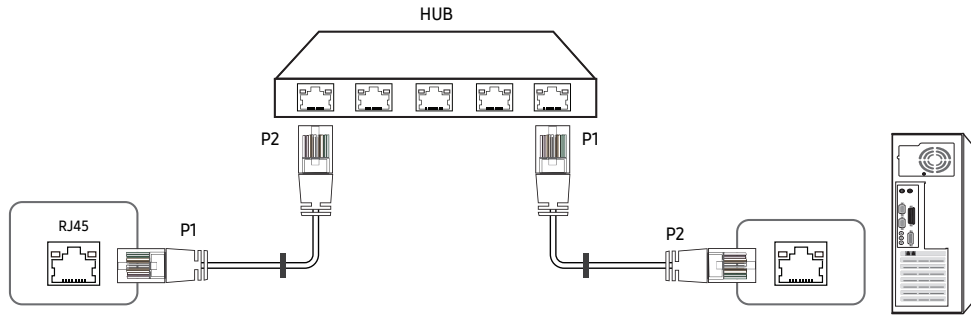

Signal	P1		P2	Signal
TX+	1	↔	1	TX+
TX-	2	↔	2	TX-
RX+	3	↔	3	RX+
RX-	6	↔	6	RX-

### Cross LAN cable (PC to LFD)

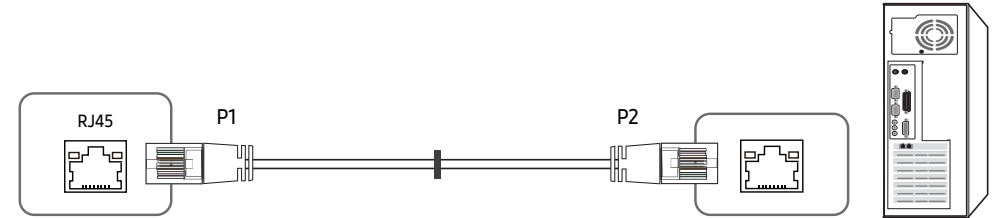

Signal	P1		P2	Signal
TX+	1	↔	3	RX+
TX-	2	↔	6	RX-
RX+	3	↔	1	TX+
RX-	6	↔	2	TX-

# Connection

— Ensure you connect each of the adapters to the correct RS232C IN or OUT port on the product.

- Connection 1

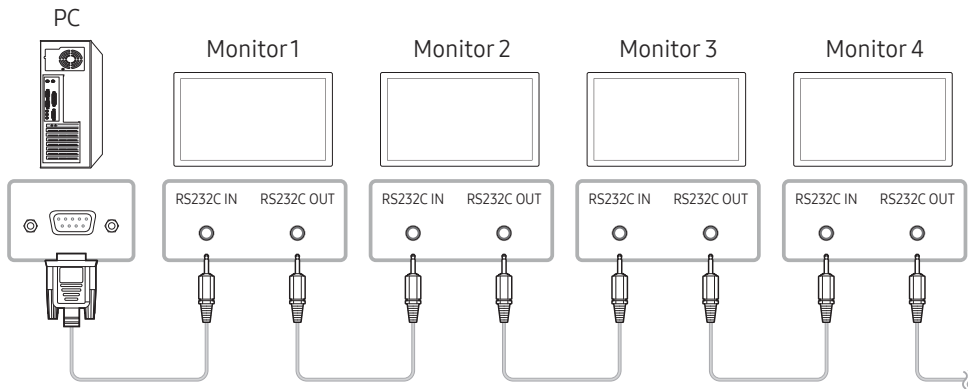

- Connection 2

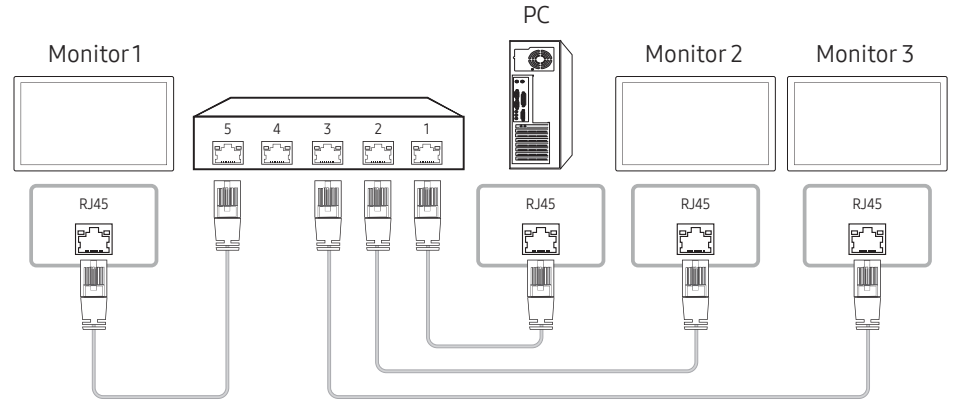

- Connection 3

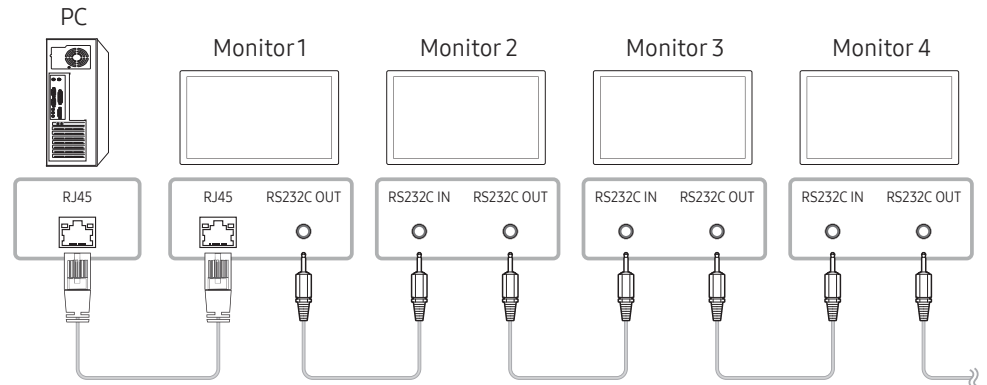

## Control Codes

### Viewing control state (Get control command)

Header	Command	ID	Data length	Checksum
0xAA	Command type		0	

### Controlling (Set control command)

Header	Command	ID	Data length	Data	Checksum
0xAA	Command type		1	Value	

### Command

No.	Command type	Command	Value range
1	Power control	0x11	0~1
2	Volume control	0x12	0~100
3	Input source control	0x14	-
4	Screen size control	0x19	0~255
5	Video wall mode control	0x5C	0~1
6	Safety Lock	0x5D	0~1
7	Video Wall On	0x84	0~1
8	Video Wall User Control	0x89	-

- All communications take place in hexadecimals. The checksum is calculated by adding up all values except the header. If a checksum adds up to be more than 2 digits as shown below ( $11+FF+01+01=112$ ), the first digit is removed.

E.g. Power On & ID=0

Header	Command	ID	Data length	Data 1	Checksum
0xAA	0x11		1	"Power"	

Header	Command	ID	Data length	Data 1	Checksum
0xAA	0x11		1	1	12

- To control all devices connected by a serial cable simultaneously irrespective of IDs, set the ID as "0xFE" and transmit commands. Commands will be executed by each device but ACK will not respond.

## Power control

- Function  
A product can be powered on and off using a PC.
- Viewing power state (Get Power ON / OFF Status)

Header	Command	ID	Data length	Checksum
0xAA	0x11		0	

- Setting power ON/Off (Set Power ON / OFF)

Header	Command	ID	Data length	Data	Checksum
0xAA	0x11		1	"Power"	

"Power": Power code to be set on a product.

1: Power ON

0: Power OFF

- Ack

Header	Command	ID	Data length	Ack/Nak	r-CMD	Val1	Checksum
0xAA	0xFF		3	'A'	0x11	"Power"	

"Power": Power code to be set on a product.

- Nak

Header	Command	ID	Data length	Ack/Nak	r-CMD	Val1	Checksum
0xAA	0xFF		3	'N'	0x11	"ERR"	

"ERR" : A code showing what error has occurred.

## Volume control

- Function  
The volume of a product can be adjusted using a PC.
- Viewing volume state (Get Volume Status)

Header	Command	ID	Data length	Checksum
0xAA	0x12		0	

- Setting the volume (Set Volume)

Header	Command	ID	Data length	Data	Checksum
0xAA	0x12		1	"Volume"	

"Volume": Volume value code to be set on a product. (0-100)

- Ack

Header	Command	ID	Data length	Ack/Nak	r-CMD	Val1	Checksum
0xAA	0xFF		3	'A'	0x12	"Volume"	

"Volume": Volume value code to be set on a product. (0-100)

- Nak

Header	Command	ID	Data length	Ack/Nak	r-CMD	Val1	Checksum
0xAA	0xFF		3	'N'	0x12	"ERR"	

"ERR" : A code showing what error has occurred.

## Input source control

- Function  
The input source of a product can be changed using a PC.
- Viewing input source state (Get Input Source Status)

Header	Command	ID	Data length	Checksum
0xAA	0x14		0	

- Setting the input source (Set Input Source)

Header	Command	ID	Data length	Data	Checksum
0xAA	0x14		1	"Input Source"	

"Input Source": An input source code to be set on a product.

0x14	PC
0x18	DVI
0x0C	Input source
0x08	Component
0x1F	DVI_video
0x30	RF(TV)
0x40	DTV
0x21	HDMI1
0x22	HDMI1_PC
0x23	HDMI2

0x24	HDMI2_PC
0x25	DisplayPort

— DVI\_video, HDMI1\_PC and HDMI2\_PC cannot be used with the Set command. They only respond to "Get" commands.

— This model does not support HDMI1\_PC and HDMI2\_PC ports.

— RF(TV), DTV are only available with models that include a TV.

- Ack

Header	Command	ID	Data length	Ack/Nak	r-CMD	Val1	Checksum
0xAA	0xFF		3	'A'	0x14	"Input Source"	

"Input Source": An input source code to be set on a product.

- Nak

Header	Command	ID	Data length	Ack/Nak	r-CMD	Val1	Checksum
0xAA	0xFF		3	'N'	0x14	"ERR"	

"ERR" : A code showing what error has occurred.

## Screen size control

- Function  
The screen size of a product can be changed using a PC.
- Viewing the screen size (Get Screen Size Status)

Header	Command	ID	Data length	Checksum
0xAA	0x19		0	

- Ack

Header	Command	ID	Data length	Ack/Nak	r-CMD	Val1	Checksum
0xAA	0xFF		3	'A'	0x19	"Screen Size"	

"Screen Size": product screen size (range: 0 – 255, unit: inch)

- Nak

Header	Command	ID	Data length	Ack/Nak	r-CMD	Val1	Checksum
0xAA	0xFF		3	'N'	0x19	"ERR"	

"ERR": A code showing what error has occurred

## Video Wall Mode Control

- Function  
**Video Wall** mode can be activated on a product using a PC.  
This control is only available on a product whose **Video Wall** is enabled.
- Viewing video wall mode (Get Video Wall Mode)

Header	Command	ID	Data length	Checksum
0xAA	0x5C		0	

- Setting the video wall (Set Video Wall Mode)

Header	Command	ID	Data length	Data	Checksum
0xAA	0x5C		1	"Video Wall Mode"	

"Video Wall Mode": A code used to activate Video Wall mode on a product

1: **Full**

0: **Natural**

- Ack

Header	Command	ID	Data length	Ack/Nak	r-CMD	Val1	Checksum
0xAA	0xFF		3	'A'	0x5C	"Video Wall Mode"	

"Video Wall Mode": A code used to activate Video Wall mode on a product

- Nak

Header	Command	ID	Data length	Ack/Nak	r-CMD	Val1	Checksum
0xAA	0xFF		3	'A'	0x5C	"ERR"	

"ERR": A code showing what error has occurred

## Safety Lock

- Function  
PC can be used to turn the **Safety Lock** function on or off on a product.  
This control is available regardless of whether or not the power is turned on.
- Viewing the safety lock state (Get Safety Lock Status)

Header	Command	ID	Data length	Checksum
0xAA	0x5D		0	

- Enabling or disabling safety lock (Set Safety Lock Enable / Disable)

Header	Command	ID	Data length	Data	Checksum
0xAA	0x5D		1	"Safety Lock"	

"Safety Lock": Safety lock code to be set on a product

1: ON

0: OFF

- Ack

Header	Command	ID	Data length	Ack/Nak	r-CMD	Val1	Checksum
0xAA	0xFF		3	'A'	0x5D	"Safety Lock"	

"Safety Lock": Safety lock code to be set on a product

- Nak

Header	Command	ID	Data length	Ack/Nak	r-CMD	Val1	Checksum
0xAA	0xFF		3	'N'	0x5D	"ERR"	

"ERR": A code showing what error has occurred

## Video Wall On

- Function  
Turn Video Wall on or off on the product from your computer.
- Get Video Wall On/Off Status

Header	Command	ID	Data length	Checksum
0xAA	0x84		0	

- Set Video Wall On/Off

Header	Command	ID	Data length	Data	Checksum
0xAA	0x84		1	V.Wall_On	

- V.Wall\_On: Video Wall code to be assigned to the product

1: Video Wall ON

0: Video Wall OFF

- Ack

Header	Command	ID	Data length	Ack/Nak	r-CMD	Val1	Checksum
0xAA	0xFF		3	'A'	0x84	V.Wall_On	

V.Wall\_On : Same as above

- Nak

Header	Command	ID	Data length	Ack/Nak	r-CMD	Val1	Checksum
0xAA	0xFF		3	'N'	0x84	ERR	

"ERR": A code showing what error has occurred

## Video Wall User Control

- **Function**  
Turn the Video Wall function on or off on the product from your computer.
- **Get Video Wall Status**

Header	Command	ID	Data length	Checksum
0xAA	0x89		0	

- **Set Video Wall**

Header	Command	ID	Data length	Val1	Val2	Checksum
0xAA	0x89		2	Wall_Div	Wall_SNo	

Wall\_SNo: Product Number code assigned to the product

### 10x10 Video Wall Model : ( 1 ~ 100)

Set Number	Data
1	0x01
2	0x02
...	...
99	0x63
100	0x64

- **Ack**

Header	Command	ID	Data length	Ack/Nak	r-CMD	Val1	Val2	Checksum
0xAA	0xFF		4	'A'	0x89	Wall_Div	Wall_SNo	

- **Nak**

Header	Command	ID	Data length	Ack/Nak	r-CMD	Val1	Checksum
0xAA	0xFF		3	'N'	0x89	ERR	

"ERR": A code showing what error has occurred

Wall\_Div: Video Wall Divider code assigned to the product

### 10x10 Video Wall Model

	1	2	3	4	5	6	7	8	9	10	11	12	13	14	15
Off	0x00	0x00	0x00	0x00	0x00	0x00	0x00	0x00	0x00	0x00	0x00	0x00	0x00	0x00	0x00
1	0x11	0x12	0x13	0x14	0x15	0x16	0x17	0x18	0x19	0x1A	0x1B	0x1C	0x1D	0x1E	0x1F
2	0x21	0x22	0x23	0x24	0x25	0x26	0x27	0x28	0x29	0x2A	0x2B	0x2C	0x2D	0x2E	0x2F
3	0x31	0x32	0x33	0x34	0x35	0x36	0x37	0x38	0x39	0x3A	0x3B	0x3C	0x3D	0x3E	0x3F
4	0x41	0x42	0x43	0x44	0x45	0x46	0x47	0x48	0x49	0x4A	0x4B	0x4C	0x4D	0x4E	0x4F
5	0x51	0x52	0x53	0x54	0x55	0x56	0x57	0x58	0x59	0x5A	0x5B	0x5C	0x5D	0x5E	0x5F
6	0x61	0x62	0x63	0x64	0x65	0x66	0x67	0x68	0x69	0x6A	0x6B	0x6C	0x6D	0x6E	0x6F
7	0x71	0x72	0x73	0x74	0x75	0x76	0x77	0x78	0x79	0x7A	0x7B	0x7C	0x7D	0x7E	N/A
8	0x81	0x82	0x83	0x84	0x85	0x86	0x87	0x88	0x89	0x8A	0x8B	0x8C	N/A	N/A	N/A
9	0x91	0x92	0x93	0x94	0x95	0x96	0x97	0x98	0x99	0x9A	0x9B	N/A	N/A	N/A	N/A
10	0xA1	0xA2	0xA3	0xA4	0xA5	0xA6	0xA7	0xA8	0xA9	0xAA	N/A	N/A	N/A	N/A	N/A
11	0xB1	0xB2	0xB3	0xB4	0xB5	0xB6	0xB7	0xB8	0xB9	N/A	N/A	N/A	N/A	N/A	N/A
12	0xC1	0xC2	0xC3	0xC4	0xC5	0xC6	0xC7	0xC8	N/A	N/A	N/A	N/A	N/A	N/A	N/A
13	0xD1	0xD2	0xD3	0xD4	0xD5	0xD6	0xD7	N/A	N/A	N/A	N/A	N/A	N/A	N/A	N/A
14	0xE1	0xE2	0xE3	0xE4	0xE5	0xE6	0xE7	N/A	N/A	N/A	N/A	N/A	N/A	N/A	N/A
15	0xF1	0xF2	0xF3	0xF4	0xF5	0xF6	N/A	N/A	N/A	N/A	N/A	N/A	N/A	N/A	N/A

---

## Using MDC

Multiple display control "MDC" is an application that allows you to easily control multiple display devices simultaneously using a PC.

For details on how to use the MDC program, refer to Help after installing the program. The MDC program is available on the website. (<http://www.samsung.com/business>)

- If you press the **On** or **Off** button located at the top left of the screen, the product checks its status for about one minute. To run other commands, try after the one minute.
- For details on how to connect devices for multiple display control, refer to [page 31](#).

## MDC Program Installation/Uninstallation

- Installing and uninstalling steps can vary depending on the OS.

### Installation

- MDC installation can be affected by the graphics card, mother board and network conditions.

- 1 Click the **MDC Unified** installation program.
- 2 Next, click **"OK"**.
- 3 When the **"Welcome to the InstallShield Wizard for MDC\_Unified"** screen appears, click **"Next"**.
- 4 In the **"License Agreement"** window displayed, select **"I accept the terms in the license agreement"** and click **"Next"**.
- 5 In the displayed **"Customer Information"** window, fill out all the information fields and click **"Next"**.

- 6 In the displayed **"Destination Folder"** window, select the directory path you want to install the program in and click **"Next"**.
  - If the directory path is not specified, the program will be installed in the default directory path.
- 7 In the displayed **"Ready to Install the Program"** window, check the directory path to install the program in and click **"Install"**.
- 8 Installation progress will be displayed.
- 9 Click **"Finish"** in the displayed **"InstallShield Wizard Complete"** window.
  - Select **"Launch the program"** and click **"Finish"** to run the MDC program immediately.
- 10 The **MDC Unified** shortcut icon will be created on the desktop after installation.
  - The MDC execution icon may not be displayed depending on the PC system or product specifications.
  - Press F5 if the execution icon is not displayed.

### Uninstallation

- 1 Select **Settings > Control Panel** on the **Start** menu and double-click **Add/Delete Program**.
- 2 Select **MDC Unified** from the list and click **Change/Remove**.

# Chapter 05

## Home feature

This feature is provided in [Support](#) → [Go to Home](#).

Accessible using the HOME button on the remote control.

### Video Wall

HOME  → [Video Wall](#) → ENTER 



– The displayed image may differ depending on the model.

Customize the layout of multiple displays that are connected to form a video wall.

In addition, display part of a whole picture or repeat the same picture on each of the connected multiple displays.

To display multiple images, refer to MDC Help or the MagicInfo user guide. Some models may not support the MagicInfo function.

### Video Wall

You can activate or deactivate [Video Wall](#).

To organize a video wall, select [On](#).

- [Off / On](#)

### Horizontal x Vertical

This feature automatically splits a videowall display based on a videowall matrix configuration.

Enter the videowall matrix.

The videowall display is split based on the configured matrix. The number of vertical or horizontal display devices can be set within the range 1 and 15.

- A videowall display can be split into a maximum of 225 screens.
- The [Horizontal x Vertical](#) option is only enabled when [Video Wall](#) is set to [On](#).

---

## Screen Position

To rearrange split screens, adjust the number for each product in the matrix using the **Screen Position** feature.

Selecting **Screen Position** will display the videowall matrix with the numbers assigned to the products that form the videowall.

To change the order of a display device, change the device number and press the  button.

- A maximum of 225 displays can be arranged in **Screen Position**.
- The **Screen Position** option is only enabled when **Video Wall** is set to **On**.
- To use the function, make sure **Horizontal x Vertical** is configured.

## Format

Select how to display images on the videowall display.

- **Full**: Display images in full screen.
- **Natural**: Display images in the original aspect ratio.
- The **Format** option is only enabled when **Video Wall** is set to **On**.
- When using **Video Wall** mode, a resolution of 1280x720P, 1920x1080P or 3840x2160P is recommended.

## On/Off Timer

HOME  → On/Off Timer → ENTER 

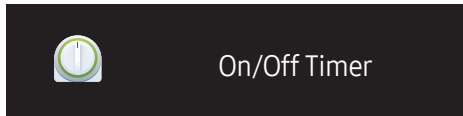

– The displayed image may differ depending on the model.

– You must set the clock before you can use **Clock Set**.

### On Timer

Set **On Timer** so that your product turns on automatically at a time and on a day of your choosing.

The power is turned on with the specified volume or input source.

**On Timer:** Set the on timer by making a selection from one of the seven options. Ensure you set the current time first.

(On Timer1 ~ On Timer7)

- **Setup:** Select **Off, Once, Everyday, Mon~Fri, Mon~Sat, Sat~Sun** or **Manual**.  
If you select **Manual**, you can choose the days you want **On Timer** to turn on your product.
  - The check mark indicates days you've selected.
- **Time:** Set the hour and minute. Use the number buttons or the up and down arrow keys to enter numbers. Use the left and right arrow buttons to change entry fields.
- **Volume:** Set the desired volume level. Use the left and right arrow buttons to change the volume level.
- **Source:** Select the input source of your choice.

### Off Timer

Set the off timer (**Off Timer**) by making a selection from one of the seven options. (**Off Timer1 ~ Off Timer7**)

- **Setup:** Select **Off, Once, Everyday, Mon~Fri, Mon~Sat, Sat~Sun** or **Manual**.  
If you select **Manual**, you can choose the days you want **Off Timer** to turn off your product.
  - The check mark indicates days you've selected.
- **Time:** Set the hour and minute. Use the number buttons or the up and down arrow keys to enter numbers. Use the left and right arrow buttons to change entry fields.

---

## Holiday Management

Timer will be disabled during a period specified as a holiday.

- **Add Holiday:** Specify the period you want to add as a holiday.  
Select the start and end dates of the holiday you want to add using the ▲/▼ buttons, and click the **Save** button.  
The period will be added to the list of holidays.
  - **Start:** Set the start date of the holiday.
  - **End:** Set the end date of the holiday.
- **Edit:** Select a holiday item and then change the date.
- **Delete:** Delete selected items from the list of holidays.
- **Set Applied Timer:** Set the **On Timer** and **Off Timer** to not activate on public holidays.
  - Press  to select the **On Timer** and **Off Timer** settings you do not want to activate.
  - The selected **On Timer** and **Off Timer** will not activate.

# Network Settings

HOME  → Network Settings → ENTER 

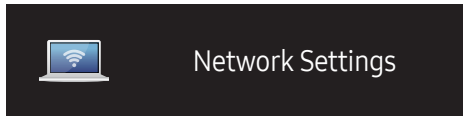

– The displayed image may differ depending on the model.

View the network settings.

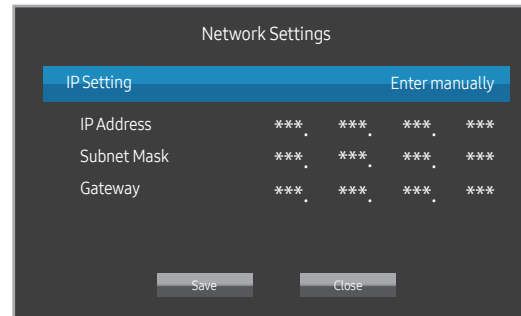

- **IP Setting:** Obtain automatically, Enter manually
- **IP Address:** Manually enter the **IP Address** if **IP Setting** is set to **Enter manually**.
- **Subnet Mask:** Manually enter the **Subnet Mask** if **IP Setting** is set to **Enter manually**.
- **Gateway:** Manually enter the **Gateway** if **IP Setting** is set to **Enter manually**.

# ID Settings

HOME  → ID Settings → ENTER 

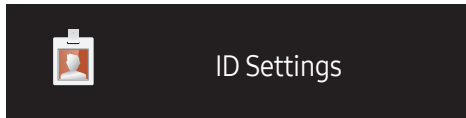

– The displayed image may differ depending on the model.

Assign an ID to a set.

## Device ID

Enter the ID number of the product connected to the input cable for input signal reception. (Range: 0~224)

- Press ▲/▼ to select a number, and press .
- Enter the number you want using the number buttons on the remote control.

## Device ID Auto Set

- Assign ID number automatically for all connected products.

## PC Connection Cable

Select a method to connect to MDC to receive the MDC signal.

- **RS232C cable**  
Communicate with MDC via the RS232C cable.
- **RJ45(LAN) cable**  
Communicate with MDC via the RJ45 cable.

---

## More settings

The on-screen menu appears.

HOME  → More settings → ENTER 

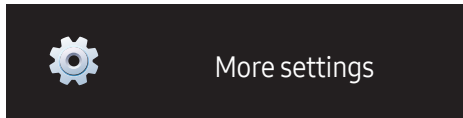

---

– The displayed image may differ depending on the model.

# Chapter 06

## Screen Adjustment

Configure the **Picture** settings (**Backlight**, **Color Tone**, etc.).

The layout of the **Picture** menu options may vary depending on the product.

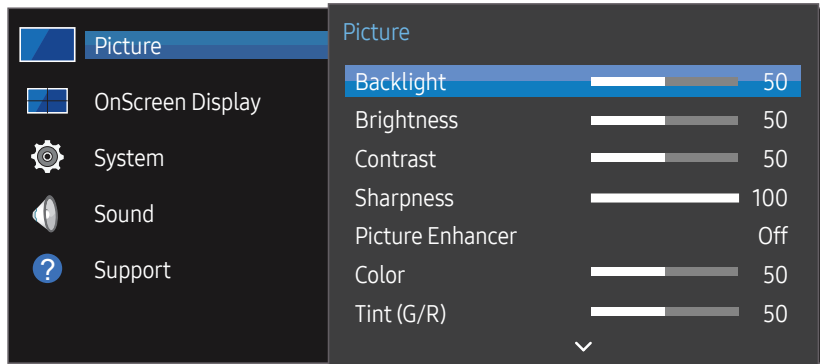

– The displayed image may differ depending on the model.

## Backlight / Brightness / Contrast / Sharpness / Picture Enhancer / Color / Tint (G/R)

MENU  → **Picture** → ENTER 

Your product has several options for adjusting picture quality.

- You can adjust and store settings for each external device you have connected to an input on the product.
- Lowering picture brightness reduces power consumption.

## Color Temperature

MENU  → **Picture** → **Color Temperature** → ENTER 

Adjust the color temperature. (Range: 2800K–16000K)

---



## White Balance Settings

MENU  → **Picture** → **White Balance Settings** → ENTER 

Adjust the color temperature of the picture so that white objects appear brighter.

- **White Balance (Custom / Color Expert)**: Select Color Expert to apply the PC calibration settings.
- **R-Gain / G-Gain / B-Gain**: Adjust the proportion of each of red, green and blue colors in bright areas.
- **Reset**: Restore the white balance settings to the default values.

## Gamma

MENU  → **Picture** → **Gamma** → ENTER 

Adjust the mid-range brightness of the picture.

## Black Equalizer

MENU  → **Picture** → **Black Equalizer** → ENTER 

Adjust the brightness of the dark areas. The dark areas become brighter when set to High, easier to see the details.

- **Off / Low / High**

## Picture Options

MENU  → **Picture** → **Picture Options** → ENTER 

### Color Tone

- **Off / Cool / Standard / Warm1 / Warm2**

— Settings can be adjusted and stored for each external device connected to an input on the product.

### HDMI Black Level

Selects the black level on the screen to adjust the screen depth.

- **Auto / Low / Normal**

— Only available if the input signal from the external device connected to the HDMI port is RGB444.

### Input Signal Plus

MENU  → **Picture** → **Input Signal Plus** → ENTER 

Expands the input signal range for HDMI/DisplayPort connections.

- **HDMI1 (Off / On)**
- **HDMI2 (Off / On)**
- **DisplayPort (Off / On)**

---

## Apply Picture Settings

MENU  → Picture → Apply Picture Settings → ENTER 

Apply the picture settings to all external devices connected to the device or to the current source only.

- All Sources / Current Source

## Picture Size

MENU  → Picture → Picture Size → ENTER 

choose size and aspect ratio picture displayed on screen.

## Picture Size

Different screen adjustment options are displayed depending on the current input source.

- **16:9**: Sets the picture to **16:9** wide mode.
- **4:3**: Sets the picture to basic (**4:3**) mode.
  - Do not set your product to **4:3** format for a long time.  
The borders displayed on the left and right, or top and bottom of the screen may cause image retention (screen burn) which is not covered by the warranty.
- **Original**: Display images in the original picture quality.

## Picture Off

MENU  → Picture → Picture Off → ENTER 

Selecting **Picture Off** switches off the screen. The volume is not disabled.

To switch the screen on, press any button other than the volume and power buttons.

## Reset Picture

MENU  → Picture → Reset Picture → ENTER 

Resets your current picture mode to its default settings.

# Chapter 07

## OnScreen Display

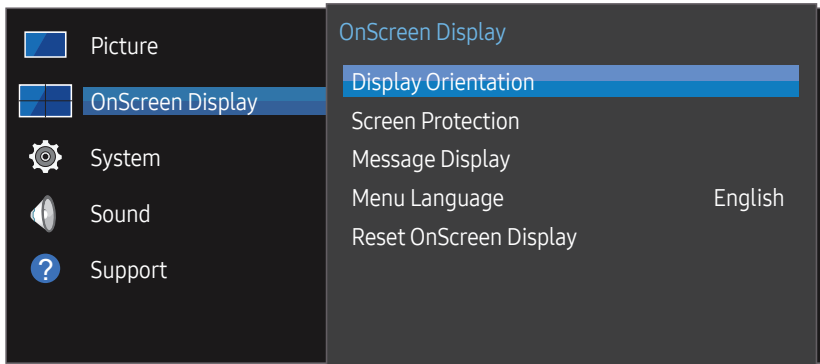

– The displayed image may differ depending on the model.

## Display Orientation

MENU → OnScreen Display → Display Orientation → ENTER

## Onscreen Menu Orientation

Set the menu screen orientation.

- **Landscape:** Display the menu in landscape mode (default).
- **Portrait:** Display the menu in portrait mode on the right side of the product screen.

## Source Content Orientation

Set the orientation of content from external devices connected to the product.

- **Landscape:** Display the screen in landscape mode (default).
  - **Portrait:** Display the screen in portrait mode.
- **Portrait** orientation mode is not supported when a UHD resolution is in use.



## Aspect Ratio

Set the rotated screen to be either full screen or original.

- **Full Screen:** Display the rotated screen in full screen.
- **Original:** Display the rotated screen in the original aspect ratio.

– Available only when **Source Content Orientation** is set to **Portrait**.

# Screen Protection

MENU  → OnScreen Display → Screen Protection → ENTER 

To reduce the possibility of screen burn, this unit is equipped with **Pixel Shift** screen burn prevention technology.

**Pixel Shift** moves the picture slightly on the screen.

The **Pixel Shift** time setting allows you to program the time between movements of the picture in minutes.

## Pixel Shift

Minimize image retention by finely moving pixels horizontally or vertically.

- **Pixel Shift (Off / On)**
  - **Horizontal**, **Vertical** and **Time** are enabled only when **Pixel Shift** is set to **On**.
- **Horizontal**: Sets how many pixels the screen moves horizontally.
- **Vertical**: Sets how many pixels the screen moves vertically.
- **Time**: Set the time interval for performing the horizontal or vertical movement, respectively.

Available Pixel Shift Settings and Optimum Settings.

	Available Settings	Optimum Settings
<b>Horizontal</b> (pixels)	0 ~ 4	4
<b>Vertical</b> (pixels)	0 ~ 4	4
<b>Time</b> (minute)	1 min. ~ 4 min.	4 min.

— The **Pixel Shift** value may differ depending on the model.

— Displaying a still image or a **4:3** output for an extended period of time may cause image retention. This is not a defect in the product.

## Timer

You can set the timer for **Screen Protection**.

The **Screen Protection** feature stops automatically after a specified period of time.

- **Timer (Off / Repeat / Interval)**
  - **Off**
  - **Repeat**: Display the anti-burn in pattern at a specified interval.
  - **Interval**: Display the anti-burn in pattern for a specified period of time (from the starting to finishing time).
    - When **Clock Set** is configured, **Interval** will be enabled.
    - **Period**, **Start Time** and **End Time** are enabled only when **Timer** is set to **Repeat** or **Interval**.
- **Period**: Specify the time interval to activate the **Screen Protection** function.
  - The option is enabled when **Repeat** is selected for **Timer**.
- **Start Time**: Set the start time to activate the screen protection function.
  - The option is enabled when **Interval** is selected for **Timer**.
- **End Time**: Set the end time to deactivate the screen protection function.
  - The option is enabled when **Interval** is selected for **Timer**.

## Immediate Display

Select the screen saver you want to display immediately.

- **Off / Fading Screen**



## Side Gray

When the screen is set to 4:3 aspect ratio, adjust the brightness of white margins on sides to protect the screen.

- **Off / Light / Dark**

---

## Message Display

MENU  → OnScreen Display → Message Display → ENTER 

### Source Info

Select whether to display the source OSD when the input source changes.

- Off / On

### No Signal Message

Select whether to display the no-signal OSD when no signal is detected.

- Off / On

### MDC Message

Select whether to display the MDC OSD when the product is controlled by the MDC.

- Off / On

## Menu Language

MENU  → OnScreen Display → Menu Language → ENTER 

Set the menu language.

— A change to the language setting will only be applied to the onscreen menu display. It will not be applied to other functions on your PC.

## Reset OnScreen Display

MENU  → OnScreen Display → Reset OnScreen Display → ENTER 

This option returns the current settings under **OnScreen Display** to the default factory settings.

# Chapter 08

## System

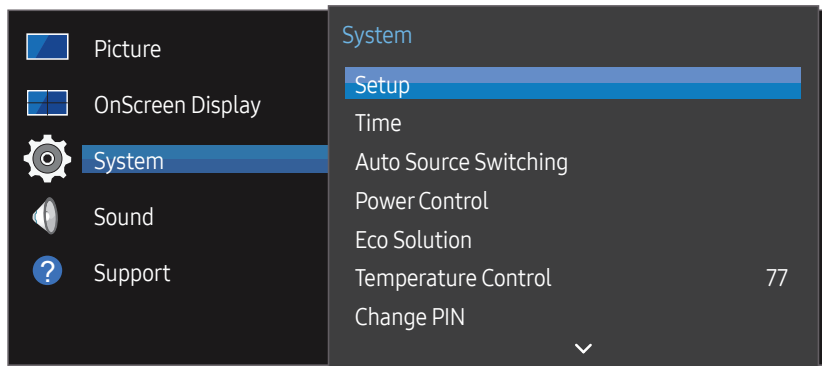

– The displayed image may differ depending on the model.

## Setup

MENU → **System** → **Setup** → ENTER

Change the initial settings that were configured when you first used the product.

### 1 Language

Select your language to start the on screen setup.

### 2 Display Orientation

Configure the menu page orientation.

– **Landscape / Portrait**

### 3 PC Connection Cable

Select which type of cable you are using to connect the display to the PC. And then select **Next**.

### 4 Network Settings

Set the IP settings, and then select **Next**.

### 5 Clock Set



Set the current date and time, and then select **Next**.

### 6 Complete

Setup is complete and you're ready to get started.

---

## Time

MENU  → System → Time → ENTER 

You can configure **Clock Set** or **Sleep Timer**. Configure various time-related settings.

— Press the INFO button if you want to view the current time.

### Clock Set

Select **Clock Set**. Select **Date** or **Time**, and then press .

Use the number buttons to enter numbers or press the up and down arrow buttons. Use the left and right arrow buttons to move from one entry field to the next. Press  when done.

— You can set the **Date** and **Time** directly by pressing the number buttons on the remote control.

### DST

Switches the DST (Daylight Saving Time) function on or off.

**Off / On**

- **Start Date**: Set the start date of Daylight Saving Time.
- **End Date**: Set the end date of Daylight Saving Time.
- **Time Offset**: Select the correct time offset your timezone.

## Sleep Timer

Automatically shuts off the product after a preset period of time.

(Off / 30 min. / 60 min. / 90 min. / 120 min. / 150 min. / 180 min.)

— Use the up and down arrows to select a period of time, and then press . To cancel **Sleep Timer**, select **Off**.

## Power On Delay

When connecting multiple products, adjust the power-on time for each product to prevent power overload (within the range 0–50 seconds).

---

## Auto Source Switching

MENU  → System → Auto Source Switching → ENTER 

Turning on the display with **Auto Source Switching On**, and the previous video source selection is not active, the display will automatically search the different video input sources for active video.

### Auto Source Switching

When the **Auto Source Switching** is **On**, the display video source will automatically be searched for active video.

The **Primary Source** selection will be activated, if the current video source is not recognized.

**Secondary Source** selection will become active, if no primary video source is available.

If both the primary and secondary input sources are not recognized, the display will perform two searches for an active source, each search checking the primary and then secondary source. If both searches fail, the display will return to the first video source and display a message indicating that there is no signal.

When the **Primary Source** selection is set to **All**, the display will search all the video source inputs twice in sequence looking for an active video source, returning back to the first video source in the sequence if no video is found.

### Primary Source Recovery

Select whether to restore the selected primary input source when a primary input source is activated.

— The **Primary Source Recovery** function is disabled if **Primary Source** is set to **All**.

## Primary Source

Specify **Primary Source** for the automatic input source.

## Secondary Source

Specify **Secondary Source** for the automatic input source.

## Power Control

MENU  → System → Power Control → ENTER 

### Auto Power On

This feature automatically turns on the product as soon as it is plugged in. Pressing the power button is not needed.

- **Off / On**

---

## Standby Control

You can set the screen standby mode to be applied when an input signal is received.

- **Auto**  
Power-saving mode will activate if no input signals are detected even though a source device is connected to the display.  
The message **No Signal** will appear if no source device is connected.
- **Off**  
The message **No Signal** will appear if no input signals are detected.
  - If **No Signal** is displayed although a source device is connected, check the cable connection.
  - If **No Signal Message** is set to **Off**, the **No Signal** message does not appear. If this is the case, set **No Signal Message** to **On**.
- **On**  
Power-saving mode will activate if no input signals are detected.

## Remote Configuration

This feature keeps the network power on when the product turns off.

- **Off / On**

## Power Button

The power button can be set to either turn on the power or turn on/off the power.

- **Power On Only**: Set the power button to turn on the power.
- **Power On/Off**: Set the power button to turn on/off the power.

## Eco Solution

MENU  → **System** → **Eco Solution** → ENTER 

### Energy Saving

Reduce the power consumption by adjusting the screen brightness.

- **Off / Low / Medium / High**

### Screen Lamp Schedule

#### Screen Lamp Schedule

Enable or disable the lamp schedule.

- **Off / On**

#### Schedule1, Schedule2

#### Time

The panel brightness will change to the brightness set in **Lamp** at a specified time.

#### Lamp

Adjust the panel brightness. A value closer to 100 makes the panel brighter.

- **0 ~ 100**

---

## No Signal Power Off

Save power by turning the device off when no signal is received from any source.

- Off / 10 min. / 15 min. / 30 min. / 60 min.

- Disabled when an attached PC is in power saving mode.
- The product will automatically power off at a specified time. The time can be changed as required.

## Auto Power Off

The product will automatically turn off if you do not operate the product for the specified period.

- Off / 4 hours / 6 hours / 8 hours

## Temperature Control

MENU  → System → Temperature Control → ENTER 

This function detects the internal temperature of the product. You can specify the temperature range that is acceptable.

The default temperature is set to 77 °C.

Recommended temperature for **Temperature Control** is 75 °C ~ 80 °C (provided that the surrounding temperature is 40 °C).

- The screen will become darker if the current temperature exceeds the specified temperature limit. If the temperature continues to rise, the product will power off to prevent overheating.

## Change PIN

MENU  → System → Change PIN → ENTER 

The **Change PIN** screen will appear.



Choose any 4 digits for your PIN and enter it in **Enter a new PIN..** Reenter the same 4 digits in **Enter the PIN again..**

When the Confirm screen disappears, press the **OK** button. The product has memorized your new PIN.

- Default password: 0 - 0 - 0 - 0
- Change the PIN to keep your device secure.

---

## General

MENU  → System → General → ENTER 

### Security

Enter your 4 digit PIN number.

If you want to change the PIN number, use the **Enter PIN** function.

— Change the PIN to keep your device secure.

#### Safety Lock

It sets safe lock function.

- Off / On

All the menus and buttons of the product and remote control, except for the **LOCK** button on the remote control, will be locked by the **Safety Lock** function.

To unlock the menus and buttons, press the **LOCK** button and then enter the password (default password: 0 - 0 - 0 - 0).

#### Power On Button

Turn on this feature to enable the remote control's Power button to turn on the product while **Safety Lock** is enabled.

- Off / On

### HDMI Hot Plug

This feature is used to activate the time delay to turn on a DVI/HDMI source device.

- Off / On

## Frame Alignment

MENU  → System → Frame Alignment → ENTER 

Improve the screen alignment between devices when using the video wall function.

- Auto / Off / On

## Reset System

MENU  → System → Reset System → ENTER 

This option returns the current settings under system to the default factory settings.

# Chapter 09

## Sound Adjustment

Configure the sound (**Sound**) settings for the product.

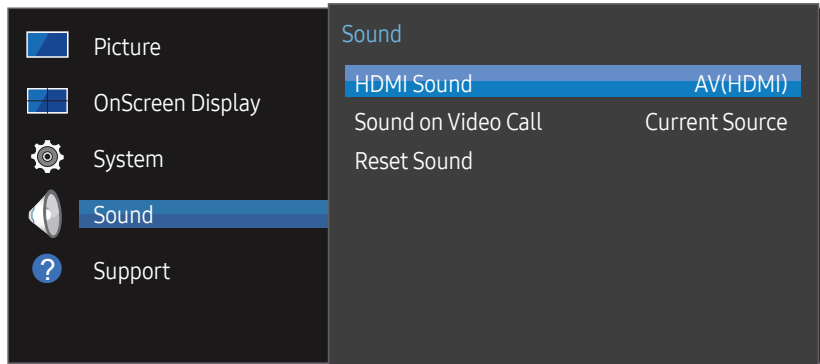

– The displayed image may differ depending on the model.

### HDMI Sound

MENU → **Sound** → **HDMI Sound** → ENTER

Select whether to hear from **AV(HDMI)** or **PC(DVI)**.

- **AV(HDMI) / PC(DVI)**

### Sound on Video Call

MENU → **Sound** → **Sound on Video Call** → ENTER

Select sound output to listen to during a video call.

- **Current Source / Video Call**

### Reset Sound

MENU → **Sound** → **Reset Sound** → ENTER

The displayed image may differ depending on the model. Reset all sound settings to the factory defaults.

# Chapter 10

## Support

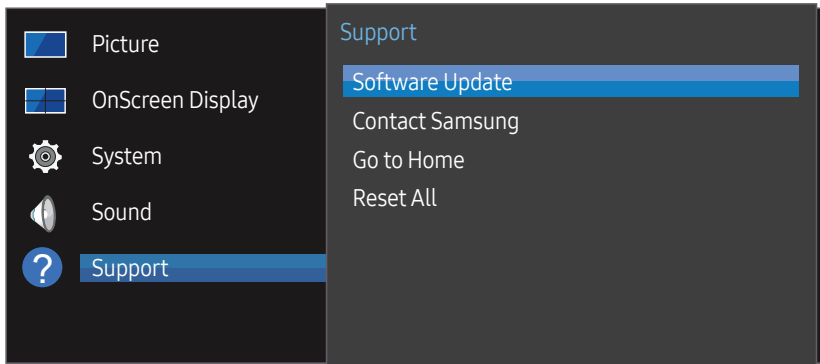

– The displayed image may differ depending on the model.

## Software Update

MENU  → **Support** → **Software Update** → ENTER 

The **Software Update** menu lets you upgrade your product software to the latest version.

- Be careful not to turn off the power until the upgrade is complete. The product will turn off and on automatically after completing the software upgrade.
- When you upgrade software, all video and audio settings you have made will return to their default settings. We advise you to write down your settings so that you can easily reset them after the upgrade.

## Updating via USB Device

Download the update package from Samsung's website to a USB storage device and then connect the device to the product to update the product's software.

- Remember to save the update package to the top-most directory of the USB device. Otherwise, the product will not be able to find the update package.

## Contact Samsung

MENU  → **Support** → **Contact Samsung** → ENTER 

View this information when your product does not work properly or when you want to upgrade the software.

You can find information regarding our call centers and how to download products and software.

- Go to **Contact Samsung** and find the product **Model Code** and **Software Version**.

---

## Go to Home

Accessible using the HOME  button on the remote control.

MENU  → Support → Go to Home → ENTER 

Refer to the "Home feature" chapter for details on sub-menu items.

Go to Home to play a variety of content from a memory device or a connected network.

## Video Wall

Customize the layout of multiple displays that are connected to form a video wall.

In addition, display part of a whole picture or repeat the same picture on each of the connected multiple displays.

To display multiple images, refer to MDC Help or the MagicInfo user guide. Some models may not support the MagicInfo function.

## On/Off Timer

— You must set the clock before you can use On/Off Timer.

Set On Timer so that your product turns on automatically at a time and on a day of your choosing.

The power is turned on with the specified volume or input source.

## Network Settings

View the network settings.

## ID Settings



Assign an ID to a set.

Press ▲/▼ to select a number, and press .

## More settings

The picture settings menu appears.

## Reset All

MENU  → Support → Reset All → ENTER 

This option returns all the current settings for a display to the default factory settings.

# Chapter 11

## Troubleshooting Guide

- 
- Follow the instruction on the right to test your product before requesting for service. If the problem persists, contact Samsung Customer Service Center.

- 
- If the screen remains blank, check the PC system, video controller and cable.

## Requirements Before Contacting Samsung Customer Service Center

### Testing the Product

Check if your product is operating normally by using the product test function.

If the product is properly connected to the PC and the screen remains turned off, run the product's self-diagnostics.

- 1 Power off both the PC and product.
- 2 Disconnect all the cables from the product.
- 3 Power on the product.
- 4 If **No Cable Connected** is displayed, the product is operating normally.

### Checking the Resolution and Frequency

**Not Optimum Mode** will briefly be displayed if a mode that exceeds a supported resolution is selected (refer to Supported Resolutions).

---

## Check the followings.

### Installation issue (PC mode)

---

The screen keeps switching on and off.

Check the cable connection between the product and PC, and ensure the connection is secure.

---

Blank spaces are found on all four sides of the screen when an HDMI or HDMI-DVI cable is connected to the product and PC.

The blank spaces found on the screen have nothing to do with the product.

---

Blank spaces on the screen are caused by the PC or graphics card. To resolve the problem, adjust the screen size in the HDMI or DVI settings for the graphics card.

---

If the graphics card settings menu does not have an option to adjust the screen size, update the graphics card driver to the latest version.

(Please contact the graphics card or computer manufacturer for further details about how to adjust the screen settings.)

---

### Screen issue

---

The screen will not turn on.

Make sure that the power cord is connected.

---

**No Signal** is displayed on the screen.

Check that the product is connected correctly with a cable.

---

Check that the device connected to the product is powered on.

---

**Not Optimum Mode** is displayed.

This message is displayed when a signal from the graphics card exceeds the product's maximum resolution and frequency.

---

Refer to the Standard Signal Mode Table and set the maximum resolution and frequency according to the product specifications.

---

The images on the screen look distorted.

Check the cable connection to the product.

---

---

## Screen issue

---

The screen is not clear. The screen is blurry.

Remove any accessories (video extension cable, etc) and try again.

Set the resolution and frequency to the recommended level.

The screen appears unstable and shaky.

Check that the resolution and frequency of the PC and graphics card are set within a range compatible with the product. Then, change the screen settings if required by referring to the Additional Information on the product menu and the Standard Signal Mode Table.

There are shadows or ghost images left on the screen.

The screen is too bright. The screen is too dark.

Adjust **Brightness** and **Contrast**.

White does not really look white.

Go to **Picture** and adjust the **White Balance Settings** settings.

The product will turn off automatically.

Go to **System** and make sure **Sleep Timer** is set to **Off**.

If a PC is connected to the product, check the power status of the PC.

Make sure the power cord is connected properly to the product and power outlet.

If the signal from a connected device is not detected, the product automatically turns off after 10 to 15 minutes.

Picture quality of the product is different from the dealer shop where it was purchased.

Use an HDMI cable to obtain high-definition (HD) picture quality.

---

---

## Screen issue

---

The screen display does not look normal.

Encoded video content may cause the display to appear corrupted in scenes featuring fast moving objects such as in a sports event or action video.

Low signal level or low picture quality may cause the display to appear corrupted. This does not mean the product is defective.

A cell phone within a distance of one-meter radius may cause static on analog and digital products.

The brightness and color do not look normal.

Go to **Picture** and adjust the screen settings such as **Color**, **Brightness** and **Sharpness**.

Go to **System** and adjust the **Energy Saving** settings.

Reset the screen settings to the default settings.

Lines (red, green or blue) are displayed on the screen.

These lines are displayed when there is a defect in **DATA SOURCE DRIVER IC** on the monitor. Contact a Samsung Service Center to resolve the issue.

The display looks unstable and then freezes.

The screen may freeze when a resolution other than the recommended resolution is used or if the signal is not stable. To resolve the issue, change the PC resolution to the recommended resolution.

---

---

## Screen issue

The screen cannot be displayed in full screen.

A scaled SD (4:3) content file can cause black bars on both sides of an HD channel screen.

A video with an aspect ratio different from the product can cause black bars at the top and bottom of the screen.

Change the screen size setting to full screen on the product or source device.

---

## Sound issue

There is no sound.

Check the connection of the audio cable or adjust the volume.

Check the volume.

The volume is too low.

Adjust the volume.

If the volume is still low after turning it up to the maximum level, adjust the volume on your PC sound card or software.

Video is available but there is no sound.

If an HDMI cable is connected, check the audio output settings on the PC.

If a source device is used

- Make sure the audio cable is properly connected to the audio input port on the product.
- Check the audio output settings for the source device.  
(For example, if an HDMI cable is connected to the monitor, the audio setting for the cable box may need to be changed to HDMI.)

If a DVI-HDMI cable is used, a separate audio cable is required.

If the product has a headphone port, make sure nothing is connected to it.

Reconnect the power cord to the device and then reboot the device.

---

---

## Sound issue

There is static coming from the speakers.

Check the cable connection. Make sure a video cable is not connected to an audio input port.

Check the signal strength after connecting a cable.

Low signal level can cause corrupted sound.

There is audible sound when the volume is muted.

Adjust the volume for the external speakers.

Audio settings for main speakers are separate from the internal speakers on the product.

Changing or muting the volume on the product does not affect an external amplifier(decoder).

---

## Remote control issue

The remote control does not work.

Make sure that the batteries are correctly in place (+/-).

Check if the batteries are flat.

Check for power failure.

Make sure that the power cord is connected.

Check for any special lighting or neon signs switched on in the vicinity.

---

## Source device issue

A beeping sound is heard when my PC is booting.

If a beeping sound is heard when your PC is booting, have your PC serviced.

---

## Other issue

The product smells like plastic.	The plastic smell is normal and disappears over time.
The monitor appears tilted.	Remove and then attach the stand again to the product.
Audio or video cuts out intermittently.	Check the cable connection and connect it again if required.  Using a very hard or thick cable may corrupt audio and video files. Make sure cables are flexible enough to ensure durability. When mounting the product onto a wall, it is recommended to use right-angle cables.
Small particles are found on the edges of the product.	The particles are part of the product design. The product is not defective.
When I try to change the PC resolution, a message "Mode not Supported" appears.	The message "Mode not Supported" appears if the input source resolution exceeds the maximum resolution of the display. To resolve the issue, change the PC resolution to a resolution supported on the display.
There is no sound from the speakers in HDMI mode when a DVI-HDMI cable is connected.	DVI cables do not transmit sound data. Make sure to connect the audio cable to the correct input jack to enable audio.
HDMI Black Level is not functioning properly on an HDMI device with YCbCr output.	This function is available only when a source device, such as a DVD player and STB, is connected to the product via an HDMI (RGB signal) cable.
There is no sound in HDMI mode.	Displayed picture colors may not look normal. Video or sound may not be available. This can occur if a source device that only supports an older version of the HDMI standard is connected to the product.  If these issues occur, connect an audio cable along with the HDMI cable.  Some PC graphics cards may not automatically recognize HDMI signals that do not include sound. In this case, manually select a sound input.

---

## Other issue

---

HDMI-CEC does not work.

This product does not support the HDMI-CEC feature.

To use several external devices compatible with the HDMI-CEC feature that are connected to the HDMI1 and HDMI2 ports on the product, turn off the HDMI-CEC features on all the external devices. External devices include Blu-ray and DVD players.

Operating an external device when its HDMI-CEC feature is enabled may automatically stop other external devices.

To change HDMI-CEC settings, refer to the device user guide or contact the device manufacturer for assistance.

---

The IR sensor is not functioning.

- Contact your nearest service center to have the product serviced.

- This function is available only when a source device, such as a DVD player and STB, is connected to the product via an HDMI (RGB signal) cable.

---

When booting the PC with the input source set to **DisplayPort** the BIOS and booting screens do not appear.

- Boot the PC when the product is turned on or when the input source is not **DisplayPort**.
-

# Chapter 12

## Specifications

### General

Model Name		VH55C-R / VM55C-R	VH55C-E / VM55C-E
Panel	Size	55 CLASS (54.6 inches / 138.7 cm)	55 CLASS (54.6 inches / 138.7 cm)
	Display area	1209.6 mm (H) x 680.3 mm (V)	1209.6 mm (H) x 680.4 mm (V)
Resolution	Optimum resolution	1920 x 1080 @ 60 Hz	
	Maximum resolution	1920 x 1080 @ 60 Hz (DVI) 3840 x 2160 @ 60 Hz (HDMI1, HDMI2, DP)	
Power Supply		AC100-240V~ 50/60Hz Refer to the label at the back of the product as the standard voltage can vary in different countries.	
Environmental considerations	Operating	Temperature : 32 °F to 104 °F (0 °C to 40 °C) * For installing the enclosure, keep the internal temperature at 35 °C or below. Humidity : 10 % to 80 %, non-condensing	
	Storage	Temperature : -4 °F to 113 °F (-20 °C to 45 °C) Humidity : 5 % to 95 %, non-condensing * Applicable before the product package is unpacked.	

---

- Plug-and-Play

This monitor can be installed and used with any Plug-and-Play compatible systems. Two-way data exchange between the monitor and PC system optimizes the monitor settings. Monitor installation takes place automatically. However, you can customize the installation settings if desired.

- Due to the nature of the manufacturing of this product, approximately 1 pixel per million (1ppm) may appear brighter or darker on the panel. This does not affect product performance.
- This product can be set to only one resolution for each screen size to obtain the optimum picture quality due to the nature of the panel. Using a resolution other than the specified resolution may degrade the picture quality. To avoid this, it is recommended that you select the optimum resolution specified for your product.
- For detailed device specifications, visit the Samsung website.

**(USA only)**

Dispose unwanted electronics through an approved recycler. To find the nearest recycling location, go to our website: [www.samsung.com/recycling](http://www.samsung.com/recycling) or call, 1-800-Samsung

For battery recycling go to [call2recycle.org](http://call2recycle.org) or call 1-800-822-8837

## Preset Timing Modes

The screen will automatically be adjusted if a signal that belongs to the following standard signal modes is transmitted from your PC. Note that the screen will be unable to display content if the signal from the PC is not one of the standard signal modes. Refer to the manual for your graphic card and configure as the following.

Resolution	Horizontal Frequency (kHz)	Vertical Frequency (Hz)	Pixel Clock (MHz)	Sync Polarity (H/V)
IBM, 720 x 400	31.469	70.087	28.322	-/+
VESA/IBM, 640 x 480	31.469	59.940	25.175	-/-
MAC, 640 x 480	35.000	66.667	30.240	-/-
MAC, 832 x 624	49.726	74.551	57.284	-/-
MAC, 1152 x 870	68.681	75.062	100.000	-/-
VESA, 640 x 480	37.861	72.809	31.500	-/-
VESA, 640 x 480	37.500	75.000	31.500	-/-
VESA, 800 x 600	37.879	60.317	40.000	+/+
VESA, 800 x 600	48.077	72.188	50.000	+/+
VESA, 800 x 600	46.875	75.000	49.500	+/+
VESA, 1024 x 768	48.363	60.004	65.000	-/-
VESA, 1024 x 768	56.476	70.069	75.000	-/-
VESA, 1024 x 768	60.023	75.029	78.750	+/+

Resolution	Horizontal Frequency (kHz)	Vertical Frequency (Hz)	Pixel Clock (MHz)	Sync Polarity (H/V)
VESA, 1152 x 864	67.500	75.000	108.000	+/+
VESA, 1280 x 720	45.000	60.000	74.250	+/+
VESA, 1280 x 800	49.702	59.810	83.500	-/+
VESA, 1280 x 1024	63.981	60.020	108.000	+/+
VESA, 1280 x 1024	79.976	75.025	135.000	+/+
VESA, 1366 x 768	47.712	59.790	85.500	+/+
VESA, 1440 x 900	55.935	59.887	106.500	-/+
VESA, 1600 x 900	60.000	60.000	108.000	+/+
VESA, 1680 x 1050	65.290	59.954	146.250	-/+
VESA, 1920 x 1080	67.500	60.000	148.500	+/+
VESA, 2560 x 1440	88.787	59.951	241.500	+/-
VESA, 3840 x 2160	133.313	59.997	533.250	+/-
CEA, 3840 x 2160	67.500	30.000	297.000	+/+
CEA, 3840 x 2160	54.000	24.000	297.000	+/+
CEA, 3840 x 2160	56.250	25.000	297.000	+/+
CEA, 3840 x 2160	112.500	50.000	594.000	+/+

# Chapter 13

## Appendix

### Responsibility for the Pay Service (Cost to Customers)

— When the service is requested, in spite of in warranty, we may charge you for a visit from a service technician in the following cases.

#### Not a product defect

Cleaning of the product, Adjustment, Explanation, Re-installation and etc.

- If a service technician is requested to give instructions on how to use product or simply adjusts options without disassembling product.
- If a defect is caused by external environmental factors (Internet, Antenna, Wired Signal, etc.)
- If a product is reinstalled or devices are connected additionally after installing the purchased product for the first time.
- If a product is reinstalled to move to a different spot or to move to a different house.
- If the customer requests instructions on how to use another company's product.
- If customer requests instructions on how to use the network or another company's program.
- If customer requests software installation and setup for the product.
- If a service technician removes/cleans dusts or foreign materials inside of the product.
- If customer requests an installation additionally after purchasing a product through home-shopping or online.

### A Product damage caused by customer's fault

Product damage caused by customer's mishandling or wrong repair

If a product damage is caused by;

- External impact or drop.
- Use of supplies or separately sold product unspecified by Samsung.
- Repair from a person besides an engineer of outsourcing service company or partner of Samsung Electronics Co., Ltd.
- Remodeling or repairing the product by customer.
- Using it with incorrect voltage or non-authorized electrical connections.
- Not following the "cautions" in User Manual.

#### Others

- If product fails by natural disaster. (lightning, fire, earthquake, flood damage, etc)
- If consumable components are all used up. (Battery, Toner, Fluorescent lights, Head, Vibrator, Lamp, Filter, Ribbon, etc.)

— If customer requests a service in case the product has no defect, service fee may be charged. So please read User Manual first.

## Prevention of Afterimage Burn-in

### What is afterimage burn-in?

Afterimage burn-in should not occur when the panel is operating normally. Normal operation refers to a continuously changing video pattern. If the panel displays a fixed pattern for an extended period of time a slight voltage difference may occur between the electrodes in pixels that control the liquid crystals.

Such a voltage difference between electrodes increases with time and makes the liquid crystals thinner. When this occurs, a previous image can remain on the screen when the pattern changes.

- ⊘ This information is a guide to prevent afterimage burn-in. Viewing a fixed screen for an extended period of time may cause afterimage burn-in. This problem is not included in warranty.

### Recommended prevention practices

Viewing a fixed screen for an extended period of time may cause afterimage burn-ins or smudges. If the product is not to be used for a long time, turn it off, or activate the Power Saving mode or Screen Saver with a moving image.

- Change the colors regularly.



- Avoid combinations of a text color and background color of contrasting brightness.
- Avoid using colors of contrasting brightness (black and white; gray and black).



---

## License



The terms HDMI, HDMI High-Definition Multimedia Interface, HDMI trade dress and the HDMI Logos are trademarks or registered trademarks of HDMI Licensing Administrator, Inc.

---

### Open Source License Notice

Open Source used in this product can be found on the following webpage (<https://opensource.samsung.com>).

---