

Planar® UltraRes™ P Series



- URP49 | URP49-T
- URP55 | URP55-T
- URP65 | URP65-T
- URP75 | URP75-ERO-T
- URP85 | URP85-ERO-T
- URP98 | URP98-ERO-T

Copyright © March 2024 by Planar Systems, Inc.
All rights reserved.

This document may not be copied in any form without permission from Planar. Information in this document is subject to change without notice.

Trademark Credits

Windows™ is a trademark of Microsoft Corp.

The terms HDMI, HDMI High-Definition Multimedia Interface, HDMI Trade dress and the HDMI Logos are trademarks or registered trademarks of HDMI Licensing Administrator, Inc. All other companies are trademarks or registered trademarks of their respective companies.

Disclaimer

The information contained in this document is subject to change without notice. Planar Systems, Inc. makes no warranty of any kind with regard to this material. While every precaution has been taken in the preparation of this manual, the Company shall not be liable for errors or omissions contained herein or for incidental or consequential damages in connection with the furnishing, performance, or use of this material.

Warranty and Service Plans

Planar warranty and service plans will help you maximize your investment by providing great support, display uptime, and performance optimization. From post-sale technical support, to a full suite of depot services, our services are performed by trained employees. When you purchase a Planar product, you get more than a display; you get the service and support you need to maximize your investment. To find the latest warranty and service information regarding your Planar product, please visit <http://www.planar.com/support>

RoHS Compliance Statement

The Planar UltraRes P Series is fully RoHS compliant.

Part Number: 020-1407-02B

Table of Contents

Introduction	6
1. Safety Information.....	7
2. Safety Precautions.....	7
2.1 Important Safety Instructions.....	8
2.2 Informations sur la sécurité	9
2.3 Précautions de sécurité.....	9
2.4 Consignes de sécurité importantes	10
3. Recommended Usage	11
3.1 Burn-In Versus Temporary Image Retention.....	11
3.2 Warranty Coverage.....	11
3.3 Important Waste Disposal Information.....	12
3.4 European Product Database for Energy Labeling (EPREL).....	12
3.5 Normal Usage Guidelines	13
3.6 ENERGY STAR Certified	13
4. Cleaning the Display	14
Unpacking and Checking Accessories.....	15
5. Package Contents.....	15
6. Accessory Kit.....	15
7. Planar UltraRes P Series – Standard Inputs	17
7.1 URP49 / URP49-T	17
7.2 URP55 / URP55-T	18
7.3 URP65 / URP65-T	19
7.4 URP75 / URP75-ERO-T.....	20
7.5 URP85 / URP85-ERO-T.....	21
7.6 URP98 / URP98-ERO-T.....	22
Installing the Display	23
8. Before You Begin	23
8.1 Tools/Equipment List.....	23
8.2 Other Things You May Need	23
8.3 Plan Your Installation.....	23
8.4 Prepare Your Installation Location.....	24
8.5 Cable Length Recommendations	24
9. Mounting.....	25
9.1 Mounting Display with a VESA Mount	25
9.2 Mounting a Peripheral Device	25
Operating the Display	26
10. OSD Keypad.....	26
10.1 URP75 / URP85 / URP98	26
10.2 URP49 / URP55 / URP65	26
11. Remote Control Receiver.....	27
12. LED Indicators	30
13. Using the Display in Portrait Mode	31
14. Using the Display in Flat or Tilted Orientation.....	31
15. Using the Remote Control.....	32
16. IR Command Protocol	33

16.1	Hex Codes (URP49 / URP55 / URP65)	34
16.2	Hex Codes (URP75 / URP85 / URP98)	37
16.3	Locking the Keypad and IR Remote	39
16.4	Locking/Unlocking the OSD Menus (URP49 / URP55 / URP65)	39
16.5	Unlocking the Keypad and IR Remote (URP75 / URP85 / URP98)	39
16.6	Changing the IR Remote Code Set	40
16.7	Turning the Display On	40
16.8	Turning the Display Off	40
16.9	Adjusting the Volume	40
16.10	Selecting Layouts and Input Sources	41
16.11	Navigating Through the Menus	42
17.	Inputs and Views Menu	43
17.1	Image Adjust Menu	46
17.2	Audio Menu	49
17.3	Presets Menu	50
17.4	Advanced Settings Menu	51
17.5	Information Menu	75
18.	Using the Touch Screen	78
Planar UltraRes P Series URP75 / URP85 / URP98: Planar UltraRes Web UI		79
19.	UltraRes Web UI Home Screen	81
20.	Admin	85
21.	Settings	88
22.	Setup	93
Planar UltraRes P Series URP49 / URP55 / URP65 Remote Monitoring Software		96
23.	Login	96
24.	Information	97
25.	Network	97
26.	SMTP	98
27.	SNMP	99
28.	Control	100
External Control		101
Signal Compatibility		102
Color Subsampling Report		109
Power Consumption		110
Specifications		111
Dimensions		117
29.	URP49	117
30.	URP49-T	118
31.	URP55	119
32.	URP55-T	120
33.	URP65	121
34.	URP65-T	122
35.	URP75	123
36.	URP75-ERO-T	124
37.	URP85	125
38.	URP85-ERO-T	126
39.	URP98	127
40.	URP98-ERO-T	128

Troubleshooting During Installation.....	129
41. Error Codes (URP75 / URP85 / URP98 only).....	129
42. Symptoms, Possible Causes and Solutions	130
42.1 Symptom: Display Doesn't Respond to External Control System	130
42.2 Symptom: Can't Get PC to Output 4K @ 24/30/60 Hz.....	130
42.3 Symptom: Can't Get PC to Output 4K @ 24/30/60 Hz.....	131
42.4 Symptom: IR Isn't Working Properly.....	131
42.5 Symptom: Touch Has Broken Response Near Middle/Bottom of Display	132
Accessing Planar's Technical Support Website	133

Introduction

The Planar® UltraRes™ P Series is a line of 49", 55", 65", 75", 85", and 98" 4K resolution (3840 x 2160) professional LCD displays with 500-nit brightness. The displays offer superior visual performance with multi-source viewing and advanced processing ideal for applications ranging from collaborative meeting spaces to high-impact digital signage and media rooms. Interactive touch models are also available.

The Planar UltraRes P Series supports native 4K resolution at up to 60Hz via HDMI® 2.0 and DisplayPort 1.2, enabling smooth motion video and mouse tracking. The displays' HDMI 2.0 inputs are also HDCP 2.2 compliant. It also features Crestron drivers for versatility.

Features of the Planar UltraRes P Series displays include:

- 49", 55", 65", 75", 85" and 98" 4K LCD displays
- 500-nit brightness
- Touch screen models, featuring protective glass, available
- Multi-source viewing

Caution: This manual is intended for use by qualified service persons and end users with experience installing LCD displays.

1. Safety Information

Before using the Planar UltraRes P Series, please read this manual thoroughly to help protect against damage to property, and to ensure personnel safety.

- Be sure to observe the following instructions.
- For your safety, be sure to observe ALL the warnings detailed in this manual.
- For installation or adjustment, please follow this manual's instructions, and refer all servicing to qualified service personnel.

2. Safety Precautions

- **If water is spilled or objects are dropped inside the display, remove the power plug from the outlet immediately.** Failure to do so may result in fire or electrical shock. Contact your dealer for inspection.
- **If the display is dropped or the chassis is damaged, remove the power plug from the outlet immediately.** Failure to do so may result in fire or electrical shock. Contact your dealer for inspection.

WARNING! Wall mounts must be secure.

- **If the display is hung on a wall, the wall must be strong enough to hold it.** Simply mounting it to wallboard or wall paneling won't be adequate or safe.

Caution: For Non-Touch Models:

- The front polarizer of non-touch URP models is soft and subject to scratches from sharp objects.
- Slight pressure on the LCD of non-touch URP models will cause distortion of the image. Heavier pressure will cause permanent damage.

Caution: For All URP Models:

- Displays should be mounted where viewers cannot insert small objects in the openings that will create hazards by contacting bare conductive parts.
- If the power cord or plug is damaged or becomes hot, turn off the main power switch of the display. Make sure the power plug has cooled down and remove the power plug from the outlet. If the display is still used in this condition, it may cause a fire or an electrical shock. Contact your dealer for a replacement.

2.1 Important Safety Instructions

1. Read these instructions.
2. Keep these instructions.
3. Heed all warnings.
4. Follow all instructions.
5. Do not use the display near water.
6. Clean the LCD screens with an LCD screen cleaner or LCD wipes.
7. Do not install near any heat sources such as radiators, heat registers, stoves or other apparatus (including amplifiers) that produce heat.
8. Do not defeat the safety purpose of the polarized or grounding type plug. A polarized plug has two blades with one wider than the other. A grounding type plug has two blades and a third grounding prong. The wide blade or the third prong is provided for your safety. When the provided plug does not fit into your outlet, consult an electrician for the replacement of the obsolete outlet.
9. Protect the power cord from being walked on or pinched, particularly at plugs, convenience receptacles and the point where they exit from any Planar large format LCD display.
10. Only use the attachments/accessories specified by the manufacturer.
11. Unplug all displays during lightning storms or when unused for long periods of time.
12. In instances where a power surge has occurred and a display no longer has an image, the display power will need to be reset.
13. You must follow all National Electrical Code regulations. In addition, be aware of local codes and ordinances when installing your system.
14. Refer all servicing to qualified service personnel. Servicing is required when any of the displays have been damaged in any way. For example, if the AC power cord or plug is damaged, liquid has been spilled or objects have fallen into a display, the displays have been exposed to rain or moisture, do not operate normally or have been dropped.
15. Keep the packing material in case the equipment should ever need to be shipped.
16. Wall mounts must be secure. The wall must be strong enough to hold displays brackets, cables and accessories. Seismic engineers should be consulted in areas prone to earthquakes.
17. **Caution:** There is a risk of explosion if the battery is replaced with incorrect type. Dispose of used batteries according to local regulations.

2.2 Informations sur la sécurité

Avant d'utiliser le Série Planar UltraRes P, veuillez lire attentivement ce manuel pour éviter tout dommage matériel et assurer la sécurité du personnel.

- Assurez-vous de respecter les instructions suivantes.
- Pour votre sécurité, veuillez respecter TOUS les avertissements détaillés dans ce manuel.
- Pour l'installation ou le réglage, suivez les instructions de ce manuel et confiez l'entretien à un personnel qualifié.

2.3 Précautions de sécurité

- **Si de l'eau est renversée ou si des objets sont tombés à l'intérieur de l'écran, débranchez immédiatement la fiche d'alimentation de la prise.** Le non-respect de cette consigne peut entraîner un incendie ou une électrocution. Contactez votre revendeur pour qu'il procède à une inspection.
- **Si l'écran est tombé ou si le châssis est endommagé, débranchez immédiatement la fiche d'alimentation de la prise.** Le non-respect de cette consigne peut entraîner un incendie ou une électrocution. Contactez votre revendeur pour qu'il procède à une inspection.

AVERTISSEMENT! Les supports muraux doivent être sécurisés.

- **Si l'écran est accroché à un mur, celui-ci doit être suffisamment solide pour le supporter.** Un simple montage sur une plaque de plâtre ou un panneau mural n'est ni suffisant ni sécuritaire.

Attention : Pour le modèle non tactile :

- Le polariseur avant du modèle URP non tactile est souple et peut être rayé par des objets pointus.
- Une légère pression sur l'écran LCD du modèle URW non tactile entraînera une distorsion de l'image. Une pression plus forte causera des dommages permanents.

Attention : Pour tous les modèles URP:

- Les écrans doivent être montés de manière à ce que les spectateurs ne puissent pas insérer de petits objets dans les ouvertures, ce qui créerait des dangers en touchant des pièces conductrices nues.
- Si le cordon d'alimentation ou la fiche est endommagé(e) ou devient chaud(e), éteignez l'interrupteur principal de l'écran. Assurez-vous que la fiche d'alimentation a refroidi et retirez-la de la prise de courant. Si vous continuez à utiliser l'écran dans cet état, vous risquez de provoquer un incendie ou une électrocution. Contactez votre revendeur pour un remplacement.

2.4 Consignes de sécurité importantes

1. Lisez ces consignes.
2. Conservez ces consignes.
3. Tenez compte de tous les avertissements.
4. Suivez toutes les consignes.
5. N'utilisez pas l'écran près de l'eau.
6. Nettoyez les écrans LCD avec un nettoyant ou des lingettes prévus pour ce type d'appareil.
7. N'installez pas l'appareil près de sources de chaleur telles que radiateurs, bouches de chaleur, poêles ou autres appareils (y compris les amplificateurs) qui produisent de la chaleur.
8. Ne neutralisez pas le dispositif de sécurité de la fiche polarisée ou de mise à la terre. Une fiche polarisée possède deux lames, l'une plus large que l'autre. Une fiche de mise à la terre a deux lames et une troisième broche de mise à la terre. La lame large ou la troisième broche est prévue pour votre sécurité. Si la fiche fournie ne rentre pas dans votre prise, consultez un électricien pour remplacer la prise obsolète.
9. Protégez le cordon d'alimentation contre les piétinements et les pincements, en particulier au niveau des fiches, des prises de courant et du point de sortie de tout écran LCD grand format de Planar.
10. Utilisez uniquement les accessoires spécifiés par le fabricant.
11. Débranchez tous les écrans pendant les orages ou lorsque vous ne les utilisez pas pendant de longues périodes.
12. Dans les cas où une surtension s'est produite et qu'un écran n'a plus d'image, il faudra réinitialiser l'alimentation de l'écran.
13. Vous devez respecter toutes les règles du Code national de l'électricité. De plus, tenez compte des codes et des règlements locaux lors de l'installation de votre système.
14. Confiez toute réparation à un personnel qualifié. Une réparation est nécessaire lorsque l'un des écrans a été endommagé de quelque manière que ce soit. Par exemple, si le cordon ou la fiche d'alimentation CA est endommagé(e), si du liquide a été renversé ou si des objets sont tombés dans un écran, si les écrans ont été exposés à la pluie ou à l'humidité, s'ils ne fonctionnent pas normalement ou s'ils ont été échappés.
15. Conservez le matériel d'emballage au cas où l'équipement devrait être expédié.
16. Les supports muraux doivent être sécurisés. Le mur doit être suffisamment solide pour supporter les supports, les câbles et les accessoires des écrans. Des ingénieurs sismiques devraient être consultés dans les zones sujettes aux tremblements de terre.
17. **Attention** : Il existe un risque d'explosion si la pile est remplacée par un type incorrect. Éliminez les piles usagées conformément aux règlements locaux.

3. Recommended Usage

In order to get the most out of your LCD, use the following recommended guidelines to optimize the display.

3.1 Burn-In Versus Temporary Image Retention

Burn-in causes the screen to retain an image essentially forever, with little or no way to correct the problem. Under normal use, an LCD will not experience burn-in, as plasma displays do, nor will it retain images in any way.

Normal use of an LCD is defined as displaying continuously changing video patterns or images. However, LCDs can experience *temporary* image retention when recommended usage guidelines are not followed.

What is Temporary Image Retention?

Temporary image retention (TIR) can occur when a static image is displayed continuously for extended periods of time (12 hours or longer). An electrical charge differential may build up between the electrodes of the liquid crystal, which causes a negative-color video image (color-inverted and brightness-inverted version of the previous image) to be retained when a new image is displayed. This behavior is true for any LCD device from any LCD manufacturer.

TIR is not covered under warranty. See standard warranty terms and conditions for details. Here are some guidelines to help you avoid TIR:

- Use the LCD to show a screen saver, moving images or still pictures that change regularly. When using high-contrast images, reposition the images frequently.
- Turn off the LCD when it is not in use. To use your source computer's Power Options Properties, set up your computer to turn off the display when not in use.

3.2 Warranty Coverage

The following models are warranted for **24 x 7** usage:

- 49": URP49, URP49-T
- 55": URP55, URP55-T
- 65": URP65, URP65-T
- 75": URP75, URP75-ERO-T
- 85": URP85, URP85-ERO-T
- 98": URP98, URP98-ERO-T

Planar recommends turning off the power for **4 hours per day** for optimal performance.

For complete warranty details, please visit <http://www.planar.com/warranty>.

3.3 Important Waste Disposal Information

Please recycle or dispose of all electronic waste in accordance with local, state, and federal laws. Additional resources can be found online at <http://www.planar.com/about/green/>.

The crossed-out wheelee bin symbol is to notify consumers in areas subject to Waste Electrical and Electronic Equipment (WEEE) Directive 2012/19/EU that the product was placed on the market after August 13, 2005 and must not be disposed of with other waste. Separate collection and recycling of electronic waste at the time of disposal ensures that it is recycled in a manner that minimizes impacts to human health and the environment. For more information about the proper disposal of electronic waste, please contact your local authority, your household waste disposal service, or the seller from whom you purchased the product.



3.4 European Product Database for Energy Labeling (EPREL)

Registration numbers:

- URP49: 1248073
- URP49-T: 1248074
- URP55: 1248075
- URP55-T: 1248076
- URP65: 1248077
- URP65-T: 1248078

3.5 Normal Usage Guidelines

Normal use of the LCD is defined as operating in the open air to prevent heat buildup, and without direct or indirect heat sources such as lighting fixtures, heating ducts, or direct sunlight that can cause the displays to experience high operating temperatures. For all displays, do not block fans or ventilation openings. If the LCD display will be installed in a recessed area with an LCD surround or enclosure, ensure adequate openings are applied for proper air flow and ventilation.

It is up to the installer to ensure that display placement is changed, thermal shielding is provided and/or additional ventilation is provided to keep the display within its nominal operating parameters. Maximum ambient operating temperatures for the Planar UltraRes P Series are:

- URP98 and URP98-ERO-T:
 - 0-40°C at up to 1000 meters
 - 0-35°C at up to 2000 meters
 - 0-30°C at up to 3000 meters
- All other models:
 - 0-40°C at up to 3000 meters

Cooling Requirements

For optimal performance, active cooling by the installer should be planned for when the ambient temperature anywhere in the wall is predicted to be above the specified ambient temperature for the display.

3.6 ENERGY STAR Certified



ENERGY STAR is a program run by the U.S. Environmental Protection Agency (EPA) and U.S. Department of Energy (DOE) that promotes energy efficiency.

The following products qualify for ENERGY STAR in the factory default settings:

- URP49
- URP49-T
- URP55
- URP55-T
- URP65
- URP65-T
- URP75
- URP75-ERO-T
- URP85
- URP85-ERO-T

The factory default settings are those in which power savings will be achieved. Changing the factory default picture settings or enabling other features will increase power consumption that could exceed the limits necessary to qualify for ENERGY STAR rating.

For more information on the ENERGY STAR program, refer to energystar.gov.

4. Cleaning the Display

If dust has collected on the power plug, remove the plug from the outlet and clean off the dust. Dust build-up may cause a fire.

Remove the power plug before cleaning. Failure to do so may result in electrical shock or damage.

Keep the following points in mind when cleaning the surface of the display:



- When the surface of the display becomes dirty, wipe the surface lightly with a soft clean cloth.
- If the surface requires additional cleaning, use LCD screen cleaner or LCD wipes, which are available at most electronics stores.
- Do not let cleaner seep into the display, as it may cause electrical shock or damage.
- Refer to the Planar Display Cleaning Guidelines for more information.





Unpacking and Checking Accessories

5. Package Contents

Part	Description	Number	Picture
LCD Display	One per box.	1	

6. Accessory Kit

Part	Description	Number	Picture
AC power cord	Power cord.	1	
IEC C14 to NEMA 5-15R adapter cable (optional)	AC Power adapter for an IEC C14 to US NEMA 5-15R AC cable.	1	
Universal power adapter (optional)	AC Power adapter for an IEC C14 to EU/UK AC cable.	1	

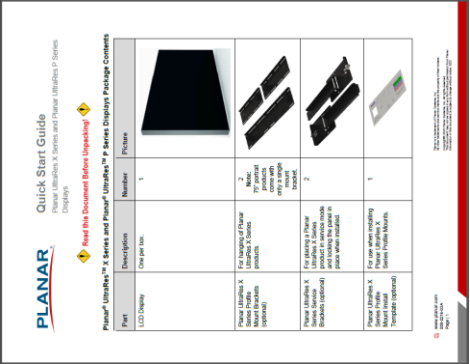
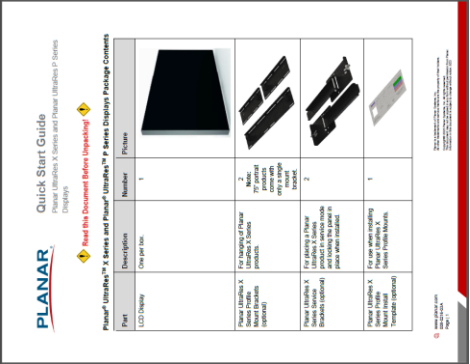
Part	Description	Number	Picture
IR sensor	Used to receive signals from the remote control.	1	
HDMI cable	HDMI cable.	1	
USB cable	Connects to a PC for touch functionality (touch models only) and serial commands (all models).	1	
Remote control	Used to control the display. Two AAA batteries are included but not installed.	1	 <p>URP49 / URP55 / URP65</p>  <p>URP75 / URP85 / URP98</p>
Passive Stylus	Dual-tip stylus. 153mm (6in) length; 7.5mm and 2mm tips (URP49 / URP55 / URP65 touch models only).	1	
Quick Start Guide: Planar UltraRes X Series and Planar UltraRes P Series		1	

7. Planar UltraRes P Series – Standard Inputs

7.1 URP49 / URP49-T

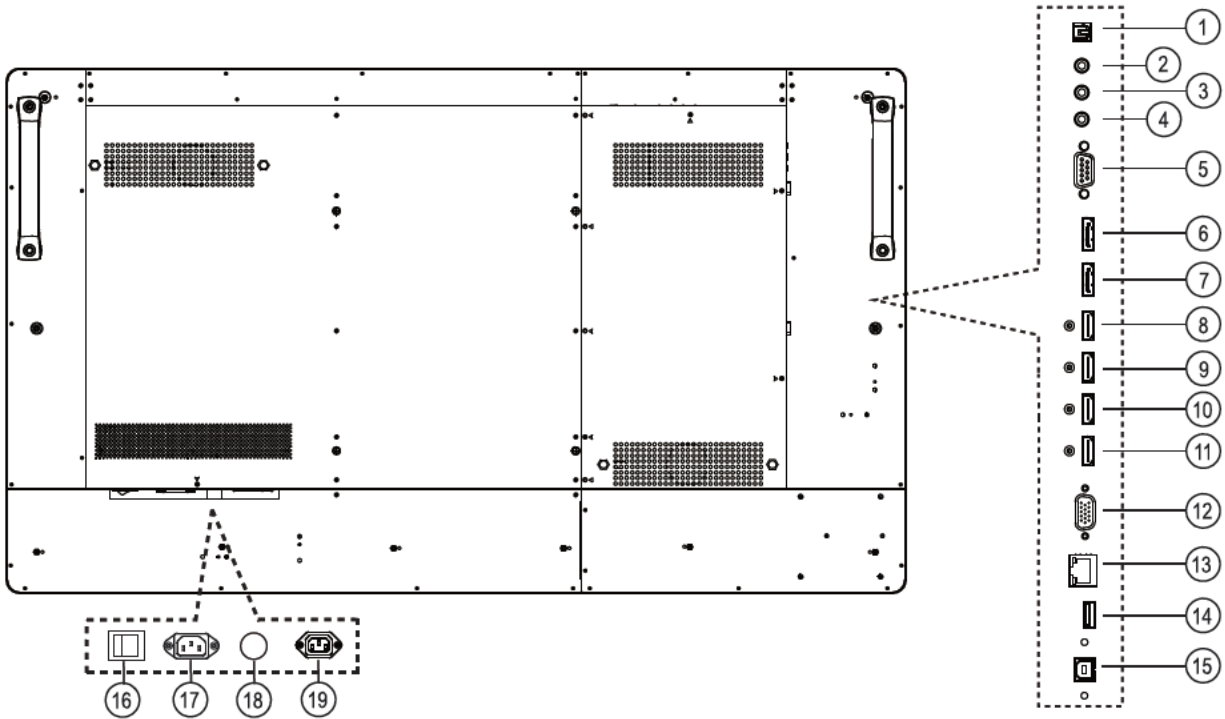

URP49 / URP49-T	Description
1	SPDIF Audio Out
2	Line Audio Out: 3.5mm TRS (female)
3	IR: 3.5mm TRS (female)
4	PC Audio In: 3.5mm TRS (female)
5	VGA
6	DP 1: 4K/60Hz
7	DP 2: 4K/60Hz
8	HDMI 1: HDMI, 4K/60Hz, HDCP 2.2
9	HDMI 2: HDMI, 4K/60Hz, HDCP 2.2
10	HDMI 3: HDMI, 4K/30Hz, HDCP 1.4
11	HDMI 4: HDMI, 4K/30Hz, HDCP 1.4
12	RS232: DB9 (female)
13	LAN
14	USB-A: Service
15	USB-B: Touch
16	AC ON/OFF
17	AC IN: IEC C14
18	AC OUT Fuse: T3.15L/250V
19	AC OUT: IEC C13

7.2 URP55 / URP55-T

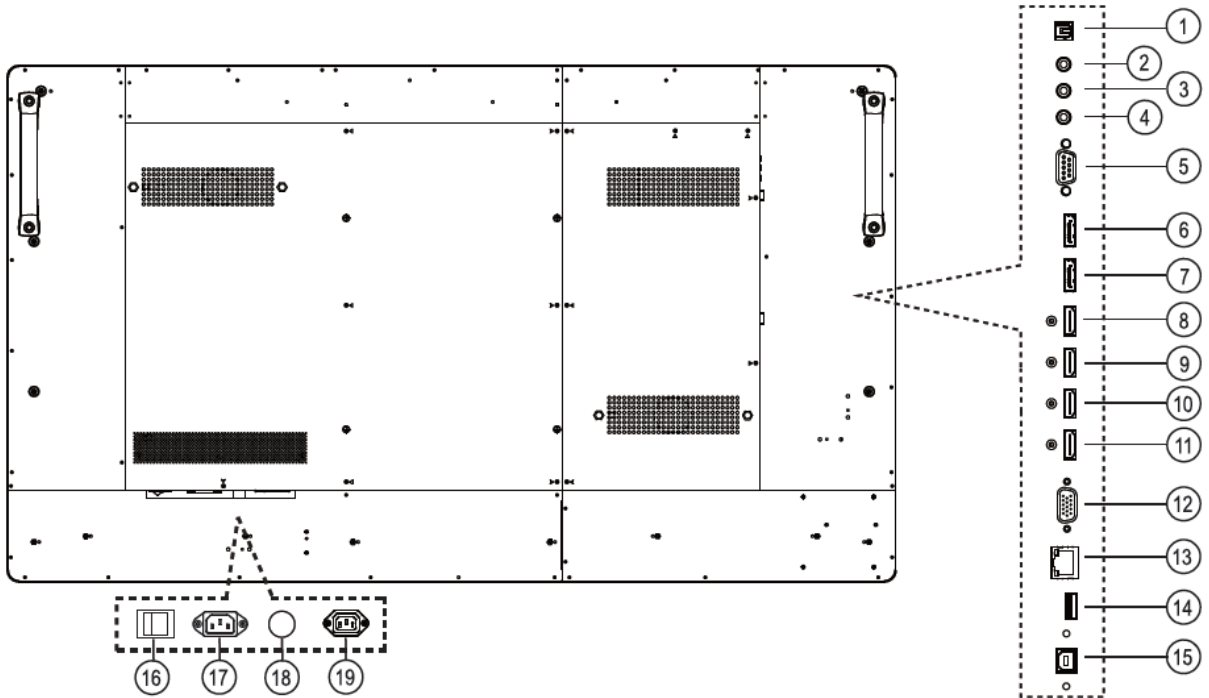

URP55 / URP55-T	Description
1	SPDIF Audio Out
2	Line Audio Out: 3.5mm TRS (female)
3	IR: 3.5mm TRS (female)
4	PC Audio In: 3.5mm TRS (female)
5	VGA
6	DP 1: 4K/60Hz
7	DP 2: 4K/60Hz
8	HDMI 1: HDMI, 4K/60Hz, HDCP 2.2
9	HDMI 2: HDMI, 4K/60Hz, HDCP 2.2
10	HDMI 3: HDMI, 4K/30Hz, HDCP 1.4
11	HDMI 4: HDMI, 4K/30Hz, HDCP 1.4
12	RS232: DB9 (female)
13	LAN
14	USB-A: Service
15	USB-B: Touch
16	AC ON/OFF
17	AC IN: IEC C14
18	AC OUT Fuse: T3.15L/250V
19	AC OUT: IEC C13

7.3 URP65 / URP65-T

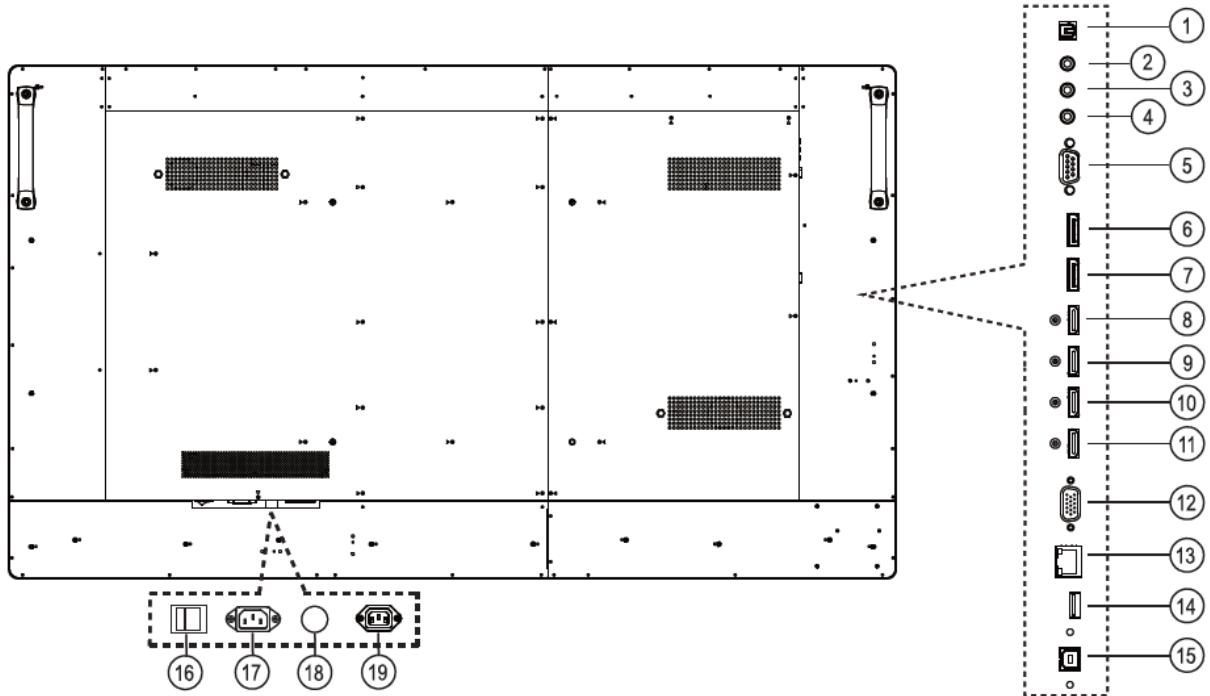

URP65 / URP65-T	Description
1	SPDIF Audio Out
2	Line Audio Out: 3.5mm TRS (female)
3	IR: 3.5mm TRS (female)
4	PC Audio In: 3.5mm TRS (female)
5	VGA
6	DP 1: 4K/60Hz
7	DP 2: 4K/60Hz
8	HDMI 1: HDMI, 4K/60Hz, HDCP 2.2
9	HDMI 2: HDMI, 4K/60Hz, HDCP 2.2
10	HDMI 3: HDMI, 4K/30Hz, HDCP 1.4
11	HDMI 4: HDMI, 4K/30Hz, HDCP 1.4
12	RS232: DB9 (female)
13	LAN
14	USB-A: Service
15	USB-B: Touch
16	AC ON/OFF
17	AC IN: IEC C14
18	AC OUT Fuse: T3.15L/250V
19	AC OUT: IEC C13

7.4 URP75 / URP75-ERO-T

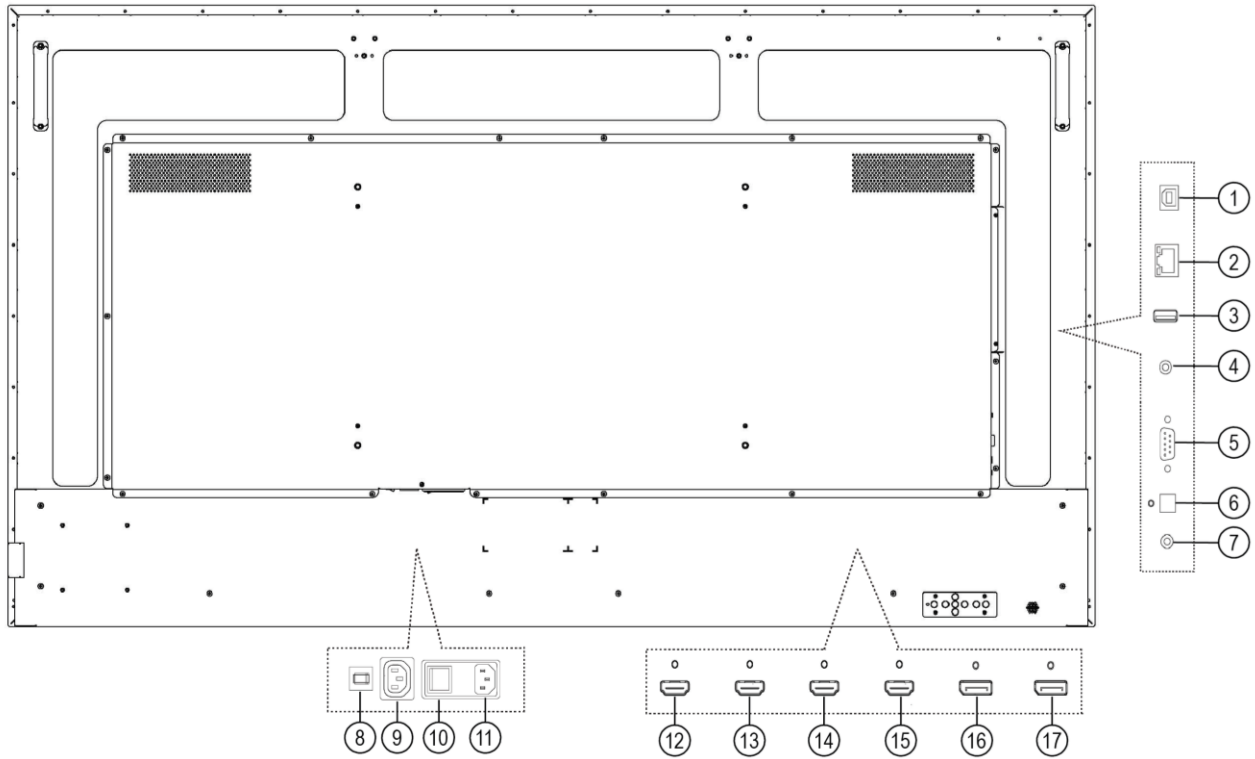

URP75 / URP75-ERO-T	Description
1	USB-B: Touch
2	LAN
3	USB-A: Service
4	IR: 3.5mm TRS (female)
5	RS232: DB9 (female)
6	SPDIF Audio Out
7	Line Audio Out: 3.5mm TRS (female)
8	AC OUT Circuit Breaker: 3A
9	AC OUT: IEC C13
10	AC ON/OFF
11	AC IN: IEC C14
12	HDMI 1: HDMI, 4K/60Hz, HDCP 2.2
13	HDMI 2: HDMI, 4K/60Hz, HDCP 2.2
14	HDMI 3: HDMI, 4K/30Hz, HDCP 1.4
15	HDMI 4: HDMI, 4K/30Hz, HDCP 1.4
16	DP IN: DisplayPort In, 4K/60Hz
17	DP OUT: DisplayPort Out

Note: Only one HDCP 2.2 source can be displayed at a time. If HDMI 1 and HDMI 2 are both being shown on the display at the same time, only HDMI 1 will support HDCP 2.2 content.

Note: DP-OUT can only transmit the content from DP IN. It cannot transmit the content from any HDMI Input.

7.5 URP85 / URP85-ERO-T

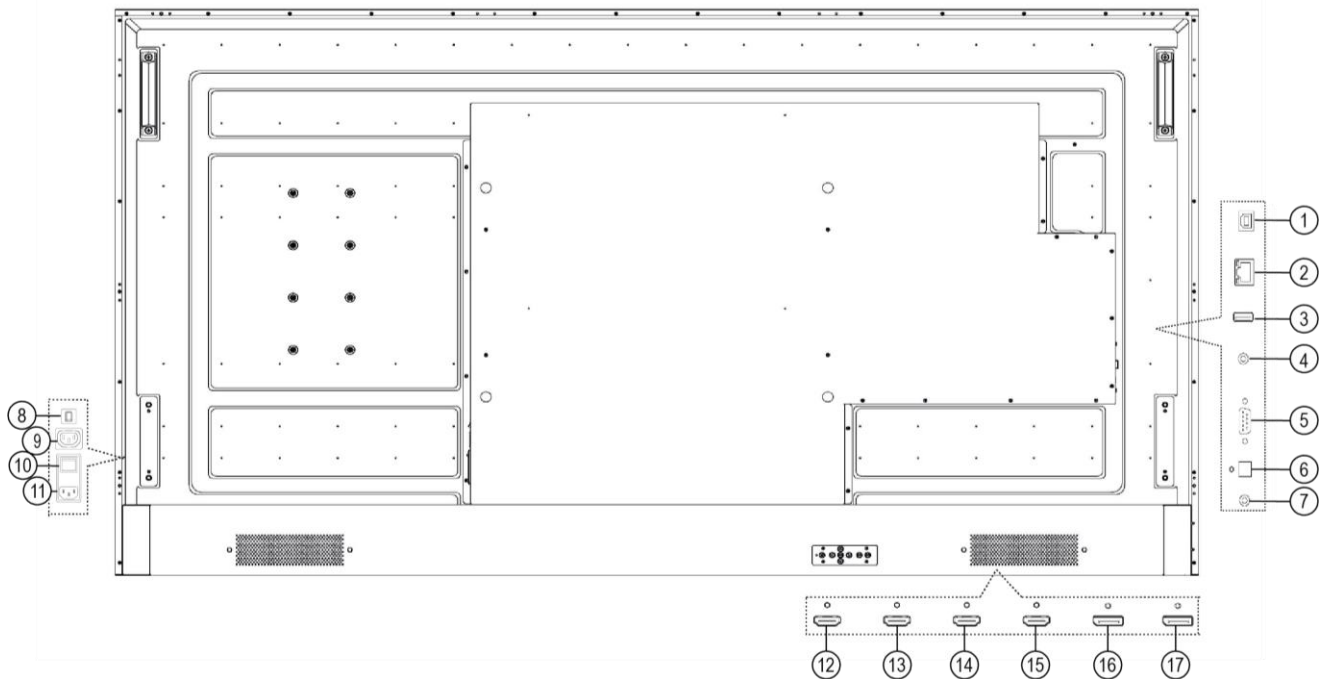

URP85 / URP85-ERO-T	Description
1	USB-B: Touch
2	LAN
3	USB-A: Service
4	IR: 3.5mm TRS (female)
5	RS232: DB9 (female)
6	SPDIF Audio Out
7	Line Audio Out: 3.5mm TRS (female)
8	AC OUT Circuit Breaker: 3A
9	AC OUT: IEC C13
10	AC ON/OFF
11	AC IN: IEC C14
12	HDMI 1: HDMI, 4K/60Hz, HDCP 2.2
13	HDMI 2: HDMI, 4K/60Hz, HDCP 2.2
14	HDMI 3: HDMI, 4K/30Hz, HDCP 1.4
15	HDMI 4: HDMI, 4K/30Hz, HDCP 1.4
16	DP IN: DisplayPort In, 4K/60Hz
17	DP OUT: DisplayPort Out

Note: Only one HDCP 2.2 source can be displayed at a time. If HDMI 1 and HDMI 2 are both being shown on the display at the same time, only HDMI 1 will support HDCP 2.2 content.

Note: DP-OUT can only transmit the content from DP IN. It cannot transmit the content from any HDMI Input.

7.6 URP98 / URP98-ERO-T

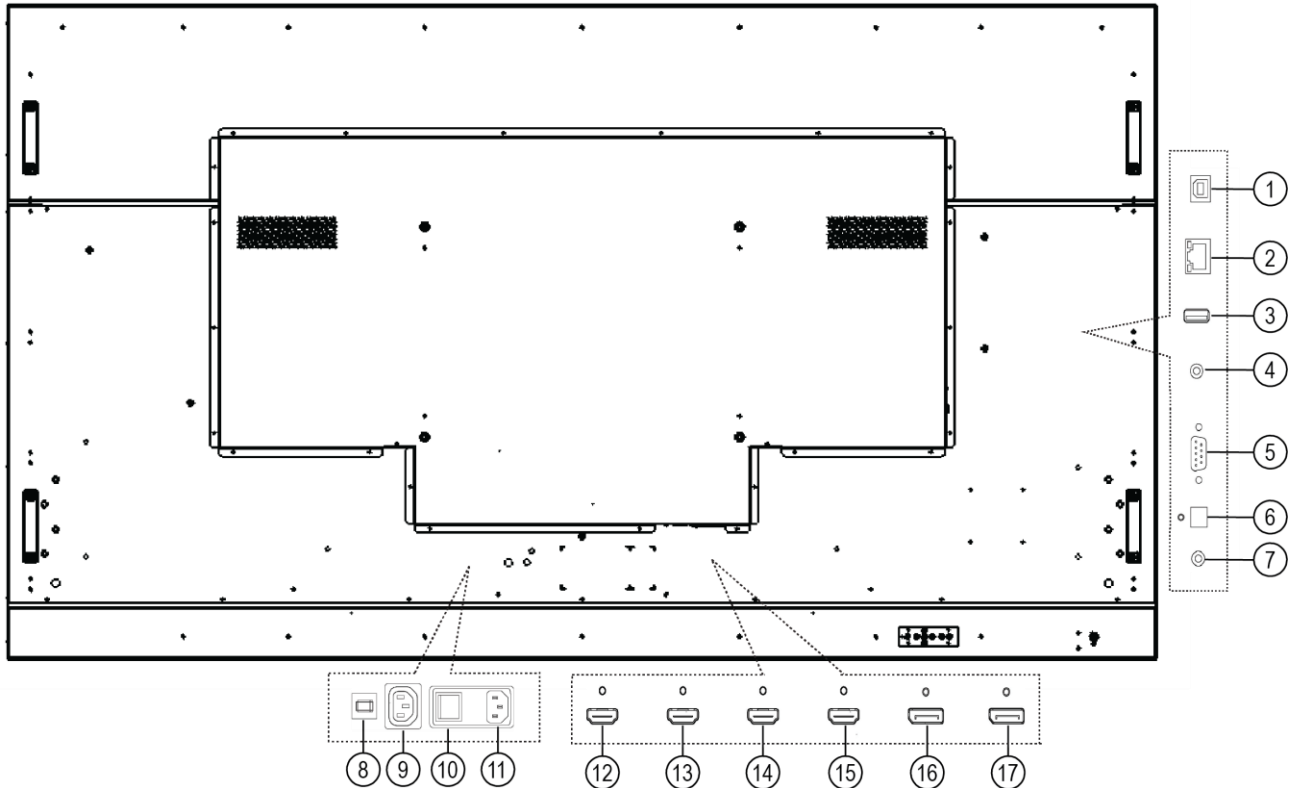

URP98 / URP98-ERO-T	Description
1	USB-B: Touch
2	LAN
3	USB-A: Service
4	IR: 3.5mm TRS (female)
5	RS232: DB9 (female)
6	SPDIF Audio Out
7	Line Audio Out: 3.5mm TRS (female)
8	AC OUT Circuit Breaker: 3A
9	AC OUT: IEC C13
10	AC ON/OFF
11	AC IN: IEC C14
12	HDMI 1: HDMI, 4K/60Hz, HDCP 2.2
13	HDMI 2: HDMI, 4K/60Hz, HDCP 2.2
14	HDMI 3: HDMI, 4K/30Hz, HDCP 1.4
15	HDMI 4: HDMI, 4K/30Hz, HDCP 1.4
16	DP IN: DisplayPort In, 4K/60Hz
17	DP OUT: DisplayPort Out

Note: Only one HDCP 2.2 source can be displayed at a time. If HDMI 1 and HDMI 2 are both being shown on the display at the same time, only HDMI 1 will support HDCP 2.2 content.

Note: DP-OUT can only transmit the content from DP IN. It cannot transmit the content from any HDMI Input.

Installing the Display

This section explains how to install your display. We suggest that you read the entire section before you attempt to install the unit.

8. Before You Begin

Make sure you have all the items in these lists before you begin unpacking and installing your display(s).

8.1 Tools/Equipment List

Depending on your installation, you may need one or more of the following items:

- String/string level
- Digital/laser level
- Ladders/lift
- Power tools
- Back brace
- Stud finder (if hanging display on a wall)

8.2 Other Things You May Need

- LCD screen cleaner or LCD wipes - available at most electronics stores
- At least two very strong people to help lift unit into place

8.3 Plan Your Installation

You should have a detailed plan of how the units are to be configured. The plan should include calculations for the following:

- Power maximums referenced below by display size:

Model	Max Current @ 115VAC (Excluding AC Output)	Max Current @ 115VAC (Including AC Output)
URP49	2.0A	4.85A
URP55	2.2A	5.05A
URP65	2.5A	5.35A
URP75	3.3A	6.3A
URP85	3.9A	6.9A
URP98	4.7A	7.7A

- Cable runs
- Ventilation and cooling requirements
- If hanging display on a wall, location of studs in the wall
- For touch model best performance, the display must be mounted in a vertical to slightly tilted back orientation.
- If the display is a touch model, it is important that the touch frame is not used to lift or support the display or touch performance may be compromised.

- Displays tilted forward can cause touch beam interference from the glass bowing slightly away from the display and into the IR path (URP75-ERO-T, URP85-ERO-T and URP98-ERO-T models only).

8.4 Prepare Your Installation Location

Prepare the area where you will install the unit. If custom enclosures are part of the installation, they must be fully designed to accommodate the installation of the displays, the installed units, and ventilation and cooling requirements.

If your installation includes a lot of construction or dust, it is **highly recommended** that you clean all of the screens after the wall installation and configuration are complete.

8.5 Cable Length Recommendations

Cable length performance may vary between different cables and sources. The recommended maximum cable lengths are as follows:

HDMI

- 4K @ 50/60Hz: 5m (15 ft) maximum
- 4K @ 24/25/30Hz: 15m (50 ft) maximum
- 1080p @ 60Hz and lower resolutions: 20m (65 ft) maximum

DisplayPort

- DP 1.2: 3m (10 ft) maximum
- DP 1.1: 5m (15 ft) maximum

9. Mounting

9.1 Mounting Display with a VESA Mount

If you purchased a VESA mount, you should have received a separate box with mounting supplies and an Installation manual. Follow these instructions carefully.

Keep in mind the following general installation guideline:

- Screw length is crucial and will vary depending on the type of mount you use. Total screw length will include the penetration length plus the length required by the type of VESA mount in use.

Caution: Screws not sized to the depth specified can result in inadequate mounting strength or damage to the internal components in the display. To prevent injury, this device must be securely attached to the wall in accordance with the installation instructions supplied with the mount. The mount must be secured to the Planar UltraRes P Series display using the four M8-1.25 VESA mounting locations, and 10mm -15mm thread engagement is required for secure mounting. Select the correct screw/spacer combination for the mount.

- Prior to installation, make sure you know where all of the mounting points are located.
- Follow all safety precautions outlined in the VESA Installation manual.
- Verify the parts received with the list shown in the VESA Installation manual.

9.2 Mounting a Peripheral Device

A 100 mm x 100 mm VESA mounting interface is located on the rear of the display to accommodate a third-party media player or computer. If needed, local power is available through the AC OUT connector.

Operating the Display

10. OSD Keypad

The OSD keypad is located on the rear of the display.

10.1 URP75 / URP85 / URP98



OSD Keypad Buttons

Key	Descriptions
Power	Power on/Power off
◀	Menu Left/Decrease value
▶	Menu Right/Increase value
▲	Menu Up/Increase volume
▼	Menu Down/Decrease volume
Menu/Exit	Menu/Exit
Source	Source selection (toggle)

10.2 URP49 / URP55 / URP65



OSD Keypad Buttons

Key	Descriptions
Power	Power on/Power off
Source	Source selection (toggle)
▶	Menu Right/Increase value
◀	Menu Left/Decrease value
▲	Menu Up
▼	Menu Down
Menu/Exit	Menu/Exit

11. Remote Control Receiver

The location of the IR remote control receiver is highlighted in the images below. An IR extender cable is included in the accessories package for additional flexibility.

URP49 / URP55 / URP65

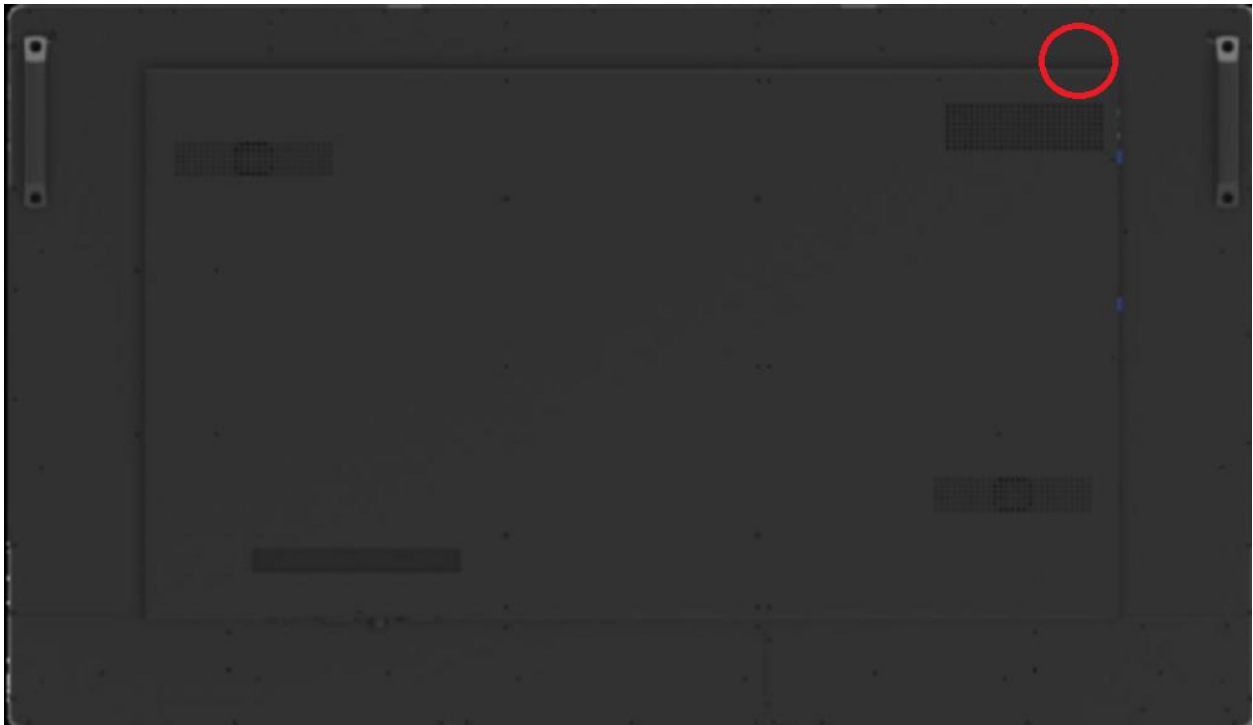

URP75



URP85



URP98

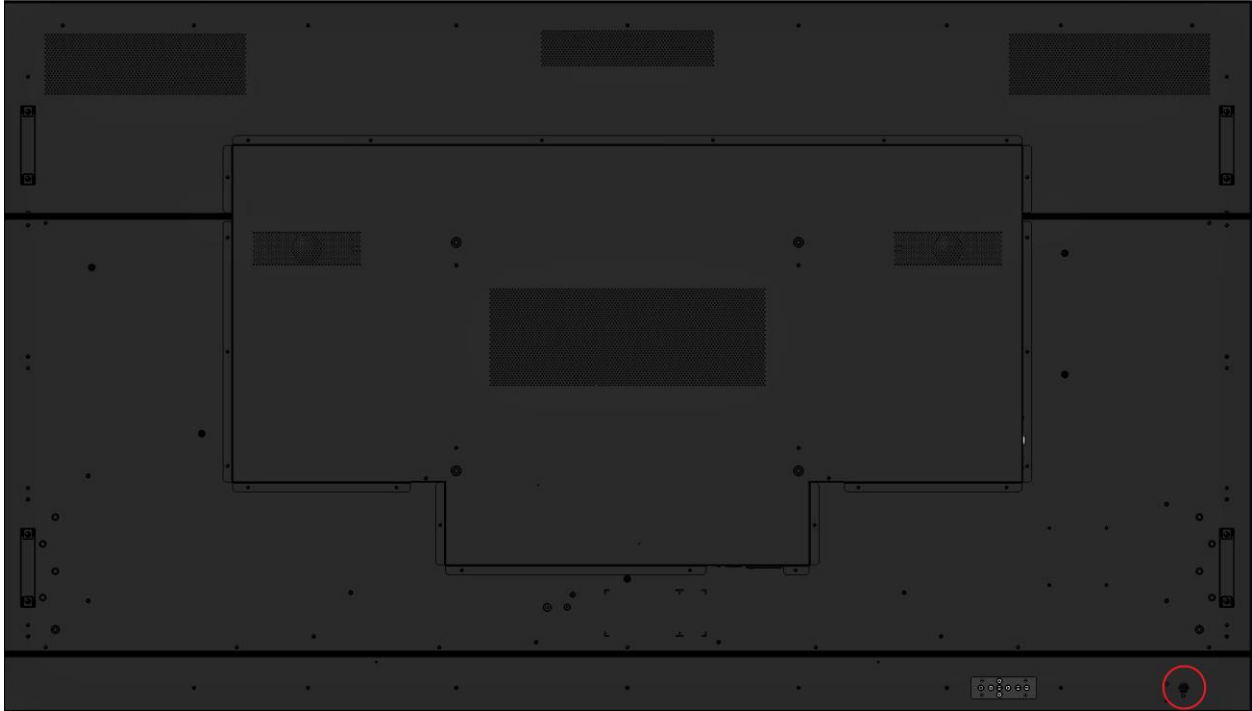

12. LED Indicators

The LED indicator light is located on the rear of the display near the keypad. The following tables explain what the different colors and blink patterns mean.

LED On (URP49 / URP55 / URP65)

Power Status	Condition
Green	Power on
Blinking Orange	No signal
Orange	Power saving mode
Off	AC off
Off	Power off

LED On (URP75 / URP85 / URP98)

Power Status	Condition
Green	Standby mode
Amber	Full power mode
Green Flashing (1 Hz)	AC power on
Green Flashing (0.5 Hz)	Powering on from standby
Green Flashing (5 Hz)	Firmware updating
Amber Flashing (5 Hz)	Power supply failure
Green and Amber	Firmware update failure

13. Using the Display in Portrait Mode

When using the display in the portrait position and looking at the rear of the display, it should be rotated according to the arrow stickers on the back of the display. This will allow for proper ventilation. Then select the OSD rotation of landscape or portrait on the OSD menu (MAIN MENU > ADVANCED SETTINGS > MENUS AND MESSAGES > OSD ROTATION).

For reference, the following list indicates the rotation direction of each display model when placed in portrait mode as viewed from the display side:

- URP49(-T): Counterclockwise
- URP55(-T): Counterclockwise
- URP65(-T): Counterclockwise
- URP75(-ERO-T): Counterclockwise
- URP85(-ERO-T): Counterclockwise
- URP98(-ERO-T): Counterclockwise

Caution: Failure to follow these instructions will void the warranty.

14. Using the Display in Flat or Tilted Orientation

The display is not recommended for use in flat orientation for tabletop, floor, or ceiling installations. LCD panels of this size are at risk of panel deflection, which can cause cosmetic sagging, brightness uniformity issues, a shortened life span, and malfunction of optional touch sensors. Installations where the display is tilted downward or upward at an angle may also be prone to these issues and are not recommended.

Note: Failure to follow these instructions will void the warranty.

15. Using the Remote Control

Below are pictures of the remotes. See next section for Hex codes.



URP49 / URP55 / URP65 Remote: 952-0088-00



URP75 / URP85 / URP98 Remote: 952-0086-00

16. IR Command Protocol

The Planar UltraRes P Series displays accept commands in the form of IR signals that conform to the NEC protocol. Each Planar UltraRes P Series remote control has an NEC control code associated with it. You can use these codes to program a third-party “universal” remote control to work with the Planar UltraRes P Series displays. These third-party products usually come with a computer software application for this purpose. For more information, consult the documentation provided with the remote control.

The IR control codes have the following characteristics:

- Each code consists of the following:
 - A leader pulse (a modulated pulse of 9 ms followed by a non-modulated pulse of 4.5 ms)
 - 16 address bits. The default address is 1785 (0x06F9, binary 00000110 11111001)
 - 16 data bits: eight (8) bits for the command followed by the logical inverse of the command
 - An end pulse (a modulated pulse of 0.56 ms, similar to the modulated pulse in the ‘0’ and ‘1’ bits). The end of the modulated pulse constitutes the end of the data transmission.
 - The carrier frequency is 38 kHz, with the modulated pulses having a 33% duty cycle.
 - Commands are sent at a maximum rate of 9 Hz.

For example, below is the NEC control code for the ON button of the Planar UltraRes P Series remote control (assuming the default address is used).

Hex	06	F9	01	FE
Binary	00000110	11111001	00000001	11111110
Function	Address Byte 1	Address Byte 2	Command	Command (Logical Inverse)
	1	2		

The following example shows the pulse train for this command.



16.1 Hex Codes (URP49 / URP55 / URP65)

The following hex codes are for the URP49 / URP55 / URP65 remote control shown in section 15.

Function	Customer Code	Hex Code	Description
INFO	40AF	04FB	Provides source and resolution information
	40AF	1CE3	Turns the display on and off
VGA	40AF	07F8	Selects the VGA source
DP1	40AF	08F7	Selects the DP1 source
HDMI1	40AF	09F6	Selects the HDMI source 1
DP2	40AF	0BF4	Selects the DP2 source
HDMI2	40AF	0CF3	Selects the HDMI source 2
P- POSITION	40AF	1AE5	Selects the PiP (Picture-in-Picture) position
OPS	40AF	15EA	Selects the OPS source
HDMI3	40AF	10EF	Selects the HDMI source 3
PIP	40AF	11EE	Selects the Multi-Source View
HDMI4	40AF	16E9	Selects the HDMI source 4
SWAP	40AF	06F9	Swaps the main input source with source 2
P-SOURCE	40AF	13EC	Selects the PiP (Picture-in-Picture) source
▲	40AF	02FD	Navigates up through submenus and settings
◀	40AF	01FE	Navigates back through submenus and settings
MENU	40AF	0EF1	Opens the display's on-screen menu system. When the menu system is already open, pressing this button will select the previous submenu.
▶	40AF	03FC	Navigates forward through submenus and settings
▼	40AF	19E6	Navigates down through submenus and settings

Function	Customer Code	Hex Code	Description
ENTER	40AF	12ED	Selects highlighted menu choices
EXIT	40AF	05FA	Closes the menu system
SCALING	40AF	14EB	Toggles between different aspect ratios (Auto, Native, 4 x 3, Full Screen and Letterbox)
FREEZE	40AF	43BC	Freezes the current source image
MUTE	40AF	00FF	Turns off the sound
BRIGHT	40AF	17E8	Adjusts the brightness
CONTRAST	40AF	18E7	Adjusts the contrast
AUTO	40AF	1EE1	Synchronizes the display to the source
SOURCE	40AF	0FF0	Allows selection of the different sources
VOLUME -	40AF	1BE4	Decreases the sound volume
VOLUME +	40AF	1DE2	Increases the sound volume
ON	06F9	01FE	Turns the display on
OFF	06F9	09F6	Turns the display off

The following hex codes for the URP75 / URP85 / URP98 remote shown in section 15 are also functional on the URP49, URP55 and URP65.

Key Name	Address	Data	NEC Data From Remote	Description
ON	1785	1	0x06F901FE	Power On
PRESET 1	1785	5	0x06F905FA	Applies Preset 1
PRESET 2	1785	7	0x06F907F8	Applies Preset 2
PRESET 3	1785	8	0x06F908F7	Applies Preset 3
OFF	1785	9	0x06F909F6	Power Off
PRESET 4	1785	10	0x06F90AF5	Applies Preset 4
MENU	1785	21	0x06F915EA	Opens the menu
PREVIOUS	1785	22	0x06F916E9	Exits the menu
ENTER	1785	23	0x06F917E8	Selects the current menu item
DOWN	1785	24	0x06F918E7	Navigate down
UP	1785	26	0x06F91AE5	Navigate up
VOL +	1785	28	0x06F91CE3	Volume increase
LEFT	1785	29	0x06F91DE2	Navigate left
RIGHT	1785	31	0x06F91FE0	Navigate right
MUTE	1785	32	0x06F920DF	Audio mute
VOL -	1785	33	0x06F921DE	Volume decrease
ZONE 1	1785	35	0x06F923DC	Opens the source menu
PIP MODE	1785	37	0x06F925DA	Selects the Multi-Source View
PIP SWAP	1785	40	0x06F928D7	Swaps the main input source with source 2
HDMI 1	1785	41	0x06F929D6	Selects the HDMI 1 input
HDMI 2	1785	42	0x06F92AD5	Selects the HDMI 2 input
HDMI 3	1785	43	0x06F92BD4	Selects the HDMI 3 input
HDMI 4	1785	44	0x06F92CD3	Selects the HDMI 4 input
DP	1785	45	0x06F92DD2	Selects the DP 1 input
DVI	1785	46	0x06F92ED1	Selects the DP 2 input
VGA	1785	47	0x06F92FD0	Selects the VGA input

16.2 Hex Codes (URP75 / URP85 / URP98)

Remote Control Button Name	Address	Data	NEC Data From Remote (Hex Code)	Description
ON	1785	1	0x06F901FE	Power on
OFF	1785	9	0x06F909F6	Power off
◀	1785	2	0x06F902FD	Not used
▶	1785	3	0x06F903FC	Not used
**	1785	6	0x06F906F9	Not used
PRESETS	1785	4	0x06F904FB	Opens the Presets menu
PRESET 1	1785	5	0x06F905FA	Applies Preset 1
PRESET 2	1785	7	0x06F907F8	Applies Preset 2
PRESET 3	1785	8	0x06F908F7	Applies Preset 3
PRESET 4	1785	10	0x06F90AF5	Applies Preset 4
1	1785	12	0x06F90CF3	Number button 1
2	1785	13	0x06F90DF2	Number button 2
3	1785	14	0x06F90EF1	Number button 3
4	1785	15	0x06F90FF0	Number button 4
5	1785	16	0x06F910EF	Number button 5
6	1785	17	0x06F911EE	Number button 6
7	1785	20	0x06F914EB	Number button 7
8	1785	25	0x06F919E6	Number button 8
9	1785	27	0x06F91BE4	Number button 9
0	1785	18	0x06F912ED	Number button 0
VOL +	1785	28	0x06F91CE3	Volume increase
VOL -	1785	33	0x06F921DE	Volume decrease
MUTE	1785	32	0x06F920DF	Audio mute
COLOR	1785	19	0x06F913EC	Not used

Remote Control Button Name	Address	Data	NEC Data From Remote (Hex Code)	Description
VIDEO WALL	1785	34	0x06F922DD	Opens the Tiling menu
MISC	1785	11	0x06F90BF4	Opens the Image Information menu
MENU	1785	21	0x06F915EA	Opens the menu
PREV	1785	22	0x06F916E9	Returns to the previous menu
ENTER	1785	23	0x06F917E8	Selects the current menu item
UP	1785	26	0x06F91AE5	Navigate up
LEFT	1785	29	0x06F91DE2	Navigate left
RIGHT	1785	31	0x06F91FE0	Navigate right
DOWN	1785	24	0x06F918E7	Navigate down
TOP	1785	30	0x06F91EE1	Selects the top line in the current menu
ZONE 1	1785	35	0x06F923DC	Selects the input for Zone 1
ZONE 2	1785	36	0x06F924DB	Selects the input for Zone 2
ZONE 3	1785	38	0x06F926D9	Selects the input for Zone 3
ZONE 4	1785	39	0x06F927D8	Selects the input for Zone 4
PIP MODE	1785	37	0x06F925DA	Selects the Multi-Source View setting
PIP SWAP	1785	40	0x06F928D7	Swaps the main and PIP windows
HDMI 1	1785	41	0x06F929D6	Selects HDMI 1 for the current zone
HDMI 2	1785	42	0x06F92AD5	Selects HDMI 2 for the current zone
HDMI 3	1785	43	0x06F92BD4	Selects HDMI 3 for the current zone
HDMI 4	1785	44	0x06F92CD3	Selects HDMI 4 for the current zone
DP	1785	45	0x06F92DD2	Selects DP for the current zone
DVI	1785	46	0x06F92ED1	Not used
VGA	1785	47	0x06F92FD0	Not used
OPS	1785	48	0x06F930CF	Not used

16.3 Locking the Keypad and IR Remote

You can lock the keypad and IR remote functionality on the display. To lock the keypad, go to Main Menu -> Advanced Settings -> System Settings and select Keypad Lock. To lock the IR remote, go to Main Menu -> Advanced Settings -> System Settings and select IR Remote Lock.

16.4 Locking/Unlocking the OSD Menus (URP49 / URP55 / URP65)

You can lock or unlock the OSD menus by pressing a series of key commands on the remote control. To **lock** the menu, press the following keys on the remote in the order listed: ENTER, ENTER, EXIT, EXIT, ENTER and EXIT. To **unlock** it, simply follow the same sequence.

Depending on whether you locked or unlocked the menu, you will see one of the following messages on the screen.



16.5 Unlocking the Keypad and IR Remote (URP75 / URP85 / URP98)

To unlock the keypad, press the following keys on the keypad in the order listed: UP, UP, RIGHT, LEFT, DOWN. If the IR remote is unlocked, you can also unlock the keypad by using the IR remote to go to Main Menu -> Advanced Settings -> System Settings and uncheck Keypad Lock.

To unlock the IR remote, press the following keys on the IR remote in the order listed: UP, UP, RIGHT, LEFT, DOWN. If the keypad is unlocked, you can also unlock the IR remote by using the keypad to go to Main Menu -> Advanced Settings -> System Settings and uncheck IR Remote Lock.

16.6 Changing the IR Remote Code Set

The IR remote code set transmitted by the remote and accepted by the display can be configured. This is useful if there are multiple Planar displays and you would like each remote to work only with one of the displays. It can also be used if IR interference with another device, such as a DVD player, is occurring.

To change the IR code on the remote, use the following procedure:

1. Press and hold the CODE button on the remote control until the LED on the remote lights solid red (approximately five seconds).
2. Enter a new five-digit code between 00000 and 65535. Include leading zeros for codes with four or fewer digits; for example, enter 255 as 00255.
3. The LED turns off to confirm the code change. If you enter an invalid code, the LED flashes for three or four seconds. Try again, entering a valid code.

Note: The code must match the IR Remote ID Code setting. See page 74.

Note: This feature requires the IR remote part # 952-0086-00. This remote ships standard with the URP75, URP85 and URP98. To use this feature on URP49 / URP55 / URP65, the remote must be ordered by contacting Planar.

16.7 Turning the Display On

1. Insert the power cord into the display and into the power outlet.
2. Ensure the AC switch is set to “—”.
3. Press the ON button on the remote or the power button on the keypad.

16.8 Turning the Display Off

With the power on, press the OFF button on the remote or the power button on the keypad to put the LCD panel in a standby mode. To turn off power completely, turn the AC switch to “O” or disconnect the AC power cord from the power outlet.

Note: The display may automatically turn off the backlight or enter standby mode if no signal is present for a certain period of time. See the description of the Power Saving Mode setting on page 52 for more information.

16.9 Adjusting the Volume

1. Using the remote, press the vol + or vol - to increase or decrease the volume. You can also use the Up and Down keys on the remote and keypad to increase or decrease the volume.
2. Press the mute button to temporarily turn off all sound. To restore the sound, press the mute button again.

Note: The analog audio out is variable. S/PDIF is fixed.

16.10 Selecting Layouts and Input Sources

With Planar MediaPlex Plus Processing, you can show one source at a time or multiple sources simultaneously. Multiple layout options are available and can be selected from the Inputs and Views Menu (see page 43). Once a layout has been designated, you can assign sources to each of the zones in the layout. The selection of sources must be made one at a time by assigning a current zone. To select the current zone, you can navigate through the on-screen menu (see page 43). Alternatively, you can use the remote or keypad as described next.

Remote

Press the Zone 1, Zone 2, Zone 3, or Zone 4 buttons on the remote. After selecting the desired zone, you can press the source button (DP, HDMI 1, HDMI 2, HDMI 3, or HDMI 4). This action will also select the active audio source.

For example, to change Zone 3 to DP, press the Zone 3 button and then press the DP button.

Keypad

Press the SRC/Source button. The input source will be toggled sequentially.

Note: Sources will toggle through the current zone, or last zone to be modified. Current zones can only be re-assigned in the on-screen menu.

Note: This feature requires the IR remote part # 952-0086-00. This remote ships standard with the 75", 85" and 98". To use this feature on the URP49 / URP55 / URP65, the remote must be ordered by contacting Planar.

16.11 Navigating Through the Menus

1. With the power on, press MENU. The MAIN menu appears.

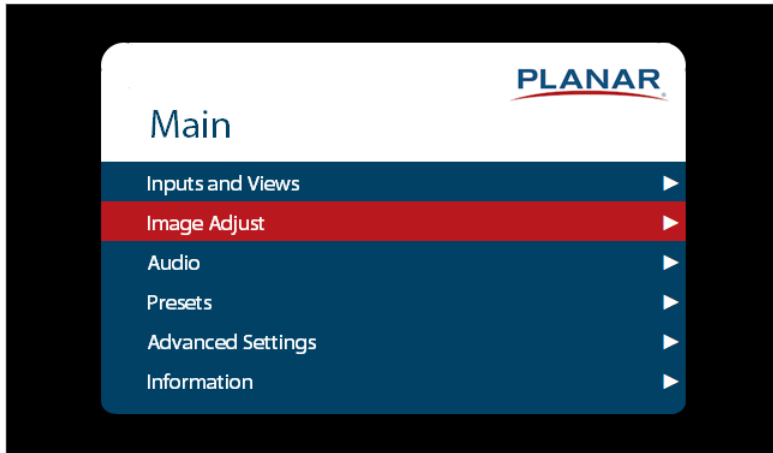

2. Within the menu, use ▲, ▼, ◀, ▶, and ENTER to navigate through the menus and adjust options.
3. (*URP75 / URP85 / URP98 Remote*) Press PREV on the remote control, or MENU on the keypad, to return to the previous menu. To exit the menu system, press MENU on the remote control, or continue to press menu on the keypad until the main menu is reached.
4. (*URP49 / URP55 / URP65 Remote*) Press MENU on the remote control, or MENU/EXIT on the keypad, to return to the previous menu. To exit the menu system, press EXIT on the remote control, or continue to press MENU/EXIT on the keypad until the main menu is reached.

17. Inputs and Views Menu

This menu shows how the sources will be laid out on the screen based on the current Multi-Source View and Advanced Layouts selections.

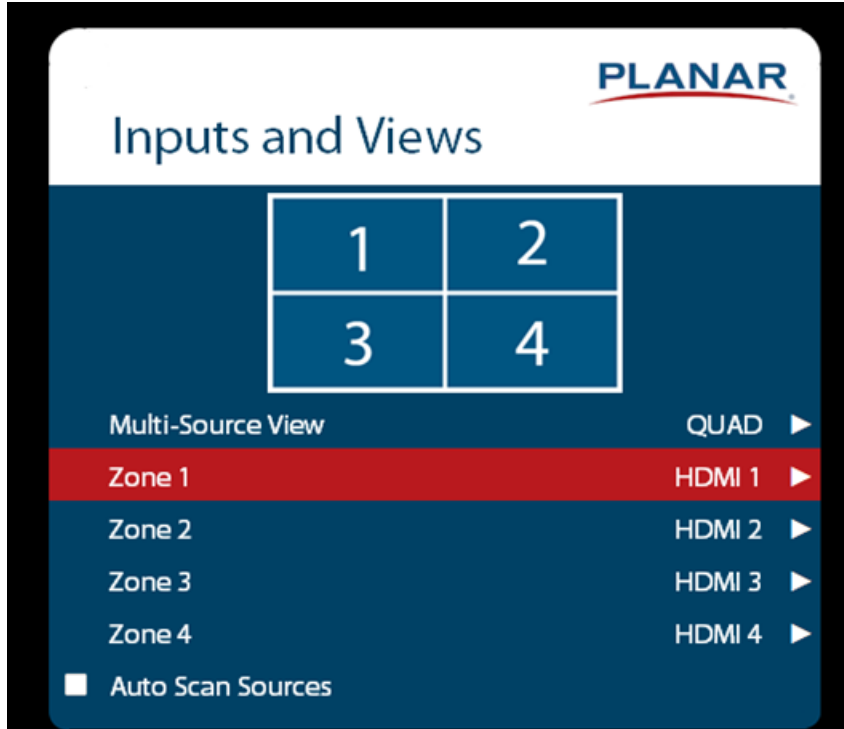

Multi-Source View

- Select the Multi-Source View mode
- **Options:** Single View, Dual View, Triple View, Quad View, PiP, Advanced Layouts;
Default: Single
- **Note:** Triple View is supported on URP75 / URP85 / URP98 only.
- **Note:** For the Advanced Layouts submenu, refer to the Advanced Layouts Submenu on page 44.
- **Note:** URP75 / URP85 / URP98 do not support 4K/60Hz in multi-source view.

Zone 1

- Select the source displayed in Zone 1
- **Options:** HDMI 1, HDMI 2, HDMI 3, HDMI 4, DP, DP2, VGA; **Default:** HDMI 1
- **Note:** DP2 and VGA are supported on URP49 / URP55 / URP65 only.

Zone 2

- Select the source displayed in Zone 2
- **Options:** HDMI 1, HDMI 2, HDMI 3, HDMI 4, DP, DP2, VGA; **Default:** HDMI 2
- **Note:** DP2 and VGA are supported on URP49 / URP55 / URP65 only.

Zone 3

- Select the source displayed in Zone 3
- **Options:** HDMI 1, HDMI 2, HDMI 3, HDMI 4, DP, DP2, VGA; **Default:** HDMI 3
- **Note:** DP2 and VGA are supported on URP49 / URP55 / URP65 only.

Zone 4

- Select the source displayed in Zone 4
- **Options:** HDMI 1, HDMI 2, HDMI 3, HDMI 4, DP, DP2, VGA; **Default:** HDMI 4
- **Note:** DP2 and VGA are supported on URP49 / URP55 / URP65 only.

Zone 1 Secondary

- Second input to scan when Auto Scan Sources is set to **Failover**
- **Options:** HDMI 1, HDMI 2, HDMI 3, HDMI 4, DP, DP2, VGA; **Default:** HDMI 1
- **Note:** DP2 and VGA are supported on URP49 / URP55 / URP65 only.

Auto Scan Sources

- Select whether the display will automatically scan for a valid source on any input or zone that does not have a source currently displayed.
- **Options:** Off, On, Failover; **Default:** Off
- **Off:** Display will stay on current selection of inputs.
- **On:** Scanning will begin on the currently selected source and move sequentially through the inputs in the order listed below – stopping once a valid source is obtained.
 - **Search Order:** HDMI 1, HDMI 2, HDMI 3, HDMI 4, DP, DP2, VGA
 - **Note:** DP2 and VGA are supported on URP49 / URP55 / URP65 only.
- **Failover:** Display will scan selected Zone 1 input and selected Zone 1 Secondary input for a valid source. Only applies to Zone 1.

Advanced Layouts Submenu

This submenu defines the layouts for each multi-source view type.

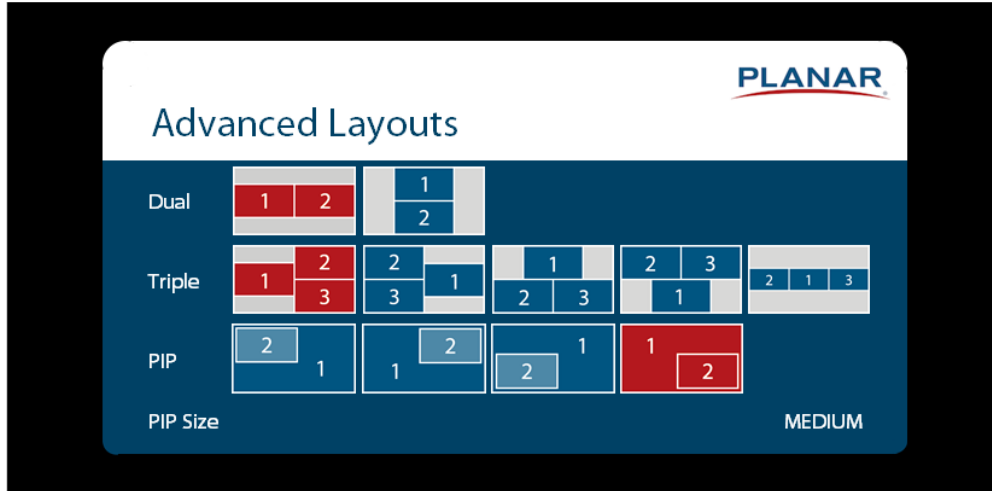

Dual (URP75 / URP85 / URP98 only)

- Select from two dual source layout options. The layout in orange will be the active layout displayed when the Multi-Source View is set to Dual.

Triple (URP75 / URP85 / URP98 only)

- Select from five triple source layout options. The layout in orange will be the active layout displayed when the Multi-Source View is set to Triple.

PIP

- Select from four PiP (Picture-in-Picture) layouts. The layout in orange will be the active layout displayed when the Multi-Source View is set to PiP.

PIP Size

- Select the size of the PiP (Picture-in-Picture) window.

17.1 Image Adjust Menu

This menu is used for making common image adjustments for the current zone.

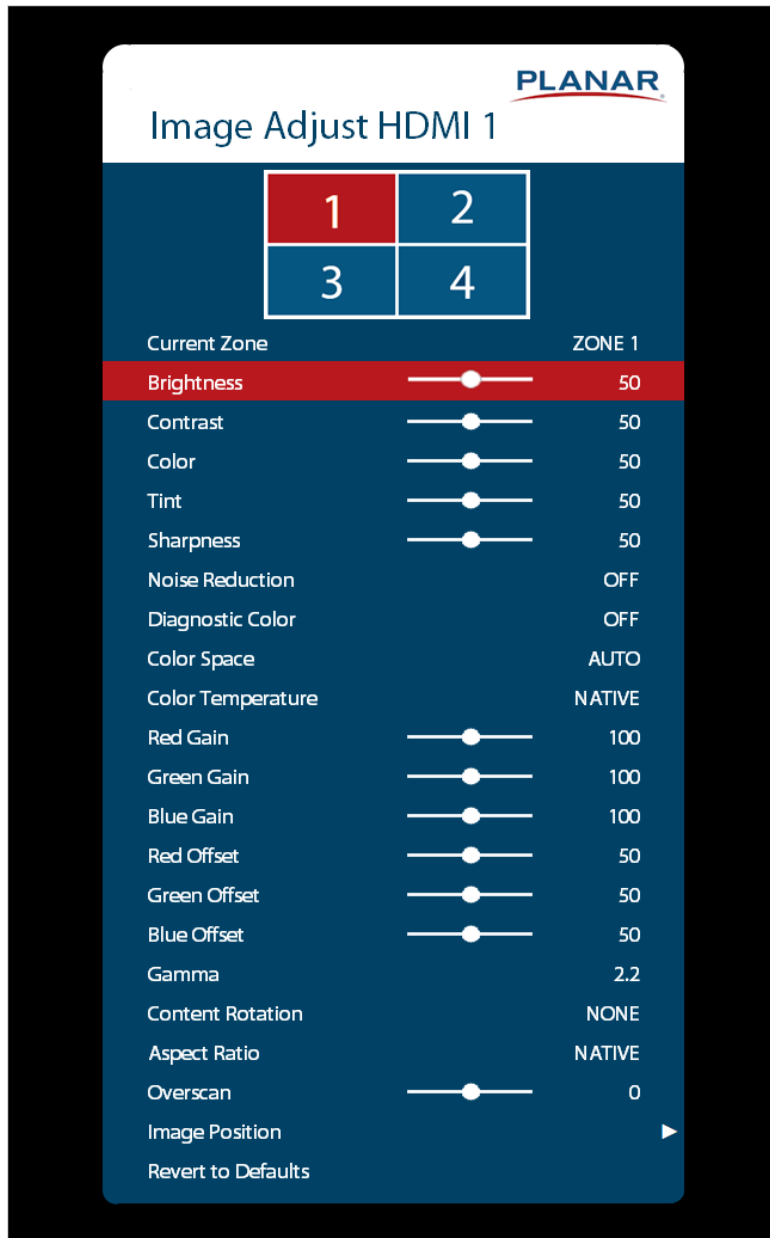

Current Zone

- The zone that is currently being adjusted. All of the settings in this menu are saved per input. The zone's corresponding input source is shown in the title bar, and the graphic beneath that shows which zone is being adjusted in the current Multi-Source View mode and Advanced Layout setting (if applicable).
- The current zone can be changed via the menu or by using the ZONE 1-4 keys on the remote control.
- **Note:** Changing the Current Zone setting via the ZONE 1-4 keys also changes the Audio Select setting.

Brightness

- Adjust the black level of the image
- **Range:** 0~100; **Default:** 50

Contrast

- Adjust the white level of the image
- **Range:** 0~100; **Default:** 50

Color

- Adjust the saturation of the image
- **Range:** 0~100; **Default:** 50

Tint

- Adjust the hue of the image
- **Range:** 0~100; **Default:** 50

Sharpness

- Adjust the sharpness of the image. Higher numbers are sharper
- **Range:** 0~10; **Default:** 5

Noise Reduction (URP75 / URP85 / URP98 only)

- Turn on noise reduction processing
- **Options:** Off, Low, Medium, High; **Default:** Off

Diagnostic Color (URP75 / URP85 / URP98 only)

- Set the image to monochrome. This setting is for use in adjustments to a test pattern and is not stored.
- **Options:** Off, Red, Green, Blue; **Default:** Off

Color Space

- Set the color space of the image
- **Options:** REC601, REC709, RGB, RGB Video, Auto; **Default:** Auto

Color Temperature

- Set the color temperature of the image
- **Options:** 3200K, 5500K, 6500K, 7500K, 9300K, Native; **Default:** Native

Red Gain

- Adjust the red gain of the image
- **Range:** 0~200; **Default:** 100

Green Gain

- Adjust the green gain of the image
- **Range:** 0~200; **Default:** 100

Blue Gain

- Adjust the blue gain of the image
- **Range:** 0~200; **Default:** 100

Red Offset

- Adjust the red offset of the image
- **Range:** 0~100; **Default:** 50

Green Offset

- Adjust the green offset of the image
- **Range:** 0~100; **Default:** 50

Blue Offset

- Adjust the blue offset of the image
- **Range:** 0~100; **Default:** 50

Gamma

- Set the gamma of the image
- **Options:** 1.85, 1.9, 1.95, 2.0, 2.05, 2.1, 2.15, 2.2, 2.25, 2.3, 2.35, 2.4, 2.45, 2.5, 2.55, 2.6, 1.5, 1.55, 1.6, 1.65, 1.7, 1.75, 1.8, 2.65, 2.7, 2.75, 2.8 also available on URP75 / URP85 / URP98.
- **Default:** 2.2

Content Rotation (URP75 / URP85 / URP98 only)

- Rotate the image on the display
- **Options:** None, 90, 180, 270; **Default:** None

Aspect Ratio

- Set how the source is treated when the aspect ratio of the input is different than the aspect ratio of the zone it is in. If the image does not fill the zone completely, the extra margins are black.
- **Options:** Auto, 16:9, 4:3, Fill Screen, Native, Letterbox; **Default:** Auto

Overscan

- Set the percentage of the image to remove from each edge
- **Range:** 0~20; **Default:** 0

Phase (URP49 / URP55 / URP65 only)

- Adjust the phase of the displayed signal (VGA source only)
- **Range:** 0~100

Tracking (URP49 / URP55 / URP65 only)

- Adjust the phase of the displayed signal (VGA source only)
- **Range:** 0~100

Image Position

- Move the image horizontally or vertically. The amount to move is measured in input pixels.
- **Range:** -1000~1000; **Default:** 0

Revert to Defaults

- Reset all settings in the Image Adjust menu to their factory defaults for the current zone only

17.2 Audio Menu

This menu enables you to make audio adjustments to the selected zone.

Note: Volume, Bass, Treble and Balance do not apply to the S/PDIF output.

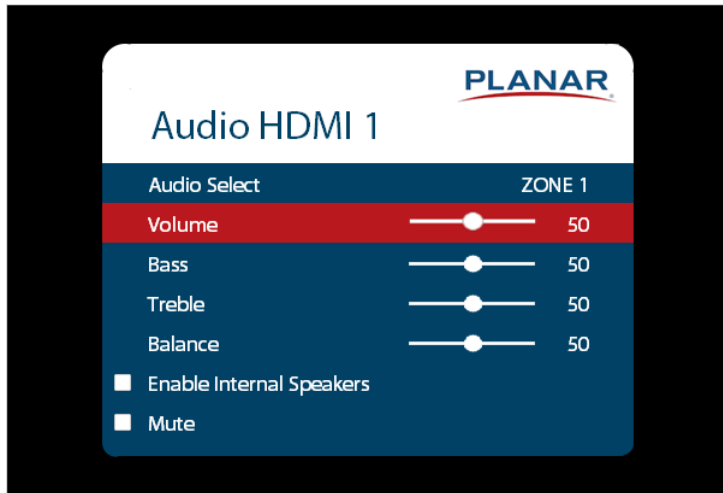

Audio Select

- The zone that is currently being adjusted and whose audio is being played. The zone's corresponding input source is shown in the title bar.
- **Options:** Zone 1, Zone 2, Zone 3, Zone 4; **Default:** Zone 1
- **Note:** Changing the Audio Select setting via the ZONE 1-4 keys on the URP 75 / URP85 / URP98 remote also changes the Current Zone setting.

Volume

- Set the volume of the audio
- **Range:** 0~100; **Default:** 50

Bass

- Set the bass level
- **Range:** 0~100; **Default:** 50
- **Note:** This setting applies only to the internal speakers, and cannot be adjusted for the Line Out connector.

Treble

- Set the treble level
- **Range:** 0~100; **Default:** 50
- **Note:** This setting applies only to the internal speakers, and cannot be adjusted for the Line Out connector.

Balance

- Set the audio balance
- **Range:** 0~100; **Default:** 50

Enable Internal Speakers

- Disable or enable the built-in speakers
- **Options:** On, Off; **Default:** On

Mute

- Mute or unmute the audio
- **Options:** On or Off; **Default:** Off

17.3 Presets Menu

This menu enables you to save Inputs and Views settings, Image Adjust settings, Audio settings, and the Backlight Intensity setting. The Local Dimming setting and Tiling settings are also available on URP75 / URP85 / URP98. You can save up to 10 presets using this menu (more can be saved via the serial command interface). If a preset is saved, it will appear as “Preset 1”, “Preset 2”, and so on. If it is not saved, it will appear as “<Empty>”.



Recall

- Apply the setup from the selected preset
- **Range:** Preset 1~Preset 10

Save

- Save the current setup for later recall
- **Range:** Preset 1~Preset 10

Delete

- Delete the selected preset
- **Range:** Preset 1~Preset 10

17.4 Advanced Settings Menu

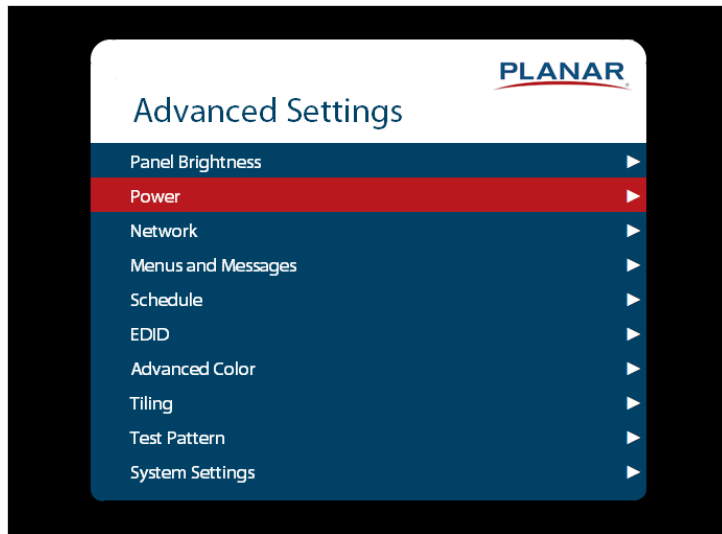

Panel Brightness Submenu



Intensity

- Set the intensity of the LCD backlight
- **Range:** 0~100; **Default:** 75

Power Submenu

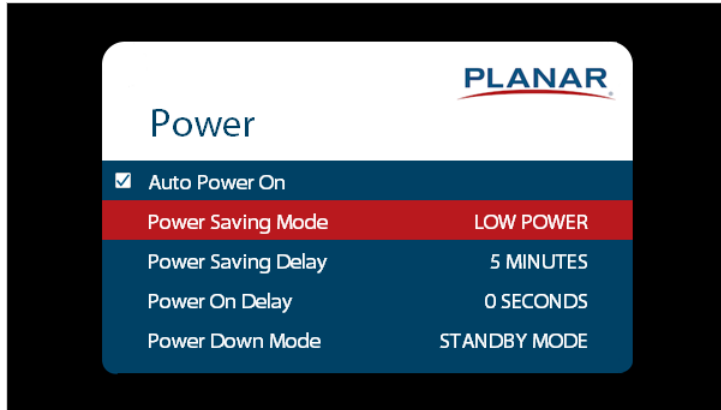

Auto Power On

- If set to On, the display will automatically leave standby after AC power is applied
- **Options:** On, Off; **Default:** Off
- **Note:** URP49 / URP55 / URP65 also includes Previous State. If selected, when the display is on and loses power, it will go to the last operational state when power is restored.

Power Saving Mode

- Set the action to take if there is no signal detected after the period of time specified by the **Power Saving Delay** setting
- **Options:** Disabled, Power Down, Wake on Signal; **Default:** Disabled
 - **Disabled:** Once powered on, the display will remain on even if no signal is present.
 - **Power Down:** The display will enter a standby state specified by the **Power Down Mode** setting.
 - **Wake On Signal:** The display will enter a standby sleep mode if no signal is detected. The display will wake when signal is restored.
 - **Note:** When signal is restored, a 10-15 second wait is typical to have an image displayed.
 - **Note:** The display must be allowed to enter sleep mode due to lack of signal for **Wake On Signal** to take effect. Sending an OFF command via Keypad, IR, CEC, RS232 or LAN will bypass **Wake On Signal** detection, and the display will enter the power state specified in the **Power Down Mode** setting.
 - **Note:** If **Auto Scan Sources** is enabled in the **Inputs and Views** menu, the display will sequentially scan all inputs before entering sleep mode. The display will leave sleep mode when a signal is detected on any input.
 - **Note:** If **Auto Scan Sources** is disabled in the **Inputs and Views** menu, the display leave sleep mode only when a signal is detected on the last selected input.
 - **Note:** When **Wake On Signal** is selected, the LAN port and **Remote Monitoring** web interface will remain accessible after the display enters sleep mode.

Power Saving Delay

- Sets the amount of time before initiating the standby state specified in **Power Saving Mode** when no signal is present
- **Options:** 1 Minute, 5 Minutes, 15 Minutes, 30 Minutes, 60 Minutes; **Default:** 5 Minutes

Power On Delay (URP75 / URP85 / URP98 only)

- Sets the amount of time to delay between an ON command being received and the display leaving standby. This can be useful when multiple displays are on the same electrical circuit, and it is beneficial to avoid all displays leaving standby simultaneously, causing a large inrush of current.
- **Options:** 0-10 seconds, in 0.1 second increments; **Default:** 0 seconds

Power Down Mode

- Set the action to take when the display enters standby
- **Options:** Standby Mode, Networked Standby Mode, Fast Startup; **Default:** Standby Mode
- **Standby Mode:** The lowest power standby setting. CEC, LAN, DB9 RS232, and USB communication are disabled. IR, Keypad connector will remain active.
 - **Note:** To remove display from standby with the IR remote or keypad, IR Remote Lock or Keypad Lock must be disabled.
 - **Note (URP75 / UPR85):** The Turn On action in the Schedule feature will not work if the **Power Down Mode** setting is set to **Standby Mode**. To allow the Turn On action to occur, set **Power Down Mode** to **Networked Standby Mode** or **Fast Startup**.
- **Networked Standby Mode:** The display will enter a low power standby state with LAN, DB9 RS232, USB and IR communications active.
- **Fast Startup:** The display will enter a standby state with partially reduced power, allowing for 3-5 second wait between an ON command being sent, and image being displayed. IR, Keypad, CEC, LAN, DB9 RS232, and USB communication will remain active.

Network Submenu

The default static IP values are:

- IP Address: 192.168.12.12
- Subnet Mask: 255.255.255.0
- Default Gateway: 192.168.12.1

The static IP settings that you program will be used if a DHCP server cannot be found.

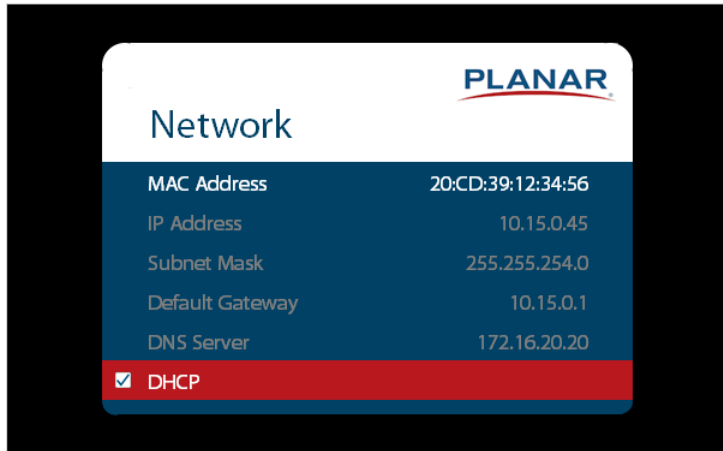

MAC Address

- The MAC address of the system

IP Address

- The current network address. You can use the number keys on the remote to enter this information.

Subnet Mask

- The current subnet mask. You can use the number keys on the remote to enter this information.

Default Gateway

- The current default gateway. You can use the number keys on the remote to enter this information.

DNS Server

- The current DNS server. You can use the number keys on the remote to enter this information.
- **Note:** The specified DNS server is used when Use Network Time is checked for the Set Date and Time setting.

DHCP

- Turn DHCP on or off
- **Options:** On, Off; **Default:** On

Menus and Messages Submenu

URP75 / URP85 / URP98

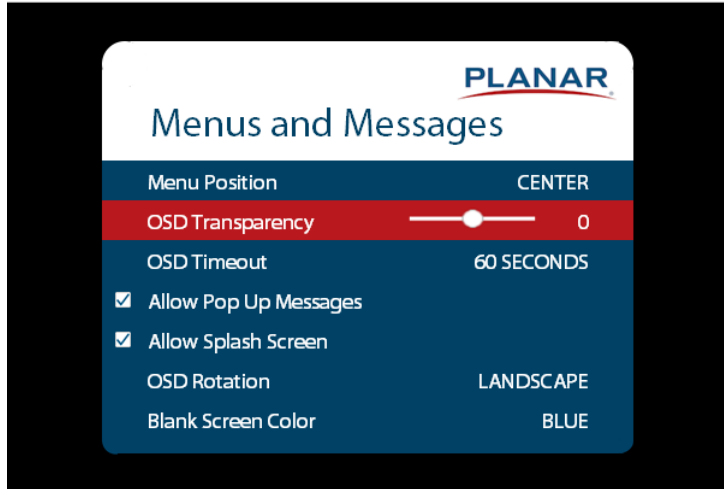

URP49 / URP55 / URP65

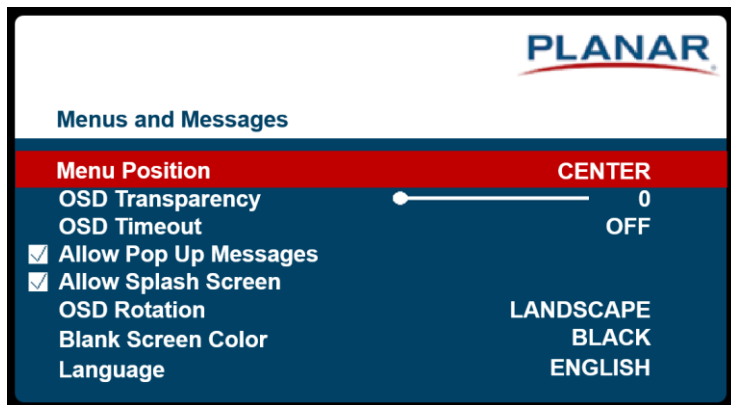

Menu Position

- Move the OSD menu to a different location on the screen
- **Options:** Center, Upper Left, Upper Right, Lower Left, Lower Right; **Default:** Center

OSD Transparency

- Set the transparency of the OSD so that the image behind it can be seen. Higher values mean greater transparency.
- **Range:** URP49 / URP55 / URP65: 0~10; URP75 / URP85 / URP98: 0~5; **Default:** 0

OSD Timeout

- Set the amount of time in seconds since the last keypress before the OSD menu automatically closes. If set to Off, the menu never automatically closes.
- **Options:** Off, 10 Seconds, 30 Seconds, 60 Seconds, 120 Seconds, 240 Seconds; **Default:** 60 Seconds

Allow Pop Up Messages

- Suppress messages that pop up automatically. When set to No, the source status message and the volume slider bar will not be displayed.
- **Options:** Yes or No; **Default:** Yes

Allow Splash Screen

- Enable or disable the splash screen during startup
- **Options:** Enable or Disable; **Default:** Enable

OSD Rotation

- Rotate the OSD menu so that it is readable if the display is mounted in portrait orientation
- **Options:** Landscape or Portrait; **Default:** Landscape

Blank Screen Color

- Select the color to display when there is no signal in a zone
- **Options:** Black, White, Gray, Red, Green, Blue, Cyan, Magenta, Yellow
- **Default:** Black

Language (URP49 / URP55 / URP65 only)

- Select the OSD language
- Options: English, French, German, Italian, Portuguese, Spanish, Chinese (Traditional), Chinese (Simplified), Japanese; **Default:** English

Schedule Submenu

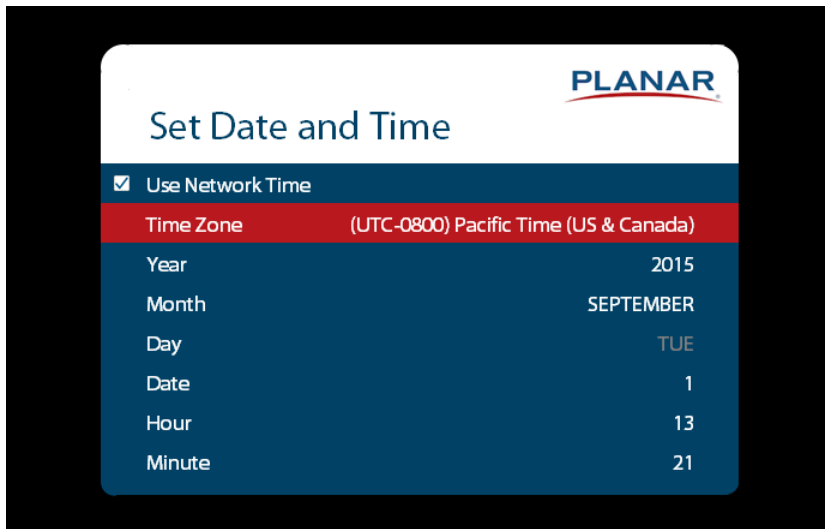
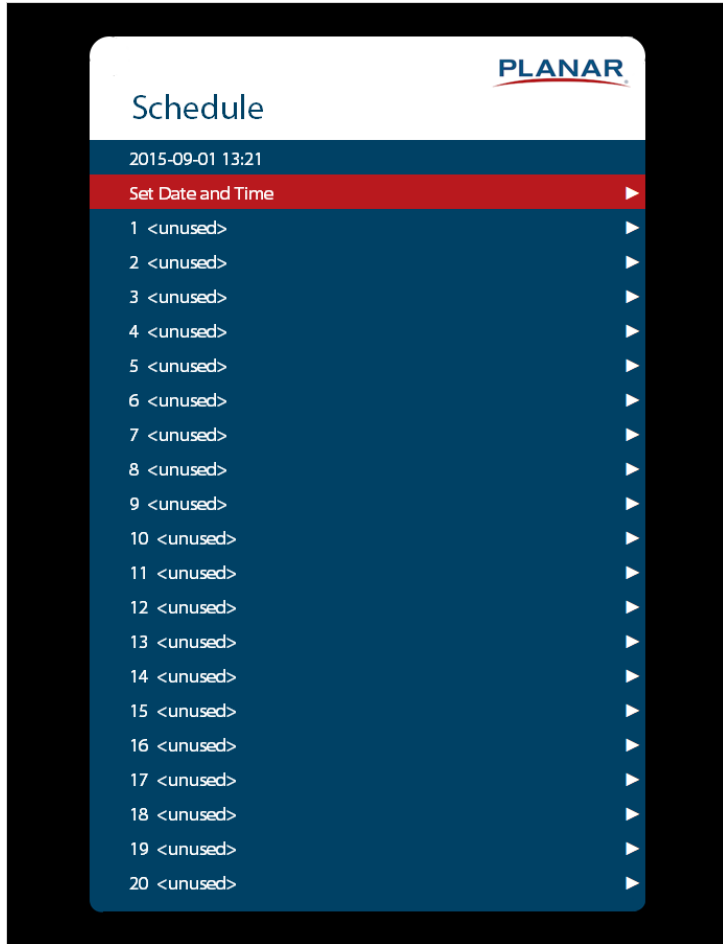

Note: URP49 / URP55 / URP65 shows only 10 events.

Set Date and Time

- Set the internal system clock. If Use Network Time is unchecked, you can set the following settings individually: Time Zone, Year, Month, Day, Date, Hour, and Minute.
- **Note:** If Use Network Time is checked and DHCP is unchecked, the display will be unable to obtain the network time unless a DNS server is programmed. This is done via the DNS Server setting in the Network menu or the serial command interface.

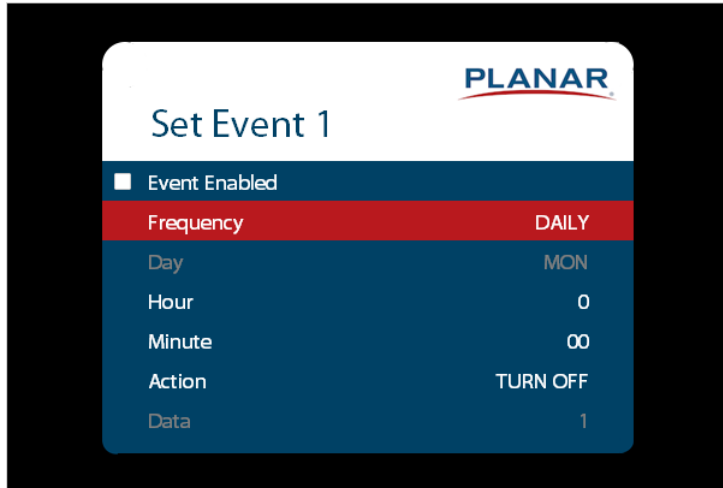

Set Event 1~Event 20

- **Event Enabled:** Turns on the event. If disabled, the settings are saved so that the event can be re-enabled.
- **Frequency:** The frequency of the event. Options are Daily, Weekly, Weekdays, Weekends.
- **Action:** The action to take for the event. Options are Turn On, Turn Off, Recall, Panel Brightness.
 - **Note (URP75 / URP85 / URP98):** The Turn On action will not work if the **Power Down Mode** setting is set to **Standby Mode**. To allow the Turn On action to occur, set **Power Down Mode** to **Networked Standby Mode** or **Fast Startup**.
- **Data:** The preset to recall when the Action is set to Recall, or the backlight setting when the Action is set to Panel Brightness.

EDID Submenu

This menu specifies the EDID format and preferred timing for the selected connector.

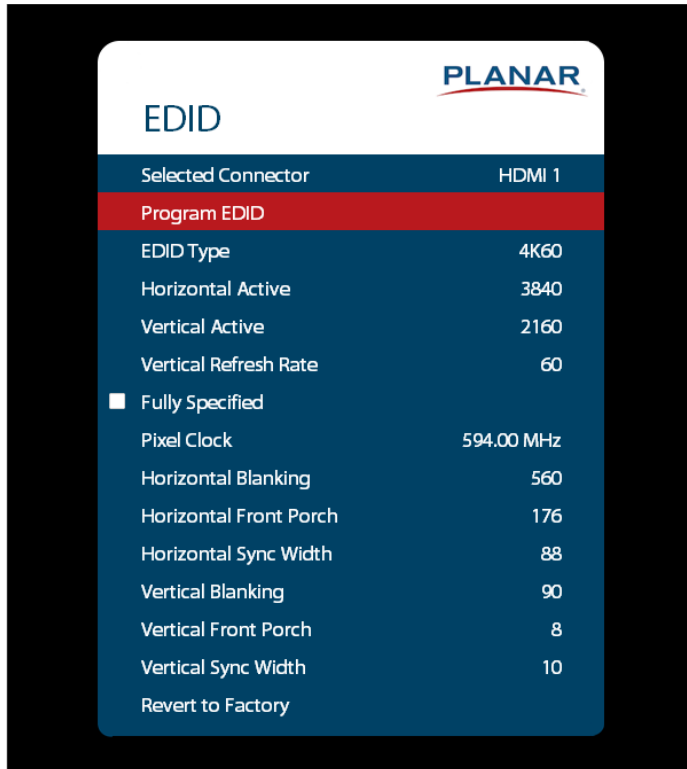

Selected Connector

- Set which connector is used
- **Options:**
 - HDMI 1, HDMI 2, HDMI 3, HDMI 4, DP, All (URP75 / URP85 / URP98)
 - HDMI 1, HDMI 2, HDMI 3, HDMI 4, DP1, DP2 (URP49 / URP55 / URP65)

Program EDID

- Program the EDID information for the selected connector based on the selections in the EDID submenu

EDID Type

- Set the EDID type to determine the base EDID used for the current connector:
- 4K60 selects an EDID format compliant with HDMI 2.0 and DP 1.2
- 4K30 selects an EDID format compliant with HDMI 1.4b and DP 1.1
- 1080P selects an EDID format compliant with HDMI 1.3 and DP 1.1
- **Options:** 4K60, 4K30, 1080P

Horizontal Active (URP75 / URP85 / URP98 only)

- The number of active pixels in a line
- **Range:** 0~4095

Vertical Active (URP75 / URP85 / URP98 only)

- The number of active lines in a field
- **Range:** 0~4095

Vertical Refresh Rate (URP75 / URP85 / URP98 only)

- The number of fields per second rounded to the nearest Hz
- **Range:** 0~120

Fully Specified (URP75 / URP85 / URP98 only)

- Determine how the final detailed timing is calculated. If disabled, it is calculated based on Horizontal Active, Vertical Active, and Vertical Refresh Rate values. If enabled, it is calculated based on all of the EDID values except for Vertical Refresh Rate.
- **Options:** Disabled, Enabled
- **Note:** This setting should only be enabled by advanced users.

Pixel Clock (URP75 / URP85 / URP98 only)

- The value of the pixel clock, in megahertz
- **Range:** 0~600.00, in 0.01 increments

Horizontal Blanking (URP75 / URP85 / URP98 only)

- The number of non-active pixel clocks in a line
- **Range:** 0~1023

Horizontal Front Porch (URP75 / URP85 / URP98 only)

- The number of pixel clocks in the horizontal front porch
- **Range:** 0~1023

Horizontal Sync Width (URP75 / URP85 / URP98 only)

- The number of pixel clocks in the horizontal sync pulse
- **Range:** 0~255

Vertical Blanking (URP75 / URP85 / URP98 only)

- The number of non-active lines in a field
- **Range:** 0~255

Vertical Front Porch (URP75 / URP85 / URP98 only)

- The number of line times in the vertical front porch
- **Range:** 0~255

Vertical Sync Width (URP75 / URP85 / URP98 only)

- The number of line times in the vertical sync
- **Range:** 0~255

Revert to Factory

- Reset the EDID type and timings to the default values for the selected connector

Advanced Color Submenu (URP75 / URP85 / URP98 only)

This menu adjusts the color coordinates of the current zone. These controls are used by advanced installers to achieve exact color point targets on the display. In some cases, the target color coordinates may not be achievable. In this case, an asterisk (*) will appear next to the color coordinate value.

Note: The white color point should be adjusted before adjusting the other color points.

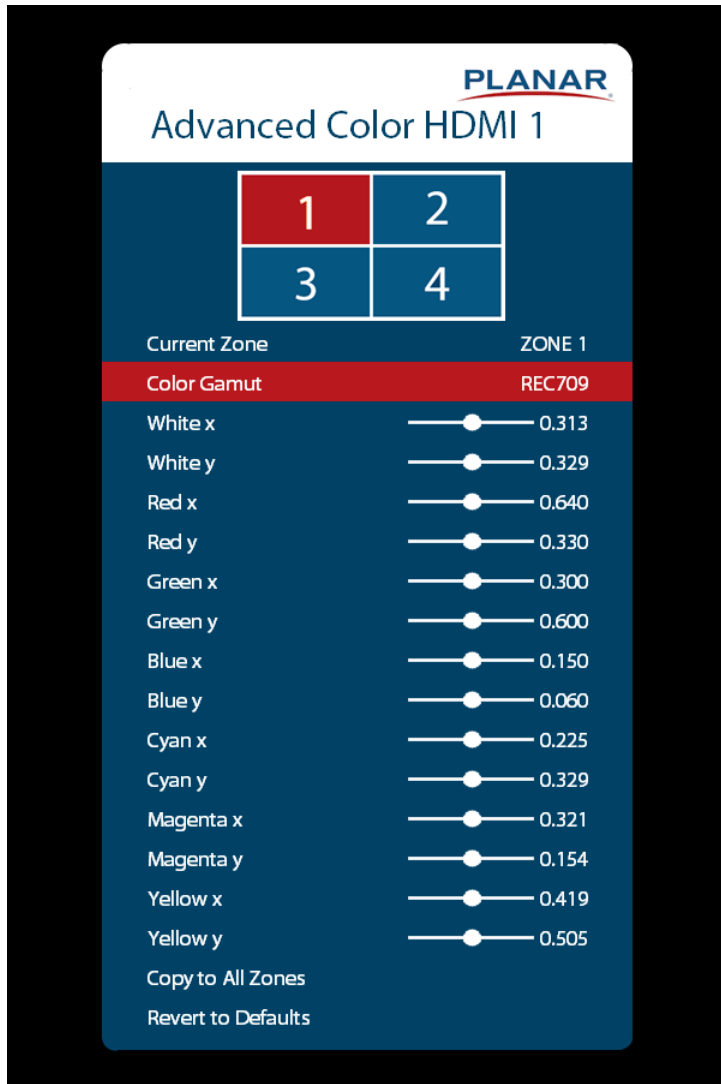

Current Zone

- The zone that is currently being adjusted. All of the settings in this menu are saved per zone, and all color coordinate values are also saved per Color Gamut setting. The zone's corresponding input source is shown in the title bar, and the graphic beneath that shows which zone is being adjusted in the current Multi-Source View mode and Advanced Layout setting (if applicable).

- The current zone can be changed via the menu or by using the ZONE 1-4 keys on the remote control.
- **Note:** Changing the Current Zone setting via the ZONE 1-4 keys also changes the Audio Select setting.

Color Gamut

- Select a preset Color Gamut of the image
- **Options:** REC709, SMPTE C, EBU, DCI, User, Auto, Disable. **Default:** Disable

White x

- Adjust the x coordinate of the white color point
- **Range:** 0.000-0.800

White y

- Adjust the y coordinate of the white color point
- **Range:** 0.000-0.800

Red x

- Adjust the x coordinate of the red color point
- **Range:** 0.000-0.800

Red y

- Adjust the y coordinate of the red color point
- **Range:** 0.000-0.800

Green x

- Adjust the x coordinate of the green color point
- **Range:** 0.000-0.800

Green y

- Adjust the y coordinate of the green color point
- **Range:** 0.000-0.800

Blue x

- Adjust the x coordinate of the blue color point
- **Range:** 0.000-0.800

Blue y

- Adjust the y coordinate of the blue color point
- **Range:** 0.000-0.800

Cyan x

- Adjust the x coordinate of the cyan color point
- **Range:** 0.000-0.800

Cyan y

- Adjust the y coordinate of the cyan color point
- **Range:** 0.000-0.800

Magenta x

- Adjust the x coordinate of the magenta color point
- **Range:** 0.000-0.800

Magenta y

- Adjust the y coordinate of the magenta color point
- **Range:** 0.000-0.800

Yellow x

- Adjust the x coordinate of the yellow color point
- **Range:** 0.000-0.800

Yellow y

- Adjust the y coordinate of the yellow color point
- **Range:** 0.000-0.800
- Copy to All Zones
- Copy the color coordinate settings for the current zone and the current Color Gamut setting to all other zones

Revert to Defaults

- Reset the color coordinate settings for the current zone and the current Color Gamut setting to their default values

Tiling Submenu (URP75 / URP85 / URP98 only)

This menu contains controls for using multiple Planar UltraRes P Series displays in a tiled configuration. This is useful when trying to display one image across multiple displays. In addition to setting up the width and height of the tiled wall, each display must have its position within the tiled wall properly selected. Refer to the diagrams below for example setting values in a 3 x 4 tiled wall.

Note: When using the Content Rotation feature, the Tiling settings must be adjusted differently in order to display the image properly. Refer to the examples below.

Example 1: 0 Degree Rotation, Wall Width = 3, Wall Height = 4

Unit Row 1 Unit Column 1	Unit Row 1 Unit Column 2	Unit Row 1 Unit Column 3
Unit Row 2 Unit Column 1	Unit Row 2 Unit Column 2	Unit Row 2 Unit Column 3
Unit Row 3 Unit Column 1	Unit Row 3 Unit Column 2	Unit Row 3 Unit Column 3
Unit Row 4 Unit Column 1	Unit Row 4 Unit Column 2	Unit Row 4 Unit Column 3



Example 2: 180 Degree Rotation, Wall Width = 3, Wall Height = 4

Unit Row 4 Unit Column 3	Unit Row 4 Unit Column 2	Unit Row 4 Unit Column 1
Unit Row 3 Unit Column 3	Unit Row 3 Unit Column 2	Unit Row 3 Unit Column 1
Unit Row 2 Unit Column 3	Unit Row 2 Unit Column 2	Unit Row 2 Unit Column 1
Unit Row 1 Unit Column 3	Unit Row 1 Unit Column 2	Unit Row 1 Unit Column 1



Example 3: 90 Degree Rotation, Wall Width = 4, Wall Height = 3

Unit Row 3 Unit Column 1	Unit Row 2 Unit Column 1	Unit Row 1 Unit Column 1
Unit Row 3 Unit Column 2	Unit Row 2 Unit Column 2	Unit Row 1 Unit Column 2
Unit Row 3 Unit Column 3	Unit Row 2 Unit Column 3	Unit Row 1 Unit Column 3
Unit Row 3 Unit Column 4	Unit Row 2 Unit Column 4	Unit Row 1 Unit Column 4



Example 4: 270 Degree Rotation, Wall Width = 4, Wall Height = 3

Unit Row 1 Unit Column 4	Unit Row 2 Unit Column 4	Unit Row 3 Unit Column 4
Unit Row 1 Unit Column 3	Unit Row 2 Unit Column 3	Unit Row 3 Unit Column 3
Unit Row 1 Unit Column 2	Unit Row 2 Unit Column 2	Unit Row 3 Unit Column 2
Unit Row 1 Unit Column 1	Unit Row 2 Unit Column 1	Unit Row 3 Unit Column 1



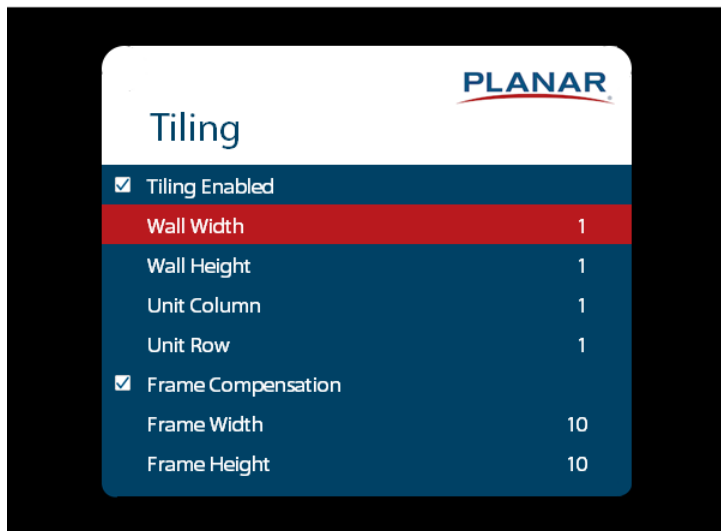

Tiling Enabled

- When enabled, the tiling parameters in the menu are used
- **Options:** Disable, Enable; **Default:** Disable

Wall Width, Wall Height

- Select the width and height of the tiled wall
- **Default:** Width=1, Height=1

Unit Column, Unit Row

- Selects the location of the current display within the tiled wall
- **Default:** Column=1, Row=1

Frame Compensation

- When enabled, the image is scaled to compensate for the width of the display's bezel, using the Frame Width and Frame Height parameters. See "Frame Compensation Examples" on page 69.
- **Options:** Disable, Enable; **Default:** Disable

Frame Width, Frame Height

- Selects how many lines/pixels are removed from the image to compensate for the display's bezel

Frame Compensation Examples

Below are examples with the Frame Compensation feature enabled (left) and disabled (right). Note that the eagle's eye is noticeably different when Frame Compensation is disabled.

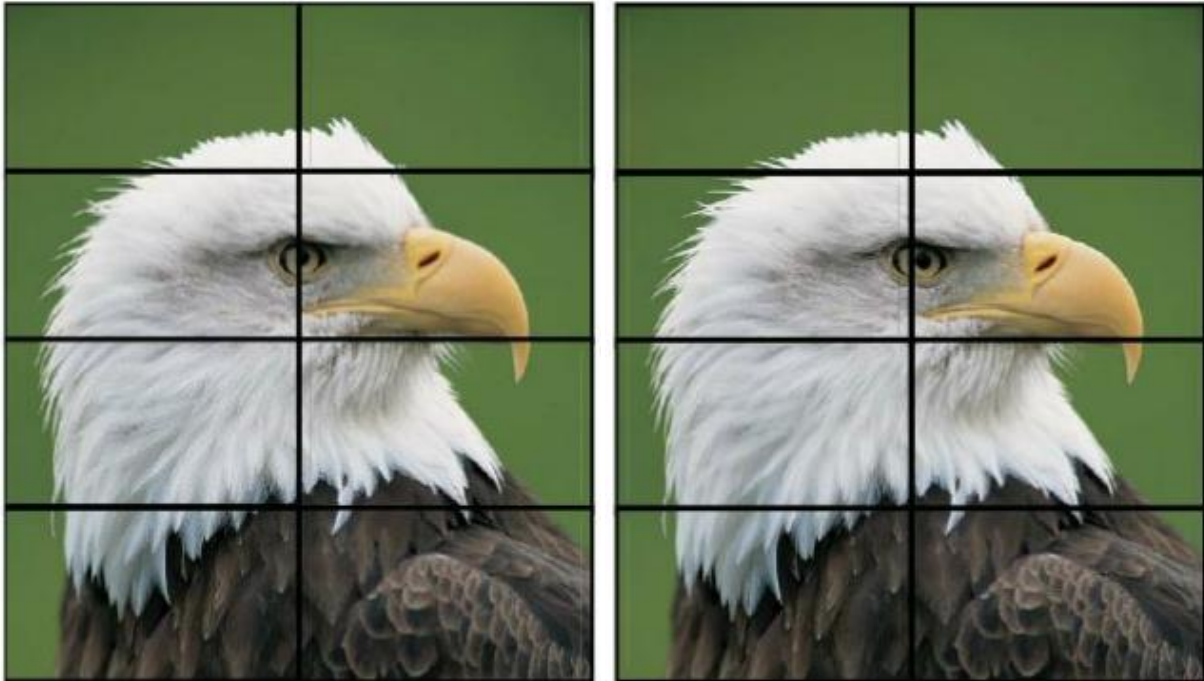

Test Patterns Submenu

This menu selects a test pattern to show on the display for diagnostic purposes.

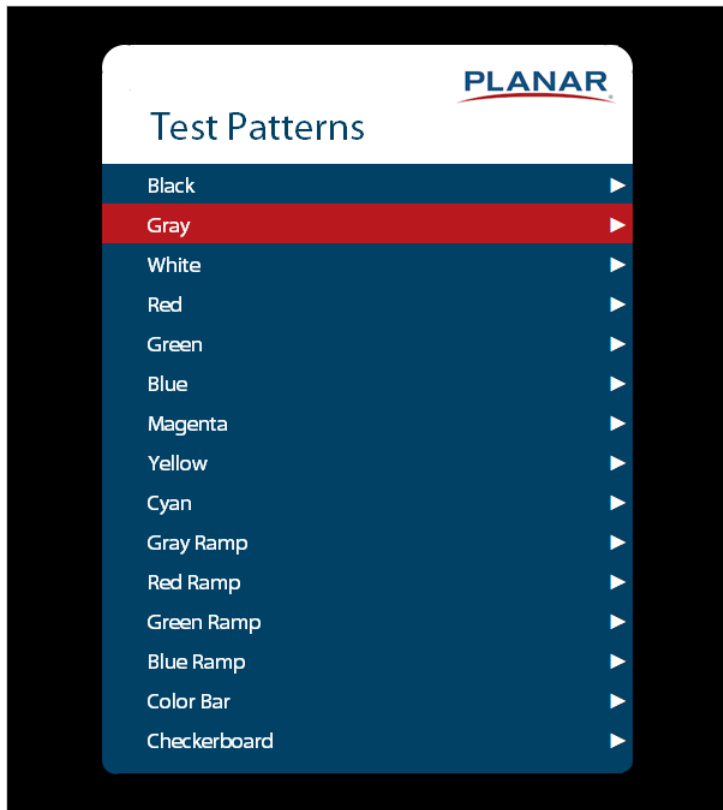

Test Patterns

- **Options:** Black, Gray, White, Red, Green, Blue, Magenta, Yellow, Cyan, Gray Ramp, Red Ramp, Blue Ramp, Color Bar (URP75 / URP85 / URP98 only), Checkerboard (URP75 / URP85 / URP98 only)

System Settings Submenu

URP49 / URP55 / URP65

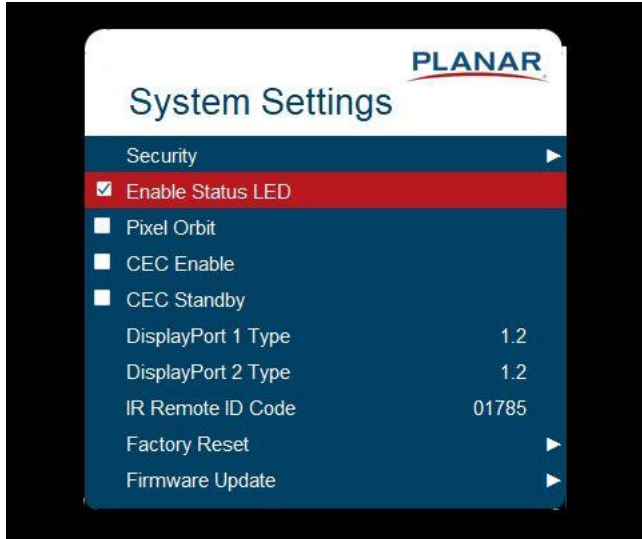

URP75 / URP85 / URP98

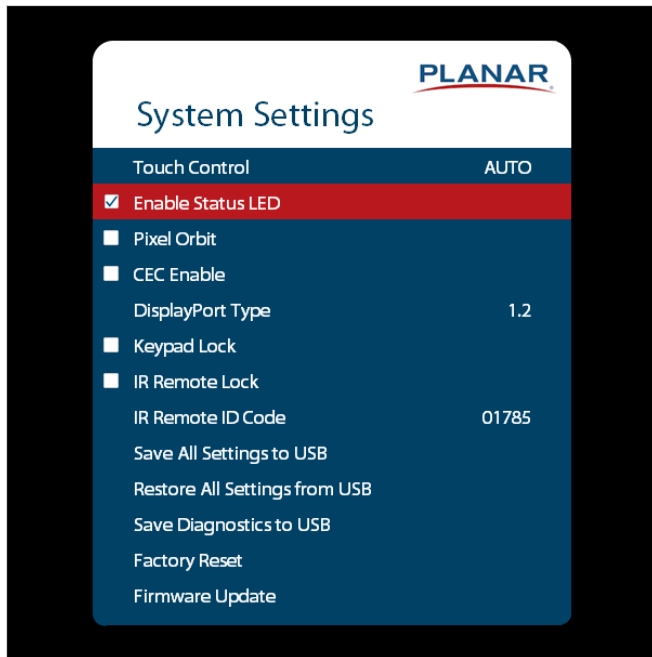

Security (URP49 / URP55 / URP65 only)



- Keypad Lock: When enabled, locks keypad
- IR Remote Lock: When enabled, locks IR Remote
- RS232 Lock: When enabled, RS232 communication is disabled
- LAN Lock: When enabled, LAN communication is disabled
- USB-A Lock: When enabled, USB-A port is disabled
- **Note:** To unlock the IR Remote press the following keys on the remote: ENTER, ENTER, EXIT, EXIT, ENTER and EXIT
- **Note:** Locking the keypad and/or IR Remote does not disable the power on command button on the IR Remote

Enable Status LED

- When enabled, the status LEDs on the back of the display behave as indicated on page 30. When disabled, the status LEDs are always turned off.
- **Options:** Disable, Enable; **Default:** Enable

Pixel Orbit

- Create slight frame motion to help avoid image retention
- **Options:** Enable, Disable; **Default:** Disable

CEC Enable

- Enables HDMI-CEC (Consumer Electronics Control) with compatible external devices
- **Options:** On, Off: **Default:** Off

The CEC commands listed in the tables below are implemented:

Command	Value
Image View On	0x04
Text View On	0x0D
Standby	0x36
User Control Pressed	0x44
Routing Change	0x80
Active Source	0x82
Give Physical Address	0x83
Report Physical Address	0x84
Request Active Source	0x85
Give Device Power Status	0x8F
Report Power Status	0x90
Inactive Source	0x9D
CEC Version	0x9E
Get CEC Version	0x9F
Give Features	0xA5
Report Features	0xA6

DisplayPort Type

- Set the version of DisplayPort that is used by the system
- **Options:** 1.1, 1.2; **Default:** 1.2

Keypad Lock

- Lock or unlock the keypad. When it is enabled, all keypad presses will be ignored.
- **Options:** Enable, Disable; **Default:** Disable

IR Remote Lock

- Lock or unlock the remote control. When it is enabled, all remote control presses will be ignored.
- **Options:** Enable, Disable; **Default:** Disable

IR Remote ID Code (URP75 / URP85 / URP98 only)

- Selects the IR remote code set accepted by the display.
- **Note:** The remote that ships with the URP49 / URP55 / URP65 (952-0088-00) only supports the default IR code of 01785. Changing the default IR code requires the use of the 952-0086-00 Planar remote. See “Using the Remote Control” on page 32.
- **Options:** 00000-65535; **Default:** 01785

Save All Settings to USB (URP75 / URP85 / URP98 only)

- Save all settings in the display to a USB flash drive. The saved file will be named Planar-settings.bin and will be saved in the root folder of the USB flash drive.
- **Note:** A USB flash drive must be inserted into the USB-A connector prior to using this feature. The USB flash drive must be formatted as FAT32. This feature will not work with the NTFS file system.

Restore All Settings from USB (URP75 / URP85 / URP98 only)

- Restores all settings in the display from a USB flash drive. The settings file must be named Planar-settings.bin and must be located in the root folder of the USB flash drive.
- **Note:** A USB flash drive must be inserted into the USB-A connector prior to using this feature. The USB flash drive must be formatted as FAT32. This feature will not work with the NTFS file system.

Save Diagnostics to USB (URP75 / URP85 / URP98 only)

- Save a diagnostic report to a USB flash drive to help Planar Technical Support troubleshoot any issues. The saved file will be named Planar-diagnostics.bin and will be saved in the root folder of the USB flash drive.
- **Note:** A USB flash drive must be inserted into the USB-A connector prior to using this feature. The USB flash drive must be formatted as FAT32. This feature will not work with the NTFS file system.

Factory Reset

- Return the saved settings in a system to their factory defaults.

Firmware Update

- Update the firmware for the display. Refer to the instructions on the firmware release package for more information.

17.5 Information Menu



System Information Submenu

This menu displays version information for all programmable parts in the system. It also contains the model and serial number.

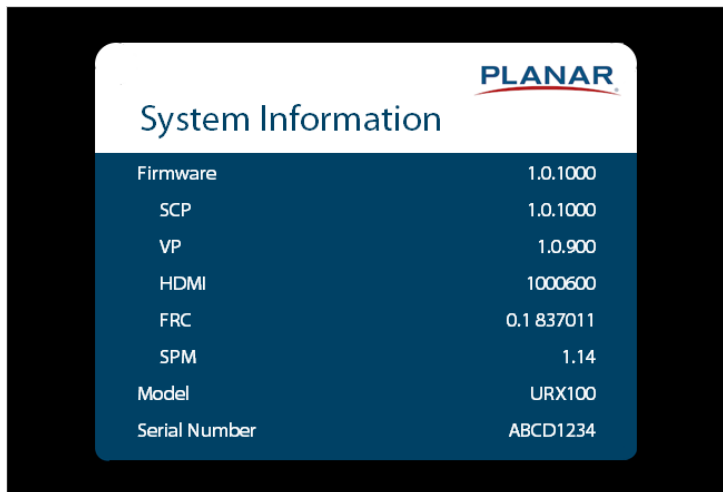
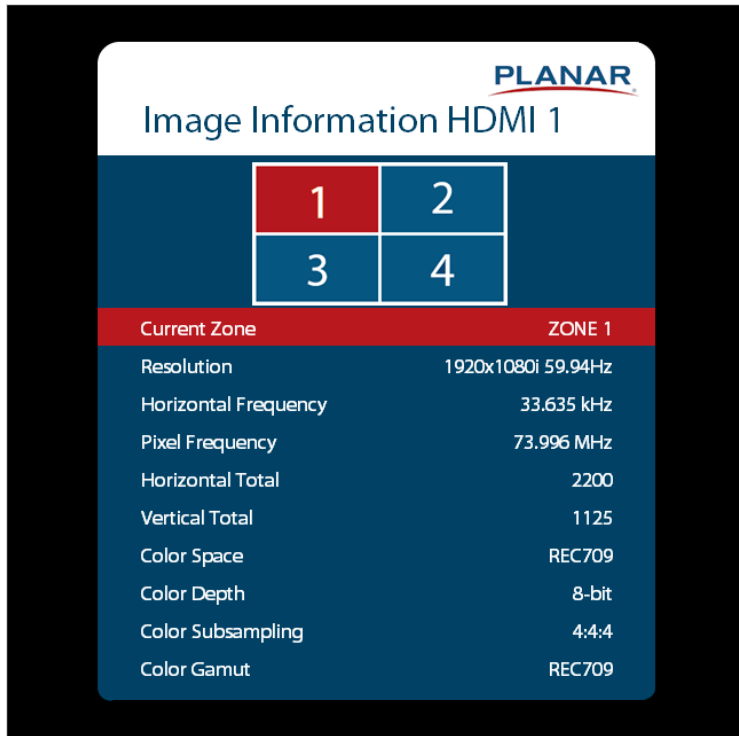

Image Information Submenu

This menu displays image details for the current zone. If more than one zone is available, you can change zones by setting the **Current Zone** option.



Error Log Submenu (URP75 / URP85 / URP98 only)

This menu displays a chronological list of system errors that have occurred. For a list of possible errors, see "Error Codes" on page 129.

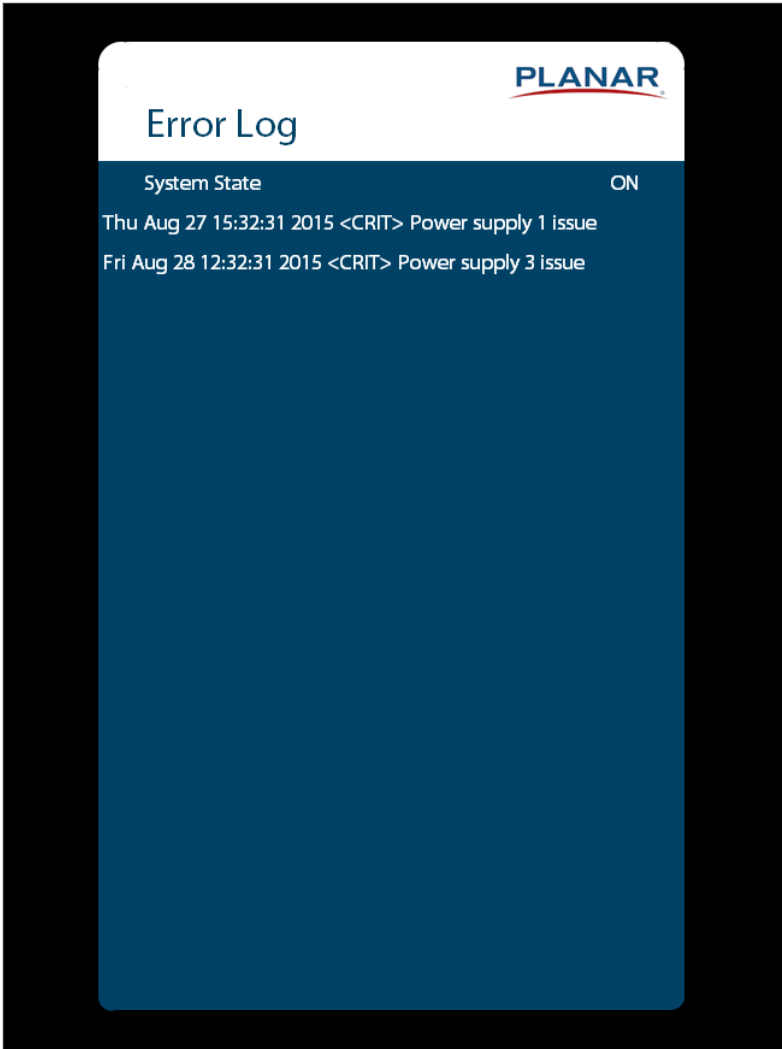

18. Using the Touch Screen

You can use the touch screen to control your Windows, Mac or Linux operating system. The Planar UltraRes P Series is HID compliant, delivering up to 50 points of touch on URP49 / URP55 / URP65 touch models and up to 20 points of touch on URP75 / URP85 / URP98 touch models on both Windows and Linux without a driver. Single touch only is supported for Mac operating systems. To achieve more than single touch Mac support, drivers will need to be installed, which can be found on <http://www.planar.com/support>.

Note: Ensure that you have installed the USB cable on the display to a computer.

Planar UltraRes P Series URP75 / URP85 / URP98: Planar UltraRes Web UI

Connect the display to the Local Area Network. Launch a web browser on your computer or mobile device that has access to the same LAN.

Enter the IP address shown in the “Network submenu” on page 54.

Because the UI is generated within the display, and not an external website, it does not carry the typical https certificate. Depending on your browser’s security settings, you may be asked to authorize the display’s web interface.

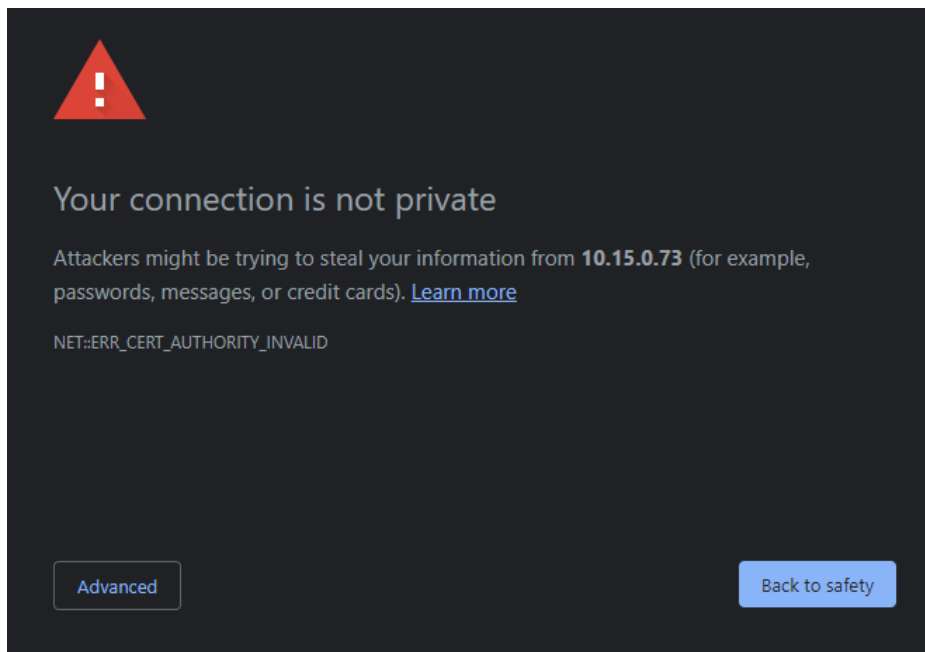

Example of a browser’s authorization screen. The authorization is found by pressing the **Advanced** button.

When a new session is started by opening a web browser window and directing it to the appropriate IP address, compatible Planar UltraRes products will display the login page to access the features within the software.

The default username is Admin. The default password is the display’s serial number.

This password may be changed after login to a more convenient password.

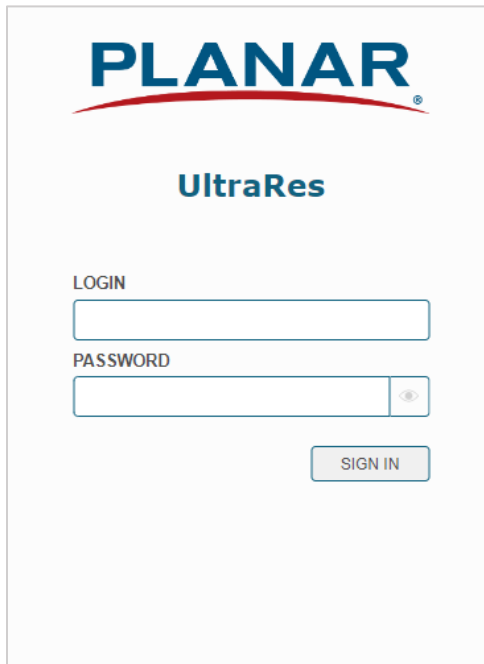

The image shows the login page for the Planar UltraRes interface. At the top is the Planar logo in blue with a red swoosh underneath. Below the logo is the text "UltraRes" in a bold, blue font. Underneath that, the word "LOGIN" is displayed. There are two input fields: the first is for the username, and the second is for the password, which includes a small eye icon to toggle visibility. A "SIGN IN" button is located below the password field.

If successful, you should see the Remote Monitoring Interface.

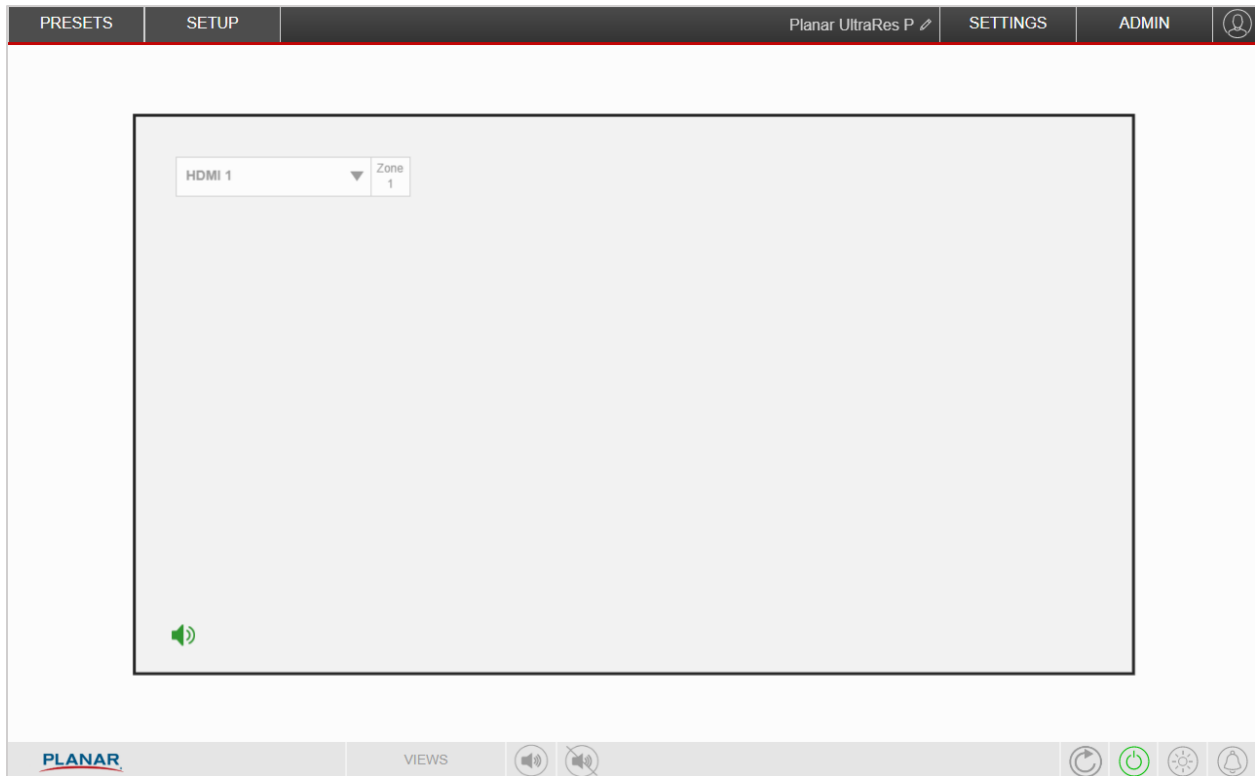

Note: If the password needs to be reset, the recovery method is connected by serial and send a `PASSWORD.SET="newpassword"` command, with the new password enclosed in double-quotes. `PASSWORD.SET` commands are not accepted over network, only direct serial connection. Alternatively, a factory reset will restore the password to the serial number.

19. UltraRes Web UI Home Screen

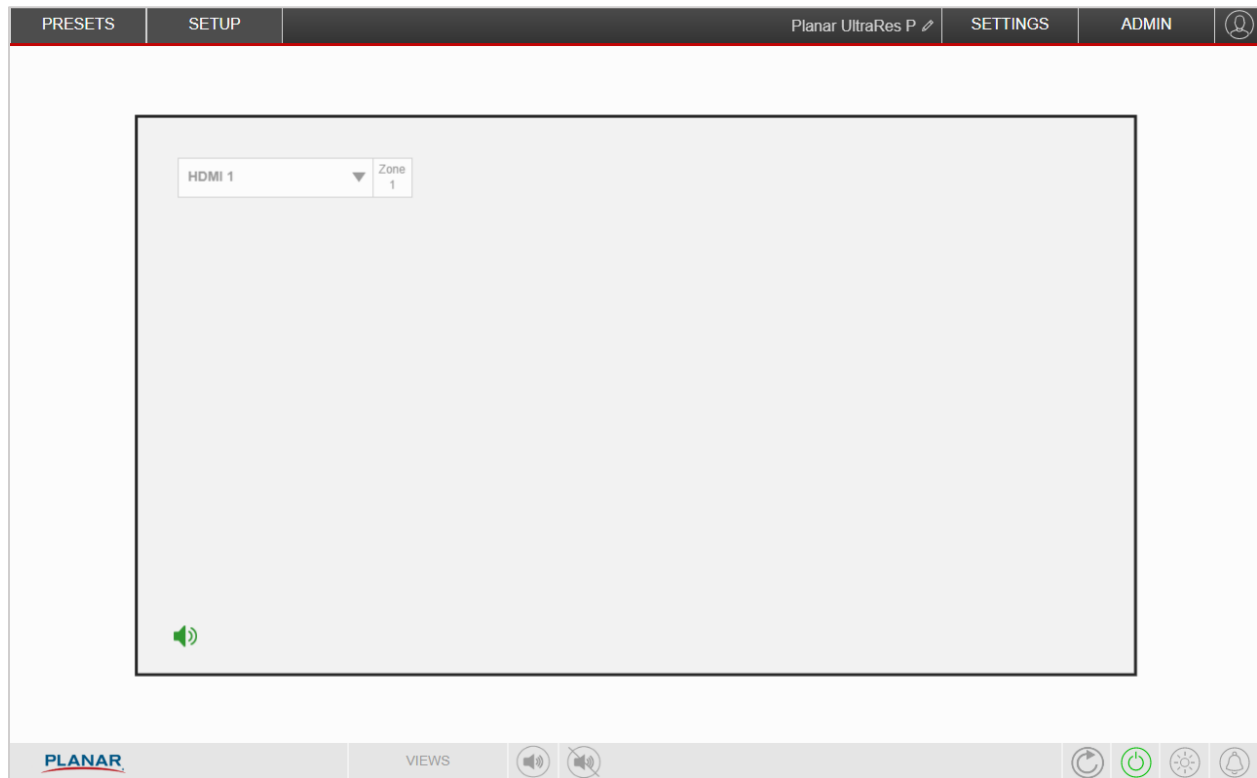

The Planar UltraRes Web UI consists of a top bar with drop-down menus, a canvas representing the display's current layout, and a bottom bar with pop-up menus.

Note: Depending on your device or browser settings, the proportions of the UI will vary. If the Planar UltraRes Web UI detects a mobile device, the layout will change to the proportionate interface, and menu items may be relocated.

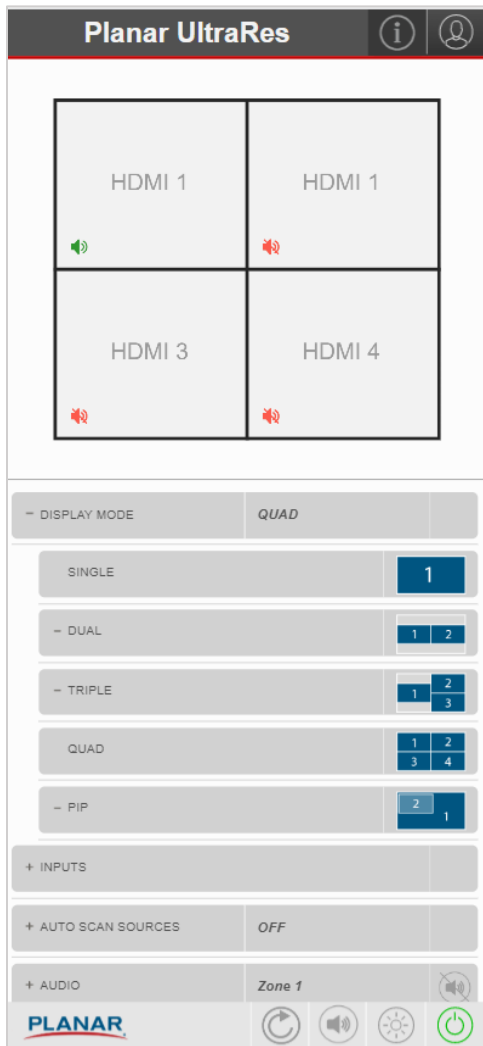

Example of a mobile interface

The top bar of the user interface contains the drop-down menus for Presets, Setup, Settings and Admin.



The avatar icon contains a drop-down menu to show who is currently logged in. The display name is shown to the left of the Settings drop-down menu, and allows the display to be renamed. This name is shown only in the web UI and browser and does not change any information shown in the UltraRes on-screen display. This can be useful to differentiate multiple Planar displays connected to the same LAN.

The bottom bar of the user interface contains pop-up menus for Views, Volume, Mute, Refresh, Power, Brightness, and Alerts.



Note: When a menu item is selected, the pop-up menu will remain visible until it is closed again. A red line above selected item indicates the pop-up menu is active.

- Views

- The Views button provides a pop-up menu that displays all the available multi-source layouts. Select a layout and drag it to the display canvas.

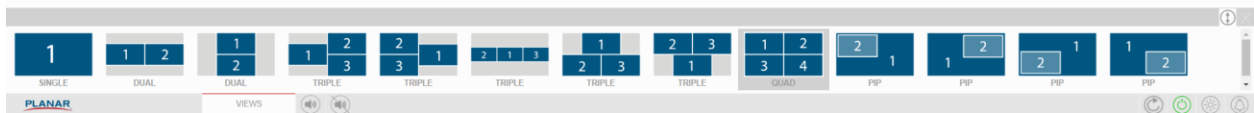

- Once a layout is placed in the canvas, each zone will contain a drop-down menu of available sources. Each zone will have an audio icon in the lower right representing which zone is currently playing audio. Refer to the “Inputs and Views Menu” on page 43 for more information.
- Audio
 - The audio icons provide volume adjustment, and system mute.

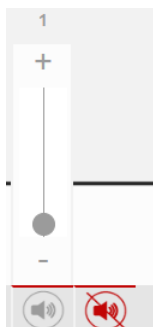

- The Refresh button forces the web interface to sync with the status of the display. This can be useful if changes have been made from an alternate control method.
- The Power button provides a pop-up menu with On and Off command. Refer to the “Power Submenu” on page 52 for more information.

- The Brightness button provides a pop-up menu with adjustment of the backlight.

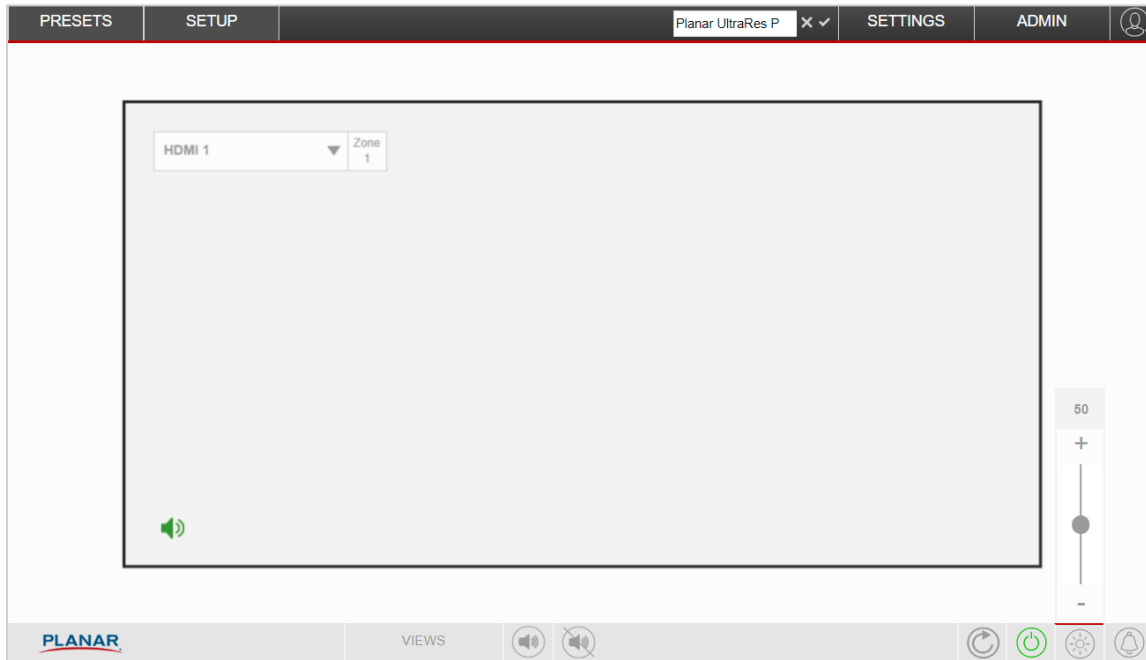

- The Alerts button provides a pop-up menu that displays information on any system alerts.

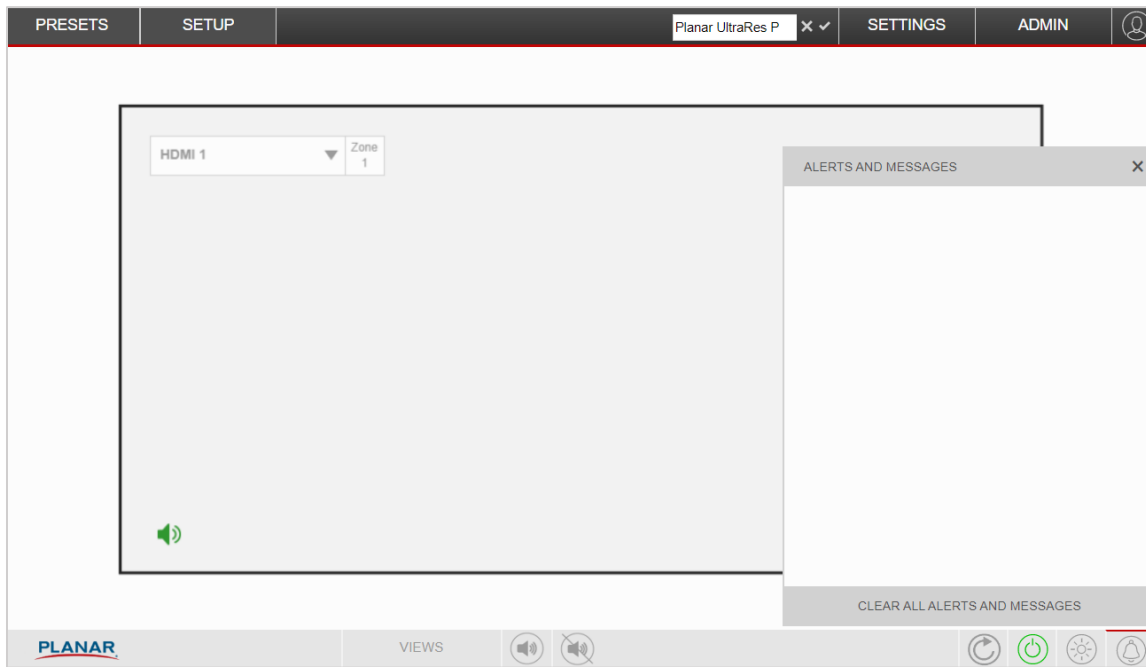

20. Admin

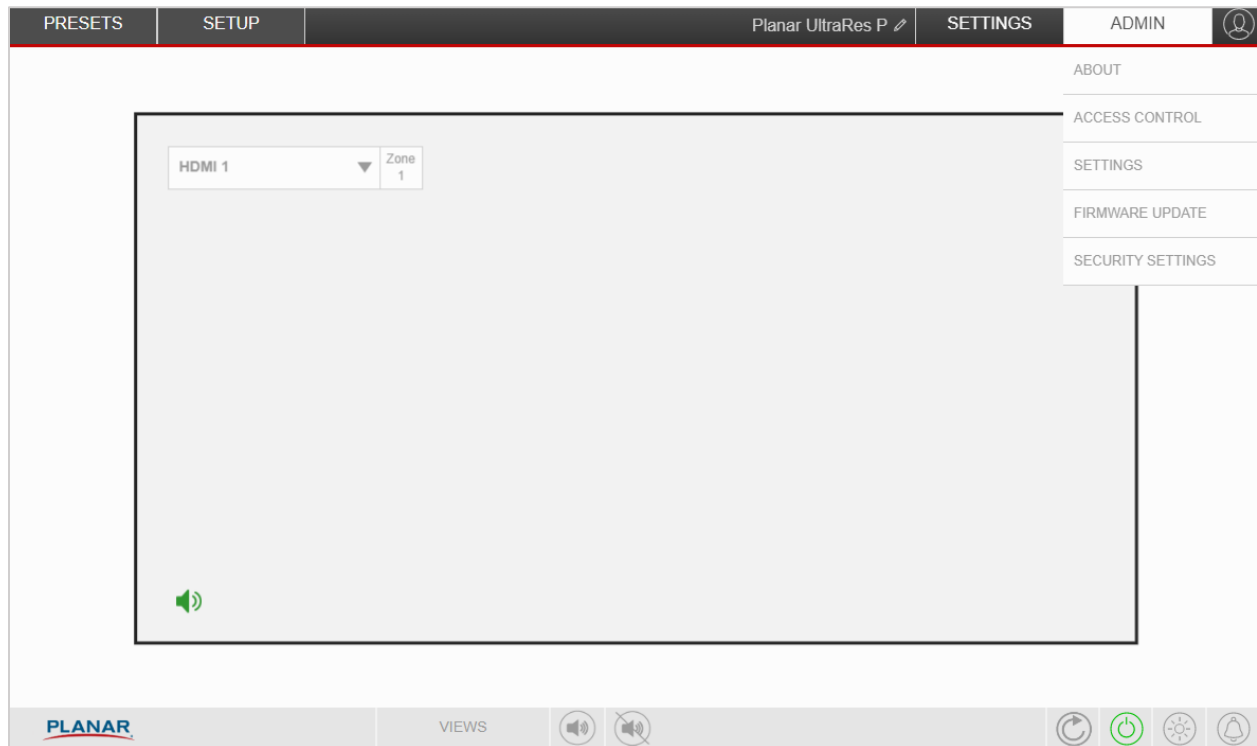

The Admin dropdown menu contains the following submenus:

- **About:** Provides the version number and licensing info for the UltraRes web interface

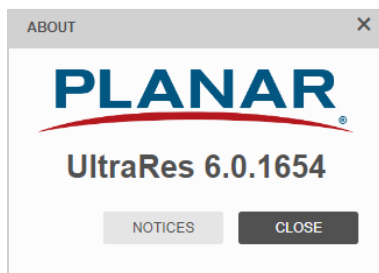

- **Access Control:** Manage Admin and User passwords

ACCESS CONTROL

Manage Passwords

Admin

Password

Confirm Password

Set Admin Password

User

Password

Confirm Password

Set User Password

Remove Passwords

Remove Passwords

CLOSE

- **Settings:** Generate or restore a settings package. This package will store all user settings. Refer to the “Save All Settings to USB” on page 74.

SETTINGS

Generate Settings Package

Download Settings Package

Save All Settings to USB

Restore Settings

Restore All Settings from USB

Click on "Generate Settings Package" to start collecting system settings

CLOSE

- **Firmware Update:** Update the Firmware from a Firmware file located on your computer. Refer to “Firmware Update” on page 74.

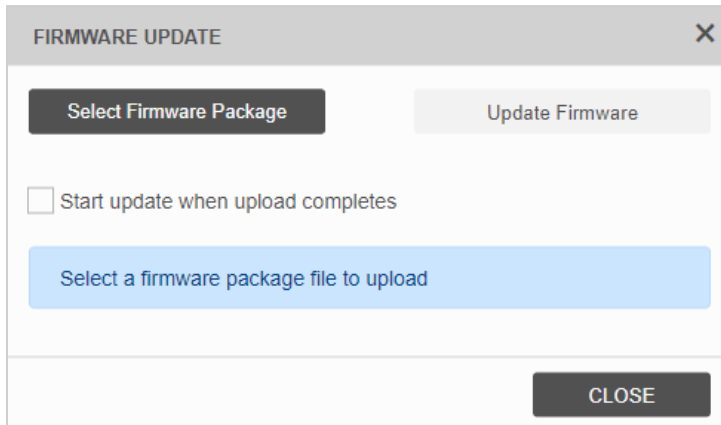

The screenshot shows a dialog box titled "FIRMWARE UPDATE" with a close button (X) in the top right corner. Inside the dialog, there are two buttons: "Select Firmware Package" and "Update Firmware". Below these buttons is a checkbox labeled "Start update when upload completes". Underneath the checkbox is a blue button that says "Select a firmware package file to upload". At the bottom right of the dialog is a "CLOSE" button.

- **Security Settings:** Configure the network security, keypad lock, IR Remote lock, and IR code. Refer to the “System Settings Submenu” on page 71.

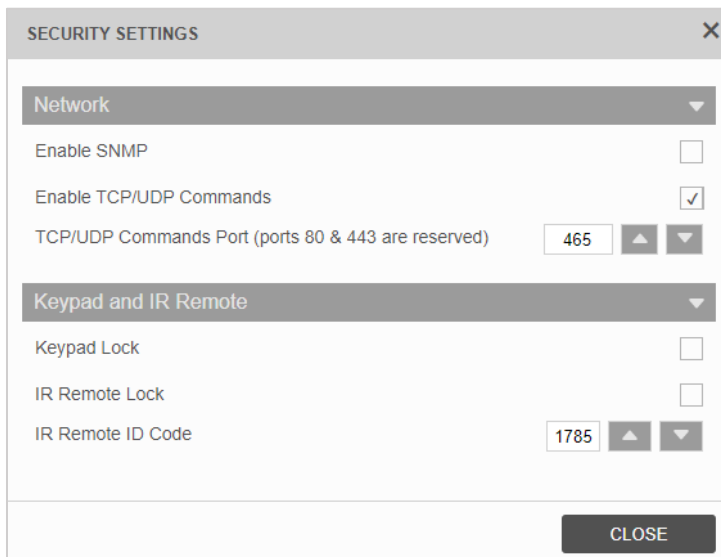

The screenshot shows a dialog box titled "SECURITY SETTINGS" with a close button (X) in the top right corner. The dialog is divided into two sections. The first section is "Network" and contains three settings: "Enable SNMP" with an unchecked checkbox, "Enable TCP/UDP Commands" with a checked checkbox, and "TCP/UDP Commands Port (ports 80 & 443 are reserved)" with a text input field containing "465" and up/down arrow buttons. The second section is "Keypad and IR Remote" and contains three settings: "Keypad Lock" with an unchecked checkbox, "IR Remote Lock" with an unchecked checkbox, and "IR Remote ID Code" with a text input field containing "1785" and up/down arrow buttons. At the bottom right of the dialog is a "CLOSE" button.

21. Settings

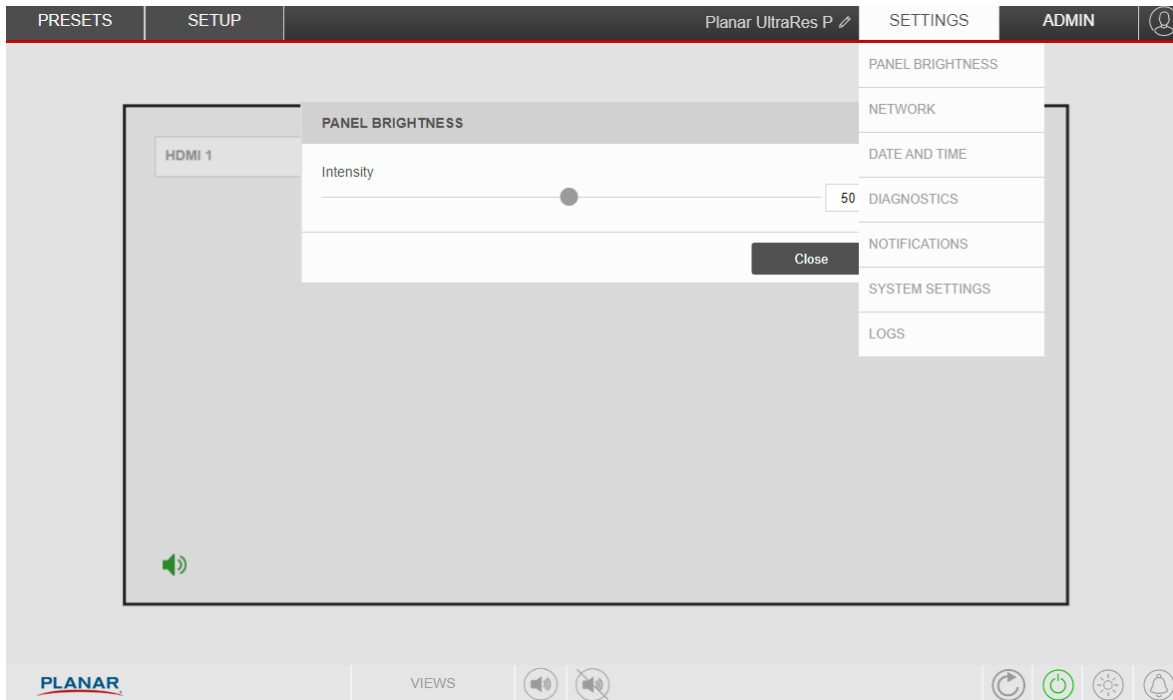

- **Panel Brightness:** Adjust the backlight of the display. Refer to the “Panel Brightness Submenu” on page 51.



- **Network:** Provides the network configuration. Refer to the “Network Submenu” on page 54.

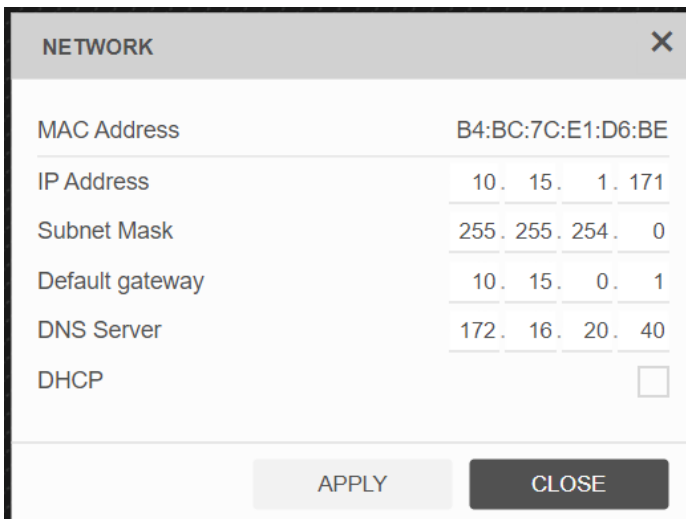

- **Date and Time:** Configure the date and time, and scheduled events. Refer to the “Schedule Submenu” on page 57.

DATE AND TIME
✕

Date and Time

Use Network Time

Time Zone (UTC-08:00) Pacific Time (US & Canada) ▾

Date Apr 16, 2023

Time 18:43 ✕

Scheduled Events

	Frequency	Day	Time	Action	Data	Enabled
1	Daily ▾	Monday ▾	00:00 ✕	Turn Off ▾	▾	<input type="checkbox"/>
2	Daily ▾	Monday ▾	00:00 ✕	Turn Off ▾	▾	<input type="checkbox"/>
3	Daily ▾	Monday ▾	00:00 ✕	Turn Off ▾	▾	<input type="checkbox"/>
4	Daily ▾	Monday ▾	00:00 ✕	Turn Off ▾	▾	<input type="checkbox"/>
5	Daily ▾	Monday ▾	00:00 ✕	Turn Off ▾	▾	<input type="checkbox"/>
6	Daily ▾	Monday ▾	00:00 ✕	Turn Off ▾	▾	<input type="checkbox"/>
7	Daily ▾	Monday ▾	00:00 ✕	Turn Off ▾	▾	<input type="checkbox"/>
8	Daily ▾	Monday ▾	00:00 ✕	Turn Off ▾	▾	<input type="checkbox"/>
9	Daily ▾	Monday ▾	00:00 ✕	Turn Off ▾	▾	<input type="checkbox"/>
10	Daily ▾	Monday ▾	00:00 ✕	Turn Off ▾	▾	<input type="checkbox"/>
11	Daily ▾	Monday ▾	00:00 ✕	Turn Off ▾	▾	<input type="checkbox"/>
12	Daily ▾	Monday ▾	00:00 ✕	Turn Off ▾	▾	<input type="checkbox"/>
13	Daily ▾	Monday ▾	00:00 ✕	Turn Off ▾	▾	<input type="checkbox"/>
14	Daily ▾	Monday ▾	00:00 ✕	Turn Off ▾	▾	<input type="checkbox"/>
15	Daily ▾	Monday ▾	00:00 ✕	Turn Off ▾	▾	<input type="checkbox"/>
16	Daily ▾	Monday ▾	00:00 ✕	Turn Off ▾	▾	<input type="checkbox"/>
17	Daily ▾	Monday ▾	00:00 ✕	Turn Off ▾	▾	<input type="checkbox"/>
18	Daily ▾	Monday ▾	00:00 ✕	Turn Off ▾	▾	<input type="checkbox"/>
19	Daily ▾	Monday ▾	00:00 ✕	Turn Off ▾	▾	<input type="checkbox"/>
20	Daily ▾	Monday ▾	00:00 ✕	Turn Off ▾	▾	<input type="checkbox"/>

CLOSE

- **Diagnostics:** Generate a diagnostics package. Refer to “Save Diagnostics to USB” on page 74.

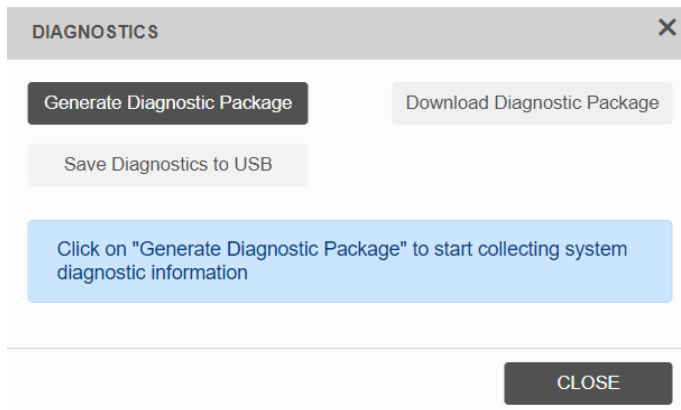

- Notifications
 - Email Account Settings
 - **SMTP Server:** The name of the outgoing SMTP server. Obtain this information from your ISP.
 - **Connection Encryption:** Selects the appropriate encryption method required by the SMTP server.
 - **Port:** Selects the port that the SMTP server uses.
 - **Authentication:** Use Auto unless directed by your ISP or network administrator.
 - **User Name:** Login username for the SMTP server.
 - **Password:** Login password for the SMTP server.
 - **Email From Address:** The email address that will be shown in the “From:” field of the notification emails.
 - Events
 - **Power On/Off:** Occurs when standby mode is entered and when the display is powered on.
 - **System Error:** Occurs when the display has detected an error within the system.
 - **Source Detect:** Occurs when the display detects and displays a new input signal.
 - **Source Lost:** Occurs when the current input signal is no longer detected.
 - **Source Selected:** Occurs when a different input source is selected for any of the zones.
 - **Note:** Each event can be sent to one or more recipients. To add multiple email addresses, separate them by a space.

- **Test Email:** Sends a test of the selected email notification. This is useful for verifying that your email account settings are setup correctly. If the test email fails, you can use the View Last 10 Log Messages button to get more detailed information about the failure.

NOTIFICATIONS SETTINGS ✕

Email Account Settings

SMTP Server	<input style="width: 90%;" type="text" value="name or IP address"/>
Connection Encryption	<input style="width: 90%;" type="text" value="TLS"/>
Port	<input style="width: 90%;" type="text" value="465"/>
Authentication	<input style="width: 90%;" type="text" value="AUTO"/>
User Name	<input style="width: 90%;" type="text"/>
Password	<input style="width: 90%;" type="password" value="....."/>
Email From Address	<input style="width: 90%;" type="text"/>

SMTP Server name is required

Events

Event	Recipient(s)	Additional Note	Enabled
Power On/Off	<input style="width: 100%;" type="text"/>	<input style="width: 100%;" type="text"/>	<input type="checkbox"/>
System Error	<input style="width: 100%;" type="text"/>	<input style="width: 100%;" type="text"/>	<input type="checkbox"/>
Source Detect	<input style="width: 100%;" type="text"/>	<input style="width: 100%;" type="text"/>	<input type="checkbox"/>
Source Lost	<input style="width: 100%;" type="text"/>	<input style="width: 100%;" type="text"/>	<input type="checkbox"/>
Source Selected	<input style="width: 100%;" type="text"/>	<input style="width: 100%;" type="text"/>	<input type="checkbox"/>

Security Model User Based (USM)

Test Email

Message	<input style="width: 90%;" type="text" value="Power On/Off"/>	<input type="button" value="TEST EMAIL"/>
---------	---	---

- System Settings

SYSTEM SETTINGS
✕

Settings ▾

Enable Status LED

Pixel Orbit

Enable CEC

Display Port Type 1.1 ▾

OSD Menus and Messages ▾

Menu Position CENTER ▾

OSD Transparency
|
●
|
 1

OSD Timeout OFF ▾

Allow Popup Messages

Allow Splash Screen

OSD Rotation LANDSCAPE ▾

Blank Screen Color CYAN ▾

CLOSE

- Logs

LOGS
✕

#	DATE	HOUR	LEVEL	MESSAGE
1				
2				
3				
4				
5				
6				
7				
8				
9				
10				
11				
12				
13				

CLOSE

22. Setup

The Setup tab provides dropdown menus that contains information about the display and provides a means of controlling the display. Refer to the relevant section of “Navigating Through the Menus” on page 42 for more information on each of these items.

- Display
 - **Summary:** Provides the status of the display's current video and audio layout, IP address, model name, serial number, and firmware version. Panel brightness, power settings, and test patterns, can be viewed and adjusted.

The screenshot displays the 'SETUP' tab of the Planar UltraRes P Series user interface. The 'DISPLAY SETUP' panel is open, showing various configuration options. The interface includes a top navigation bar with 'PRESETS', 'SETUP', 'Planar UltraRes P', 'SETTINGS', and 'ADMIN'. The left sidebar contains 'DISPLAY', '+ INPUTS', 'AUDIO', and '+ ZONES'. The main content area is divided into several sections:

- SUMMARY:** System State (ON), Multi-Source View (SINGLE), Audio Zone (ZONE 1), Audio Input (HDMI 1), Volume (50), Mute (OFF), Pattern OSD On Screen (NO), Network IP Address (10.15.0.73).
- PRODUCT INFORMATION:** Model (URP98), Serial (ENG-03-21).
- VERSION INFORMATION:** Firmware (6.0.1654), SCP (6.0.1654), VP (6.0.1586), HDMI (01002100), SPM (1.14).
- PANEL BRIGHTNESS:** Intensity slider (50), Local Dimming (checked).
- POWER SETTINGS:** Auto Power On (unchecked), Power Saving Mode (Disabled), Power Saving Delay (15 minutes), Power On Delay (s) (0.1), Standby Mode (Fast Startup).
- TEST PATTERN:** Test Pattern (dropdown menu).

The bottom of the interface features a 'PLANAR' logo, 'VIEWS' button, and system icons for volume, power, and network.

- Inputs
 - Adjust the Auto Scan Sources settings, and configure EDID for each input.

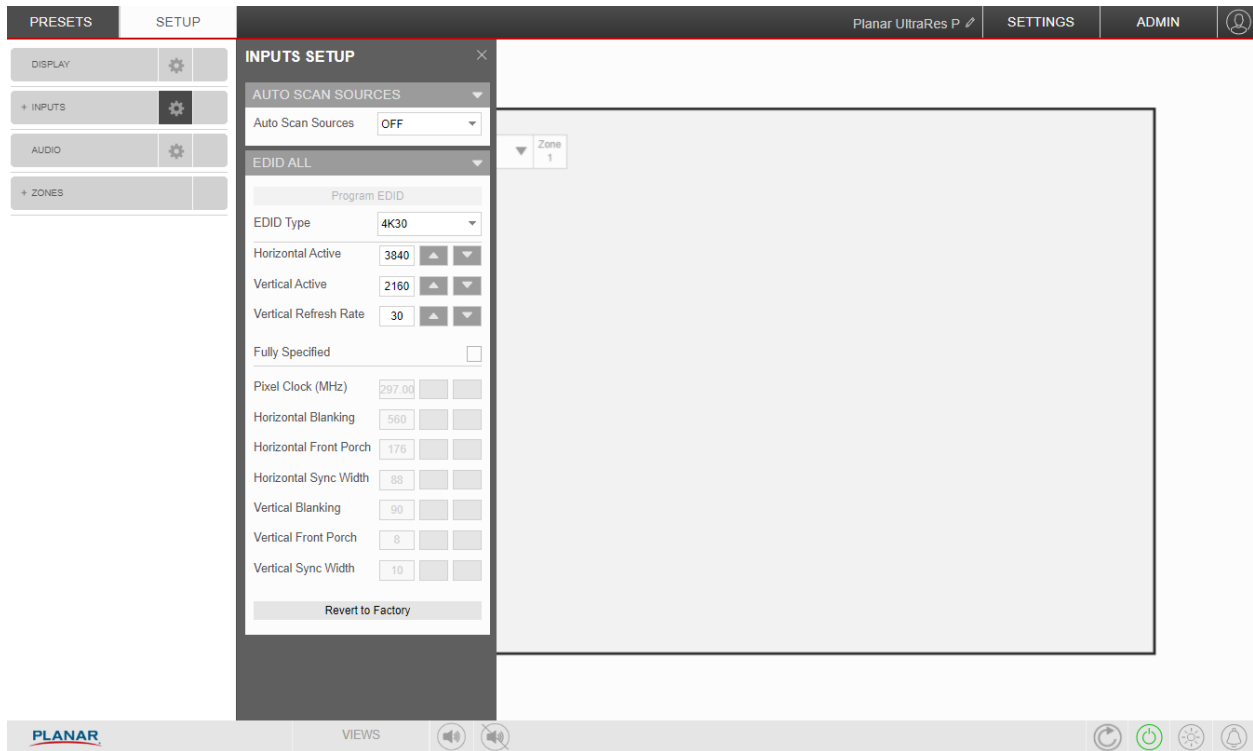

- Audio
 - Adjust the audio settings.

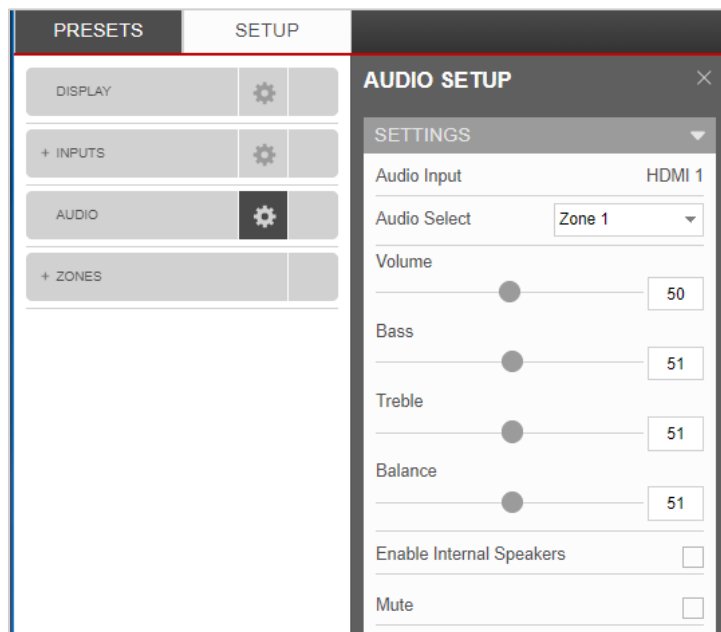

- Zones
 - Provides the image information and image adjustments for each source connected to the display
 - The “Eye” icon will show the current layout of zones on the canvas

- Presets
 - View, create, save, delete, and name presets. Refer to the “Presets Menu” on page 50.

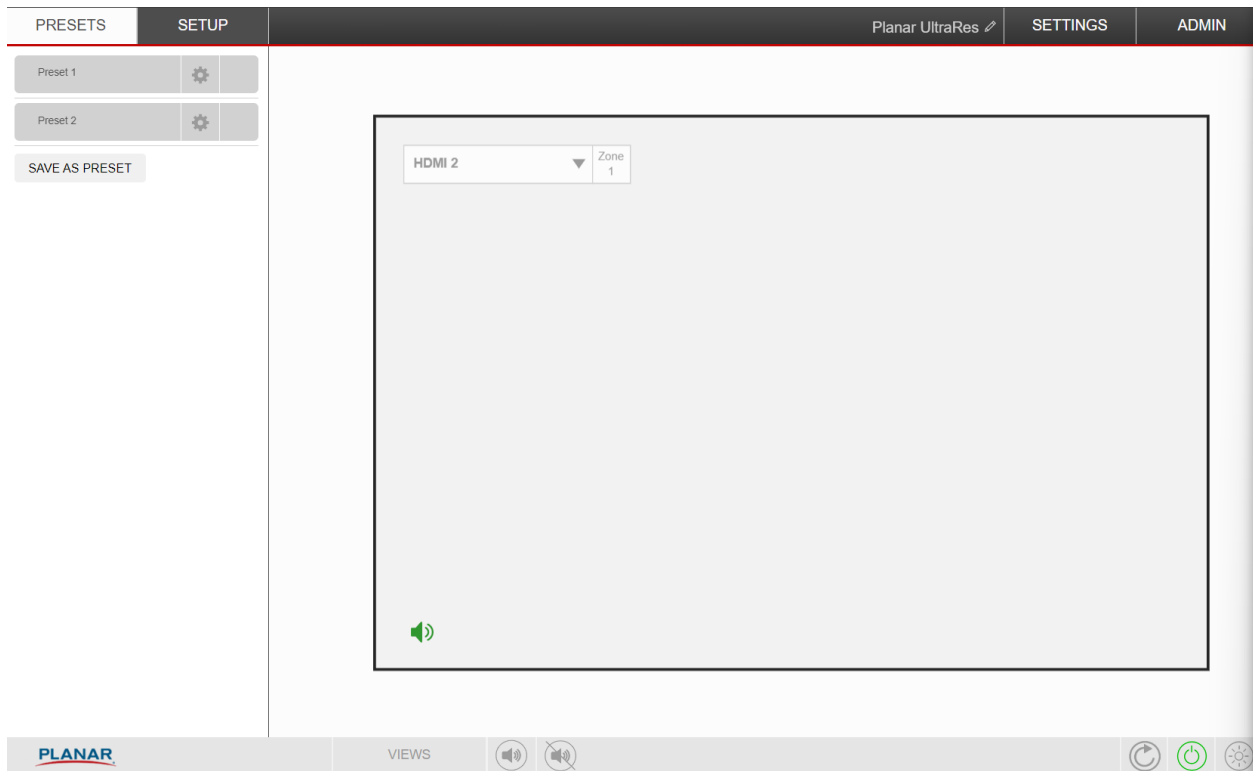

Planar UltraRes P Series URP49 / URP55 / URP65 Remote Monitoring Software

Planar UltraRes P Series Remote Monitoring is a software tool that displays information about the display via a web browser. It is also used to configure email alerts.

23. Login

Launch a web browser. Enter the IP address, shown in the Network submenu.

The default username is Admin. The default password is the serial number, which can be viewed in the System Information submenu. Once logged in, the username and password can be changed.

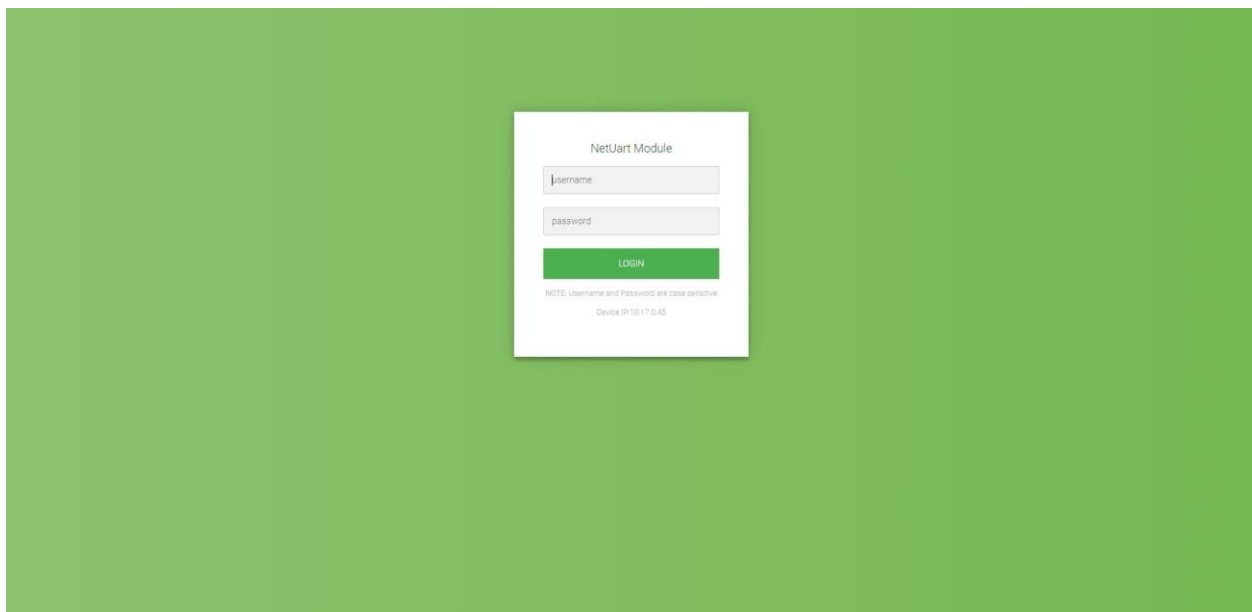

24. Information

This page displays serial number, model number and firmware version.



The screenshot shows a web interface with a header bar containing the word "Information" on the left and navigation links "Network", "SMTP", "SNMP", "Control", and "Logout" on the right. The main content area is a table with four columns. The first three columns contain the following data:

Display S/N	Display Model	Firmware Version	
045508A23E001	URP55	V2056	

25. Network

This page allows for network configuration and changing the admin user name and password.

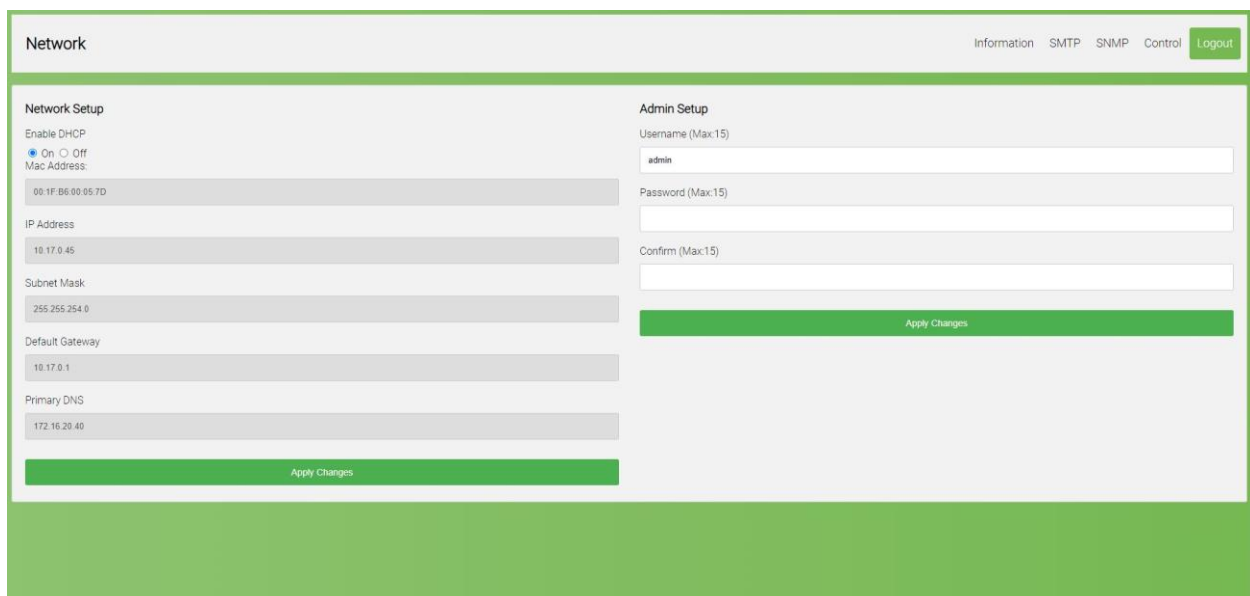

The screenshot shows a web interface with a header bar containing the word "Network" on the left and navigation links "Information", "SMTP", "SNMP", "Control", and "Logout" on the right. The main content area is divided into two sections: "Network Setup" and "Admin Setup".

Network Setup

Enable DHCP
 On Off
Mac Address:
00:1F:86:00:05:7D

IP Address
10.17.0.45

Subnet Mask
255.255.254.0

Default Gateway
10.17.0.1

Primary DNS
172.16.20.40

Admin Setup

Username (Max:15)
admin

Password (Max:15)

Confirm (Max:15)

26. SMTP

This page allows configuration of SMTP and email alerts.

SMTP Information Network SNMP Control [Logout](#)

SMTP Setup

Enable SMTP
 On Off

SMTP Port:

SMTP Server Address (Max 60 chars):

SMTP Connection Encryption
 NONE TLS STARTTLS

SMTP Authentication
 NONE AUTO PLAIN LOGIN

Username (Max 30 chars):

Password (Max 30 chars):

Mail To (Max 100 chars):

Mail From (Max 60 chars):

[Apply Changes](#)

E-Mail Alert Setup

Power Status Alert
 On Off

Subject (Max 40 chars):

Message Body (Max 80 chars):

Source Status Alert
 On Off

Subject (Max 40 chars):

Message Body (Max 80 chars):

Signal Lost Alert
 On Off

Subject (Max 40 chars):

Message Body (Max 80 chars):

[Apply Changes](#)

Test

[Send Test E-Mail](#)

27. SNMP

This page allows configuration of SNMP and Trap.

SNMP Information Network SMTP Control [Logout](#)

SNMP Setup

Enable SNMP
 Off V1/V2c V3

SNMP Port:

SNMP Community (Max 15 chars):

SNMP Write Community (Max 15 chars):

User Name (Max 15 chars):

Security Level
 NoAuthNoPriv AuthNoPriv AuthPriv

Authentication Protocol
 MD5 SHA

Authentication Password (8~15 chars):

Privacy Protocol
 CBC-DES CFB-AES-128

Privacy Password (8~15 chars):

Engine ID:

[Apply Changes](#)

Trap Setup

Enable Trap
 On Off

Trap Port:

Trap IP:

Trap Community (Max 15 chars):

Trap for Power Status Change
 On Off

Trap for Source Change
 On Off

Trap for Signal Lost
 On Off

[Apply Changes](#)

28. Control

This page allows configuration of the control connection type.

Options: Disabled, Telnet, SSH. **Default:** Telnet

The screenshot shows a web interface for configuring the control connection type. The page title is "Control". In the top right corner, there are navigation links for "Information", "Network", "SMTP", "SNMP", and a "Logout" button. The main content area is titled "Control Setup" and contains the following configuration options:

- Connection Type:** Radio buttons for "Disabled", "Telnet" (selected), and "SSH".
- SSH Port:** A text input field containing the value "22".
- Username (Max 30 chars):** A text input field containing the value "admin".
- Password (Max 30 chars):** A text input field with masked characters (dots).
- Idle Session Timeout (1-255 minutes):** A text input field containing the value "3".

At the bottom of the configuration area, there is a green button labeled "Apply Changes".

External Control

In addition to using the Planar UltraRes P Series remote control and display, there are other methods of controlling the Planar UltraRes P Series display externally:

- Using a serial link to send ASCII commands and to receive responses to those commands. The same set of commands can be sent over RS-232, USB, TCP or UDP. See the Planar UltraRes P Series RS232 User Manual for more information.
- Using discrete infrared (IR) codes to program a third-party remote control. See "IR Command Protocol" on page 33.
- Using the Planar UltraRes P Series Remote Monitoring software to access the settings in the OSD as well as some additional features via a web browser. See "Planar UltraRes P Series Remote Monitoring Software" on page 79.
- Using HDMI-CEC with compatible devices. See "CEC" on page 73.

Signal Compatibility

URP75 / URP85 / URP98

Signal Type	Resolution	Frame rate (Hz)	Line Rate (kHz)	Pixel Rate (MHz)	HDMI 1-2	HDMI 3-4	DisplayPort	References
PC	640x480	59.94	31.469	25.175	x	x	x	VESA DMT, CEA-861-F Format 1
	640x480	72	37.861	31.500	x	x	x	VESA DMT
	640x480	74.99	37.500	31.500	x	x	x	VESA DMT
	640x480	85	43.269	36.000	x	x	x	VESA DMT
	800x600	60.32	37.890	40.000	x	x	x	VESA DMT
	800x600	72	48.077	50.000	x	x	x	VESA DMT
	800x600	75	46.875	49.500	x	x	x	VESA DMT
	800x600	85.06	53.674	56.250	x	x	x	VESA DMT
	848x480	59.659	29.830	31.500	x	x	x	VESA CVT
	848x480	74.769	37.684	41.000	x	x	x	VESA CVT
	848x480	84.751	42.969	46.750	x	x	x	VESA CVT
	1024x768	60	48.363	65.000	x	x	x	VESA DMT
	1024x768	70	56.476	75.000	x	x	x	VESA DMT
	1024x768	75.03	60.023	78.750	x	x	x	VESA DMT
	1024x768	85.03	68.677	94.500	x	x	x	VESA DMT
	1152x864	70.012	63.851	94.500	x	x	x	VESA DMT
	1152x864	75	67.500	108.000	x	x	x	VESA DMT
	1152x864	84.999	77.094	121.500	x	x	x	VESA DMT
	1280x768	49.929	39.593	65.250	x	x	x	VESA CVT
	1280x768	59.995	47.396	68.250	x	x	x	VESA CVT-R
1280x768	60	47.776	79.500	x	x	x	VESA CVT	
1280x768	74.893	60.289	102.250	x	x	x	VESA CVT	

Signal Type	Resolution	Frame rate (Hz)	Line Rate (kHz)	Pixel Rate (MHz)	HDMI 1-2	HDMI 3-4	DisplayPort	References
PC	1280x768	84.837	68.633	117.500	x	x	x	VESA CVT
	1280x960	60	60.000	108.000	x	x	x	VESA DMT
	1280x960	75	75.000	126.000	x	x	x	VESA DMT
	1280x960	85.002	85.938	148.500	x	x	x	VESA DMT
	1280x1024	60.02	63.981	108.000	x	x	x	VESA DMT
	1280x1024	75.02	79.976	135.000	x	x	x	VESA DMT
	1280x1024	85.02	91.146	157.500	x	x	x	VESA DMT
	1360x768	60	47.712	85.500	x	x	x	VESA DMT
	1400x1050	49.965	54.113	100.000	x	x	x	VESA CVT
	1400x1050	60	64.7	101.00	x	x	x	VESA CVT-R
	1400x1050	60	65.317	121.750	x	x	x	VESA CVT
	1400x1050	74.867	82.278	156.000	x	x	x	VESA CVT
	1600x1200	60	75.000	162.000	x	x	x	VESA DMT
	1920x1080	49.929	55.621	141.500	x	x	x	VESA CVT
	1920x1080	59.963	67.158	173.000	x	x	x	VESA CVT
	1920x1080	59.950	66.587	138.500	x	x	x	VESA CVT-R
	1920x1200	49.932	61.816	158.250	x	x	x	VESA CVT
	1920x1200	59.950	74.038	154.000	x	x	x	VESA CVT-R
	1680x1050	49.974	54.121	119.500	x	x	x	VESA CVT
	1680x1050	59.954	65.290	146.250	x	x	x	VESA CVT
	1920x2160	60	135.000	297.000	x	x	x	CEA-861-F, VIC 16, with vertical parameters doubled
	2560x1440	59.951	88.787	241.500	x	x	x	VESA CVT-R
	2560x1600	59.972	98.713	268.500	x	x	x	VESA CVT-R
3840x2160	24	52.438	209.750	x	x	x	VESA CVT-R	

Signal Type	Resolution	Frame rate (Hz)	Line Rate (kHz)	Pixel Rate (MHz)	HDMI 1-2	HDMI 3-4	DisplayPort	References
PC	3840x2160	30	65.688	262.750	x	x	x	VESA CVT-R
	3840x2160	50	110.500	442.000	x		x	VESA CVT-R
	3840x2160	60	133.313	533.250	x		x	VESA CVT-R
Apple Mac	640x480	66.59			x	x	x	
	832x624	75.087	49.107	55.000	x	x	x	
	1024x768	59.278	48.193	64.000	x	x	x	
	1024x768	74.927	60.241	80.000	x	x	x	
	1152x870	75.062	68.681	100.000	x	x	x	
SDTV	480i	60			x	x	x	SMPTE 125M, CEA-861-F Formats 6 & 7
	576i	50			x	x	x	ITU-R BT.601, CEA-861-F Formats 21 & 22
EDTV	480p	60	31.469	27.000	x	x	x	ITU-R BT.1358, CEA-861-F Format 17 & 18
	576p	50	31.250	27.000	x	x	x	SMPTE 125M, CEA-861-F Format 6 & 7
HDTV	1080i	50	28.125	74.500	x	x	x	SMPTE 274M, CEA-861-F Format 20
	1080i	60	33.750	74.250	x	x	x	SMPTE 274M, CEA-861-F Format 5
	720p	50	37.500	74.250	x	x	x	SMPTE 296M, CEA-861-F Format 19
	720p	60	45.000	74.250	x	x	x	SMPTE 296M, CEA-861-F Format 4
	1080p	24	27.000	74.250	x	x	x	SMPTE 274M, CEA-861-F Format 32
	1080p	25	28.125	74.250	x	x	x	SMPTE 274M, CEA-861-F Format 33
	1080p	30	33.750	74.250	x	x	x	SMPTE 274M, CEA-861-F Format 34
	1080p	50	56.250	148.500	x	x	x	SMPTE 274M, CEA-861-F Format 31
	1080p	60	67.500	148.500	x	x	x	SMPTE 274M, CEA-861-F Format 16

Signal Type	Resolution	Frame rate (Hz)	Line Rate (kHz)	Pixel Rate (MHz)	HDMI 1-2	HDMI 3-4	DisplayPort	References
UHDTV	3840x2160	24	54.000	297.000	x	x	x	CEA-861-F Format 93, HDMI 1.4b VIC 1
	3840x2160	25	56.250	297.000	x	x	x	CEA-861-F Format 94, HDMI 1.4b VIC 2
	3840x2160	30	67.500	297.000	x	x	x	CEA-861-F Format 95, HDMI 1.4b VIC 3
	3840x2160	50	67.500	297.000	x			CEA-861-F Format 96, 4:2:0 sub-sampling
	3840x2160	50	135.000	594.000	x		x	CEA-861-F Format 96
	3840x2160	60	67.500	297.000	x			CEA-861-F Format 97, 4:2:0 sub-sampling
	3840x2160	60	135.000	594.000	x		x	CEA-861-F Format 97

URP49 / URP55 / URP65

Signal Type	Resolution	Frame Rate (Hz)	Line Rate (kHz)	Pixel Rate (MHz)	HDMI 1-2	HDMI 3-4	DP 1-2	VGA	References
PC	640x480	59.94	31.469	25.175	x	x	x	x	VESA DMT, CEA-861-F Format 1
	640x480	72.809	37.861	31.5	x	x	x	x	VESA DMT
	640x480	75	37.5	31.5	x	x	x	x	VESA DMT
	640x480	85.008	43.269	36	x	x	x	x	VESA DMT
	800x600	60.317	37.879	40	x	x	x	x	VESA DMT
	800x600	72.188	48.077	50	x	x	x	x	VESA DMT
	800x600	75	46.875	49.5	x	x	x	x	VESA DMT
	800x600	85.061	53.674	56.25	x	x	x	x	VESA DMT
	848x480	59.659	29.83	31.5	x	x	x	x	VESA CVT
	848x480	74.769	37.684	41	x	x	x	x	VESA CVT
	848x480	84.751	42.969	46.75	x	x	x	x	VESA CVT

Signal Type	Resolution	Frame Rate (Hz)	Line Rate (kHz)	Pixel Rate (MHz)	HDMI 1-2	HDMI 3-4	DP 1-2	VGA	References
PC	1024x768	60.004	48.363	65	x	x	x	x	VESA DMT
	1024x768	70.069	56.476	75	x	x	x	x	VESA DMT
	1024x768	75.029	60.023	78.75	x	x	x	x	VESA DMT
	1024x768	84.997	68.677	94.5	x	x	x	x	VESA DMT
	1152x864	70.012	63.851	94.5	x	x	x	x	VESA DMT
	1152x864	75	67.5	108	x	x	x	x	VESA DMT
	1152x864	84.999	77.094	121.5	x	x	x	x	VESA DMT
	1280x768	49.929	39.593	65.25	x	x	x	x	VESA CVT
	1280x768	59.995	47.396	68.25	x	x	x	x	VESA CVT-R
	1280x768	59.87	47.776	79.5	x	x	x	x	VESA CVT
	1280x768	74.893	60.289	102.25	x	x	x	x	VESA CVT
	1280x768	84.837	68.633	117.5	x	x	x	x	VESA CVT
	1280x960	60	60	108	x	x	x	x	VESA DMT
	1280x960	75	75	126	x	x	x	x	VESA DMT
	1280x960	85.002	85.938	148.5	x	x	x	x	VESA DMT
	1280x1024	60.02	63.981	108	x	x	x	x	VESA DMT
	1280x1024	75.025	79.976	135	x	x	x	x	VESA DMT
	1280x1024	85.024	91.146	157.5	x	x	x	x	VESA DMT
	1366x768	59.79	47.712	85.5	x	x	x	x	VESA DMT
	1400x1050	49.965	54.113	100	x	x	x	x	VESA CVT
	1400x1050	59.948	64.744	101	x	x	x	x	VESA CVT-R
	1400x1050	59.978	65.317	121.75	x	x	x	x	VESA CVT
	1400x1050	74.867	82.278	156	x	x	x	x	VESA CVT
	1600x1200	60	75	162	x	x	x	x	VESA DMT
	1920x1080	49.929	55.621	141.5	x	x	x	x	VESA CVT

Signal Type	Resolution	Frame Rate (Hz)	Line Rate (kHz)	Pixel Rate (MHz)	HDMI 1-2	HDMI 3-4	DP 1-2	VGA	References
PC	1920x1080	59.963	67.158	173	x	x	x	x	VESA CVT
	1920x1080	59.95	66.587	138.5	x	x	x	x	VESA CVT-R
	1920x1200	49.932	61.816	158.25	x	x	x	x	VESA CVT
	1920x1200	59.95	74.038	154	x	x	x	x	VESA CVT-R
	1680x1050	49.974	54.121	119.5	x	x	x	x	VESA CVT
	1680x1050	59.954	65.29	146.25	x	x	x	x	VESA CVT
	1920x2160	60	135	297	x	x	x		CEA-861-F, VIC 16, with vertical parameters doubled
	1920x2160	59.988	133.293	277.25	x	x	x		VESA CVT-R
	2560x1440	59.951	88.787	241.5	x	x	x		VESA CVT-R
	2560x1600	59.972	98.713	268.5	x	x	x		VESA CVT-R
	3840x2160	23.999	52.438	209.75	x	x	x		VESA CVT-R
	3840x2160	29.981	65.688	262.75	x	x	x		VESA CVT-R
	3840x2160	49.977	110.5	442	x		x		VESA CVT-R
	3840x2160	59.997	133.313	533.25	x		x		VESA CVT-R
Apple Mac	640x480	66.59			x	x	x	x	
	832x624	75.087	49.107	55	x	x	x	x	
	1024x768	59.278	48.193	64	x	x	x	x	
	1024x768	74.927	60.241	80	x	x	x	x	
	1152x870	75.062	68.681	100	x	x	x	x	
EDTV	480p	60	31.469	27	x	x	x	x	ITU-R BT.1358, CEA-861-F Format 17 & 18
	576p	50	31.25	27	x	x	x	x	SMPTE 125M, CEA-861-F Format 6 & 7
HDTV	720p	50	37.5	74.25	x	x	x	x	SMPTE 296M, CEA-861-F Format 19
	720p	60	45	74.25	x	x	x	x	SMPTE 296M, CEA-861-F Format 4
	1080p	24	27	74.25	x	x	x	x	SMPTE 274M, CEA-861-F Format 32

Signal Type	Resolution	Frame Rate (Hz)	Line Rate (kHz)	Pixel Rate (MHz)	HDMI 1-2	HDMI 3-4	DP 1-2	VGA	References
HDTV	1080p	25	28.125	74.25	x	x	x	x	SMPTE 274M, CEA-861-F Format 33
	1080p	30	33.75	74.25	x	x	x	x	SMPTE 274M, CEA-861-F Format 34
	1080p	50	56.25	148.5	x	x	x	x	SMPTE 274M, CEA-861-F Format 31
	1080p	60	67.5	148.5	x	x	x	x	SMPTE 274M, CEA-861-F Format 16
UHDTV	3840x2160	24	54	297	x	x	x		CEA-861-F Format 93, HDMI 1.4b VIC 1
	3840x2160	25	56.25	297	x	x	x		CEA-861-F Format 94, HDMI 1.4b VIC 2
	3840x2160	30	67.5	297	x	x	x		CEA-861-F Format 95, HDMI 1.4b VIC 3
	3840x2160	50	56.25	297	x				CEA-861-F Format 96, 4:2:0 sub-sampling
	3840x2160	50	112.5	594	x		x		CEA-861-F Format 96
	3840x2160	60	67.5	297	x				CEA-861-F Format 97, 4:2:0 sub-sampling
	3840x2160	60	135	594	x		x		CEA-861-F Format 97
	4096x2160	24	54	297	x	x	x		CEA-861-F Format 98
	4096x2160	25	56.25	297	x	x	x		CEA-861-F Format 99
	4096x2160	30	67.5	297	x	x	x		CEA-861-F Format 100

Color Subsampling Report

Video Timing	Input	RGB 4:4:4 Supported	YUV 4:4:4 Supported	YUV 4:2:2 Supported	YUV 4:2:0 Supported
4K @ 50/60 Hz	DP	x	x	x	
4K @ 50/60 Hz	HDMI 1-2	x	x	x	x
4K @ 50/60 Hz	HDMI 3-4				
All Other Supported Timings	Any	x	x	x	

Power Consumption

The power consumption values stated in the Specifications table are calculated under the typical conditions of viewing a single source with default settings. The “Power Consumption: Backlight Max (Typ.)” value is calculated by increasing the default backlight value of 75 to 100, and multiplying the wattage by approximately 1.33. The power consumption would increase above these specified values if multi-source views are introduced, and should be taken into account when estimating power consumption.

Specifications

Item	URP49 URP49-T	URP55 URP55-T	URP65 URP65-T
LCD Panel			
Display Technology	Commercial-Grade IPS LCD		
Resolution	3840x2160		
Aspect Ratio	16:9		
Screen Size	49"	55"	65"
Orientation	Landscape/Portrait		
Brightness (Typ.)	Non-T versions: 500 cd/m ² -T versions: 450 cd/m ²		
Contrast Ratio (Typ.)	1100:1		
Viewing Angle (Typ.)	178 degrees		
Response Time (Typ.)	8ms		
Color Gamut	72% NTSC		
Display Color	1.07 billion (10-bit depth)		
Haze (Typ.)	28%		
Connectivity			
Standard Inputs	DisplayPort 1.2 x 2, HDMI 2.0 x 2, HDMI 1.4 x 2, VGA		
HDCP 2.2	Yes (HDMI 2.0)		
Audio Output	Line out, S/PDIF out		
Control and Monitoring	LAN RJ45, RS232 In, IR, HDMI CEC, Keypad		
Mechanical			
Display Dimensions w/Handles	URP49: 43.3" x 24.9" x 2.9" (1099.4mm x 632.2mm x 74.8mm) URP49-T: 44.4" x 25.9" x 3.1" (1127.2mm x 657.4mm x 78.8mm)	URP55: 48.6" x 27.9" x 2.9" (1235.6mm x 709.0mm x 74.8mm) URP55-T: 49.8" x 28.9" x 3.1" (1263.8mm x 734.2mm x 77.8mm)	URP65: 57.3" x 32.8" x 2.9" (1454.4mm x 832.2mm x 74.8mm) URP65-T: 58.4" x 33.8" x 3.1" (1482.7mm x 857.5mm x 78.8mm)
Display Dimensions w/o Handles	URP49: 43.3" x 24.9" x 2.6" (1099.4mm x 632.2mm x 65.8mm) URP49-T: 44.4" x 25.9" x 2.8" (1127.2mm x 657.4mm x 69.8mm)	URP55: 48.6" x 27.9" x 2.6" (1235.6mm x 709.0mm x 65.8mm) URP55-T: 49.8" x 28.9" x 2.7" (1263.8mm x 734.2mm x 68.8mm)	URP65: 57.3" x 32.8" x 2.7" (1454.4mm x 832.2mm x 67.3mm) URP65-T: 58.4" x 33.8" x 2.8" (1482.7mm x 857.5mm x 71.3mm)

Item	URP49 URP49-T	URP55 URP55-T	URP65 URP65-T
Display Edge to Active Area	URP49: 12.8mm URP49-T: 26.7mm	URP55: 13mm URP55-T: 27.1mm	URP65: 13mm URP65-T: 27.1mm
Bezel Width	URP49: 10mm (top), 10.5mm (left / right), 13.6mm (bottom) URP49-T: 1.5mm even	URP55: 10mm (top), 10.5mm (left / right), 13.6mm (bottom) URP55-T: 1.5mm even	URP65: 10mm (top), 10.5mm (left / right), 13.6mm (bottom) URP65-T: 1.5mm even
Display Weight	URP49: 46 lbs (21 kg) URP49-T: 63 lbs (29 kg)	URP55: 57 lbs (26 kg) URP55-T: 77 lbs (35 kg)	URP65: 84 lbs (38 kg) URP65-T: 110 lbs (50 kg)
Mounting (Display)	VESA 300 mm x 300 mm		VESA 400 mm x 400 mm
Mounting (Peripheral Device)	VESA 100 mm x 100 mm		
Fanless	Yes		
Speakers	10W x 2 built-in		
Recommended Usage	Up to 24x7		
Backlight	E-LED		
Backlight Life (Typ.)	30,000 hours		
Power Consumption (Typ.)	80W	85W	100W
Power Consumption Max Backlight (Typ.)	114W	121W	143W
BTU/hr (Typ.)	80W x 3.42 BTU = 274 BTU/hr	85W x 3.42 BTU = 291 BTU/hr	100W x 3.42 BTU = 342 BTU/hr
Standby Power Consumption	< 0.5W		
Input Voltage / Frequency	AC 100-240V 50-60 Hz		
AC Inlet Type	C14		
Storage Temperature	Min -4°F ~ Max 140°F (-20°C ~ 60°C)		
Operating Temperature	Min 32°F ~ Max 104°F (0-40°C) at up to 3000 m		
Humidity	20-85% RH		
Approvals	FCC Class A, cTUVus, CE		
ENERGY STAR Certified	Yes		
Touch (-T models only)			
Surface Treatment	Anti-glare (AG) + Anti-fingerprint (AF)		
Protective Glass	3mm semi-tempered glass		
Touch Technology	Projected Capacitive 50-point, 2mm minimum tip width		
Touch Interface	USB-B		

Item	URP49 URP49-T	URP55 URP55-T	URP65 URP65-T
Supporting OS	Windows 7, 8, 10, 11; Mac OSX, Linux		

Passive Pen

Item	Specification
Weight	15g (0.5 oz)
Length	153mm (6in)
Stylus Tips	2 tips, 2mm and 7mm
Tips Active Force	250 ± 50g

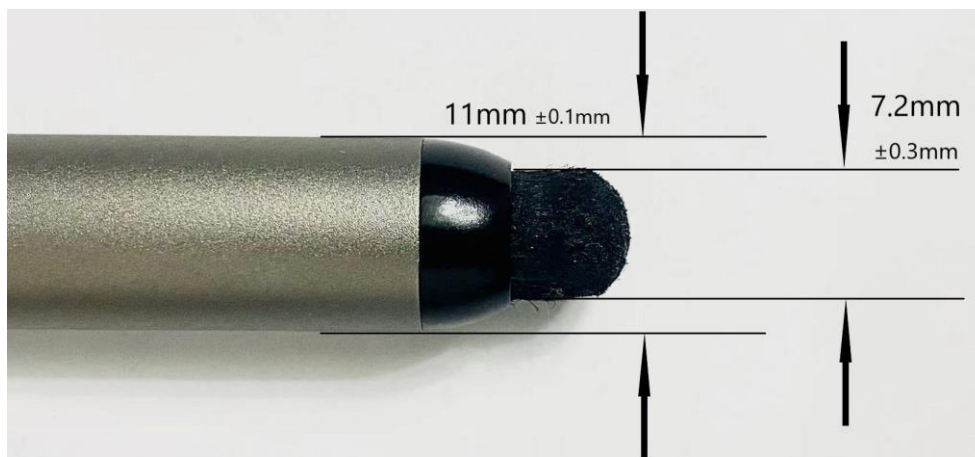
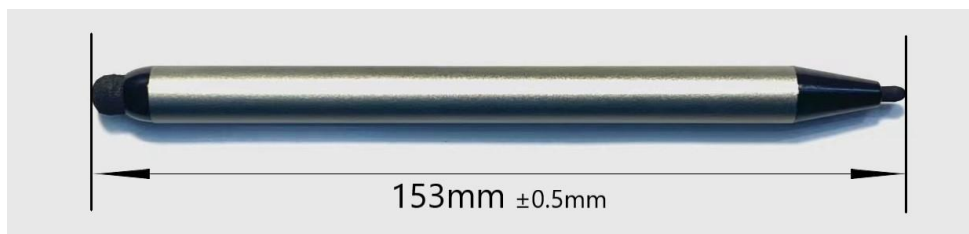

Item	URP75 URP75-ERO-T	URP85 URP85-ERO-T	URP98 URP98-ERO-T
LCD Panel			
Display Technology	Commercial-Grade ADS LCD	Commercial-Grade VA LCD	Commercial-Grade IPS LCD
Resolution	3840x2160		
Aspect Ratio	16:9		
Screen Size	75"	85"	98"
Orientation	Landscape/Portrait		
Brightness (Typ.)	Non-ERO versions: 500 cd/m ² ERO-T versions: 450 cd/m ²		
Contrast Ratio (Typ.)	1200:1	5000:1	1200:1
Viewing Angle (Typ.)	178 degrees		
Response Time (Typ.)	8ms	9.5ms	8ms
Color Gamut	72% NTSC		
Display Color	1.07 billion (10-bit depth)		
Haze (Typ.)	25%	25%	28%
Connectivity			
Standard Inputs	DisplayPort 1.2, HDMI 2.0 x 2, HDMI 1.4 x 2		
HDCP 2.2	Yes (HDMI 2.0)		
Audio Output	Line out, S/PDIF out		
Control and Monitoring	LAN RJ45, RS232 In, IR, HDMI CEC, Keypad, Planar UltraRes™ Web UI		
Mechanical			
Display Dimensions w/Handles	URP75: 66.3" x 37.9" x 3.6" (1684.0mm x 962.0mm x 91.2mm) URP75-ERO-T: 67.6" x 39.2" x 4.1" (1717.0mm x 995.0mm x 103.7mm)	URP85: 74.9" x 42.6" x 3.7" (1902.0mm x 1083.0mm x 92.6mm) URP85-ERO-T: 76.2" x 44.0" x 4.1" (1936.0mm x 1117.0mm x 104.5mm)	URP98: 86.3" x 49.1" x 3.8" (2192.0mm x 1247.0mm x 97.6mm) URP98-ERO-T: 87.5" x 50.3" x 4.2"
Display Dimensions w/o Handles	URP75: 66.3" x 37.9" x 3.6" (1684.0mm x 962.0mm x 91.2mm) URP75-ERO-T: 67.6" x 39.2" x 4.1" (1717.0mm x 995.0mm x 103.7mm)	URP85: 74.9" x 42.6" x 3.5" (1902.0mm x 1083.0mm x 89.4mm) URP85-ERO-T: 76.2" x 44.0" x 4.1" (1936.0mm x 1117.0mm x 104.5mm)	URP98: 86.3" x 49.1" x 3.5" (2192.0mm x 1247.0mm x 89.6mm) URP98-ERO-T: 87.5" x 50.3" x 3.9" (2221.0mm x 1276.0mm x 98.9mm)
Display Edge to Active Area	URP75: 16.9mm URP75-ERO-T: 33.7mm	URP75: 15mm URP75-ERO-T: 31.8mm	URP98: 16.5mm Right, Left; 16.2mm Top, Bottom

Item	URP75 URP75-ERO-T	URP85 URP85-ERO-T	URP98 URP98-ERO-T
			URP98-ERO-T: 31.3mm Right, Left; 31.0 mm Top, Bottom
Bezel Width	URP75: 14.9mm even URP75-ERO-T: 15.1mm even	URP85: 13mm even URP85-ERO-T: 15.1mm even	URP98: 15.2mm: even URP98-ERO-T: 15.1mm even
Display Weight	URP75: 92 lbs (42 kg) URP75-ERO-T: 138 lbs (63 kg)	URP85: 127 lbs (58 kg) URP85-ERO-T: 181 lbs (82 kg)	URP98: 209 lbs (95 kg) URP98-ERO-T: 278 lbs (126 kg)
Mounting (Display)	VESA 600 mm x 400 mm		
Mounting (Peripheral Device)	VESA 100 mm x 100 mm		
Fanless	Yes		
Speakers	10W x 2 built-in		
ERO (ERO-T models only)			
Surface Treatment	Anti-glare (AG)		Anti-reflective (AR)
Protective Glass	2mm Corning® Gorilla® Glass		3mm Soda-lime Glass
Touch (ERO-T models only)			
Touch Technology	IR 20-point Standard Writing: 10 points, 8mm minimum tip width Fine Tip Writing: 5 points, 2mm minimum tip width		
Touch Interface	USB-B		
Supporting OS	Windows 7, 8, 10, 11; Mac OSX, Linux		
Usage			
Recommended Usage	Up to 24x7		
Backlight	D-LED		
Backlight Life (Typ.)	50,000 hours		60,000 hours
Power Source			
Power Consumption (Typ.)	195W	175W	273W
Power Consumption Max Backlight (Typ.)	260W	233W	363W
BTU/hr (Typ.)	195W x 3.42 BTU = 667 BTU/hr	175W x 3.42 BTU = 599 BTU/hr	273W x 3.42 BTU = 934 BTU/hr
Standby Power Consumption	< 0.5W		
Input Voltage / Frequency	AC 100-240V 50-60 Hz		
AC Inlet Type	C14		

Item	URP75 URP75-ERO-T	URP85 URP85-ERO-T	URP98 URP98-ERO-T
Environment			
Storage Temperature	Min -4°F ~ Max 140°F (-20°C ~ 60°C)		
Operating Temperature	Min 32°F ~ Max 104°F (0-40°C) at up to 3000 m	Min 32°F ~ Max 104°F (0-40°C) at up to 1000 m Min 32°F ~ Max 95°F (0-35°C) at up to 2000 m Min 32°F ~ Max 86°F (0-30°C) at up to 3000 m	
Humidity	20-85% RH		
Approvals	FCC Class A, cTUVus, CE		
ENERGY STAR Certified	Yes	Yes	No

Dimensions

29. URP49

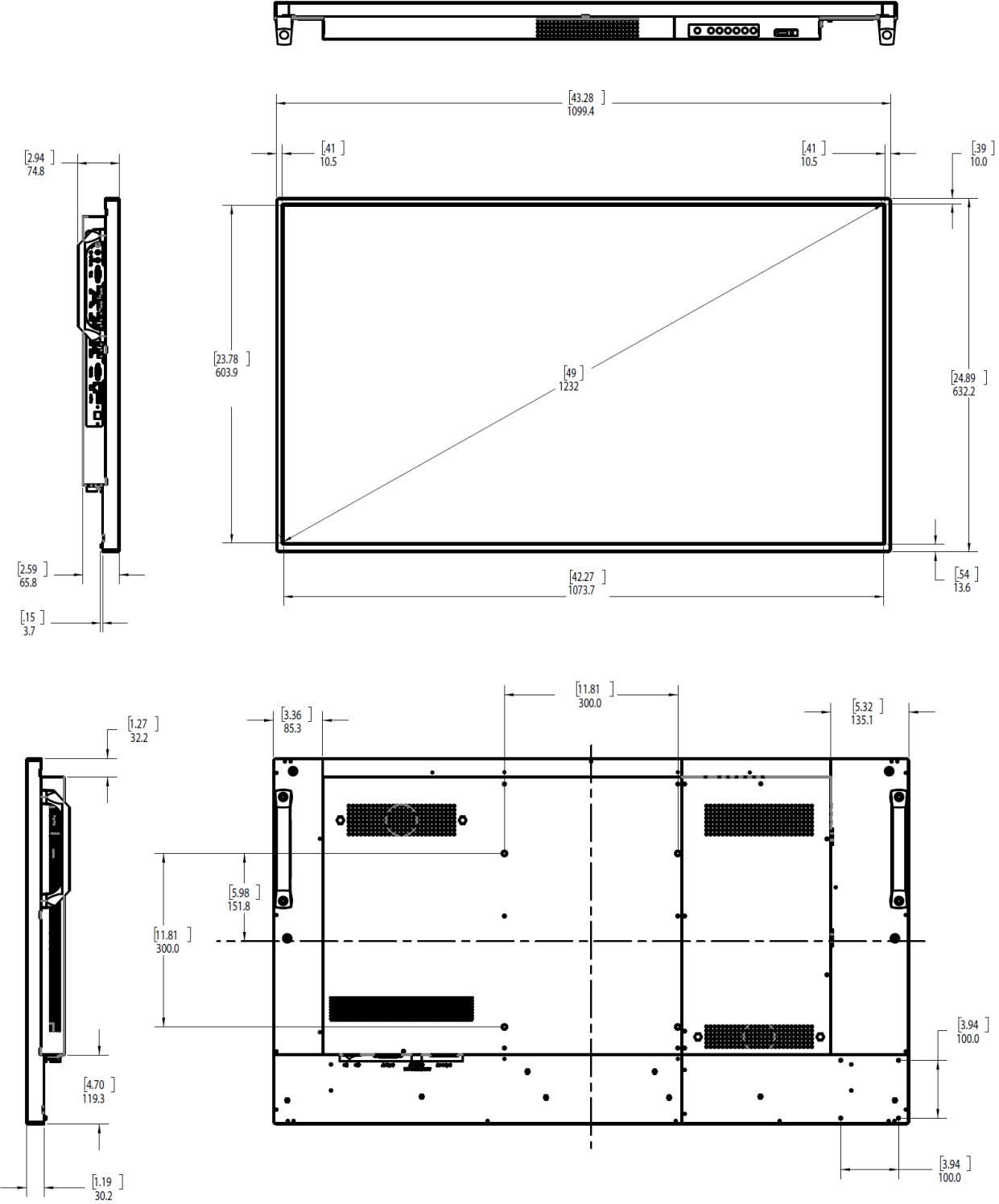

30. URP49-T

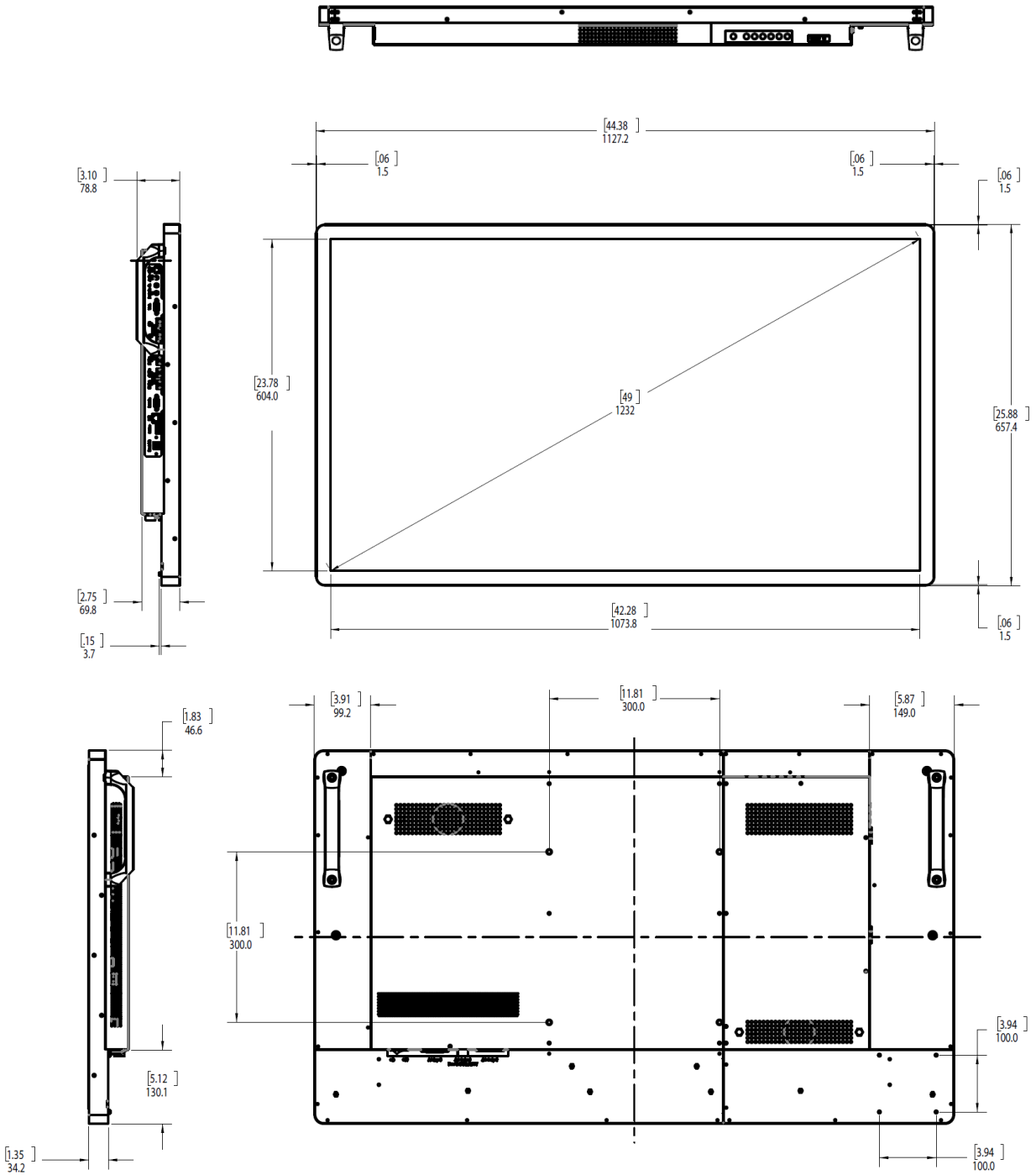

31. URP55

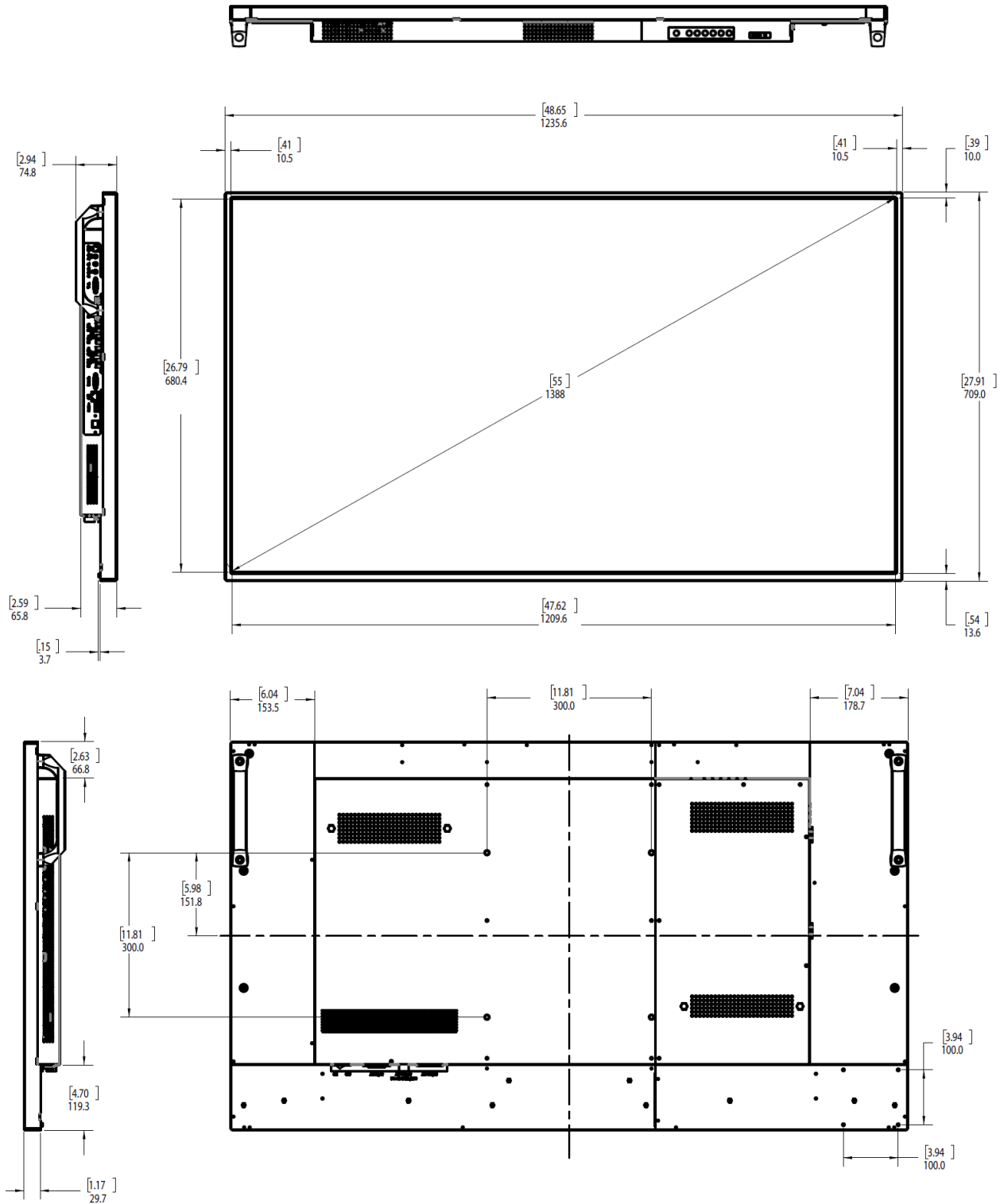

32. URP55-T

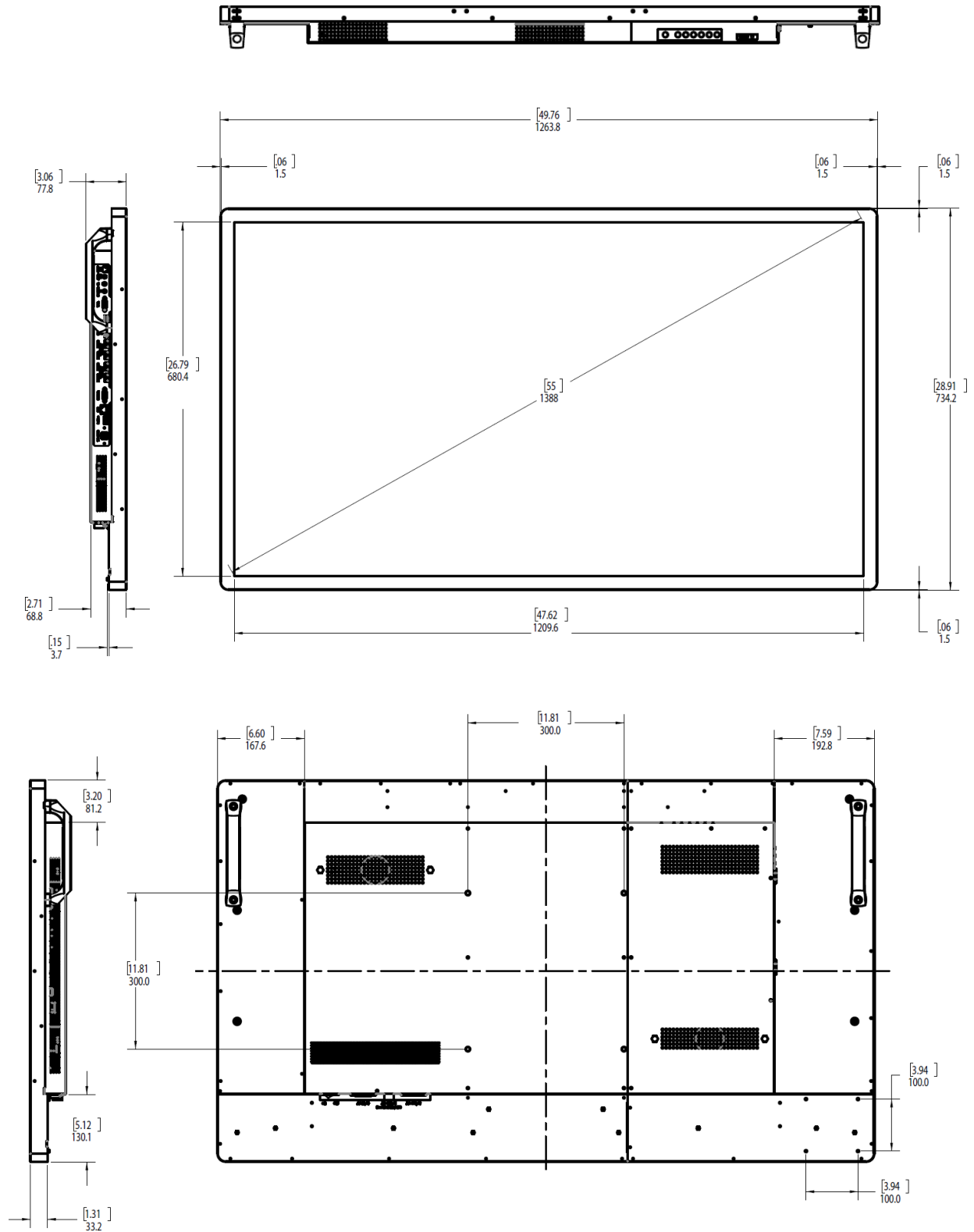

33. URP65

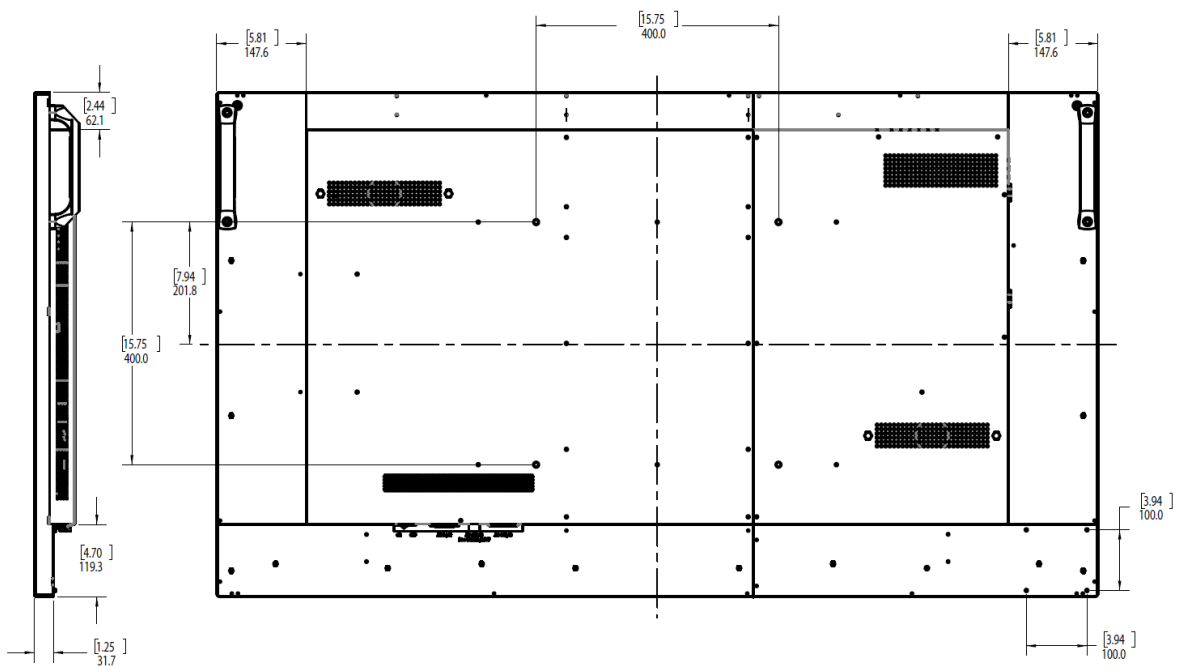
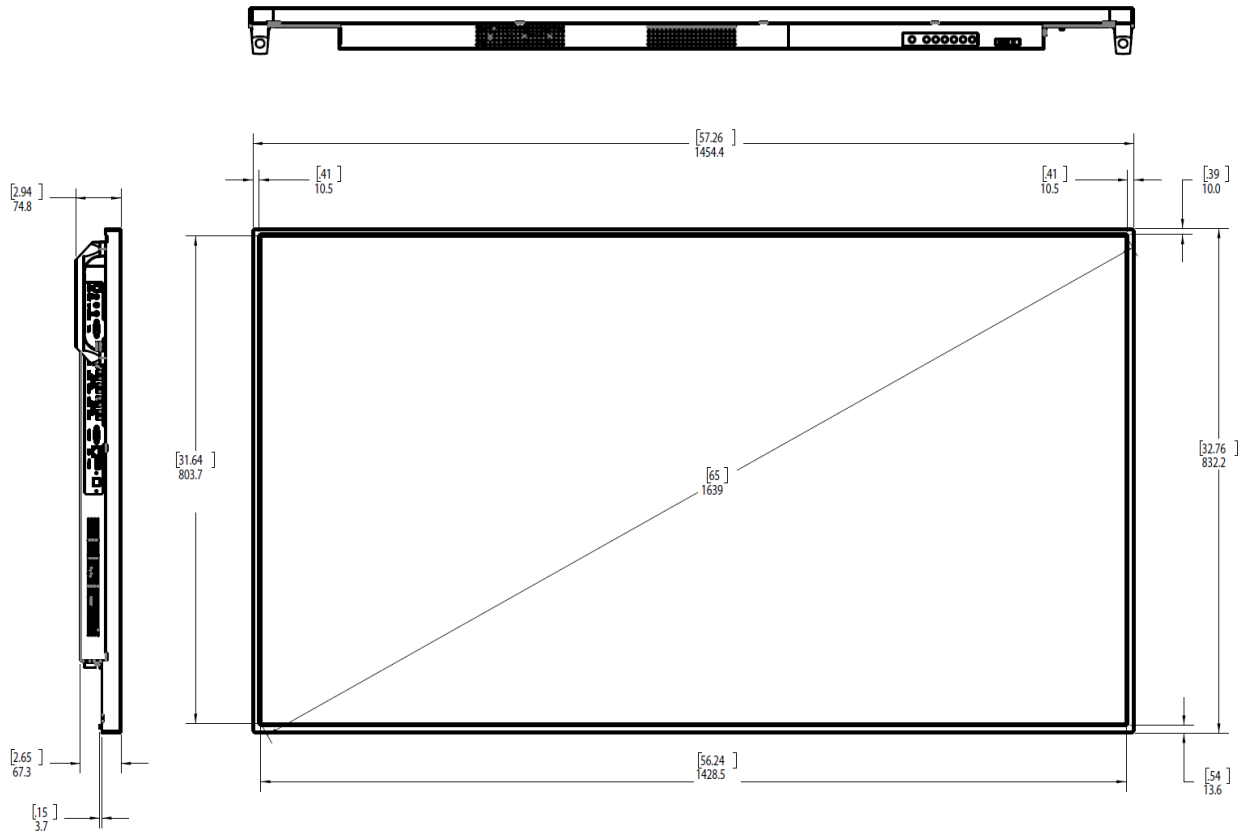

34. URP65-T

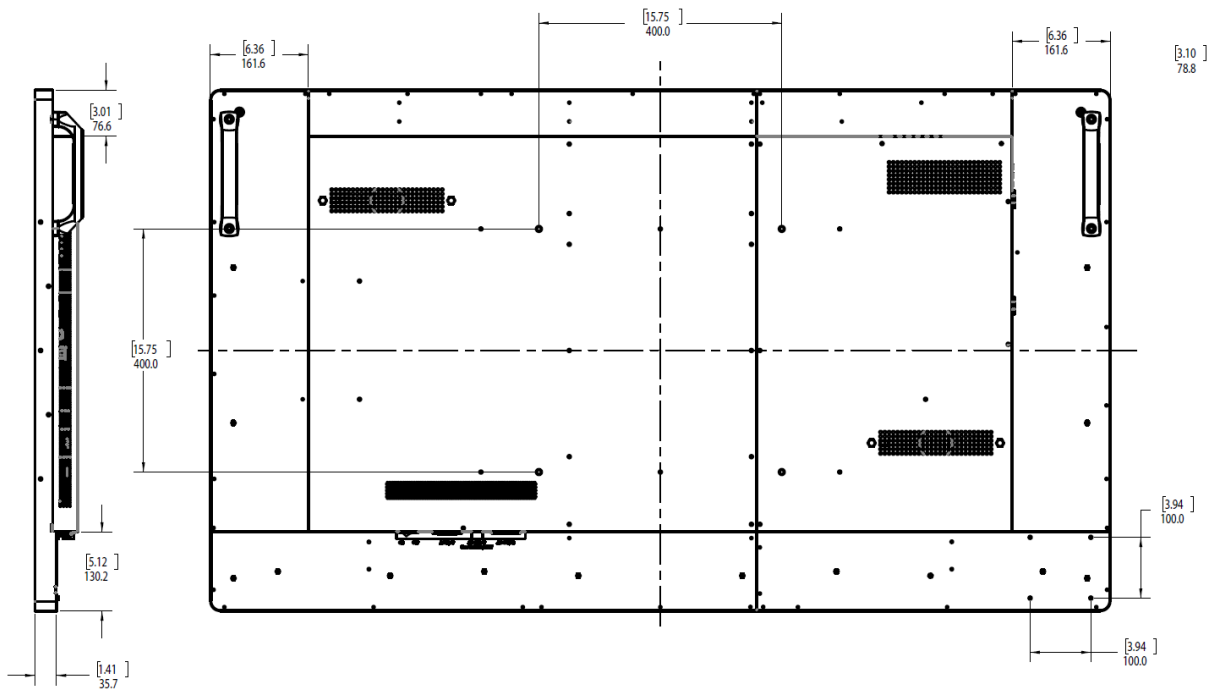
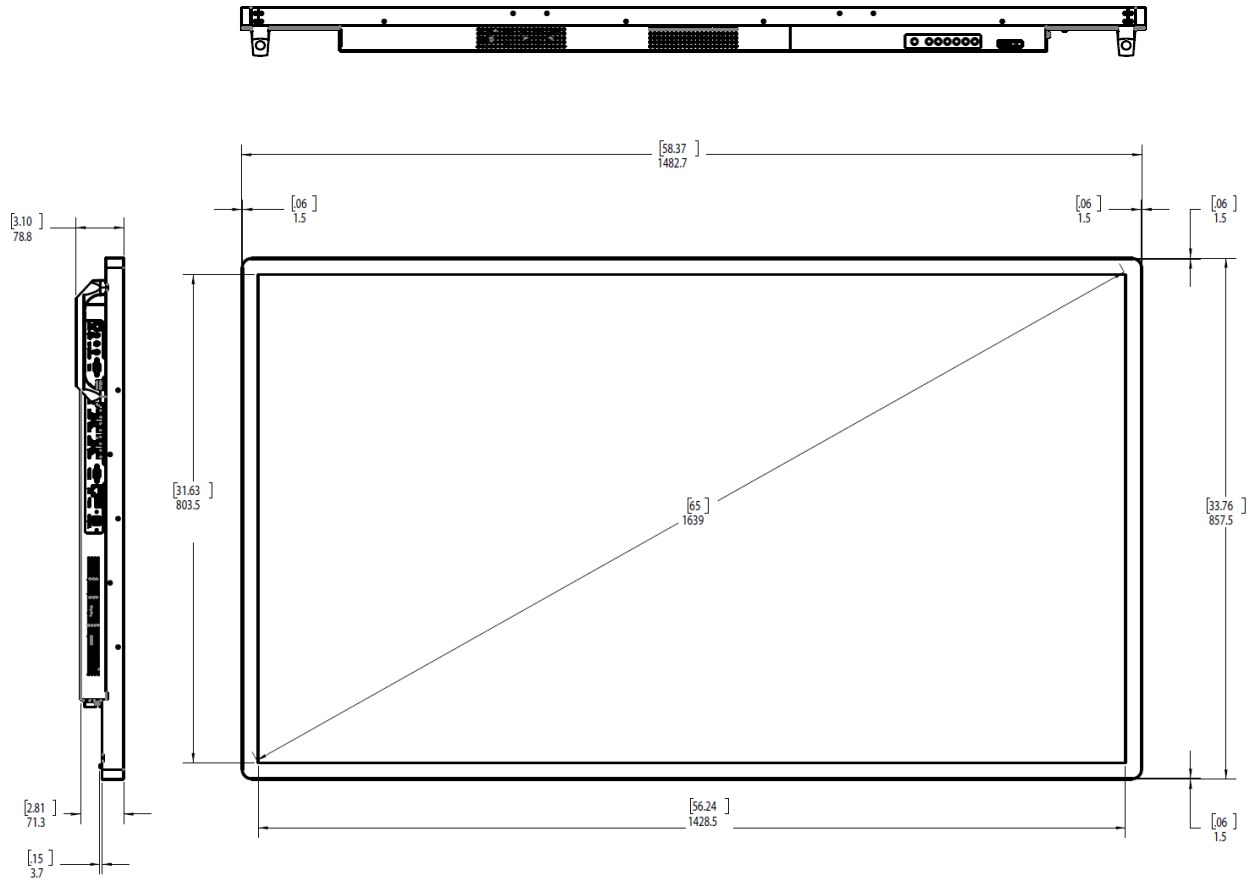

35. URP75

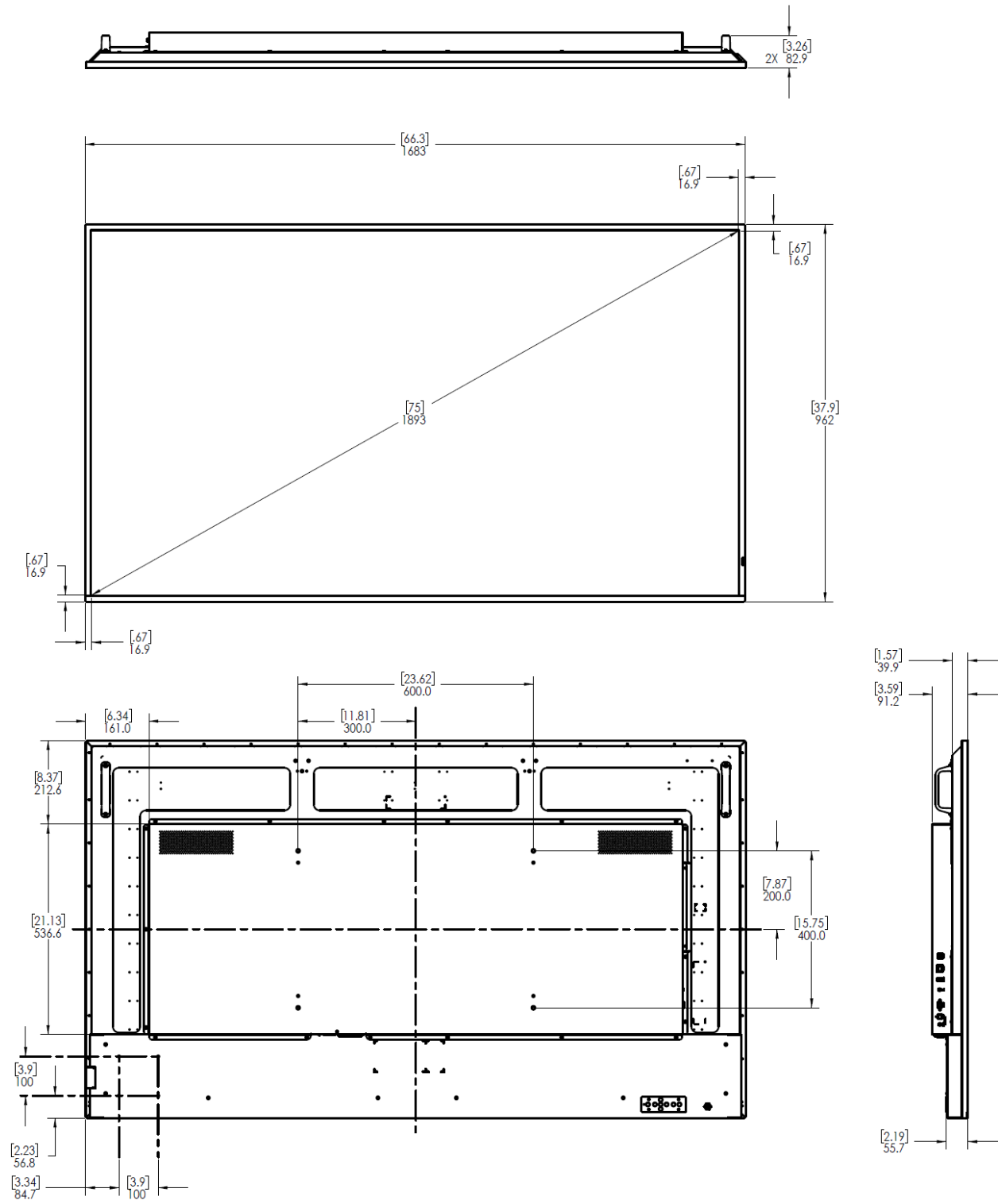

36. URP75-ERO-T

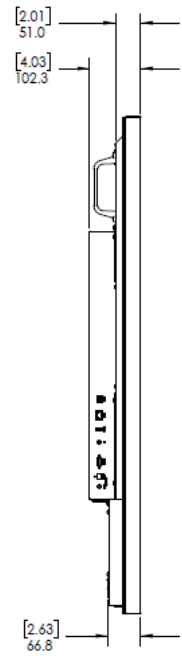
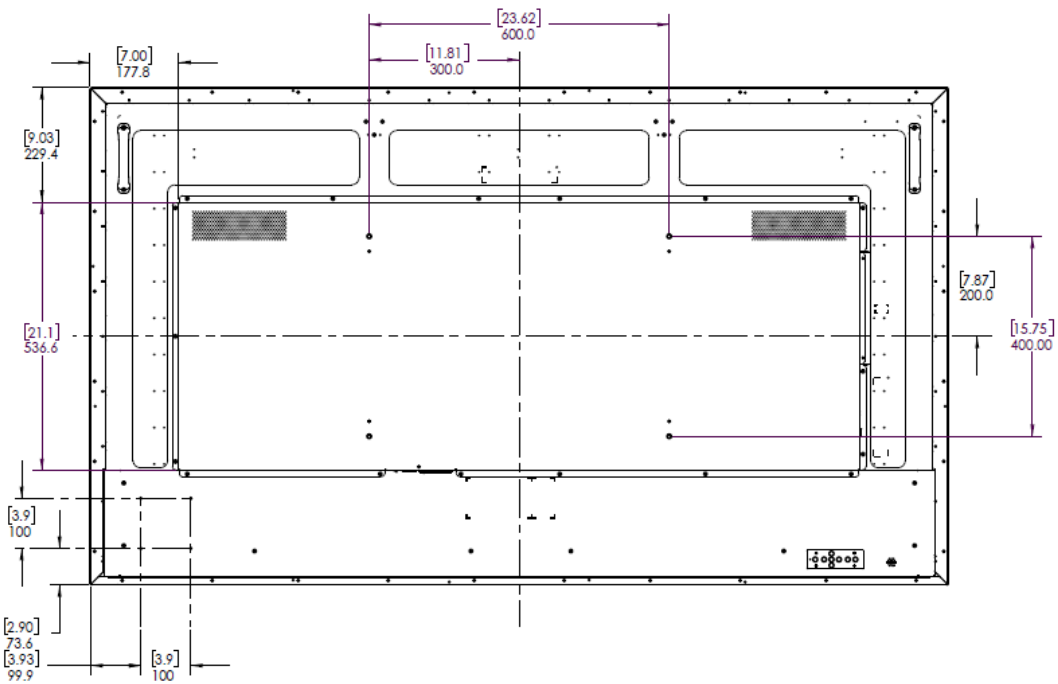
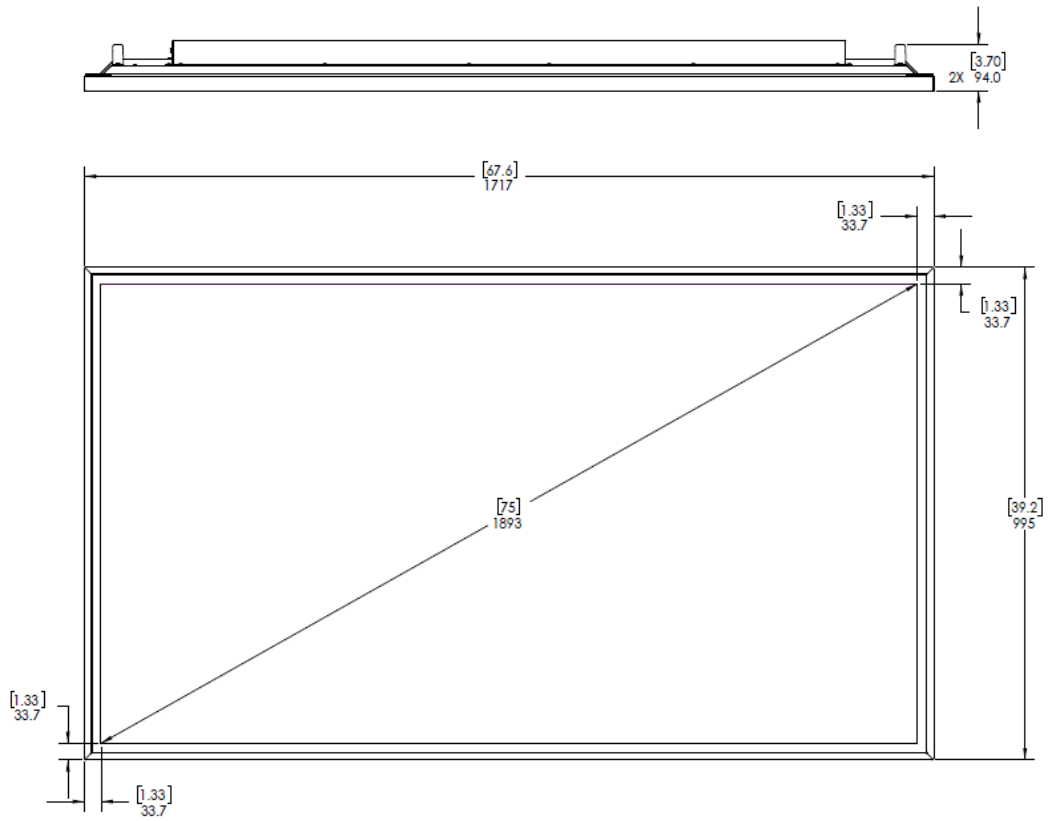

37. URP85

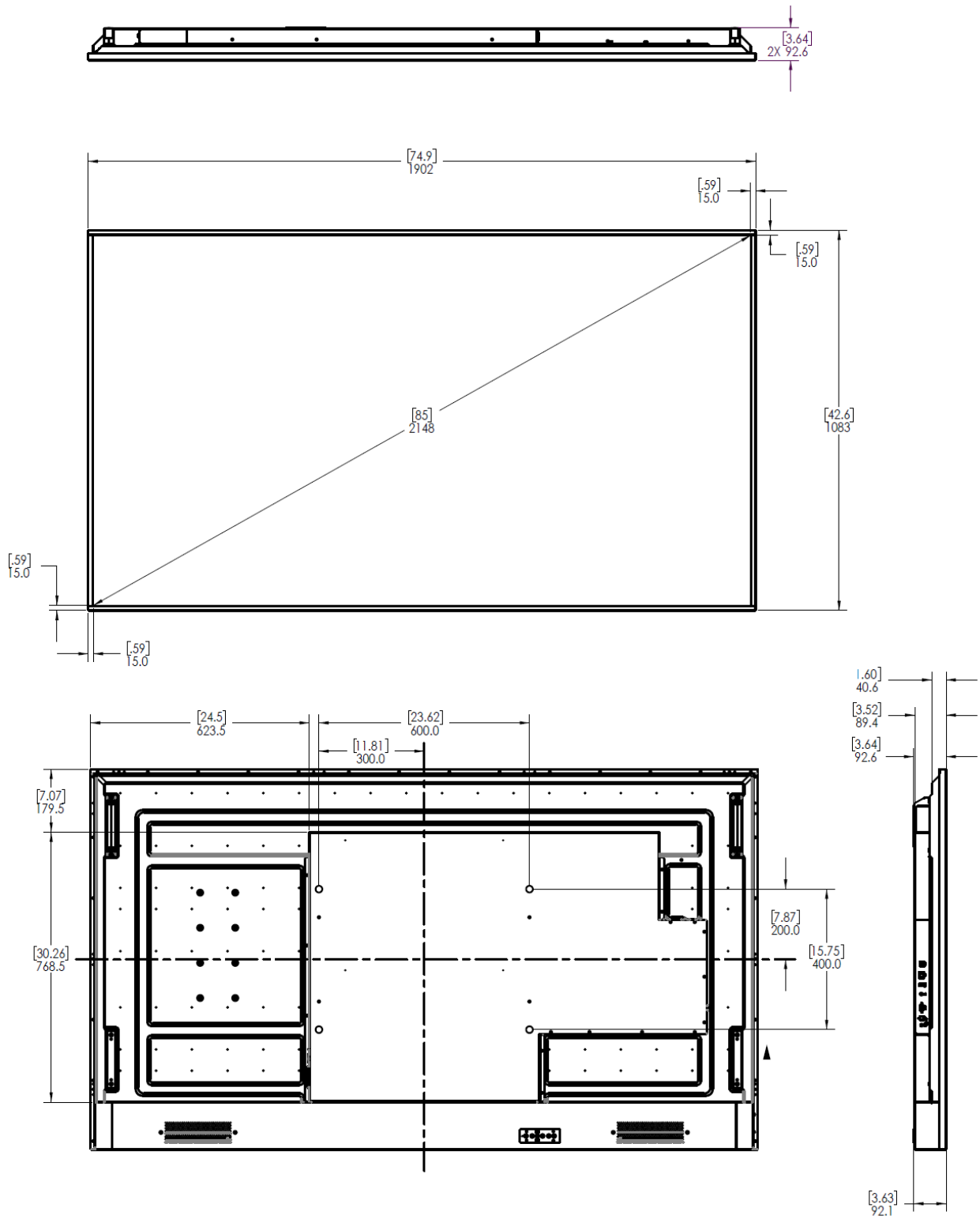

38. URP85-ERO-T

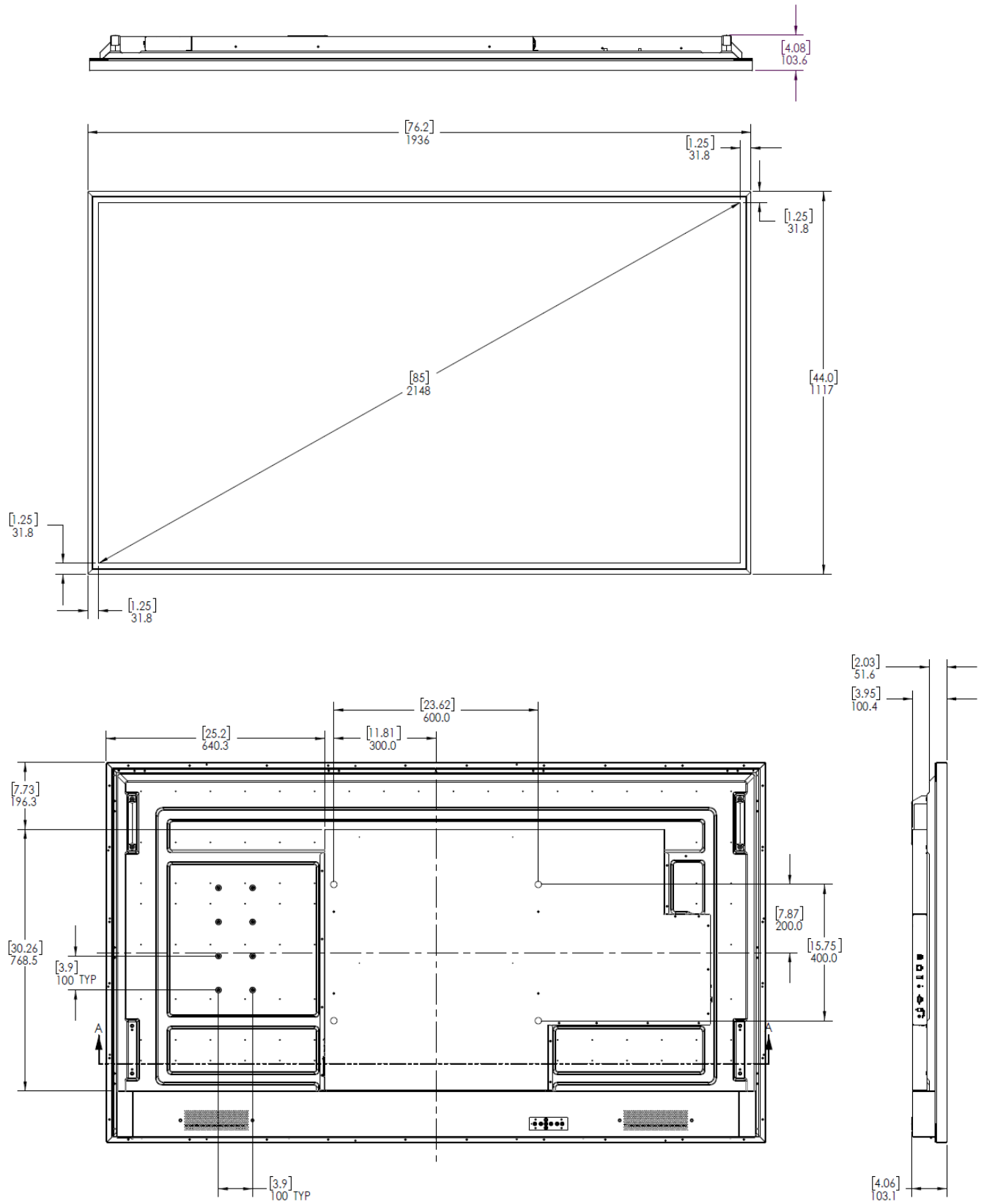

39. URP98

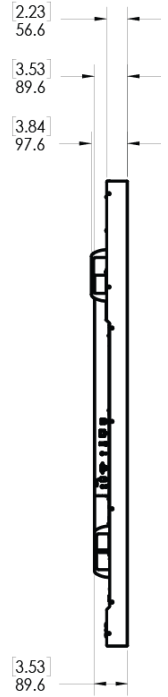
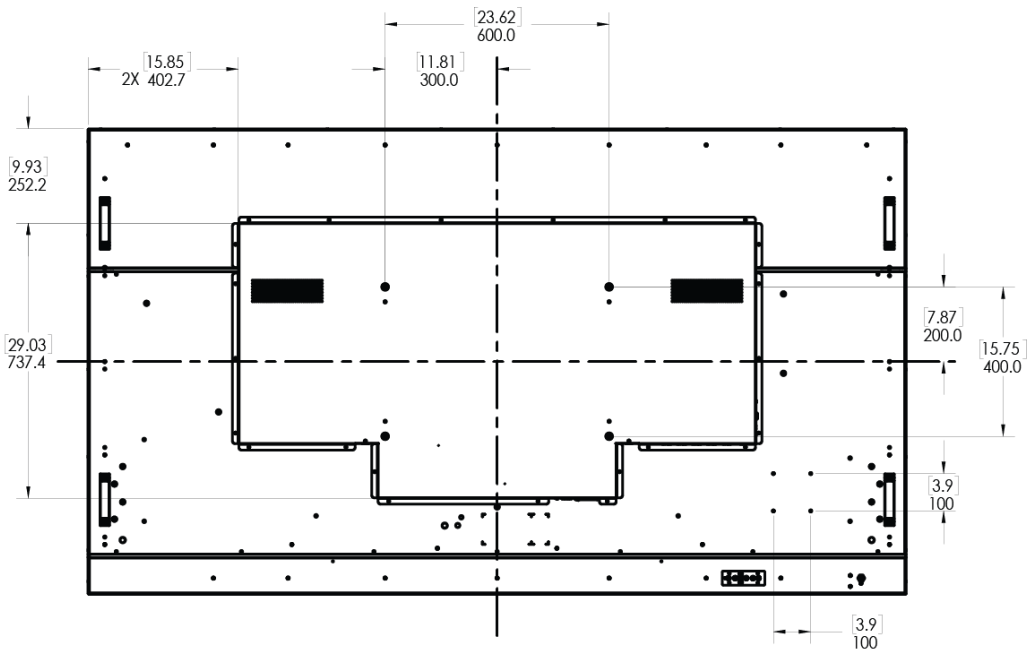
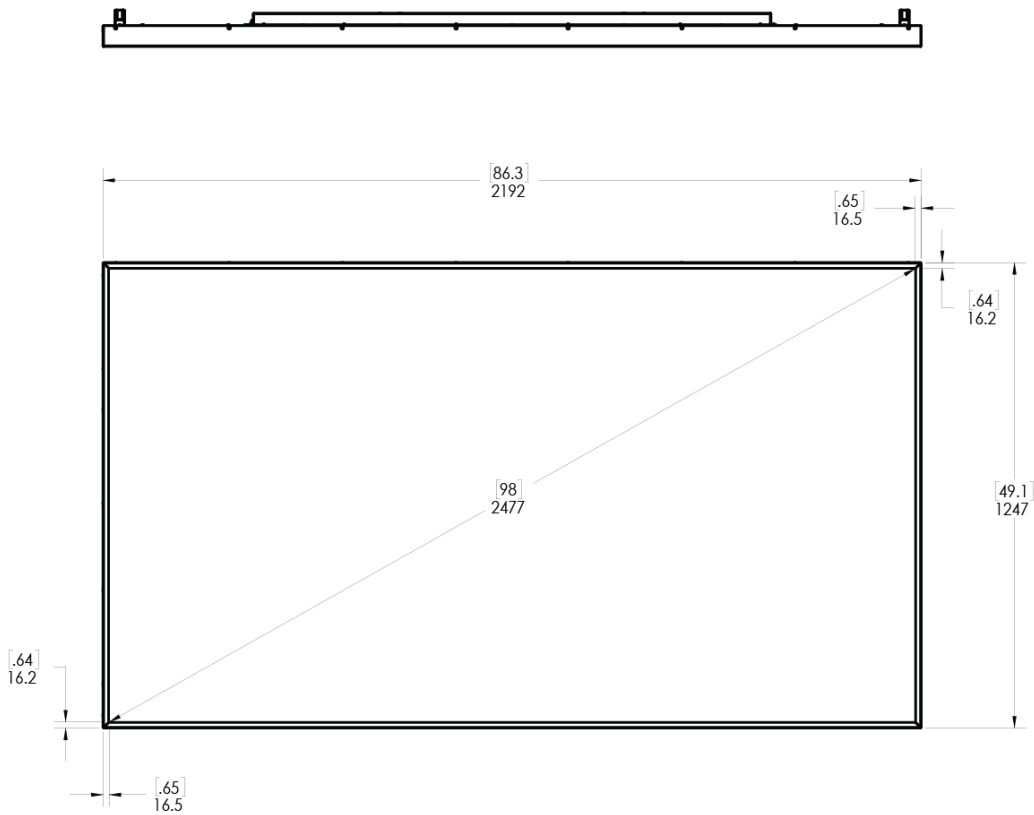

40. URP98-ERO-T

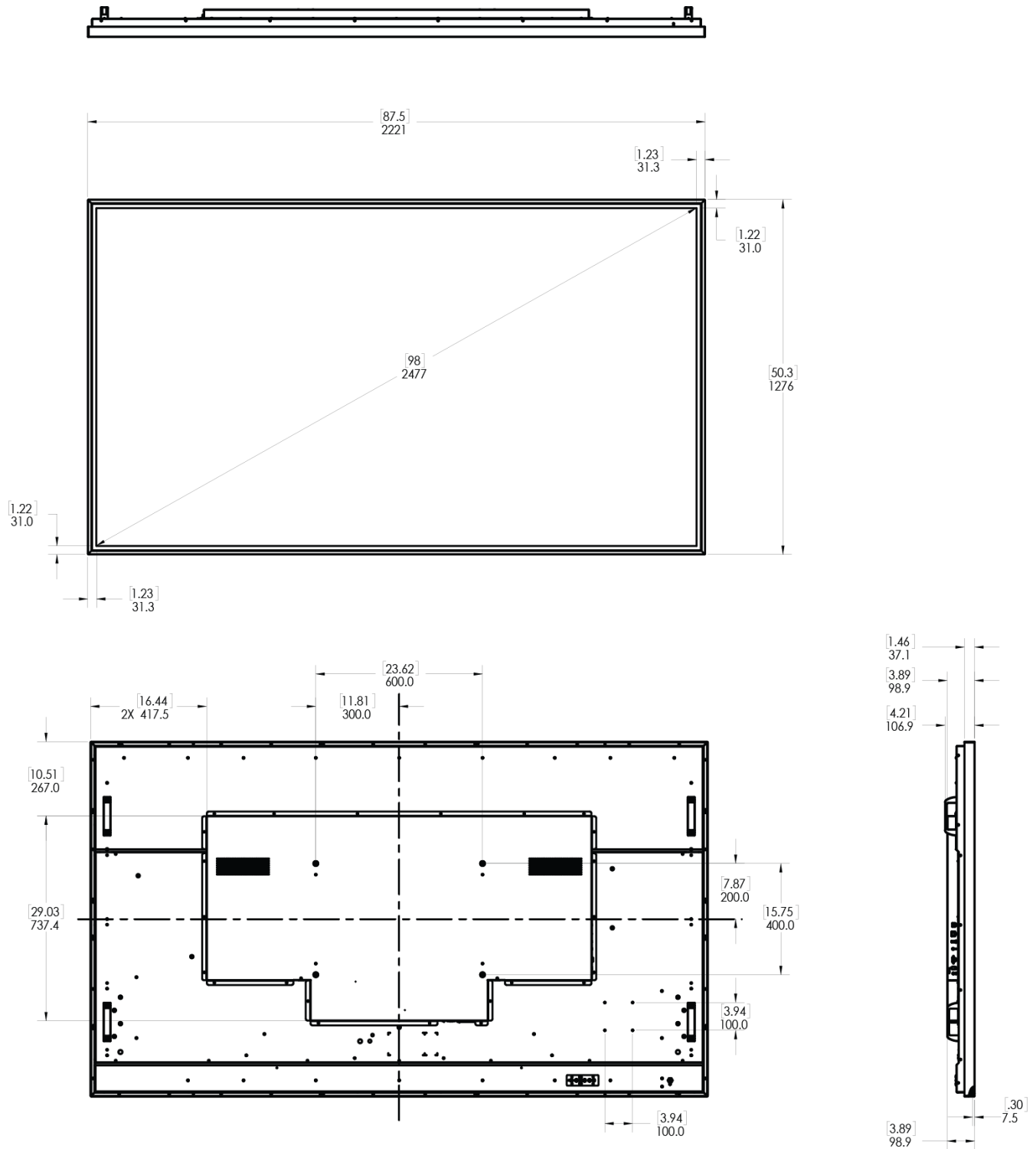

Troubleshooting During Installation

This section includes troubleshooting information about different issues you may encounter during the installation process or after your display has been running for some time. If you are not able to solve your issue in this section, please contact Planar's Technical Support team for assistance.

41. Error Codes (URP75 / URP85 / URP98 only)

To see the last 50 errors that have occurred, select the Error Log tab in the OSD (MAIN MENU > INFORMATION > ERROR LOG), as shown below.

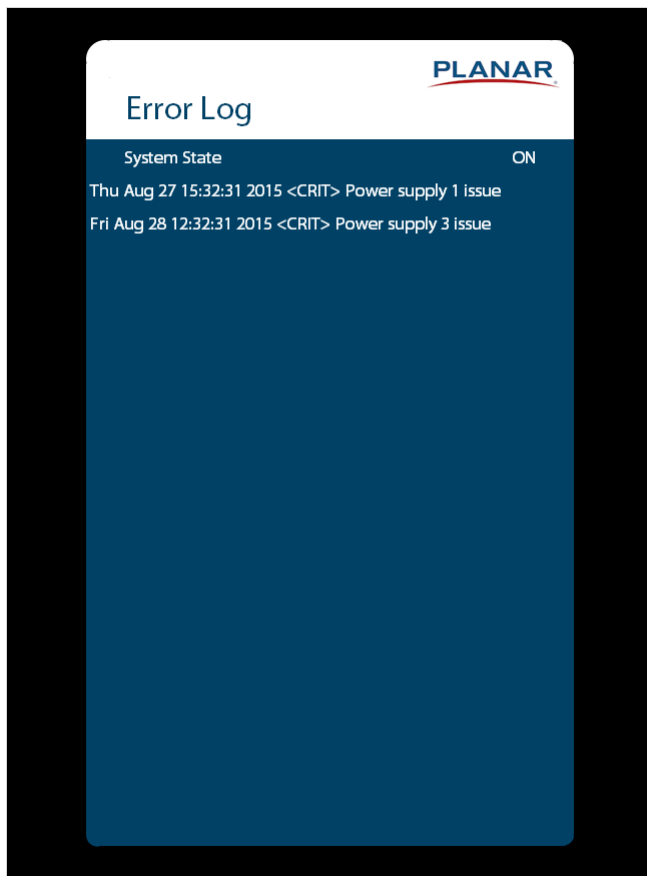

42. Symptoms, Possible Causes and Solutions

Below are different symptoms that you might encounter as you install your Planar UltraRes P Series display. First look at the different symptoms to see if you can find your issue. And then look at the possible cause and try the suggested solution(s). If you still are not able to resolve your issue, please contact Planar's Technical Support Department.

42.1 Symptom: Display Doesn't Respond to External Control System

Solution

Confirm the **Power Down Mode** setting. **Networked standby** or **Fast Startup** are required to enable the use of external control devices. **Standby** disables all external control except IR, allowing the display to be in the lowest power setting. See "Power Down Mode" on page 53.

42.2 Symptom: Can't Get PC to Output 4K @ 24/30/60 Hz

Solution

Confirm that DisplayPort-to-HDMI adapters are not being used. These adapters do not support outputting 4K content.

Solution

Make sure you are using a high-speed HDMI or a Certified Premium HDMI cable. Standard HDMI cables might work but are not guaranteed.

Solution

Verify that the selected **EDID Type** setting in the OSD is **4K60** or **4K30**. If you change the EDID setting, you may need to disconnect and reconnect the cable.

Solution

If you are trying to use 4K @ 60 Hz on HDMI, the display must be connected to HDMI 1 or HDMI 2.

Solution

If you are trying to display 4K @ 60 Hz on HDMI 1 or HDMI 2, the Multi-Source View setting must be Single.

42.3 Symptom: Can't Get PC to Output 4K @ 24/30/60 Hz

Possible Cause

The connector overmold is too large, which can cause the pins not to contact properly on some cards.

Solution

If using DisplayPort, make sure the connector overmold isn't too large.



42.4 Symptom: IR Isn't Working Properly

Possible Cause

The wired IR module may not be fully connected.

Solution

Make sure the IR is fully connected by pressing hard to ensure it is inserted as far as possible.

Possible Cause

The wired IR module cable is not being used.

Solution

Make sure that the wired IR module cable is being used.



42.5 Symptom: Touch Has Broken Response Near Middle/Bottom of Display

Possible Cause

The display is mounted tilted forward.

Solution

Reposition the display so it is vertical to slightly tilted back.

Possible Cause

There are items blocking the IR sensors from emitting or receiving

Solution

Clean display and sensor windows around the display.

Accessing Planar's Technical Support Website

Go to <http://www.planar.com/support/> to access the following support documents and resources:

- User Manual
- RS232 User Manual
- Outline drawings
- Standard warranties
- Planar support hotline number and email
- Firmware (contact Planar support via email or phone)