

Eonis

21-inch clinical display

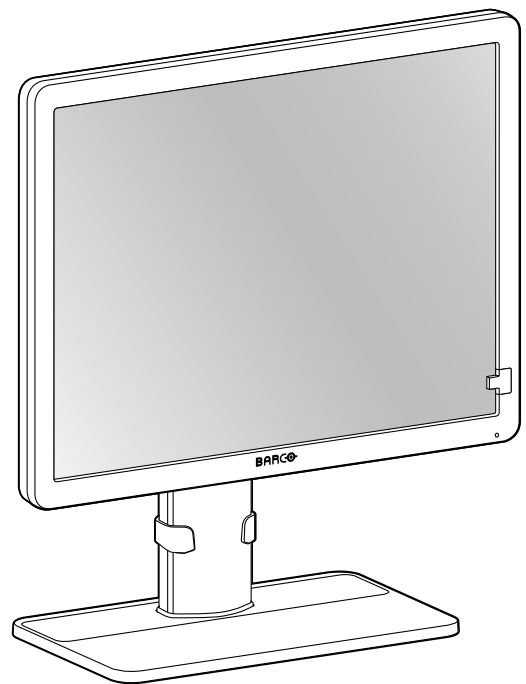

User Guide

MDRC-2421 SNIB

Barco NV

Beneluxpark 21, 8500 Kortrijk, Belgium
www.barco.com/en/support
www.barco.com

Registered office: Barco NV

President Kennedypark 35, 8500 Kortrijk, Belgium
www.barco.com/en/support
www.barco.com

Copyright notice

This document is copyrighted. All rights are reserved. Neither this document, nor any part of it, may be reproduced or copied in any form or by any means - graphical, electronic, or mechanical including photocopying, taping or information storage and retrieval systems - without written permission of Barco.

© 2024 Barco NV all rights reserved.

Disclaimer notice

Although every attempt has been made to achieve technical accuracy in this document, we assume no responsibility for errors that may be found. Our goal is to provide you with the most accurate and usable documentation possible; if you discover errors, please let us know.

Barco software products are the property of Barco. They are distributed under copyright by Barco NV or Barco Inc., for use only under the specific terms of a software license agreement between Barco NV or Barco Inc. and the licensee. No other use, duplication, or disclosure of a Barco software product, in any form, is authorized.

The specifications of Barco products are subject to change without notice.

Trademarks

All trademarks and registered trademarks are property of their respective owners.

DisplayPort™ and the DisplayPort™ logo are trademarks owned by the Video Electronics Standards Association (VESA®) in the United States and other countries.

The terms HDMI™, HDMI High-Definition Multimedia Interface, HDMI Trade dress and the HDMI Logos are trademarks or registered trademarks of HDMI Licensing Administrator, Inc.

Patent protection

Please refer to www.barco.com/about-barco/legal/patents.

Product Security Incident Response

As a global technology leader, Barco is committed to deliver secure solutions and services to our customers, while protecting Barco's intellectual property.

When product security concerns are received, the product security incident response process will be triggered immediately. To address specific security concerns or to report security issues with Barco products, please inform us via contact details mentioned on <https://www.barco.com/psirt>.

To protect our customers, Barco does not publicly disclose or confirm security vulnerabilities until Barco has conducted an analysis of the product and issued fixes and/or mitigations.

Table of contents

1	Welcome!	7
1.1	What's in the box	8
1.2	Product overview	8
2	Installation	11
2.1	Stand base plate mounting	12
2.2	Cable connections	12
2.3	Display position adjustment	13
2.4	VESA-mount installation	14
3	Operation	17
3.1	Recommendations for daily operation	18
3.2	On/Off switching	18
3.3	OSD menu use	18
3.4	Power LED	19
3.5	Jog dial locking/unlocking	19
3.6	Input source selection	19
3.7	Luminance adjustment	20
3.8	sRGB color space	20
3.9	QAWeb presets	20
3.10	Display functions	20
3.11	White point selection	21
3.12	Analog video settings	22
3.13	OSD menu language	22
3.14	Power save mode	22
3.15	OSD menu orientation	22
3.16	Factory reset	23
3.17	Information menu	23
4	Maintenance	25
4.1	Scheduled maintenance	26
4.2	Cleaning instructions	26
5	Important information	29
5.1	Safety information	30
5.2	Cybersecurity	33
5.3	Environmental information	34

5.4	Biological hazard and returns – Decommissioning	36
5.5	Regulatory information.....	36
5.6	EMC notice	37
5.7	Explanation of symbols.....	40
5.8	Technical specifications.....	43

Welcome!

1

Warnings, cautions, notes and tips

There are four levels of precautionary or advisory statements that may be used in this user guide. In descending order of importance, they are:



WARNING: Describes hazards or dangers that might result in personal injury or death.



CAUTION: Describes hazards that could damage the product.



Gives additional information about the described subject.



Gives extra advice about the described subject.

1.1 What's in the box

Overview

- 1x MDRC-2421 display
- 1x Stand base plate
- 1x DisplayPort video cable
- 1x USB cable
- 1x Printed user guide (in English, other languages can be found on the documentation disc)
- 1x Documentation disc
- 1x System sheet
- Mains cables



The user guides are also available on www.barco.com/support



Keep your original packaging. It is designed for this display and is the ideal protection during transport and storage.



If your product arrived with shipping damage or missing parts, please refer to the instructions in our knowledge base article '3727' at www.barco.com/support/knowledge-base/3727 for further assistance.

1.2 Product overview

Front

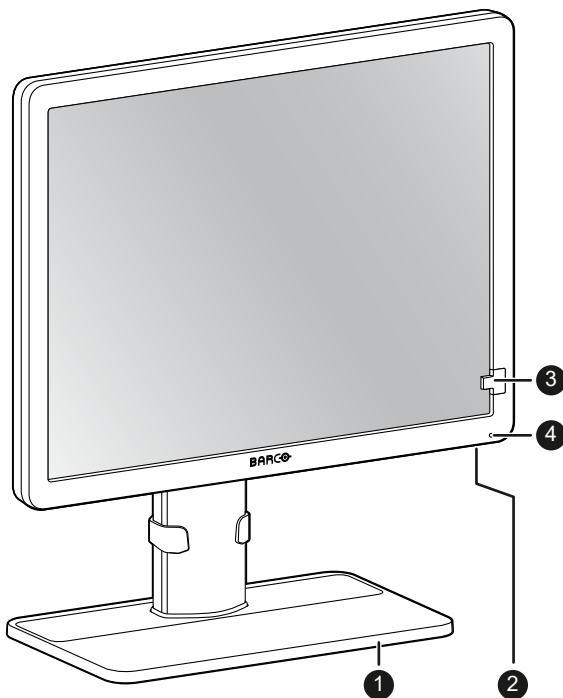

Image 1-1

1. Display stand
2. Jog dial
 - Press and hold for 5 seconds
 - to switch off the display
 - Press
 - to exit standby mode

- to activate the OSD menu
 - to confirm selections in the OSD menu
 - Turn left
 - to scroll down in the OSD menu
 - to decrease values in the OSD menu
 - Turn right
 - to scroll up in the OSD menu
 - to increase values in the OSD menu
3. Front sensor
4. Power status LED
- Off: Display not powered, or display is on but power LED function is disabled in OSD (“Power LED”, [page 19](#))
 - Steady green: Display operational
 - Blinking green: Display is entering standby mode
 - Steady orange: Display in standby mode/soft-off state

Back

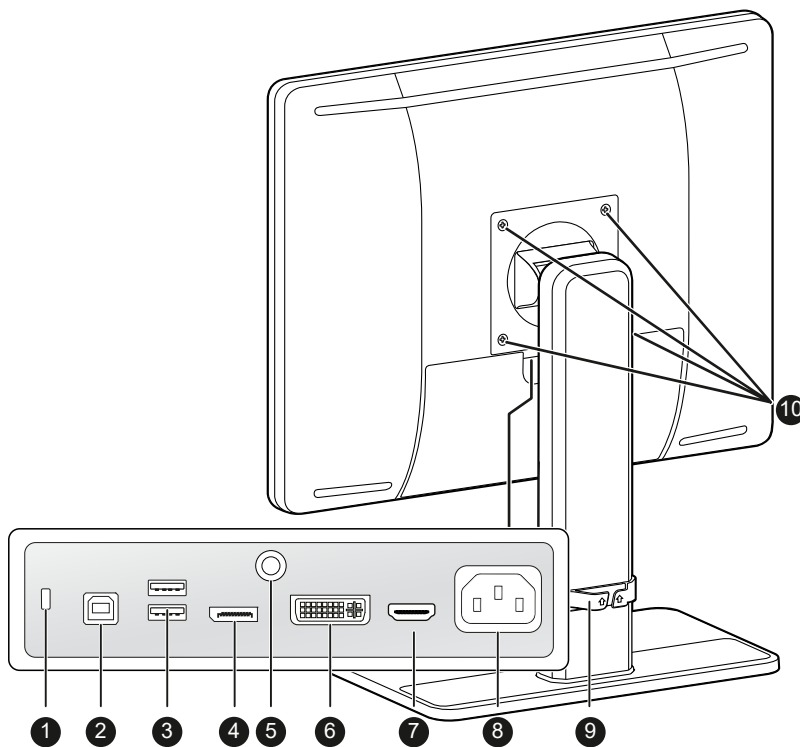

Image 1-2

1. Kensington security slot
2. USB-B 2.0 upstream connector
3. USB-A 2.0 downstream connectors (2x)
4. DisplayPort video input
5. Protective earth pin
6. DVI-I video input
7. HDMI video input
8. 100 - 240 VAC mains power input (IEC C14)
9. Height-adjustable cable routing clip
10. VESA 100 mm mounting screws (4x)



Welcome!

Installation

2



WARNING: Read all the important safety information before installing and operating your display. Please refer to the dedicated chapter in this user guide.



WARNING: Sufficient expertise is required to install this equipment. All devices and complete setup must be tested before taking into operation.



CAUTION: When the display is assembled in the medical system, take care of the fixation of all cables, to avoid unwanted detachment.



CAUTION: The monitor is not intended to be sterilized.

2.1 Stand base plate mounting

To mount the stand base plate

1. Put the display face down on a clean and soft surface. Be careful not to damage the panel.
2. Attach the stand base plate to the pillar by fixing the dedicated screw as shown below.

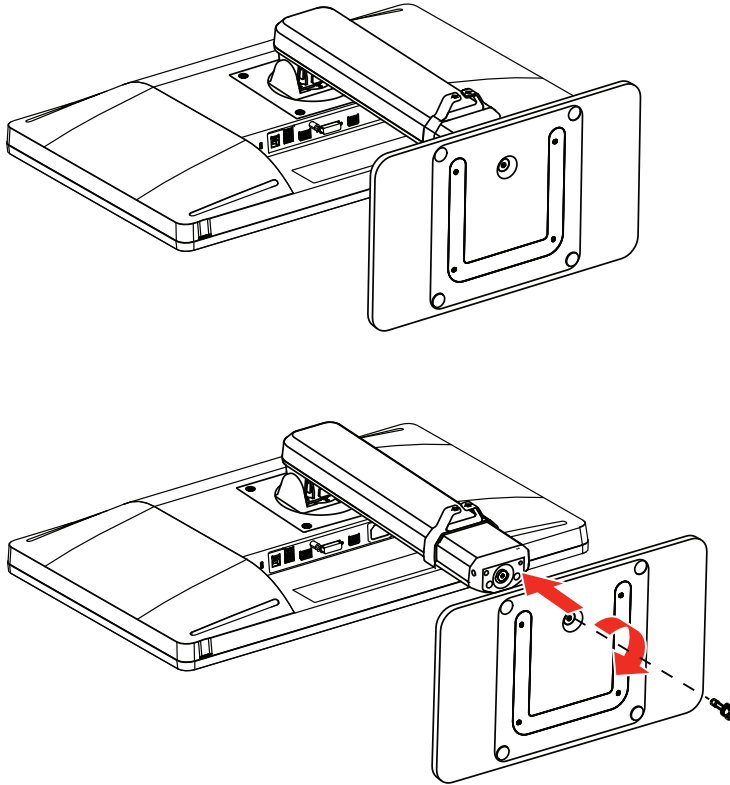

Image 2-1

2.2 Cable connections

To connect the cables

1. Connect one or more video source(s) to the corresponding video inputs. Use the appropriate video cable (s) to do this.

The input source to be displayed can be selected in the OSD menus (see [“Input source selection”](#), page 19).

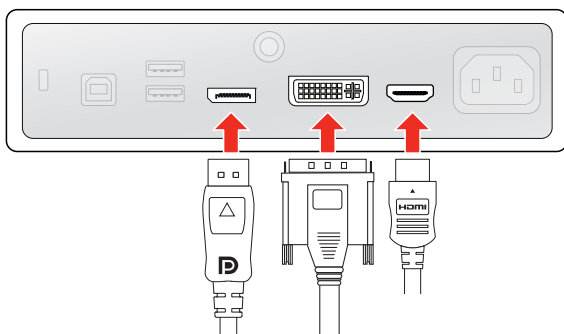

Image 2-2

2. Connect the USB upstream connector to a PC USB host to make use of QAWeb or any of the display USB downstream connectors (e.g. to connect a keyboard, mouse or other peripheral).

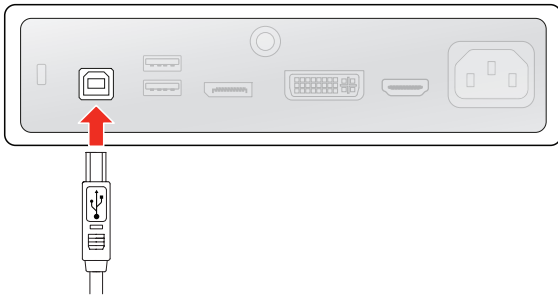

Image 2-3

3. Connect the mains power input to a **grounded** power outlet.

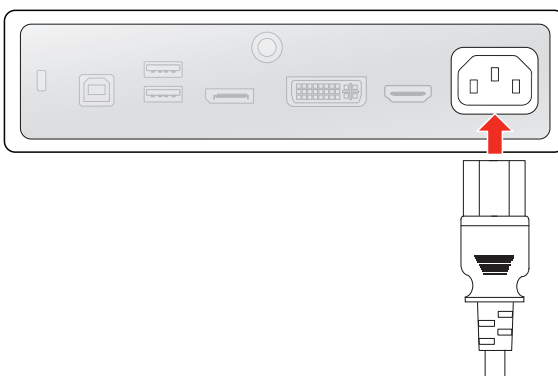

Image 2-4

4. If necessary for your application, earth the MDRC-2421 by connecting the earth pin to a grounded outlet by means of a yellow/green AWG18 wire (maximum admitted cable length according to national regulation requirements).

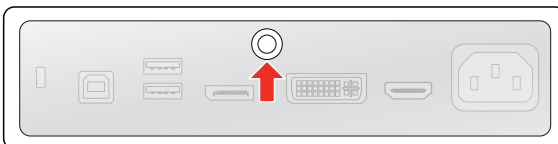

Image 2-5

5. Route all cables through the provided cable routing clip at the back of the display stand.

2.3 Display position adjustment

To adjust the display position

You can safely tilt, pivot, raise and lower the display as desired.

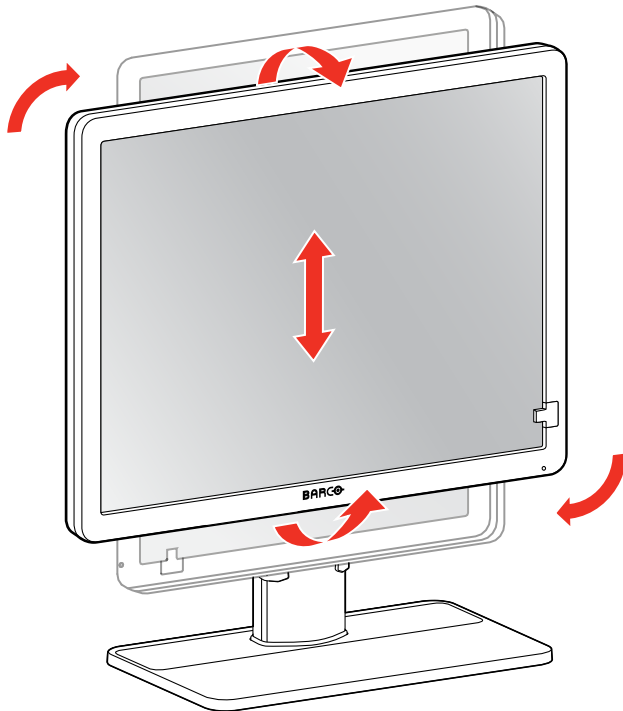

Image 2-6



WARNING: The display must be in its highest position before it can be properly pivoted.



The standard orientation of the video input is landscape. If you use the display in portrait mode, make sure you change the orientation of the video input via the screen settings of the computer.

2.4 VESA-mount installation



CAUTION: Use suitable mounting apparatus to avoid risk of injury.



WARNING: Never move a display attached to an arm by pulling or pushing the display itself. Instead, make sure that the arm is equipped with a VESA compliant handle and use this to move the display.

Please refer to the instruction manual of the arm for more information and instructions.



WARNING: Use a mount that is compliant with the VESA 100 mm standard.

Use a mount that can support the weight of the display. Refer to the technical specifications of this display for the applicable weight.

To mount the display on a VESA arm

The display panel, standard attached to the stand, is compatible with the VESA 100 mm standard.

1. Unscrew the four fixation screws to detach the panel from the stand.

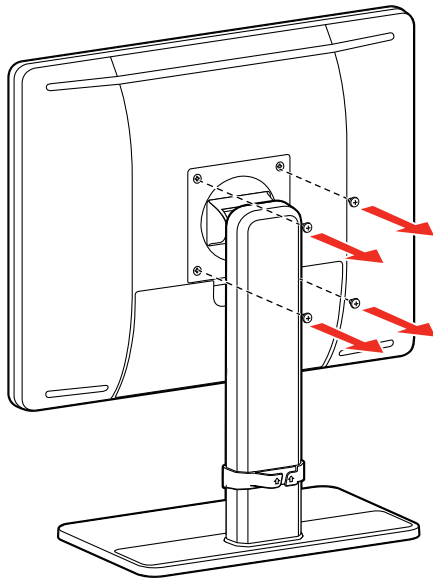

Image 2-7

2. Use 4 M4 screws to attach the panel to a VESA approved arm. Please respect the following rule to select an appropriate screw length:
- $L_{\min} = T + W + 8 \text{ mm}$
 - $L_{\max} = T + W + 14 \text{ mm}$

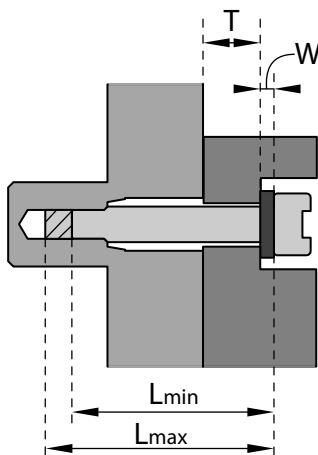

Image 2-8

3

Operation

3.1 Recommendations for daily operation

Optimize the lifetime of your display

Enabling the Display Power Management System (DPMS) of your display will optimize its diagnostic lifetime by automatically switching off the backlight when the display is not used for a specified period of time. By default, DPMS is enabled on your display, but it also needs to be activated on your workstation. To do this, go to the “Power Options” of your workstation.



Barco recommends setting DPMS activation after 20 minutes of non-usage.

Use a screen saver to avoid image retention

Prolonged operation of an LCD with the same content on the same screen area may result in a form of image retention.

You can avoid or significantly reduce the occurrence of this phenomenon by using a screen saver. You can activate a screen saver in the “Display properties” window of your workstation.



Barco recommends setting screen saver activation after 5 minutes of non-usage. A good screen saver displays moving content.

In case you are working with the same image or an application with static image elements for several hours continuously (so that the screen saver is not activated), change the image content regularly to avoid image retention of the static elements.

Understand pixel technology

LCD displays use technology based on pixels. As a normal tolerance in the manufacturing of the LCD, a limited number of these pixels may remain either dark or permanently lit, without affecting the diagnostic performance of the product. To ensure optimal product quality, Barco applies strict selection criteria for its LCD panels.

Maximize quality assurance

QAWeb Enterprise supports optimum and stabilized image quality in every private practice.

The MDRC-2421 works seamless with QAWeb Enterprise to ensure a consistent image over time. It automatically stabilizes the image from the moment you switch on the display. What's more, QAWeb Enterprise provides you with instant feedback on the status of the display.

3.2 On/Off switching

About

- Press and hold the jog dial for 5 seconds to switch off your display while no OSD menu is on the screen.
- Press the jog dial for 1 second to switch on your display.

3.3 OSD menu use

To open the OSD menu

Press the jog dial during normal operation to open the OSD menu. If the jog dial is locked, first unlock it as described in “[Jog dial locking/unlocking](#)”, page 19.

The OSD main menu comes up in the left top of the screen. If no further actions are taken within the following 20 seconds, the OSD menu will disappear again (and the keyboard will lock if enabled).

To navigate the OSD menu

- Turn the jog dial left/right to scroll through the different menu pages, to change values or to make selections.
- Press the jog dial to go into a submenu or confirm adjustments and selections.

3.4 Power LED

Overview

The power status of the display is indicated by a LED at the front of the display. Below is an overview of the different LED color modes:

- Off: Not powered
- Steady green*: Operational (when a valid input source selected)
- Blinking green*: Entering standby mode
- Steady orange: In standby mode/soft-off state

* This default behavior can be changed so that the power status LED is also off when the display is operational or when entering standby mode.

To change the behavior of the power status LED

1. Bring up the OSD main menu.
2. Navigate to the *Settings* menu.
3. Enter the *Power LED* submenu.
4. Select *On* or *Off* as desired and confirm.

3.5 Jog dial locking/unlocking

About

To avoid unwanted or accidental activation of the jog dial, a lock mechanism can be enabled. This mechanism will lock the keyboard automatically, except while using the OSD menus.

To lock/unlock the jog dial

1. Bring up the OSD main menu.
2. Navigate to the *Settings* menu.
3. Enter the *OSD lock* submenu.
4. Select *On* or *Off* as desired and confirm.

To unlock the jog dial

During normal operation, turn and hold the jog dial **right for 5 seconds**, until the *OSD unlocked* message appears.

3.6 Input source selection

About input source selection

The MDRC-2421 can have multiple video inputs connected. Switching between the different inputs can be done easily in the OSD menu.

To select the input source

1. Bring up the OSD main menu.
2. Navigate to the *Input selection* menu.

3. Select one of the available input sources and confirm.

3.7 Luminance adjustment

To adjust the luminance

1. Bring up the OSD main menu.
2. Navigate to the *Adjustments* > *Luminance* menu.
3. Set a luminance value as desired and confirm.

3.8 sRGB color space

About sRGB color space

The sRGB color space combines a display function and white point selection and is designed to match typical home and office viewing conditions. It is widely used in most computer applications.



When selecting *sRGB*, the *Display function* and *White point* selection options in the *Adjustments* menu will be disabled.

To select sRGB color space

1. Bring up the OSD main menu.
2. Navigate to the *Adjustments* menu.
3. Select *sRGB* and confirm.

3.9 QAWeb presets

About QAWeb presets

Display function, white point selection and ambient light conditions for your display can be applied from within the QAWeb application.



When selecting *QAWeb*, the *Display function* and *White point* selection options in the *Adjustments* menu will be disabled.

To select QAWeb presets

1. Bring up the OSD main menu.
2. Navigate to the *Adjustments* menu.
3. Select *QAWeb* and confirm.



The display USB upstream port must be connected to a PC with QAWeb installed on it before the QAWeb presets can be applied.

3.10 Display functions



Display function selection is disabled when *sRGB* or *QAWeb* are selected in the *Adjustments* menu.

About display functions

Native, uncorrected panels will display all grayscale/color levels with luminance increments that are not optimal for crucial diagnostic information. Studies have shown however, that in medical images certain grayscale/color parts contain more diagnostic information than others. To respond to these conclusions, display functions have been defined. These functions emphasize on these parts containing crucial diagnostic information by correcting the native panel behavior.

The available display functions for your MDRC-2421 are:

- *Native*: If you select Native, the native panel behavior will not be corrected.
- *Gamma 1.8* or *2.2*: Select one of these display functions in case the display is to replace a CRT display with a gamma of 1.8 or 2.2 respectively.
- *DICOM*: DICOM (Digital Imaging and Communications in Medicine) is an international standard that was developed to improve the quality and communication of digital images in radiology. In short, the DICOM display function results in more visible grayscales in the images. Barco recommends selecting the DICOM display function for most medical viewing applications.

The DICOM display function applies ambient light compensation (ALC) taking the ambient light conditions of your reading room into account. The available reading room options are:

- *Darkroom*: Selects DICOM calibrated function, optimized for darkroom conditions (0-50 Lux)
- *Office*: Selects DICOM function optimized for office conditions (51-250 Lux)
- *Operation Room*: Selects DICOM function optimized for operating room conditions (251-500 Lux)



The settings of the display must be adapted to suit the requirements of the visualization software. In case of doubt, please contact the vendor of the visualization software.

To select a display function

1. Bring up the OSD main menu.
2. Navigate to the *Adjustments > Display function* menu.
3. Select one of the available display functions and confirm.

3.11 White point selection



White point selection is disabled when *sRGB* or *QAWeb* are selected in the *Adjustments* menu.

About white point selection

This setting allows you to modify the display white point, used as reference for all other colors to be displayed.

The available white point settings for your display are:

- *Native*: The native, unmodified color temperature of the LCD panel.
- *Bluebase*: Simulation of the bluebase film color temperature.
- *Clearbase*: Simulation of the clearbase film color temperature.
- *Programmable*: When selecting this setting, you will be able to manually adjust the video gain for the red, green and blue channel in separate submenus.

To select the white point

1. Bring up the OSD main menu.
2. Navigate to the *Adjustments > White point* menu.
3. Select one of the available white point presets.

3.12 Analog video settings



The following settings are only available when a valid analog video input source (DVI-A) is selected.

About analog video settings

When the analog video input source is active, a number of analog video settings becomes available:

- *Auto Adjust*: The analog video setting will automatically be adjusted
- *Geometry*: Allows to manually adjust the geometry settings of the analog video (clock frequency, clock phase, horizontal position, vertical position)
- *Level*: Allows to manually adjust the contrast and brightness levels of the analog video

To adjust the analog video settings

1. Bring up the OSD main menu.
2. Navigate to the *Adjustments > Analog* menu.
3. Adjust one of the available analog video settings as desired.

3.13 OSD menu language

About the OSD menu language

By default, the OSD menu comes up in English. However, there's a wide range of other languages available for the OSD menu of your MDRC-2421.

To select the language of the OSD menu

1. Bring up the OSD main menu.
2. Navigate to the *Settings* menu.
3. Enter the *OSD Language* submenu.
4. Select one of the available languages.

3.14 Power save mode

About power save mode

Enabling power save mode on your MDRC-2421 will optimize the display lifetime by automatically switching off the backlight when no video signal is detected after approximately 13 seconds.

To enable/disable power save mode

1. Bring up the OSD main menu.
2. Navigate to the *Settings* menu.
3. Enter the *Power Save* submenu.
4. Select *On* or *Off* as desired and confirm.

3.15 OSD menu orientation

About the OSD menu orientation

The orientation of the OSD menu can be changed depending on the orientation of your display (landscape or portrait).

To change the orientation of the OSD menu

1. Bring up the OSD main menu.
2. Navigate to the *Settings* menu.
3. Enter the *OSD orientation* submenu.
4. Select *Landscape* or *Portrait* as desired and confirm.

3.16 Factory reset

About factory reset

A factory reset allows you to fully restore the display to its original factory setting.

To perform a factory reset

1. Bring up the OSD main menu.
2. Navigate to the *Settings* menu.
3. Enter the *Factory Reset* submenu.
4. Press the jog dial to confirm your selection.

3.17 Information menu

Information display

The available information items for your display are:

- Display name
- FW version
- Serial number
- System hours
- Backlight runtime

To access the information menu

1. Bring up the OSD main menu.
2. Navigate to the *Information* menu.

Maintenance

4

4.1 Scheduled maintenance

About

The MDRC-2421 does not require any scheduled maintenance or calibration activities. We recommend to use QAWeb with the Barco default tests and frequencies to calibrate and maintain the display, or to return the display to a Barco approved maintenance organization. In any case of doubts, please contact Barco Healthcare.

4.2 Cleaning instructions

To clean the display

Apply a cleaning/disinfecting product to a soft lint-free cloth, such as a microfiber or gauze and rub the display surface thoroughly. In order to be effective, all surfaces must be cleaned for a certain amount of time (ranging from 30 seconds to 2 minutes).

Use a cleaning/disinfecting product that is alcohol-, alkali-, water- or chlorine-based. Common examples are:

- Isopropanol 100%
- Ethanol 70%
- 0.5% Chlorhexidine in 70% ethanol/isopropanol
- Ortho-Phthalaldehyde (OPA) 0.55%
- Haemo-sol, 1% in water
- 250 ppm Chlorine solution
- 1.0% Iodine in 70% ethanol
- 1.6% aqueous ammonia
- "Green soap" (USP)
- 0.5% Chlorhexidine in 70% isopropyl alcohol
- Products similar to optical cleaning liquid
- Bacillo AF
- Flux
- Sodium hypochlorite 10%

When selecting an alternative cleaning/disinfecting product, it is recommended to always identify the active ingredients. In case of doubt about a certain cleaning product, use plain water.

Do not use any of the following products:

- Alcohol in concentrations > 70%
- Strong alkalis lye, strong solvents
- Acetone
- Toluene
- Acids
- Detergents containing fluoride
- Detergents containing ammonia
- Detergents containing abrasives
- Steel wool
- Sponge with abrasives
- Steel blades
- Cloths with steel thread
- Paper-based cloths (e.g. paper towels, facial tissues, toilet paper)



CAUTION: Read and follow all instructions on the label of the cleaning product.



CAUTION: Take care not to damage or scratch the front glass or LCD. Be careful with rings or other jewelry and do not apply excessive pressure on the front glass or LCD.



CAUTION: When a small object or dust is tucked between the front bezel and the LCD surface (for displays without front glass), carefully remove with a soft object such as a plastic card or finger nail. Do not use sharp objects such as paperclips or tweezers to avoid damage to the LCD.



CAUTION: Do not apply or spray liquid directly to the display as excess liquid may cause damage to internal electronics. Instead, apply the liquid to a cleaning cloth.

**Important
information**

5

5.1 Safety information

General recommendations

Read the safety and operating instructions before operating the device.

Retain safety and operating instructions for future reference.

Adhere to all warnings on the device and in the operating instructions manual.

Follow all instructions for operation and use.

Electrical shock or fire hazard

To prevent electric shock or fire hazard, do not remove cover.

No serviceable parts inside. Refer servicing to qualified personnel.

Do not expose this apparatus to rain or moisture.

Modifications to the unit

Do not modify this equipment without authorization of the manufacturer.

Preventive maintenance

With the monitor disconnected from mains perform the following periodical check:

- Check the integrity of the power cord and inspect its routing, so that it is not under the risk of being punched or cut.
- Check the integrity of the protective earth connection.
- Clean the area around the power plug, dust and liquids may result in fire.
- Clean the ventilation slot of the monitor, dust can obstruct the air flow and cause temperature increase of the electronics.

General recommendations:

- Keep the monitor clean to prolong its operational lifetime.
- LCD panel performances may deteriorate in the long-term. Periodically check that it is correctly operating.
- Periodically check the tightness of the VESA mount screws. If not sufficiently tight, the monitor may detach from the arm, which may result in injury or equipment damage.

Type of protection (electrical):

Monitor with internal power supply: Class I equipment.

Degree of safety (flammable anesthetic mixture)

Equipment not suitable for use in the presence of a flammable anesthetic mixture with air or with oxygen or nitrous oxide.

The equipment shall not be operable when the air oxygen content is above 25%.

Non-patient care equipment

Equipment primarily for use in a health care facility that is intended for use where contact with a patient is unlikely (no applied part).

The equipment shall not be used with life support equipment.

The user should not touch the equipment, nor its signal input ports (SIP)/signal output ports (SOP) and the patient at the same time.

Child safety

Equipment not suitable for use in locations where children are likely to be present.

Mission critical applications

We strongly recommend there is a replacement monitor immediately available in mission critical applications.

Use of electrical surgical knives

Provide as much distance as possible between the electrosurgical generator and other electronic equipment (such as monitors). An activated electrosurgical generator may cause interference with them and can disrupt the functionality of the display.

Power connection – Equipment with internal power supply

- This equipment must be earthed.
- Power requirements: The equipment must be powered by the AC mains voltage.
- The equipment is intended for continuous operation.

Transient over-voltage

To fully disengage the power to the device, please disconnect the power cord from the AC inlet.

High magnetic environment

- The device shall not be used in the high magnetic environment of an MRI scanner.
- The installer shall assess the magnetic environment before installation or use of the device.

Connections

Any external connection with other peripherals must follow the requirements of clause 16 of IEC60601-1 3rd. Ed. or Table BBB.201 of IEC 60601-1-1 for the medical electrical systems.

To maintain compliance with EMC Regulation, use only well shielded interface cables for the connection to peripheral devices.

Power cords

Europe: H05VV-F or H05VVH2-F PVC cord with appropriate EU plug.

US and Canada: “hospital grade” cord-set has to be used, provided with instructions to indicate that grounding reliability can be achieved only when the equipment is connected to an equivalent receptacle marked hospital only or hospital grade. These instructions need to be marked either on the equip. or on a tag on the power cord.

Do not overload wall outlets and extension cords as this may result in fire or electric shock.

Mains lead protection: Power cords should be routed so that they are not likely to be walked upon or pinched by items placed upon or against them, paying particular attention to cords at plugs and receptacles.

The power supply cord should be replaced by the designated operator only at all time.

Use a power cord that matches the voltage of the power outlet, which has been approved and complies with the safety standard of your particular country.

Korea: Use KC certified products; Plug: 250 V~, 16 A; Power cord: 60227 IEC 53, 3G0.75 mm² / 60227 IEC 53, 3G1.0 mm²; Connector: 250 V~, 10 A.

Grounding reliability

Grounding reliability can only be achieved when the equipment is connected to an equivalent receptacle.

Liquids and moisture

- Never expose the monitor to liquids or moisture.
- Never use the monitor near water - e.g. near a bathtub, washbasin, swimming pool, kitchen sink, laundry tub or in a wet basement.
- All models are IP20 compliant.

Moisture condensation

Do not use monitor under rapid temperature and humidity change condition or avoid cold air from air-conditioning outlet directly.

Moisture may condense on the surface or inside of the unit, or create a mist residue inside the protection plate, this is not a malfunction of the product itself, although it may cause damage to the monitor.

If condensation happens, let the monitor stand unplugged until there is no condensation.

Ventilation

Do not cover or block any ventilation openings in the cover of the set. When installing the device in a cupboard or another enclosed location, heed the necessary space between the set and the sides of the cupboard.

Installation

- Place the device on a flat, solid and stable surface that can support the weight of at least 3 devices. If you use an unstable cart or stand, the device may fall, causing serious injury to a child or adult, and serious damage to the device.
- The display has been designed to be used in landscape and portrait position with a tilt of -5° to 22° .
- When the equipment is attached to an arm, do not use the equipment as a handle or grip in order to move the equipment. Please refer to the instruction manual of the arm for instructions on how to move the arm with the equipment.
- All devices and complete setup must be tested and validated before taking into operation.
- At end user application level it is necessary to foresee a backup unit in case the video falls away.

Malfunctions

Disconnect the equipment's power cord from the AC inlet and refer servicing to qualified service technicians under the following conditions:

- If the power cord or plug is damaged or frayed.
- If liquid has been spilled into the equipment.
- If the equipment has been exposed to rain or water.
- If the equipment does not operate normally when the operating instructions are followed. Adjust only those controls that are covered by the operating instructions since improper adjustment of other controls may result in damage and will often require extensive work by a qualified technician to restore the product to normal operation.
- If the equipment has been dropped or the cabinet has been damaged.
- If the product exhibits a distinct change in performance, indicating a need for service.

General warnings

The device has no means to be incorporated in an IT-network in the clinical environment.

The enclosure has to be checked upon collision damage, refer to qualified service personnel.

The protective screen (if present) is made of tested high-resistance glass. Nonetheless there is the possibility that it may crack if subject to strong impacts. Evaluate and prevent the risk of possible breakages of the protective screen by correctly handling and positioning the monitor in the operating room.

The monitor is intended for indoor use.

The monitor is not intended to be sterilized.

The monitor has not applied parts, but the front side of the LCD panel and the plastic enclosure have been treated as applied part because considered accidentally touchable by the patient for a time <1 minute.

National Scandinavian Deviations for CL. 1.7.2

Finland: "Laite on liitettävä suojavaadoituskaskettimilla varustettuun pistorasiaan"

Norway: "Apparatet må tilkoples jordet stikkontakt"

Sweden: "Apparaten skall anslutas till jordat uttag"

5.2 Cybersecurity

Security objectives

The MDRC-2421 will be used for displaying and viewing digital images. Therefore, ensuring the availability of the digital images has been identified as the primary security objective of this product.

Nevertheless, the availability, integrity, and confidentiality of information processed by the product relies on the non-mandatory security recommendations described below.

The lack of storage or processing of patient or personal information, combined with the limited (network) connectivity, results in the MDRC-2421 entailing a low cybersecurity risk profile.

Security recommendations

The security measures listed below should be considered as a non-exhaustive list of possible security controls for the operating environment. The operating environment must not hinder the application of security measures on the product or force the device to operate in a lower security setting.

The operator shall maintain the necessary state-of-the-art policies, processes, standards and other security controls to incorporate, support and protect the product. This shall include the application of risk management (e.g. by implementing relevant standards).

The operating environment should provide physical security via security measures such as:

- Regulated and authenticated physical access enforced via suitable technical measures (e.g. badges)
- Physical security policy defining roles and access rights, including for physical access to the product
- Use of segregated, secure areas with appropriate access controls

The operating environment should include appropriate security controls such as:

- User access management (credentials for accessing software applications or devices, user access policy, etc.)
- Antivirus / anti-malware software
- Firewall
- Application whitelisting / system hardening
- Exclusive use of genuine software and ban of all illegitimate software and applications
- Session management measures (e.g. session timeouts)

The operating environment should provide control and security of network traffic via appropriate measures, such as:

- Network segmentation & network access control
- Traffic filtering
- Encrypted communication

Specifically for workstations connected to the product, appropriate security measures include:

- Operating system hardening and application whitelisting
- Use of strong passwords
- Install only software necessary for the intended use of the operating environment.

To ensure that the security posture of the operating environment and of the product itself remain at a suitable level, appropriate provisions regarding patch management should be in place, such as:

- The operating environment should support patching without compromising interoperability/compatibility
- The operator should have appropriate patch management processes to ensure that security patches for the product are deployed in a timely manner
- The operator should have appropriate patch management processes to ensure that the operating environment (e.g. operating systems, applications) is up-to-date in terms of security

5.3 Environmental information

Disposal Information



Waste Electrical and Electronic Equipment (WEEE)

This symbol on the product indicates that, under the European Directive 2012/19/EU governing waste from electrical and electronic equipment, this product must not be disposed of with other municipal waste. Please dispose of your waste equipment by handing it over to a designated collection point for the recycling of waste electrical and electronic equipment. To prevent possible harm to the environment or human health from uncontrolled waste disposal, please separate these items from other types of waste and recycle them responsibly to promote the sustainable reuse of material resources.

For more information about recycling of this product, please contact your local city office or your municipal waste disposal service. For details, please visit the Barco website at: <https://www.barco.com/about/sustainability/waste-of-electronic-equipment-customers>

Turkey RoHS compliance



Türkiye Cumhuriyeti: AEEE Yönetmeliğine Uygundur.

[Republic of Turkey: In conformity with the WEEE Regulation]

中国大陆 RoHS

Chinese Mainland RoHS

根据中国大陆《电器电子产品有害物质限制使用管理办法》（也称为中国大陆RoHS），以下部分列出了Barco产品中可能包含的有毒和/或有害物质的名称和含量。中国大陆RoHS指令包含在中国信息产业部MCV标准：“电子信息产品中有毒物质的限量要求”中。

According to the “Management Methods for the Restriction of the Use of Hazardous Substances in Electrical and Electronic Products ” (Also called RoHS of Chinese Mainland), the table below lists the names and contents of toxic and/or hazardous substances that Barco’s product may contain. The RoHS of Chinese Mainland is included in the MCV standard of the Ministry of Information Industry of China, in the section “Limit Requirements of toxic substances in Electronic Information Products”.

零件项目(名称) Component name	有毒有害物质或元素 Hazardous substances and elements					
	铅 Pb	汞 Hg	镉 Cd	六价铬 Cr6+	多溴联苯 PBB	多溴二苯醚 PBDE
印制电路配件 Printed Circuit Assemblies	x	o	o	o	o	o
液晶面板 LCD panel	x	o	o	o	o	o
外接电(线)缆 External Cables	x	o	o	o	o	o
内部线路 Internal wiring	o	o	o	o	o	o
金属外壳 Metal enclosure	o	o	o	o	o	o
塑胶外壳 Plastic enclosure	o	o	o	o	o	o
散热片(器) Heatsinks	o	o	o	o	o	o
电源供应器	x	o	o	o	o	o

零件项目(名称) Component name	有毒有害物质或元素 Hazardous substances and elements					
	铅 Pb	汞 Hg	镉 Cd	六价铬 Cr6+	多溴联苯 PBB	多溴二苯醚 PBDE
Power Supply Unit						
风扇 Fan	o	o	o	o	o	o
文件说明书 Paper Manuals	o	o	o	o	o	o
光盘说明书 CD manual	o	o	o	o	o	o
本表格依据SJ/T 11364的规定编制 This table is prepared in accordance with the provisions of SJ/T 11364. o: 表示该有毒有害物质在该部件所有均质材料中的含量均在 GB/T 26572 标准规定的限量要求以下。 o: Indicates that this toxic or hazardous substance contained in all of the homogeneous materials for this part is below the limit requirement in GB/T 26572. x: 表示该有毒有害物质至少在该部件的某一均质材料中的含量超出 GB/T 26572 标准规定的限量要求。 x: Indicates that this toxic or hazardous substance contained in at least one of the homogeneous materials used for this part is above the limit requirement in GB/T 26572.						

在中国大陆销售的相应电子信息产品（EIP）都必须遵照中国大陆《电子电气产品有害物质限制使用标识要求》标准贴上环保使用期限（EFUP）标签。Barco产品所采用的EFUP标签（请参阅实例，徽标内部的编号用于指定产品）基于中国大陆的《电子信息产品环保使用期限通则》标准。

All Electronic Information Products (EIP) that are sold within Chinese Mainland must comply with the “Marking for the restriction of the use of hazardous substances in electrical and electronic product” of Chinese Mainland, marked with the Environmental Friendly Use Period (EFUP) logo. The number inside the EFUP logo that Barco uses (please refer to the photo) is based on the “General guidelines of environment-friendly use period of electronic information products” of Chinese Mainland.



中国RoHS自我声明符合性标志 / China RoHS – SDoC mark

本产品符合《电器电子产品有害物质限制使用管理办法》和《电器电子产品有害物质限制使用达标管理目录》的要求。

This product meets the requirements of the “Management Rule on the Use Restriction of Hazardous Substances in Electrical and Electronic Products” and the “Management Catalogue for the Use Restriction of Hazardous Substances in Electrical and Electronic Products”.



绿色自我声明符合性标志可参见电子档文件

The green SDoC mark is visible in the digital version of this document.

RoHS

Directive 2011/65/EC on the restriction of certain hazardous substances in electrical and electronic equipment.

According to what declared by our components suppliers, this product is RoHS compliant.

5.4 Biological hazard and returns – Decommissioning

Decommissioning

When a device becomes obsolete or unusable, or is no longer needed by the health care facility, it enters the final stage of its life cycle: decommissioning.

Decommissioning is the process of disposing a device, or removing a device from its originally intended use in the health care facility to an alternative use.

Every health care facility or institution shall have standard operating procedures in place to decommission a device according to the Occupational Safety and Health Administration (OSHA) regulations or/and the World Health Organization (WHO) Decommissioning Medical Devices Technical guideline.

The seller / manufacturer of the device has no legal obligation on the device sold in the event that the health care facility or institution decides to activate the decommissioning process.

Overview

The structure and the specifications of this device as well as the materials used for manufacturing makes it easy to wipe and clean and therefore suitable to be used for various applications in hospitals and other medical environments, where procedures for frequent cleaning are specified.

However, normal use shall exclude biological contaminated environments, to prevent spreading of infections.

Therefore use of this device in such environments is at the exclusive risk of Customer. In case this device is used where potential biological contamination cannot be excluded.

Customer shall implement the decontamination process as defined in the latest edition of the ANSI/AAMI ST35 standard on each single failed Product that is returned for servicing, repair, reworking or failure investigation to Seller (or to the Authorized Service Provider). At least one adhesive yellow label shall be attached on the top site of the package of returned Product and accompanied by a declaration statement proving the Product has been successfully decontaminated.

Returned Products that are not provided with such external decontamination label, and/or whenever such declaration is missing, can be rejected by Seller (or by the Authorized Service Provider) and shipped back at Customer expenses.

5.5 Regulatory information

Indications for use

This display is intended to be used for viewing medical images by medical practitioners.

Intended usage environment

This display can also be used in the patient area.

Contra-indications

This display is not intended to be used for direct diagnosis and therapeutic interventional radiology.

Intended users

Clinical review displays are intended to be used by trained medical practitioners.

Notice to the user and/or patient

Any serious incident that has occurred in relation to the device should be reported to the manufacturer and the competent authority of the Member State in which the user and/or patient is established.

Factory address

巴可 (苏州) 医疗科技有限公司, 苏州工业园区苏桐路111号

Barco (Suzhou) Healthcare Technology Co., Ltd., No.111, Sutong Road, Suzhou Industrial Park, 215021 Suzhou China

Manufacturing country

The manufacturing country of the product is indicated on the product label (“**Made in ...**”).

Importers contact information

To find your local importer, contact one of Barco’s regional offices via the contact information provided on our website (www.barco.com).

FCC class B

This device complies with Part 15 of the FCC Rules. Operation is subject to the following two conditions: (1) this device may not cause harmful interference, and (2) this device must accept any interference received, including interference that may cause undesired operation.

This device has been tested and found to comply with the limits for a Class B digital device, pursuant to Part 15 of the FCC Rules. These limits are designed to provide reasonable protection against harmful interference in a residential installation. This device generates, uses and can radiate radio frequency energy and, if not installed and used in accordance with the instructions, may cause harmful interference to radio communications. However, there is no guarantee that interference will not occur in a particular installation. If this device does cause harmful interference to radio or television reception, which can be determined by turning the device off and on, the user is encouraged to try to correct the interference by one or more of the following measures:

- Reorient or relocate the receiving antenna.
- Increase the separation between the device and receiver.
- Connect the device into an outlet on a circuit different from that to which the receiver is connected.
- Consult the dealer or an experienced radio/TV technician for help.

Changes or modifications not expressly approved by the party responsible for compliance could void the user’s authority to operate the equipment.

FCC responsible: Barco Inc., 3059 Premiere Parkway Suite 400, 30097 Duluth GA, United States, Tel: +1 678 475 8000

Canadian notice

CAN ICES-003 (B) / NMB-003(B)

UKCA compliance

UK Responsible Person (UKRP): Barco UK Ltd, Building 329, Doncastle Road, Bracknell RG12 8PE, Berkshire, United Kingdom

5.6 EMC notice

General information

This device is for use in professional healthcare facility environments only.

With the installation of the device, use only the delivered external cables and power supply or a spare part provided by the legal manufacturer. Using another can result in a decrease of the immunity level of the device.



WARNING: Use of this equipment adjacent to or stacked with other equipment should be avoided because it could result in improper operation. If such use is necessary, this equipment and the other equipment should be observed to verify that they are operating normally.



WARNING: Use of accessories, transducers and cables other than those specified or provided by the manufacturer of this equipment could result in increased electromagnetic emissions or decreased electromagnetic immunity of this equipment and result in improper operation.



WARNING: Portable RF communications equipment (including peripherals such as antenna cables and external antennas) should be used no closer than 30 cm (12 inches) to any part of the MDRC-2421, including cables specified by the manufacturer. Otherwise, degradation of the performance of this equipment could result.

Electromagnetic emissions

The MDRC-2421 is intended for use in the electromagnetic environment specified below. The customer or the user of the MDRC-2421 should assure that it is used in such an environment.

Emissions test	Compliance	Electromagnetic environment – Guidance
RF emissions CISPR 11	Group 1	The MDRC-2421 uses RF energy only for its internal function. Therefore, its RF emissions are very low and are not likely to cause any interference in nearby electronic equipment.
RF emissions CISPR 11	Class B	The MDRC-2421 is suitable for use in all establishments, including domestic establishments and those directly connected to the public low-voltage power supply network that supplies buildings used for domestic purposes.
Harmonic emissions IEC 61000-3-2	Not applicable ¹	
Voltage fluctuations/ flicker emissions IEC 61000-3-3	Complies	

This MDRC-2421 complies with appropriate medical EMC standards on emissions to, and interference from surrounding equipment. Operation is subject to the following two conditions: (1) this device may not cause harmful interference, and (2) this device must accept any interference received, including interference that may cause undesired operation.

Interference can be determined by turning the equipment off and on.

If this equipment does cause harmful interference to, or suffer from harmful interference of, surrounding equipment, the user is encouraged to try to correct the interference by one or more of the following measures:

- Reorient or relocate the receiving antenna or equipment.
- Increase the separation between the equipment and receiver.
- Connect the equipment into an outlet on a circuit different from that to which the receiver is connected.
- Consult the dealer or an experienced technician for help.

Electromagnetic immunity

The MDRC-2421 is intended for use in the electromagnetic environment specified below. The customer or the user of the MDRC-2421 should assure that it is used in such an environment.

Immunity test	IEC 60601 test levels	Compliance level	Electromagnetic environment – guidance
Electrostatic discharge (ESD) IEC 61000-4-2	± 8 kV contact ± 2 kV, ± 4 kV, ± 8 kV, ± 15 kV air	± 8 kV contact ± 2 kV, ± 4 kV, ± 8 kV, ± 15 kV air	Floors should be wood, concrete or ceramic tile. If floors are covered with synthetic material, the relative humidity should be at least 30%
Electrical fast transient/ burst IEC 61000-4-4	± 2 kV for power supply lines ± 1 kV for input/ output lines 100 kHz repetition frequency	± 2 kV for power supply lines ± 1 kV for input/ output lines 100 kHz repetition frequency	Mains power quality should be that of a typical commercial or hospital environment

1. Active power for MDRC-2421 is less than 75 W

Immunity test	IEC 60601 test levels	Compliance level	Electromagnetic environment – guidance
Surge IEC61000-4-5	Line to line: ± 0.5 kV, ± 1 kV Line to ground: ± 0.5 kV, ± 1 kV, ± 2 kV	Line to line: ± 0.5 kV, ± 1 kV Line to ground: ± 0.5 kV, ± 1 kV, ± 2 kV	Mains power quality should be that of a typical commercial or hospital environment
Voltage dips, short interruptions and voltage variations on power supply input lines IEC 61000-4-11	0% residual voltage for 0.5 period at 0°, 45°, 90°, 135°, 180°, 225°, 270° and 315° 0% residual voltage for 1 period at 0° 70% residual voltage for 25 periods at 0° Voltage interruptions: 0% residual voltage for 250 periods at 0°	0% residual voltage for 0.5 period at 0°, 45°, 90°, 135°, 180°, 225°, 270° and 315° 0% residual voltage for 1 period at 0° 70% residual voltage for 25 periods at 0° Voltage interruptions: 0% residual voltage for 250 periods at 0°	Mains power quality should be that of a typical commercial or hospital environment. If the user of the MDRC-2421 requires continued operation during power mains interruptions, it is recommended that the MDRC-2421 be powered from an uninterruptible power supply or a battery
Power frequency (50/60 Hz) magnetic field IEC 61000-4-8	30 A/m	Not applicable ²	Power frequency magnetic fields should be at levels characteristic of a typical location in a typical commercial or hospital environment
Conducted RF IEC 61000-4-6	3 Vrms (6 Vrms in ISM bands) 150 kHz to 80 MHz	3 Vrms (6 Vrms in ISM bands)	- N/A
Radiated RF IEC 61000-4-3	3 V/m 80 MHz to 2.7 GHz	10 V/m	

Immunity to RF wireless communications equipment

Test frequency (MHz)	Band (MHz)	Service	Modulation	Maximum power (W)	Distance (m)	Immunity test level (V/m)
385	380 – 390	TETRA 400	Pulse modulation 18 Hz	1.8	0.3	27
450	430 – 470	GMRS 460, FRS 460	FM ± 5 kHz deviation 1 kHz sine	2	0.3	28
710	704 – 787	LTE Band 13, 17	Pulse modulation 217 Hz	0.2	0.3	9
745						
780						
810	800 – 960	GSM 800/ 900, TETRA 800, iDEN 820, CDMA 850, LTE Band 5	Pulse modulation 18 Hz	2	0.3	28
870						
930						
1720	1700 – 1990	GSM 1800, CDMA 1900, GSM 1900, DECT, LTE	Pulse modulation 217 Hz	2	0.3	28
1845						
1970						









2. MDRC-2421 doesn't contain susceptible components to magnetic fields















Test frequency (MHz)	Band (MHz)	Service	Modulation	Maximum power (W)	Distance (m)	Immunity test level (V/m)
		Band 1/3/4/25, UMTS				
2450	2400 – 2570	Bluetooth, WLAN, 802.11 b/g/n, RFID 2450, LTE Band 7	Pulse modulation 217 Hz	2	0.3	28
5240	5100 – 5800	WLAN 802.11 a/n	Pulse modulation 217 Hz	0.2	0.3	9
5500						
5785						

5.7 Explanation of symbols





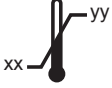









Symbols on the device

On the device or power supply, you may find the following symbols (nonrestrictive list):

	Indicates the device meets the requirements of the applicable EC directives/regulations.
	Indicates compliance with Part 15 of the FCC rules (Class A or Class B).
	Indicates the device is approved according to the UL Recognition regulations.
	MEDICAL – GENERAL MEDICAL EQUIPMENT AS TO ELECTRICAL SHOCK, FIRE AND MECHANICAL HAZARDS ONLY IN ACCORDANCE WITH ANSI/AAMI ES60601-1:2005/R1:2012 + R2:2021, CSA CAN/CSA-C22.2 NO. 60601-1:14
	Indicates the device is approved according to the UL Demko regulations.
	Indicates the device is approved according to the CCC regulations.
	Indicates the device is approved according to the VCCI regulations.
	Indicates the device is approved according to the KC regulations.
	Indicates the device is approved according to the BSMI regulations.





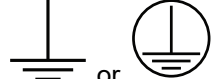

	<p>Indicates the device is approved according to the PSE regulations.</p>
	<p>Indicates the device is approved according to the RCM regulations.</p>
	<p>Indicates the device is approved according to the EAC regulations.</p>
	<p>Caution: Federal law (United States of America) restricts this device to sale by or on the order of a licensed healthcare practitioner.</p>
<p>IS 13252 (Part 1) IEC 60950-1</p>  <p>R-xxxxxxx www.bis.gov.in</p>	<p>Indicates the device is approved according to the BIS regulations.</p>
	<p>Indicates the device is approved according to the INMETRO regulations.</p>
	<p>Indicates the device meets the requirements of the UK MDR 2002 (as amended).</p>
	<p>Indicates the USB connectors on the device.</p>
	<p>Indicates the DisplayPort connectors on the device.</p>
	<p>Indicates the legal manufacturer.</p>
	<p>Indicates the manufacturing date.</p>
	<p>Indicates the entity importing the medical device into the locale.</p>
	<p>Indicates the temperature limitations³ for the device to safely operate within specs.</p>
	<p>Indicates this is a Medical Device.</p>

3. Values for xx and yy can be found in the technical specifications paragraph.

	Indicates the device serial number.
	Indicates the device part number or catalogue number.
	Indicates the Unique Device Identifier.
	Indicates the Authorised Representative for the European Union.
	Indicates the Authorised Representative for Switzerland.
	Warning: dangerous voltage
	Caution
	Consult the Instructions For Use.
 eIFU indicator	Consult the Instruction For Use on website address that is provided as eIFU indicator.
	Indicates this device must not be thrown in the trash but must be recycled, according to the European WEEE (Waste Electrical and Electronic Equipment) directive.
	Indicates Direct Current (DC).
	Indicates Alternating Current (AC).
	Stand-by
	Equipotentiality
	Protective earth (ground)

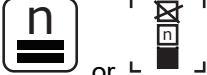
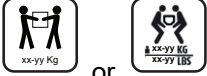
Symbols on the box

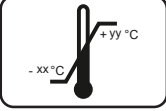
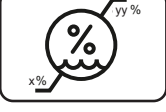
On the box of the device, you may find the following symbols (nonrestrictive list):

	Indicates a device that can be broken or damaged if not handled carefully when being stored.
	Indicates a device that needs to be protected from moisture when being stored.
	Indicates the storage direction of the box. The box must be transported, handled and stored in such a way that the arrows always point upwards.
	Indicates the maximum number of identical boxes which may be stacked on each other, where "n" is the limiting number.
	Indicates the weight of the box and that it should be carried with two persons.
	Indicates that the box should not be cut with a knife, a cutter or any other sharp object.
	Indicates the temperature limits ⁴ to which the device can be safely exposed when being stored.
	Indicates the range ⁴ of humidity to which the device can be safely exposed when being stored.
	Indicates the range ⁴ of atmospheric pressure to which the device can be safely exposed when being stored.

5.8 Technical specifications

Overview

Screen technology	IPS TFT
Active screen size (diagonal)	541.0 mm (21.3")
Active screen size (H x V)	432.0 mm x 324.0 mm (17.0 x 12.8")
Aspect ratio (H:V)	4:3
Resolution	2MP (1600 x 1200 pixels)
Pixel pitch	0.270 mm
Color imaging	Yes
Gray imaging	Yes
Bit depth	8 bit
Viewing angle (H, V)	178°

4. Values for xx and yy can be found in the technical specifications paragraph.

Front sensor	Yes, Front Consistency Sensor
Maximum luminance (panel typical)	500 cd/m ²
DICOM calibrated luminance	250 cd/m ²
Contrast ratio (panel typical)	1800:1
Response time ((Tr + Tf)/2) (typical)	8 ms
Housing color	RAL 9004
Video input signals	1x DisplayPort 1x DVI-D 1x DVI-A 1x HDMI
USB ports	1x USB 2.0 upstream (endpoint) 2x USB 2.0 downstream
Power rating	100-240 VAC, 50-60 Hz, 0.75-0.45A
Power consumption	< 25 W < 0.3 W (hibernate) < 0.3 W (switched off)
Dimensions with stand (W x H x D)	Portrait: 374.5 x 506.6~583.3 x 201.3 mm Landscape: 477.0 x 411.5~529.6 x 201.3 mm
Dimensions w/o stand (W x H x D)	Portrait: 477.0 x 374.5 x 70.4 mm Landscape: 374.5 x 477.0 x 70.4 mm
Dimensions packaged (W x H x D)	195 x 488 x 527 mm
Net weight with stand	6.2 kg
Net weight w/o stand	4.1 kg
Net weight packaged	10 kg
Tilt	-5° to +22°
Swivel	N/A
Pivot	0° to 90°
Height adjustment range	110 mm
Mounting standard	VESA (100 mm)
Recommended modalities	All digital images, except digital mammography.
Certifications*	FDA Class I, 510(k) exempt CE (Medical Device Class I) UKCA (UK) CCC(China) KC(Korea) VCCI(Japan) BIS (India) UL (US and Canada), FCC, DEMKO Safety specific:

	<p>IEC 60601-1:2005 + AMD1:2012+ AMD2:2020 EN 60601-1:2006 + A1:2013 + A12:2014 + A2:2021 IEC 62368-1:2018 EN 62368-1:2020 + A11:2020 IEC 60601-1-6:2010 + AMD1:2013 + AMD2:2020 ANSI/AAMI ES60601-1:2005 + R1:2012 + R2:2021 CAN/CSA C22.2 No. 60601-1:2014 GB 4943.1-2022 EMC specific: IEC 60601-1-2:2014 + A1:2020 EN 60601-1-2:2015 + A1:2021 FCC Part 15 Subpart B ICES-003 Level B GB 17625.1-2022 GB/T 9254.1-2021 Environmental: China Energy Label, EU RoHS, China RoHS, REACH, Canada Health, WEEE, Packaging Directive *Some of the listed certifications may still be pending. For the actual list of applicable certifications, please refer to the product page on www.barco.com or see the certification marks on the product label of your display.</p>
Supplied accessories	<p>1x DisplayPort video cable 1x USB cable 1x Printed user guide (in English, other languages can be found on the documentation disc) 1x Documentation disc 1x System sheet Mains cables</p>
QA software	QAWeb
Warranty	3 years
Operating temperature	0°C to +40 °C
Storage temperature	-20 °C to +60 °C
Operating humidity	20 % to 90 % (non-condensing)
Storage humidity	10% to 90 % (non-condensing)
Operating pressure	70 kPa minimum
Storage pressure	50 to 106 kPa



Barco NV
President Kennedypark 35
8500 Kortrijk
Belgium

