



Simply Better Connections

VW3620

36 × 20 Modular Video Wall
Processor
User Manual

Compliance Statements

FEDERAL COMMUNICATIONS COMMISSION INTERFERENCE STATEMENT

This equipment has been tested and found to comply with the limits for a Class A digital device, pursuant to Part 15 of the FCC Rules. These limits are designed to provide reasonable protection against harmful interference when the equipment is operated in a commercial environment. This equipment generates, uses, and can radiate radio frequency energy and, if not installed and used in accordance with the instruction manual, may cause harmful interference to radio communications. Operation of this equipment in a residential area is likely to cause harmful interference in which case the user will be required to correct the interference at his own expense.

The device complies with Part 15 of the FCC Rules. Operation is subject to the following two conditions: (1) this device may not cause harmful interference, and (2) this device must accept any interference received, including interference that may cause undesired operation.

FCC Caution

Any changes or modifications not expressly approved by the party responsible for compliance could void the user's authority to operate this equipment.

Warning

Operation of this equipment in a residential environment could cause radio interference.

Achtung

Der Gebrauch dieses Geräts in Wohnumgebung kann Funkstörungen verursachen.



KCC Statement

유선 제품용 / A 급 기기 (업무용 방송 통신 기기)
이 기기는 업무용 (A 급) 전자파적합기기로서 판매자 또는 사용자는 이
점을 주의하시기 바라며, 가정 외의 지역에서 사용하는 것을 목적으로
합니다.

Industry Canada Statement

This Class A digital apparatus complies with Canadian ICES-003.

CAN ICES-003 (A) / NMB-003 (A)

HDMI Trademark Statement

The terms HDMI, HDMI High-Definition Multimedia Interface, and the HDMI Logo are trademarks or registered trademarks of HDMI Licensing Administrator, Inc.



RoHS

This product is RoHS compliant.

User Information

Online Registration

Be sure to register your product at our online support center:

International	http://eservice.aten.com
---------------	---

Telephone Support

For telephone support, call this number:

International	886-2-8692-6959
China	86-400-810-0-810
Japan	81-3-5615-5811
Korea	82-2-467-6789
North America	1-888-999-ATEN ext 4988 1-949-428-1111

User Notice

All information, documentation, and specifications contained in this manual are subject to change without prior notification by the manufacturer. The manufacturer makes no representations or warranties, either expressed or implied, with respect to the contents hereof and specifically disclaims any warranties as to merchantability or fitness for any particular purpose. Any of the manufacturer's software described in this manual is sold or licensed *as is*. Should the programs prove defective following their purchase, the buyer (and not the manufacturer, its distributor, or its dealer), assumes the entire cost of all necessary servicing, repair and any incidental or consequential damages resulting from any defect in the software.

The manufacturer of this system is not responsible for any radio and/or TV interference caused by unauthorized modifications to this device. It is the responsibility of the user to correct such interference.

The manufacturer is not responsible for any damage incurred in the operation of this system if the correct operational voltage setting was not selected prior to operation. PLEASE VERIFY THAT THE VOLTAGE SETTING IS CORRECT BEFORE USE.

Caution: There is a risk of explosion if the battery is replaced by an incorrect type. Always dispose of used batteries according to the relevant instructions.

Product Information

For information about all ATEN products and how they can help you connect without limits, visit ATEN on the Web or contact an ATEN Authorized Reseller. Visit ATEN on the Web for a list of locations and telephone numbers:

International	http://www.aten.com
---------------	---

Package Contents

Check to make sure that all of the components are present and in good order. If anything is missing or was damaged in shipping, contact your dealer.

VW3620

The VW3620 package consists of:

- ◆ 1 VW3620 36 × 20 Modular Video Wall Processor
- ◆ 1 power module
- ◆ 1 power cord
- ◆ 1 cable strap
- ◆ 1 user instructions

VW784 / VW884

The 4-Port 4K HDMI Input Board for VW Series / 4-Port 4K HDMI Output Board for VW Series package consists of:

- ◆ 1 VW784 4-Port 4K HDMI Input Board for VW Series / VW884 4-Port 4K HDMI Output Board for VW Series
- ◆ 1 user instructions

Contents

Compliance Statements	ii
User Information	iv
Online Registration	iv
Telephone Support	iv
User Notice	iv
Product Information	v
Package Contents	v
VW3620	v
VW784 / VW884	v
Contents	vi
About this Manual	xi
Conventions	xii

1. Introduction

Overview	1
VW3620	1
VW784 / VW884	2
Features	3
VW3620	3
VW784 / VW884	4
Compatible Browsers	5
Optional Equipment	5
Components	6
VW3620 Front View	6
VW3620 Side View	7
VW3620 Rear View	8
VW784 Front View	10
VW884 Front View	11

2. Hardware Setup

Transporting and Storing the Unit	13
Installing the Power Module	14
Adjusting the Cable Strap	18
Installation	19

Installing the Input / Output Boards	22
Rack Mounting	24
Mounting with Brackets	25

3. Front Panel Operation

Overview	29
Front Panel Pushbuttons	30
Front Panel LCD	31
Standby Mode	31
Idle Screen	31
LCD Password	32
Menu	34
System Info	35
Mode	36
Timeout	36
Change Password	37
Settings	38
Baud Rate	38
EDID Mode	39
OSD	39
Network	40
F/W upgrade	41
Local Output	44
Zone View	45
Single Source View	45
Array Source View	46
Profile	47

4. Browser Operation

Overview	49
Logging In	49
Display Configuration	51
Main Page	53
Menu Bar	54
Setting the Standby Mode	54
Source Array	55

Design Mode	56
Understanding Display Zones	56
Understanding Profiles and Profile List	56
Interactive Functions on Design Mode Tab	56
Multiview Window Management	63
Create a Multiview Window	63
Configure a Multiview Window	65
Customized Video Source	66
Profile Management	67
Creating a Profile	67
Edit a Profile	68
Apply a Profile	69
Preview	70
Delete a Profile	71
System Settings	72
Overview	73
General	74
Port Settings	76
OSD	76
HDCP	77
Source Settings	78
Zone Settings	78
Scaler Resolution	79
Port Name	81
EDID	82
EDID Mode	83
EDID & CEA Description	84
CEC	85
HDR	86
Status	87
Maintenance	88
System Setup	89
User Account	90
Add a New User	90
Edit / Delete an Existing User	92
Network	93
Security	95

5. CLI Commands

Overview	97
Connecting to the Video Wall Processor via Telnet	97
Connecting to the Video Wall Processor via RS-232	98
Command Guidelines	99
Verification	99
Commands	100
Switch Port Command	100
Parameters:	100
Example:	100
Load Profile Commands	101
Parameters:	101
Example:	101
EDID Mode Command	102
Parameters:	102
Example:	102
Read Command	103
Example:	103
Reset Command	103
Example:	103
Reboot Command	103
Example:	103
Baud Rate Command	104
Parameters:	104
Example:	104
Echo Command	104
Parameters:	104
Example:	104
Fan Speed Command	105
Parameters:	105
Example:	105
Alert Command	106
Parameters:	106
Example:	106
Standby Mode Command	107
Parameters:	107
Example:	107

Appendix

Safety Instructions	109
General	109
Rack Mounting	111
Technical Support	112
International	112
Specifications	113
VW3620	113
VW784 / VW884	115
ATEN Standard Warranty Policy	116
Limited Hardware Warranty	116

About this Manual

This manual covers all aspects of installation, configuration and operation of the VW3620 36 × 20 Modular Video Wall Processor. An overview of the information found in the manual is provided below.

Chapter 1 Introduction introduces you to the VW3620 and its components. Its purpose, features and benefits are presented, and its front and back panel components are described.

Chapter 2 Hardware Setup describes how to set up the hardware for your Modular Matrix Solution installation.

Chapter 3 Front Panel Operation explains the fundamental concepts involved in operating the VW3620 at the local site via the front panel LCD display using pushbuttons.

Chapter 4 Browser Operation provides a complete description of the Modular Matrix Solution's web Graphical User Interface (GUI), and how to use it to remotely configure and operate the Modular Matrix Solution.

Appendix provides specifications and other technical information regarding the VW3620.

Note:

- ◆ Read this manual thoroughly and follow the installation and operation procedures carefully to prevent any damage to the device or to any other connected devices.
 - ◆ The VW3620 product firmware may have been updated with new features after the release of this manual. For an up-to-date VW3620 user manual, visit <http://www.aten.com/global/en/>
-

Conventions

This manual uses the following conventions:

- Monospaced Indicates text that you should key in.
- [] Indicates keys you should press. For example, [Enter] means to press the **Enter** key. If keys need to be chorded, they appear together in the same bracket with a plus sign between them: [Ctrl+Alt].
1. Numbered lists represent procedures with sequential steps.
- ◆ Bullet lists provide information, but do not involve sequential steps.
- > Indicates selecting the option (on a menu or dialog box, for example), that comes next. For example, Start > Run means to open the *Start* menu, and then select *Run*.
-  Indicates critical information.

Chapter 1

Introduction

Overview

VW3620

Purpose-built to meet the increasingly stringent system performance requirements in mission-critical applications, the VW3620 is a 7U, modular 4K video wall processor with 7 input slots, 5 output slots, and 2 function board slots, which also work as input board slots, to support up to 36 input sources and 20 display terminals while being able to handle 4K sources without delay. Advanced 4K@60 4:4:4 scaling technology plus the signal processing capability allow the VW3620 to deliver astonishing, accurate True 4K imagery. The hot-swappable, redundant CPU control board and dual power modules add an extra level of reliability. With input / output cards and cooling fan module also coming hot-swappable, the VW3620 guarantees 24/7 operation and easy maintenance in scenarios where system malfunction or shutdown is unacceptable.

Thanks to ATEN's cutting-edge windowing technology, the VW3620 supports multiple video walls with varying resolutions. Nearly restriction-free window placement functionality allows source cropping, overlap, and more, displaying a tailored view of every piece of crucial information. Organization logos, color schemes, calendar, clock, and scrolling text can be added to the video walls to widely broaden applications. Moreover, the VW3620 can be configured and controlled via various methods to overcome geographical limitations, from RS-232, Ethernet, the front panel buttons, web GUI to RESTful API. Integration with ATEN Control System and the 3rd party devices is allowed through its RS-232 and Ethernet interfaces as well as the support for RESTful APIs.

The VW3620's unrivalled video wall processing power, configurability and reliability have made it suitable for a range of mission-critical video wall applications, including command centers, control rooms, public security organizations, governments, or other large-scale digital signage scenarios such as exhibitions, broadcasting, and education organizations.

VW784 / VW884

VW784 / VW884 is a 4-port 4K HDMI input / output board built to work with VW3620 Modular Video Wall Processor, with VW784 taking 4 HDMI sources and VW884 enabling routing of 4 HDMI signals to 4 displays, meeting the increasingly stringent video wall requirements in mission-critical applications. With the support for Seamless Switch™, the VW784 / VW884 allows real-time video switching and stable signal transmission.

The EDID Expert™ technology enables the selection of optimum EDID settings for smooth power-up, high quality display and use of the best video resolutions across different screens. A True 4K scaler is built into VM884 to handle different video resolutions. In addition, the VW784 / VW884 supports hot-swappable installation to give system integrators great flexibility and efficiency for maintenance.

Features

VW3620

- ◆ Processes up to 36 input sources and manages up to 20 displays in any sizes at varying resolutions from a single 7U chassis
- ◆ Modular construction with 7 input slots, 5 output slots, and 2 function board slots, which also work as input board slots, to meet various expansion needs
- ◆ FPGA hardware architecture—handles 4K input sources, supports near-zero-second seamless source switching, and transmits high quality video streams without delay
- ◆ True 4K@60 scalability with 4:4:4 signal processing—supports custom resolutions and enables upscaling of video signals for crystal clear, accurate imagery regardless of the display size or type from LED, LCD, DLP, to other large screens
- ◆ Reliable 24/7 operation with hot-swappable, redundant CPU control board and dual power modules, and hot-swappable input / output cards and cooling fan module
- ◆ HDMI (Deep Color, True 4K); HDCP 2.2 compliant
- ◆ Powerful windowing technology for nearly restriction-free content placement—outputs signals in real-time in customizable layouts, such as PiP, PbP, source cropping, overlapping, and spreading across multiple screens, and in any sizes based on the correct aspect ratio
- ◆ Seamless Switch™—unifies video formats to provide continuous video streams, real-time switching and stable signal transmissions
- ◆ Powerful windowing technology for nearly restriction-free content placement—outputs signals in real-time in customizable layouts, such as PiP, PbP, source cropping, overlapping, and spreading across multiple screens, and in any sizes based on the correct aspect ratio
- ◆ Supports Multiview—content source monitoring in 2 × 2 or 4 × 4 layouts from a single display
- ◆ Customizable elements to enhance organization identity and video wall presentation including logos, color schemes, calendar, clock, and scrolling text
- ◆ Direct control via RS-232 / Ethernet connection and the front panel buttons
- ◆ Remote control via intuitive Web GUI to preview input signals in real-time and control outputs including content placement and management of up to 4 canvases

- ◆ Local HDMI output—monitoring of video input signals and video wall layouts via Single / Array mode at up to 1080p in real-time from one display
- ◆ Integration with ATEN Control System and the 3rd party devices via RS-232 / Ethernet / RESTful API
- ◆ Built-in USB Type-A ports—video wall background image change and firmware upgrade
- ◆ Supports FrameSync—avoids image tearing by synchronizing the scaler output frame rate to the input signal frame rate
- ◆ EDID Expert™—selects optimum EDID settings for smooth power-up, high-quality display and use of the best video resolution across different screens
- ◆ Perfect for mission-critical video wall applications, including command centers, control rooms, public security organizations, governments, or other large-scale digital signage scenarios

VW784 / VW884

- ◆ Works with VW3620 to take 4 HDMI sources (VW784) and enable routing of 4 HDMI signals to 4 displays (VW884) for optimum flexibility
- ◆ Supports resolutions up to 4K for superior video quality
- ◆ True 4K @ 60 Hz scalability—supports custom resolutions and enables upscaling of signals for crystal clear, accurate imagery regardless of the display size or type from LED, LCD, DLP, to other large screens (VW884)
- ◆ Supports HDR, HDR+, and Dolby Vision
- ◆ Seamless Switch—unifies video formats to provide continuous video streams, real-time switching, and stable signal transmissions
- ◆ EDID Expert—selects optimum EDID settings for smooth power-up and the highest quality display
- ◆ HDMI (Deep Color, 4K); HDCP 2.2 Compatible
- ◆ Supports hot-swappable installation for great system integration flexibility and maintenance efficiency
- ◆ Output rates matched to input rates to prevent lagging and freezing, ensuring stable, smooth video display
- ◆ Consumer Electronics Control (CEC)

Compatible Browsers

In order to achieve the best performance, the browsers listed in the table below are recommended to be used with the VW3620 Web GUI.

OS	Java Version	Browser
Windows 10 (64 bit)	V1.8.0_391 (64 bit)	Chrome
		Edge
		Firefox
		Opera
Windows 10 Enterprise (64 bit)		IE
MAC 14.1	Safari	

Optional Equipment

Purchase optional equipment such as a secondary power module, fan, or rack mount kit to get the most out of your ATEN Video Wall Processor. For more information, go to <https://www.aten.com/global/en/>

Components

VW3620 Front View

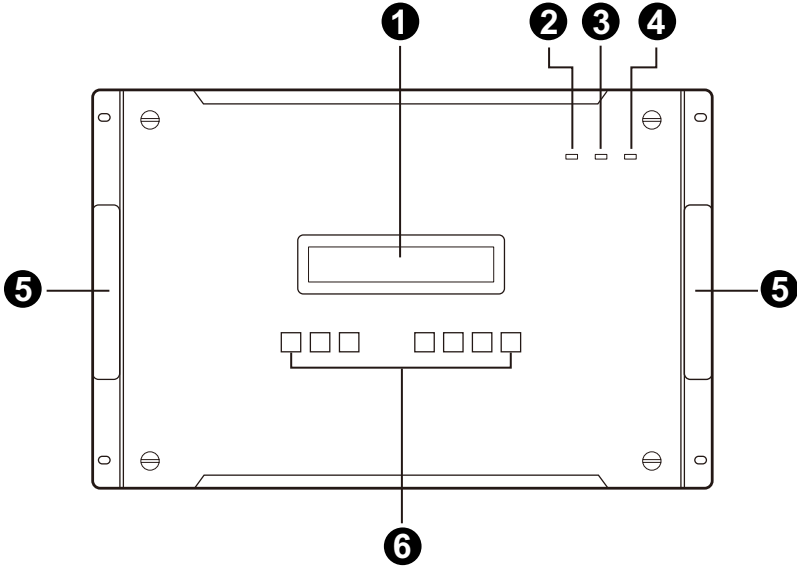

No.	Component	Description
1	LCD display	The LCD display shows the options for configuring and operating the VW3620. See <i>Front Panel Pushbuttons</i> , page 30, for details.
2	alarm LED	The LED lights red to indicate that a system error occurred. To obtain details for the issue, log in to the Web GUI. The alarm LED goes off once the system error is fixed.
3	redundant power LED	The LED lights green to indicate that the redundant power module is in operation.
4	primary power LED	The primary power LED gives the following status: <ul style="list-style-type: none"> ◆ lights green Indicates that the primary power module is in operation. ◆ blinks Indicates that the unit is in sleep mode.
5	handles	The two front handles are used to install the unit into a rack.
6	function pushbuttons	Use the pushbuttons to control and configure the options available to the unit. See <i>Front Panel Pushbuttons</i> , page 30, for details. Note: The pushbuttons have LEDs that light to indicate they have been selected.

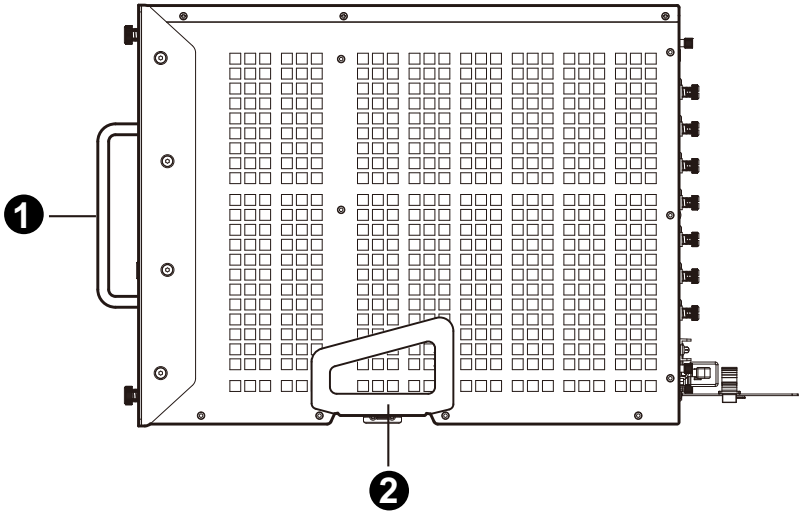
VW3620 Side View

No.	Component	Description
1	handles	The two front handles are used to install the unit into a rack.
2	recessed handles	The two side handles are used to transport the unit. Push in to lock and unlock the handles so that they can be used to carry the unit and be tucked away when not in use.

VW3620 Rear View

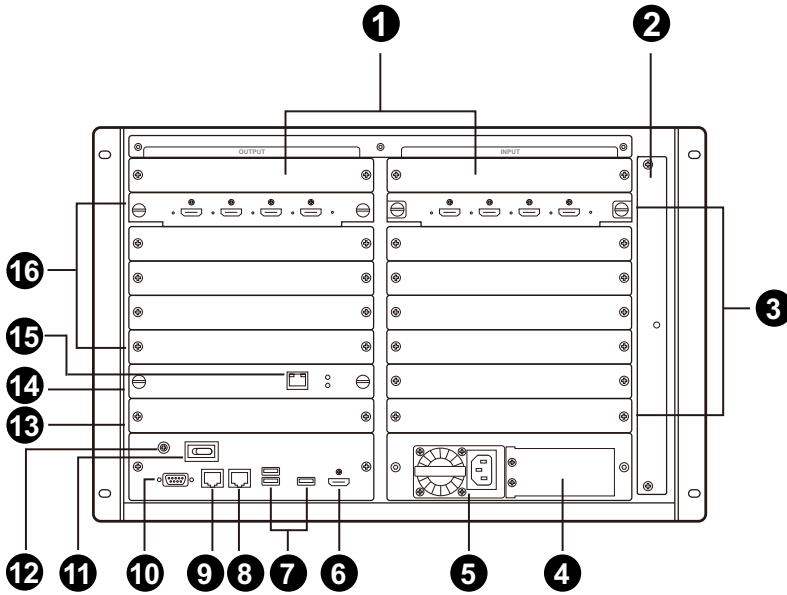

No.	Component	Description
1	function board / video input board slots	Optionally install the VW784 video input board(s) to the function board / video input board slot(s) for expansion.
2	fan module	The fan module is used for cooling down the unit that generates heat in operation.
3	video input board slots	Optionally install the VW784 video input board(s) to the video input board slot(s) for expansion.
4	redundant power slot	Optionally install an additional power supply for redundant power protection. For more information about the power module, visit the product web page.
5	primary power module	Connect the supplied power cord to the unit's primary power socket. See <i>Installing the Power Module</i> , page 14 for how to install the power module to the VW3620 video wall processor.
6	system HDMI local output	Connect to an HDMI-enabled display for monitoring, previewing, and controlling the real-time content.
7	USB Type-A ports	Connect your data storage device(s) to the USB Type-A port(s). Currently the USB ports support storage and firmware upgrade.

No.	Component	Description
8	RJ-45 port (chain out)	Connect to the RJ-45 port (chain in) of the next VW3620 to daisy-chain the units. Note: The daisy-chaining functionality will be supported in a future update.
9	RJ-45 port (chain in)	Connect to the RJ-45 port (chain out) of the last VW3620 to daisy-chain the units. Note: The daisy-chaining functionality will be supported in a future update.
10	RS-232 serial port	Connect a PC or an ATEN Control Box to the RS-232 serial port for controlling the unit.
11	grounding terminal	Attach the grounding wire here.
12	power switch	Use the power switch to power the unit on and off.
13	redundant CPU slot	Optionally install the CPU board to VW3620's redundant CPU slot for hot-standby operation.
14	primary CPU board	Connect the Ethernet port of the primary CPU board to the network using an Ethernet cable.
15	Ethernet port	In order to access the VW3620's web Graphical User Interface (GUI), the VW3620 must be connected to the network. The cable that connects the VW3620 to your LAN plugs in here. For further details, see <i>Installation</i> page 19.
16	video output board slots	Optionally install the VW884 video output board(s) to the video output board slot(s) for expansion.

VW784 Front View

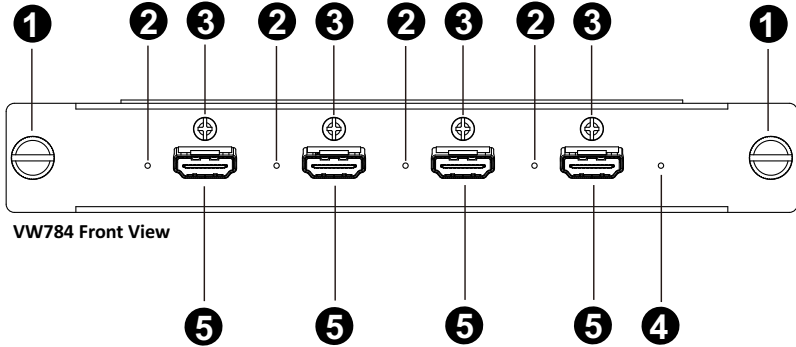

No.	Component	Description
1	thumb screws	Tighten the screw by turning it clockwise while loosen the screw by turning it anticlockwise.
2	link LEDs	Light up to indicate stable connection with the connected source devices.
3	ATEN LockPro™ screws	Optionally secure an ATEN LockPro™ to hold the HDMI cable in place and prevent it from falling off.
4	status LED	Indicate the working status of the unit.
5	HDMI out	Connect with your video display device(s) using an HDMI cable.

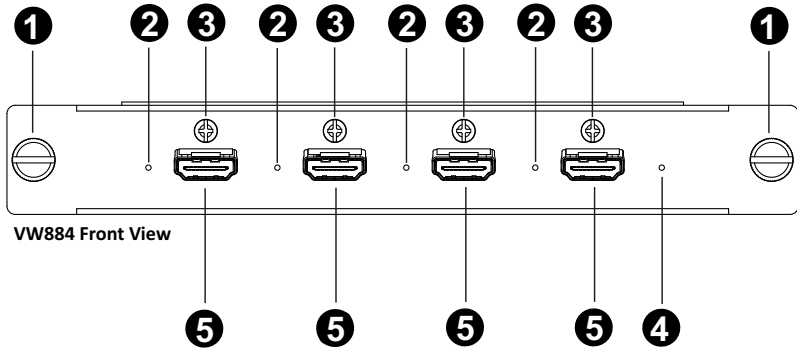
VW884 Front View

No.	Component	Description
1	thumb screws	Tighten the screw by turning it clockwise while loosen the screw by turning it anticlockwise.
2	link LEDs	Light up to indicate stable connection with the connected source devices.
3	ATEN LockPro™ screws	Optionally secure an ATEN LockPro™ to hold the HDMI cable in place and prevent it from falling off.
4	status LED	Indicates the working status of the unit.
5	HDMI out	Connect with your video source device(s) using an HDMI cable.

This Page Intentionally Left Blank

Chapter 2

Hardware Setup



1. Important safety information regarding the placement of this device is provided on page 109. Please review it before proceeding.
2. Make sure that the power to all devices connected to the installation are turned off. You must unplug the power cords of any computers that have the Keyboard Power On function.

Transporting and Storing the Unit

Its important to properly transport and store the VW3620. Follow the instructions below to avoid damaging the VW3620 due to improper handling.

When not rack mounted, the VW3620 should be placed on a flat and level surface with the bottom side down. The unit should never be placed with the front, rear or sides facing the ground.

Not for transportation

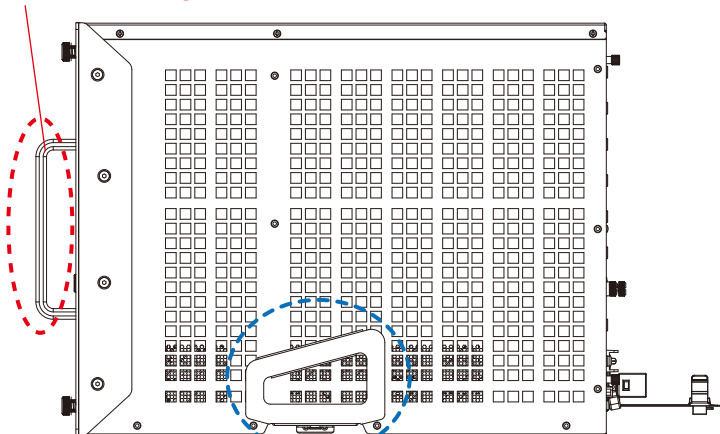

To transport the unit, use the recessed handles, but not the 2 front handles.

Installing the Power Module

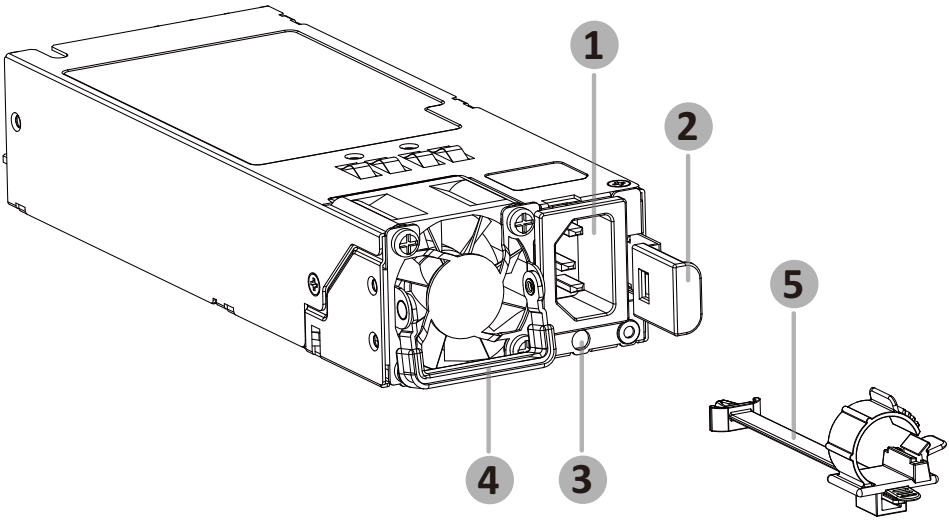

No.	Item	Description
1	3 prong socket	Plugs in the supplied power cord here.
2	power module release lever	Press the lever to detach the power module from the VW3620 video processor.
3	strap mounting hole	Plugs the cable strap here.
4	power module handle	Uses the handle to slide the power module in or out of the VW3620 video wall processor.
5	cable strap	Attaches the cable strap onto the power module and uses it to secure the power cable that connects to the power module.

To install the power module to the VW3620 video wall processor, do the followings:

1. Attach the cable strap to the power module by inserting it into the strap mounting hole.

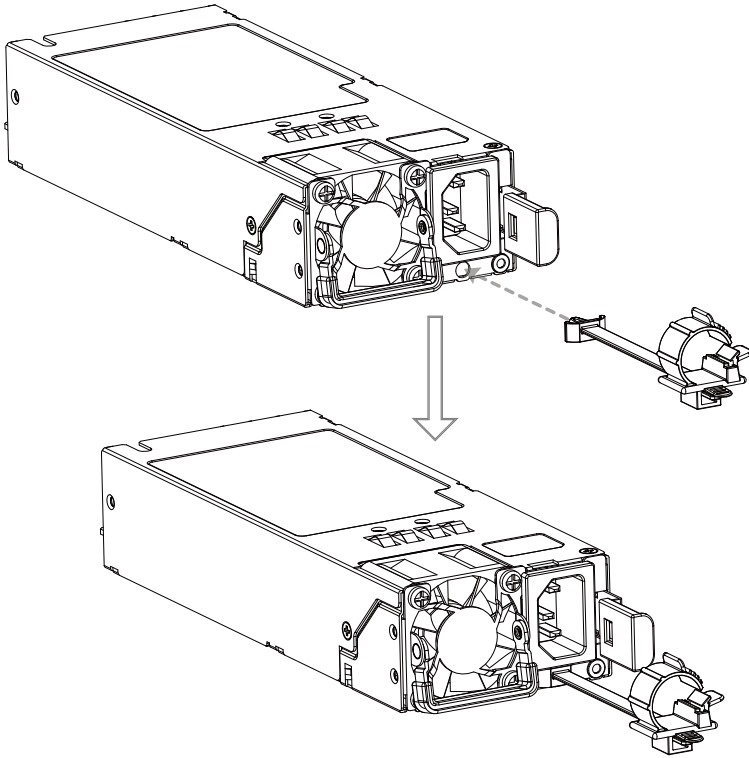

2. Install the power module to a power slot on the rear side of the VW3620 video wall processor:
 - a) To install the power module to the primary power slot, follow the description as step 3 instructs.
 - b) To install the power module to the redundant power slot, remove the slot cover first.

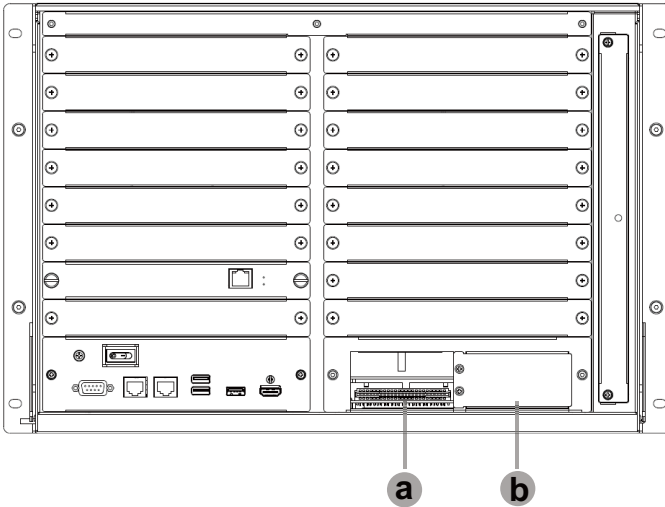

3. Slide the power module to the power slot. A click sound is made once the power module is properly installed.

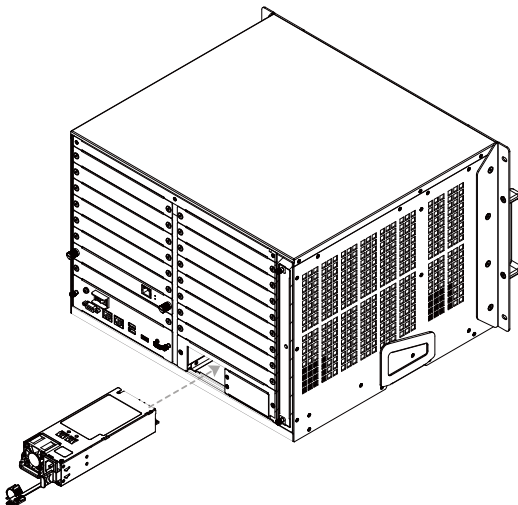

4. Plug the power cord into the 3 prong socket of the power module.

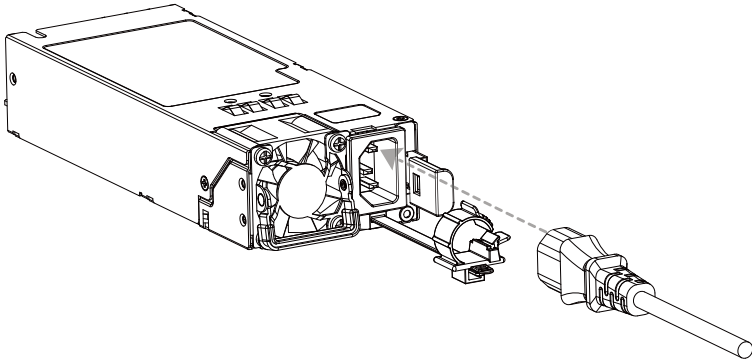

5. Secure the power cord by moving the buckle to the strain relief side of the power cord.

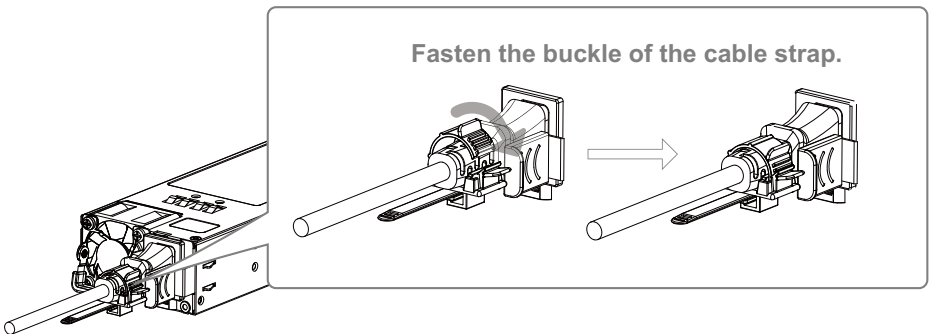
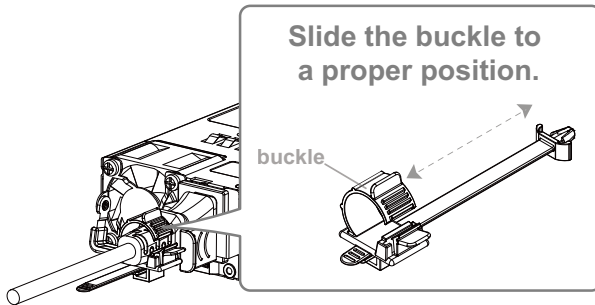

Adjusting the Cable Strap

To loosen the buckle of the cable strap, press the buckle detach lever to unlock the buckle. To adjust the position of the buckle, push down on the locking release lever and move the buckle toward or backward to your preferred position.

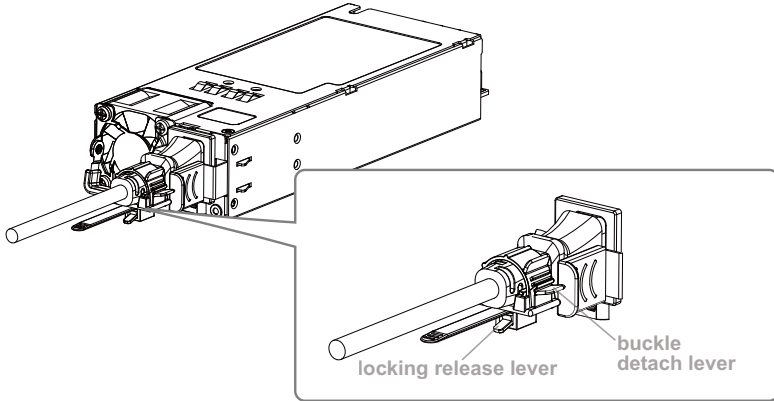

Installation

Follow the steps below to safely install devices to the VW3620.

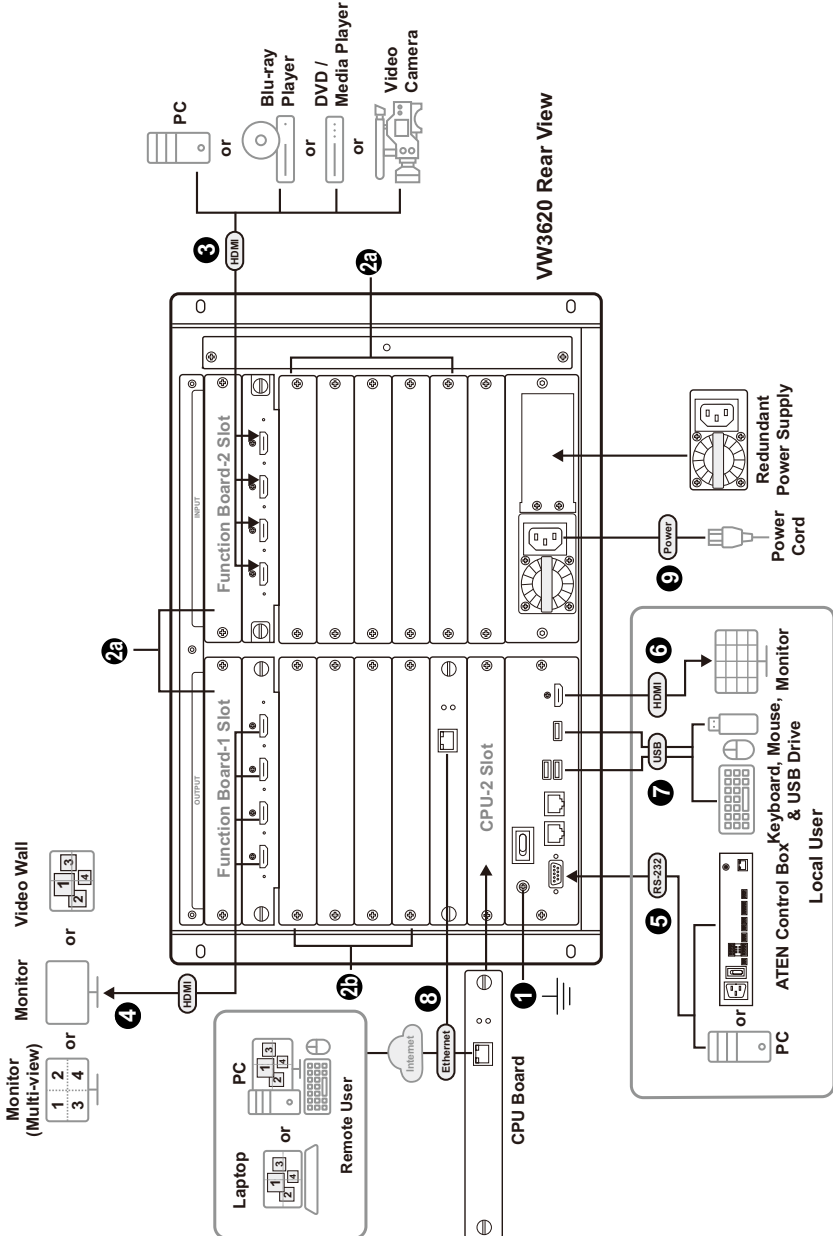

Note: 1. Install the power module onto the unit in advance. See *Installing the Power Module*, page 14, for details.

2. Make sure all the equipment you are connecting to the unit is turned off and disconnected from the power source.
-

1. Use a grounding wire to ground the unit by connecting one end of the wire to the grounding terminal, and the other end of the wire to a suitable grounded object.

Note: Do not omit this step. Proper grounding helps prevent damage to the unit from surges or static electricity.

2. Optionally install the video input boards/video output boards to the VW3620 for expansion.
 - a) Install the VW784 video input board(s) to the **video input board slot(s)** or the **function board/video input board slot(s)**.
 - b) Install the VW884 video output board(s) to **video output board slot(s)**.
3. Connect your video source device(s) to the HDMI input port(s) of the VW784 video input board(s).
4. Connect your video display device(s) to the HDMI output port(s) of the VW884 video output board(s).
5. (Optional) To control the VW3620 via serial communication, connect your PC or ATEN Control Box to the unit's RS-232 port.
6. (Optional) To monitor, preview, and control the real-time content, connect an HDMI-enabled display to the system HDMI local output port.
7. (Optional) To upgrade firmware, set the video wall background image, or store the log event data, connect your data storage device(s) to the USB Type-A port(s).

8. (Optional) To remotely operate the VW3620 via the Web GUI, connect the Ethernet port of the primary CPU board to the network using an Ethernet cable.

-
- Note:**
1. Optionally install the CPU board to VW3620's redundant CPU slot for hot-standby operation.
 2. Secondary CPU board is not part of the standard VW3620 package. For more information on supported CPU boards, go to <https://www.aten.com/global/en/>.
-

9. Connect the supplied power cord to the unit's primary power socket after powering on all other connected equipment.

-
- Note:**
1. For redundant power, plug in a power module to the redundant power slot.
 2. Secondary power modules are not part of the standard VW3620 package. For more information on supported power modules, go to <https://www.aten.com/global/en/>.
-

10. Turn on the unit's *power switch* (refer to page 9), and the *primary power LED* (refer to page 6) lights green to indicate the unit is powered on.

Installing the Input / Output Boards

To install the VW784 video input board / VW884 video output board into the VW3620 video wall processor, follow the steps below.

1. Remove the slot cover on the rear side of the VW3620 video wall processor.

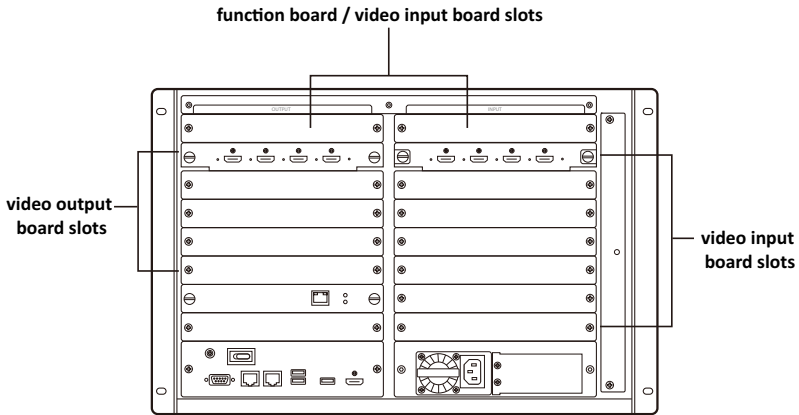

2. Insert the VW784 input board / VW884 output board into the slot of the VW3620.
 - ◆ Install the VW784 video input board(s) to the **video input board slot(s)** or the **function board/video input board slot(s)**.

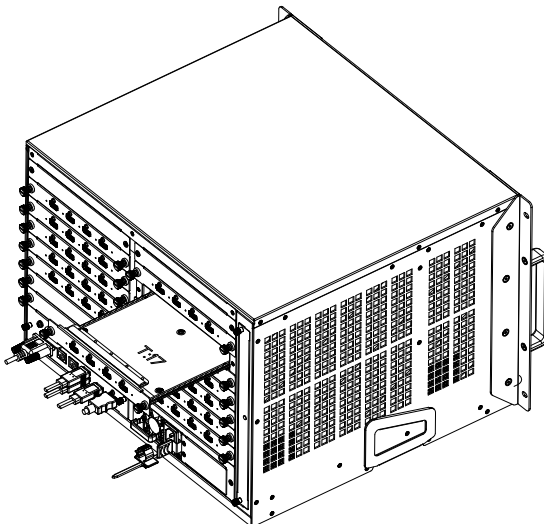

- ◆ Install the VW884 video output board(s) to **video output board slot(s)**.

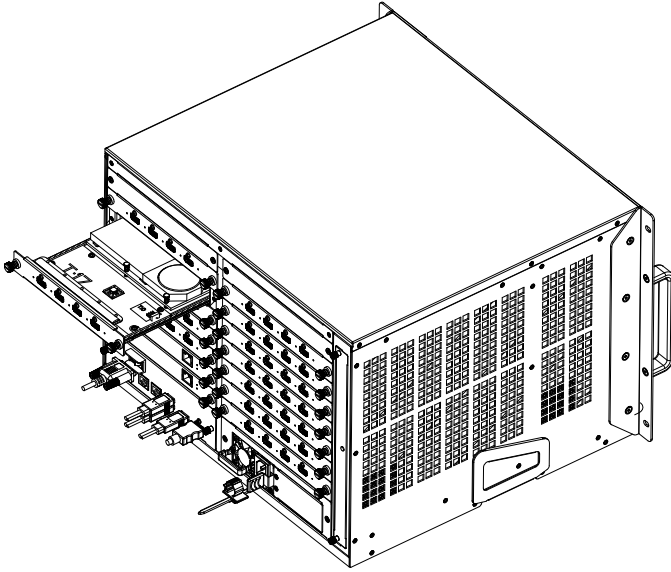

3. Give a little push to get the VW784 video input board / VW884 video output board till it is completely seated in the slot.
4. Apply force to each thumb screw head till it is in place, and then tighten the thumb screw by turning it clockwise.

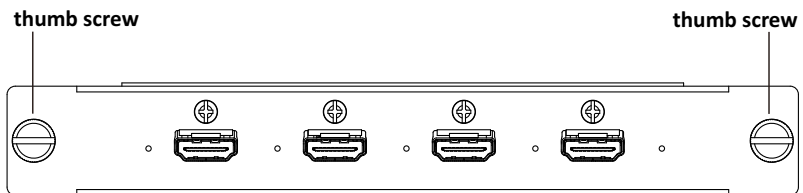

5. Repeat the above steps to install additional I/O boards.

To remove the VW784 video input board / VW884 video output board:

1. Alternately loosen each thumb screw.
2. Hold the two thumb screws and then gently pull out the VW784 input board / VW884 output board.

Rack Mounting

The VW3620 Video Wall Processor can be mounted in a 19" (1U) system rack. For the most convenient front panel operation at the local site, mount the unit at the front of the rack, as follows:

1. Position the unit in the front of the rack, and align the holes of the unit's built-in mounting brackets with the holes in the rack.
2. Use screws to attach the unit to the rack.

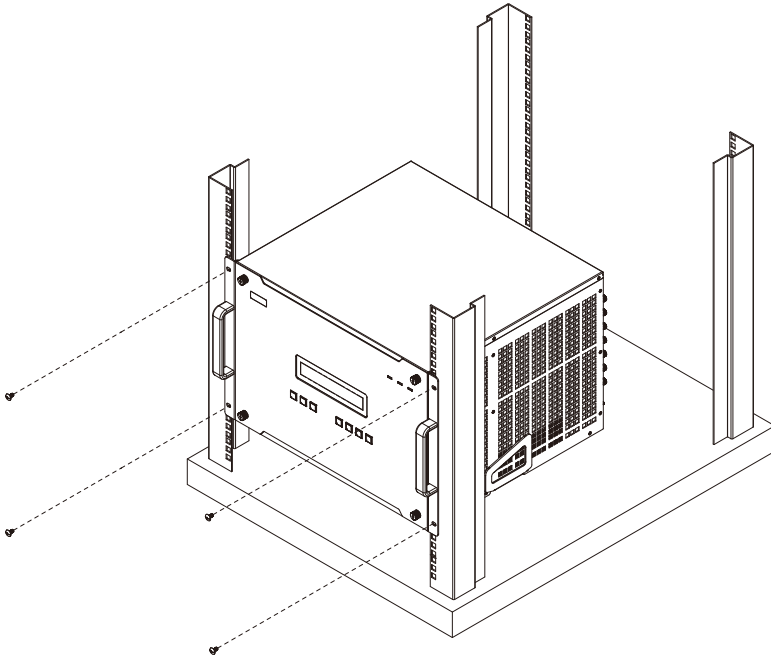

Note: To ensure the VW3620 has sufficient air flow, do not stack items around the unit. Proper air flow ensures safe operation and prevents the unit from overheating.

Mounting with Brackets

You can also use mounting brackets to install the VW3620, as shown below.

Note: The Easy Installation Mounting Kit is not included with the package. To purchase a mounting kit please contact your dealer.

1. Screw the mounting brackets to the rack, as shown in the diagram.

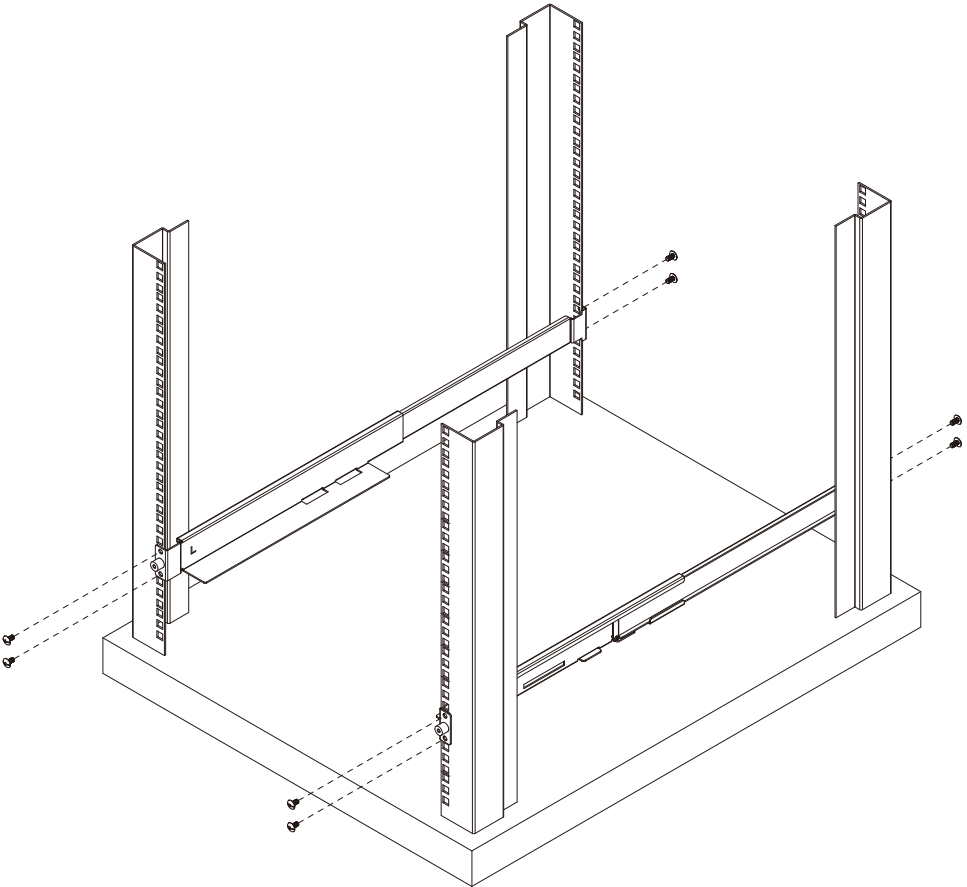

2. Push in and lock the recessed handles, and then slide the unit along the brackets.

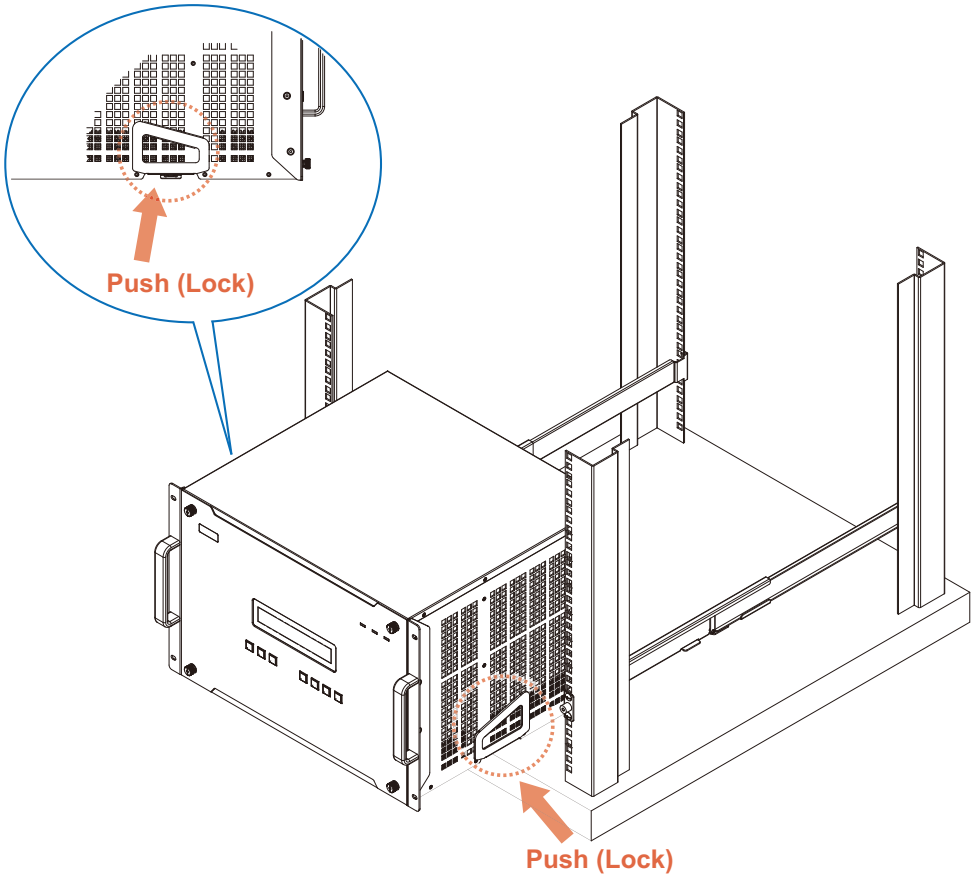

3. Screw the front panel to the rack.

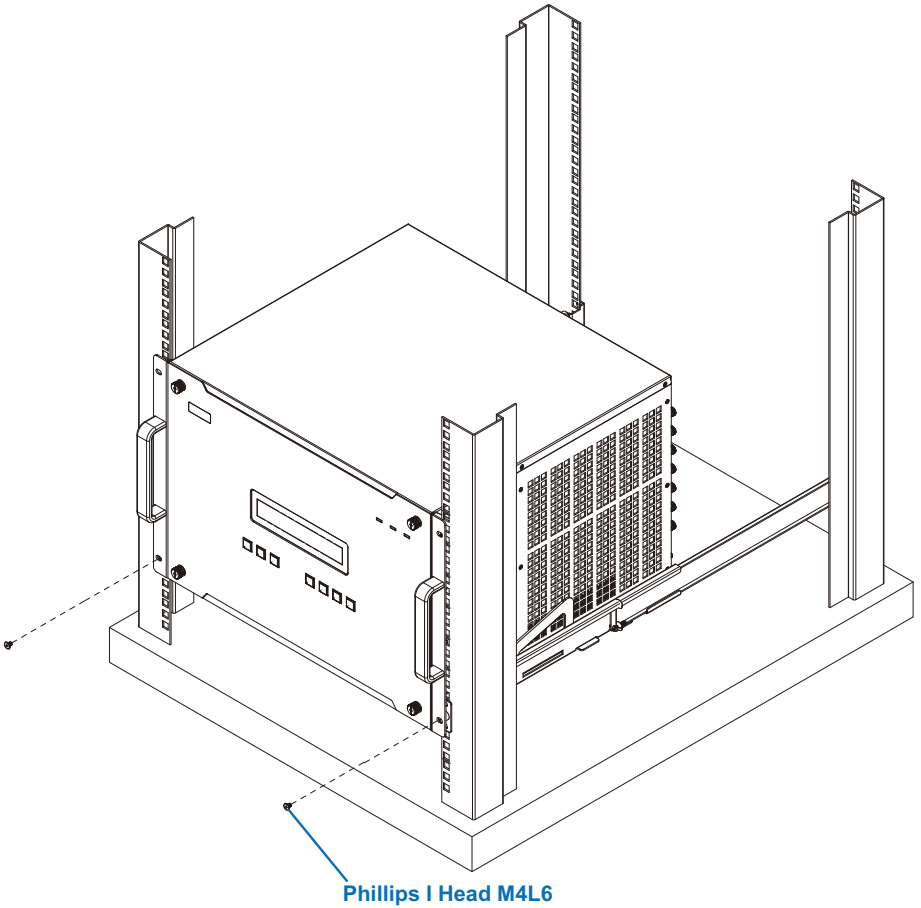

Note: To ensure the VW3620 has sufficient air flow, do not stack items around the unit. Proper air flow ensures safe operation and prevents the unit from overheating.

This Page Intentionally Left Blank

Chapter 3

Front Panel Operation

Overview

The Video Wall Processor installation can be configured and operated locally via the VW3620 front panel LCD and pushbuttons.

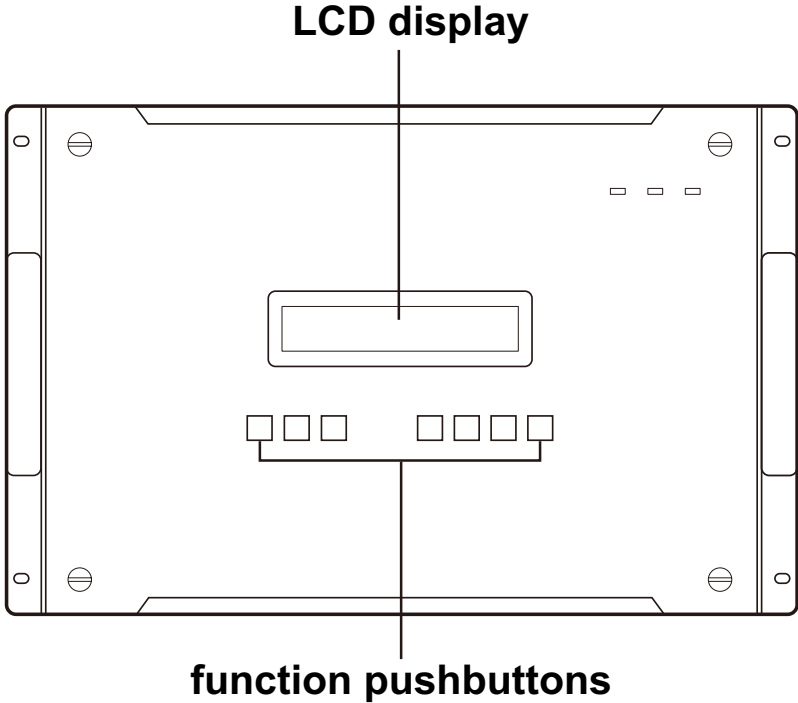

Front Panel Pushbuttons

The VW3620 front panel has easy-to-use pushbuttons for selecting which video source shows on which display. Please note the following front panel button operations:

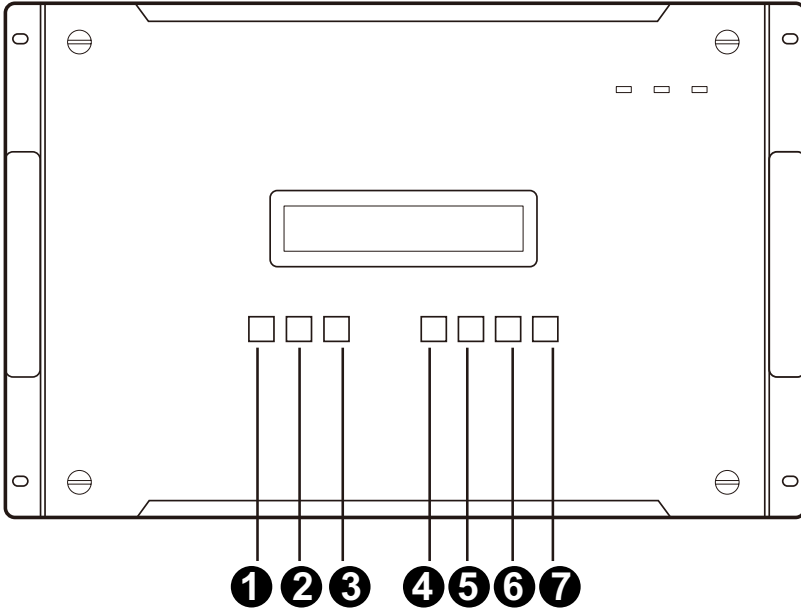

No.	Button	Description
1	Local Output	To configure and preview the content through the HDMI-enabled display connected to the unit's system HDMI local output port
2	Up	To work as the navigation button to scroll through the options listed on the on-screen display
3	Down	To work as the navigation button to scroll through the options listed on the on-screen display
4	Profile	To view, load, and apply the profile(s) that you set in the Web GUI
5	Menu	To enter the main menu screen
6	ESC	To cancel an option or go back to the previous menu screen
7	Enter	To confirm the selection

Front Panel LCD

The VW3620 features an LCD display for convenient configuration. This allows you to perform operations such as viewing the IP settings, configuring the settings of EDID/OSD/ network, selecting security settings, and loading/saving connection profiles. If the VW3620 has been configured to require a password for local operation, you need enter the 4-digit password to unlock the LCD display first. See *LCD Password*, page 32 for how to unlock the password-protected LCD display.

Standby Mode

If the unit is not actively being used, it enters standby mode. To wake up the unit, follow the on-screen instruction to press the **Enter** button, and the unit will be woken up and the LCD display enters the idle screen.

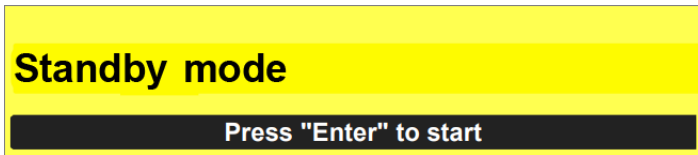

Idle Screen

When the unit is not performing any function, the idle screen is displayed with the following information shown on it:

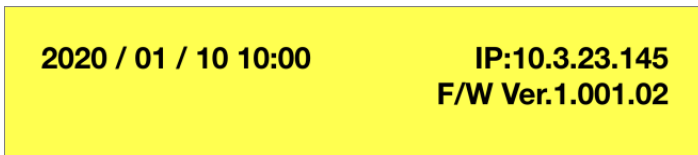

- ◆ **Date & Time**
The current date and time. You can change the setting through the VW3620 Web GUI.
- ◆ **IP Address**
The IP address of this unit. Open a supported browser on the PC which connects to the network the same with this unit, and enter this IP address to log in to the Web GUI for further configurations.

- ◆ **Firmware Version**

The current firmware version installed on the unit. To upgrade the firmware, please go to the main menu screen > F/W upgrade. See *F/W upgrade*, page 41 for details.

When the LCD display is locked, a lock icon is displayed on the upper-left corner of the screen. To leave the locked idle screen, follow the on-screen instruction to press any button to start, enter your password to continue if a password is required, and finally press the **Enter** button to unlock. If no password is required, simply press any button and then the **Enter** button. See *LCD Password*, page 32, for details.

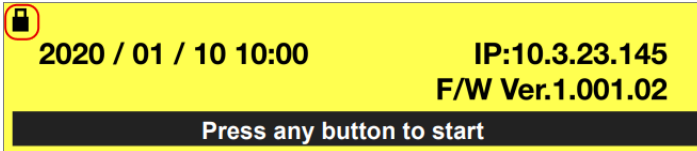

LCD Password

By default, the password protection is disabled. Please press any button to start, and then press the **Enter** button to unlock the LCD display.

If the password protection is enabled, do the followings to enter a 4-digit password to unlock the on-screen display:

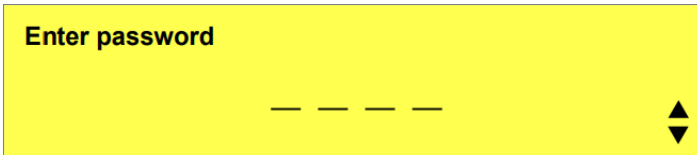

1. Press any button to start, and you will enter the screen that requires you to enter the password.
2. Input your password using the **Up** or **Down** buttons to cycle through the digits. Once the digit is selected, press the **Enter** button to advance to the next digit.

Note: To clear the current digit and go back to the previous digit, press the **ESC** button.

3. Press the **Enter** button to submit the 4-digit password to unlock the LCD display.

-
- Note:** 1. The VW3620 password can be any four digit combination between 0000 to 9999.
2. If you enter an incorrect password, the Incorrect Password screen shows up. Press the Enter button to return back to the enter password screen and try again.



Menu

Press the **Menu** pushbutton to access the main menu screen and use the navigation buttons (the **Up** arrow or the **Down** arrow) to cycle through the menu options as illustrated below:

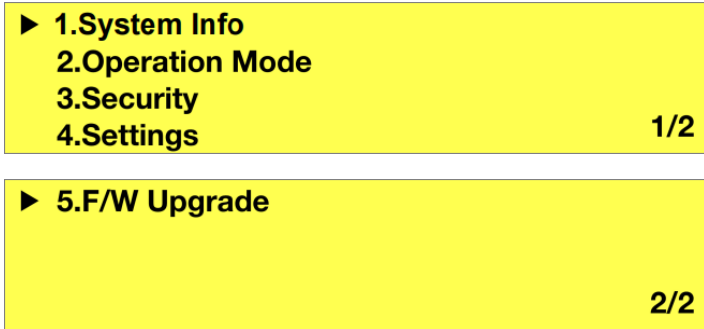

Menu Option	Description
System Info	Shows the system information of this VW3620.
Operation Mode	Configures the input source and the output layout.
Security	Configures the password protection for the LCD display.
Settings	Configures the unit's settings of the EDID mode / OSD / network.
F/W Upgrade	Upgrade the firmware of the VW3620 through local operation.

System Info

On the main menu screen, use the navigation buttons to select System Info and press the **Enter** button to enter the system info screen, the following information are listed:

- ◆ IP address
- ◆ Submask
- ◆ Gateway
- ◆ Firmware version
- ◆ Model name
- ◆ Manufacturer

Press the navigation buttons to switch between page 1 and page 2. Press the **Enter** button or the **ESC** button to return back to the main menu screen. To change the unit's IP address, the submask, and the gateway, please go to the main menu screen > Settings > Network. See *Network*, page 40 for details.

Operation Mode

On the main menu screen, use the navigation buttons to select Operation Mode and press the **Enter** button to enter the submenu to select the zone to be configured, and depending on the mode the unit currently applies, you may enter the submenu(s) as the table below shows:

Mode	Submenu(s) / Action(s)		
Video Wall Mode	Change Input	Select the <i>window</i> to be edited	Select the <i>input source</i>
	Resolution		
	Background	Background	Default
			Black the uploaded image(s)
Load from USB Storage			
Independent Mode	Change Input	Select the <i>output display</i> to be edited	Select the <i>input source</i>
	Resolution	Select the <i>output display</i> to be edited	Select the <i>resolution</i>

Press the **Enter** button or the **ESC** button to return back to the previous page. Security

Enter the submenu of Security, and you can further configure the password-related settings for the VW3620.

- ▶ **1.Mode: Auto Lock with Password**
- 2.Time out: 1min**
- 3.Change Password**

Mode

The VW3620 offers the following three security modes for user to select:

- ▶ **1.Never Lock**
- 2.Auto Lock**
- 3.Auto Lock with password (selected)**

Mode	Description
Never Lock	The VW3620's LCD display is not locked and it can be operated by any user.
Auto Lock	The VW3620 will automatically lock the LCD display when it has been unlocked for a certain period of time which can be set through the main menu > Security > Timeout .
Auto Lock with Password	The VW3620 will automatically lock the LCD display when it has been unlocked for a certain period of time which can be set through the main menu > Security > Timeout . To unlock the LCD display, you need to input the 4-digit password. See <i>LCD Password</i> , page 32.

Please note that the current selected mode is marked with the word selected.

Timeout

The VW3620 LCD display enters the idle screen (see *Idle Screen*, page 31) after it times out. On the Timeout option screen, select between 1 minute, 3 minutes, and 10 minutes to determine how long the LCD display stays unlocked. The current selected option is marked with the word selected.

Change Password

Follow the steps below to change the 4-digit password for unlocking the VW3620's LCD display:

1. Enter the old password by using the navigation buttons (the **Up** arrow or the **Down** arrow) to cycle through the digits. Once the digit is selected, press the **Enter** button to advance to the next digit. You can clear the current digit and go back to the previous digit by pressing the **ESC** button.

Old Password: * * * *

New Password:

Confirm New Password: ▲▼

Note: The flashing asterisk (*) indicates the current position that will respond to input the digit.

2. Submit the old password by pressing the **Enter** button, and you will advance to the next step to input your new password.

If the old password you just submitted is incorrect, a warning message as the figure below shows up. Follow the on-screen instruction to press the **Enter** button to go back to the step to input the old password again.

Incorrect Password

Press "Enter" to close dialog

3. Input your new password and then press the **Enter** button to go to the next step to confirm the new password. Confirm the new password by inputting it again and then press the **Enter** button to submit your change.

Old Password: * * * *

New Password: * * * *

Confirm New Password: * * * * ▲▼

If the confirm password you input does not match the new password, a warning message shows up. Press the **Enter** button to close the message and return back to the step to input the new password again.

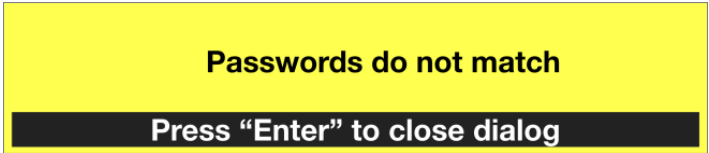

4. The password is successfully changed. Press the **Enter** button to go back to the main menu screen.

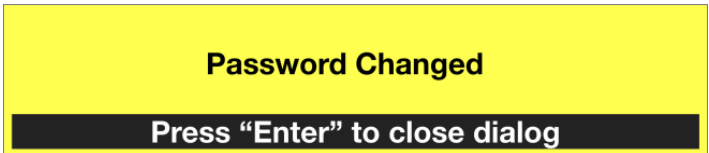

Settings

The baud rate, EDID, OSD, and network features are adjusted from the Settings screen.

Baud Rate

Use the navigation buttons (the **Up** arrow or the **Down** arrow) to cycle through the options and press the **Enter** button to make your selection. The baud rate options are:

- ◆ 9600
- ◆ 19200
- ◆ 38400
- ◆ 115200

Please note that the current selected baud rate is marked with the word selected.

EDID Mode

EDID (extended display identification data) is used to apply a preset video configuration (EDID Mode), which utilizes the best resolution across different monitors. To adjust the EDID mode, do the following:

1. Go to the main menu screen > Settings > EDID Mode.
2. Select the EDID mode from the options:

EDID Option	Description
Port 1	EDID data read from port 1 is passed to all video sources. The system will enforce the Default EDID setting if port 1 is not occupied
Default	ATEN's default EDID data is passed to all video sources by default when the system is powered on.
Customized	This mode allows user-defined EDID configurations for optimum output.

Please note that the current selected EDID mode is marked with the word selected.

OSD

The On-Screen Display or OSD feature enables the information about the input source, the output port, and the window(s) to appear on the display device's screen. To configure the OSD settings, do the following:

1. From the Settings screen, use the navigation buttons (the **Up** arrow or the **Down** arrow) to select OSD and press the **Enter** button to access its submenu.
2. Select to enter the option menu of Output ID, Input ID, and Window ID respectively, and choose whether to show or hide the ID. You can set to reveal or conceal all the 3 ID information at a time by directly selecting Show All or Hide All on the OSD submenu.

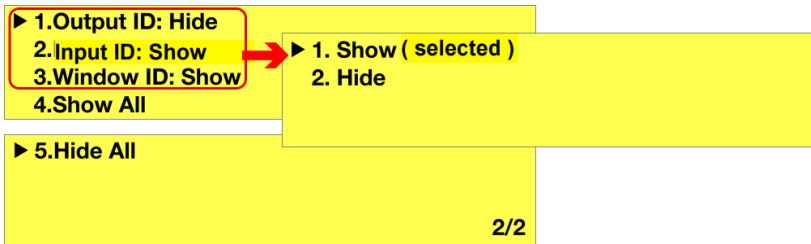

Network

To change the unit's IP address, the submask, and the gateway, do the followings:

1. Go to the main menu screen > Settings > Network.

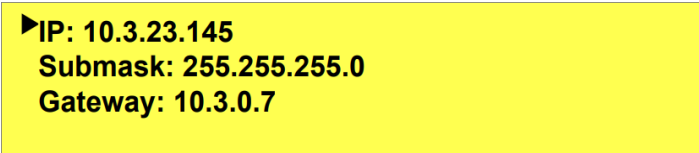

▶ **IP: 10.3.23.145**
Submask: 255.255.255.0
Gateway: 10.3.0.7

2. Select to access the setting screen of the item to be changed and the screen displays the current IP address / submask / gateway information.

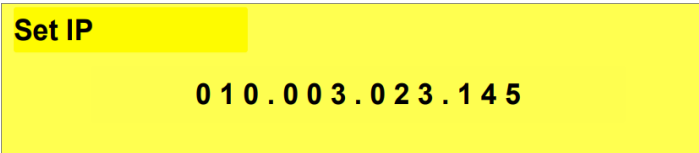

Set IP

0 1 0 . 0 0 3 . 0 2 3 . 1 4 5

3. The flashing digit identifies the one you are changing. To modify the parameters:
 - ◆ Use the navigation buttons (the **Up** arrow or the **Down** arrow) to cycle through the digits.
 - ◆ Once the digit is determined, press the **Enter** button to advance to the next digit.
 - ◆ Use the **ESC** button to go back to the previous digit without deleting the current one.
 - ◆ To return to previous page, press the **ESC** button when editing the first digit, or long press on the **ESC** button when being at any digit position.

-
- Note:**
1. The address consists of four decimal numbers whose range is from 0 to 255, and the first digit of each decimal numbers only ranges from 0 to 2.
 2. If the numbers you configured exceeds the limitation of 255, it will be automatically modified to be 255.
 3. If the address you set starts with 000, it will be automatically modified to be 001.
-

- After all the four numbers are determined, press the **Enter** button to submit your change, and a confirmation screen appears. Use the navigation buttons to select the option Save your changes and then press the **Enter** button to continue.

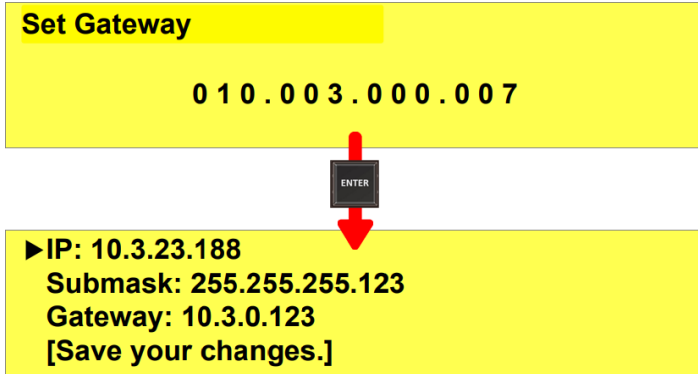

- Press the **Enter** button again to close the dialog that reminds you the change is saved and return to the Network screen.

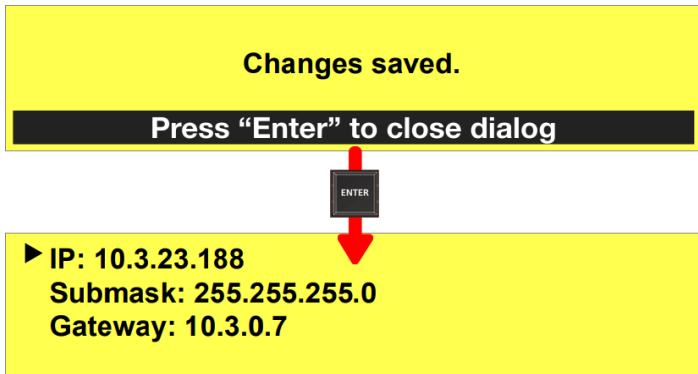

F/W upgrade

To upgrade the firmware of the VW3620 video wall processor through local operation:

- Connect a USB drive which contains an up-to-date firmware file to the USB port on the rear side of the unit. See *USB Type-A ports*, page 8.

2. Access the main menu screen > F/W Upgrade. Press the **Enter** button to load the firmware file from the connected USB drive.

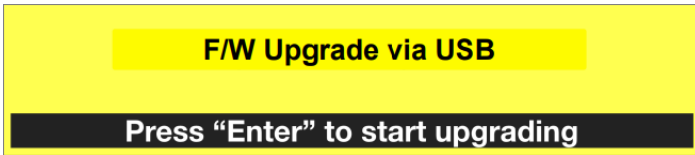
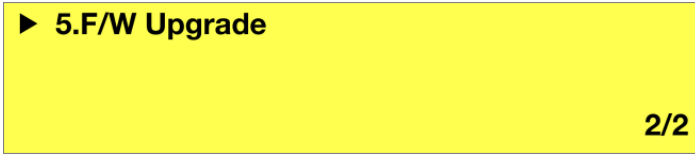

3. The unit starts to load the firmware file and detect whether the firmware version is valid.
 - ◆ If the firmware file is invalid, a message screen shows up to remind you to check the firmware file. Simply press the **Enter** button to close the dialog and try again.

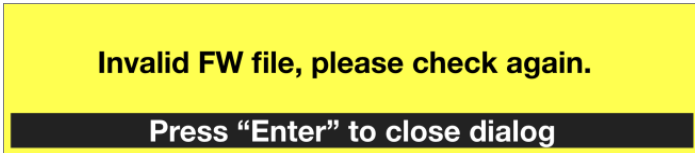

- ◆ If the firmware file is detected and confirmed valid, the unit starts to upgrade its firmware. During the upgrade process, do not power off the VW3620.

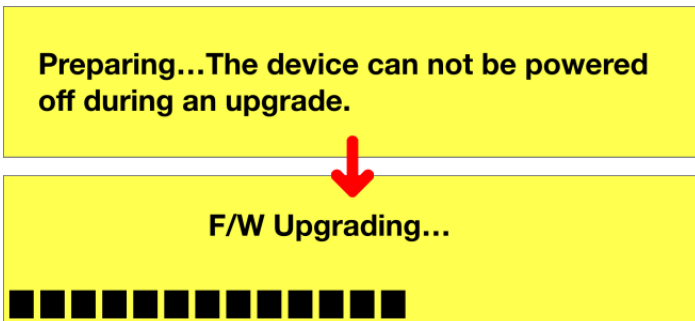

4. Once the upgrade is completed, the LCD display shows the message as illustrated below. Press the **Enter** button to return to the unlocked idle screen.

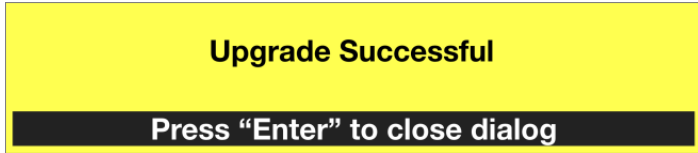

Local Output

The pushbutton **Local Output** allows you to monitor the video input signals and the video wall layouts in real time through the display device connected to the unit's system HDMI local output port.

Press the **Local Output** button, and the LCD display shows the current selected mode and its related feature options as illustrated below:

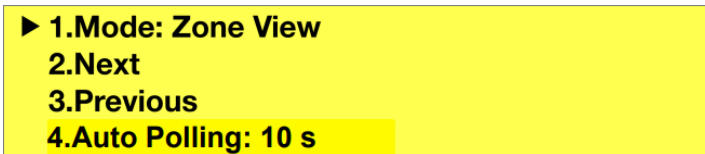

Item	Description
Mode	Enter the subscreen of Mode to select the mode you'd like to check: <ul style="list-style-type: none"> ◆ Zone View ◆ Single Source View ◆ Array Source View
Next	Switch to the next zone or video source. Please note that this function is unavailable in Array Source View.
Previous	Switch to the previous zone or video source. Please note that this function is unavailable in Array Source View.
Auto Polling	To have a playback of the zones or video sources. Please note that this function is unavailable in Array Source View.

On the **Local Output** menu screen, you can do the followings:

- ◆ Use the navigation buttons (the **Up** arrow or the **Down** arrow) to cycle through the menu options.
- ◆ Press the **Enter** button to access the selected option's submenu screen, or take the selected action.
- ◆ Press the **ESC** button to return to the previous page.

Zone View

By selecting Zone View, you will see the output screen similar to the following:



Select Next / Previous using the navigation buttons and press the **Enter** button to switch to the next or previous zone. Enter the option menu of Auto Polling to determine the duration each zone is played.

- ▶ 1.Off
- 2.10s
- 3.30s
- 4.60s

Single Source View

- ▶1.Mode: Single Souce View
- 2.Next
- 3.Previous
- 4.Auto Polling: 10 s

In Single Source View, the output screen displayed on the display device connected to the unit's system HDMI local output port is similar to the figure below:



Select Next / Previous using the navigation buttons and press the **Enter** button to switch to the next or previous input video source. Enter the option menu of Auto Polling to determine the duration each input video is played.

Array Source View

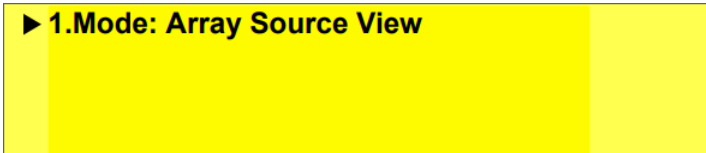

In Array Source View, it displays all your input video sources:

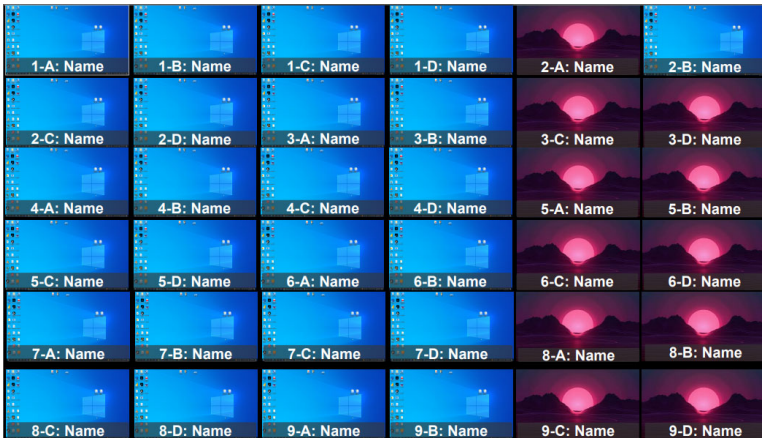

Profile

A profile is a set of settings that defines the input to output connections and configured by users in VW3620 Web GUI.

▶ **Zone A: P1**
Zone B: - -
Zone C: P4
Zone D: P3

Press the **Profile** pushbutton to enter the Profile menu, and select the zone to preview using the navigation buttons and the **Enter** button. The LCD panel displays a list of profiles. Use the navigation buttons to cycle through the profiles, and press the **Enter** button to apply the selected profile.

▶ **P1 (selected)**
P3
P4
P5 1/3

Depending on the arrangement of the display monitors you configured for your zone(s) in VW3620 Web GUI, the preview screen shows on the display device connected to the unit's system HDMI local output port may as the followings:

- ◆ Video Wall



- ◆ Independent Display



Chapter 4

Browser Operation

Overview

The VW3620 can be configured over a standard TCP/IP connection via its built-in Graphical User Interface (GUI). Because it can be accessed from anywhere over a network or the Internet, operators can easily log in via web browser. Security is ensured by password protection and user-configurable time-out. For full details see the sections that follow.

Logging In

To access the Web GUI, type the VW3620's IP address into the address bar of any browser. If a Security Alert dialog box appears, accept the certificate—it can be trusted. The login screen appears:

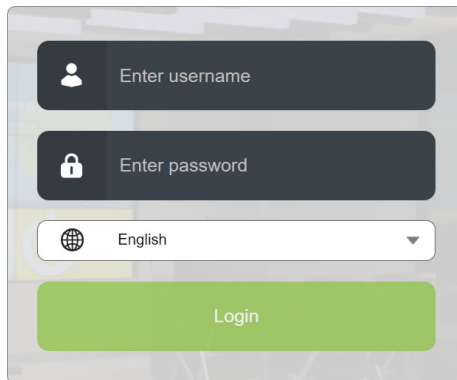

- ◆ For DHCP environment, download IP Installer from ATEN website to your PC and run the IP Installer to get the IP address to log in to the Web GUI.
- ◆ If DHCP is disabled, use the default IP address *192.168.0.60*
- ◆ The default login credentials are *administrator* and *password*.
- ◆ Enter the username and password, then click Login.
- ◆ For the very first time you log in to your VW3620 Web GUI, you are required to change the password. Follow the on-screen instruction to complete the change.

- ◆ Use the drop-down menu to select the display language.

Note: If you have installed a redundant CPU board and connected it to the network using an Ethernet cable, the IP address(es) of CPU 1 and CPU 2 might differ. Run *IP Installer* to obtain the DHCP-assigned address(es).

After successfully logging in to your VW3620 Web GUI, you will enter the Design Mode tab where you can set up the display zone(s).

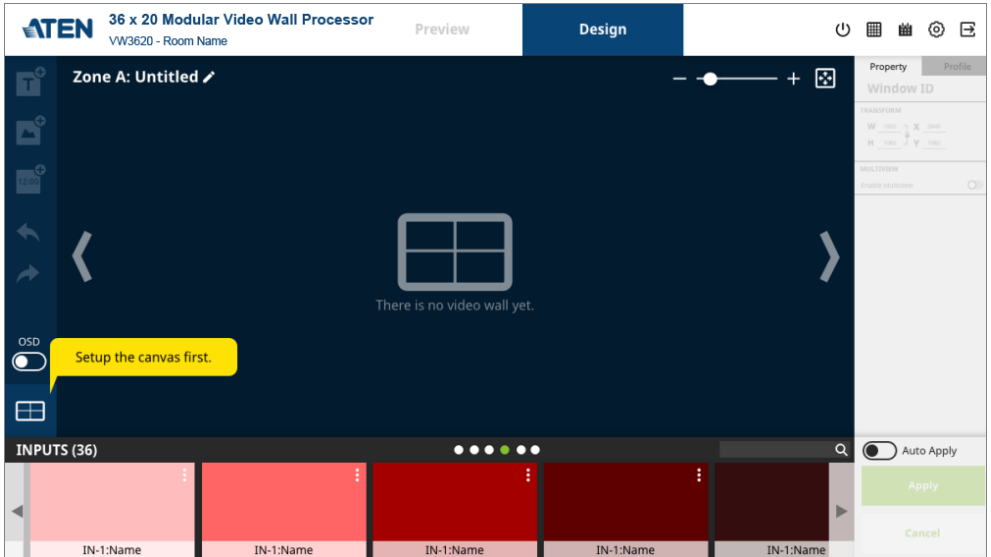



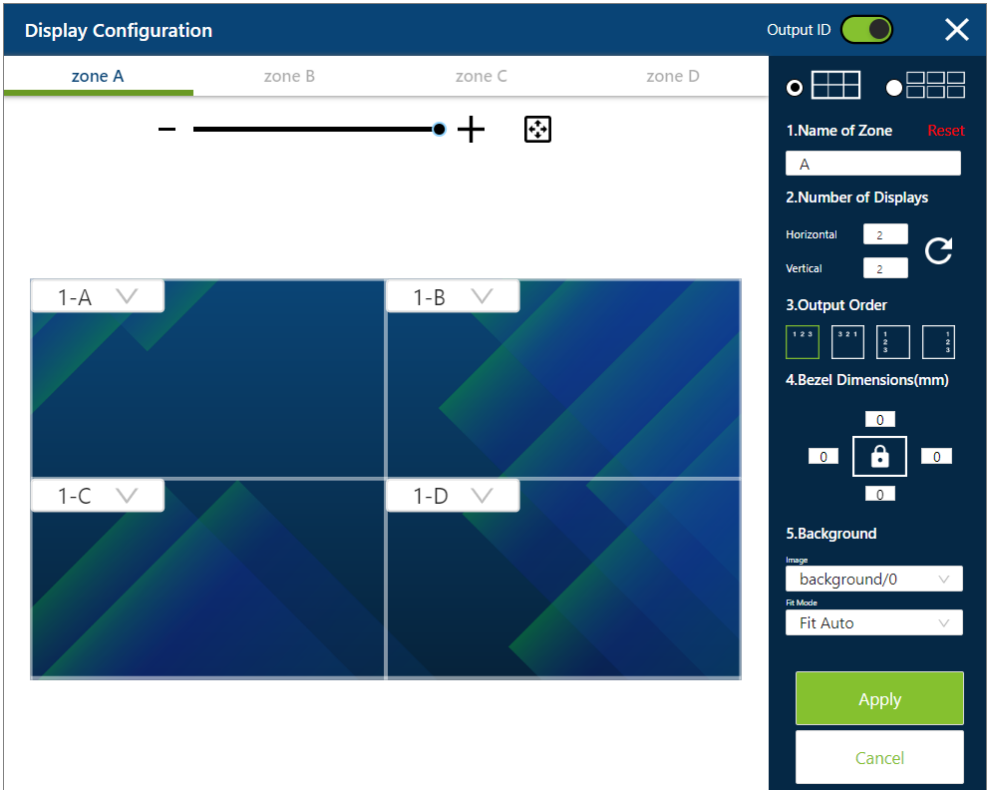

Display Configuration

To get started, click on the Display configuration button  to open the popup window to set up your output display configuration.



1. Click to select the zone you would like to set up.

- ◆ Use the zoom slider  to change the zoom level of the display zone.
- ◆ Use the zoom to fit button  to automatically resize the display zone to fit the configuration area in this popup window.
- ◆ Turn the Output ID switch  on or off to reveal or conceal the output ID.

2. Configure the display monitors settings in the right panel of the popup window.
 - ◆ Use the radio button to select the displays arrangement between Video Wall  and Independent Display .
 - ◆ Define the name for this zone.
 - ◆ Enter the number of the display monitors belong to this zone.
 - ◆ Set the output order of the display monitors.
 - ◆ Configure the bezel dimensions.
 - ◆ Set the background image by using the default image, or setting with no image, or uploading the image from your PC.
 - ◆ Set the fit mode.
 - ◆ Click on the Apply button to complete your settings while closing the popup window without saving any change by the Cancel button.
 - ◆ Click on Reset to restore the settings to the default.
3. From the drop-down menu, select the input video source for each display monitor belongs to this zone.

The further configuration can be proceeded in the Design Mode tab.
See *Design Mode*, page 56.



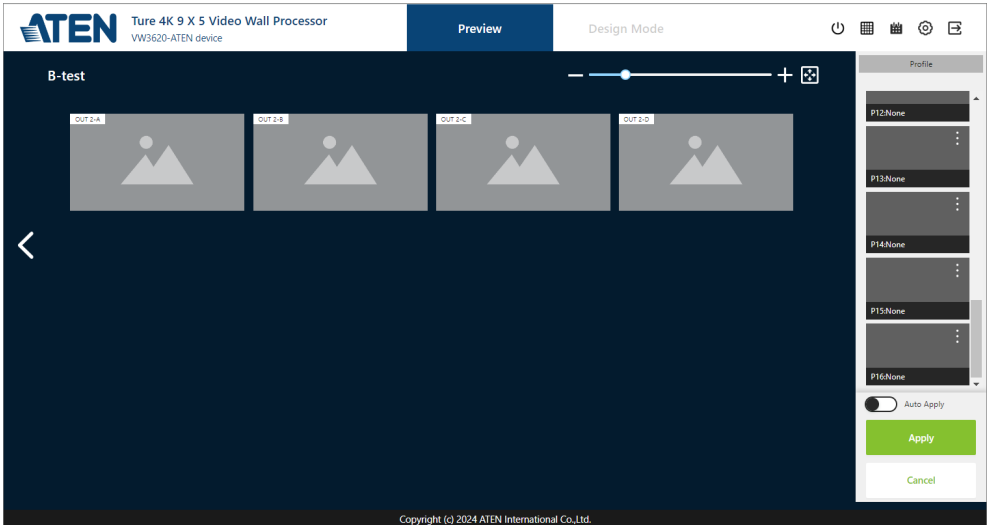

Main Page

After logging in, you will enter the VW3620 Web GUI main page which is divided into three parts—the menu bar (page 54), the Design Mode tab (page 56), and the Preview tab (page 70).



Menu Bar

Use the buttons in the menu bar to perform the following actions:

Button	Control	Description
	Standby	Click to set the VW3620 to standby mode.
	Source Array	Click to set view all the video sources simultaneously.
	Scheduling	Click to enter the page to set the profile playlists that play periodically on specified time frames.
	Settings	Click to access the system settings. Note: This function is only available for the user role, administrator.
	Logout	Click to log out of the VW3620 Web GUI.

Setting the Standby Mode

The standby mode is a low-power mode where the VW3620 operates minimally by stopping all input and output transmissions and logging the user out of the Web GUI.

To enable the standby mode, click on the Standby button from the menu bar in the VW3620 Web GUI.

To disable the standby mode, do one of the following:

- ◆ Press the Enter pushbutton from the device panel. See *Standby Mode*, page 31.

- ◆ Log in to the Web GUI with a valid credential, and wake up the unit by clicking on the screen as illustrated below.

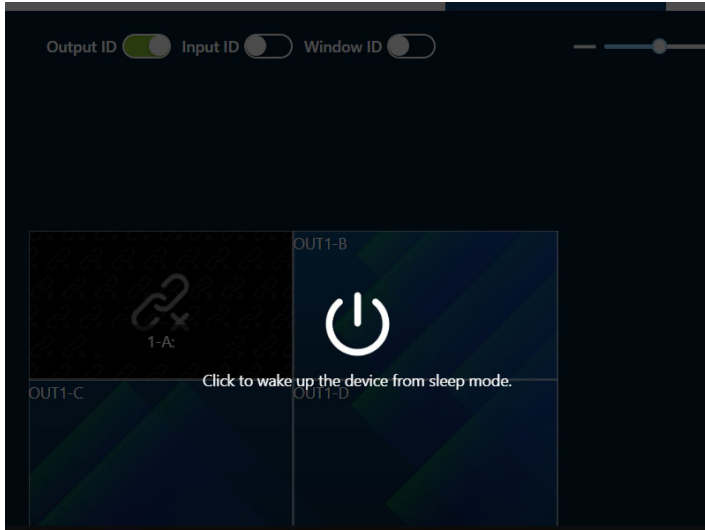

Source Array

Source Array page displays all the video from the connected input source device(s), giving you a glance at all the video source(s) with the input board numbers, the port numbers, and the self-defined port names.

Source Array					
HDCP					
IN 1-A	IN 1-B	IN 1-C	IN 1-D	IN 2-A	IN 2-B
IN 2-C	IN 2-D	IN 3-A	IN 3-B	IN 3-C	IN 3-D
IN 4-A	IN 4-B	IN 4-C	IN 4-D	IN 5-A	IN 5-B
IN 5-C	IN 5-D	IN 6-A	IN 6-B	IN 6-C	IN 6-D
IN 7-A	IN 7-B	IN 7-C	IN 7-D	IN 8-A	IN 8-B
IN 8-C	IN 8-D	IN 9-A	IN 9-B	IN 9-C	IN 9-D

Design Mode

Understanding Display Zones

In your video wall processor application, you may more than one video wall set up—for example, a 2 x 2 video wall, a 4 x 4 video wall, and a single-monitor display, all managed by one VW3620. In this case, you have three display zones.

Understanding Profiles and Profile List

A profile is a set of settings that specifies how video sources will be displayed on one or more video walls. You can create and save your profiles to the Profile List to be conveniently switched via the front panel or the Web GUI.

Interactive Functions on Design Mode Tab

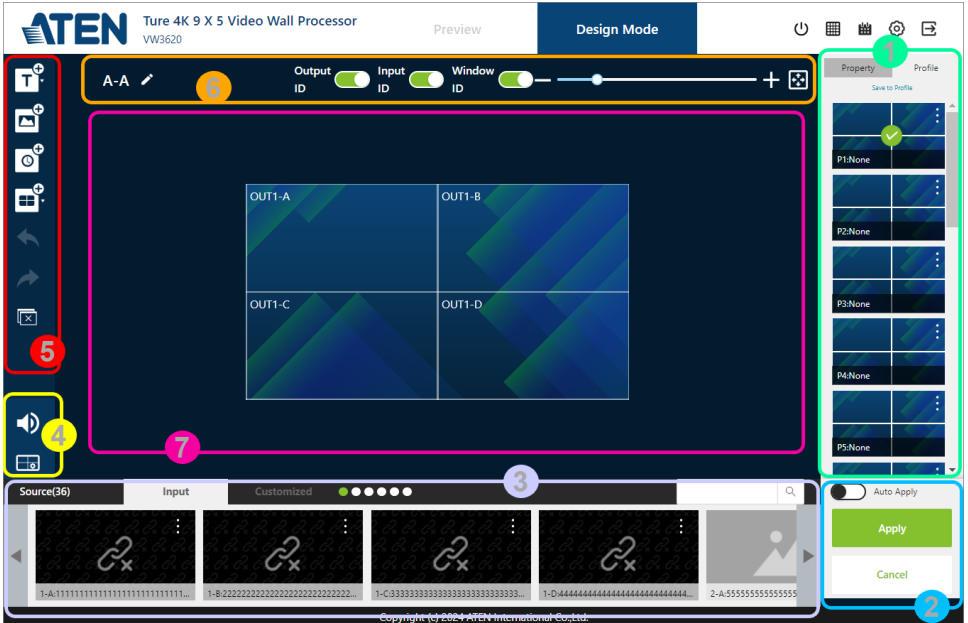

The Design Mode tab is where you can configure the video wall layout and save the layout configuration as a profile for conveniently switching. The Design Mode tab contains the following interactive functions:



1. Profile Panel

The profile panel contains the following 2 tabs:

- ◆ Profile List:
The profile list shows all the profiles, including those are not edited.
- ◆ Property Settings:
The property settings tab shows the property of the displayed item(s) in the profile.
By selecting an item, the property settings display its property. User

can edit the property or click on the show  / hide  button to reveal or conceal the selected item.

2. Profile Playing Functions

User can determine whether to play the profile shown on the canvas through the functions listed below:

Item	Description
Auto Apply	Enable the auto apply switch and once you open a profile, it automatically applies to your video wall.
Apply	Click on the Apply button to play the profile.
Cancel	Discard your changed settings.



3. Video Source List

The video source list contains 2 tabs, Input and Customized. The Input tab displays all the input video sources from the connected source devices while the Customized tab shows the user-defined video source(s). User can drag and drop the video source to be displayed to the canvas, and release it to the display area to have it placed.

- ◆ To quickly and easily find the video source you need, input the keyword into the search bar, and the video(s) whose input port name fulfills the keyword shows up.
- ◆ By enabling the function Auto Fit Frame, the video automatically scales to fit inside the size of the display frame.

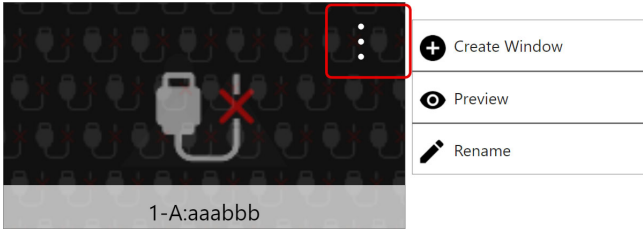
- ◆ By clicking on the more button of a video source (both Input and Customized), an option menu is opened for you to choose an action to take:



Action		Description
	Create Window	To create a window on the canvas that displays this video source.
	Preview	To open a popup window that display this video source.
	Rename	To rename this video source.

Note: As to the management of the customized video source, refer to *Multiview Window Management*, page 63.

4. Audio & Display Configuration Buttons

Click on the Audio Control button  to open the Audio Control popup window for configuring the output audio:

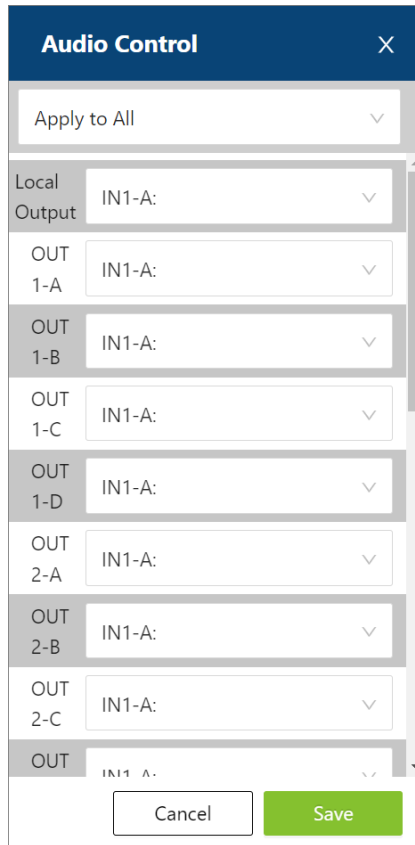

Audio Control	
Apply to All	
Local Output	IN1-A:
OUT 1-A	IN1-A:
OUT 1-B	IN1-A:
OUT 1-C	IN1-A:
OUT 1-D	IN1-A:
OUT 2-A	IN1-A:
OUT 2-B	IN1-A:
OUT 2-C	IN1-A:
OUT	IN1-A:
Cancel Save	

- ◆ Use the drop-down menu to apply options to all output ports.
- ◆ Set for each output port by selecting Mute or the input audio source from the drop-down menu.
- ◆ Click on the Save button to adopt the changed settings.

Click on the Display Configuration button  for arranging the displayed layout for each zone.



Display Configuration
Output ID ● ✕

zone A
zone B
zone C
zone D

-

+
⊞

1-C ▾	1-B ▾	3-B ▾
1-D ▾	2-A ▾	2-B ▾
2-C ▾	2-D ▾	3-A ▾

1. Name of Zone Reset
2. Number of Displays
 Horizontal
 Vertical ↻
3. Output Order









1 2 3	3 2 1	1 2 3	1 2 3
-------	-------	-------	-------
4. Bezel Dimensions(mm)

0	🔒	0
0	0	0
5. Background
 Image
 Fit Mode

Apply
Cancel

5. Canvas Toolbar







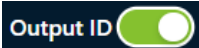

The toolbar contains the 7 tools:

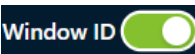
Item	Description
	<u>Add Text</u> Click the button to open the options menu to select whether to add normal text  or to add the scrolling text  .
	<u>Add Image</u> Click the button to browse the image file to be uploaded.
	<u>Add Clock</u> Click to open the popup window to configure the details about the clock to be added.
	<u>Create Multiview Window</u> Click the button to open the option menu to select the window type and open the <i>Multiview Editor</i> popup to edit the input sources.
	<u>Undo</u> Click the button to reverse the action you just took.
	<u>Redo</u> Click the button to reverse your last undo action.
	<u>Clear All</u> Click on the button to remove all the videos you set to display.

6. Layout Configuration Tools

The layout configuration tools offer the following functions:

Item	Description
	Click the button and you can rename the zone name you defined in the Display Configuration popup.
	Turn on the Output ID switch to show the output port ID on the display(s).

Item	Description
	Turn on the Input ID switch to show the input port ID on the display(s).
	Turn on the Window ID switch to show the window port ID on the display(s).
	The Bring to Front button appears only when an item is selected to be edited. Click on it to bring the selected item to the front of the stack.
	The Bring Forward button appears only when an item is selected to be edited. Click on it to bring the selected item one layer up.
	The Send Backward button appears only when an item is selected to be edited. Click on it to move the selected item one layer down.
	The Send to Back button appears only when an item is selected to be edited. Click on it to send the selected item to the back of the stack.
	The Remove button appears only when an item is selected to be edited. Click on it to delete the selected item.
	The zoom slider is used to zoom in or out the display zone. Drag the slider to change the zoom level.
	Click on the zoom to fit button to change the zoom level and automatically resize the display zone in the canvas area.

7. Canvas Area

Canvas area is where you design the display zone. If you have more than one zone, you can easily switch to other zone by the next / previous buttons located on the 2 sides of the canvas.

Multiview Window Management

Create a Multiview Window

To create a multiview window, do the followings:

1. From the canvas toolbar, click on the Create Multiview Window button



to open the option menu to select window type.

2. The 2 X 2 Multiview Editor / 4 X 4 Multiview Editor popup window shows up. Check the checkbox(es) of the slot(s) to determine which input sources are available for this multiview window.

2 X 2 Multiview Editor

Input Source: Slot 1 Slot 2 Slot 3 Slot 4 Slot 5 Slot 6 Slot 7 Slot 8 Slot 9

1	2
3	4

3. Drag and drop the input source to the layout editing area, and release it to have it placed.

- Click on the OK button, and the newly-created multiview window is displayed on the canvas now.

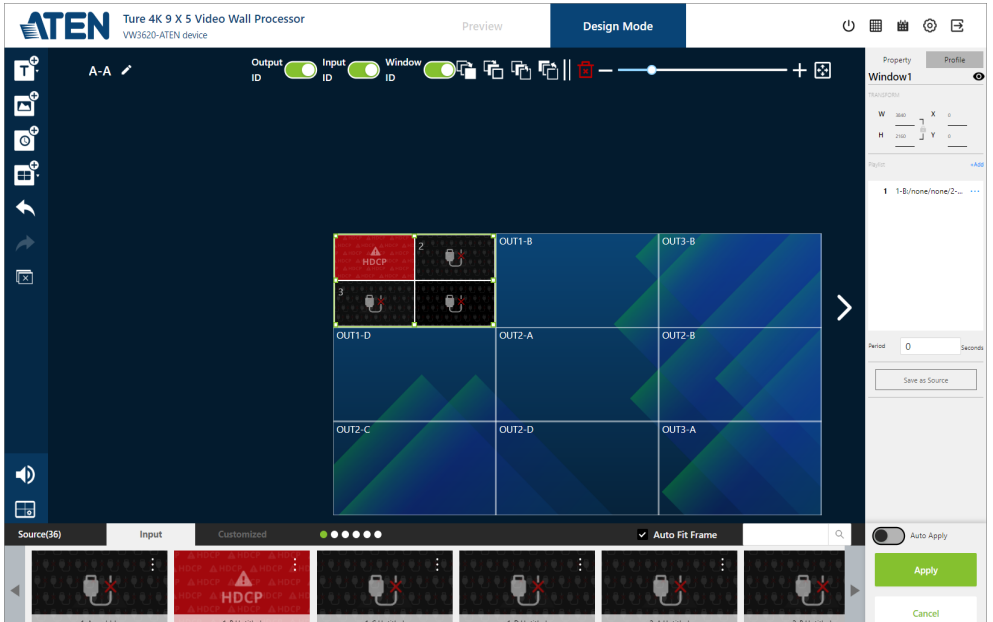

Configure a Multiview Window

To configure an existed multiview window:

1. On the canvas, click to select the multiview window to be edited.
2. From the profile panel, make change of this multiview window's property:

◆ Click on the show  / hide  button to reveal or conceal this window.

◆ To resize the window by inputting the width and the height.

◆ To move the window, drag and drag the window to place it to your preferred position, or enter the absolute position (x and y coordinates).

◆ To add more multiview contents, click on +Add to open a 2 X 2 Multiview Editor / 4 X 4 Multiview Editor popup window, and do the followings:

a) Check the checkbox(es) of the slot(s) to determine the available input sources.

b) Drag and drop the input source to the layout editing area, and release it to have it placed.

c) Click on the OK button to add the multiview content to the playlist.

◆ To edit an existed multiview content:

a) Hover the cursor over the more button  next to the multiview content to be edited to expand the option menu.

b) Select Edit to open the 2 X 2 Multiview Editor / 4 X 4 Multiview Editor popup window.

c) Make change of it and click on the save

button to save your changed settings.

- ◆ To remove an existed multiview content from the playlist, hover the cursor to the more button next to the multiview content to be deleted, and select Delect from the option menu.
- ◆ Enter the duration that determines how long each multiview content is played.

Customized Video Source

To save a multiview window as a customized video source:

1. On the canvas, click to select the multiview window to be edited.
2. The property tab is shown on the profile panel. Click on the Save as Source button to continue.
3. Enter a name fo this customized video source, and then click the OK button to create it.

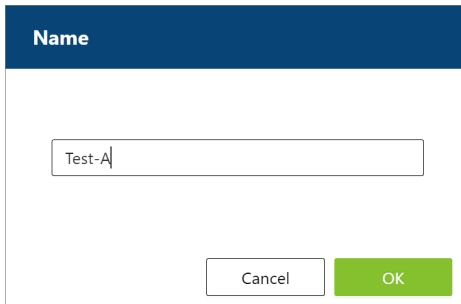

The image shows a dialog box with a dark blue header containing the word "Name" in white. Below the header is a white text input field with a thin border, containing the text "Test-A" and a vertical cursor. At the bottom of the dialog box, there are two buttons: a white "Cancel" button with a thin border and a green "OK" button with a thin border.

Profile Management

Creating a Profile

To create a profile:

1. Enter the Design Mode tab.
2. (Optional) Follow the steps as *Display Configuration*, page 51 describes to set the zone(s) and the display monitors.
3. Use the interactive functions to configure the display zone(s).
See *Interactive Functions on Design Mode Tab*, page 56.
4. Once you finish the layout design, click on Save to Profile in the profile panel to open the Save to Profile popup.

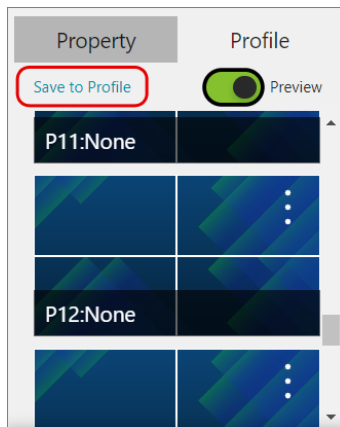

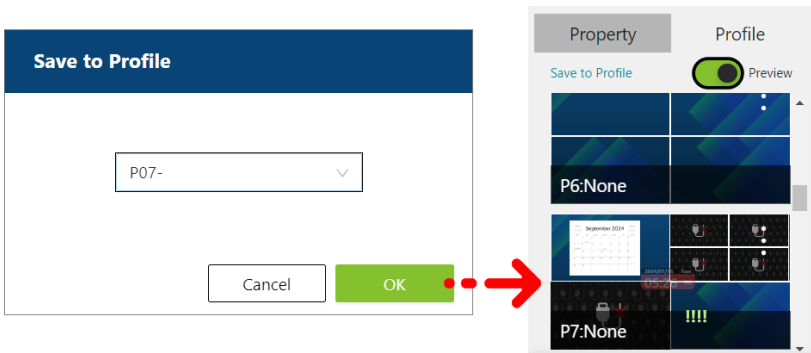

5. Select a profile item from the drop-down menu and click on the OK button to save it.



Edit a Profile

To edit an existed profile:

1. Click on the more button   of the profile to be edited to open the option menu, and select Open.

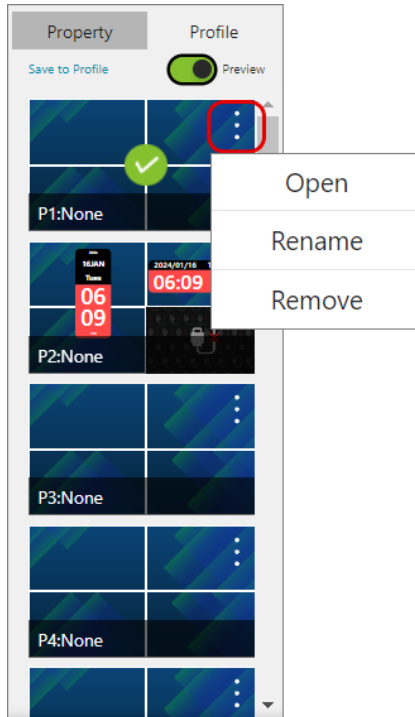

2. The profile is now shown in the canvas area. Use the interactive functions to make change of it, and click on Save to Profile in the profile panel to open the popup window. Select the profile item from the drop-down menu, and click the OK button to save your change(s).

Apply a Profile

To implement a profile to display the video configuration to the connected output devices, do the followings:

1. From the profile panel, click on the more button  of the profile to be played to open the option menu, and then select Open. Or drag the profile to be edited to the canvas area and release it to open this profile.

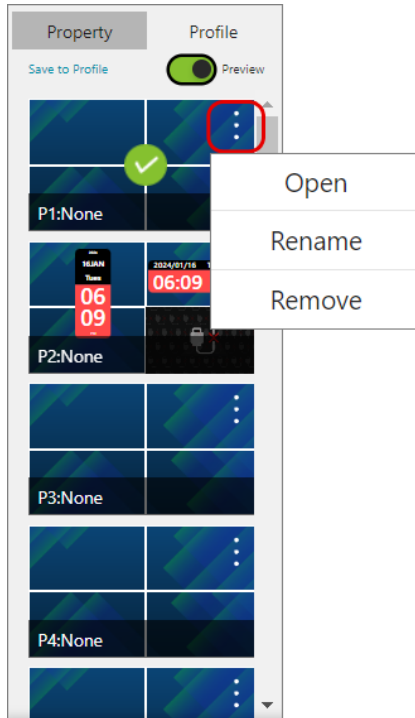

2. Click on the Apply button beneath the profile panel to implement the current-opened profile.

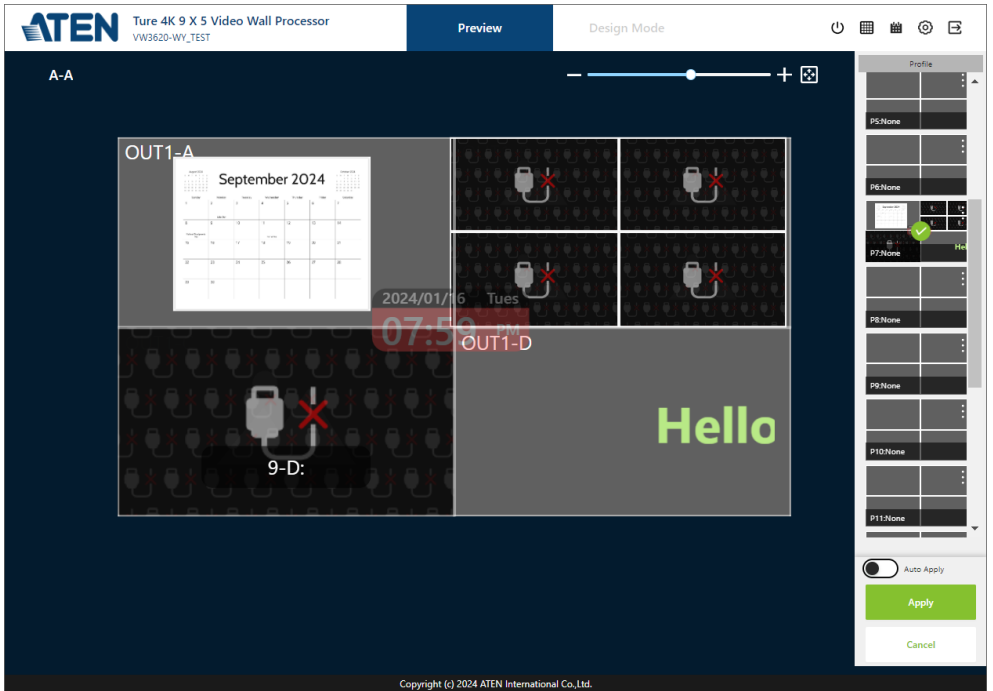

Preview

To view the live streaming of the implementing profile output to the display device(s), please go to the Preview tab.



Delete a Profile

To delete an existing profile:

1. From the profile panel, find the profile to be deleted, and click on its more button   to open the option menu.

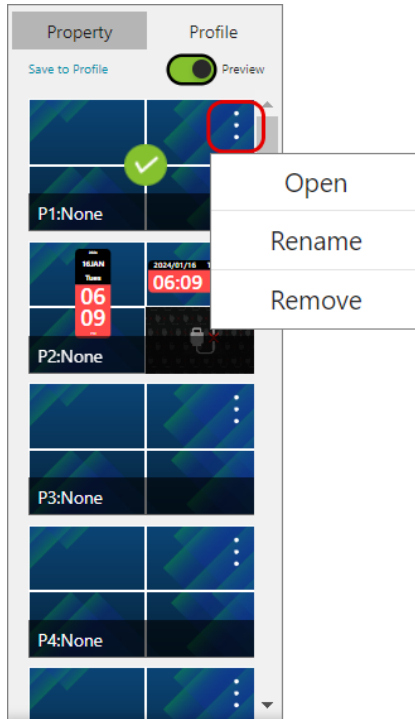

2. Simply select Remove to delete the profile, and confirm to delete it. The profile item will be cleaned up.

System Settings

Click on the Settings button  in the menu bar to enter the settings page for configuring the system settings. Please note that only the user with administrator user role can access the settings page.

The setting page opens to the General tab. To access to other settings, click on the menu item listed in the system settings menu bar, and you will directly to enter its tab page or expand its submenu to select the setting category you'd like to configure.

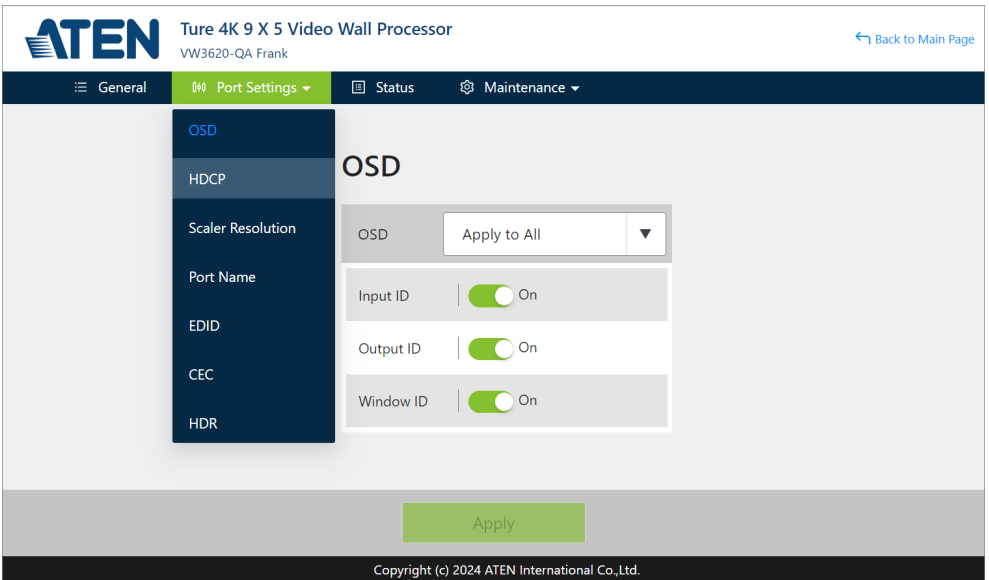

Overview

The table below provides an overview of the available settings for each tab.

Tab	Supported Functions	Detailed Information
General	<ul style="list-style-type: none"> ◆ Configure the device name. ◆ Select the interface language. ◆ Configure the system time. 	For more information, see <i>General</i> , page 74.
Port Settings	<ul style="list-style-type: none"> ◆ Configure the OSD and CEC port settings. ◆ Configure the HDCP key. ◆ Name the input ports. ◆ Select EDID modes. 	For more information, see <i>Port Settings</i> , page 76.
Status	<ul style="list-style-type: none"> ◆ Provide a graphical view for user to check statuses of the input/output boards installed to the VW3620. 	For more information, see <i>Status</i> , page 87.
Maintenance	<ul style="list-style-type: none"> ◆ Upgrade the firmware for the installed input and output boards ◆ Back up or restore the VW3620's configuration ◆ Add, edit, or remove user accounts ◆ Configure the system network settings 	See <i>Maintenance</i> , page 88.

General

The General tab allows you to configure the following settings:

The screenshot displays the ATEN configuration web interface. At the top, the ATEN logo is on the left, followed by the device name 'Ture 4K 9 X 5 Video Wall Processor' and model 'VW3620-TEST DEVICE'. A 'Back to Main Page' link is on the right. Below this is a dark navigation bar with 'General' selected, and other options: 'Port Settings', 'Status', and 'Maintenance'. The main content area is titled 'Device Info' and contains four configuration fields: 'Device Name' (text input with 'TEST DEVICE'), 'Firmware Version' (text input with '9.1.101'), 'Baud Rate' (dropdown menu with '19200'), and 'Language' (dropdown menu with 'English'). Below this is the 'System Time' section, which includes a 'System Time' field showing '2024-01-12 20:45:45', a 'Time Zone' field, and a green 'Apply' button. At the bottom of the interface, a copyright notice reads 'Copyright (c) 2024 ATEN International Co.,Ltd.'.

Item	Description
Device Info	
Device Name	Define the name for this VW3620 unit.
Firmware Version	The current version of the firmware installed on this VW3620 unit.
Buad Rate	Select the buad rate from the drop-down menu
Language	Select the display language for this VW3620 unit.
System Time	
System Time	Set the system time.
Time Zone	Set the time zone.
NTP Server	Set the Network Time Protocol (NTP) to synchronize the clock between the unit and the server.

Item	Description
Sync with PC	To synchronize the time shown on the VW3620 with the connected PC.
Apply	By making any changes on this page, the Apply button located at the bottom of the page becomes available. Click on it to adopt the changed settings.

Port Settings

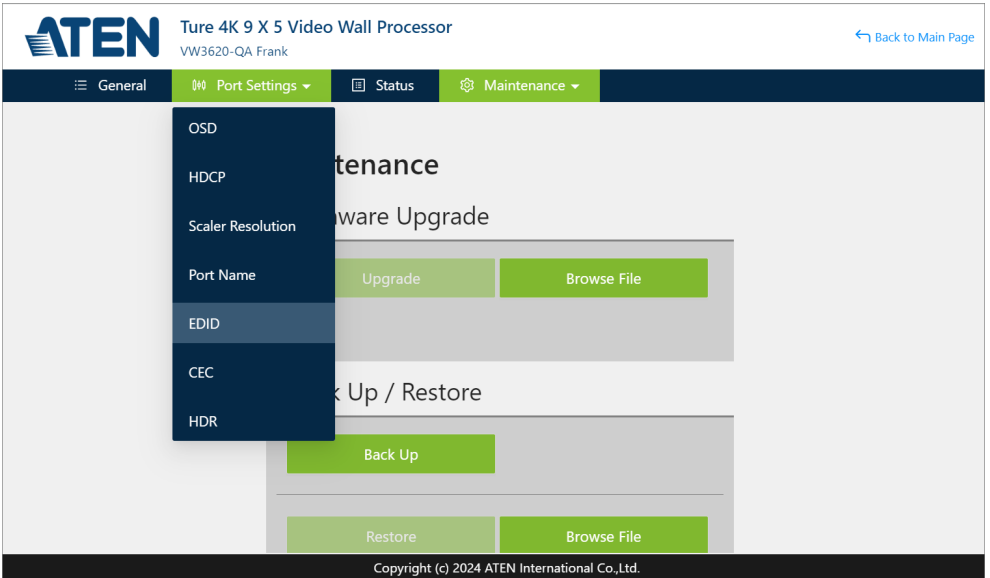

Move the cursor over the menu item System Settings to expand the submenu, and click on the submenu option you'd like to configure to enter the page.

OSD

OSD is to set whether to reveal or conceal the information about the input source(s), the output port(s), and the window(s) on the display device's screen.

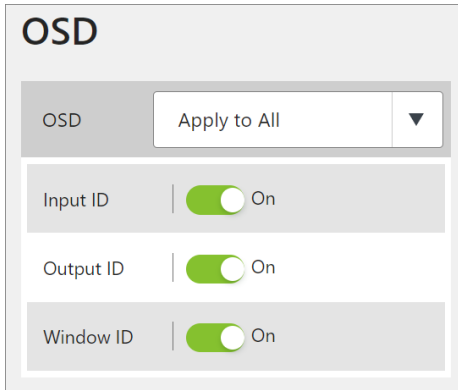

Item	Description
OSD	Select the option from the Apply to All drop-down menu: <ul style="list-style-type: none"> ◆ Turn All On Reveal all the ID information on all your display device(s). ◆ Turn All Off Conceal all the ID information on all your display device(s).
Input ID	Click on the switch to turn on or off to enable or disable the appear of the input ID on the display devices.
Output ID	Click on the switch to turn on or off to enable or disable the appear of the output ID on the display devices.
Window ID	Click on the switch to turn on or off to enable or disable the appear of the window ID on the display devices.
Apply	By making any changes on this page, the Apply button located at the bottom of the page becomes available. Click on it to adopt the changed settings.

HDCP

The HDCP (High-bandwidth Digital Content Protection) page allows user to view and set HDCP settings for digital copy protection.

The screenshot displays the ATEN Ture 4K 9 X 5 Video Wall Processor web interface. The page title is "Ture 4K 9 X 5 Video Wall Processor" with the model number "VW3620-TEST DEVICE". The navigation menu includes "General", "Port Settings", "Status", and "Maintenance". The "Port Settings" tab is active, showing the "Source" section with a dropdown menu set to "Apply to All". Below this, there are eight individual HDCP 1.4 settings for zones 1-A, 1-B, 1-C, 1-D, 2-A, 2-B, 2-C, and 2-D. On the right side, there are four "Zone" sections (Zone A, Zone B, Zone C, Zone D), each with an "Output" dropdown menu set to "Enable". A green "Apply" button is visible at the bottom center of the settings area. The footer of the page reads "Copyright (c) 2024 ATEN International Co., Ltd.".

Source Settings

To set HDCP for the input video source(s):

- ◆ Separately set for each input ports by selecting between **HDCP 1.4**, **HDCP 2.2**, and **Non-HDCP** from the drop-down menu.
- ◆ From the Apply to All drop-down menu of the Input field, select the option to be applied to all the input ports at a time:
 - ◆ All Ports HDCP 1.4
 - ◆ All Ports HDCP 2.2
 - ◆ All Ports Non-HDCP

Zone Settings

Separately set for each zone by selecting the option from the drop-down menu to enable or disable HDCP sink to determine whether the HDMI display(s) responds to HDCP content protection properly and decrypt incoming HDCP data and produce full fidelity digital streams. By selecting Enable, the source device connected to the VW3620 and the sink device will do an HDCP handshake to adapt the highest HDCP version supported by the sink device.

Scaler Resolution

Enter the Scaler Resolution to set the resolution for each zone.

ATEN Ture 4K 9 X 5 Video Wall Processor
VW3620-TEST DEVICE [Back to Main Page](#)

General Port Settings Status Maintenance

Scaler Resolution

▼ Zone A

Output 1920x1080@60Hz ▼

▼ Zone B

Output 1920x1080@60Hz ▼

▼ Zone C

Output 3840x2160@60Hz ▼

▼ Zone D

Output 3840x2160@60Hz ▼

Apply

Copyright (c) 2024 ATEN International Co.,Ltd.



The options are:

- ◆ 3480 × 2160 @60Hz
- ◆ 3480 × 2160 @30Hz
- ◆ 1920 × 1080 @60Hz
- ◆ 1920 × 1080 @30Hz
- ◆ Customized

By making any changes on this page, the Apply button located at the bottom of the page becomes available. Click on it to adopt the changed settings.

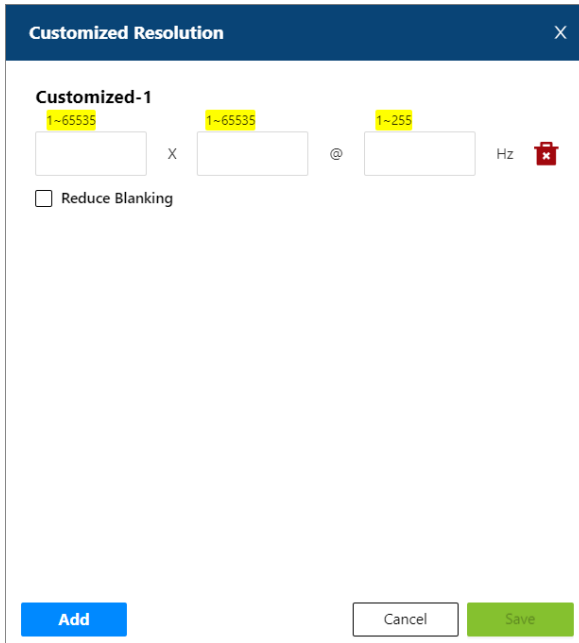
By selecting Customized, a popup Customized Resolution shows up for the user to configure the resolution.



Item	Description
	Click to add a user-defined resolution.
	Click to delete the user-defined resolution.
<input checked="" type="checkbox"/> Reduce Blanking	Check the checkbox to enable the function Reduce Blanking to reduce the horizontal and vertical blanking periods on the display(s).
<input type="text" value="Cancel"/>	Click to close the popup window and discard the changes you just made.
<input type="text" value="Save"/>	Click to save the changes you just made.

Click on the Add button to create a user-defined resolution, and once you finish the configuration, click on the Save button to complete the settings.

Port Name

Enter the name for the port you'd like to define, and click on the Apply button to save your changes.

ATEN Ture 4K 9 X 5 Video Wall Processor
VW3620-TEST DEVICE [← Back to Main Page](#)

General Port Settings Status Maintenance

Port Name

Input

1-A	<input type="text" value="123"/>
1-B	<input type="text" value="ABC"/>
1-C	<input type="text" value="Name"/>
1-D	<input type="text" value="Name"/>
2-A	<input type="text" value="Name"/>
2-B	<input type="text" value="Name"/>
2-C	<input type="text" value="Name"/>

Apply

Copyright (c) 2024 ATEN International Co.,Ltd.

By making any changes on this page, the Apply button located at the bottom of the page becomes available. Click on it to adopt the changed settings.

EDID

Extended Display Identification Data (EDID) is a data format that contains a display's basic information and is used to communicate with the video source/system. The EDID page lets users view and select an EDID mode so that the VW3620 can use the best resolution for its displays.

ATEN Ture 4K 9 X 5 Video Wall Processor
VW3620-TEST DEVICE [← Back to Main Page](#)

General Port Settings Status Maintenance

EDID

EDID Mode

- ATEN Default
- Port1 Mode
- Customized

Apply

Port EDID Status

ATEN_EDID_1

EDID & CEA Description

EDID

1. Vendor/Product Identification
2. EDID Structure/Revision
3. Basic Display/Feature
4. Color Characteristics
5. Established Timings
6. Standard Timings
7. Detail Timing/Display Description 1
8. Detail Timing/Display Description 2
9. Monitor Description
10. Monitor Description

CEA

1. Display Support
2. Video Data
3. Audio Data
4. Speaker Allocation
5. Vendor Specific Data
6. HDMI Forum Vendor Specific Block
7. YCBCR 4:2:0 Video Data Block

Copyright (c) 2024 ATEN International Co.,Ltd.

Note: The EDID mode can also be selected via the front panel pushbuttons—see *EDID Mode*, page 39.

EDID Mode

In the left panel of the page, users can select a pre-configured EDID Mode using the EDID Mode radio buttons.

EDID

EDID Mode

ATEN Default
 Port1 Mode
 Customized

Port EDID Status

ATEN_EDID_1

EDID & CEA Description

EDID

1. Vendor/Product Identification
2. EDID Structure/Revision
3. Basic Display/Feature
4. Color Characteristics
5. Established Timings
6. Standard Timings
7. Detail Timing/Display Description 1
8. Detail Timing/Display Description 2
9. Monitor Description
10. Monitor Description

CEA

1. Display Support
2. Video Data
3. Audio Data
4. Speaker Allocation
5. Vendor Specific Data
6. HDMI Forum Vendor Specific Block
7. YCBCR 4:2:0 Video Data Block

Item	Description
ATEN Default	All ports' EDID is the same as the hardware default EDID.
Port 1 Mode	All ports' EDID is the same as Port1's EDID.
Customized	Select the Customized mode to defined the EDID and CEA settings by users.
Apply	Click to apply the mode you just selected.

EDID & CEA Description

The middle panel of the screen lets users view and configure the EDID or the CEA mode.

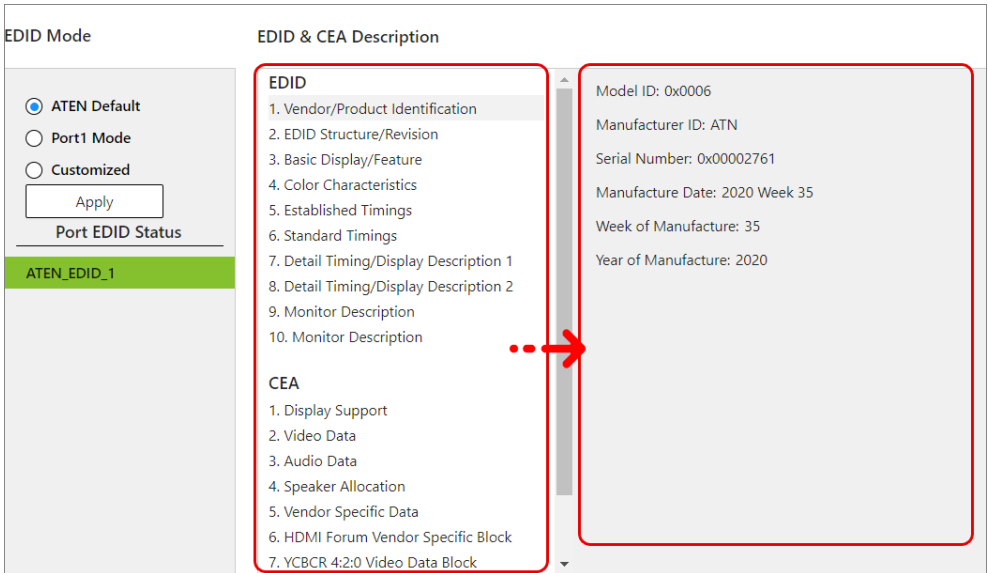

From the middle column, click the option that you want to view and/or edit. There are two categories: EDID (Extended Display Identification Data) and CEA (Consumer Electronics Association).

When you select the menu items on the middle column, the current settings for the selected EDID appear on the right column. Some of the screens are read-only.

CEC

Consumer Electronics Control (CEC) allows interconnected HDMI devices to communicate and respond to one remote control.

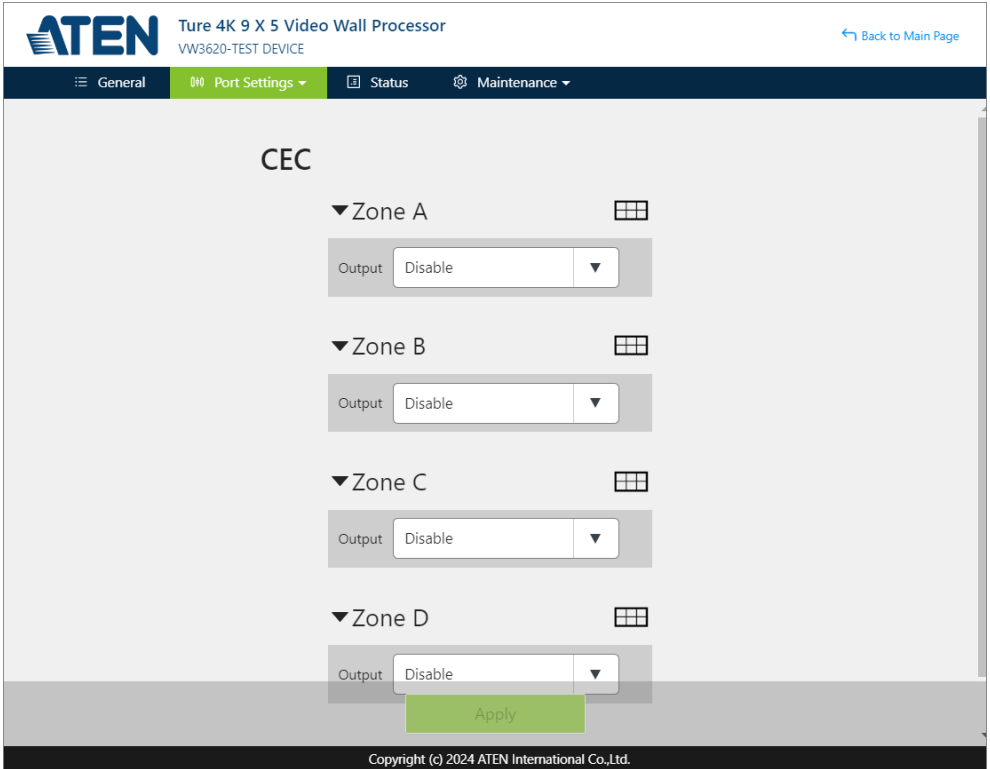

The screenshot displays the ATEN web interface for a Ture 4K 9 X 5 Video Wall Processor (VW3620-TEST DEVICE). The interface includes a navigation bar with 'General', 'Port Settings', 'Status', and 'Maintenance' tabs. The 'Port Settings' tab is active. The main content area is titled 'CEC' and contains four sections for Zone A, Zone B, Zone C, and Zone D. Each zone section includes a dropdown menu labeled 'Output' with the value 'Disable' selected. A green 'Apply' button is located at the bottom center of the page. The footer contains the copyright notice: 'Copyright (c) 2024 ATEN International Co.,Ltd.'

Use the drop-down menu to enable/disable CEC for the output ports of the zone. By making any changes on this page, the Apply button located at the bottom of the page becomes available. Click on it to adopt the changed settings.

HDR

High dynamic range (HDR) displays video content with more luminance, more color and contrast.

The screenshot shows the ATEN Ture 4K 9 X 5 Video Wall Processor web interface. The top navigation bar includes the ATEN logo, the device name 'Ture 4K 9 X 5 Video Wall Processor', the model 'VW3620-TEST DEVICE', and a 'Back to Main Page' link. Below the navigation bar are tabs for 'General', 'Port Settings', 'Status', and 'Maintenance'. The main content area is titled 'HDR' and contains a list of input ports with drop-down menus for setting HDR to 'Apply to All', 'Enable', or 'Disable'. An 'Apply' button is visible at the bottom of the settings list.

Input	Setting
Input	Apply to All
1-A	Enable
1-B	Disable
1-C	Disable
1-D	Disable
2-A	Disable
2-B	Disable
2-C	Disable
2-D	Disable
3-A	Apply

Copyright (c) 2024 ATEN International Co.,Ltd.

Use the drop-down menu to apply options to all input ports, or set for each input port by selecting Enable or Disable from the drop-down menu. By making any changes on this page, the Apply button located at the bottom of the page becomes available. Click on it to adopt the changed settings.

Status

Status page gives you a graphical information about the current working status of the VW3620.

The screenshot displays the ATEN Ture 4K 9 X 5 Video Wall Processor status page. The page is titled "Connections" and shows a graphical representation of the device's status. The "Input" section is highlighted, showing a temperature of 36°C. The "Output" section shows various connection ports (A, B, C, D) for FN, 1, 2, 3, 4, 5, 6, 7, CPU 1, CPU 2, POWER1, and POWER2. A "Refresh" button is located in the top right corner.

Click on the component to be checked to open the popup for detailed information.

The screenshot shows the "Input Board @" popup window. The working status is "Normal". The table below provides detailed information about the input board.

Model Name	I/O Type	FW Version	Temperature	Power
VW784	HDMI	V1.0.075	41°C	MAX.17 W

Port A	Port B	Port C	Port D
Connected	N/A	N/A	N/A
1-A:123	N/A	N/A	N/A

Maintenance

Move the cursor over the menu item Maintenance to expand the submenu, and click on the submenu option you'd like to configure to enter the page.

The screenshot shows the ATEN web interface for a Ture 4K 9 X 5 Video Wall Processor (VW3620-TEST DEVICE). The top navigation bar includes 'General', 'Port Settings', 'Status', and 'Maintenance'. The 'Maintenance' menu is expanded, showing options for 'System Setup', 'User Account', 'Network', and 'Security'. The 'User Account' option is selected, leading to a page with a table of user accounts and an '+ Add Account' button.

User Name	Level	Description
administrator	Administrator	administrator

Copyright (c) 2024 ATEN International Co.,Ltd.

System Setup

You can use the System Setup page to do any of the following:

The screenshot shows the ATEN WMS interface for a Ture 4K 9 X 5 Video Wall Processor (VW3620-TEST DEVICE). The top navigation bar includes 'General', 'Port Settings', 'Status', and 'Maintenance'. The 'Maintenance' section is expanded, showing three sub-sections:

- Firmware Upgrade:** Contains 'Upgrade' and 'Browse File' buttons.
- Back Up / Restore:** Contains 'Back Up', 'Restore', 'Browse File', and 'Reset to Default' buttons.
- SSL Encryption:** Contains 'Browse File' buttons for 'Certificate' and 'Private key', and an 'Update' button.

Copyright (c) 2024 ATEN International Co.,Ltd.

- ◆ Upgrade the VW3620's firmware.
- ◆ Back up or restore the VW3620's settings. Note that account settings cannot be backed up or restored.
- ◆ Configure the SSL Encryption settings.

User Account

The User Account page lets you check, add, edit, or delete users and change the password for accessing the VW3620's Web GUI.

ATEN Pure 4K 9 X 5 Video Wall Processor
VW3620-TEST DEVICE [← Back to Main Page](#)

General Port Settings Status Maintenance

User Account + Add Account

User Name	Level	Permission	Description
administrator	Administrator	All Zones	administrator

Copyright (c) 2024 ATEN International Co., Ltd.

Note: This is an Administrator only function.

Add a New User

To create a new user account, do the followings:

1. Click the Add Account button to open the Add / Edit Account popup.

User Account + Add Account

User Name	Level	Permission	Description
administrator	Administrator	All Zones	administrator

2. Fill in the required field.

Add / Edit Account
✕

User Name

Description:

Password

Confirm Password

Please enter 5-16 characters without these special characters <>[]0*+=?@\|/';:~" space &

Level

Administrator: Preview / Design / Calendar / Settings

Advanced User: Preview / Design / Calendar

Basic User: Preview / View Calendar

Permission

zone A zone B zone C zone D

Delete

Cancel

Save

Item	Description
User Name	The account used to log in to the Web GUI
Description	Any description you'd like to add to this user
Password	The password for this user to log in to the Web GUI
Confirm Password	Enter the password again for confirmation.
Level	Assign the user role type for this user: <ul style="list-style-type: none"> ◆ Administrator ◆ Advanced User ◆ Basic User

Item	Description
Permission	Check the check box(es) to select the zone(s) this
Cancel	Close the popup and discard the settings.
Save	Click on the save button to create this user account.

3. Click on the Save button to complete.

Edit / Delete an Existing User

On the user list, pass your cursor to the user to be edited, and an Edit option appears. Click on it to open the Add / Edit Account popup. To edit the user account, make changes and then click on the Save button. To delete the user account, directly click on the Delete button to remove this user.

User Account

[+ Add Account](#)

User Name	Level	Permission	Description
administrator	Administrator	All Zones	administrator
test123	Basic User	All Zones	Edit

Network

The Network page lets you configure the VW3620's IP settings for connecting to it via the web GUI.

The screenshot shows the ATEN web GUI interface. At the top, there is a navigation bar with the ATEN logo, the device name 'Ture 4K 9 X 5 Video Wall Processor', the model 'VW3620-TEST DEVICE', and a 'Back to Main Page' link. Below the navigation bar are tabs for 'General', 'Port Settings', 'Status', and 'Maintenance'. The main content area is titled 'Network' and contains two sections: 'IP Settings' and 'Browser'. The 'IP Settings' section has a 'Mode' dropdown with 'DHCP' selected and 'Manual' as an option. Below are input fields for 'IP Address' (10.3.52.34), 'Mask' (255.255.254.0), 'Gateway' (10.3.53.254), and 'DNS' (10.0.1.6). The 'Browser' section has a 'Timeout' field and an 'Apply' button. At the bottom of the page, there is a copyright notice: 'Copyright (c) 2024 ATEN International Co., Ltd.'

Item	Description
IP Settings	
Mode	Enable DHCP to allow the DHCP server to assign an IP address to the VW3620. Select Disable to enter your own static IP address settings for the device.
IP Address	Set the IP address for this VW3620.
Mask	Configure the mask settings for this VW3620.
Gateway	Configure the gateway settings for this VW3620.
DNS	Configure the DNS settings for this VW3620.
Browser	
Timeout	Set the inactive duration before the system automatically log the user out.

Item	Description
IP Installer	
Mode	<ul style="list-style-type: none">◆ Enable◆ View Only◆ Disable
Apply	By making any changes on this page, the Apply button located at the bottom of the page becomes available. Click on it to adopt the changed settings.

Security

Security page allows the user to set the followings:

ATEN Ture 4K 9 X 5 Video Wall Processor
VW3620- [← Back to Main Page](#)

General Port Settings Status Maintenance

Security

Account Lockout Policy

Account Lockout
Disable

Maximum Invalid Login Attempts (1-999)
2

Account Lockout Duration (1-999 mins)
2

Connection

Telnet Login
Enable

Transport Layer Security

Transport Layer Security
Any version

Cancel Save

Copyright (c) 2024 ATEN International Co.,Ltd.

Item	Description
Account Lockout Policy	
Account Lockout	To enable or disable the function that locks the login account after a certain number of failed sign-in attempts.
Maximum Invalid Login Attempts (1-999)	Enter the maximum number of failed sign-in attempts.
Account Lockout Duration (1-999 mins)	Define the number of minutes that a locked-out account remains locked out before it gets unlocked.

Item	Description
Connection	
Telnet Login	To enable or disable the Telnet login function.
Transport Layer Security	
Transport Layer Security	Select the TLS version to be adopted.

Once you finish your configuration about the security, click the Save button to make the change to take effect.

Chapter 5

CLI Commands

Overview

The VW3620 can be configured and controlled via RS-232 or Telnet commands when connected to a host computer or other device, such as a control system. This chapter provides information on how to connect to the VW3620 via RS-232/Telnet and command syntax.

Connecting to the Video Wall Processor via Telnet

To establish a Telnet session with the VW3620, do the following:

1. Connect a host computer or control system to a shared network with the VW3620.
2. Open a command-line interpreter program from your computer.
3. In the command-line interpreter, type the VW3620's IP address in the following way:

```
telnet [IP address]:23
```

4. Press **Enter**. The login screen appears.
5. At the login prompt, type the login username and password for the VW3620.
6. When a session is established with the VW3620, you can control and configure the VW3620 via RS-232 commands. For more information on commands, see *Commands*, page 100.

Note: If a user logs in using a username that is already in session, the newest login takes effect and the previous session will be replaced.

Connecting to the Video Wall Processor via RS-232

You can control and operate the VW3620 using a high-end controller or PC. To connect to the VW3620 via RS-232, do the following:

1. Connect the RS-232 serial port on the VW3620 to the RS-232 serial port on your computer using a 9-wire straight cable, with only pin 2 to pin 2, pin 3 to pin 3, and pin 5 to pin 5 connected.

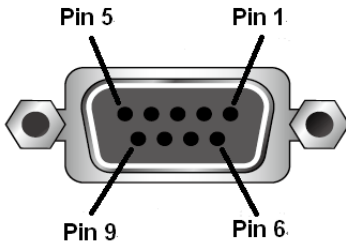

Pin	Description
1	Not connected
2	RxD
3	TxD
4	Not connected
5	GND
6	Not connected
7	Not connected
8	Not connected
9	Not connected

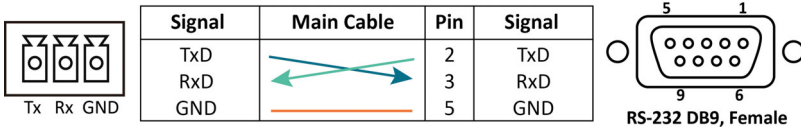

2. The controller’s serial port should be configured as follows:

RS-232 Protocol	
Baud Rate	19200
Data Bits	8
Parity	None
Stop Bits	1
Flow Control	None

3. When a session is established with the VW3620, you can control and configure the VW3620 via RS-232 commands. For more information on commands, see *Commands*, page 100.

Command Guidelines

- ♦ The general form of a command is:

```
command parameter<argument> {one|two|three}
```

Notation	Description
command	The name of the command is shown in bold.
parameter	Indicates the name of the parameter.
<argument>	Indicates the name of the value or the information that the user must provide. Only type the information in the angle brackets, not the brackets themselves.
[]	Indicates keys you should press. For example, [Enter] means to press the Enter key. If keys need to be chorded, they appear together in the same bracket with a plus sign between them: [Ctrl+Alt].
{ }	Indicates a set of choices from which the user must choose one.
	Indicates two or more mutually exclusive choices in a command line. Only type one of the choices in the command line, not the symbol.

- ♦ If you have two or more parameters, the order of these parameters among themselves does not affect the result of the operation. For example, both of the following commands execute the same task:

```
command name + parameter 1 + parameter 2
```

```
command name + parameter 2 + parameter 1
```

Verification

After entering a command, a verification message appears at the end of the command line as follows:

- ♦ **Command OK** - indicates that the command is correct and successfully performed by the switch
- ♦ **Command incorrect** - indicates that the command has the wrong format and/or values.

Commands

After connecting to the VW3620 via Telnet or RS-232, you can operate the system using the following commands.

Switch Port Command

Switch a specific input video source to a specific output port(s) / window(s) displayed on a designated zone.

The formula for Switch commands are as follows:

- ◆ **sw** z<zone ID> o<output ID> i<input ID> [ENTER]
- ◆ **sw** z<zone ID> ow<window ID> i<input ID> [ENTER]

Parameters:

- ◆ z<zone ID>
 - ◆ **Description:** Specify the zone to be displayed
 - ◆ **Format:** a to d
- ◆ o<output ID>
 - ◆ **Description:** Specify the output port
 - ◆ **Format:** 1-a to 5-d ; an asterisk * means all the output ports
- ◆ ow<window ID>
 - ◆ **Description:** Specify the output window
 - ◆ **Format:** 1 to 144 ; an asterisk * means all the output windows
- ◆ i<input ID>
 - ◆ **Description:** Specify the input port of the target source
 - ◆ **Format:** 1-a to fn2-d

Example:

1. To switch input port fn-1a to output port 4-a, and display on zone c, type the following:

```
sw zc o4-a ifn1-a [Enter]
```

2. To switch input port 3-b to all the output windows displayed on zone c, type the following:

```
sw zc ow* i3-b [Enter]
```

3. To switch input port fn2-a to all the output ports, and display one zone b, type the following:

```
sw zb o* ifn2-a [Enter]
```

Load Profile Commands

The Load Profile command allows you to apply one or multiple profiles to the display zones. The formula for Load Profile command is as follows:

- ◆ **profile** f<profile ID> z<zone ID> load [ENTER]

Parameters:

- ◆ f<profile ID>
 - ◆ **Description:** Specify the profile to be applied
 - ◆ **Format:** 1 to 16
- ◆ z<zone ID>
 - ◆ **Description:** Specify the display zone that applies the designated profile
 - ◆ **Format:** 1 to 4

Example:

1. To apply profile 4 to zone 2, type the following:

```
profile f4 z2 load [Enter]
```

EDID Mode Command

Extended Display Identification Data (EDID) is a data that contains a display's basic information and is used to communicate with the video source. The EDID Mode commands allow you to change the EDID setting.

The formula for the EDID command is as follows:

- ◆ `edid port1|default|custom [ENTER]`

Parameters:

- ◆ `port1`
Set all ports' EDID is the same as Port1's EDID.
- ◆ `default`
Set all ports' EDID to be the same as the hardware default EDID.
- ◆ `custom`
Implement the customized mode as set in the EDID system settings.
See *EDID Mode*, page 83, for details.

Example:

1. To use the default mode, type:
`edid default [Enter]`
2. To use Port1 EDID mode, type:
`edid port1 [Enter]`

Read Command

The Read command allows you to view information about the devices, including the model name, the firmware version, the serial number, and the MAC address. The formula for the Read command is as follows:

◆ **read** [Enter]

Example:

1. To view information of the VW3620, type:

```
read [Enter]
```

Reset Command

The Reset command allows you to reset the VW3620 back to the default factory settings. Reset includes resetting the devices IP address.

The formula for the Reset command is as follows:

◆ **reset** [Enter]

Example:

1. To reset the VW3620, type:

```
reset [Enter]
```

Reboot Command

The Reboot command allows you to turn off the VW3620 and then start it again immediately. The formula for the Reset command is as follows:

◆ **reboot** [Enter]

Example:

1. To reboot the VW3620, type:

```
reboot [Enter]
```

Baud Rate Command

The Baud Rate command allows you to set the RS-232 data rate for the VW3620 to use. Options are 9600, 19200 (default) 38400 and 115200.

The formula for the Baud Rate command is as follows:

```
baud 9600|19200|38400|115200 [Enter]
```

Parameters:

- ◆ 9600
- ◆ 19200
- ◆ 38400
- ◆ 115200

Example:

1. To set 38400 as the baud rate, type:

```
baud 38400 [Enter]
```

Echo Command

The Echo function updates the RS232 controller when operations are made via the front panel pushbuttons, web browser or telnet. The changes echo back to the RS232 controller to keep the settings in sync with the device.

The formula for the Echo command is as follows:

```
echo on|off [Enter]
```

Parameters:

- ◆ on
Enable the echo feature.
- ◆ off
Disable the echo feature.

Example:

1. For example, to enable the echo feature, type:

```
echo on [Enter]
```

Fan Speed Command

The Fan Speed command allows you to set the VW3620's internal fan speed.

To set the fan speed, use the following command:

- ◆ `fan mid|high|auto [Enter]`

Parameters:

- ◆ `mid`
Set internal fan to normal speed.
- ◆ `high`
Set internal fan to high speed.
- ◆ `auto`
Set internal fan to auto detect (default).

Example:

1. To set the fan to auto detect, type:
`fan auto [Enter]`

Alert Command

To trigger a warning when issues arise for a specific window, use the following command:

- ◆ **alert** z<zone ID> w<window ID> on|off [Enter]

Parameters:

- ◆ z<zone ID>
 - ◆ **Description:** Specify the display zone
 - ◆ **Format:** 1 to 4
- ◆ w<window ID>
 - ◆ **Description:** Specify the output window
 - ◆ **Format:** 1 to 144 ; an asterisk * means all the output windows
- ◆ on
Enable the alert feature.
- ◆ off
Disable the alert feature.

Example:

1. To enable the Alert function for window 5 on zone 1, type:
alert z1 w5 on
2. To disable the Alert function for window 3 on zone 2, type:
alert z2 w3 off

Standby Mode Command

Standby mode is a power-saving mode that shuts parts of the system down to allow the user to quickly resume operation when needed.

The formula for the standby mode command is as follows:

- ◆ **standby** on|off [Enter]

Parameters:

- ◆ on
Turn on the standby mode.
- ◆ off
Turn off the standby mode.

Example:

1. To enable standby mode, type the following:
standby on [Enter]

This Page Intentionally Left Blank

Safety Instructions

General

- ◆ Read all of these instructions. Save them for future reference.
- ◆ Follow all warnings and instructions marked on the device.
- ◆ This product is for indoor use only.
- ◆ Do not place the device on any unstable surface (cart, stand, table, etc.). If the device falls, serious damage will result.
- ◆ Do not use the device near water.
- ◆ Do not place the device near, or over, radiators or heat registers.
- ◆ The device cabinet is provided with slots and openings to allow for adequate ventilation. To ensure reliable operation, and to protect against overheating, these openings must never be blocked or covered.
- ◆ The device should never be placed on a soft surface (bed, sofa, rug, etc.) as this will block its ventilation openings. Likewise, the device should not be placed in a built in enclosure unless adequate ventilation has been provided.
- ◆ Never spill liquid of any kind on the device.
- ◆ Unplug the device from the wall outlet before cleaning. Do not use liquid or aerosol cleaners. Use a damp cloth for cleaning.
- ◆ The device should be operated from the type of power source indicated on the marking label. If you are not sure of the type of power available, consult your dealer or local power company.
- ◆ The device is designed for IT power distribution systems with 230V phase-to-phase voltage.
- ◆ To prevent damage to your installation it is important that all devices are properly grounded.
- ◆ The device is equipped with a 3-wire grounding type plug. This is a safety feature. If you are unable to insert the plug into the outlet, contact your electrician to replace your obsolete outlet. Do not attempt to defeat the purpose of the grounding-type plug. Always follow your local/national wiring codes.
- ◆ Do not allow anything to rest on the power cord or cables. Route the power cord and cables so that they cannot be stepped on or tripped over.

- ◆ If an extension cord is used with this device make sure that the total of the ampere ratings of all products used on this cord does not exceed the extension cord ampere rating. Make sure that the total of all products plugged into the wall outlet does not exceed 15 amperes.
- ◆ To help protect your system from sudden, transient increases and decreases in electrical power, use a surge suppressor, line conditioner, or un-interruptible power supply (UPS).
- ◆ Position system cables and power cables carefully; Be sure that nothing rests on any cables.
- ◆ Never push objects of any kind into or through cabinet slots. They may touch dangerous voltage points or short out parts resulting in a risk of fire or electrical shock.
- ◆ Do not attempt to service the device yourself. Refer all servicing to qualified service personnel.
- ◆ If the following conditions occur, unplug the device from the wall outlet and bring it to qualified service personnel for repair.
 - ◆ The power cord or plug has become damaged or frayed.
 - ◆ Liquid has been spilled into the device.
 - ◆ The device has been exposed to rain or water.
 - ◆ The device has been dropped, or the cabinet has been damaged.
 - ◆ The device exhibits a distinct change in performance, indicating a need for service.
 - ◆ The device does not operate normally when the operating instructions are followed.
- ◆ Only adjust those controls that are covered in the operating instructions. Improper adjustment of other controls may result in damage that will require extensive work by a qualified technician to repair.
- ◆ Avoid circuit overloads. Before connecting equipment to a circuit, know the power supply's limit and never exceed it. Always review the electrical specifications of a circuit to ensure that you are not creating a dangerous condition or that one does not already exist. Circuit overloads can cause a fire and destroy equipment.

Rack Mounting

- ◆ Before working on the rack, make sure that the stabilizers are secured to the rack, extended to the floor, and that the full weight of the rack rests on the floor. Install front and side stabilizers on a single rack or front stabilizers for joined multiple racks before working on the rack.
- ◆ Always load the rack from the bottom up, and load the heaviest item in the rack first.
- ◆ Make sure that the rack is level and stable before extending a device from the rack.
- ◆ Do not overload the AC supply branch circuit that provides power to the rack. The total rack load should not exceed 80 percent of the branch circuit rating.
- ◆ Make sure that all equipment used on the rack – including power strips and other electrical connectors – is properly grounded.
- ◆ Ensure that proper airflow is provided to devices in the rack.
- ◆ Ensure that the operating ambient temperature of the rack environment does not exceed the maximum ambient temperature specified for the equipment by the manufacturer.
- ◆ Do not step on or stand on any device when servicing other devices in a rack.

Technical Support

International

- ◆ For online technical support – including troubleshooting, documentation, and software updates: <http://eservice.aten.com>
- ◆ For telephone support, see *Telephone Support*, page iv:

North America

Email Support		support@aten-usa.com
Online Technical Support	Troubleshooting Documentation Software Updates	http://www.aten-usa.com/support
Telephone Support		1-888-999-ATEN ext 4988

When you contact us, please have the following information ready beforehand:

- ◆ Product model number, serial number, and date of purchase.
- ◆ Your computer configuration, including operating system, revision level, expansion cards, and software.
- ◆ Any error messages displayed at the time the error occurred.
- ◆ The sequence of operations that led up to the error.
- ◆ Any other information you feel may be of help.

Specifications

VW3620

Input and Output Boards	
Board Input	7 × Slot, up to 32 4K inputs
Board Output	5 × Slot, up to 20 4K outputs
Function	2 x Slots for Function Board, can also used as Input Slot
Video Input	
Interfaces	Depends on which I/O board is inserted
Video Output	
Interfaces	Local Output: 1 × HDMI Type A Female (Black)
Control	
RS-232	Connector: 1 × DB-9 Female (Black) Serial Control Pin Configurations: Pin2 = Tx, Pin 3=Rx, Pin 5= Gnd Baud Rate and Protocol: Baud Rate: 19200 (default), Data Bits: 8, Stop Bits: 1, Parity: No, Flow Control: No
Ethernet	Connector: 1 × RJ-45 Female
USB	3 × Keyboard (TBD) / Mouse (TBD) / FW upgrade & Storage
EDID Settings	
EDID Mode	Default / Port1 / Customized (EDID Wizard support)
Communication	
Daisy Chain Ports	RJ-45 × 2
Connectors	
Power	1 × 3-Prong AC Socket
Power	
Maximum Input Power Rating	100–127Vac, 47–63Hz, 10A, × 2 200–240Vac, 47–63Hz, 7.08A, × 2
Consumption	AC110V:573.4W AC220V:555.4V
Optional	Redundancy, Optional Hot Swap PSU

Environmental	
Operating Temperature	0–40°C
Storage Temperature	-20–60°C
Humidity	0–80% RH, Non-condensing
Physical Properties	
Housing	Metal
Weight	16.21 kg
Dimensions (L x W x H)	48.20 × 45.80 × 30.98 cm
Rack Height (U Space)	7U

VW784 / VW884

	VW784	VW884
Video Input		
Interfaces	4 x HDMI Type A Female (Black)	N/A
Impedance	100 Ω	N/A
Max. Distance	Up to 5m	N/A
Video Output		
Interfaces	N/A	4 x HDMI Type A Female (Black)
Impedance	N/A	100 Ω
Max. Distance	N/A	Up to 5m
Video		
Max. Data Rate	10.2 Gbps (3.4 Gbps Per Lane)	18.0 Gbps (6.0 Gbps Per Lane)
Max. Pixel Clock	340 MHz	600 MHz
Compliance	HDMI (3D, Deep Color, 4K) HDCP 2.2 Compatible Consumer Electronics Control (CEC)	
Max. Resolution	4096 × 2160 / 3840 × 2160 @30Hz (4:4:4)	4096 × 2160 / 3840 × 2160 @60Hz (4:4:4)
Power Consumption	17.71W	54.72W
Environmental		
Operating Temperature	0–40°C	
Storage Temperature	-20–60°C	
Humidity	0–80% RH, Non-Condensing	
Physical Properties		
Housing	Metal	
Weight	0.73 kg	0.92 kg
Dimensions (L x W x H)	19.3 × 27.1 × 27.4 cm	19.3 × 27.1 × 27.4 cm

ATEN Standard Warranty Policy

Limited Hardware Warranty

ATEN warrants its hardware in the country of purchase against flaws in materials and workmanship for a Warranty Period of two [2] years (warranty period may vary in certain regions/countries) commencing on the date of original purchase. This warranty period includes the [LCD panel of ATEN LCD KVM switches](#). For UPS products, the device warranty is two [2] years but battery is one [1] year. Select products are warranted for an additional year (see [A+ Warranty](#) for further details). Cables and accessories are not covered by the Standard Warranty.

What is covered by the Limited Hardware Warranty

ATEN will provide a repair service, without charge, during the Warranty Period. If a product is defective, ATEN will, at its discretion, have the option to (1) repair said product with new or repaired components, or (2) replace the entire product with an identical product or with a similar product which fulfills the same function as the defective product. Replaced products assume the warranty of the original product for the remaining period or a period of 90 days, whichever is longer. When the products or components are replaced, the replacing articles shall become customer property and the replaced articles shall become the property of ATEN.

To learn more about our warranty policies, please visit our website:

<http://www.aten.com/global/en/legal/policies/warranty-policy/>

© Copyright 2024 ATEN® International Co., Ltd.
Released: 2024-04-17

ATEN and the ATEN logo are registered trademarks of ATEN International Co., Ltd. All rights reserved. All other brand names and trademarks are the registered property of their respective owners.