



# Digital Projector User Manual

# Warranty and Copyright information

## Limited warranty

BenQ warrants this product against any defects in material and workmanship, under normal usage and storage.

Proof of purchase date will be required with any warranty claim. In the event this product is found to be defective within the warranty period, BenQ's only obligation and your exclusive remedy shall be replacement of any defective parts (labor included). To obtain warranty service, immediately notify the dealer from which you purchased the product of any defects.

Important: The above warranty shall be void if the customer fails to operate the product in accordance with BenQ's written instructions, especially the ambient humidity must be in-between 10% and 90%, temperature in-between 0°C and 35°C, altitude lower than 4920 feet, and avoiding to operate the projector in a dusty environment. This warranty gives you specific legal rights, and you may have other rights which vary from country to country.

For other information, please visit [www.BenQ.com](http://www.BenQ.com).

## Copyright

Copyright © 2024 by BenQ Corporation. All rights reserved. No part of this publication may be reproduced, transmitted, transcribed, stored in a retrieval system or translated into any language or computer language, in any form or by any means, electronic, mechanical, magnetic, optical, chemical, manual or otherwise, without the prior written permission of BenQ Corporation.

## Disclaimer

BenQ Corporation makes no representations or warranties, either expressed or implied, with respect to the contents hereof and specifically disclaims any warranties, merchantability or fitness for any particular purpose. Further, BenQ Corporation reserves the right to revise this publication and to make changes from time to time in the contents hereof without obligation to notify any person of such revision or changes.

\*DLP, Digital Micromirror Device and DMD are trademarks of Texas Instruments. Others are copyrights of their respective companies or organizations.

The terms HDMI, HDMI High-Definition Multimedia Interface, HDMI Trade dress and the HDMI Logos are trademarks or registered trademarks of HDMI Licensing Administrator, Inc.

# Table of Contents

<b>Warranty and Copyright information</b> .....	<b>2</b>
<b>Important safety instructions</b> .....	<b>4</b>
<b>Introduction</b> .....	<b>8</b>
Shipping contents .....	8
Projector exterior view .....	9
Controls and functions .....	10
<b>Positioning your projector</b> .....	<b>12</b>
Choosing a location .....	12
Obtaining a preferred projected image size .....	13
Adjusting the projector position .....	14
Mounting the projector .....	15
Adjusting the projected image .....	16
<b>Connection</b> .....	<b>18</b>
<b>Operation</b> .....	<b>20</b>
Starting up the projector .....	20
Using the menus .....	22
Securing the projector .....	23
Switching input signal .....	25
Shutting down the projector .....	25
<b>Menu operation</b> .....	<b>26</b>
Menu System .....	26
<b>Basic Menu</b> .....	26
<b>Advanced Menu</b> .....	27
<b>Maintenance</b> .....	<b>42</b>
Care of the projector .....	42
Light source information .....	43
<b>Troubleshooting</b> .....	<b>45</b>
<b>Specifications</b> .....	<b>46</b>
Projector specifications .....	46
Dimensions .....	47
Timing chart .....	48
RS232 command .....	51

# Important safety instructions

Your projector is designed and tested to meet the latest standards for safety of information technology equipment. However, to ensure safe use of this product, it is important that you follow the instructions mentioned in this manual and marked on the product.

1. **Please read this manual before you operate your projector.** Save it for future reference.

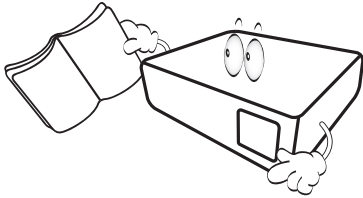

2. **Do not look straight at the projector lens during operation.** The intense light beam may damage your eyes.

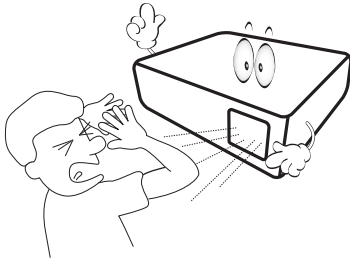

3. **Refer servicing to qualified service personnel.**

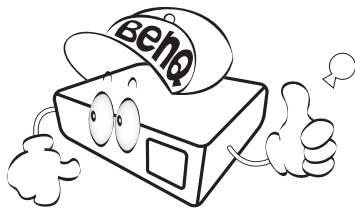

4. The light source becomes extremely hot during operation.

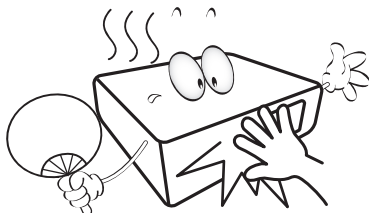

5. In some countries, the line voltage is NOT stable. This projector is designed to operate safely within a mains voltage between 100 to 240 volts AC, but could fail if power cuts or surges of  $\pm 10$  volts occur. **In areas where the mains voltage may fluctuate or cut out, it is recommended that you connect your projector through a power stabilizer, surge protector or uninterruptible power supply (UPS).**

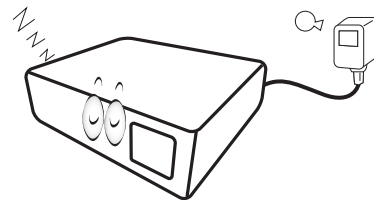

6. Do not block the projection lens with any objects when the projector is under operation as this could cause the objects to become heated and deformed or even cause a fire. To temporarily turn off the light source, use the blank function.

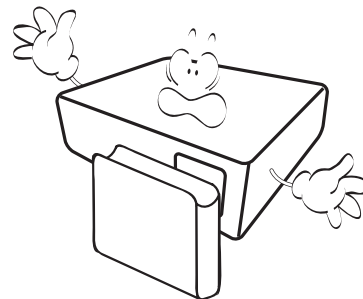

7. Do not operate light sources beyond the rated light source life.

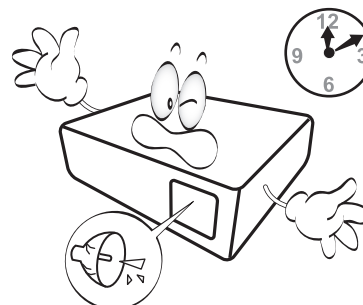

8. Do not place this product on an unstable cart, stand, or table. The product may fall, sustaining serious damage.

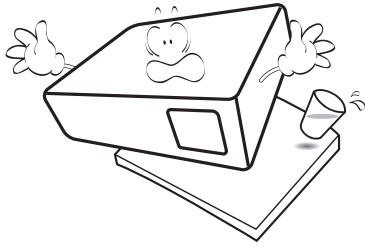

9. Do not attempt to disassemble this projector. There are dangerous high voltages inside which may cause death if you should come into contact with live parts.

Under no circumstances should you ever undo or remove any other covers. Refer servicing only to suitably qualified professional service personnel.

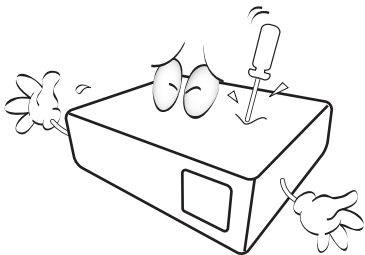

10. Do not block the ventilation holes.

- Do not place this projector on a blanket, bedding or any other soft surface.
- Do not cover this projector with a cloth or any other item.
- Do not place inflammables near the projector.

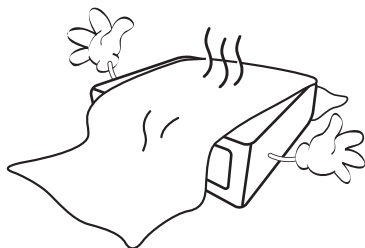

If the ventilation holes are seriously obstructed, overheating inside the projector may result in a fire.

11. Always place the projector on a level, horizontal surface during operation.

- Do not use if tilted at an angle of more than 10 degrees left to right, nor at angle of more than 15 degrees front to back. Using the projector when it is not fully horizontal may cause a malfunction of, or damage to, the light source.

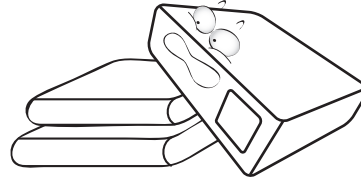

12. Do not stand the projector on end vertically. Doing so may cause the projector to fall over, causing injury or resulting in damage to the projector.

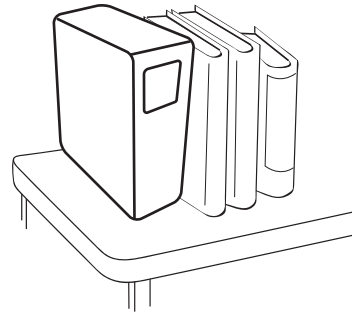

13. Do not step on the projector or place any objects upon it. Besides probable physical damage to the projector, doing so may result in accidents and possible injury.

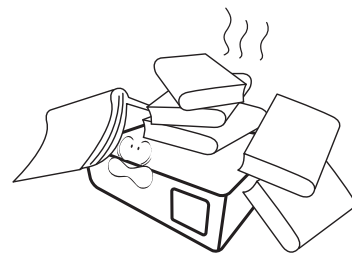

14. When the projector is under operation, you may sense some heated air and odor from its ventilation grill. It is a normal phenomenon and not a product defect.

15. Do not place liquids near or on the projector. Liquids spilled into the projector may cause it to fail. If the projector does become wet, disconnect it from the power supply's power outlet and call BenQ to have the projector serviced.

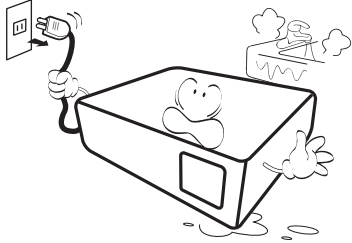

16. This product is capable of displaying inverted images for ceiling/wall mount installation.

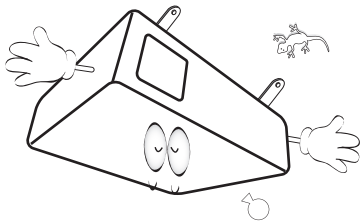

17. This apparatus must be earthed.

18. Do not place this projector in any of the following environments.

- Space that is poorly ventilated or confined. Allow at least 50 cm clearance from walls and free flow of air around the projector.
- Locations where temperatures may become excessively high, such as the inside of a car with all windows rolled up.
- Locations where excessive humidity, dust, or cigarette smoke may contaminate optical components, shorten the projector's life span and darken the image.

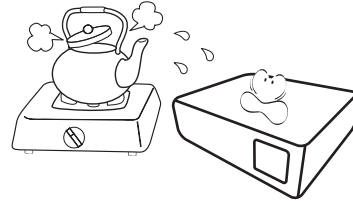

- Locations near fire alarms
- Locations with an ambient temperature above 40°C / 104°F
- Locations where the altitudes are higher than 3000 m (10000 feet).

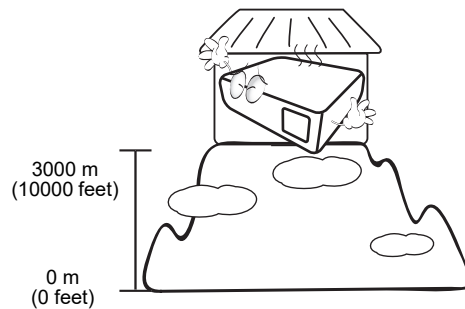

## Risk Group 2

1. According to the classification of photobiological safety of light sources and light source systems, this product is Risk Group 2, IEC 62471-5:2015.
2. Possibly hazardous optical radiation emitted from this product.
3. Do not stare at operating light source. May be harmful to the eyes.
4. As with any bright source, do not stare into the direct beam.



The projector's light source unit uses a laser.

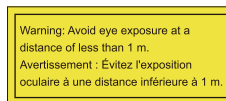

- Notice is given to supervise children and to never allow them to stare into the projector beam at any distance from the projector.
- Notice is given to use caution when using the remote control for starting the projector while in front of the projection lens.
- Notice is given to the user to avoid the use of optical aids such as binoculars or telescopes inside the beam.

## Laser Caution

This product belongs to CLASS 1 consumer laser product and complies with IEC 60825-1:2014, EN 60825-1:2014/A11:2021 and EN 50689:2021.



Above laser caution are located on the bottom of this apparatus.

Caution – Use of controls or adjustments or performance of procedures other than those specified herein may result in hazardous radiation exposure.

- ! To avoid damaging the DLP chips, never aim a high-power laser beam into the projection lens.

# Introduction

## Shipping contents

Carefully unpack and verify that you have all of the items shown below. If any of these items are missing, please contact your place of purchase.

### Standard accessories

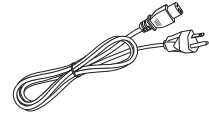
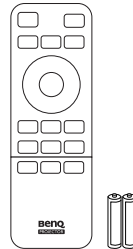
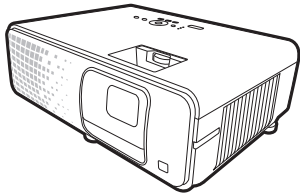

Projector

Remote control with  
batteries

Power cord

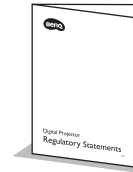

Quick start guide

Warranty card\*

Regulatory statements



- The supplied accessories will be suitable for your region, and may differ from those illustrated.
- \*The warranty card is only supplied in some specific regions. Please consult your dealer for detailed information.

## Replacing the remote control batteries

1. Press and open the battery cover, as illustrated.
2. Remove the old batteries (if applicable) and install two AAA batteries. Make sure that the positive and negative ends are positioned correctly, as illustrated.
3. Replace the battery cover until it clicks into place.

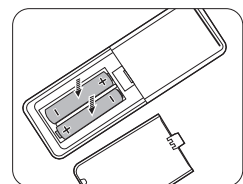
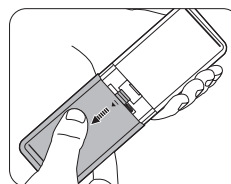



- Avoid leaving the remote control and batteries in an excessive heat or humid environment like the kitchen, bathroom, sauna, sunroom or in a closed car.
- Replace only with the same or equivalent type recommended by the battery manufacturer.
- Dispose of the used batteries according to the manufacturer's instructions and local environment regulations for your region.
- Never throw the batteries into a fire. There may be danger of an explosion.
- If the batteries are dead or if you will not be using the remote control for an extended period of time, remove the batteries to avoid damage to the remote control from possible battery leakage.

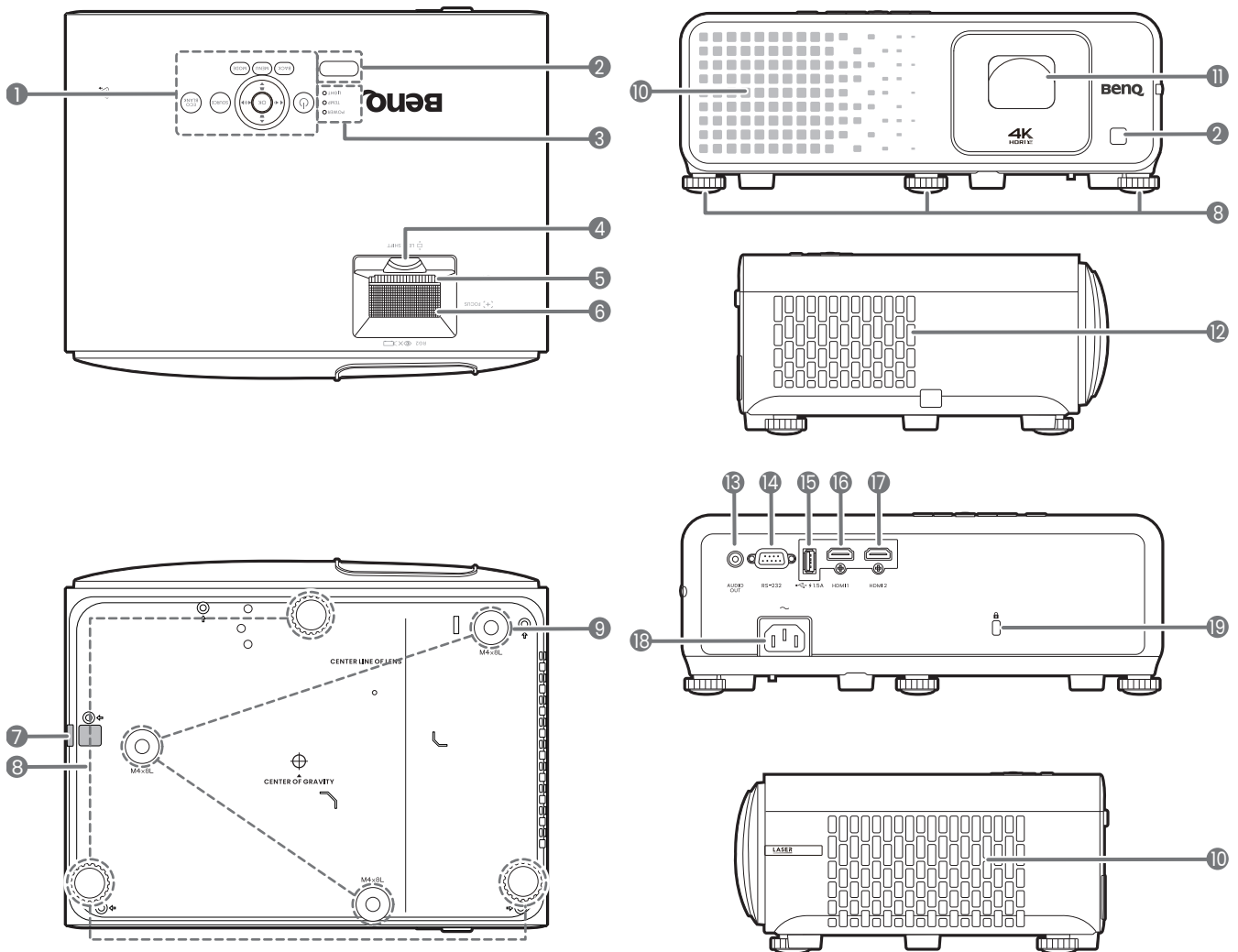

# Projector exterior view



1. External control panel  
(See [Controls and functions on page 10.](#))
2. IR remote sensor
3. **POWER indicator light/TEMPerature warning light/LIGHT indicator light**  
(See [Indicators on page 44.](#))
4. Lens shift adjustment control  
( Up/Down  
)
5. Zoom ring
6. Focus ring
7. Security bar
8. Adjuster feet
9. Ceiling/Wall mount holes
10. Vent (air inlet)

11. Projection lens
12. Vent (air exhaust)
13. Audio output jack
14. RS-232 control port
15. USB-A port with power charging
16. HDMI 1 input port
17. HDMI 2 input port
18. AC power jack
19. Kensington anti-theft lock slot

# Controls and functions

## Projector & Remote control



All the key presses described in this document are available on the remote control or projector.

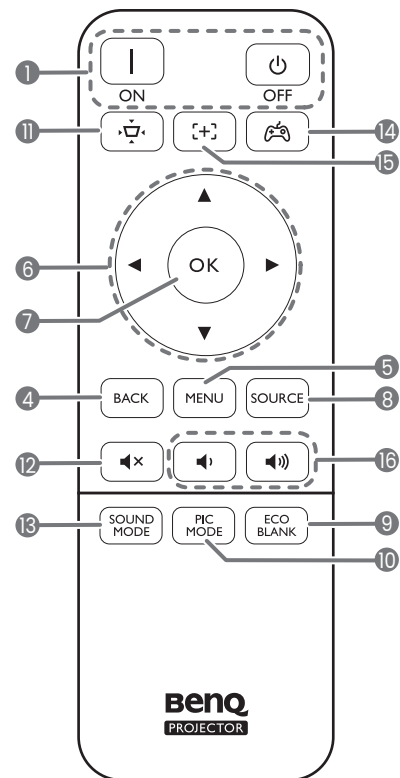
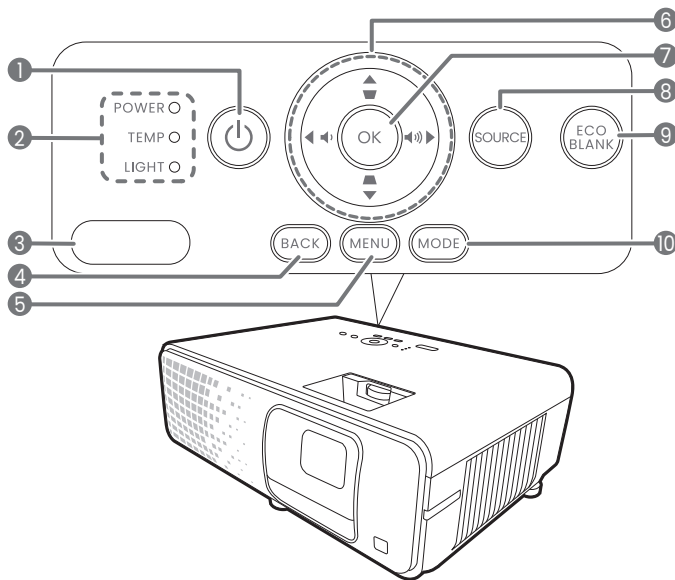

1. **POWER**  
Toggles the projector between standby mode and on.  
 **ON** / **Off**  
Toggles the projector between standby mode and on.
2. **POWER indicator light/TEMPerature warning light/LIGHT indicator light** (See [Indicators on page 44.](#))
3. IR remote sensor
4. **BACK**  
Goes back to previous OSD menu, exits and saves menu settings.
5. **MENU**  
Turns on/off the On-Screen Display (OSD) menu.

6. **Arrow keys** ( , , , )  
When the On-Screen Display (OSD) menu is activated, these keys are used as directional arrows to select the desired menu items and to make adjustments.  
When OSD menu is inactive, workable under CEC-capable sources only.  
Keystone keys ( , )  
Displays the keystone correction page.  
Volume keys ( / )  
Decreases or increase the projector volume.
7. **OK**  
Confirms the selected On-Screen Display (OSD) menu item.

## 8. SOURCE

Displays the source selection bar.

## 9. ECO BLANK

Used to hide the screen picture.



Do not block the projection lens from projecting as this could cause the blocking object to become heated and deformed or even cause a fire.

## 10. MODE/PIC MODE

Displays the picture mode menu.



Displays the keystone menu. See [Correcting keystone on page 17](#) for details.



Toggles projector audio between on and off.

## 13. SOUND MODE

Displays the sound mode menu.



Displays the **Game Settings** menu.



Activates Auto Focus.

\*Available on compatible projectors only.



Decreases or increase the projector volume.

## Remote control effective range

The remote control must be held at an angle within 30 degrees perpendicular to the projector's IR remote control sensor(s) to function correctly. The distance between the remote control and the sensor(s) should not exceed 8 meters (~ 26 feet).

Make sure that there are no obstacles between the remote control and the IR sensor(s) on the projector that might obstruct the infra-red beam.

- Operating the projector from the front

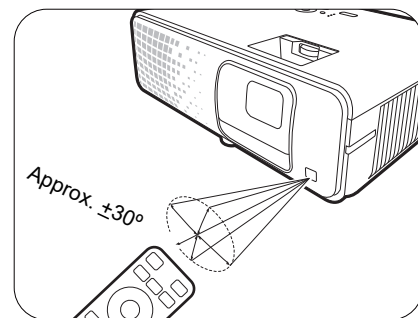

- Operating the projector from the top

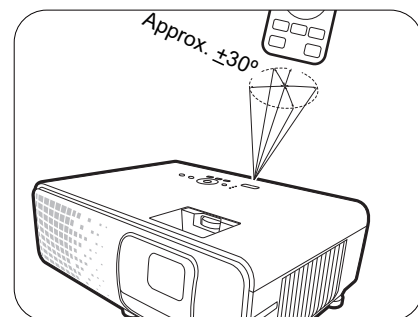

# Positioning your projector

## Choosing a location

Before choosing an installation location for your projector, take the following factors into consideration:

- Size and position of your screen
- Electrical outlet location
- Location and distance between the projector and the rest of your equipment

You can install your projector in the following ways.

---

### 1. Front

Select this location with the projector placed on the table in front of the screen. This is the most common way to position the projector for quick setup and portability.

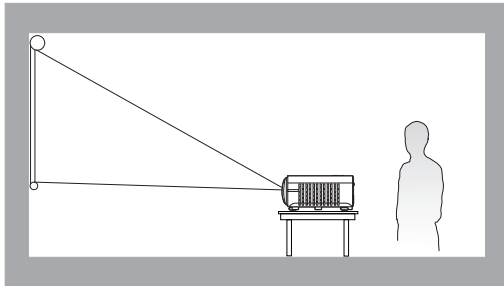

### 2. Rear

Select this location with the projector placed on the table behind the screen. Note that a special rear projection screen is required.

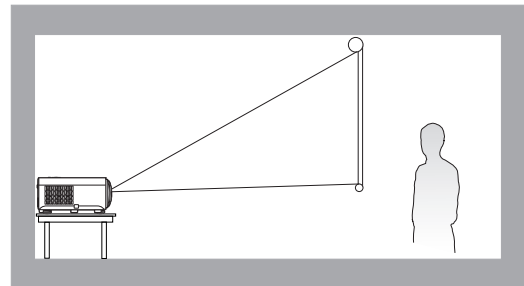

### 3. Front Ceiling

Select this location with the projector suspended upside-down in front of the screen. Purchase the BenQ Projector Ceiling/Wall Mount Kit from your dealer to mount your projector.

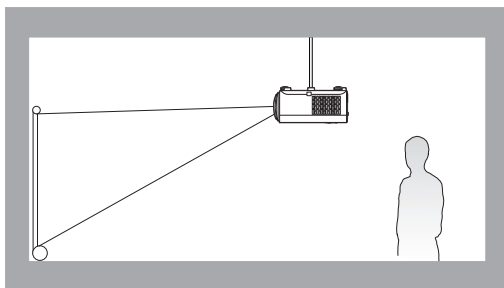

### 4. Rear Ceiling

Select this location with the projector suspended upside-down from behind the screen. Note that a special rear projection screen and the BenQ Projector Ceiling/Wall Mount Kit are required for this installation location.

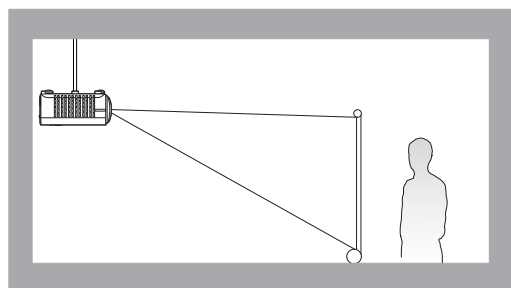

---

After turning on the projector, the projector will automatically select a suitable setting for the way the projector is installed. If not, go to the **Advanced Menu - Installation > Projector Position** and press ◀/▶ to select a setting.

# Obtaining a preferred projected image size

The distance from the projector lens to the screen, the zoom setting (if available), and the video format each factors in the projected image size.

## Projection dimensions

- The screen aspect ratio is 16:9 and the projected picture is in a 16:9 aspect ratio

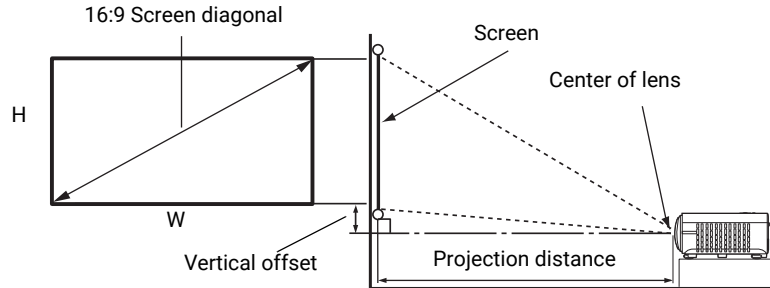

Screen size				Projection distance in mm			Vertical offset	
Diagonal		H	W	Min.	Average	Max.	Min.	Max.
(inch)	(mm)	(mm)	(mm)	(Wide)		(Tele)	(mm)	(mm)
30	762	374	664	764	880	996	19	56
40	1016	498	886	1018	1173	1328	25	75
50	1270	623	1107	1273	1467	1660	31	93
60	1524	747	1328	1528	1760	1992	37	112
70	1778	872	1550	1782	2053	2324	44	131
80	2032	996	1771	2037	2347	2657	50	149
90	2286	1121	1992	2291	2640	2989	56	168
100	2540	1245	2214	2546	2933	3321	62	187
110	2794	1370	2435	2800	3227	3653	68	205
115	2921	1432	2546	2928	3373	3819	72	215
120	3048	1494	2657	3055	3520	3985	75	224
130	3302	1619	2878	3310	3813	4317	81	243
140	3556	1743	3099	3564	4107	4649	87	262
150	3810	1868	3321	3819	4400	4981	93	280
160	4064	1992	3542	4073	4693	5313	100	299
170	4318	2117	3763	4328	4987	5645	106	318
180	4572	2241	3985	4583	5280	5977	112	336
190	4826	2366	4206	4837	5573	6309	118	355
200	5080	2491	4428	5092	5867	6641	125	374
210	5334	2615	4649	5346	6160	6973	131	392
220	5588	2740	4870	5601	6453	7306	137	411
230	5842	2864	5092	5856	6747	7638	143	430
240	6096	2989	5313	6110	7040	7970	149	448
250	6350	3113	5535	6365	7333	8302	156	467
260	6604	3238	5756	6619	7627	8634	162	486
270	6858	3362	5977	6874	7920	8966	168	504
280	7112	3487	6199	7128	8213	9298	174	523
290	7366	3611	6420	7383	8507	9630	181	542
300	7620	3736	6641	7638	8800	9962	187	560

For example, if you are using a 100-inch screen, the recommended projection distance is 2933 mm.

If your measured projection distance is 2000 mm, the closest match in the "Projection distance in mm" column is 2053 mm. Looking across this row shows that a 70" (about 1.8 m) screen is required. The projected image will be slightly higher/lower than the lens centerline with 44 - 131 mm vertical offset.

 To optimize your projection quality, we suggest doing the projection by referring to the values listed in the non-gray rows. The values in the gray cells are for reference only.

 All measurements are approximate and may vary from the actual sizes. BenQ recommends that if you intend to permanently install the projector, you should physically test the projection size and distance using the actual projector in situ before you permanently install it, so as to make allowance for this projector's optical characteristics. This will help you determine the exact mounting position so that it best suits your installation location.

## Adjusting the projector position

### Shifting the projection lens

The lens shift control provides flexibility for installing your projector. It allows the projector to be positioned off the center of the screen.

The lens shift is expressed as a percentage of the projected image height or width. You can turn the knob on the projector to shift the projection lens within the allowable range depending on your desired image position.

Desk-front projection

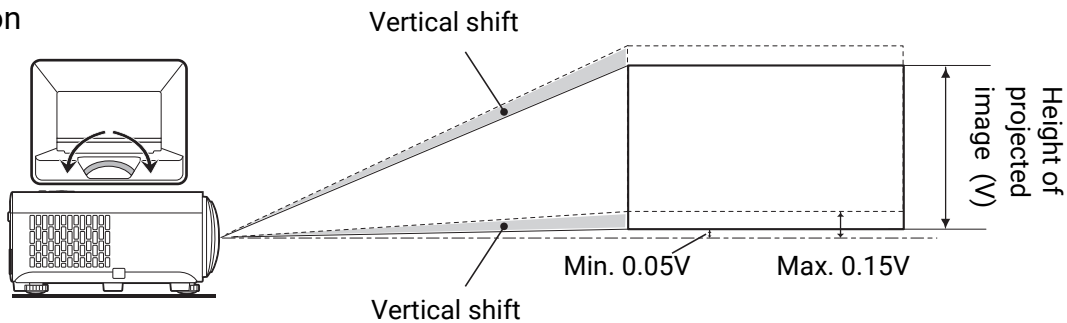

Ceiling mount-front projection

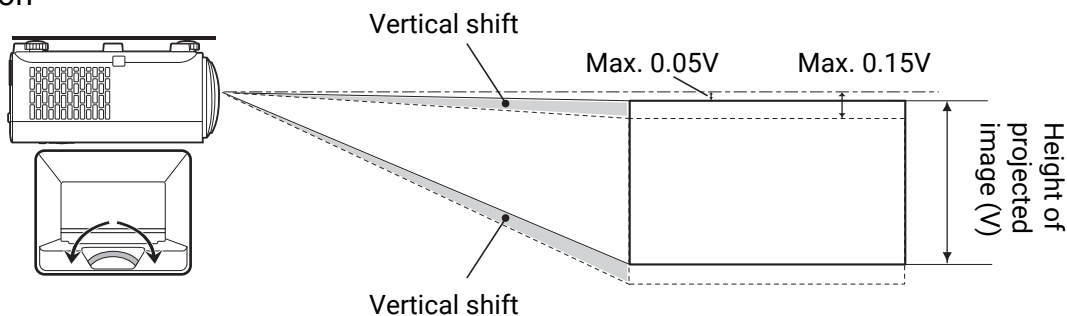

## Mounting the projector

If you intend to mount your projector, we strongly recommend that you use a proper fitting BenQ projector mounting kit and that you ensure it is securely and safely installed.

If you use a non-BenQ brand projector mounting kit, there is a safety risk that the projector may fall down due to an improper attachment through the use of the wrong gauge or length screws.

### Before mounting the projector

- Purchase a BenQ projector mounting kit from the place you purchased your BenQ projector.
- BenQ recommends that you also purchase a separate Kensington lock compatible security cable and attach it securely to both the Kensington lock slot on the projector and the base of the mounting bracket. This will perform the secondary role of restraining the projector should its attachment to the mounting bracket become loose.
- Ask your dealer to install the projector for you. Installing the projector on your own may cause it to fall and result in injury.
- Take necessary procedures to prevent the projector from falling off such as during an earthquake.
- The warranty doesn't cover any product damage caused by mounting the projector with a non-BenQ brand projector mounting kit.
- Consider the surrounding temperature where the projector is ceiling/wall mounted. If a heater is used, the temperature around the ceiling/wall may be higher than expected.
- Read the user manual for the mounting kit about the range of torque. Tightening with torque exceeding the recommended range may cause damage to the projector and subsequently falling off.
- Make sure the power outlet is at an accessible height so that you can easily shut down the projector.

### Ceiling/Wall mount installation diagram

Ceiling/Wall mount screw: M4  
(Max L = 25 mm; Min L = 20 mm)

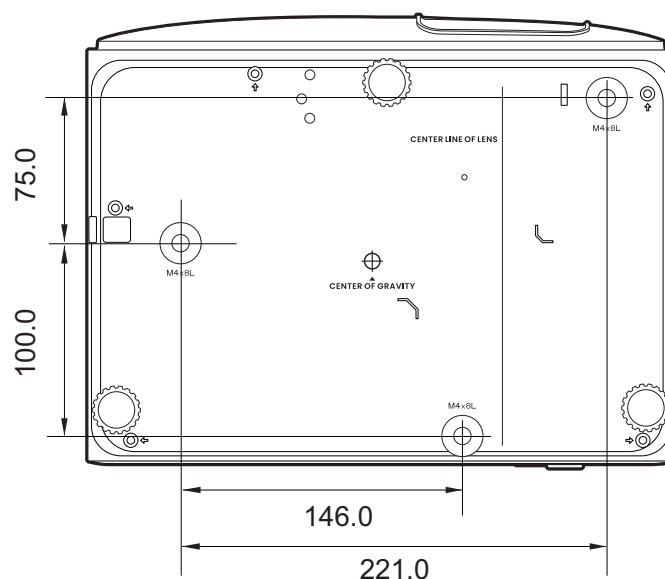

Unit: mm

# Adjusting the projected image

## Adjusting the projection angle

If the projector is not placed on a flat surface or the screen and the projector are not perpendicular to each other, the projected image becomes trapezoidal. You can screw the adjuster feet to fine-tune the horizontal angle.

To retract the feet, screw the adjuster feet in a reverse direction.

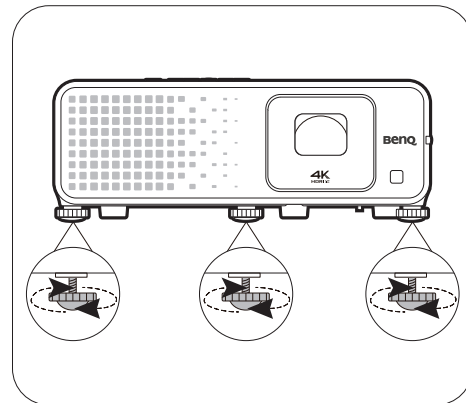

**!** Do not look into the lens while the light source is on. The strong light from the light source may cause damage to your eyes.

## Fine-tuning the image size and clarity

- Adjust the projected image to the size that you need using the zoom ring.
- Sharpen the image by rotating the focus ring.

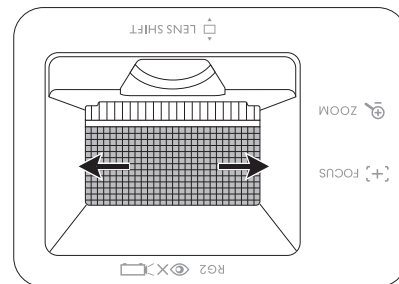
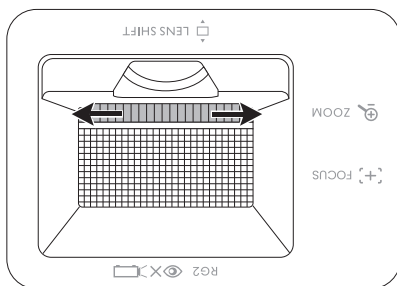

## Adjusting image corners

You can manually adjust four corners of the image by setting the horizontal and vertical values.

1. Go to the **Basic/Advanced** menu - **Installation > 4 Point Adjustment** and press **OK** to display the correction page.
2. Press **▲/▼/◀/▶** to select one corner and press **OK**.
3. Press **▲/▼** to adjust vertical values.
4. Press **◀/▶** to adjust horizontal values.

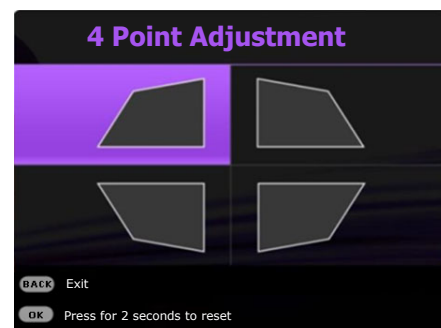



## Correcting keystone

Keystoning refers to the situation where the projected image becomes a trapezoid due to angled projection.

.

To correct the distorted image:

1. Display the **3D Keystone** correction page from the following menus.
  - The setup wizard during the projector initial setup
  - Press **▲/▼** on the projector.
  - Go to the **Basic/Advanced Menu - Installation > 3D Keystone** and press **OK**.
2. After the **3D Keystone** correction page appears:
  - Press **◀/▶** to select V, H, or R. Selecting V corrects the vertical sides keystone. Selecting H corrects the horizontal sides keystone. Selecting R rotates the projected image clockwise or counterclockwise.
  - Press **▲/▼** to adjust its value.
  - To automatically correct the vertical sides of the distorted image, press **OK** for 2 seconds.
3. When done, press **BACK** to save your changes and exit.

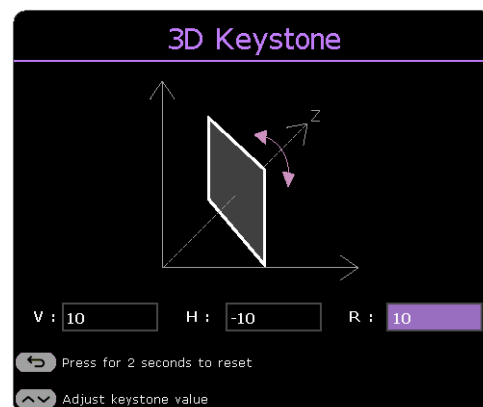
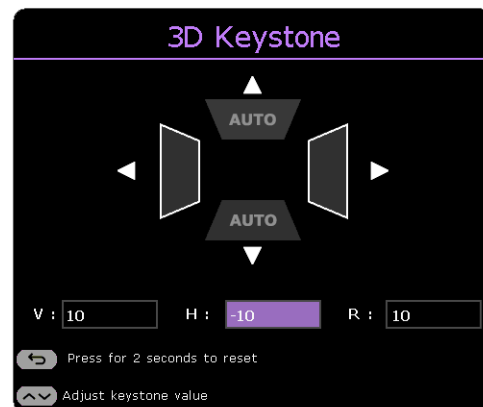
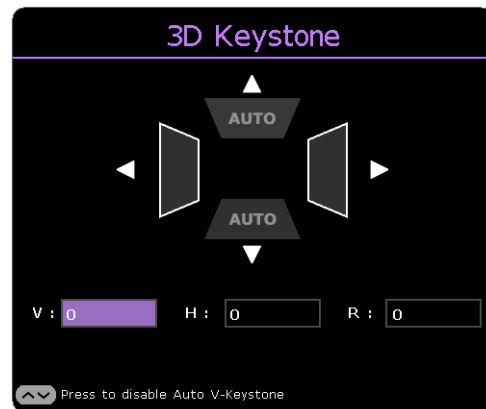

# Connection

When connecting a signal source to the projector, be sure to:

1. Turn all equipment off before making any connections.
2. Use the correct signal cables for each source.
3. Ensure the cables are firmly inserted.

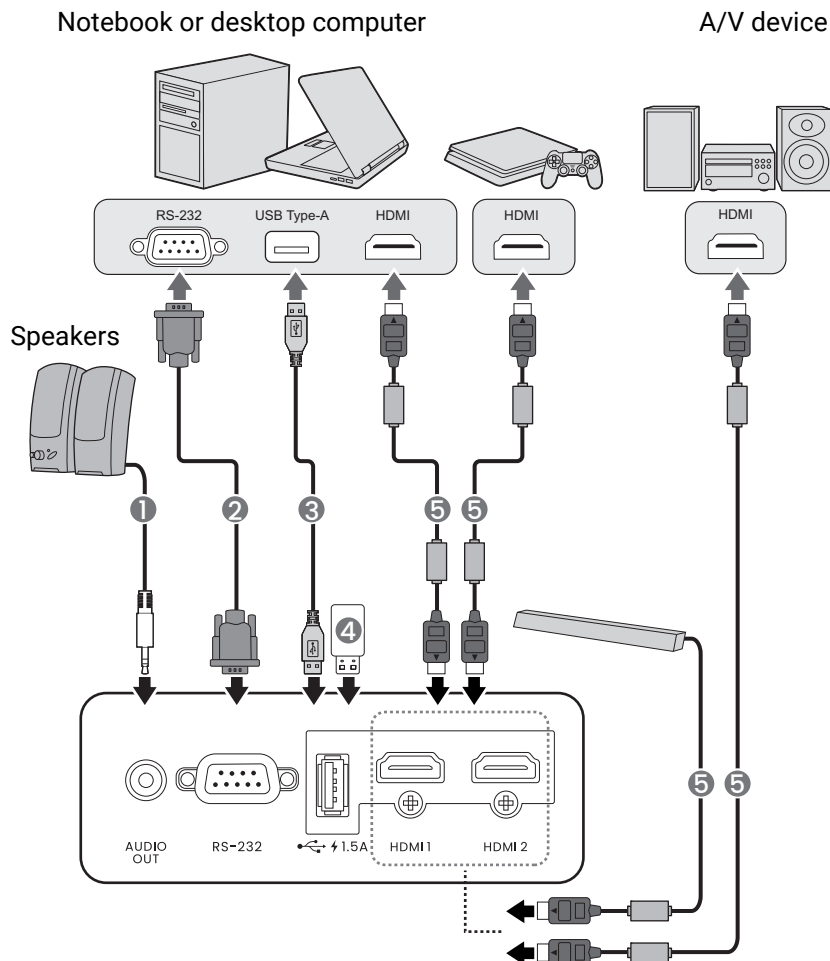

- |                |                   |
|----------------|-------------------|
| ① Audio cable  | ④ USB flash drive |
| ② RS-232 cable | ⑤ HDMI cable      |
| ③ USB-A cable  |                   |



- In the connections above, some cables may not be included with the projector (see [Shipping contents on page 8](#)). They are commercially available from electronics stores.
- The connection illustrations are for reference only. The rear connecting jacks available on the projector vary with each projector model.
- Many notebooks do not turn on their external video ports when connected to a projector. Usually a key combo like FN + function key with a monitor symbol turns the external display on/off. Press FN and the labeled function key simultaneously. Refer to your notebook's documentation to find your notebook's key combination.
- If the selected video image is not displayed after the projector is turned on and the correct video source has been selected, check that the video source device is turned on and operating correctly. Also check that the signal cables have been connected correctly.

## Connecting audio

The projector has built-in mono speaker(s) which are designed to provide basic audio functionality accompanying data presentations for business purposes only. They are not designed for, nor intended for stereo audio reproduction use as might be expected in home theater or home cinema applications. Any stereo audio input (if provided), is mixed into a common mono audio output through the projector speaker(s).



The built-in speaker(s) will be muted when the **AUDIO OUT** jack is connected.



- The projector is only capable of playing mixed mono audio, even if a stereo audio input is connected.
- If the selected video image is not displayed after the projector is turned on and the correct video source has been selected, check that the video source device is turned on and operating correctly. Also check that the signal cables have been connected correctly.





# Operation

## Starting up the projector

1. Plug the power cord. Turn on the power outlet switch (where fitted). The power indicator on the projector lights orange after power has been applied.
2. Press  on the projector or  on the remote control to start the projector. The power indicator flashes green and stays green when the projector is on.

The start up procedure takes about 10 seconds. In the later stage of start up, a startup logo is projected.

(If necessary) Rotate the focus ring to adjust the image clearness.

3. If this is the first time you turn on the projector, the setup wizard appears to guide you through setting up the projector. If you have already done this, skip this step and move on to the next step.
  - Use the arrow keys (///) on the projector or remote control to move through the menu items.
  - Use **OK** to confirm the selected menu item.

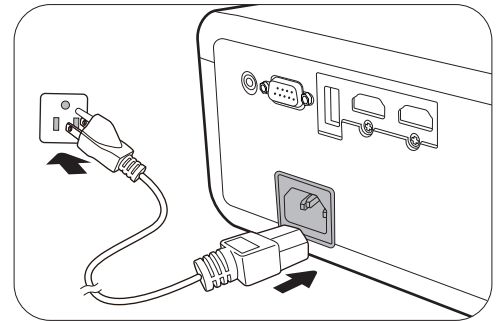

### Step 1:

#### Specify **Projector Position**.

For more information about projector position, see [Choosing a location on page 12](#).

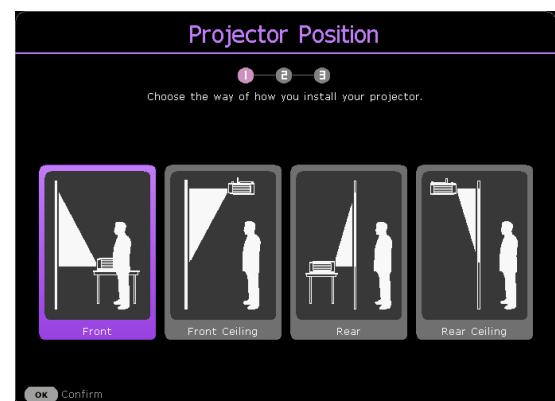

### Step 2:

#### Specify OSD **Language**.

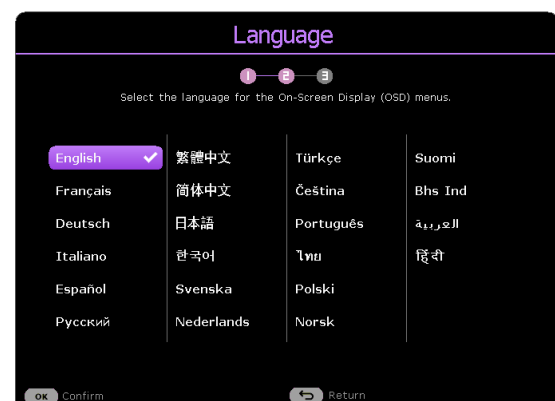

Step 3:

Specify **3D Keystone**, and choose to activate **Auto Vertical Keystone**.

For more information about keystone, see [Correcting keystone on page 17](#).

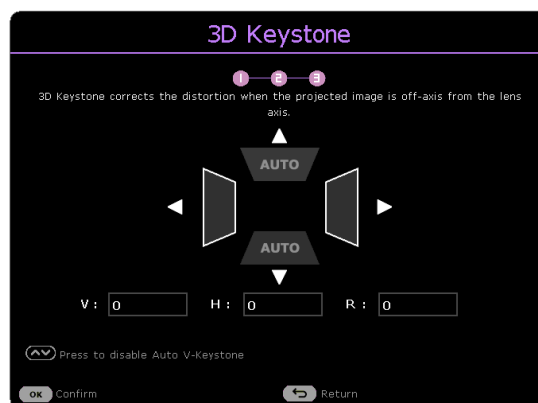

4. If you are prompted for a password, press the arrow keys to enter a 6-digit password. See [Utilizing the password function on page 23](#).
5. Switch all of the connected equipment on.
6. The projector will search for input signals. The current input signal being scanned appears. If the projector does not detect a valid signal, the message “No Signal” will continue displaying until an input signal is found.

You can also press **SOURCE** to select your desired input signal. See [Switching input signal on page 25](#).



- Please use the original accessories (e.g. power cord) to avoid possible dangers such as electric shock and fire.
- If the projector is still hot from previous activity, it will run the cooling fan for approximately 90 seconds before energizing the light source.



- The Setup Wizard screenshots are for reference only and may differ from the actual design.
- If the frequency/resolution of the input signal exceeds the projector's operating range, you will see the message “Out of Range” displayed on the background screen. Please change to an input signal which is compatible with the projector's resolution or set the input signal to a lower setting. See [Timing chart on page 48](#).
- If no signal is detected for 3 minutes, the projector automatically enters saving mode.

# Using the menus

The projector is equipped with 2 types of On-Screen Display (OSD) menus for making various adjustments and settings.

- **Basic** OSD menu: provides primary menu functions. (See [Basic Menu on page 26](#))
- **Advanced** OSD menu: provides full menu functions. (See [Advanced Menu on page 27](#))

To access the OSD menu, press **MENU** on the projector or remote control.

- Use the arrow keys (▲/▼/◀/▶) on the projector or remote control to move through the menu items.
- Use **OK** on the projector or remote control to confirm the selected menu item.

The first time you use the projector (after finishing the initial setup), press **MENU**, and the **Basic** OSD menu will be displayed.



The OSD screenshots below are for reference only, and may differ from the actual design.

Below is the overview of the **Basic** OSD menu.

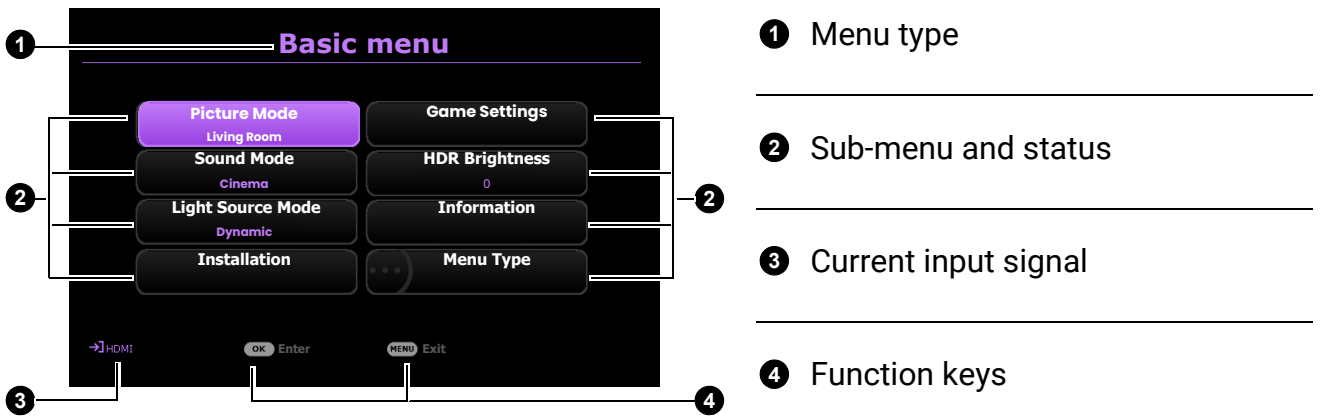

If you intend to switch from the **Basic** OSD menu to the **Advanced** OSD menu, follow the instructions below:

1. Go to **Menu Type** and press **OK**.
2. Press ▲ / ▼ to select **Advanced** and press **OK**. Your projector will switch to **Advanced** OSD menu.

Below is the overview of the **Advanced** OSD menu.

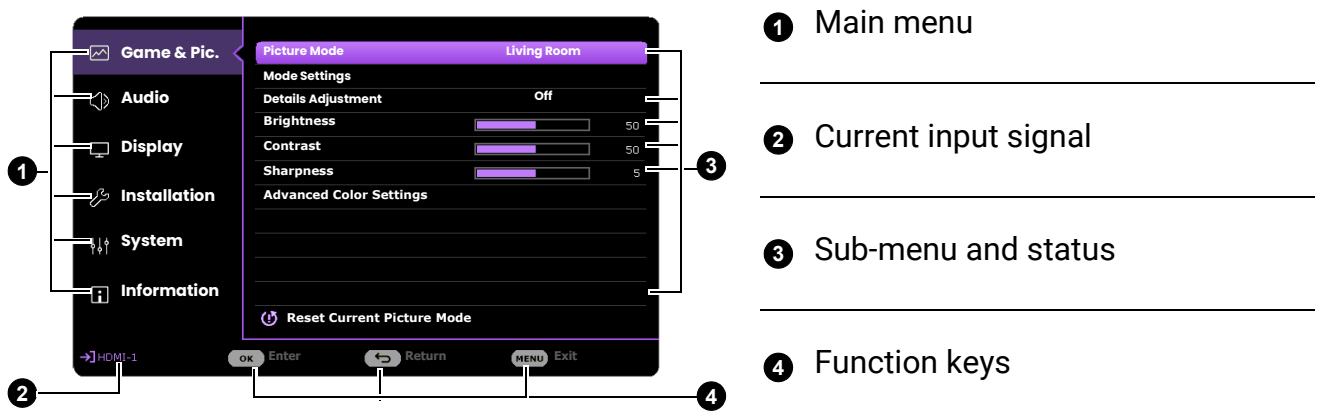

Likewise, when you wish to switch from the **Advanced** OSD menu to the **Basic** OSD menu, follow the instructions below:

1. Go to **System > Menu Settings > Menu Type** and press **OK**.
2. Press **▲/▼** to select **Basic**. Your projector will switch to the **Basic** OSD menu.

## Securing the projector

### Using a security cable lock

The projector has to be installed in a safe place to prevent theft. Otherwise, purchase a lock, such as the Kensington lock, to secure the projector. You can locate a Kensington lock slot on the rear side of the projector. See item 19 on [page 9](#).

A Kensington security cable lock is usually a combination of key(s) and the lock. Refer to the lock's documentation for finding out how to use it.

## Utilizing the password function

### Setting a password

1. Go to the **Advanced** menu - **System > Security Settings**. Press **OK**. The **Security Settings** page appears.
2. Highlight **Change Password** and press **OK**.
3. The four arrow keys (**▲**, **▶**, **▼**, **◀**) respectively represent 4 digits (1, 2, 3, 4). According to the password you desire to set, press the arrow keys to enter six digits for the password.
4. Confirm the new password by re-entering the new password.
5. To activate the **Power On Lock** function, press **▲/▼** to highlight **Power On Lock** and press **◀/▶** to select **On**. Input the password again.

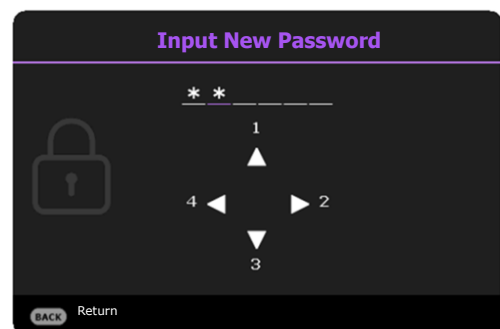

- The digits being input will display as asterisks on-screen. Make a note of your selected password and keep it in a safe place in advance or right after the password is entered so that it is available to you should you ever forget it.
- Once a password has been set and the power on lock is activated, the projector cannot be used unless the correct password is entered every time the projector is started.

### If you forget the password

If you enter the wrong password, the password error message will appear, and the **Input Password** message follows. If you absolutely do not remember the password, you can use the password recall procedure. See [Entering the password recall procedure on page 24](#).

If you enter an incorrect password 5 times in succession, the projector will automatically shut down in a short time.

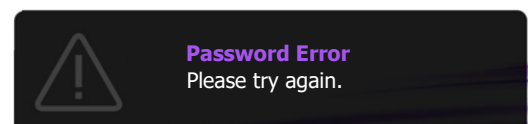

## Entering the password recall procedure

1. Press and hold **OK** for 3 seconds. The projector will display a coded number on the screen.
2. Write down the number and turn off your projector.
3. Seek help from the local BenQ service center to decode the number. You may be required to provide proof of purchase documentation to verify that you are an authorized user of the projector.

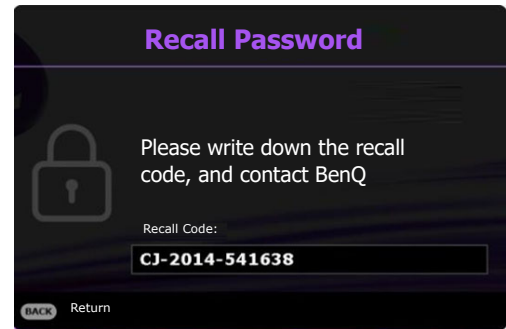

## Changing the password

1. Go to the **Advanced** menu - **System** > **Security Settings** > **Password**. Press **OK**. The **Password** page appears.
2. Highlight **Change Password** and press **OK**.
3. Enter the old password.
  - If the password is correct, another message "**Input New Password**" appears.
  - If the password is incorrect, the password error message will appear, and the message "**Input Password**" appears for your retry. You can press **BACK** to cancel the change or try another password.
4. Enter a new password.
5. Confirm the new password by re-entering the new password.

## Disabling the password function

1. Go to the **Advanced** menu - **System** > **Security Settings** > **Password** > **Power On Lock** and press **OK** and **◀/▶** to select **Off**. The message **Input Password** appears.
2. Enter the current password.
  - If the password is correct, the OSD menu will disappear. You will not have to enter the password next time turning on the projector.
  - If the password is incorrect, the password error message will appear, and the message **Input Current Password** appears for your retry. You can press **BACK** to cancel the change or try another password.



Though the password function is disabled, you need to keep the old password in hand should you ever need to re-activate the password function by entering the old password.



## Switching input signal

The projector can be connected to multiple devices at the same time. However, it can only display one full screen at a time. When starting up, the projector automatically searches for the available signals.

Be sure the **Advanced** menu - **Display > Auto Source Search** menu is **On** if you want the projector to automatically search for the signals.

To select the source:

1. Press **SOURCE**. A source selection bar appears.
2. Press **▲/▼** until your desired signal is selected and press **OK**.

Once detected, the selected source information will appear at the corner of the screen for seconds. If there is multiple equipment connected to the projector, repeat steps 1-2 to search for another signal.



- The brightness level of the projected image will change accordingly when you switch between different input signals.
- For best display picture results, you should select and use an input signal which outputs at the projector's native resolution. Any other resolutions will be scaled by the projector depending upon the "aspect ratio" setting, which may cause some image distortion or loss of picture clarity. See [Aspect Ratio on page 34](#).

## Shutting down the projector

1. Press **⏻** on the projector or **⏻** on the remote control and a confirmation message will appear prompting you. If you don't respond in a few seconds, the message will disappear.
2. Press **⏻** or **⏻** a second time. The power indicator flashes orange, the projection light source shuts down, and the fans will continue to run for approximately 2 seconds to cool down the projector.
3. Once the cooling process finishes, the power indicator becomes a steady orange and fans stop. Disconnect the power cord from the power outlet.

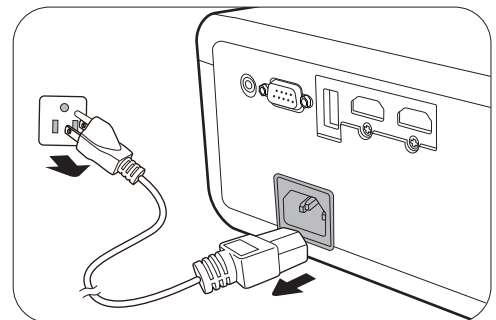

- To protect the light source, the projector will not respond to any commands during the cooling process.

# Menu operation

Please note that the on-screen display (OSD) menus vary according to the signal type selected and the projector model you are using.

The menu items are available when the projector detects at least one valid signal. If there is no equipment connected to the projector or no signal detected, limited menu items are accessible.

## Menu System

### Basic Menu

Menu (Ref. Page)	Options
Picture Mode (28)	Bright/Living Room/ RPG/HDR-RPG/FPS/HDR-FPS/ Cinema/3D/HDR10/User/HDR-User/HLG
Sound Mode (32)	Cinema/Music/FPS/User
Light Source Mode (43)	Normal
	ECO
	Dynamic
3D Keystone (17)	H: -30~0~30
	V: -30~0~30
	R: -30~0~30
Installation	Top Left
	4 Point Adjustment (16)
	Top Right
	Bottom Left
	Bottom Right
Game Settings	Picture Mode (28) (Refer to the Picture Mode options.)
	Details Adjustment (29)
	Off/Low/High
HDR Brightness (31)	-2/-1/0/1/2
Information (41)	Detected Resolution
	Source
	Picture Mode
	Light Source Mode
	Sound Mode
	3D Format
	Color System
	Dynamic Range
	Light Source Usage Time
	Firmware Version
	Service Code
Menu Type (39)	Basic/Advanced

# Advanced Menu

## 1. Main menu: **Game & Pic.**

### Structure

Menu		Options	
Picture Mode		Bright/Living Room/ RPG/HDR-RPG/ FPS/HDR-FPS/ Cinema/3D/HDR10/ User/HDR-User/ HLG	
Mode Settings	Copy Settings From	Living Room/ RPG/HDR-RPG/ FPS/HDR-FPS/ Cinema/HDR10	
	Rename Picture Mode		
Details Adjustment		Off/Low/High	
Brightness		0-100	
Contrast		0-100	
Sharpness		0-15	
Advanced Color Settings	Gamma Selection	1.8/2.0/2.1/2.2/2.3/2.4/2.5/2.6/BenQ Native (for Bright picture mode)	
	Color Temperature Tuning	Color Temperature	Normal/Cool/Warm (for the rest picture modes)
		R Gain/ G Gain/ B Gain	0-200
		R Offset/ G Offset/ B Offset	0-511
		Reset	
	Color Management	R/G/B/C/M/Y	Hue/Saturation/Gain
		White Balance (W)	R Gain/G Gain/B Gain
		Reset	Reset/Cancel
	Light Source Mode		Normal/ECO/Dynamic
	HDR Brightness		-2/-1/0/1/2
Noise Reduction		0-15	
Reset Current Picture Mode		Reset/Cancel	

## Function descriptions

Menu	Descriptions
	<p>The projector is preset with several predefined picture modes so that you can choose one to suit your operating environment and input signal picture type.</p> <ul style="list-style-type: none"><li>• <b>Bright</b> Maximizes the brightness of the projected image. This mode is suitable for environments where extra-high brightness is required.</li><li>• <b>Living Room</b> With well-saturated color, fine-tuned sharpness, and a higher brightness level, this mode is suitable for TV streaming in rooms where there is a small amount of ambient light, e.g. your living room.</li><li>• <b>RPG/HDR-RPG</b> Provides CinematicColor and powerful cinema sound as if in a film-like and role-playing game world. <b>Sound Mode</b> will automatically switch to <b>Cinema</b>. <b>HDR-RPG</b> is selectable when the projector reads HDR contents.</li><li>• <b>FPS/HDR-FPS</b> Enhances detail viewing experience by revealing all the enemies hidden in the dark shadow, and provides surrounding sound to hear the distant footsteps and gunshot and recognize their directions. <b>Sound Mode</b> will automatically switch to <b>FPS</b>. <b>HDR-FPS</b> is selectable when the projector reads HDR contents.</li></ul>
<b>Picture Mode</b>	<ul style="list-style-type: none"><li>• <b>Cinema</b> This mode is best for watching movies with accurate color and deepest contrast at lower brightness level in rooms with a bit of ambient light, as if in a commercial cinema.</li><li>• <b>3D</b> Is appropriate for playing 3D images and 3D video clips. This mode is only available when 3D function is enabled and 3D content is detected.</li><li>• <b>HDR10</b> Delivers High Dynamic Range effects with higher contrasts of brightness and colors for HDR Blu-ray movies. <b>Picture Mode</b> will be switched to <b>HDR10</b> automatically while detecting metadata or EOTF info from HDR contents.</li><li>• <b>User/HDR-User</b> Recalls the settings customized based on the current available picture modes. See <a href="#">Mode Settings on page 29</a>.</li><li>• <b>HLG</b> Delivers High Dynamic Range effects with higher contrasts of brightness and colors. <b>Picture Mode</b> will be switched to <b>HLG</b> automatically while detecting metadata or EOTF info from HLG streaming contents.</li></ul>

---

There is one user-definable mode if the current available picture modes are not suitable for your need. You can use one of the picture modes (except the **User/HDR-User** mode) as a starting point and customize the settings.

• **Copy Settings From**

1. Go to **Game & Pic. > Picture Mode**, and press **OK**.
2. Press **▼/▲** to select **User/HDR-User**, and press **OK**.
3. Press **▼** to highlight **Mode Settings**, and press **OK**. The **Mode Settings** page is displayed.
4. Select **Copy Settings From** and press **OK**.
5. Press **▼/▲** to select a picture mode that is closest to your need.
6. Press **OK** and **BACK** to return to the **Game & Pic.** menu.
7. Press **▼** to select the sub-menu items you want to change and adjust the values with **◀/▶**. The adjustments define the selected user mode.

• **Rename Picture Mode**

Select to rename the customized picture mode (**User/HDR-User**). The new name can be up to 9 characters including English letters (A-Z, a-z), digits (0-9), and space (\_).

1. Go to **Game & Pic. > Picture Mode**, and press **OK**.
2. Press **▼/▲** to select **User/HDR-User**, and press **OK**.
3. Press **▼** to highlight **Mode Settings**, and press **OK**. The **Mode Settings** page is displayed.
4. Press **▼** to highlight **Rename Picture Mode** and press **OK**. The **Rename Picture Mode** page is displayed.
5. Press **OK** to activate the keyboard.
6. Press **▲/▶/▼/◀** to select a desired characters, and press **OK** to confirm the selection. Repeat this step until all the characters are being input.
7. Press **BACK** and **▼** to highlight **Commit**, and press **OK**.
8. Press **BACK** to save the change and exit.

## Mode Settings

---

<b>Details Adjustment</b>	Adjusts the level of detail clarity. The higher the effect, the more details will be shown but with lower black performance.
<b>Brightness</b>	The higher the value, the brighter the image. Adjust this control so the black areas of the image appear just as black and that detail in the dark areas is visible.
<b>Contrast</b>	The higher the value, the greater the contrast. Use this to set the peak white level after you have previously adjusted the Brightness setting to suit your selected input and viewing environment.
<b>Sharpness</b>	The higher the value, the sharper the picture becomes.

---

---

### • Gamma Selection

Gamma refers to the relationship between input source and picture brightness.

- **1.8/2.0/2.1/BenQ:** Select these values according to your preference.
- **2.2/2.3:** Increases the average brightness of the picture. Best for a lit environment, meeting room or family room.
- **2.4/2.5:** Best for viewing movies in a dark environment.
- **2.6:** Best for viewing movies which are mostly composed of dark scenes.

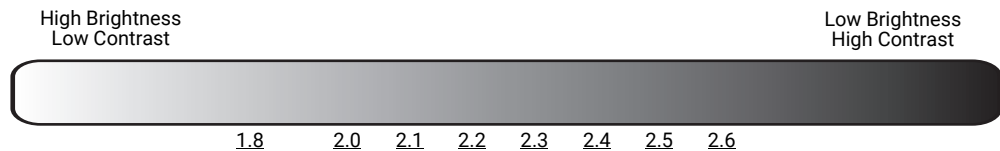

### • Color Temperature Tuning

## Advanced Color Settings

There are several preset color temperature settings available. The available settings may vary according to the signal type selected.

When **Bright** is selected for **Picture Mode**, the color temperature switches to **Native**, and cannot be changed.

- **Native:** With the light source's original color temperature and higher brightness. This setting is suitable for environments where high brightness is required, such as projecting pictures in well lit rooms.
- **Normal:** Maintains normal colorings for white.
- **Cool:** Makes images appear bluish white.
- **Warm:** Makes images appear reddish white.

You can also set a preferred color temperature by adjusting the following options.

- **R Gain/G Gain/B Gain:** Adjusts the contrast levels of Red, Green, and Blue.
- **R Offset/G Offset/B Offset:** Adjusts the brightness levels of Red, Green, and Blue.

To return all the settings to the factory default values, highlight **Reset**, and press **OK**.

---

---

## • Color Management

The Color Management provides six sets (RGBCMY) of colors to be adjusted. When you select each color, you can independently adjust its range and saturation according to your preference.

To make adjustments, press the ▲/▼ arrows to highlight an independent color from among Red (R), Green (G), Blue (B), Cyan (C), Magenta (M), Yellow (Y) or White (W). The following menu items are displayed for your choice.

- **Hue:** Press ▲/▼ to adjust the video hue of the selected primary color.
- **Saturation:** Press ▲/▼ to adjust the video saturation of the selected primary color.
- **Gain:** Press ▲/▼ to adjust the video gain of the selected primary color.

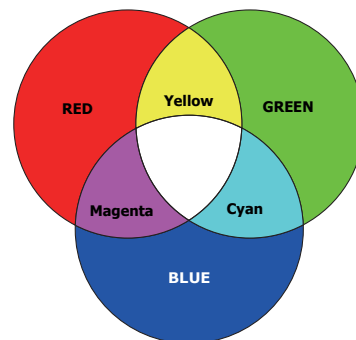

## Advanced Color Settings (Continued)

If you select **White Balance (W)**, you can adjust the contrast levels of Red, Green, Blue, Cyan, Magenta, Yellow and White by selecting **R Gain, G Gain, and B Gain**.

To return all the settings to the factory default values, highlight **Reset**, and press **OK**.



**Saturation** is the amount of that color in a video picture. Lower settings produce less saturated colors; a setting of "0" removes that color from the image entirely. If the saturation is too high, that color will be overpowering and unrealistic.

## • Light Source Mode

Selects a suitable light source power from among the provided modes. See [Extending light source life on page 43](#).

## • HDR Brightness

You can manually select a brightness level to display better picture quality. When the value is higher, the image becomes brighter; when the value is lower, the image becomes darker.

## • Noise Reduction

Reduces electrical image noise caused by different media players.

---

Returns all of the adjustments you've made for the selected **Picture Mode** (including the preset mode, **User** and **HDR-User**) to the factory preset values.

1. Press **OK**. The confirmation message is displayed.
2. Use ◀/▶ to select **Reset** and press **OK**. The current picture mode returns to the factory preset settings.

## Reset Current Picture Mode



The following settings will still remain: **Picture Mode**.

---

## 2. Main menu: **Audio**

### Structure

Menu	Options	
Sound Mode	Cinema/Music/FPS/User	
Sound EQ	100Hz	-10 – +10
	300Hz	-10 – +10
	1kHz	-10 – +10
	4kHz	-10 – +10
	10kHz	-10 – +10
	Reset Sound EQ	
Audio Output	Internal Speaker	
	Audio Return+	
	3.5mm Jack	
Audio Output Format	Auto	
	LPCM	
	RAW (Up to 5.1)	
	RAW+ (Object-Based)	
Mute	Off/On	
Volume	0 – 20	
Reset Audio	Reset/Cancel	

### Function descriptions

Menu	Descriptions
<b>Sound Mode</b>	<p>This function utilizes treVolo and Bongiovi DPS (Digital Power Station) Technology, which incorporates its patented algorithms with 120 calibration points that optimizes any audio signal in real time to add depth, clarity, definition, presence and enhanced stereo field imaging for more immersive audio experience. The following preset sounds are available: <b>Cinema, Music, FPS, and User</b>.</p> <p>The <b>User</b> mode allows you to personalize the sound settings. When selecting the <b>User</b> mode, you may make manual adjustments with the <b>Sound EQ</b> function.</p>
<b>Sound EQ</b>	<p>Selects desired frequency bands (100 Hz, 300 Hz, 1k Hz, 4k Hz, and 10k Hz) to adjust the levels according to your preference. The settings made here define the <b>Sound Mode &gt; User</b> mode.</p> <p>To return all the levels of the frequency bands to factory settings, highlight <b>Reset Sound EQ</b> and press <b>OK</b>.</p>
<b>Audio Output</b>	<p>Selects the audio output from internal or external speakers.</p> <p>To enjoy <b>Audio Return+</b> sound effect, make sure to turn on the eARC/ARC function from your soundbar as well.</p> <p><b>Audio Return+</b> supports multi-audio outputs including 2.0, 5.1, 7.1 and Dolby Atmos to external audio systems like soundbars.</p>



---

<b>Audio Output Format</b>	The following audio output formats are provided to achieve the audio performance you desire: <b>LPCM</b> supports 2 channel audio output, <b>RAW (Up to 5.1)</b> supports up to 5.1 channel audio output, and <b>RAW+ (Object-Based)</b> supports Dolby Atmos audio output. The default setting <b>Auto</b> selects a suitable output format for the audio system.
<b>Mute</b>	Select <b>On</b> to temporarily turn off the projector's internal speaker. To restore the audio, select <b>Off</b> .
<b>Volume</b>	Adjusts the volume level of the projector's internal speaker. If the <b>Mute</b> function is activated, adjusting <b>Volume</b> will turn off the <b>Mute</b> function.
<b>Reset Audio</b>	Returns all of the adjustments you've done under the <b>Audio</b> menu to the factory preset values.

---

### 3. Main menu: **Display**

#### Structure

Menu		Options
<b>Aspect Ratio</b>		Auto/4:3/16:9
<b>Auto Source Search</b>		Off/On
<b>Source Rename</b>		HDMI-1/HDMI-2
<b>3D</b>	<b>3D Mode</b>	Auto/Frame Sequential/ Frame Packing/Top-Bottom/ Side by Side/Off
	<b>3D Sync Invert</b>	Disable/Invert
<b>Signal Format</b>		Auto/Limited/Full
<b>HDMI Settings</b>	<b>Equalizer</b>	HDMI-1/HDMI-2 Auto/1/2/3/4/5
	<b>EDID</b>	HDMI-1/HDMI-2 Enhanced/Standard
	<b>HDMI Device Control</b>	Off/On
	<b>Power On Link</b>	Off/From Device
	<b>Power Off Link</b>	Off/From Projector
<b>4K Upscaling</b>		Off/On
<b>Reset Display</b>		Reset/Cancel

#### Function descriptions

Menu	Descriptions
<b>Aspect Ratio</b>	<p>There are several options to set the image's aspect ratio depending on your input signal source.</p> <ul style="list-style-type: none"> <li>• <b>Auto</b>: Scales an image proportionally to fit the projector's native resolution in its horizontal or vertical width.</li> <li>• <b>4:3</b>: Scales an image so that it is displayed in the center of the screen with a 4:3 aspect ratio.</li> <li>• <b>16:9</b>: Scales an image so that it is displayed in the center of the screen with a 16:9 aspect ratio.</li> </ul>
<b>Auto Source Search</b>	<p>Allows the projector to automatically search for a signal.</p>
<b>Source Rename</b>	<p>Renames the current input source to your desired name.</p> <p>On the <b>Source Rename</b> page:</p> <ol style="list-style-type: none"> <li>1. Press <b>OK</b> to display the on-screen keyboard.</li> <li>2. Press <b>▲/▼/◀/▶</b> to select each desired digit/letter, and press <b>OK</b> to confirm each input.</li> <li>3. Repeat the step above and when done, press <b>BACK</b>.</li> <li>4. Press <b>▼</b> to highlight <b>Commit</b>.</li> <li>5. Press <b>OK</b> and the source name changes.</li> </ol>

## 3D

---

This projector supports playing three-dimensional (3D) content transferred through your 3D-compatible video devices and contents, such as PlayStation consoles (with 3D game discs), 3D Blu-ray players (with 3D Blu-ray discs), and so on. After you have connected the 3D video devices to the projector, wear a pair of 3D glasses and make sure the power is on to view 3D contents.

When watching 3D contents:

- The image may seem misplaced; however, this is not a product malfunction.
- Take appropriate breaks when watching 3D contents.
- Stop watching 3D contents if you feel fatigue or discomfort.
- Keep a distance from the screen of about three times the effective height of the screen.
- Children and people with a history of oversensitivity to light, heart problems, or any other existing medical conditions should be refrained from watching 3D contents.
- The image may seem reddish, greenish, or bluish without wearing 3D glasses. However, you will not notice any color bias when watching 3D contents with 3D glasses.
- The 4K source will not be displayed.

### • 3D Mode

The projector can automatically enable 3D mode via the contents when the source type is HDMI and supports 1.4a. If you want the projector to automatically choose an appropriate 3D format when detecting 3D contents, select **Auto**. If the projector cannot recognize the 3D format, choose a 3D mode from among **Frame Sequential**, **Frame Packing**, **Top-Bottom** and **Side by Side**.

When **3D Mode** is enabled:

- The brightness level of the projected image decreases.
- The **Picture Mode** cannot be adjusted.
- The **3D Keystone** can only be adjusted within limited degrees.

### • 3D Sync Invert

When your 3D image is distorted, enable this function to switch between the image for the left eye and the right eye for more comfortable 3D viewing experience.

---

---

## HDMI Settings

- **Signal Format**

Selects a suitable RGB color range to correct the color accuracy.

- **Auto:** Automatically selects a suitable color range for the incoming HDMI signal.
- **Limited:** Utilizes the Limited range RGB 16-235.
- **Full:** Utilizes the Full range RGB 0-255.

- **Equalizer**

Sets a suitable value to maintain the HDMI picture quality in long distance data transmission.

- **EDID**

Switches between **Enhanced** for HDMI 2.0 EDID and **Standard** for HDMI 1.4 EDID. Selecting **Standard** which supports up to 1080p 60Hz may solve abnormal display issues with some old players.

- **HDMI Device Control**

When you enable this function and connect an HDMI CEC-compatible device (e.g. QS02, a soundbar) to your projector, the projector remote control can control the device's menu or volume during the projector power-on state.

- **Power On Link/Power Off Link**

When you connect an HDMI CEC-compatible device to your projector with an HDMI cable, you can set the behavior of powering on/off between the device and the projector.

<b>Power On Link &gt; From Device</b>	When the connected device is turned on, the projector will be activated, too.
<b>Power Off Link &gt; From Projector</b>	When the projector is turned off, the connected device will be shut down, too.

---

## 4K Upscaling

Enables or disables "XPR always ON" which upscales all input timings to 4K resolution.

---

## Reset Display

Returns all the settings on the **Display** main menu to the factory default values.

---

## 4. Main menu: **Installation**

### Structure

Menu	Options
Projector Position	Auto/Front/Front Ceiling/Rear/Rear Ceiling
3D Keystone	H: -30 – +30 V: -30 – +30 R: -30 – +30
4 Point Adjustment	Top Left Top Right Bottom Left Bottom Right
Test Pattern	On/Off
High Altitude Mode	On/Off
Baud Rate	9600/14400/19200/38400/57600/115200

### Function descriptions

Menu	Descriptions
<b>Projector Position</b>	The projector can be installed on a ceiling or behind a screen, or with one or more mirrors. See <a href="#">Choosing a location on page 12</a> for details.
<b>3D Keystone</b>	See <a href="#">Correcting keystone on page 17</a> for details. This image adjustment might impact latency. We suggest setting the <b>3D Keystone</b> values to 0 to enjoy low latency gaming.
<b>4 Point Adjustment</b>	See <a href="#">Adjusting image corners on page 16</a> for details.
<b>Test Pattern</b>	Adjusts the image size and focus and check that the projected image is free from distortion.

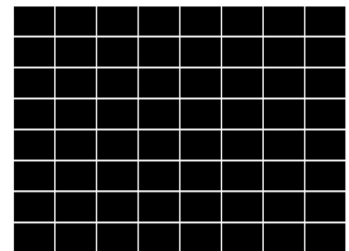

---

We recommend you use the **High Altitude Mode** when your environment is between 1501 m–3000 m above sea level, and ambient temperature is between 0°C–30°C.

Operation under "**High Altitude Mode**" may cause a higher decibel operating noise level because of increased fan speed necessary to improve overall system cooling and performance.

### High Altitude Mode

If you use this projector under other extreme conditions excluding the above, it may display auto shut-down symptoms, which is designed to protect your projector from over-heating. In cases like this, you should switch to High Altitude mode to solve these symptoms. However, this is not to state that this projector can operate under any and all harsh or extreme conditions.



Do not use the **High Altitude Mode** if your altitude is between 0 m and 1500 m and ambient temperature is between 0°C and 35°C. The projector will be over cooled, if you turn the mode on under such a condition.

---

### Baud Rate

Selects a baud rate that is identical with your computer's so that you can connect the projector using a suitable RS-232 cable. This function is intended for qualified service personnel.

---

## 5. Main menu: **System**

### Structure

Menu		Options
<b>Language</b>		English / Français / Deutsch / Italiano / Español / Русский / 繁體中文 / 简体中文 / 日本語 / 한국어 / Svenska / Nederlands / Türkçe / Čeština / Português / ไทย / Polski / Norsk / Suomi / Indonesian / العربية / हिन्दी
<b>Menu Settings</b>	<b>Menu Type</b>	<b>Basic/Advanced</b>
	<b>Menu Display Time</b>	<b>5 sec/10 sec/20 sec/30 sec/Always</b>
	<b>Menu Position</b>	<b>Center/Top-Left/Top-Right/ Bottom-Right/Bottom-Left</b>
<b>Light Source Information</b>	<b>Light Source Usage Time</b>	
	<b>Normal Mode</b>	
	<b>ECO Mode</b>	
	<b>Dynamic Mode</b>	
	<b>Equivalent Light Hours</b>	<b>Refer to UM for detailed formula</b>
<b>Operation Settings</b>	<b>Reminder Message</b>	<b>Off/On</b>
	<b>LED Indicator</b>	<b>Off/On</b>
	<b>Power On/Off Settings</b>	<b>Direct Power On Off/On</b>
		<b>Auto Power Off Disable/3 min/10 min/15 min/ 20 min/25 min/30 min</b>
<b>Security Settings</b>	<b>Panel Key Lock</b>	<b>Off/On Yes/No</b>
	<b>Change Password</b>	
	<b>Power On Lock</b>	
<b>Factory Default</b>		<b>Reset/Cancel</b>
<b>Reset System</b>		<b>Reset/Cancel</b>

### Function descriptions

Menu	Descriptions
<b>Language</b>	Sets the language for the On-Screen Display (OSD) menus.
<b>Menu Settings</b>	<ul style="list-style-type: none"> <li>• <b>Menu Type</b> Sets the OSD menu type according to your needs.</li> <li>• <b>Menu Display Time</b> Sets the length of time the OSD will remain active after your last key press.</li> <li>• <b>Menu Position</b> Sets the On-Screen Display (OSD) menu position.</li> </ul>

---

## Light Source Information

This menu page displays the following information:

- **Light Source Usage Time**
- Light hours used under **Normal Mode, ECO Mode, Dynamic Mode.**
- **Equivalent Light Hours**

For details about how to calculate the hours, see [Getting to know the light hour on page 43.](#)

---

## Operation Settings

- **Reminder Message**

Sets the reminder messages on or off.

- **LED Indicator**

You can turn off the LED warning lights. This is to avoid any light disturbance when viewing images in a dark room.

- **Power On/Off Settings**

- **Direct Power On:** Allows the projector to turn on automatically once the power is fed through the power cord.
  - **Auto Power Off:** Allows the projector to turn off automatically if no input signal is detected after a set period of time to prevent unnecessary waste of light source life.
- 

## Security Settings

- **Panel Key Lock**

With the control keys on the projector and remote control locked, you can prevent your projector settings from being changed accidentally (by children, for example). When the **Panel Key Lock** is on, no control keys on the projector will operate except  **POWER**.

To release panel key lock, press and hold  (the right key) on the projector or remote control for 3 seconds.



If you turn off the projector without disabling panel key lock, the projector will still be in locked status the next time it is turned on.

- **Change Password/Power On Lock**

See [Utilizing the password function on page 23.](#)

---

## Factory Default



The following settings will still remain: **Projector Position, 3D Keystone, 4 Point Adjustment, High Altitude Mode, Baud Rate, Light Source Information, Security Settings.**

---

## Reset System



Returns all the settings on the **System** main menu to the factory default values.

The following settings will still remain: **Light Source Information, Security Settings.**

---



## 6. Main menu: **Information**

### Structure

Menu
Detected Resolution
Source
Picture Mode
Light Source Mode
Sound Mode
3D Format
Color System
Dynamic Range
Light Source Usage Time
Firmware Version
Service Code

### Function descriptions

Menu	Descriptions
<b>Detected Resolution</b>	Shows the timing of the input signal.
<b>Source</b>	Shows the current signal source.
<b>Picture Mode</b>	Shows the selected mode on the <b>Game &amp; Pic.</b> menu.
<b>Light Source Mode</b>	Shows the used light source mode.
<b>Sound Mode</b>	Shows the selected sound mode.
	Displays the current 3D mode.
<b>3D Format</b>	 <b>3D Format</b> is only available when 3D is enabled.
<b>Color System</b>	Shows the input system format.
<b>Dynamic Range</b>	Shows the dynamic range of the input source.
<b>Light Source Usage Time</b>	Shows the number of hours the light has been used.
<b>Firmware Version</b>	Shows the firmware version of your projector.
<b>Service Code</b>	Shows the projector's serial number.

# Maintenance

## Care of the projector

### Cleaning the lens

Clean the lens whenever you notice dirt or dust on the surface. Please be sure to turn off the projector and let it cool down completely before cleaning the lens.

- Use a canister of compressed air to remove dust.
- If there is dirt or smears, use lens-cleaning paper or moisten a soft cloth with lens cleaner and gently wipe the lens surface.
- Never use any type of abrasive pad, alkaline/acid cleaner, scouring powder, or volatile solvent, such as alcohol, benzene, thinner or insecticide. Using such materials or maintaining prolonged contact with rubber or vinyl materials may result in damage to the projector surface and cabinet material.

### Cleaning the projector case

Before you clean the case, turn the projector off using the proper shutdown procedure as described in [Shutting down the projector on page 25](#) and unplug the power cord.

- To remove dirt or dust, wipe the case with a soft, lint-free cloth.
- To remove stubborn dirt or stains, moisten a soft cloth with water and a neutral pH detergent. Then wipe the case.



Never use wax, alcohol, benzene, thinner or other chemical detergents. These can damage the case.

### Storing the projector

If you need to store the projector for an extended time, please follow the instructions below:

- Make sure the temperature and humidity of the storage area are within the recommended range for the projector. Please refer to [Specifications on page 46](#) or consult your dealer about the range.
- Retract the adjuster feet.
- Remove the battery from the remote control.
- Pack the projector in its original packing or equivalent.

### Transporting the projector

It is recommended that you ship the projector with its original packing or equivalent.

# Light source information

## Getting to know the light hour

When the projector is in operation, the duration (in hours) of light source usage is automatically calculated by the built-in timer. The method of calculating the equivalent light hour is as follows:

1. Light Usage Time = (x+y+z) hours, if  
Time used in **Normal Mode** = x hours  
Time used in **ECO Mode** = y hours  
Time used in **Dynamic Mode** = z hours
2. Equivalent Light Hour =  $\alpha$  hours

$$\alpha = \frac{A'}{X} \times x + \frac{A'}{Y} \times y + \frac{A'}{Z} \times z, \text{ if}$$

X= light source life spec of **Normal Mode**

Y= light source life spec of **ECO Mode**

Z= light source life spec of **Dynamic Mode**

A' is the longest light life spec among X, Y, Z.



For time used in each light source mode shown on OSD menu:

- Time used is accumulated and rounded down to an integer in **hours**.
- When time used is less than 1 hour, it shows 0 hours.



When you calculate **Equivalent Light Hours** manually, it will probably have deviation from the value shown on OSD menu since projector system calculates time used for each light source mode in "Minutes" then rounds down to an integer in hours shown in OSD.

To obtain the light source hour information:

Go to the **Advanced** menu - **System** > **Light Source Information** and press **OK**. The **Light Source Usage Time** information is displayed.

You can also get the light source hour information on the **Information** menu.

## Extending light source life

- Setting the **Light Source Mode**

Go to the **Advanced** menu - **Game & Pic.** > **Advanced Color Settings** > **Light Source Mode** and select a suitable light source power from among the provided modes.

Setting the projector in **ECO Mode**, or **Dynamic Mode** mode extends light source life.

Light mode	Description
<b>Normal Mode</b>	Provides full light source brightness.
<b>ECO Mode</b>	Lowers brightness to extend the light source life and decreases the fan noise.
<b>Dynamic Mode</b>	Adjusts the light source power automatically depending on the content brightness level while optimizing display quality















































Some of the above light mode(s) may not be available under certain circumstances.









• Setting **Auto Power Off**

This function allows the projector to turn off automatically if no input signal is detected after a set period of time to prevent unnecessary waste of light source life.

To set **Auto Power Off**, go to the **Advanced** menu - **System > Operation Settings > Power On/Off Settings > Auto Power Off**, and press **OK**, ◀/▶ to set a period of time.

## Indicators

Light			Status & Description
POWER ○	TEMP ○	LIGHT ○	
<b>Power events</b>			
			Stand-by mode
			Powering up
			Normal operation
			Normal power-down cooling
			Downloading
			Color wheel start/spin fail
			Phosphor wheel start/spin fail
<b>Burn-in events</b>			
			Burn-in on
			Burn-in off
<b>Light events</b>			
			Light life exhausted
			Light error in normal operation
<b>Thermal events</b>			
			Fan 1 error (the actual fan speed is outside the desired speed)
			Fan 2 error (the actual fan speed is outside the desired speed)
			Fan 3 error (the actual fan speed is outside the desired speed)
			Temperature 1 error (over limited temperature)

	 : <b>Off</b>	 : Orange On	 : Green On	 : Red On
		 : Orange Flashing	 : Green Flashing	 : Red Flashing

# Troubleshooting

## ? The projector does not turn on.

Cause	Remedy
There is no power from the power cord.	Plug the power cord into the AC power jack on the projector, and plug the power cord into the power outlet. If the power outlet has a switch, make sure that it is switched on.
Attempting to turn the projector on again during the cooling process.	Wait until the cooling down process has completed.

## ? No picture

Cause	Remedy
The video source is not turned on or connected correctly.	Turn the video source on and check that the signal cable is connected correctly.
The projector is not correctly connected to the input signal device.	Check the connection.
The input signal has not been correctly selected.	Select the correct input signal with the <b>SOURCE</b> key.

## ? Blurred image

Cause	Remedy
The projection lens is not correctly focused.	Adjust the focus of the lens using the focus ring.
The projector and the screen are not aligned properly.	Adjust the projection angle and direction as well as the height of the projector if necessary.
The lens cover is still closed.	Open the lens cover.

## ? Abnormal image

Cause	Remedy
The image is abnormal.	<ul style="list-style-type: none"> <li>• Ensure the video source cable is connected properly, and that the video source is turned on.</li> <li>• Ensure that the air intake or exhaust is not blocked.</li> </ul>

## ? Remote control does not work.

Cause	Remedy
The batteries are out of power.	Replace both of the batteries with new ones.
There is an obstacle between the remote control and the projector.	Remove the obstacle.
You are too far away from the projector.	Stand within 8 meters (26 feet) of the projector.

## ? The password is incorrect.

Cause	Remedy
You do not remember the password.	See <a href="#">Entering the password recall procedure on page 24.</a>

# Specifications

## Projector specifications



All specifications are subject to change without notice.

### Optical

Resolution  
3840 x 2160

Display system  
1-CHIP DMD

Throw ratio  
1.15 ~ 1.5

Light source  
Laser & LED

### Electrical

Power supply  
AC100–240V, 3.6 A, 50–60 Hz (Automatic)

Power consumption  
275 W (Max); < 0.5 W (Standby)

### Mechanical

Weight  
3.0 Kg  $\pm$  100 g (6.61 lbs  $\pm$  0.22 lbs)

### Input terminals

Digital  
HDMI 1/HDMI 2 (2.0b, HDCP 2.2) x 2

### Output terminals

Speaker  
5 watt x1

Audio signal output  
PC audio jack x 1

### Control

USB  
USB-A 2.0 x 1 (Power supply 5V /1.5 A, Firmware upgrade)

RS-232 serial control  
9 pin x 1

IR receiver x 2

### Environmental Requirements

Operating temperature  
0°C–40°C at sea level

Operating relative humidity  
10%–90% RH (without condensation)

Operating altitude  
0–1500 m at 0°C–35°C  
1501–3000 m at 0°C–30°C (with High Altitude Mode on)

Storage temperature  
-20°C–60°C at sea level

Storage humidity  
10%–90% RH (without condensation)

Storage altitude  
30°C@ 0~12,200m above sea level

### Transporting

Original packing or equivalent is recommended.

### Repairing

Please visit below website and choose your country to find your service contact window.  
<http://www.benq.com/welcome>

# Dimensions

304.2 mm (W) x 232.5 mm (D) x 112.4 mm (H)

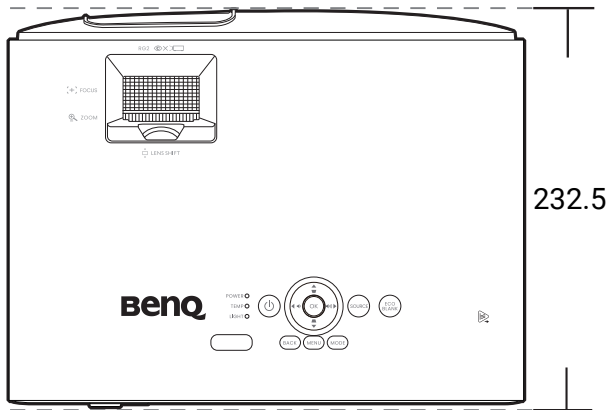
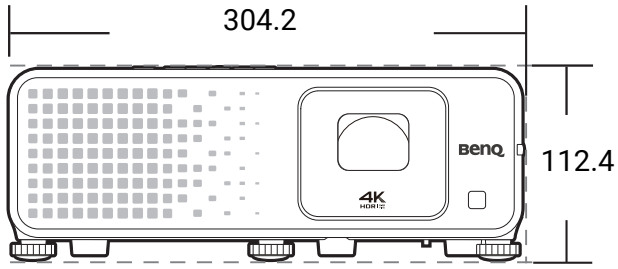

# Timing chart

## Supported timing for HDMI (HDCP) input

• PC timings

Resolution	Mode	Refresh rate (Hz)	H-frequency (kHz)	Clock (MHz)	Supported 3D format		
					Frame Sequential	Top-Bottom	Side by Side
640 x 480	VGA_60	59.940	31.469	25.175	v	v	v
	VGA_72	72.809	37.861	31.500			
	VGA_75	75.000	37.500	31.500			
	VGA_85	85.008	43.269	36.000			
720 x 400	720 x 400_70	70.087	31.469	28.3221			
800 x 600	SVGA_60	60.317	37.879	40.000	v	v	v
	SVGA_72	72.188	48.077	50.000			
	SVGA_75	75.000	46.875	49.500			
	SVGA_85	85.061	53.674	56.250			
	SVGA_120 (Reduce Blanking)	119.854	77.425	83.000	v		
1024 x 768	XGA_60	60.004	48.363	65.000	v	v	v
	XGA_70	70.069	56.476	75.000			
	XGA_75	75.029	60.023	78.750			
	XGA_85	84.997	68.667	94.500			
	XGA_120 (Reduce Blanking)	119.989	97.551	115.500	v		
1152 x 864	1152 x 864_75	75.00	67.500	108.000			
1024 x 576	BenQ Notebook Timing	60.00	35.820	46.996			
1024 x 600	BenQ Notebook Timing	64.995	41.467	51.419			
1280 x 720	1280 x 720_60	60	45.000	74.250	v	▲	▲
1280 x 768	1280 x 768_60	59.870	47.776	79.5	v	v	v
1280 x 800	WXGA_60	59.810	49.702	83.500	v	v	v
	WXGA_75	74.934	62.795	106.500			
	WXGA_85	84.880	71.554	122.500			
	WXGA_120 (Reduce Blanking)	119.909	101.563	146.25	v		
1280 x 1024	SXGA_60	60.020	63.981	108.000		v	v
	SXGA_75	75.025	79.976	135.000			
	SXGA_85	85.024	91.146	157.500			
1280 x 960	1280 x 960_60	60.000	60.000	108		v	v
	1280 x 960_85	85.002	85.938	148.500			
1360 x 768	1360 x 768_60	60.015	47.712	85.500		v	v
1440 x 900	WXGA+_60	59.887	55.935	106.500		v	v
1400 x 1050	SXGA+_60	59.978	65.317	121.750		v	v
1600 x 1200	UXGA	60.000	75.000	162.000			
1680 x 1050	1680 x 1050_60	59.954	65.290	146.250		v	v
640 x 480@67Hz	MAC13	66.667	35.000	30.240			
832 x 624@75Hz	MAC16	74.546	49.722	57.280			



1024 x 768@75Hz	MAC19	75.020	60.241	80.000			
1152 x 870@75Hz	MAC21	75.06	68.68	100.00			
1920 x 1080@60Hz	1920 x 1080_60 (CEA-861)	60	67.5	148.5	v	▲	▲
1920 x 1200@60Hz	1920 x 1200_60 (Reduce Blanking)	59.95	74.038	154	v		
1920 x 1080@120Hz	1920 x 1080_120	120.000	135.000	297	v		
1920 x 1200@120Hz	1920 x 1200_120 (Reduce Blanking)	119.909	152.404	317.00	v		



- ▲: Supports auto-detecting and manually setting 3D format.
- v: Supports manually setting 3D format.
- The timings showing above may not be supported due to EDID file and VGA graphic card limitations. It is possible that some timings cannot be chosen.

• Video timings

Timing	Resolution	Horizontal frequency (KHz)	Vertical frequency (Hz)	Dot Clock Frequency (MHz)	Supported 3D format			
					Frame Sequential	Frame Packing	Top-Bottom	Side by Side
480i	720 (1440) x 480	15.73	59.94	27				
480p	720 x 480	31.47	59.94	27	v			
576i	720 (1440) x 576	15.63	50	27				
576p	720 x 576	31.25	50	27				
720/50p	1280 x 720	37.5	50	74.25		▲	▲	▲
720/60p	1280 x 720	45.00	60	74.25	v	▲	▲	▲
1080/24P	1920 x 1080	27	24	74.25		▲	▲	▲
1080/25P	1920 x 1080	28.13	25	74.25				
1080/30P	1920 x 1080	33.75	30	74.25				
1080/50i	1920 x 1080	28.13	50	74.25				▲
1080/60i	1920 x 1080	33.75	60	74.25				▲
1080/50P	1920 x 1080	56.25	50	148.5			▲	▲
1080/60P	1920 x 1080	67.5	60	148.5	v		▲	▲
1080/120P	1920 x 1080	135	120	297	v			
1080/240P	1920 x 1080	135	240	594				
2160/24P	3840 x 2160	54	24	297				
2160/25P	3840 x 2160	56.25	25	297				
2160/30P	3840 x 2160	67.5	30	297				
2160/50P	3840 x 2160	112.5	50	594				
2160/60P	3840 x 2160	135	60	594				



- ▲: Supports auto-detecting and manually setting 3D format.
- v: Supports manually setting 3D format.
- The timings showing above may not be supported due to EDID file and VGA graphic card limitations. It is possible that some timings cannot be chosen.

• Supported detail timings for sampling and color depth

Display format (refresh rate)	Chroma subsampling	8 Bit	10 Bit	12 Bit
4K/60p (60 Hz)	4:4:4	v		
	4:2:2	v	v	
	4:2:0	v	v	v
4K/50p (50 Hz)	4:4:4	v		
	4:2:2	v	v	
	4:2:0	v	v	v
4K/30p (30 Hz)	4:4:4	v	v	v
	4:2:2	v	v	v
	4:2:0			
4K/24p (24 Hz)	4:4:4	v	v	v
	4:2:2	v	v	v
	4:2:0			
1080P/60p (60 Hz)	4:4:4	v	v	v
	4:2:2	v	v	v
	4:2:0			
1080P/50p (50 Hz)	4:4:4	v	v	v
	4:2:2	v	v	v
	4:2:0			
1080P/30p (30 Hz)	4:4:4	v	v	v
	4:2:2	v	v	v
	4:2:0			
1080P/24p (24 Hz)	4:4:4	v	v	v
	4:2:2	v	v	v
	4:2:0			

# RS232 command

## RS232 pin assignment

No.	Serial
1	NC
2	RX
3	TX
4	NC
5	GND

No.	Serial
6	NC
7	RTSZ
8	CTSZ
9	NC

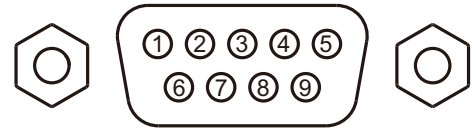

Function	Type	Operation	ASCII
Power	Write	Power On	<CR>*pow=on#<CR>
	Write	Power Off	<CR>*pow=off#<CR>
	Read	Power Status	<CR>*pow=?#<CR>
Source Selection	Write	HDMI (MHL)	<CR>*sour=hdmi#<CR>
	Write	HDMI 2(MHL2)	<CR>*sour=hdmi2#<CR>
	Read	Current source	<CR>*sour=?#<CR>
Audio Control	Write	Mute On	<CR>*mute=on#<CR>
	Write	Mute Off	<CR>*mute=off#<CR>
	Read	Mute Status	<CR>*mute=?#<CR>
	Write	Volume +	<CR>*vol=+#<CR>
	Write	Volume -	<CR>*vol=-#<CR>
	Write	Volume level for customer	<CR>*vol=value#<CR>
	Read	Volume Status	<CR>*vol=?#<CR>
Picture Mode	Write	Bright	<CR>*appmod=bright#<CR>
	Write	Living Room	<CR>*appmod=livingroom#<CR>
	Write	Cinema (Rec.709)	<CR>*appmod=cine#<CR>
	Write	User1	<CR>*appmod=user1#<CR>
	Write	3D	<CR>*appmod=threed#<CR>
	Write	HDR	<CR>*appmod=hdr#<CR>
	Write	HLG	<CR>*appmod=hlg#<CR>
	Write	RPG	<CR>*appmod=rpg#<CR>
	Write	HDR-RPG	<CR>*appmod=hdrpg#<CR>
	Write	FPS	<CR>*appmod=fps#<CR>
	Write	HDR-FPS	<CR>*appmod=hdrfps#<CR>
	Write	HDR-User	<CR>*appmod=hdruser1#<CR>
	Write	Rename Picture Mode	<CR>*appmodrename=value#<CR>
	Read	Picture Mode Rename	<CR>*appmodrename=?#<CR>
Read	Picture Mode	<CR>*appmod=?#<CR>	
Picture Setting	Write	Contrast +	<CR>*con=+#<CR>
	Write	Contrast -	<CR>*con=-#<CR>
	Write	Set Contrast value	<CR>*con=value#<CR>
	Read	Contrast value	<CR>*con=?#<CR>
	Write	Brightness +	<CR>*bri=+#<CR>
	Write	Brightness -	<CR>*bri=-#<CR>
	Write	Set Brightness value	<CR>*bri=value#<CR>
	Read	Brightness value	<CR>*bri=?#<CR>
	Write	Sharpness +	<CR>*sharp=+#<CR>
	Write	Sharpness -	<CR>*sharp=-#<CR>
	Write	Set Sharpness value	<CR>*sharp=value#<CR>

Picture Setting	Read	Sharpness value	<CR>*sharp=?#<CR>
	Write	Color Temperature-Warm	<CR>*ct=warm#<CR>
	Write	Color Temperature-Normal	<CR>*ct=normal#<CR>
	Write	Color Temperature-Cool	<CR>*ct=cool#<CR>
	Write	Color Temperature-lamp native	<CR>*ct=native#<CR>
	Read	Color Temperature Status	<CR>*ct=?#<CR>
	Write	Aspect 4:3	<CR>*asp=4:3#<CR>
	Write	Aspect 16:9	<CR>*asp=16:9#<CR>
	Write	Aspect Auto	<CR>*asp=AUTO#<CR>
	Read	Aspect Status	<CR>*asp=?#<CR>
	Write	Vertical Keystone +	<CR>*vkeystone=+#<CR>
	Write	Vertical Keystone -	<CR>*vkeystone=-#<CR>
	Write	Vertical Keystone value Set	<CR>*vkeystone=value#<CR>
	Read	Vertical Keystone value	<CR>*vkeystone=?#<CR>
	Write	Horizontal Keystone +	<CR>*hkeystone=+#<CR>
	Write	Horizontal Keystone -	<CR>*hkeystone=-#<CR>
	Write	Horizontal Keystone value Set	<CR>*hkeystone=value#<CR>
	Read	Horizontal Keystone value	<CR>*hkeystone=?#<CR>
	Write	Rotate Keystone +	<CR>*rkeystone=+#<CR>
	Write	Rotate Keystone -	<CR>*rkeystone=-#<CR>
	Write	Rotate Keystone value Set	<CR>*rkeystone=value#<CR>
	Read	Rotate Keystone value	<CR>*rkeystone=?#<CR>
	Write	4 Corners Top-Left-X Decrease	<CR>*cornerfittlx=-#<CR>
	Write	4 Corners Top-Left-X Increase	<CR>*cornerfittlx=+#<CR>
	Read	4 Corners Top-Left-X Status	<CR>*cornerfittlx=?#<CR>
	Write	4 Corners Top-Left-Y Decrease	<CR>*cornerfittly=-#<CR>
	Write	4 Corners Top-Left-Y Increase	<CR>*cornerfittly=+#<CR>
	Read	4 Corners Top-Left-Y Status	<CR>*cornerfittly=?#<CR>
	Write	4 Corners Top-Right-X Decrease	<CR>*cornerfittrx=-#<CR>
	Write	4 Corners Top-Right-X Increase	<CR>*cornerfittrx=+#<CR>
	Read	4 Corners Top-Right-X Status	<CR>*cornerfittrx=?#<CR>
	Write	4 Corners Top-Right-Y Decrease	<CR>*cornerfittly=-#<CR>
	Write	4 Corners Top-Right-Y Increase	<CR>*cornerfittly=+#<CR>
	Read	4 Corners Top-Right-Y Status	<CR>*cornerfittly=?#<CR>
	Write	4 Corners Bottom-Left-X Decrease	<CR>*cornerfitblx=-#<CR>
	Write	4 Corners Bottom-Left-X Increase	<CR>*cornerfitblx=+#<CR>
	Read	4 Corners Bottom-Left-X Status	<CR>*cornerfitblx=?#<CR>
	Write	4 Corners Bottom-Left-Y Decrease	<CR>*cornerfitbly=-#<CR>
	Write	4 Corners Bottom-Left-Y Increase	<CR>*cornerfitbly=+#<CR>
	Read	4 Corners Bottom-Left-Y Status	<CR>*cornerfitbly=?#<CR>
	Write	4 Corners Bottom-Right-X Decrease	<CR>*cornerfitbrx=-#<CR>
	Write	4 Corners Bottom-Right-X Increase	<CR>*cornerfitbrx=+#<CR>
	Read	4 Corners Bottom-Right-X Status	<CR>*cornerfitbrx=?#<CR>
	Write	4 Corners Bottom-Right-Y Decrease	<CR>*cornerfitbry=-#<CR>
	Write	4 Corners Bottom-Right-Y Increase	<CR>*cornerfitbry=+#<CR>
	Read	4 Corners Bottom-Right-Y Status	<CR>*cornerfitbry=?#<CR>
	Write	Digital Zoom In	<CR>*zoomI#<CR>
Write	Digital Zoom out	<CR>*zoomO#<CR>	
Write	Reset current picture settings	<CR>*rstcurpicsetting#<CR>	
Write	Reset all picture settings	<CR>*rstallpicsetting#<CR>	

Operation Settings	Write	Projector Position-Front Table	<CR>*pp=FT#<CR>
	Write	Projector Position-Rear Table	<CR>*pp=RE#<CR>
	Write	Projector Position-Rear Ceiling	<CR>*pp=RC#<CR>
	Write	Projector Position-Front Ceiling	<CR>*pp=FC#<CR>
	Read	Projector Position Status	<CR>*pp=?#<CR>
	Write	Quick auto search	<CR>*QAS=on#<CR>
	Write	Quick auto search	<CR>*QAS=off#<CR>
	Read	Quick auto search status	<CR>*QAS=?#<CR>
	Write	Menu Position - Center	<CR>*menuposition=center#<CR>
	Write	Menu Position - Top-Left	<CR>*menuposition=tl#<CR>
	Write	Menu Position - Top-Right	<CR>*menuposition=tr#<CR>
	Write	Menu Position - Bottom-Right	<CR>*menuposition=br#<CR>
	Write	Menu Position - Bottom-Left	<CR>*menuposition=bl#<CR>
	Read	Menu Position Status	<CR>*menuposition=?#<CR>
	Write	Direct Power On-on	<CR>*directpower=on#<CR>
	Write	Direct Power On-off	<CR>*directpower=off#<CR>
	Read	Direct Power On-Status	<CR>*directpower=?#<CR>
Baud Rate	Write	9600	<CR>*baud=9600#<CR>
	Write	14400	<CR>*baud=14400#<CR>
	Write	19200	<CR>*baud=19200#<CR>
	Write	38400	<CR>*baud=38400#<CR>
	Write	57600	<CR>*baud=57600#<CR>
	Write	115200	<CR>*baud=115200#<CR>
	Read	Current Baud Rate	<CR>*baud=?#<CR>
Lamp Control	Read	Lamp	<CR>*ltim=?#<CR>
	Write	Normal mode	<CR>*lampm=lnor#<CR>
	Write	Eco mode	<CR>*lampm=eco#<CR>
	Write	SmartEco mode	<CR>*lampm=seco#<CR>
	Read	Lamp Mode Status	<CR>*lampm=?#<CR>
Miscellaneous	Read	Model Name	<CR>*modelname=?#<CR>
	Read	System F/W Version	<CR>*sysfwversion=?#<CR>
	Read	Scaler F/W Version	<CR>*scalerfwversion=?#<CR>
	Read	MCU F/W Version	<CR>*mcutfwversion=?#<CR>
	Write	Blank On	<CR>*blank=on#<CR>
	Write	Blank Off	<CR>*blank=off#<CR>
	Read	Blank Status	<CR>*blank=?#<CR>
	Write	Menu On	<CR>*menu=on#<CR>
	Write	Menu Off	<CR>*menu=off#<CR>
	Read	Menu Status	<CR>*menu=?#<CR>
	Write	Up	<CR>*up#<CR>
	Write	Down	<CR>*down#<CR>
	Write	Right	<CR>*right#<CR>
	Write	Left	<CR>*left#<CR>
	Write	Enter	<CR>*enter#<CR>
	Write	Back	<CR>*back#<CR>
	Write	Source Menu On	<CR>*sourmenu=on#<CR>
	Write	Source Menu Off	<CR>*sourmenu=off#<CR>
	Read	Source Menu Status	<CR>*sourmenu=?#<CR>
	Write	3D Sync Off	<CR>*3d=off#<CR>

Miscellaneous	Write	3D Auto	<CR>*3d=auto#<CR>
	Write	3D Sync Top Bottom	<CR>*3d=tb#<CR>
	Write	3D Sync Frame Sequential	<CR>*3d=fs#<CR>
	Write	3D Frame packing	<CR>*3d=fp#<CR>
	Write	3D Side by side	<CR>*3d=sbs#<CR>
	Write	3D inverter disable	<CR>*3d=da#<CR>
	Write	3D inverter	<CR>*3d=iv#<CR>
	Read	3D Sync Status	<CR>*3d=?#<CR>
	Read	Serial Number	<CR>*serialnumber=?#<CR>
	Write	High Altitude mode on	<CR>*highaltitude=on#<CR>
	Write	High Altitude mode off	<CR>*highaltitude=off#<CR>
	Read	High Altitude mode status	<CR>*highaltitude=?#<CR>
	Color Calibration (only for service)	Write	Set BenQ gamma value
Read		Gamma value status	<CR>*gamma=?#<CR>
Write		Set HDR Brightness value	<CR>*hdrbri=value#<CR>
Read		Get HDR Brightness value	<CR>*hdrbri=?#<CR>
Write		Red Gain +	<CR>*RGain=+#<CR>
Write		Red Gain -	<CR>*RGain=-#<CR>
Write		Set Red Gain value	<CR>*RGain=value#<CR>
Read		Get Red Gain value	<CR>*RGain=?#<CR>
Write		Green Gain +	<CR>*GGain=+#<CR>
Write		Green Gain -	<CR>*GGain=-#<CR>
Write		Set Green Gain value	<CR>*GGain=value#<CR>
Read		Get Green Gain value	<CR>*GGain=?#<CR>
Write		Blue Gain +	<CR>*BGain=+#<CR>
Write		Blue Gain -	<CR>*BGain=-#<CR>
Write		Set Blue Gain value	<CR>*BGain=value#<CR>
Read		Get Blue Gain value	<CR>*BGain=?#<CR>
Write		Red Offset +	<CR>*ROffset=+#<CR>
Write		Red Offset -	<CR>*ROffset=-#<CR>
Write		Set Red Offset value	<CR>*ROffset=value#<CR>
Read		Get Red Offset value	<CR>*ROffset=?#<CR>
Write		Green Offset +	<CR>*GOffset=+#<CR>
Write		Green Offset -	<CR>*GOffset=-#<CR>
Write		Set Green Offset value	<CR>*GOffset=value#<CR>
Read		Get Green Offset value	<CR>*GOffset=?#<CR>
Write		Blue Offset +	<CR>*BOffset=+#<CR>
Write		Blue Offset -	<CR>*BOffset=-#<CR>
Write		Set Blue Offset value	<CR>*BOffset=value#<CR>
Read		Get Blue Offset value	<CR>*BOffset=?#<CR>
Write		Primary Color	<CR>*primcr=value#<CR>
Read		Primary Color Status	<CR>*primcr=?#<CR>
Write		Hue +	<CR>*hue=+#<CR>
Write		Hue -	<CR>*hue=-#<CR>
Write		Set Hue value	<CR>*hue=value#<CR>
Read		Get Hue value	<CR>*hue=?#<CR>
Write		Saturation +	<CR>*saturation =+#<CR>
Write		Saturation -	<CR>*saturation =-#<CR>
Write	Set Saturation value	<CR>*saturation =value#<CR>	
Read	Get Saturation value	<CR>*saturation =?#<CR>	
Write	Gain +	<CR>*gain=+#<CR>	

Color Calibration (only for service)	Write	Gain -	<CR>*gain=-#<CR>
	Write	Set Gain value	<CR>*gain=value#<CR>
	Read	Get Gain value	<CR>*gain=?#<CR>
	Write	White Red Gain +	<CR>*WRGain=+#<CR>
	Write	White Red Gain -	<CR>*WRGain=-#<CR>
	Write	Set White Red Gain value	<CR>*WRGain=value#<CR>
	Read	Get White Red Gain value	<CR>*WRGain=?#<CR>
	Write	White Green Gain +	<CR>*WGGain=+#<CR>
	Write	White Green Gain -	<CR>*WGGain=-#<CR>
	Write	Set White Green Gain value	<CR>*WGGain=value#<CR>
	Read	Get White Green Gain value	<CR>*WGGain=?#<CR>
	Write	White Blue Gain +	<CR>*WBGain=+#<CR>
	Write	White Blue Gain -	<CR>*WBGain=-#<CR>
	Write	Set White Blue Gain value	<CR>*WBGain=value#<CR>
	Read	Get White Blue Gain value	<CR>*WBGain=?#<CR>
Service (Only for service)	Write	Service mode enable for error report	<CR>*error=enable#<CR>
	Read	Error code report	<CR>*error=report#<CR>
	Read	FAN 1 speed	<CR>*fan1=?#<CR>
	Read	FAN 2 speed	<CR>*fan2=?#<CR>
	Read	FAN 3 speed	<CR>*fan3=?#<CR>
	Read	Temperature 1	<CR>*tmp1=?#<CR>