

ASUS[®]

VA24DQFS/VA27DQFS

LCD Monitor

User Guide

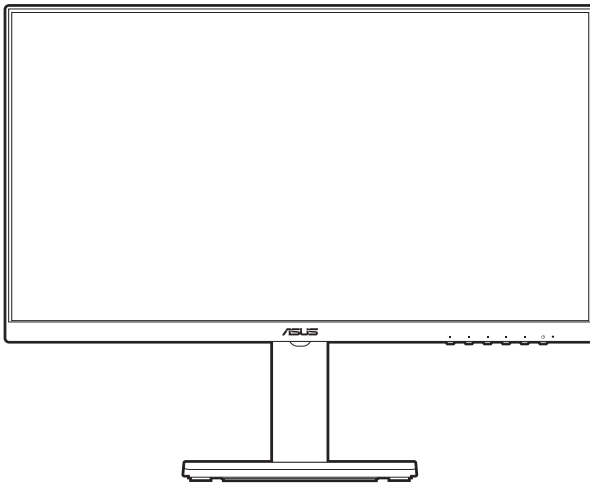

HDMI[™]

HIGH-DEFINITION MULTIMEDIA INTERFACE

First Edition

May 2024

Copyright © 2024 ASUSTeK COMPUTER INC. All Rights Reserved.

No part of this manual, including the products and software described in it, may be reproduced, transmitted, transcribed, stored in a retrieval system, or translated into any language in any form or by any means, except documentation kept by the purchaser for backup purposes, without the express written permission of ASUSTeK COMPUTER INC. ("ASUS").

Product warranty or service will not be extended if: (1) the product is repaired, modified or altered, unless such repair, modification or alteration is authorized in writing by ASUS; or (2) the serial number of the product is defaced or missing.

ASUS PROVIDES THIS MANUAL "AS IS" WITHOUT WARRANTY OF ANY KIND, EITHER EXPRESS OR IMPLIED, INCLUDING BUT NOT LIMITED TO THE IMPLIED WARRANTIES OR CONDITIONS OF MERCHANTABILITY OR FITNESS FOR A PARTICULAR PURPOSE. IN NO EVENT SHALL ASUS, ITS DIRECTORS, OFFICERS, EMPLOYEES OR AGENTS BE LIABLE FOR ANY INDIRECT, SPECIAL, INCIDENTAL, OR CONSEQUENTIAL DAMAGES (INCLUDING DAMAGES FOR LOSS OF PROFITS, LOSS OF BUSINESS, LOSS OF USE OR DATA, INTERRUPTION OF BUSINESS AND THE LIKE), EVEN IF ASUS HAS BEEN ADVISED OF THE POSSIBILITY OF SUCH DAMAGES ARISING FROM ANY DEFECT OR ERROR IN THIS MANUAL OR PRODUCT.

SPECIFICATIONS AND INFORMATION CONTAINED IN THIS MANUAL ARE FURNISHED FOR INFORMATIONAL USE ONLY, AND ARE SUBJECT TO CHANGE AT ANY TIME WITHOUT NOTICE, AND SHOULD NOT BE CONSTRUED AS A COMMITMENT BY ASUS. ASUS ASSUMES NO RESPONSIBILITY OR LIABILITY FOR ANY ERRORS OR INACCURACIES THAT MAY APPEAR IN THIS MANUAL, INCLUDING THE PRODUCTS AND SOFTWARE DESCRIBED IN IT.

Products and corporate names appearing in this manual may or may not be registered trademarks or copyrights of their respective companies, and are used only for identification or explanation and to the owners' benefit, without intent to infringe.

Contents

Contents	iii
Notices	iv
Safety information	vi
Care & Cleaning	vii
Takeback Services	viii
Product information for EU energy label	viii
Chapter 1: Product introduction	
1.1 Welcome!	1-1
1.2 Package contents	1-1
1.3 Monitor introduction	1-2
1.3.1 Front view	1-2
1.3.2 Back view	1-3
Chapter 2: Setup	
2.1 Assembling the monitor arm/base	2-1
2.2 Detaching the arm/base (for VESA wall mount)	2-2
2.3 Adjusting the monitor	2-3
2.4 Connecting the cables	2-4
2.5 Turning on the monitor	2-5
Chapter 3: General instructions	
3.1 OSD (On-Screen Display) menu	3-1
3.1.1 How to reconfigure	3-1
3.1.2 OSD function introduction	3-2
3.2 Specifications summary	3-10
3.3 Outline dimensions	3-12
3.4 Troubleshooting (FAQ)	3-14
3.5 Supported operating modes	3-15

Notices

Federal Communications Commission Statement

This device complies with Part 15 of the FCC Rules. Operation is subject to the following two conditions:

- This device may not cause harmful interference, and
- This device must accept any interference received including interference that may cause undesired operation.

This equipment has been tested and found to comply with the limits for a Class B digital device, pursuant to Part 15 of the FCC Rules. These limits are designed to provide reasonable protection against harmful interference in a residential installation. This equipment generates, uses and can radiate radio frequency energy and, if not installed and used in accordance with the instructions, may cause harmful interference to radio communications. However, there is no guarantee that interference will not occur in a particular installation. If this equipment does cause harmful interference to radio or television reception, which can be determined by turning the equipment off and on, the user is encouraged to try to correct the interference by one or more of the following measures:

- Reorient or relocate the receiving antenna.
- Increase the separation between the equipment and receiver.
- Connect the equipment into an outlet on a circuit different from that to which the receiver is connected.
- Consult the dealer or an experienced radio/TV technician for help.



The use of shielded cables for connection of the monitor to the graphics card is required to assure compliance with FCC regulations. Changes or modifications to this unit not expressly approved by the party responsible for compliance could void the user's authority to operate this equipment.

ENERGY STAR complied product



ENERGY STAR is a joint program of the U.S. Environmental Protection Agency and the U.S. Department of Energy helping us all save money and protect the environment through energy efficient products and practices.

All ASUS products with the ENERGY STAR logo comply with the ENERGY STAR standard, and the power management feature is enabled by default. The monitor and computer are automatically set to sleep after 10 and 30 minutes of user inactivity. To wake your computer, click the mouse or press any key on the keyboard. Please visit <http://www.energystar.gov/powermanagement> for detail information on power management and its benefits to the environment. In addition, please visit <http://www.energystar.gov> for detail information on the ENERGY STAR joint program.



NOTE: Energy Star is NOT supported on FreeDOS and Linux-based operating system.

Canadian Department of Communications Statement

This digital apparatus does not exceed the Class B limits for radio noise emissions from digital apparatus set out in the Radio Interference Regulations of the Canadian Department of Communications.

This class B digital apparatus complies with Canadian ICES-003.

This Class B digital apparatus meets all requirements of the Canadian Interference - Causing Equipment Regulations.

Cet appareil numérique de la classe B respecte toutes les exigences du Règlement sur le matériel brouiller du Canada.



Safety information

- Before setting up the monitor, carefully read all the documentation that came with the package.
- To prevent fire or shock hazard, never expose the monitor to rain or moisture.
- Never try to open the monitor cabinet. The dangerous high voltages inside the monitor may result in serious physical injury.
- If the power supply is broken, do not try to fix it by yourself. Contact a qualified service technician or your retailer.
- Before using the product, make sure all cables are correctly connected and the power cables are not damaged. If you detect any damage, contact your dealer immediately.
- Slots and openings on the back or top of the cabinet are provided for ventilation. Do not block these slots. Never place this product near or over a radiator or heat source unless proper ventilation is provided.
- The monitor should be operated only from the type of power source indicated on the label. If you are not sure of the type of power supply to your home, consult your dealer or local power company.
- Use the appropriate power plug which complies with your local power standard.
- Do not overload power strips and extension cords. Overloading can result in fire or electric shock.
- Avoid dust, humidity, and temperature extremes. Do not place the monitor in any area where it may become wet. Place the monitor on a stable surface.
- Unplug the unit during a lightning storm or if it will not be used for a long period of time. This will protect the monitor from damage due to power surges.
- Never push objects or spill liquid of any kind into the slots on the monitor cabinet.
- To ensure satisfactory operation, use the monitor only with UL listed computers which have appropriate configured receptacles marked between 100-240V AC.
- If you encounter technical problems with the monitor, contact a qualified service technician or your retailer.
- Adjustment of the volume control as well as the equalizer to other settings than the center position may increase the ear-/headphones output voltage and therefore the sound pressure level.
- Ensure to connect the power cord to a socket-outlet with earthing connection.
- The supplied power adapter and/or power cable are designed to use with the product only. Do not use with other products.



This symbol of the crossed out wheeled bin indicates that the product (electrical, electronic equipment, and mercury-containing button cell battery) should not be placed in municipal waste. Please check local regulations for disposal of electronic products.

AEEE yönetmeliğine uygundur

Care & Cleaning

- Before you lift or reposition your monitor, it is better to disconnect the cables and power cord. Follow the correct lifting techniques when positioning the monitor. When lifting or carrying the monitor, grasp the edges of the monitor. Do not lift the display by the stand or the cord.
- Cleaning. Turn your monitor off and unplug the power cord. Clean the monitor surface with a lint-free, non-abrasive cloth. Stubborn stains may be removed with a cloth dampened with mild cleaner.
- Avoid using a cleaner containing alcohol or acetone. Use a cleaner intended for use with the monitor. Never spray cleaner directly on the screen, as it may drip inside the monitor and cause an electric shock.

The following symptoms are normal with the monitor:

- You may find slightly uneven brightness on the screen depending on the desktop pattern you use.
- When the same image is displayed for hours, an afterimage of the previous screen may remain after switching the image. The screen will recover slowly or you can turn off the Power Switch for hours.
- When the screen becomes black or flashes, or cannot work anymore, contact your dealer or service center to fix it. Do not repair the screen by yourself!

Conventions used in this guide



WARNING: Information to prevent injury to yourself when trying to complete a task.



CAUTION: Information to prevent damage to the components when trying to complete a task.



IMPORTANT: Information that you **MUST** follow to complete a task.



NOTE: Tips and additional information to aid in completing a task.

Where to find more information

Refer to the following sources for additional information and for product and software updates.

1. ASUS websites

The ASUS websites worldwide provide updated information on ASUS hardware and software products. Refer to <http://www.asus.com>

2. Optional documentation

Your product package may include optional documentation that may have been added by your dealer. These documents are not part of the standard package.

3. About Flicker

https://www.asus.com/Microsite/display/eye_care_technology/

Takeback Services

ASUS recycling and takeback programs come from our commitment to the highest standards for protecting our environment. We believe in providing solutions for our customers to be able to responsibly recycle our products, batteries and other components as well as the packaging materials.

Please go to <http://csr.asus.com/english/Takeback.htm> for detail recycling information in different region.

Product information for EU energy label



VA24DQFS



VA27DQFS

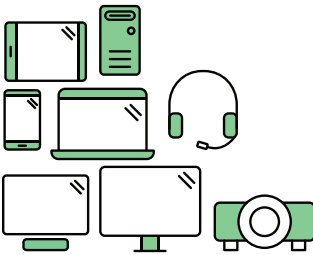

Say hello to a more sustainable product

IT products are associated with a wide range of sustainability risks throughout their life cycle. Human rights violations are common in the factories. Harmful substances are used both in products and their manufacture. Products can often have a short lifespan because of poor ergonomics, low quality and when they are not able to be repaired or upgraded.

This product is a better choice. It meets all the criteria in TCO Certified, the world's most comprehensive sustainability certification for IT products. Thank you for making a responsible product choice, that help drive progress towards a more sustainable future!

Criteria in TCO Certified have a life-cycle perspective and balance environmental and social responsibility. Conformity is verified by independent and approved verifiers that specialize in IT products, social responsibility or other sustainability issues. Verification is done both before and after the certificate is issued, covering the entire validity period. The process also includes ensuring that corrective actions are implemented in all cases of factory non-conformities. And last but not least, to make sure that the certification and independent verification is accurate, both TCO Certified and the verifiers are reviewed regularly.

Want to know more?

Read information about TCO Certified, full criteria documents, news and updates at [tcocertified.com](https://www.tcocertified.com). On the website you'll also find our Product Finder, which presents a complete, searchable listing of certified products.

1.1 Welcome!

Thank you for purchasing the ASUS® LCD monitor!

The latest widescreen LCD monitor from ASUS provides a broader, brighter and crystal-clear display, plus a host of features that enhance your viewing experience.

With these features, you can enjoy the convenience and delightful visual experience that the monitor brings to you!

1.2 Package contents

Check your package for the following items:

- ✓ LCD monitor
- ✓ Monitor base
- ✓ Quick start guide
- ✓ Warranty card
- ✓ Power cord
- ✓ HDMI cable (optional)
- ✓ DisplayPort cable (optional)
- ✓ VGA cable (optional)
- ✓ Audio cable (optional)
- ✓ USB cable (optional)
- ✓ L-shaped screwdriver (optional)
- ✓ 4 screws
- ✓ Phone holder stickers



If any of the above items is damaged or missing, contact your retailer immediately.



If you need to replace the power cord or the connection cable(s), please contact ASUS customer service.

1.3 Monitor introduction

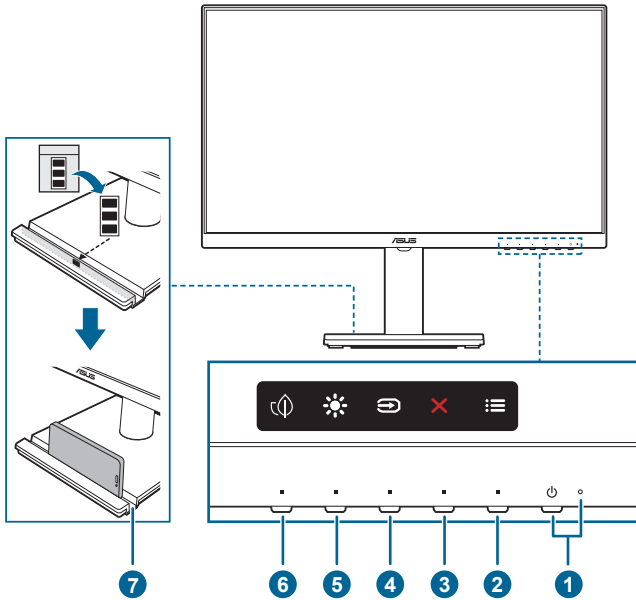

1.3.1 Front view



1. Power button/power indicator
 - Turns the monitor on/off.
 - The color definition of the power indicator is as the below table.

Status	Description
White	On
Amber	Standby mode
Off	Off

2. ☰ Menu button:
 - Press this button to display the OSD menu when the OSD is off.
 - Enters the OSD menu.
 - Toggles the Key Lock function between on and off with a long press for 5 seconds.
3. ✕ Exit button:
 - Press this button to display the OSD menu when the OSD is off.
 - Exits the OSD menu.

4.  Input select button:
 - Press this button to display the OSD menu when the OSD is off.
 - Selects an available input source.
5.  Shortcut 1
 - Press this button to display the OSD menu when the OSD is off.
 - Default: Brightness hotkey
 - To change the hotkey function, go to the Shortcut > Shortcut 1 menu.
6.  Shortcut 2
 - Press this button to display the OSD menu when the OSD is off.
 - Default: Energy Saving hotkey
 - To change the hotkey function, go to the Shortcut > Shortcut 2 menu.
7. Phone holder
 - VA24DQFS: The size of the phone holder is 14.3 x 212.0 mm. Make sure your device fits into the groove.
 - VA27DQFS: The size of the phone holder is 14.3 x 227.9 mm. Make sure your device fits into the groove.
 - You can paste the phone holder stickers on the inside of the front side of the groove to protect your device.

1.3.2 Back view

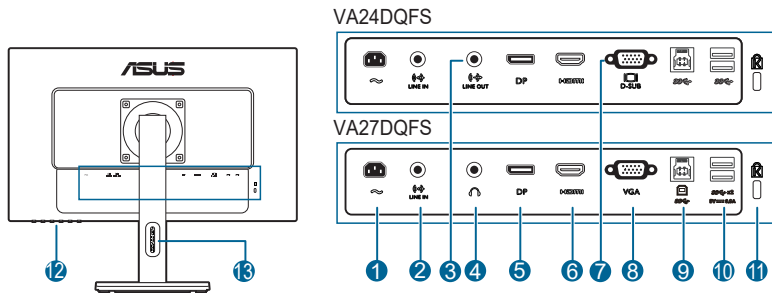

1. **AC-IN port.** This port connects the power cord.
2. **Line in port.** This port connects PC audio source by the audio cable.
3. **Line out port.** This port is only available when an HDMI/DisplayPort cable is connected.
4. **Earphone jack.** This port is only available when an HDMI/DisplayPort cable is connected.
5. **DisplayPort.** This port is for connection for a DisplayPort compatible device.

6. **HDMI port.** This port is for connection with an HDMI compatible device.
7. **D-SUB port.** This 15-pin port is for PC VGA connection.
8. **VGA port.** This 15-pin port is for PC VGA connection.
9. **USB 3.2 Gen 1 Type-B.** This port is for connection with a USB upstream cable. The connection enables the USB ports on the monitor.
10. **USB 3.2 Gen 1 Type-A.** These ports are for connection with USB devices, such as USB keyboard/mouse, USB flash drive, etc.
11. **Kensington lock slot.**
12. **Control buttons.**
13. **Cable management slot.**

2.1 Assembling the monitor arm/base

To assemble the monitor base:

1. Have the front of the monitor face down on a table.
2. Place the arm hinge plate on the rear of the monitor and tighten the screws (for selected models).
3. Insert the arm into the hinge plate and attach the base into the arm, making sure the tab on the base fits into the groove on the arm.
4. Fix the base to the arm by fastening the bundled screw(s).



We recommend that you cover the table surface with soft cloth to prevent damage to the monitor.

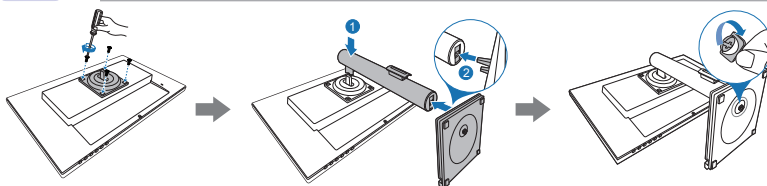

(For selected models)



Hinge screw size: M4 x 8 mm.

2.2 Detaching the arm/base (for VESA wall mount)

The detachable arm/base of this monitor is specially designed for VESA wall mount.

To detach the arm/base:

1. Have the front of the monitor face down on a table.
2. Use a screwdriver to remove the screw(s) on the hinge, then remove the hinge.

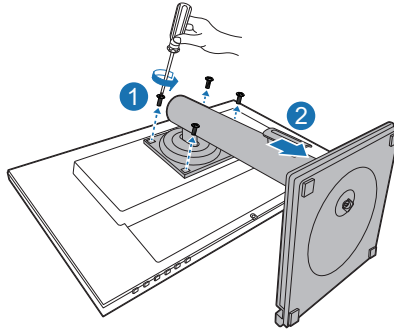

We recommend that you cover the table surface with soft cloth to prevent damage to the monitor.



- The VESA wall mount kit (120 x 120 mm) is purchased separately.
 - Use only the UL Listed Wall Mount Bracket with minimum weight/load 22.7kg (Screw size: M4 x 10 mm)
-

2.3 Adjusting the monitor

- For optimal viewing, we recommend that you look at the full face of the monitor, then adjust the monitor to the angle that is most comfortable for you.
- Hold the stand to prevent the monitor from falling when you change its angle.
- The recommended adjusting angle is $+35^{\circ}$ to -5° (for tilt)/ $+45^{\circ}$ to -45° (for swiveling/VA24DQFS: 130 mm (for height adjustment)/VA27DQFS: 150 mm (for height adjustment)/ $\pm 90^{\circ}$ (for portrait view).

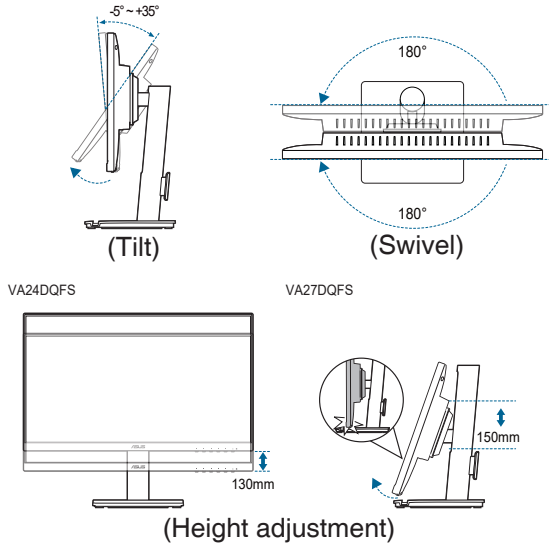

Pivoting the monitor

1. Lift the monitor to the highest position.
2. Tilt the monitor to its maximum angle.
3. Pivot the monitor clockwise or counterclockwise to the angle you need.

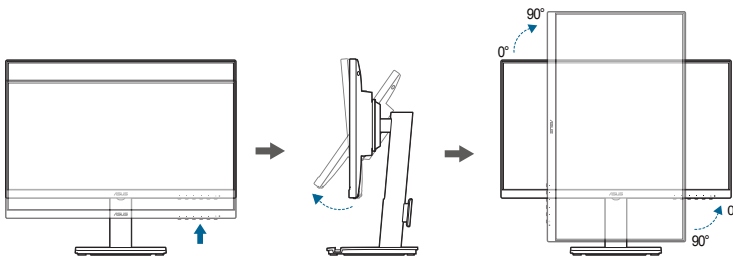

It is normal that the monitor slightly shakes while you adjust the viewing angle.

2.4 Connecting the cables

Connect the cables as the following instructions:

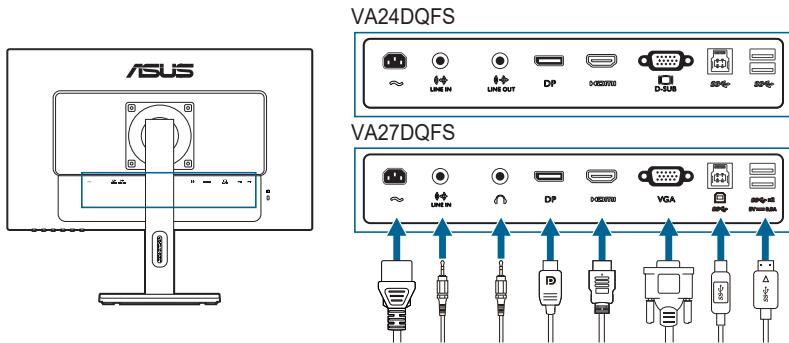

- **To connect the power cord:** Connect one end of the power cord securely to the monitor's AC input port, the other end to a power outlet.
- **To connect the VGA/HDMI/DisplayPort cable:**
 - a. Plug one end of the VGA/HDMI/DisplayPort cable to the monitor's VGA/HDMI/DisplayPort jack.
 - b. Connect the other end of the VGA/HDMI/DisplayPort cable to your computer's VGA/HDMI/DisplayPort jack.
 - c. Tighten the two screws to secure the VGA connector.
- **To connect the audio cable:** connect one end of the audio cable to the monitor's line in port, the other end to the computer's audio-out port.
- **To use the earphone:** connect the audio cable to the monitor's earphone jack or line out port.



When these cables are connected, you can choose the desired signal from the Input Select item in the OSD menu.





If you need to replace the power cord or the connection cable(s), please contact ASUS customer service.

- **To use the USB 3.2 Gen 1 ports:**
 - » Upstream: Take the USB cable, and plug the smaller end (type B) of the USB upstream cable to the monitor's USB upstream port, and the larger end (type A) to your computer's USB port. Make sure your computer is installed with the latest Windows 10/Windows 11 operating system. That will enable the USB ports on the monitor to work.

- » Downstream: Plug the USB Type A cable of your device to the monitor's USB Type A jack.

2.5 Turning on the monitor

Press the power button . See page 1-2 for the location of the power button. The power indicator  lights up in white to show that the monitor is ON.

3.1 OSD (On-Screen Display) menu

3.1.1 How to reconfigure

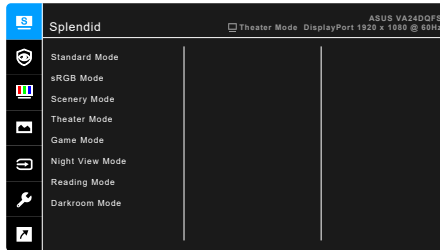

1. Press any button (except the Power button) to display the OSD menu.
2. Press the button to activate the OSD menu.
3. Press the buttons as indicated on the screen to navigate through the functions. Highlight the desired function and press to activate it. If the function selected has a sub-menu, press and again to navigate through the sub-menu functions. Highlight the desired sub-menu function and press to activate it.
4. Press and to change the settings of the selected function.
5. To exit and save the OSD menu, press or repeatedly until the OSD menu disappears. To adjust other functions, repeat steps 1-4.

3.1.2 OSD function introduction

1. Splendid

This function contains 8 sub-functions you can select for your preference. Each mode has the Reset selection, allowing you to maintain your setting or return to the preset mode.

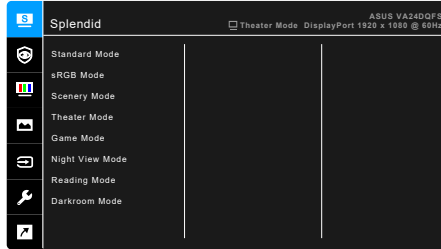

- **Standard Mode:** Best choice for document editing with Splendid Video Enhancement.



Standard Mode meets Energy Star® requirements.

- **sRGB Mode:** best choice for viewing photos and graphics from PCs.
- **Scenery Mode:** Best choice for scenery photo display with Splendid Video Enhancement.
- **Theater Mode:** Best choice for movies with Splendid Video Enhancement.
- **Game Mode:** Best choice for game playing with Splendid Video Enhancement.
- **Night View Mode:** Best choice for dark-scene games or movies with Splendid Video Enhancement.
- **Reading Mode:** This is the best choice for book reading.
- **Darkroom Mode:** This is the best choice for a weak ambient light environment.



-
- In the **Standard Mode**, the following function(s) are not user-configurable: **Saturation, ASCR.**
 - In the **sRGB Mode**, the following function(s) are not user-configurable: **Brightness, Contrast, Saturation, Color Temp., ASCR.**
 - In the **Reading Mode**, the following function(s) are not user-configurable: **Contrast, Saturation, Color Temp., ASCR.**
-

2. Eye Care

In this function, you can adjust settings to better protect your eyes.

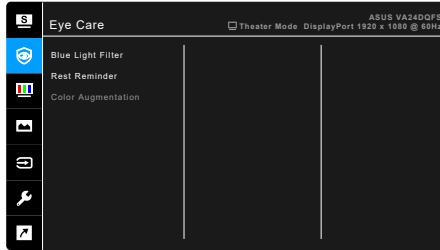

- **Blue Light Filter:** In this function, you can adjust the blue light filter from 0 to **MAX**.
 - * 0: No change.
 - * **MAX:** The higher the level, the less blue light is scattered. When blue light filter is activated, the default settings of **Standard Mode** will be automatically imported. Besides maximum level, the brightness is user-configurable. **MAX** is an optimized setting. It is in compliance with TÜV Low Blue Light (Software Solution) Certification.



Please refer to the following to alleviate eye strains:

- Users should take some time away from the display if working for long hours. It is advised to take short breaks (at least 5 mins) after around 1 hour of continuous working at the computer. Taking short and frequent breaks is more effective than a single longer break.
 - To minimize eye strain and dryness in your eyes, users should rest the eye periodically by focusing on objects that are far away.
 - Eye exercises can help to reduce eye strain. Repeat these exercises often. If eye strain continues please consult a physician. Eye exercises: (1) Repeating look up and down (2) Slowly roll your eyes (3) Move your eyes diagonal.
 - High energy blue light may lead to eye strain and AMD (Age-Related Macular Degeneration). Blue light filter to reduce 70% (max.) harmful blue light to avoiding CVS (Computer Vision Syndrome) when the user adjusts blue light filter bar to maximum level.
-
- **Rest Reminder:** This function provides you a rest reminder according to how long you set for your working time. For example, if you set a 30-minute working time and there will be a pop up reminder appeared on the upper left corner of the monitor for 5 seconds when time is up. Press any key to make this reminder OSD disappear.



When this function is enabled, the following functions are not available:
GamePlus, QuickFit.

- **Color Augmentation:** The adjusting range of color enhancement is from 0 to 100.



This function is not available when **sRGB Mode** is selected in the **Splendid** menu.

3. Color

Set a desired color setting from this menu.

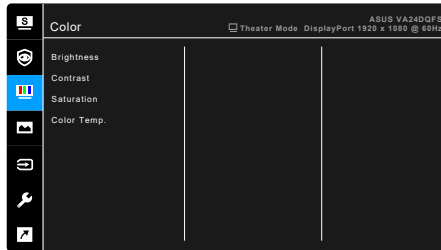

- **Brightness:** The adjusting range is from 0 to 100.
- **Contrast:** The adjusting range is from 0 to 100.
- **Saturation:** The adjusting range is from 0 to 100.
- **Color Temp.:** Contains 4 modes including Cool, Normal, Warm and User Mode.

4. Image

Set the image related setting from this menu.

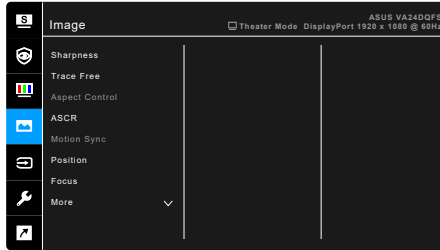

- **Sharpness:** The adjusting range is from 0 to 100.
- **Trace Free:** Adjusts the response time of the monitor.
- **Aspect Control:** Adjusts the aspect ratio to **Full** or **1:1 Ratio**.
- **ASCR:** Turns on/off the ASCR (ASUS Smart Contrast Ratio) function.
- **Motion Sync:** Offers a more clear mode while displaying motion pictures. Please note this function only works when the refresh rate is 100Hz. It includes two modes: **Normal Mode** and **Advanced Mode**, which can provide different effects.



- When this function is enabled, the system will automatically reduce the brightness level.
- If the Adaptive-Sync is enabled, the Motion Sync function is grayed out.

- **Position (Only available for VGA input):** adjusts the horizontal position (H-Position) and the vertical position (V-Position) of the image. The adjusting range is from 0 to 100.
- **Focus (Only available for VGA input):** reduces Horizontal-line noise and Vertical-line noise of the image by adjusting (Phase) and (Clock) separately. The adjusting range is from 0 to 100.



- Phase adjusts the phase of the pixel clock signal. With a wrong phase adjustment, the screen shows horizontal disturbances.
- Clock (pixel frequency) controls the number of pixels scanned by one horizontal sweep. If the frequency is not correct, the screen shows vertical stripes and the image is not proportional.
- **Auto Adjust.:** Automatically adjusts the image to its optimized position, clock, and phase (for VGA mode only).

- **Adaptive-Sync:** Allows a Adaptive-Sync supported* graphics source to dynamically adjust display refresh rate based on typical content frame rates for power efficient, virtually stutter free and low-latency display update.



* Adaptive-Sync can only be activated within 48Hz ~ 100Hz.

* For supported GPUs, minimum PC system and driver requirements, please contact the GPU manufactures.

5. Input Select

In this function, you can select your desired input source or decide if you want the monitor to automatically search for input sources.

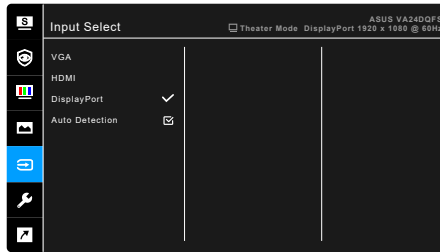

6. System Setup

Allows you to adjust the system.

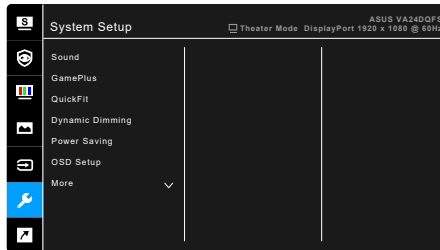

- **Sound:**
 - * **Volume:** The adjusting range is from 0 to 100.
 - * **Mute:** Toggles the monitor sound between on and off.
 - * **Source:** Decides the monitor sound comes from which source.
- **GamePlus:** The GamePlus function provides a toolkit and creates a better gaming environment for users when playing different types of games.

- * **Crosshair:** The crosshair overlays with 6 different crosshair options letting you choose the one that best suits the game you're playing.
- * **Timer:** You can position the timer on the upper left corner of the display so you can keep track of the gaming time.
- * **FPS Counter:** The FPS (frames per second) counter lets you know how smooth the game is running.
- * **Display Alignment:** Display Alignment displays alignment lines on 4 sides of the screen, serving as an easy and handy tool for you to line up multiple monitors perfectly.
- **QuickFit:** You can have a preview of the document or photo layout directly on screen without printing test copies.
 - * **Alignment:** This facilitates designers and users to organize content and layout on one page and achieve a consistent look and feel.

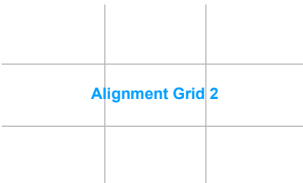
Alignment Grid 1	Alignment Grid 2
	

- * **Paper size:** You can view the documents in real size on the screen.

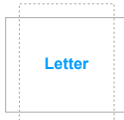
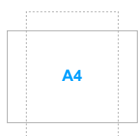
B5	Letter
	
A4 (VA27DQFS only)	
	

- * **Photo:** The various real photo sizes displayed provides photographers and other users to accurately view and edit their photos in real size on the screen.

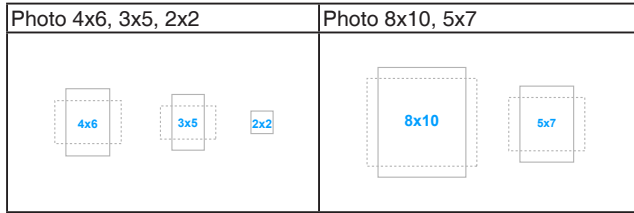

- **Dynamic Dimming:** Synchronizes with contents while contrast changing to execute backlight dynamic dimming.



When this function is activated, the following function(s) will be disabled: **Blue Light Filter, ASCR, Aspect Control.**

- **Power Saving:** Reduces power consumption. The default setting is “**Deep Level**”. When “**Deep Level**” is selected, the maximum brightness value is fixed and **Splendid** mode is fixed at “**Standard Mode**”.
- **OSD Setup:**
 - * Adjusts the OSD timeout from 10 to 120 seconds.
 - * The DDC/CI function is always enabled.
 - * Adjusts the OSD background from opaque to transparent.
- **Language:** There are 23 languages for your selection, including English, French, German, Italian, Spanish, Dutch, Portuguese, Russian, Czech, Croatian, Polish, Romanian, Hungarian, Turkish, Simplified Chinese, Traditional Chinese, Japanese, Korean, Thai, Indonesian, Persian, Ukrainian, Vietnamese.
- **DisplayWidget Center:** Displays a QR code for you to access the information about ASUS DisplayWidget Center.
- **Key Lock:** To disable all function keys. Press the second button from the right over five seconds to cancel the key lock function.
- **Information:** Shows the monitor information.
- **Power Indicator:** Turns the power LED indicator on/off.
- **Power Key Lock:** Enables or disables the power key.
- **All Reset:** “Yes” allows you to restore the default settings.

7. Shortcut

Defines the functions for Shortcut 1 and 2 buttons.

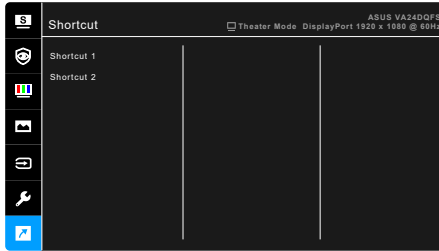

- **Shortcut 1/Shortcut 2:** selects a function for Shortcut 1 and 2 buttons.



When a certain function is selected or activated, your shortcut key may not support. Available function choices for shortcut: **Blue Light Filter, Splendid, Brightness, Contrast, Color Temp., Volume, QuickFit, GamePlus, Rest Reminder, Color Augmentation, Energy Saving.**

3.2 Specifications summary

Panel Type	TFT LCD
Panel size	VA24DQFS: 23.8" (16:9, 60.45 cm) wide screen VA27DQFS: 27" (16:9, 68.5 cm) wide screen
Max. Resolution	1920 x 1080
Pixel pitch	VA24DQFS: 0.2745 mm VA27DQFS: 0.311 mm
Brightness (Typ.)	300 cd/m ²
Contrast Ratio (Typ.)	1000:1
Contrast Ratio (Max.)	100,000,000:1 (with ASCR on)
Viewing angle (H/V) CR>10	178°/178°
Display colors	16.7 M
Response time	5 ms (Grey to Grey), 1 ms MPRT
Splendid Video Enhancement	Yes
Splendid selection	8 video preset modes
Auto adjustment	No
Color temperature selection	4 color temperatures
Analog input	D-sub
Digital input	HDMI v1.4, DisplayPort v1.2
Earphone jack	Yes
Audio input	Yes
Speaker (Built-in)	2 W x 2 Stereo, RMS
USB 3.2 Gen 1 port	1 x USB 3.2 Gen 1 Type-B (upstream) 2 x USB 3.2 Gen 1 Type-A (downstream)
Colors	Black
Power LED	White (On)/Amber (Standby)
Tilt	-5°~+35°
Pivot	+/-90°
Swivel	+/-180°
Height Adjustment	VA24DQFS: 130 mm VA27DQFS: 150 mm
Kensington lock	Yes
AC input voltage	AC: 100~240V
Power consumption	VA24DQFS: Power On: < 11 W** (Typ.), Standby: < 0.5 W (Typ.), Power Off: < 0.3 W VA27DQFS: Power On: < 13 W** (Typ.), Standby: < 0.5 W (Typ.), Power Off: < 0.3 W
Temperature (Operating)	0°C~40°C
Temperature (Non-operating)	-20°C~+60°C

Dimension (W x H x D)	<p>VA24DQFS: 539.7 x 341.4 x 211.2 mm (with stand, lowest) 539.7 x 457 x 211.2 mm (with stand, highest) 539.70 x 325.05 x 54.05 mm (without stand) 668 x 137 x 416 mm (standard packaging)</p> <p>VA27DQFS: 611.9 x 383.4 x 224 mm (with stand, lowest) 611.9 x 528.5 x 224 mm (with stand, highest) 611.9 x 364.71 x 53.94 mm (without stand) 729 x 150 x 445 mm (standard packaging)</p>
Weight (Esti.)	<p>VA24DQFS: 3.35 kg (net without stand); 5.1 kg (net with stand); 7.6 kg (gross)</p> <p>VA27DQFS: 3.75 kg (net without stand); 5.8 kg (net with stand); 8.8 kg (gross)</p>
Multi-languages	23 languages (English, French, German, Italian, Spanish, Dutch, Portuguese, Russian, Czech, Croatian, Polish, Romanian, Hungarian, Turkish, Simplified Chinese, Traditional Chinese, Japanese, Korean, Thai, Indonesian, Persian, Ukrainian, Vietnamese)
Accessories	Quick start guide, warranty card, power cord, HDMI cable (optional), DisplayPort cable (optional), VGA cable (optional), audio cable (optional), USB cable (optional), L-shaped screwdriver (optional), 4 screws, phone holder stickers
Compliance and Standards	cTUVus, FCC, ICES-3, EPEAT GOLD, CB, CE, ErP, WEEE, EU Energy label, ISO 9241-307, UkrSEPRO, Ukraine Energy Doc, CU, EAEU RoHs, CCC, China Energy Label, BSMI, RCM, MEPS, VCCI, PSE, PC Recycle, J-MOSS, KC, KCC, SDoC, Energy Star8.0, TCO 9.0, RoHs, CEC, TÜV Flicker free, TÜV Low Blue Light, SIOC, Windows 10 & 11 WHQL

*Specifications are subject to change without notice.

**Measuring a screen brightness of 300 nits without audio/USB/Card reader connection.

3.4 Troubleshooting (FAQ)

Problem	Possible Solution
Power LED is not ON	<ul style="list-style-type: none"> • Press the ⏻ button to check if the monitor is in the ON mode. • Check if the power cord is properly connected to the monitor and the power outlet. • Check if the power switch is ON.
The power LED lights amber and there is no screen image	<ul style="list-style-type: none"> • Check if the monitor and the computer are in the ON mode. • Make sure the signal cable is properly connected the monitor and the computer. • Inspect the signal cable and make sure none of the pins are bent. • Connect the computer with another available monitor to check if the computer is properly working.
Screen image is too light or dark	<ul style="list-style-type: none"> • Adjust the Contrast and Brightness settings via OSD.
Screen image bounces or a wave pattern is present in the image	<ul style="list-style-type: none"> • Make sure the signal cable is properly connected to the monitor and the computer. • Move electrical devices that may cause electrical interference.
Screen image has color defects (white does not look white)	<ul style="list-style-type: none"> • Inspect the signal cable and make sure that none of the pins are bent. • Perform All Reset via OSD. • Adjust the R/G/B color settings or select the Color Temperature via OSD.
Screen image is blurry or fuzzy	<ul style="list-style-type: none"> • Adjust the Phase and Clock settings via OSD.

3.5 Supported operating modes

Resolution Frequency	Vertical Frequency (Hz)	Horizontal Frequency (KHz)
640 x 480 (60)	59.94Hz	31.469KHz
640 x 480 (75)	75Hz	37.5KHz
800 x 600 (60)	60.32Hz	37.879KHz
800 x 600 (75)	75Hz	46.875KHz
1024 x 768 (60)	60Hz	48.363KHz
1024 x 768 (75)	75.03Hz	60.023KHz
1280 x 960 (60)	60Hz	60KHz
1280 x 1024 (60)	60.02Hz	63.981KHz
1280 x 720(60)	60Hz	45KHz
1600 x 900 (60)	60Hz	60KHz
1920 x 1080 (60)	60Hz	67.5KHz
1920 x 1080 (100)	100Hz	110KHz

When the monitor is operating in the video mode (i.e., not displaying data), the following high definition modes shall be supported in addition to standard definition video.

Resolution Frequency	Vertical Frequency (Hz)	Horizontal Frequency (KHz)
640 x 480p	59.94Hz/60Hz	31.47KHz
720 x 480p (4:3)	59.94Hz/60Hz	31.47KHz
720 x 480p (16:9)	59.94Hz/60Hz	31.47KHz
720 x 576p (4:3)	50Hz	31.25KHz
720 x 576p (16:9)	50Hz	31.25KHz
1280 x 720p	50Hz	37.5KHz
1280 x 720p	59.94Hz/60Hz	45KHz
1920 x 1080p	50Hz	56.25KHz
1920 x 1080p	59.94Hz/60Hz	67.5KHz