

# Latitude 9450 2-in-1

## Owner's Manual

## Notes, cautions, and warnings

 **NOTE:** A NOTE indicates important information that helps you make better use of your product.

 **CAUTION:** A CAUTION indicates either potential damage to hardware or loss of data and tells you how to avoid the problem.

 **WARNING:** A WARNING indicates a potential for property damage, personal injury, or death.

<b>Chapter 1: Views of Latitude 9450 2-in-1.....</b>	<b>6</b>
Right.....	6
Left.....	6
Top.....	8
Front.....	9
Bottom.....	10
Service Tag.....	10
Modes.....	11
Battery charge and status light .....	13
<b>Chapter 2: Set up your Latitude 9450 2-in-1.....</b>	<b>14</b>
<b>Chapter 3: Specifications of Latitude 9450 2-in-1.....</b>	<b>16</b>
Dimensions and weight.....	16
Processor.....	16
Chipset.....	17
Operating system.....	17
Memory.....	18
External ports.....	18
Internal slots.....	19
Audio.....	19
Storage.....	19
Keyboard.....	20
Keyboard shortcuts of Latitude 9450 2-in-1.....	20
Camera.....	22
Clickpad.....	23
Power adapter.....	24
Battery.....	25
Display.....	25
Fingerprint reader (optional).....	26
Sensor .....	27
GPU—Integrated.....	27
Multiple display support matrix.....	28
Hardware security.....	28
Operating and storage environment.....	28
Dell support policy.....	29
SafeShutter .....	29
ComfortView Plus.....	29
<b>Chapter 4: Working inside your computer.....</b>	<b>30</b>
Safety instructions.....	30
Service Mode.....	30
Before working inside your computer.....	32
Safety precautions.....	33

Electrostatic discharge—ESD protection.....	34
ESD Field Service kit .....	34
Transporting sensitive components.....	35
After working inside your computer.....	35
BitLocker.....	35
Recommended tools.....	36
Screw list.....	36
Major components of Latitude 9450 2-in-1.....	37
<b>Chapter 5: Removing and installing Customer Replaceable Units (CRUs).....</b>	<b>39</b>
Nano-SIM card tray.....	39
Removing the Nano-SIM card tray .....	39
Installing the Nano-SIM card tray .....	41
Base cover.....	42
Removing the base cover .....	42
Installing the base cover .....	44
Fan.....	45
Removing the right fan.....	45
Installing the right fan.....	46
Removing the left fan.....	47
Installing the left fan.....	48
Solid state drive.....	49
Removing the solid state drive.....	49
Installing the solid state drive.....	51
Wireless Wide Area Network (WWAN) card.....	51
Removing the WWAN card.....	51
Installing the WWAN card.....	54
Wireless Local Area Network (WLAN) Antenna module.....	55
Removing the WLAN antenna module.....	55
Installing the WLAN antenna module.....	56
<b>Chapter 6: Removing and installing Field Replaceable Units (FRUs).....</b>	<b>57</b>
Battery.....	57
Rechargeable Li-ion battery precautions.....	57
Removing the battery .....	57
Installing the battery .....	60
Heat sink.....	63
Removing the heat sink .....	63
Installing the heat sink.....	64
Display assembly.....	64
Removing the display assembly.....	64
Installing the display assembly.....	67
System-board.....	69
Removing the system board .....	69
Installing the system board .....	74
Power button with fingerprint-reader assembly.....	79
Removing the power button with fingerprint-reader assembly.....	79
Installing the power button with fingerprint reader assembly .....	80
Speaker.....	81

Removing the right-speaker .....	81
Installing the right speaker.....	82
Palm-rest and keyboard assembly.....	84
Removing the palm-rest and keyboard assembly.....	84
Installing the palm-rest and keyboard assembly .....	85
<b>Chapter 7: Software.....</b>	<b>87</b>
Operating system.....	87
Drivers and downloads.....	87
<b>Chapter 8: BIOS Setup.....</b>	<b>88</b>
Entering BIOS setup program.....	88
Navigation keys.....	88
F12 One Time Boot menu.....	88
View Advanced Setup options.....	89
View Service options.....	89
System Setup options.....	89
Updating the BIOS.....	110
Updating the BIOS in Windows.....	110
Updating the BIOS using the USB drive in Windows.....	110
Updating the BIOS from the F12 One Time Boot menu.....	110
System and setup password.....	111
Assigning a System Setup password.....	111
Deleting or changing an existing system setup password.....	112
Clearing Chassis Intrusion Alert.....	112
Clearing CMOS settings.....	114
Clearing BIOS (System Setup) and System passwords.....	115
<b>Chapter 9: Troubleshooting.....</b>	<b>116</b>
Handling swollen rechargeable Li-ion batteries.....	116
Locate the Service Tag or Express Service Code of your Dell computer .....	116
Dell SupportAssist Pre-boot System Performance Check diagnostics.....	117
Running the SupportAssist Pre-Boot System Performance Check.....	117
Built-in self-test (BIST).....	117
M-BIST.....	117
LCD Power rail test (L-BIST).....	118
LCD Built-in Self-Test (BIST).....	118
System-diagnostic lights.....	119
Recovering the operating system.....	120
Recovering the operating system.....	121
Real-Time Clock (RTC Reset).....	121
Backup media and recovery options.....	121
Wi-Fi power cycle.....	121
Drain residual flea power (perform hard reset).....	122
<b>Chapter 10: Getting help and contacting Dell.....</b>	<b>123</b>

# Views of Latitude 9450 2-in-1

## Right



Figure 1. Right view

### 1. Universal audio port

Connect headphones or a headset (headphone and microphone combo).

### 2. Thunderbolt 4.0 with DisplayPort Alt Mode/USB Type-C/USB4/Power Delivery

Supports USB4, DisplayPort 2.1, Thunderbolt 4 and also enables you to connect to an external display using a display adapter. Provides data transfer rates of up to 40 Gbps for USB4 and Thunderbolt 4.

**NOTE:** You can connect a Dell Docking Station to the Thunderbolt 4 ports. For more information, search in the Knowledge Base Resource at [www.dell.com/support](http://www.dell.com/support).

**NOTE:** A USB Type-C to DisplayPort adapter (sold separately) is required to connect a DisplayPort device.

**NOTE:** USB4 is backward compatible with USB 3.2, USB 2.0, and Thunderbolt 3.

**NOTE:** Thunderbolt 4 supports two 4K displays or one 8K display.

### 3. Wedge-shaped lock slot

Connect a security cable to prevent unauthorized movement of your computer.

## Left



Figure 2. Left view

### 1. Thunderbolt 4.0 with DisplayPort Alt Mode/USB Type-C/USB4/Power Delivery

Supports USB4, DisplayPort 2.1, Thunderbolt 4 and also enables you to connect to an external display using a display adapter. Provides data transfer rates of up to 40 Gbps for USB4 and Thunderbolt 4.

**NOTE:** You can connect a Dell Docking Station to the Thunderbolt 4 ports. For more information, search in the Knowledge Base Resource at [www.dell.com/support](http://www.dell.com/support).

**NOTE:** A USB Type-C to DisplayPort adapter (sold separately) is required to connect a DisplayPort device.

**NOTE:** USB4 is backward compatible with USB 3.2, USB 2.0, and Thunderbolt 3.

**NOTE:** Thunderbolt 4 supports two 4K displays or one 8K display.

## 2. Thunderbolt 4.0 with DisplayPort Alt Mode/USB Type-C/USB4/Power Delivery

Supports USB4, DisplayPort 2.1, Thunderbolt 4 and also enables you to connect to an external display using a display adapter. Provides data transfer rates of up to 40 Gbps for USB4 and Thunderbolt 4.

**NOTE:** You can connect a Dell Docking Station to the Thunderbolt 4 ports. For more information, search in the Knowledge Base Resource at [www.dell.com/support](http://www.dell.com/support).

**NOTE:** A USB Type-C to DisplayPort adapter (sold separately) is required to connect a DisplayPort device.

**NOTE:** USB4 is backward compatible with USB 3.2, USB 2.0, and Thunderbolt 3.

**NOTE:** Thunderbolt 4 supports two 4K displays or one 8K display.

## 3. Battery-status light

Indicates the battery-charge status.

- If the computer is connected to the electrical outlet, the battery light operates as follows:
  - Solid white — The battery is charging. When the charge is complete, the LED turns off.
- If the computer is running on a battery, the battery light operates as follows:
  - Off— The battery is adequately charged (or the computer is turned off).
  - Solid amber— The battery charge is critically low (approximately 30 minutes or less remaining battery life).

## 4. Nano-SIM slot (optional)

Insert a Nano-SIM card to connect to a mobile broadband network.

**NOTE:** Availability of the Nano-SIM card slot depends on the region and configuration ordered.

# Top

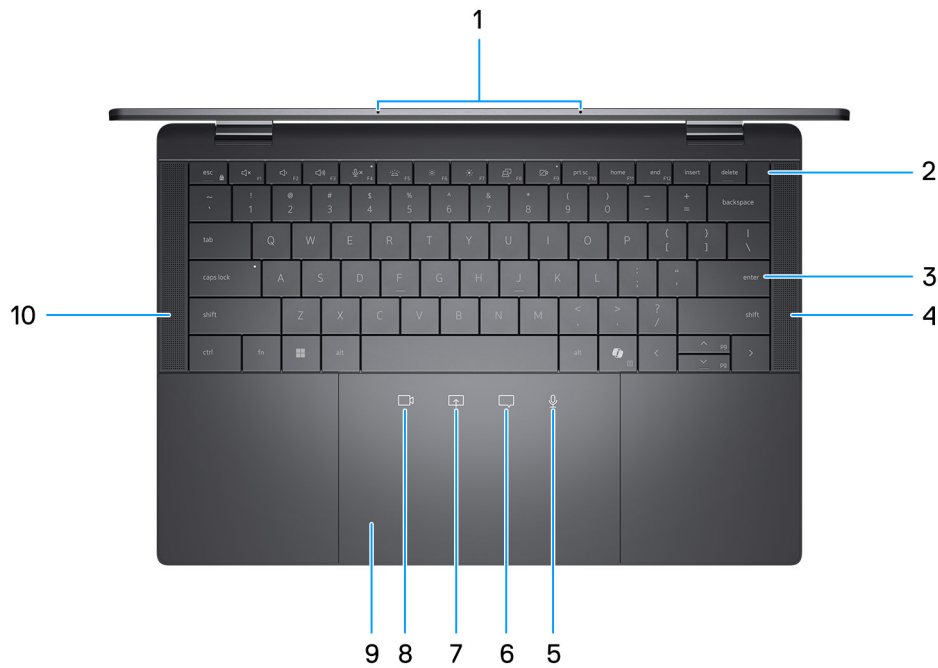

Figure 3. Top view

## 1. Microphones

Provides digital sound input for audio recording and voice calls.

## 2. Power button with optional fingerprint reader

Press to turn on the computer if it is turned off, in sleep state, or in hibernate state.

**i** **NOTE:** When the computer is turned on, press the power button to put the computer into sleep state; press and hold the power button for 10 seconds to force shut-down the computer.

**i** **NOTE:** The power-status light on the power button is available only on computers without the fingerprint reader. Computers that are shipped with the fingerprint reader that is integrated on the power button will not have the power-status light on the power button.

**i** **NOTE:** You can customize the power-button behavior in Windows.

## 3. Zero-Lattice Keyboard with Battery-saving backlight

## 4. Right speaker

Provides audio output.

## 5. Mute mic control (Zoom app and Teams for work or school (Windows desktop) app support only)

Tap to turn on or mute the microphone. Icon turn white when mic is on and red when mic is off.

## 6. Chat box control (Zoom app and Teams for work or school (Windows desktop) app support only)

Tap to show or hide the chat window. The icon blinks when you receive a new chat message.

## 7. Screen share control (Zoom app and Teams for work or school (Windows desktop) app support only)

Tap once to share your screen. Tap again to stop sharing.

## 8. Webcam control (Zoom app and Teams for work or school (Windows desktop) app support only)

Tap to turn on or off the camera. Icon turns white when camera is on and red when camera is off.

## 9. Haptic Collaboration Touchpad



Collaboration icons are only visible when a Zoom or Teams call is ongoing. Compatible video conferencing applications are subject to change.

#### 10. **Left speaker**

Provides audio output.

## Front



**Figure 4. Front view**

#### 1. **Time-of-Flight Sensor**

Time-of-Flight or ToF sensor detects the absence of the user and locks the system for securing the computer and reducing power consumption.

#### 2. **Time-of-Flight Sensor**

Time-of-Flight or ToF sensor detects the absence of the user and locks the system for securing the computer and reducing power consumption.

#### 3. **Ambient-light sensor**

The sensor detects the ambient light and automatically adjusts the display brightness.

#### 4. **Infrared emitter**

Emits infrared light, which enables the infrared camera to sense and track motion.

#### 5. **Camera-status light**

Turns on when the camera is in use.

#### 6. **Infrared camera**

Enhances security when paired with Windows Hello face authentication.

#### 7. **RGB camera**

Enables you to video chat, capture photos, and record videos.

#### 8. **Infrared emitter**

Emits infrared light, which enables the infrared camera to sense and track motion.

# Bottom



Figure 5. Bottom view

## 1. Speakers

Provide audio output.

## 2. Air vents

Air vents provide ventilation for your computer. Clogged air vents can cause overheating and can affect your computer's performance and potentially cause hardware issues. Keep the air vents clear of obstructions and clean them regularly to prevent the build-up of dust and dirt. For more information about cleaning air vents, search for articles in the Knowledge Base Resource at [www.dell.com/support](http://www.dell.com/support).

## 3. Service tag label

The Service Tag is a unique alphanumeric identifier that enables Dell service technicians to identify the hardware components in your computer and access warranty information.

# Service Tag

The service tag is a unique alphanumeric identifier that allows Dell service technicians to identify the hardware components in your computer and access warranty information.



Figure 6. Service tag location

## Modes

The following modes are applicable for your Latitude 9450 2-in-1 computer.

### Notebook



Figure 7. Notebook mode

## Tablet



**Figure 8. Tablet mode**

## Stand



**Figure 9. Stand mode**

# Tent



Figure 10. Tent mode

## Battery charge and status light

The following table lists the battery charge and status light behavior of your Latitude 9450 2-in-1.

Table 1. Battery charge and status light behavior

Power Source	LED Behavior	System Power State	Battery Charge Level
AC Adapter	Off	S0 - S5	Fully Charged
AC Adapter	Solid White	S0 - S5	< Fully Charged
Battery	Off	S0 - S5	11-100%
Battery	Solid Amber (590+/-3 nm)	S0 - S5	< 10%

- S0 (ON) - System is turned on.
- S4 (Hibernate) - The system consumes the least power compared to all other sleep states. The system is almost at an OFF state, except for a trickle power. The context data is written to a hard drive.
- S5 (OFF) - The system is in a shutdown state.

# Set up your Latitude 9450 2-in-1

## About this task

**NOTE:** The images in this document may differ from your computer depending on the configuration you ordered.

## Steps

1. Connect the power adapter and press the power button.



**Figure 11. Connecting the power adapter**

**NOTE:** The battery may go into power-saving mode during shipment to conserve charge on the battery. Ensure that the power adapter is connected to your computer when it is turned on for the first time.

2. Finish the operating system setup.

### For Windows:

Follow the on-screen instructions to complete the setup. When setting up, Dell Technologies recommends that you:





- Connect to a network for Windows updates.

**NOTE:** If connecting to a secured wireless network, enter the password for the wireless network access when prompted.

- If connected to the Internet, sign in with or create a Microsoft account.
- On the **Support and Protection** screen, enter your contact details.

3. Locate and use Dell apps from the Windows Start menu—Recommended.

**Table 2. Locate Dell apps in Windows**

Resources	Description
	<p><b>Dell Command Update</b></p> <p>Updates your computer with critical fixes and latest device drivers as they become available. For more information about using Dell Command Update, see the product guides and third-party license documents at <a href="http://www.dell.com/support">www.dell.com/support</a>.</p>
	<p><b>Dell Digital Delivery</b></p> <p>Download software applications, which are purchased but not preinstalled on your computer. For more information about using Dell Digital Delivery, search in the Knowledge Base Resource at <a href="http://www.dell.com/support">www.dell.com/support</a>.</p>
	<p><b>SupportAssist</b></p> <p>SupportAssist proactively and predictively identifies hardware and software issues on your computer and automates the engagement process with Dell Technical support. It addresses performance and stabilization issues, prevents security threats, monitors, and detects hardware failures. For more information, see <i>SupportAssist for Home PCs User's Guide</i> at <a href="http://www.dell.com/support/home/product-support/product/dell-supportassist-pcs-tablets/docs">www.dell.com/support/home/product-support/product/dell-supportassist-pcs-tablets/docs</a>.</p> <p> <b>NOTE:</b> In SupportAssist, click the warranty expiry date to renew or upgrade your warranty.</p>

# Specifications of Latitude 9450 2-in-1

## Dimensions and weight

The following table lists the height, width, depth, and weight of your Latitude 9450 2-in-1.

**Table 3. Dimensions and weight**

Description	Values
Height:	
Front height	14.92 mm (0.59 in.)
Rear height	16.28 mm (0.64 in.)
Width	310.5 mm (12.22 in.)
Depth	215 mm (8.46 in.)
Weight  <b>NOTE:</b> The weight of your computer depends on the configuration that is ordered and manufacturing variability.	1.54 kg (3.38 lb)

## Processor

The following table lists the details of the processors that are supported for your Latitude 9450 2-in-1.

**Table 4. Processor**

Description	Option one	Option two	Option three
Processor type	Intel Core Ultra 7 165U	Intel Core Ultra 5 135U	Intel Core Ultra 5 125U
Processor wattage	15 W	15 W	15 W
Processor total core count	10	10	10
Performance-cores	2	2	2
Efficient-cores	8	8	8
Processor total thread counts  <b>NOTE:</b> Intel Hyper-Threading Technology is only available on Performance-cores.	12	12	12
Processor speed	1.7 GHz to 4.9 GHz	0.8 GHz to 4.3 GHz	1.3 GHz to 4.3 GHz
Performance-cores frequency			



**Table 4. Processor (continued)**

Description		Option one	Option two	Option three
	Processor base frequency	1.7 GHz	1.6 GHz	1.3 GHz
	Maximum turbo frequency	4.9 GHz	4.4 GHz	4.3 GHz
Efficient-cores frequency				
	Processor base frequency	1.2 GHz	1.1 GHz	0.8 GHz
	Maximum turbo frequency	3.4 GHz	3.2 GHz	3.2 GHz
Thermal Mode/Thermal Design Power (TDP)				
	Cool	12 W-20 W	12 W-20 W	12 W-20 W
	Optimized	15 W-35 W	15 W-35 W	15 W-35 W
	Quiet	12 W-20 W	12 W-20 W	12 W-20 W
	Ultra Performance	22 W-40 W	22 W-40 W	22 W-40 W
		 <b>NOTE:</b> Processor clock speeds and thermal design power differ according to the thermal mode selected in the My Dell app on your computer.		
	Processor cache	12 MB	12 MB	12 MB
	Integrated graphics	Intel Graphics	Intel Graphics	Intel Graphics

## Chipset

The following table lists the details of the chipset that is supported for your Latitude 9450 2-in-1.

**Table 5. Chipset**

Description	Values
Chipset	Integrated with the processor
Processor	Intel Core Ultra 5/7
DRAM bus width	64-bit
Flash EPROM	64 MB
PCIe bus	Up to Gen4

## Operating system

Your Latitude 9450 2-in-1 supports the following operating systems:

- Windows 11 22H2
- Windows 11 23H2

# Memory

The following table lists the memory specifications of your Latitude 9450 2-in-1.

**Table 6. Memory specifications**

Description	Values
Memory slots	On-board memory  <b>NOTE:</b> Integrated memory is not upgradable.
Memory type	LPDDR5x
Memory speed	7467 MT/s
Maximum memory configuration	64 GB
Minimum memory configuration	16 GB
Memory configurations supported	<ul style="list-style-type: none"> <li>• 16 GB, LPDDR5x, 7467 MT/s, dual-channel, integrated</li> <li>• 32 GB, LPDDR5x, 7467 MT/s, dual-channel, integrated</li> <li>• 64 GB, LPDDR5x, 7467 MT/s, dual-channel, integrated</li> </ul>

# External ports

The following table lists the external ports of your Latitude 9450 2-in-1.

**Table 7. External ports**

Description	Values
Network port	Not supported
USB ports	Three Thunderbolt 4 with Power Delivery and DisplayPort (USB Type-C)  <b>NOTE:</b> You can connect a Dell Docking Station to any of the three ports. For more information, search in the Knowledge Base Resource at <a href="http://www.dell.com/support">www.dell.com/support</a>
Audio port	One universal audio port
Video port	Supported through USB-C
Media-card reader	Not supported
Power-adaptor port	DC-in through one of the three Thunderbolt 4 USB Type-C ports
Security-cable slot	One wedge-shaped lock slot
SIM-card slot	nano-SIM slot (optional)

## Internal slots

The following table lists the internal slots of your Latitude 9450 2-in-1.

**Table 8. Internal slots**

Description	Values
M.2	<ul style="list-style-type: none"> <li>On-board Wi-Fi and Bluetooth</li> <li>One M.2 3052 slot for WWAN</li> <li>One M.2 2230 slot for solid-state drive (SSD)</li> </ul> <p><b>NOTE:</b> To learn more about the features of different types of M.2 cards, search in the Knowledge Base Resource at <a href="http://www.dell.com/support">www.dell.com/support</a>.</p>

## Audio

The following table lists the audio specifications of your Latitude 9450 2-in-1.

**Table 9. Audio specifications**

Description	Values	
Audio controller	Waves MaxxAudio Pro 13 Output	
Stereo conversion	Supported	
Internal audio interface	SoundWire interface	
External audio interface	Universal audio jack	
Number of speakers	Four	
Internal-speaker amplifier	Realtek ALC1318	
External volume controls	Keyboard shortcut controls	
Speaker output:		
	Average speaker output	2 W
	Peak speaker output	2.5 W
Subwoofer output	Supported	
Microphone	Dual-array microphone on FPC	

## Storage

This section lists the storage options on your Latitude 9450 2-in-1.

Your computer supports one M.2 2230 solid-state drive

**Table 10. Storage specifications**

Storage type	Interface type	Capacity
M.2 2230, Class 35 solid-state drive	Gen 4 PCIe x4 NVMe	256 GB/512 GB/1 TB

**Table 10. Storage specifications (continued)**

Storage type	Interface type	Capacity
M.2 2230, Class 35 solid-state drive, self-encrypting drive	Gen 4 PCIe x4 NVMe	512 GB
M.2 2230, Class 25 solid-state drive	Gen 4 PCIe x4 NVMe	2 TB

## Keyboard

The following table lists the keyboard specifications of your Latitude 9450 2-in-1.

**Table 11. Keyboard specifications**

Description	Values
Keyboard type	Single-pointing spill-resistant, zero-lattice keyboard with battery-saving backlight
Keyboard layout	QWERTY
Number of keys	<ul style="list-style-type: none"> <li>• United States and Canada: 79 keys</li> <li>• United Kingdom: 80 keys</li> <li>• Japan: 83 keys</li> </ul>
Keyboard size	X=19.05 mm key pitch Y=18.05 mm key pitch
Keyboard shortcuts	Some keys on your keyboard have two symbols on them. These keys can be used to type alternate characters or to perform secondary functions. To type the alternate character, press Shift and the desired key. To perform secondary functions, press Fn and the desired key. <b>i</b> <b>NOTE:</b> You can define the primary behavior of the function keys (F1–F12) by changing the <b>Function Key Behavior</b> in the BIOS setup program.

## Keyboard shortcuts of Latitude 9450 2-in-1

**i** **NOTE:** Keyboard characters may differ depending on the keyboard language configuration. Keys that are used for shortcuts remain the same across all language configurations.



Some keys on your keyboard have two symbols on them. These keys can be used to type alternate characters or to perform secondary functions. The symbol that is shown on the lower part of the key refers to the character that is typed out when the key is pressed. If you press shift and the key, the symbol that is shown on the upper part of the key is typed out. For example, if you press **2**, **2** is typed out; if you press **Shift + 2**, **@** is typed out.

The keys F1-F12 at the top row of the keyboard are function keys for multimedia control, as indicated by the icon at the bottom of the key. Press the function key to invoke the task represented by the icon. For example, pressing F1 mutes the audio (see the following table).

However, if the function keys F1-F12 are needed for specific software applications, multimedia functionality can be disabled by pressing **Fn + Esc**. Later, multimedia control can be invoked by pressing **Fn** and the respective function key. For example, mute audio by pressing **Fn + F1**.

**i** **NOTE:** You can also define the primary behavior of the function keys (F1–F12) by changing **Function Key Behavior** in BIOS setup program.

**Table 12. List of keyboard shortcuts**

Keys	Primary behavior
Copilot	Launch Copilot in Windows  <b>NOTE:</b> If Copilot in Windows is not available on your computer, the Copilot key launches Windows Search. For more information about Copilot in Windows, search in the Knowledge Base Resource at <a href="http://www.dell.com/support">www.dell.com/support</a> .
F1	Mute audio
F2	Decrease volume
F3	Increase volume
F4	Mute mic
F5	Adjust keyboard backlight level.  <b>NOTE:</b> Press to cycle the keyboard backlight level through low, medium, or high.
F6	Decrease display brightness
F7	Increase display brightness
F8	Switch to external display
F9	SafeShutter control
F10	Print screen
F11	Home
F12	End

The **Fn** key is also used with selected keys on the keyboard to invoke other secondary functions.

**Table 13. Secondary behavior**

Key combination for the task	Secondary behavior
Fn + F1	Operating system and application-specific F1 behavior
Fn + F2	Operating system and application-specific F2 behavior
Fn + F3	Operating system and application-specific F3 behavior
Fn + F4	Operating system and application-specific F4 behavior
Fn + F5	Operating system and application-specific F5 behavior
Fn + F6	Operating system and application-specific F6 behavior
Fn + F8	Operating system and application-specific F8 behavior
Fn + F9	Operating system and application-specific F9 behavior
Fn + F10	Operating system and application-specific F10 behavior
Fn + F11	Operating system and application-specific F11 behavior
Fn + F12	Operating system and application-specific F12 behavior
Fn + PrtScr	Turn off or on wireless
Fn + B	Pause or break
Fn + Insert	Sleep
Fn + S	Toggle scroll lock
Fn + R	System request

**Table 13. Secondary behavior (continued)**

Key combination for the task	Secondary behavior
Fn + Ctrl	Open the application menu
Fn + Esc	Toggle Fn-key lock
Fn + PgUp	Page up
Fn + PgDn	Page down
Fn + Home	Home
Fn + End	End

## Camera

The following table lists the camera specifications of your Latitude 9450 2-in-1.

**Table 14. Camera specifications**

Description	Values
Number of cameras	One
Camera type	<ul style="list-style-type: none"> <li>FHD RGB + IR Camera with built-in collaboration features</li> <li>Low light capability</li> <li>TNR, Intelligent Privacy, IPU6, Proximity Sensor, Intel Camera Sensing Technology (ExpressSign-in 2.0), dual-array microphones</li> </ul> FHD RGB + IR Camera with built-in collaboration features - Low light capability, TNR, Intelligent Privacy, IPU6, Proximity Sensor, Intel Camera Sensing Technology (ExpressSign-in 2.0), dual-array microphones
Camera location	Front camera
Camera sensor type	Intel Camera Sensing Technology (ExpressSign-in 2.0)
Camera resolution:	
Still image	2.07 megapixels
Video	1920 x 1080 (FHD) at 60 fps
Infrared camera resolution:	
Still image	0.18 megapixels
Video	1280 x 720 at 30 fps
Diagonal viewing angle:	
Camera	82.2 degrees
Infrared camera	78.1 degrees



# Clickpad

The following table lists the clickpad specifications of your Latitude 9450 2-in-1.

**Table 15. Clickpad specifications**

Description	Values
Clickpad type	Haptic Collaboration Touchpad
Haptic functionality	Control the level of loudness and haptic feedback from the Windows 11 operating system settings, <b>Bluetooth and Devices</b> . Select from 0 % to 100 % for intensity of the haptic feedback.
Collaboration controls on clickpad	<p>Four controls are available to control video, share screen, chat, and mute microphone functions during conference calls.</p> <p><b>NOTE:</b></p> <ul style="list-style-type: none"> <li>The collaboration controls are compatible only with Zoom and Microsoft Teams for work or school.</li> <li>The collaboration controls are visible only when a conference call is ongoing.</li> </ul>
Collaboration controls settings	<ul style="list-style-type: none"> <li>Control brightness manually or configure icon brightness to automatically adjust to the ambient light.</li> <li>Customize settings to activate collaboration controls with a single tap or a double tap.</li> <li>Customize settings to enable or disable specific controls.</li> </ul>
Collaboration controls functionality	<ul style="list-style-type: none"> <li>Video icon: Turn on or off the webcam.               <ul style="list-style-type: none"> <li>White icon: The camera is turned on.</li> <li>Red icon: The camera is off.</li> </ul> </li> <li>Share screen icon: Tap once to share your screen. Tap again to stop sharing.</li> <li>Chat icon: Show or hide the chat window. The icon blinks when you receive a new chat message.</li> <li>Microphone icon: Turn on or mute the microphone.               <ul style="list-style-type: none"> <li>White icon: The microphone is turned on.</li> <li>Red icon: The microphone is muted.</li> </ul> </li> </ul>
Required apps for collaboration controls	<ul style="list-style-type: none"> <li>Dell Optimizer Version 4.2.0.0 and higher</li> <li>Zoom Client Version 5.9.3 and higher</li> <li>Microsoft Teams for work or school (Windows desktop) Version 1.6.00.24078 and higher</li> </ul>
Clickpad resolution:	> 300 dpi
Clickpad dimensions:	
Horizontal	135.00 mm (5.31 in.)
Vertical	91.40 mm (3.59 in.)
Clickpad gestures	For more information about clickpad gestures available on Windows, see the Microsoft Knowledge Base article at <a href="https://support.microsoft.com">support.microsoft.com</a> .
<p><b>NOTE:</b> To enjoy the collaboration touchpad (CTP) controls feature on your keyboard, ensure that you have the latest versions of the Dell Optimizer app and Zoom or Teams for work or school installed on your computer. Dell Optimizer supports modular installation which allows you to select the modules you want to install. Install the collaboration touchpad module within the Dell Optimizer app to enjoy the functionality of collaboration controls. For more information, search for the Dell Optimizer User's Guide in the Knowledge Base Resource at <a href="https://www.dell.com/support">www.dell.com/support</a>.</p>	

**Table 15. Clickpad specifications (continued)**

Description	Values
<p> <b>NOTE:</b> For more information about how to configure and use the collaboration controls, search for the Collaboration Touchpad Reference Guide in the Knowledge Base Resource at <a href="http://www.dell.com/support">www.dell.com/support</a>. Or, watch the video at <a href="http://www.dell.com/collaboration-touchpad">www.dell.com/collaboration-touchpad</a>.</p> <p> <b>NOTE:</b> Collaboration Touchpad is supported only on Teams for work or school (Windows desktop) application. Teams for home and Teams on web are currently not supported.</p>	

## Power adapter

The following table lists the power adapter specifications of your Latitude 9450 2-in-1.

**Table 16. Power adapter specifications**



Description	Option one	Option two	Option three
Type	60 W AC adapter, USB-C	65 W AC adapter, USB-C	100 W AC adapter, USB-C
Power-adapter dimensions:			
Height	22.00 mm (0.866 in.)	28.00 mm (1.10 in.)	26.50 mm (4.80 in.)
Width	66.00 mm (2.598 in.)	51.00 mm (2.01 in.)	60.00 mm (2.36 in.)
Depth	55.00 mm (2.165 in.)	112.00 mm (4.41 in.)	122.00 mm (4.80 in.)
Weight	0.105 kg (0.231 lbs)	0.201 kg (0.443 lbs)	0.33 kg (0.731 lbs)
Input voltage	100 VAC – 240 VAC	100 VAC – 240 VAC	100 VAC – 240 VAC
Input frequency	50 Hz – 60 Hz	50 Hz – 60 Hz	50 Hz – 60 Hz
Input current (maximum)	1.70 A	1.70 A	1.70 A
Output current (continuous)	<ul style="list-style-type: none"> <li>● 5 V/3 A</li> <li>● 9 V/3 A</li> <li>● 15 V/3 A</li> <li>● 20 V/3 A</li> </ul>	<ul style="list-style-type: none"> <li>● 5 V/3 A</li> <li>● 9 V/3 A</li> <li>● 15 V/3 A</li> <li>● 20 V/3.25 A</li> </ul>	<ul style="list-style-type: none"> <li>● 5 V/3 A</li> <li>● 9 V/3 A</li> <li>● 15 V/3 A</li> <li>● 20 V/5 A</li> </ul>
Rated output voltage	<ul style="list-style-type: none"> <li>● 5 VDC</li> <li>● 9 VDC</li> <li>● 15 VDC</li> <li>● 20 VDC</li> </ul>	<ul style="list-style-type: none"> <li>● 5 VDC</li> <li>● 9 VDC</li> <li>● 15 VDC</li> <li>● 20 VDC</li> </ul>	<ul style="list-style-type: none"> <li>● 5 VDC</li> <li>● 9 VDC</li> <li>● 15 VDC</li> <li>● 20 VDC</li> </ul>
Temperature range:			
Operating	0°C to 40°C (32°F to 104°F)	0°C to 40°C (32°F to 104°F)	0°C to 40°C (32°F to 104°F)
Storage	-20°C to 70°C (-4°F to 158°F)	-40°C to 70°C (-40°F to 158°F)	-40°C to 70°C (-40°F to 158°F)
<p> <b>CAUTION:</b> Operating and storage temperature ranges may differ among components, so operating or storing the device outside these ranges may impact the performance of specific components.</p>			



# Battery

The following table lists the battery specifications of your Latitude 9450 2-in-1.

**Table 17. Battery specifications**

Description		Values
Battery type		3-cell, 60 WHr, ExpressCharge Boost capable, Long-lifecycle capable
Battery voltage		11.55 VDC
Battery weight (maximum)		0.24 kg (0.52 lb)
Battery dimensions:		
	Height	250.70 mm (9.87 in.)
	Width	81.18 mm (3.19 in.)
	Depth	5.35 mm (0.21 in.)
Temperature range:		
	Operating	<ul style="list-style-type: none"> <li>Charge: 0°C to 50°C (32°F to 122°F)</li> <li>Discharge: 0°C to 70°C (32°F to 158°F)</li> </ul>
	Storage	-20°C to 60°C (-4°F to 140°F)
Battery operating time		Varies depending on operating conditions and can significantly reduce under certain power-intensive conditions.
Battery charging time (approximate)		<ul style="list-style-type: none"> <li>3 hours (when the computer is turned off)</li> <li>80% in 60 min with ExpressCharge 1.0</li> <li>35% in 20 min with ExpressCharge Boost</li> </ul>
 <b>NOTE:</b> Control the charging time, duration, start and end time, and so on, using the Dell Power Manager application. For more information about Dell Power Manager, search in the Knowledge Base Resource at <a href="http://www.dell.com/support">www.dell.com/support</a> .		
Coin-cell battery		Not supported
 <b>CAUTION:</b> Operating and storage temperature ranges may differ among components, so operating or storing the device outside these ranges may impact the performance of specific components.		
 <b>CAUTION:</b> Dell Technologies recommends that you charge the battery regularly for optimal power consumption. If your battery charge is depleted, connect the power adapter, turn on your computer, and then restart your computer to reduce the power consumption.		

# Display

The following table lists the display specifications of your Latitude 9450 2-in-1.

**Table 18. Display specifications**

Description	Values
Display type	14-inch, Quad High Definition (QHD+)
Touch options	Yes

**Table 18. Display specifications (continued)**

Description		Values
Display-panel technology		IPS
Display-panel dimensions (active area):		
	Height	188.49 mm (7.42 in.)
	Width	301.59 mm (11.87 in.)
	Diagonal	355.64 mm (14.00 in.)
Display-panel native resolution		2560 x 1600
Luminance (typical)		500 nits
Megapixels		2.30
Color gamut		sRGB 100%
Pixels Per Inch (PPI)		161
Contrast ratio (minimum)		1000:1
Response time (maximum)		35 ms
Refresh rate		60 Hz
Horizontal view angle		88 degree
Vertical view angle		88 degree
Pixel pitch		0.15 mm
Power consumption (maximum)		2.85 W
Anti-glare vs glossy finish		anti-reflection, anti-smudge

## Fingerprint reader (optional)

The following table lists the specifications of the optional fingerprint-reader of your Latitude 9450 2-in-1.

**Table 19. Fingerprint reader specifications**

Description	Values
Fingerprint-reader sensor technology	Trans-capacitive sensing
Fingerprint-reader sensor resolution	500 dpi
Fingerprint-reader sensor pixel size	108 mm x 88 mm

# Sensor

The following table lists the sensor of your Latitude 9450 2-in-1.

**Table 20. Sensor**

<b>Sensor support</b>
Low Power Vision AI Based User Presence Detection
Ambient Light Sensor
Windows Auto Brightness
IR User Proximity Detection
eCompass/Magnetometer
Accelerometer
Gyro + Accelerometer
Adaptive Thermal Performance (via Gyroscope/Accelerometer)
Screen Rotation support
Near Field Proximity Sensor
Hall Effect Sensor
Sensor Hub
Wake/Power on with lid open
Dell ExpressSign-In 1.0 (via Proximity Sensor)
Dell ExpressSign-in 2.0 (via Intel Camera Sensing Technology)
GPS (via WWAN Card only)
Gyroscope
Accelerometer: ST Micro LIS2DW12TR(1st) or Bosch BMA422(2nd) in the base (system board) for 2-in-1
Accelerometer + Gyro: ST Micro LSM6DSOUSTR in the hinge-up sensor board for 2-in-1

# GPU—Integrated

The following table lists the specifications of the integrated Graphics Processing Unit (GPU) supported by your Latitude 9450 2-in-1.

**Table 21. GPU—Integrated**

Controller	Memory size	Processor
Intel Graphics	Shared system memory	Intel Core Ultra 5/7

# Multiple display support matrix

The following table lists the multiple display support matrix of your Latitude 9450 2-in-1.

**Table 22. Multiple display support matrix**

Graphics Card	Supported external displays with computer internal display on	Supported external displays with computer internal display off
Integrated GPU	Up to 3	Up to 4

# Hardware security

The following table lists the hardware security of your Latitude 9450 2-in-1.

**Table 23. Hardware security**

Hardware security
Trusted Platform Module (TPM) 2.0 FIPS-140-2 Certified/TCG Certified
Touch Fingerprint Reader (in Power Button) with Control Vault 3.0 Plus Advanced Authentication with FIPS 140-2 Level 3 Certification (Optional)
Face IR camera (Windows Hello compliant) with ExpressSign-in 1.0 (Proximity Sensor) and ExpressSign-in 2.0 (Camera Sensing)
Dell SafeBIOS - Verifies the integrity of BIOS using a secure off-host source, and if the test fails, captures and stores a copy of the test result in a secure area in the computer.
Dell SafeBIOS - Indicators of Attack - Alerts when malicious activity is detected
Dell SafeID - Dedicated FIPS Level 3 security chip secures end user credentials <sup>1</sup> - TCG Certified
Dell SafeSupply Chain - Optional tamper evident packing and pre-imaging HDD wipes to NIST standards from a secure Dell facility.
Dell SafeShutter - Control your camera shutter by pressing F9 on your keyboard to enable or disable the shutter.

# Operating and storage environment

This table lists the operating and storage specifications of your Latitude 9450 2-in-1.

**Airborne contaminant level:** G1 as defined by ISA-S71.04-1985

**Table 24. Computer environment**

Description	Operating	Storage
Temperature range	0°C to 35°C (32°F to 95°F)	-40°C to 65°C (-40°F to 140°F)
Relative humidity (maximum)	10% to 90% (non-condensing)	0% to 95% (non-condensing)
Vibration (maximum)*	0.66 GRMS	Not applicable
Shock (maximum)	140 G†	Not applicable
Altitude range	0 m to 3,048 m (0 ft to 10,000 ft)	0 m to 10,668 m (0 ft to 35,000 ft)
 <b>CAUTION: Operating and storage temperature ranges may differ among components, so operating or storing the device outside these ranges may impact the performance of specific components.</b>		

\* Measured using a random vibration spectrum that simulates the user environment.

† Measured using a 2 ms half-sine pulse.

## Dell support policy

For information about Dell support policy, search in the Knowledge Base Resource at [www.dell.com/support](http://www.dell.com/support).

## SafeShutter

This section details the SafeShutter specifications of your Latitude 9450 2-in-1.

SafeShutter lets you take control of your privacy with the camera disable (F9 key), and mic mute (F4 key) to override software settings. When the camera is on, press the F9 key to close the camera shutter and then press the F9 key again to open the camera shutter.

## ComfortView Plus

 **WARNING: Prolonged exposure to blue light from the display may lead to long-term effects such as eye strain, eye fatigue, or damage to the eyes.**

Blue light is a color in the light spectrum which has a short wavelength and high energy. Chronic exposure to blue light, particularly from digital sources, may disrupt sleep patterns and cause long-term effects such as eye strain, eye fatigue, or damage to the eyes.

The display on this computer is designed to minimize blue light and complies with TÜV Rheinland's requirement for low blue light displays.

Low blue light mode is enabled at the factory, so no further configuration is necessary.











To reduce the risk of eye strain, it is also recommended that you:

- Position the display at a comfortable viewing distance between 20 and 28 inches (50 cm and 70 cm) from your eyes.
- Blink frequently to moisten your eyes, wet your eyes with water, or apply suitable eye drops.
- Look away from your display, and gaze at a distant object at 20 ft (609.60 cm) away for at least 20 seconds during each break.
- Take an extended break for 20 minutes every two hours.

# Working inside your computer

## Safety instructions

Use the following safety guidelines to protect your computer from potential damage and to ensure your personal safety. Unless otherwise noted, each procedure in this document assumes that you have read the safety information that shipped with your computer.

-  **WARNING:** Before working inside your computer, read the safety information that is shipped with your computer. For more safety best practices, see the Regulatory Compliance home page at [www.dell.com/regulatory\\_compliance](http://www.dell.com/regulatory_compliance).
-  **WARNING:** Disconnect your computer from all power sources before opening the computer cover or panels. After you finish working inside the computer, replace all covers, panels, and screws before connecting your computer to an electrical outlet.
-  **CAUTION:** To avoid damaging the computer, ensure that the work surface is flat, dry, and clean.
-  **CAUTION:** To avoid damaging the components and cards, handle them by their edges, and avoid touching the pins and the contacts.
-  **CAUTION:** You should only perform troubleshooting and repairs as authorized or directed by the Dell technical assistance team. Damage due to servicing that is not authorized by Dell is not covered by your warranty. See the safety instructions that is shipped with the product or at [www.dell.com/regulatory\\_compliance](http://www.dell.com/regulatory_compliance).
-  **CAUTION:** Before touching anything inside your computer, ground yourself by touching an unpainted metal surface, such as the metal at the back of the computer. While you work, periodically touch an unpainted metal surface to dissipate static electricity which could harm internal components.
-  **CAUTION:** When you disconnect a cable, pull it by its connector or its pull tab, not the cable itself. Some cables have connectors with locking tabs or thumbscrews that you must disengage before disconnecting the cable. When disconnecting cables, keep them evenly aligned to avoid bending the connector pins. When connecting cables, ensure that the ports and the connectors are correctly oriented and aligned.
-  **CAUTION:** Press and eject any installed card from the media-card reader.
-  **CAUTION:** Exercise caution when handling rechargeable Li-ion batteries in laptops. Swollen batteries should not be used and should be replaced and disposed properly.
-  **NOTE:** The color of your computer and certain components may differ from what is shown in this document.

## Service Mode

**Service Mode** allows users to immediately cut off power from the system and conduct repairs without disconnecting the battery cable from the system board:

1. Shut down the system and disconnect the AC adapter.
2. Press and hold the **<B>** key on the keyboard and then press the **Power** button. The system boots.

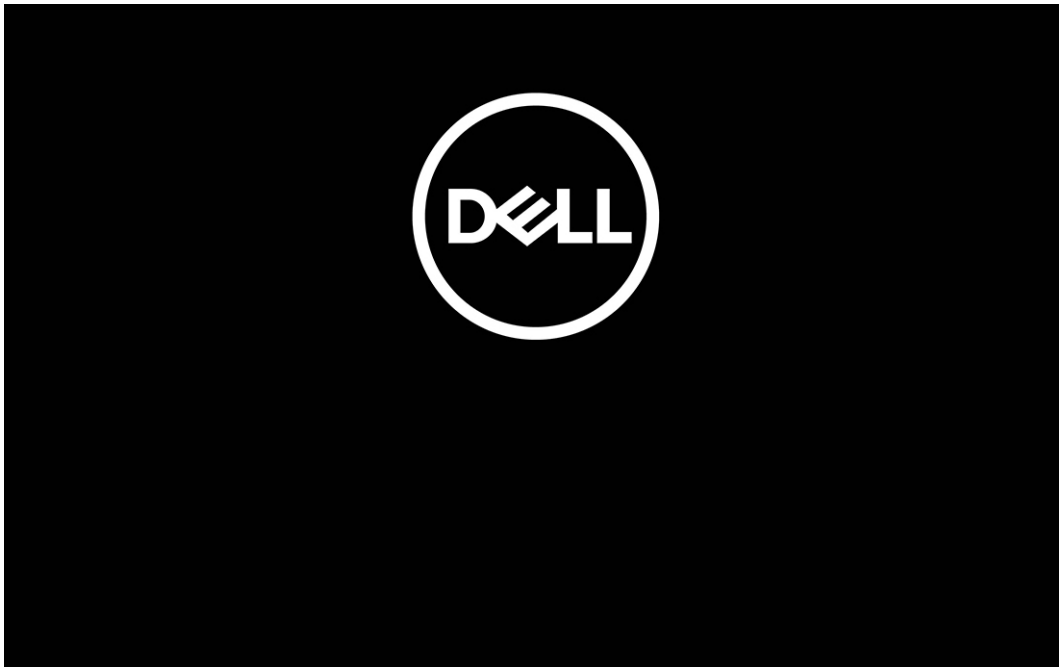
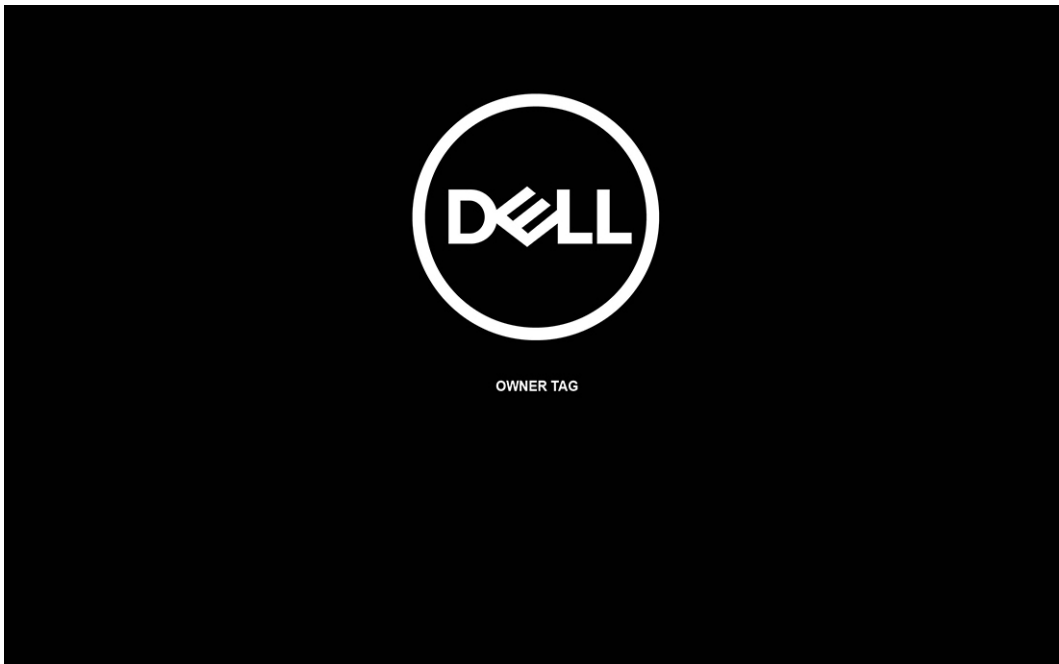

**Figure 12. Dell logo screen**

**3. For computers configured with an Owner Tag**

When the Owner Tag information appears on the screen, press any key to proceed.

**i** **NOTE:** The Service Mode procedure will automatically skip this step if the Owner Tag of the system is not set up in advance by the manufacturer.



**Figure 13. Owner Tag**

**4. Ensure that the AC adapter has been disconnected and press any key to proceed.**



**Figure 14. Press any key**

5. When the ready-to-proceed message appears on the screen, press any key to proceed. The system emits three short beeps and shuts down immediately.

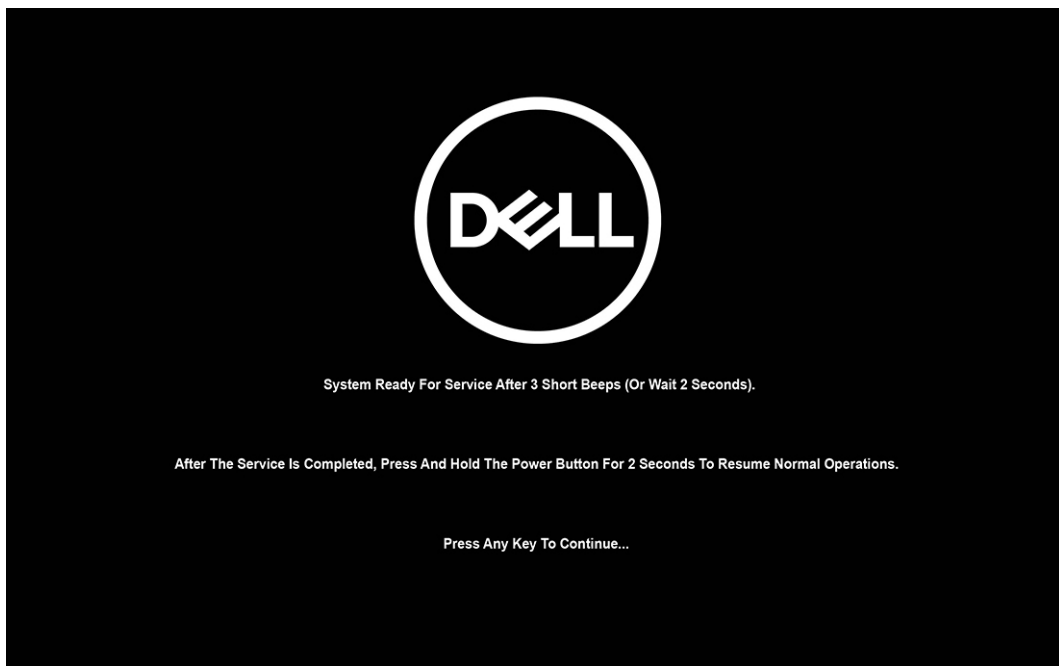

**Figure 15. Ready-to-proceed message**

Once the system shuts down, you can then go to perform replacement procedures.

To exit Service Mode, connect the AC adapter and press the power button to power on the system. The system will automatically return to normal functioning mode.

## Before working inside your computer

### Steps

1. Save and close all open files and exit all open applications.
2. Shut down your computer. For Windows operating system, click **Start** > **Power** > **Shut down**.





 **NOTE:** If you are using a different operating system, see the documentation of your operating system for shut-down instructions.

3. Disconnect your computer and all attached devices from their electrical outlets.
4. Disconnect all attached network devices and peripherals, such as keyboard, mouse, and monitor from your computer.
5. Remove any media card and optical disk from your computer, if applicable.
6. Enter the service mode, if you can turn on your computer.

### Service Mode

Service Mode is used to cut off power, without disconnecting the battery cable from the system board prior to conducting repairs in the computer.

 **CAUTION:** If you are unable to turn on the computer to put it into Service Mode, or the computer does not support Service Mode, proceed to disconnect the battery cable. To disconnect the battery cable, follow the steps in [Removing the battery](#).

 **NOTE:** Ensure that your computer is shut down and the AC adapter is disconnected.

- a. Hold the **<B>** key on the keyboard and press the power button for 3 seconds or until the Dell logo appears on the screen.
- b. Press any key to continue.
- c. If the AC adapter is not disconnected, a message prompting you to remove the AC adapter appears on the screen. Remove the AC adapter and then press any key to continue the **Service Mode** process. The **Service Mode** process automatically skips the following step if the **Owner Tag** of the computer is not set up in advance by the user.
- d. When the **ready-to-proceed** message appears on the screen, press any key to proceed. The computer emits three short beeps and shuts down immediately.
- e. Once the computer shuts down, it has successfully entered Service Mode.

 **NOTE:** If you are unable to turn on your computer or unable to enter Service Mode, skip this process.

## Safety precautions

The safety precautions chapter details the primary steps to be taken before performing any disassembly instructions.

Observe the following safety precautions before you perform any installation or break or fix procedures involving disassembly or reassembly:

- Turn off the computer and all attached peripherals.
- Disconnect the computer and all attached peripherals from AC power.
- Disconnect all network cables, telephone, and telecommunications lines from the computer.
- Use an ESD field service kit when working inside any notebook to avoid electrostatic discharge (ESD) damage.
- After removing any computer component, carefully place the removed component on an anti-static mat.
- Wear shoes with non-conductive rubber soles to reduce the chance of getting electrocuted.

## Standby power

Dell products with standby power must be unplugged before you open the case. Systems that incorporate standby power are powered while turned off. The internal power enables the computer to be remotely turned on (Wake-on-LAN) and suspended into a sleep mode and has other advanced power management features.

Unplugging, pressing, and holding the power button for 15 seconds should discharge residual power in the system board.

## Bonding

Bonding is a method for connecting two or more grounding conductors to the same electrical potential. This is done by using a field service electrostatic discharge (ESD) kit. When connecting a bonding wire, ensure that it is connected to bare metal and never to a painted or nonmetal surface. The wrist strap should be secure and in full contact with your skin, and ensure that you remove all jewelry such as watches, bracelets, or rings prior to bonding yourself and the equipment.

## Electrostatic discharge—ESD protection

ESD is a major concern when you handle electronic components, especially sensitive components such as expansion cards, processors, memory modules, and system boards. Slight charges can damage circuits in ways that may not be obvious, such as intermittent problems or a shortened product life span. As the industry pushes for lower power requirements and increased density, ESD protection is an increasing concern.

Due to the increased density of semiconductors used in recent Dell products, the sensitivity to static damage is now higher than in previous Dell products. For this reason, some previously approved methods of handling parts are no longer applicable.

Two recognized types of ESD damage are catastrophic and intermittent failures.

- **Catastrophic** – Catastrophic failures represent approximately 20 percent of ESD-related failures. The damage causes an immediate and complete loss of device functionality. An example of catastrophic failure is a memory DIMM that has received a static shock and immediately generates a "No POST/No Video" symptom with a beep code that is emitted for missing or nonfunctional memory.
- **Intermittent** – Intermittent failures represent approximately 80 percent of ESD-related failures. The high rate of intermittent failures means that most of the time when damage occurs, it is not immediately recognizable. The DIMM receives a static shock, but the tracing is merely weakened and does not immediately produce outward symptoms that are related to the damage. The weakened trace may take weeks or months to melt, and in the meantime may cause degradation of memory integrity, intermittent memory errors, and so on.

The more difficult type of damage to recognize and troubleshoot is the intermittent (also called latent or "walking wounded") failure.

Perform the following steps to prevent ESD damage:

- Use a wired ESD wrist strap that is properly grounded. Wireless anti-static straps do not provide adequate protection. Touching the chassis before handling parts does not ensure adequate ESD protection on parts with increased sensitivity to ESD damage.
- Handle all static-sensitive components in a static-safe area. If possible, use anti-static floor pads and workbench pads.
- When unpacking a static-sensitive component from its shipping carton, do not remove the component from the anti-static packing material until you are ready to install the component. Before unwrapping the anti-static packaging, ensure that you discharge static electricity from your body.
- Before transporting a static-sensitive component, place it in an anti-static container or packaging.

## ESD Field Service kit

The unmonitored Field Service kit is the most commonly used service kit. Each Field Service kit includes three main components: anti-static mat, wrist strap, and bonding wire.

### Components of an ESD field service kit

The components of an ESD field service kit are:

- **Anti-Static Mat** – The anti-static mat is dissipative and parts can be placed on it during service procedures. When using an anti-static mat, your wrist strap should be snug and the bonding wire should be connected to the mat and to any bare metal on the computer being worked on. Once deployed properly, service parts can be removed from the ESD bag and placed directly on the mat. ESD-sensitive items are safe in your hand, on the ESD mat, in the computer, or inside an ESD bag.
- **Wrist Strap and Bonding Wire** – The wrist strap and bonding wire can be either directly connected between your wrist and bare metal on the hardware if the ESD mat is not required, or connected to the anti-static mat to protect hardware that is temporarily placed on the mat. The physical connection of the wrist strap and bonding wire between your skin, the ESD mat, and the hardware is known as bonding. Use only Field Service kits with a wrist strap, mat, and bonding wire. Never use wireless wrist straps. Always be aware that the internal wires of a wrist strap are prone to damage from normal wear and tear, and must be checked regularly with a wrist strap tester in order to avoid accidental ESD hardware damage. It is recommended to test the wrist strap and bonding wire at least once per week.
- **ESD Wrist Strap Tester** – The wires inside an ESD strap are prone to damage over time. When using an unmonitored kit, it is a best practice to regularly test the strap prior to each service call, and at a minimum, test once per week. A wrist strap tester is the best method for doing this test. If you do not have your own wrist strap tester, check with your regional office to find out if they have one. To perform the test, plug the bonding-wire of wrist-strap into the tester while it is strapped to your wrist and push the button to test. A green LED is lit if the test is successful; a red LED is lit and an alarm sounds if the test fails.
- **Insulator Elements** – It is critical to keep ESD sensitive devices, such as plastic heat sink casings, away from internal parts that are insulators and often highly charged.

- **Working Environment** – Before deploying the ESD Field Service kit, assess the situation at the customer location. For example, deploying the kit for a server environment is different than for a desktop or laptop environment. Servers are typically installed in a rack within a data center; desktops or laptops are typically placed on office desks or cubicles. Always look for a large open flat work area that is free of clutter and large enough to deploy the ESD kit with additional space to accommodate the type of computer that is being repaired. The workspace should also be free of insulators that can cause an ESD event. On the work area, insulators such as Styrofoam and other plastics should always be moved at least 12 inches or 30 centimeters away from sensitive parts before physically handling any hardware components.
- **ESD Packaging** – All ESD-sensitive devices must be shipped and received in static-safe packaging. Metal, static-shielded bags are preferred. However, you should always return the damaged part using the same ESD bag and packaging that the new part arrived in. The ESD bag should be folded over and taped shut and all the same foam packing material should be used in the original box that the new part arrived in. ESD-sensitive devices should be removed from packaging only at an ESD-protected work surface, and parts should never be placed on top of the ESD bag because only the inside of the bag is shielded. Always place parts in your hand, on the ESD mat, in the computer, or inside an anti-static bag.
- **Transporting Sensitive Components** – When transporting ESD sensitive components such as replacement parts or parts to be returned to Dell, it is critical to place these parts in anti-static bags for safe transport.

## ESD protection summary

It is recommended to always use the traditional wired ESD grounding wrist strap and protective anti-static mat when servicing Dell products. In addition, it is critical to keep sensitive parts separate from all insulator parts while performing service and use anti-static bags for transporting sensitive components.

## Transporting sensitive components

When transporting ESD sensitive components such as replacement parts or parts to be returned to Dell, it is critical to place these parts in anti-static bags for safe transport.

## After working inside your computer

### About this task

 **CAUTION:** Leaving stray or loose screws inside your computer may severely damage your computer.

### Steps

1. Replace all screws and ensure that no stray screws remain inside your computer.
  2. Connect any external devices, peripherals, or cables you removed before working on your computer.
  3. Replace any media cards, discs, or any other parts that you removed before working on your computer.
  4. Connect your computer and all attached devices to their electrical outlets.
-  **NOTE:** To exit service mode, ensure to connect the AC adapter to the power-adapter port on your computer.
5. Press the power button to turn on the computer. Your computer will automatically return to normal functioning mode.

## BitLocker

 **CAUTION:** If BitLocker is not suspended before updating the BIOS, the next time you reboot the system it will not recognize the BitLocker key. You will then be prompted to enter the recovery key to progress, and the system will ask for the recovery key on each reboot. If the recovery key is not known, this can result in data loss or an unnecessary operating system reinstall. For more information about this subject, see Knowledge Article: [updating the BIOS on Dell systems with BitLocker enabled](#).

The installation of the following components triggers BitLocker:

- Hard disk drive or solid-state drive
- System board

# Recommended tools













The procedures in this document may require the following tools:

- Phillips screwdriver #0
- Phillips screwdriver #1
- Plastic scribe



# Screw list

- NOTE:** When removing screws from a component, it is recommended to note the screw type, and the quantity of screws, and then place them in a screw storage box. This is to ensure that the correct number of screws and correct screw type is restored when the component is replaced.
- NOTE:** Some computers have magnetic surfaces. Ensure that the screws are not left attached to such surfaces when replacing a component.
- NOTE:** Screw color may vary with the configuration ordered.

**Table 25. Screw list**

Component	Screw type	Quantity	Image
Base cover	Captive screws	6	
Solid-state drive	Captive screw	1	
WWAN card	M1.6x2.3	1	
Right fan	M1.6x3	2	
Left fan	M1.6x3	2	
Display cable/Left Type-C bracket	M1.6x3	2	
Right Type-C bracket	M1.6x3	3	
Display assembly	M2.5x4	6	
Heat sink	Captive screws	3	
Battery	M2x3	6	 Image: M2x3
Right speaker	M1.6x1.8	2	
WLAN antenna module	M1.6x2	2	

**Table 25. Screw list (continued)**

Component	Screw type	Quantity	Image
Power button with fingerprint reader assembly	M1.6x2	1	
System board	M1.6x2	6	
	M1.6x3	1	

## Major components of Latitude 9450 2-in-1

The following image shows the major components of Latitude 9450 2-in-1.

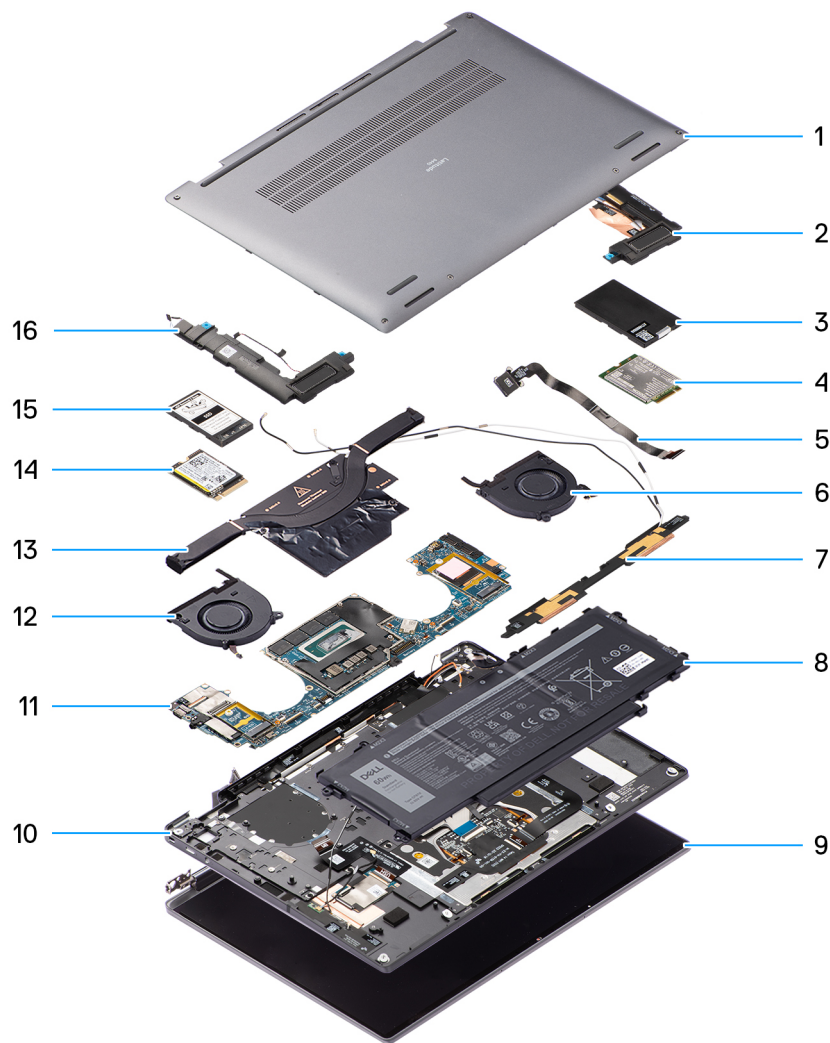

**Figure 16. Explode view**

1. Base cover
2. Speaker
3. WWAN card shielding cover

4. WWAN card
5. Power button
6. Fan
7. WLAN antenna module
8. Battery
9. Display assembly
10. Palm-rest and keyboard assembly
11. System board
12. Fan
13. Heatsink
14. Solid-state drive
15. Solid-state drive shielding cover
16. Speaker

 **NOTE:** Dell provides a list of components and their part numbers for the original system configuration purchased. These parts are available according to warranty coverage that you have purchased. Contact your Dell sales representative for purchase options.

# Removing and installing Customer Replaceable Units (CRUs)

The replaceable components in this chapter are Customer Replaceable Units (CRUs).

 **CAUTION:** Customers can replace only the Customer Replaceable Units (CRUs) following the safety precautions and replacement procedures.

 **NOTE:** The images in this document may differ from your computer depending on the configuration you ordered.

## Nano-SIM card tray

### Removing the Nano-SIM card tray

#### Prerequisites

1. Follow the procedure in [Before working inside your computer](#).

 **NOTE:** Ensure that your computer is in Service Mode. For more information see, step 6 in [Before working inside your computer](#).

#### About this task

The following image provides a visual representation of the Nano-SIM card tray removal procedure.

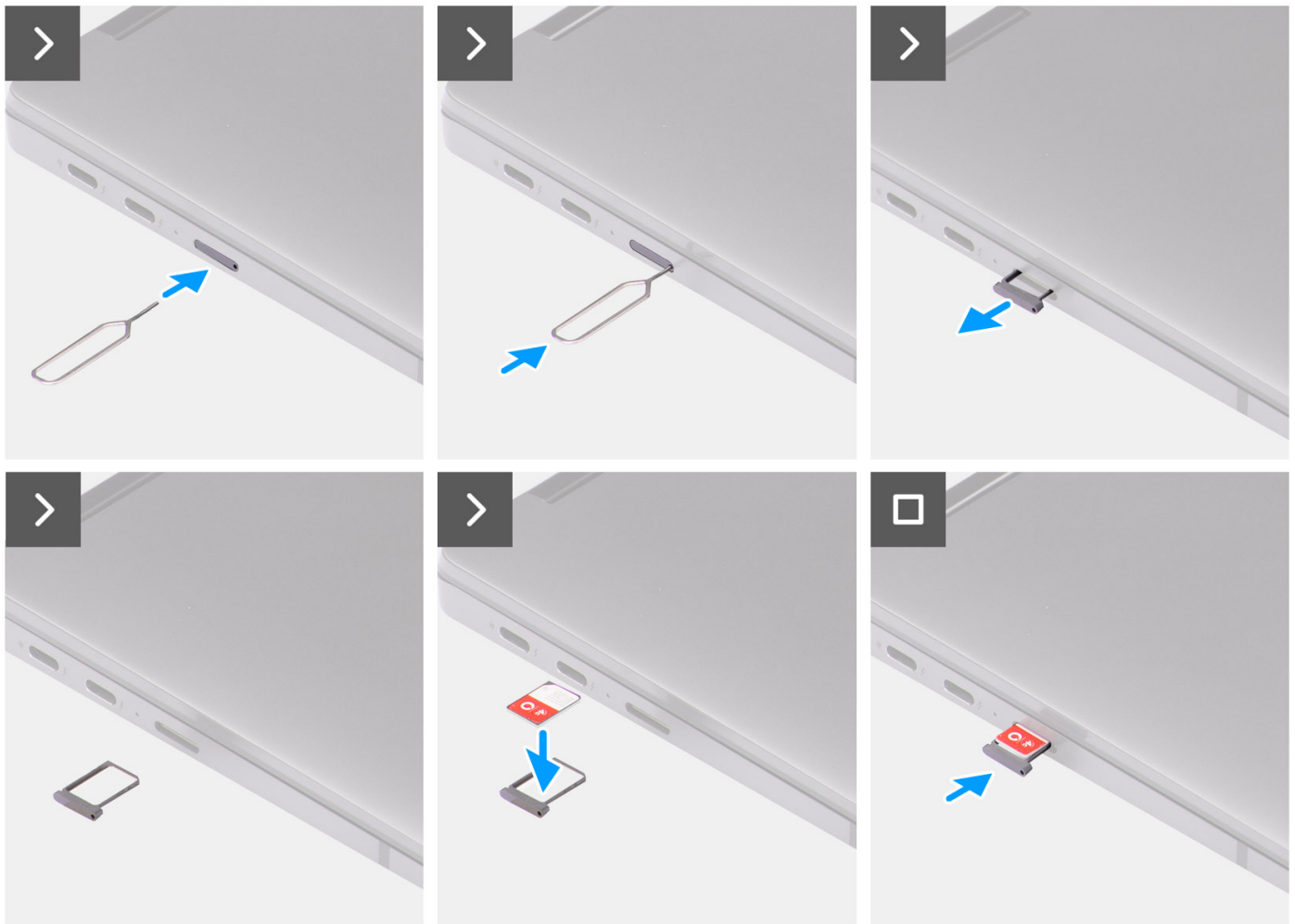

**Figure 17. Removing the Nano-SIM card tray**

**Steps**

1. Insert the Nano-SIM card removal pin into the release hole to release the Nano-SIM card tray.
2. Push the pin to disengage the lock, and eject the Nano-SIM card tray.
3. Slide the Nano-SIM card tray out of the slot on the system.
4. Remove the Nano-SIM from the Nano-SIM card tray.
5. Slide the Nano-SIM card tray back into the slot on the system.



# Installing the Nano-SIM card tray

## Prerequisites

If you are replacing a component, remove the necessary component before the installation procedure.

## About this task

The following image provides a visual representation of the Nano-SIM card tray installation procedure.

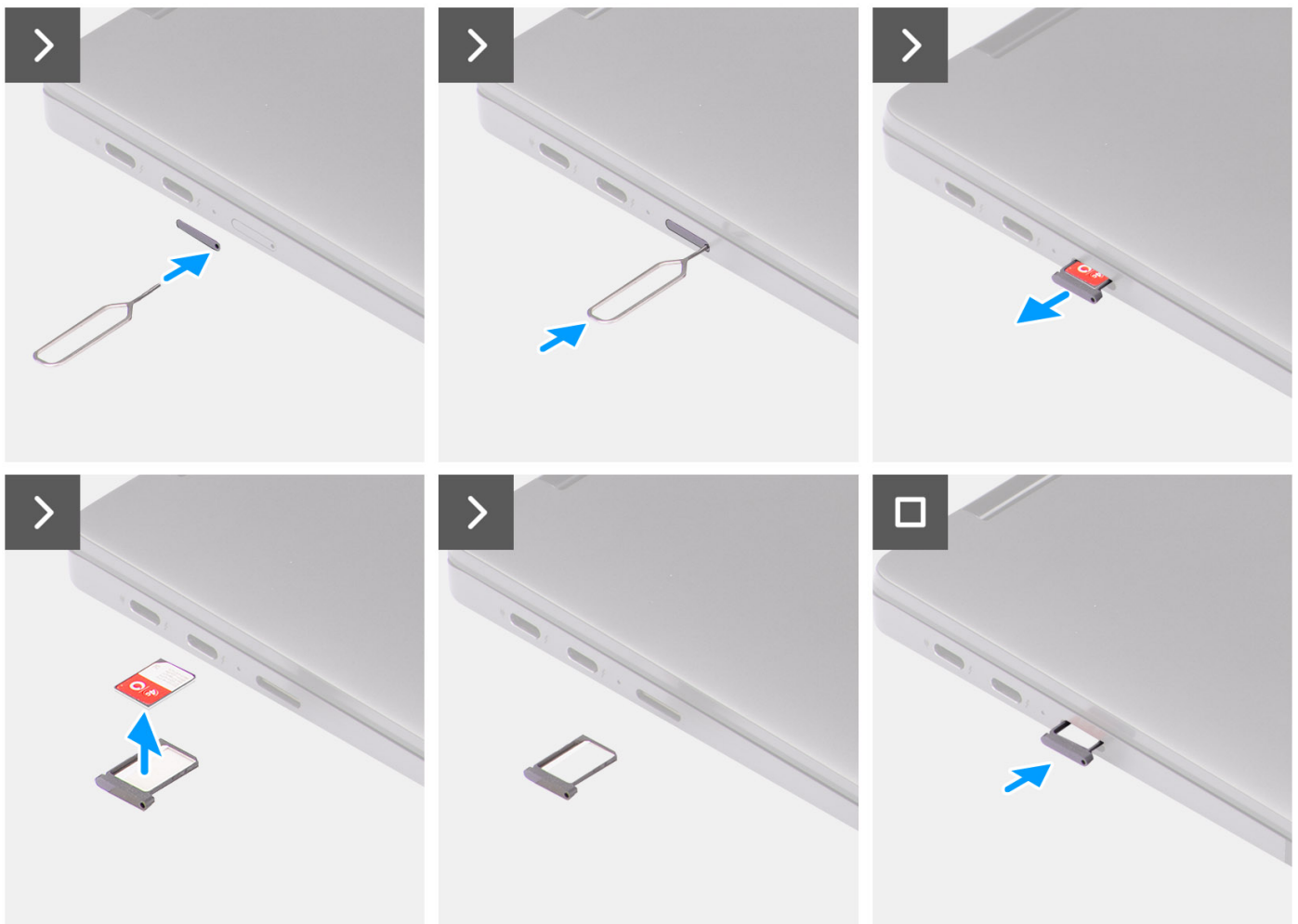

Figure 18. Installing the Nano-SIM card tray

## Steps

1. Insert the Nano-SIM card removal pin into the release hole to remove the Nano-SIM card tray.
2. Push the pin to disengage the lock, and eject the Nano-SIM card tray.

3. Slide the Nano-SIM card tray out of the slot on the system.
4. Align and place the Nano-SIM card in the dedicated slot on the Nano-SIM card tray.
5. Slide the Nano-SIM card tray back into the slot on the system.

**Next steps**

Follow the procedure in [after working inside your computer](#).

## Base cover

### Removing the base cover

**Prerequisites**

1. Follow the procedure in [Before working inside your computer](#).
2. Remove the [nanoSIM-card tray](#).

**About this task**

The following images indicate the location of the base cover and provide a visual representation of the removal procedure.



**Figure 19. Base cover removal**

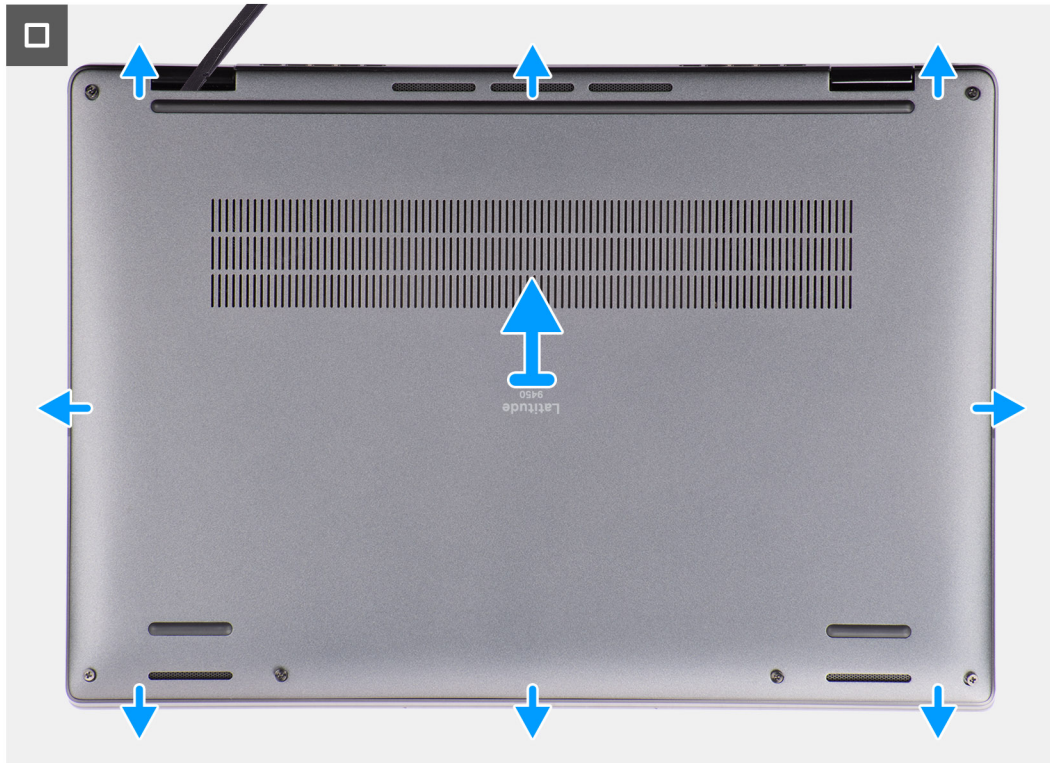

Figure 20. Base cover removal

**Steps**

1. Loosen the six captive screws that secure the base cover to the system.
2. Using a plastic scribe, pry open the base cover starting from the recesses, which are in the U-shaped indents at the top edge of the base cover, near the hinges.



Figure 21. Base cover pry points

**CAUTION:** Do not lift the base cover from the top side immediately after prying it from the recesses, as this will cause damage to the base cover. Proceed with the following steps to loosen all the hooks that secure the base cover to the system before removing the base cover.

3. Pry open the top side of the base cover and continue working on the left, right and, bottom sides to open the base cover.
4. Hold the left and right sides of the base cover, and remove the base cover from the system.

## Installing the base cover

### Prerequisites

If you are replacing a component, remove the existing component before performing the installation procedure.

### About this task

The following images indicate the location of the base cover and provide a visual representation of the installation procedure.

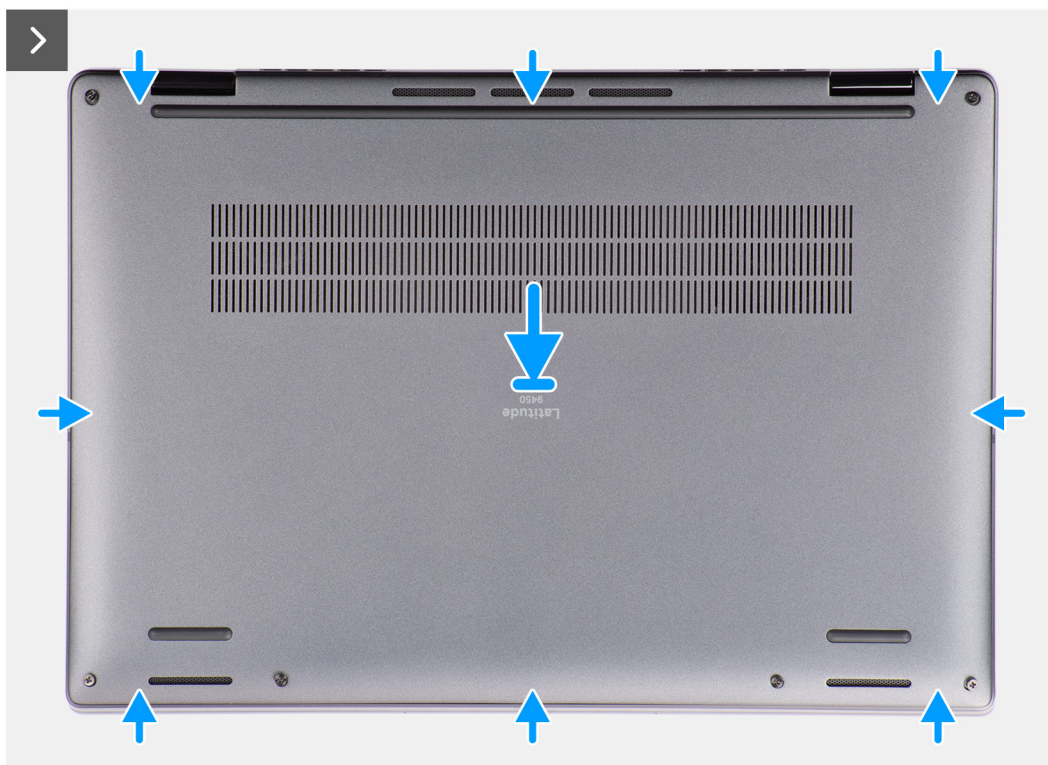

Figure 22. Installing the base cover



**Figure 23. Installing the base cover**

#### Steps

1. Align and place the base cover on the palm-rest and keyboard assembly, and snap the base cover into place.
2. Tighten the six captive screws to secure the base cover to the system.

#### Next steps

1. Install the [nanoSIM-card tray](#).
2. Follow the procedure in [after working inside your computer](#).

## Fan

### Removing the right fan

#### Prerequisites

1. Follow the procedure in [Before working inside your computer](#).

**NOTE:** Ensure that your computer is in Service Mode. For more information, see step 6 in [Before working inside your computer](#).

2. Remove the [Nano-SIM card tray](#).
3. Remove the [base cover](#).

### About this task

The following image indicates the location of the right fan and provides a visual representation of the removal procedure.



Figure 24. Removing the right fan

### Steps

1. Peel off the mylar sticker from the system board.
2. Disconnect the right-fan FPC cable from the connector (FANR) on the system board.
3. Remove the two (M1.6x3) screws that secure the right fan to the palm-rest assembly and keyboard.
4. Lift the right fan off the palm-rest assembly and keyboard.

## Installing the right fan

### Prerequisites

If you are replacing a component, remove the existing component before performing the installation procedure.

### About this task

The following image indicates the location of the right fan and provides a visual representation of the installation procedure.

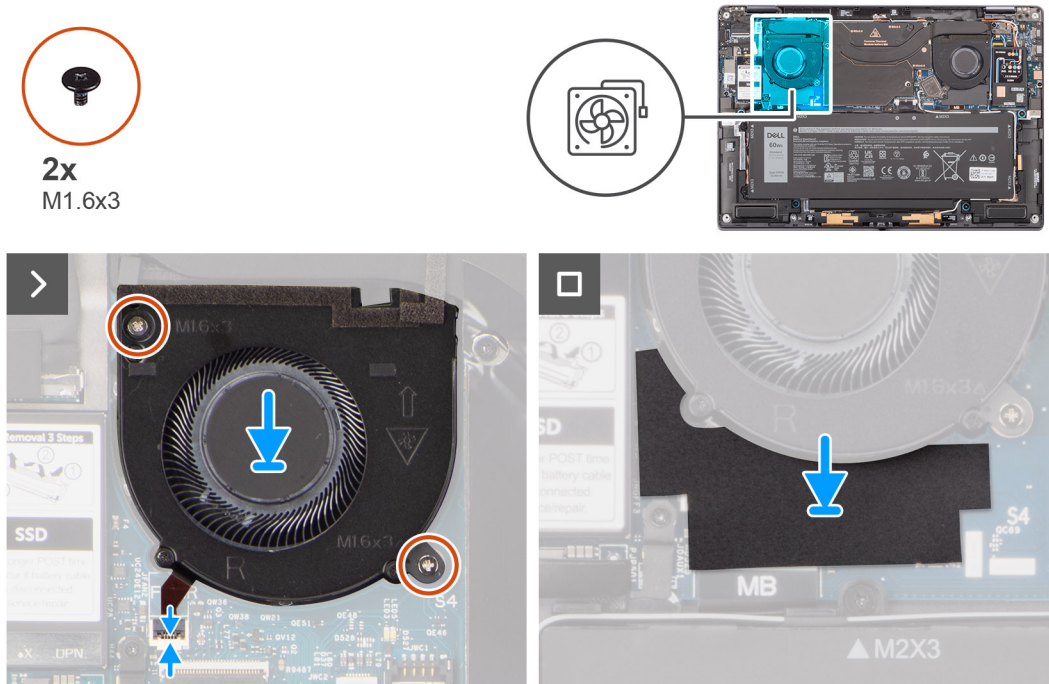

**Figure 25. Installing the right fan**

### Steps

1. Align and place the right fan onto the palm-rest assembly.
2. Replace the two (M1.6x3) screws to secure the right fan to the palm-rest assembly.
3. Connect the right-fan FPC cable to the connector (FANR) on the system board.
4. Adhere the mylar sticker on the system board.

### Next steps

1. Install the [base cover](#).
2. Install the [Nano-SIM card tray](#).
3. Follow the procedure in [after working inside your computer](#).

## Removing the left fan

### Prerequisites

1. Follow the procedure in [Before working inside your computer](#).
  - NOTE:** Ensure that your computer is in Service Mode. For more information, see step 6 in [Before working inside your computer](#).
2. Remove the [Nano-SIM card tray](#).
3. Remove the [base cover](#).

### About this task

The following image indicates the location of the left fan and provides a visual representation of the removal procedure.

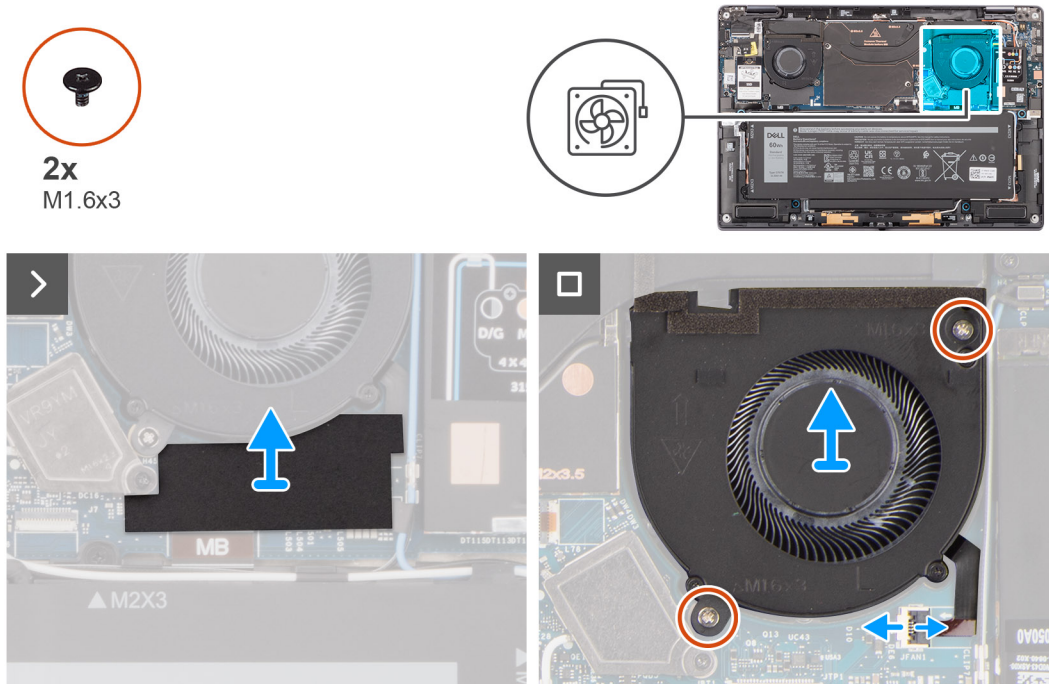

**Figure 26. Removing the left fan**

### Steps

1. Peel off the mylar sticker from the system board.
2. Disconnect the left-fan FPC cable from the connector (FANL) on the system board.
3. Remove the two (M1.6x3) screws that secure the left fan to the palm-rest assembly.
4. Lift the left fan off the palm-rest assembly.

## Installing the left fan

### Prerequisites

If you are replacing a component, remove the existing component before performing the installation procedure.

### About this task

The following image indicates the location of the left fan and provides a visual representation of the installation procedure.



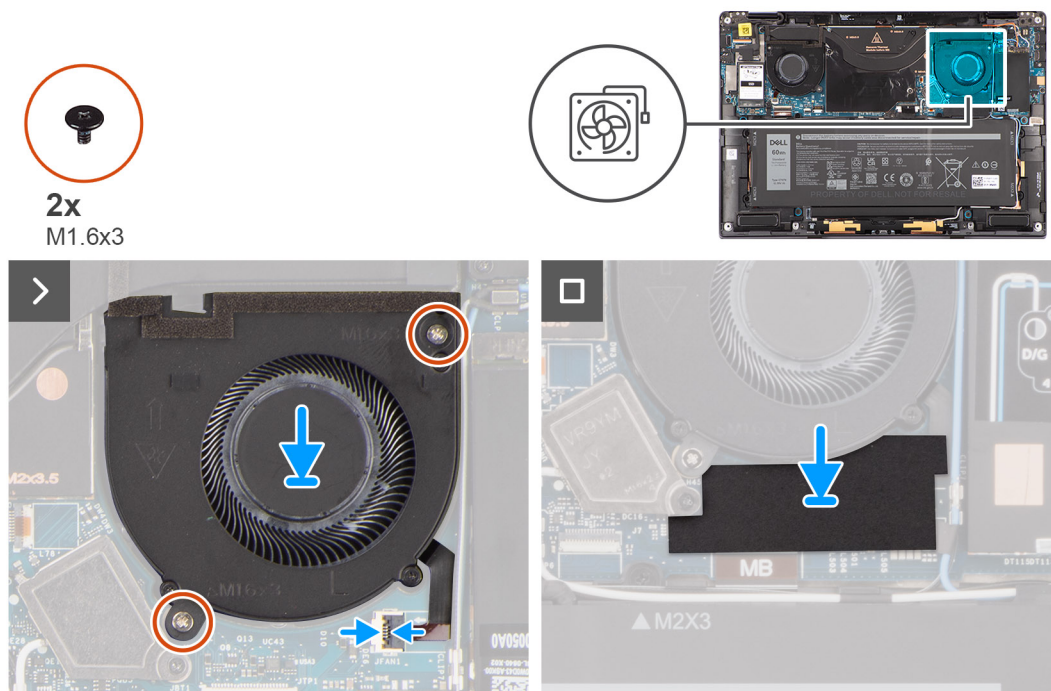

**Figure 27. Installing the left fan**

#### Steps

1. Align and place the left fan onto the palm-rest assembly.
2. Replace the two (M1.6x3) screws to secure the left fan to the palm-rest assembly.
3. Connect the left-fan cable to the connector (FANL) on the system board.
4. Adhere the mylar sticker on the system board.

#### Next steps

1. Install the [base cover](#).
2. Install the [Nano-SIM card tray](#).
3. Follow the procedure in [after working inside your computer](#).

## Solid state drive

### Removing the solid state drive

#### Prerequisites

1. Follow the procedure in [before working inside your computer](#).
  - NOTE:** Ensure that your computer is in Service Mode. For more information, see step 6 in [before working inside your computer](#).
2. Remove the [Nano-SIM card tray](#).
3. Remove the [base cover](#).

#### About this task

The following images indicate the location of the solid state drive and provide a visual representation of the removal procedure.

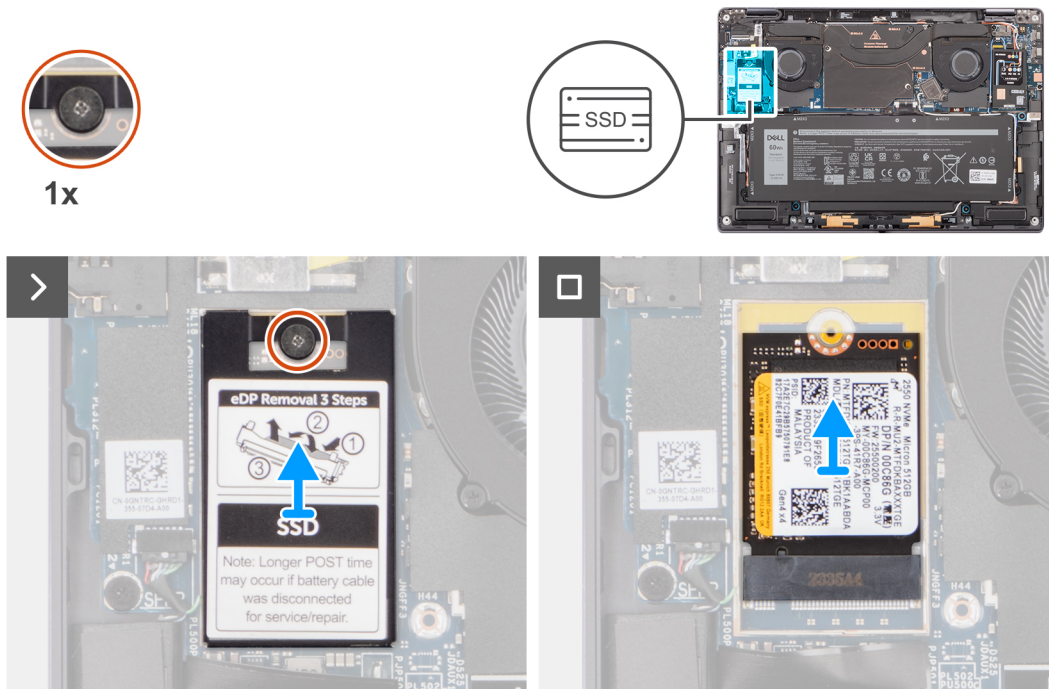

**Figure 28. Removing the solid state drive**

**Steps**

1. Loosen the captive screw that secures the solid state drive shielding cover to the system board.
2. Pry open the M.2 SSD shielding cover from the recesses that are at its left or right sides. Lift the solid state drive off the slot.



**Figure 29. M.2 SSD shielding cover**

# Installing the solid state drive

## Prerequisites

If you are replacing a component, remove the existing component before performing the installation procedure.

## About this task

The following image indicates the location of the solid state drive and provides a visual representation of the installation procedure.

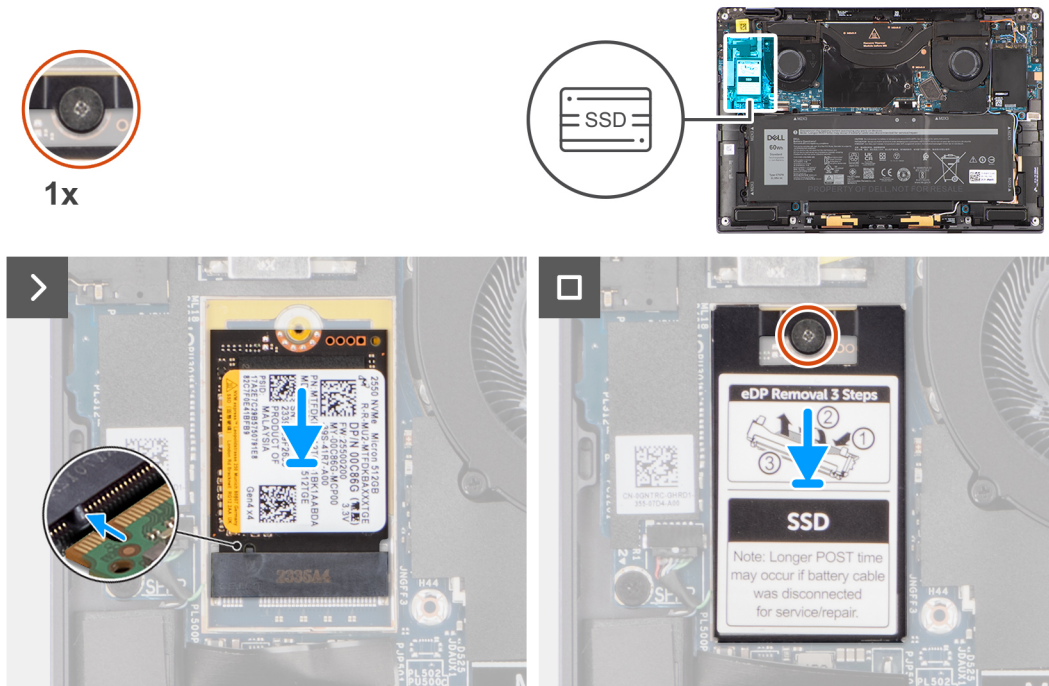

Figure 30. Installing the solid state drive

## Steps

1. Align the notch on the solid state drive with the tab on the solid state drive slot.
2. Slide the solid state drive at an angle into the solid state drive slot on the system board.
3. Align and place the solid state drive shielding cover, press to fit it firmly in place to cover the solid state drive.
4. Tighten the captive screw to secure the solid state drive to the system board.

## Next steps

- 1.
2. Install the [base cover](#).
3. Install the [Nano-SIM card tray](#).
4. Follow the procedure in [after working inside your computer](#).

# Wireless Wide Area Network (WWAN) card

## Removing the WWAN card

### Prerequisites

1. Follow the procedure in [before working inside your computer](#).

**CAUTION:** Ensure that your computer is in Service Mode. For more information, see step 6 in [before working inside your computer](#).

2. Remove the Nano-SIM card tray.
3. Remove the base cover.

**About this task**

The following images indicate the location of the WWAN card and provide a visual representation of the removal procedure.

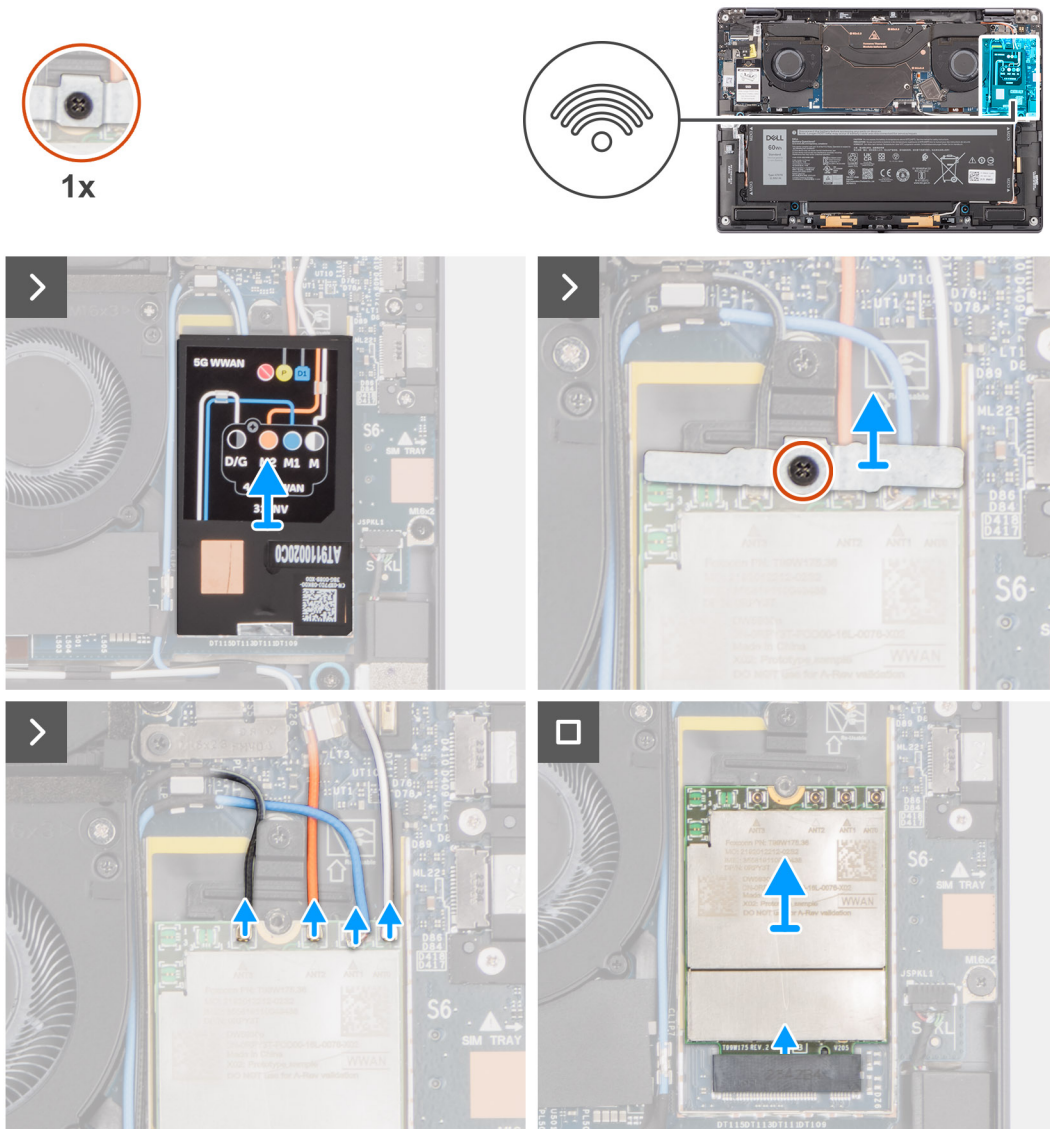

**Figure 31. Removing the WWAN card**

**Steps**

1. Using a plastic scribe, pry open the WWAN card shielding cover from the right edge of the WWAN card shielding cover.

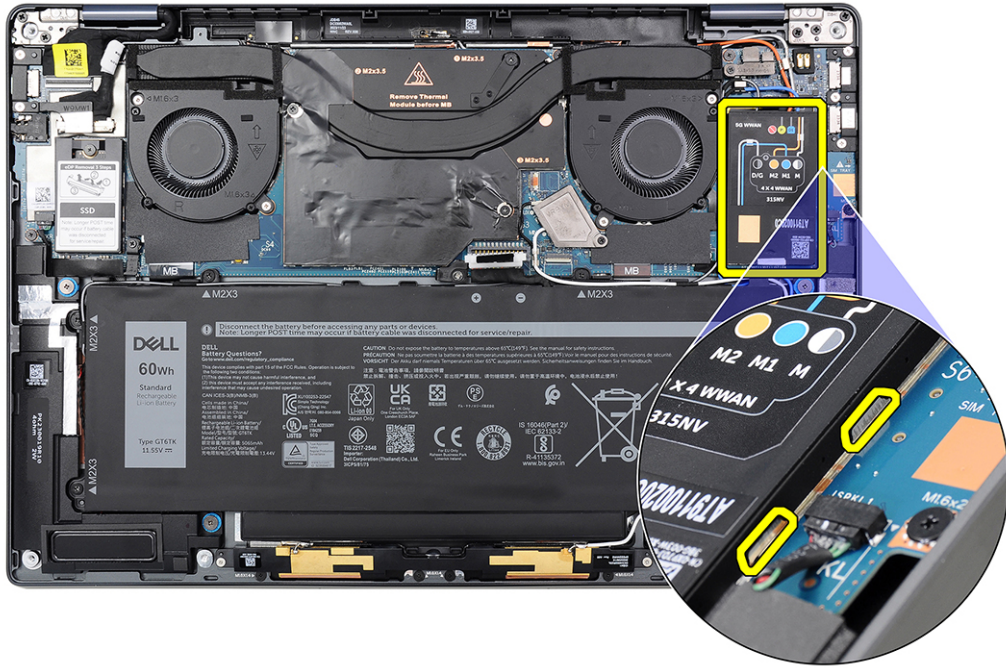

**Figure 32. WWAN card shielding cover**

**NOTE:** A thermal pad is included with the WWAN card shielding cover which must always be adhered to the cover. If the thermal pad gets separated from the cover or adheres to the WWAN card during the removal procedure, you must readhere the thermal pad to the cover before installing the cover to the system.



**Figure 33. Thermal pad**

2. Loosen the captive screw that secures the WWAN card bracket to the system board.
3. Lift the WWAN card bracket out of the system.
4. Disconnect the four antenna cables from the connectors (JNGFF2) at the top of the WWAN card.

5. Slide and remove the WWAN card from the WWAN card slot.

## Installing the WWAN card

### Prerequisites

If you are replacing a component, remove the existing component before performing the installation procedure.

### About this task

The following image indicates the location of the WWAN card and provides a visual representation of the installation procedure.

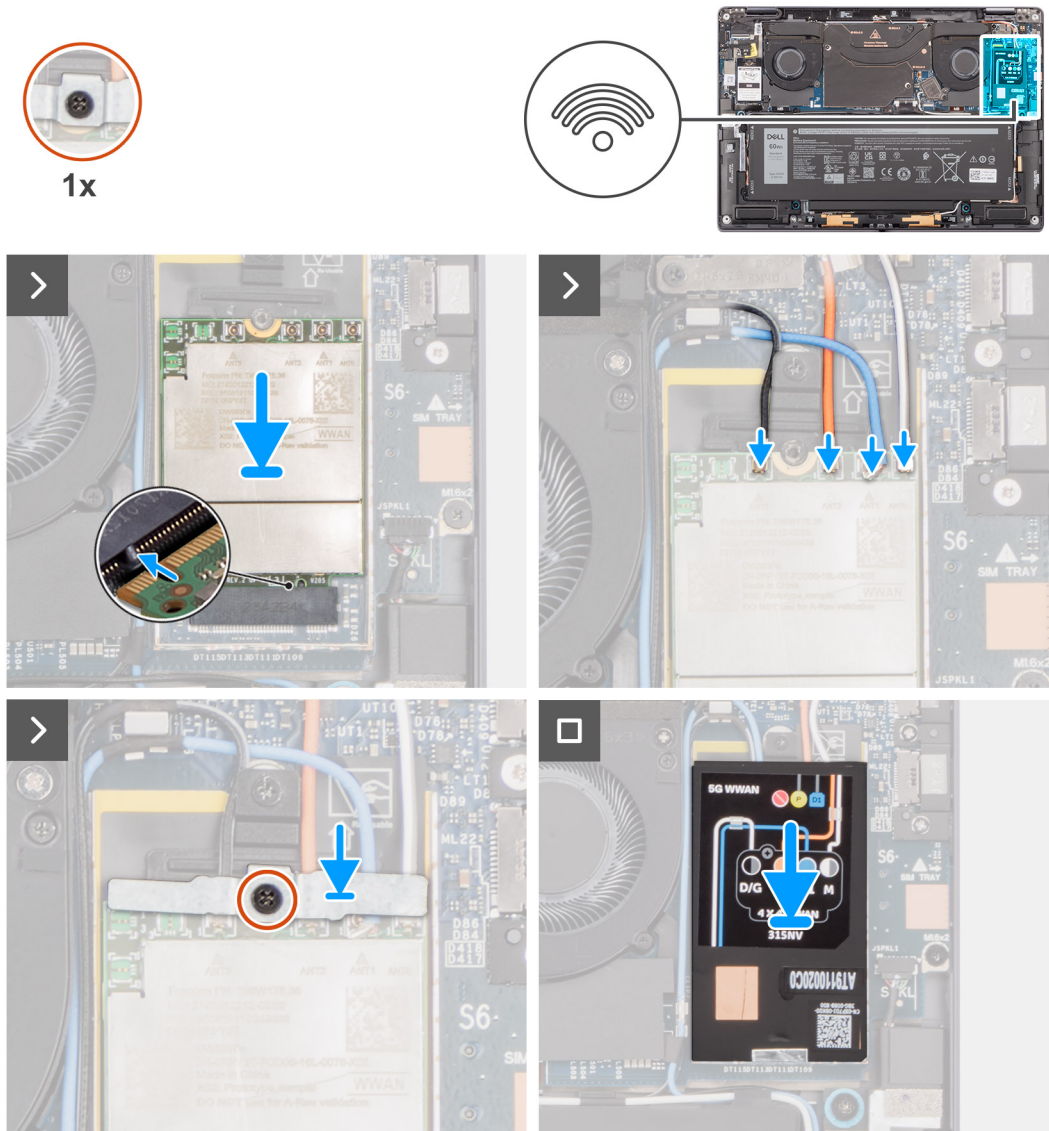

Figure 34. Installing the WWAN card

### Steps

1. Align the notch on the WWAN card with the tab on the WWAN card slot.  
**NOTE:** If any of the thermal pads that are located underneath the WWAN card are detached from the system board when removing the WWAN card from the system, adhere them back on the system board.
2. Slide the WWAN card at an angle into the WWAN card slot on the system board.
3. Connect the four antenna cables to the connectors (JNGFF2) on the WWAN card .

- Align and place the WWAN card bracket on the system board and WWAN card, and tighten the single captive screw.  
**NOTE:** For instructions on how to find your computer's IMEI (International Mobile Station Equipment Identity) number, see the knowledge base article [000143678](http://www.dell.com/support) at [www.dell.com/support](http://www.dell.com/support).
- Align and place the WWAN card shielding cover over the WWAN card.
- Press the WWAN card shielding cover to fix it firmly in place.

#### Next steps

- Install the [base cover](#).
- Install the [Nano-SIM card tray](#).
- Follow the procedure in [after working inside your computer](#).

## Wireless Local Area Network (WLAN) Antenna module

### Removing the WLAN antenna module

#### Prerequisites

- Follow the procedure in [before working inside your computer](#).  
**NOTE:** Ensure that your computer is in Service Mode. For more information, see step 6 in [before working inside your computer](#).
- Remove the [Nano-SIM card tray](#).
- Remove the [base cover](#).
- Remove the [WWAN card](#) if applicable.
- Remove the [battery](#).

#### About this task

The following image indicates the location of the WLAN antenna module and provides a visual representation of the removal procedure.

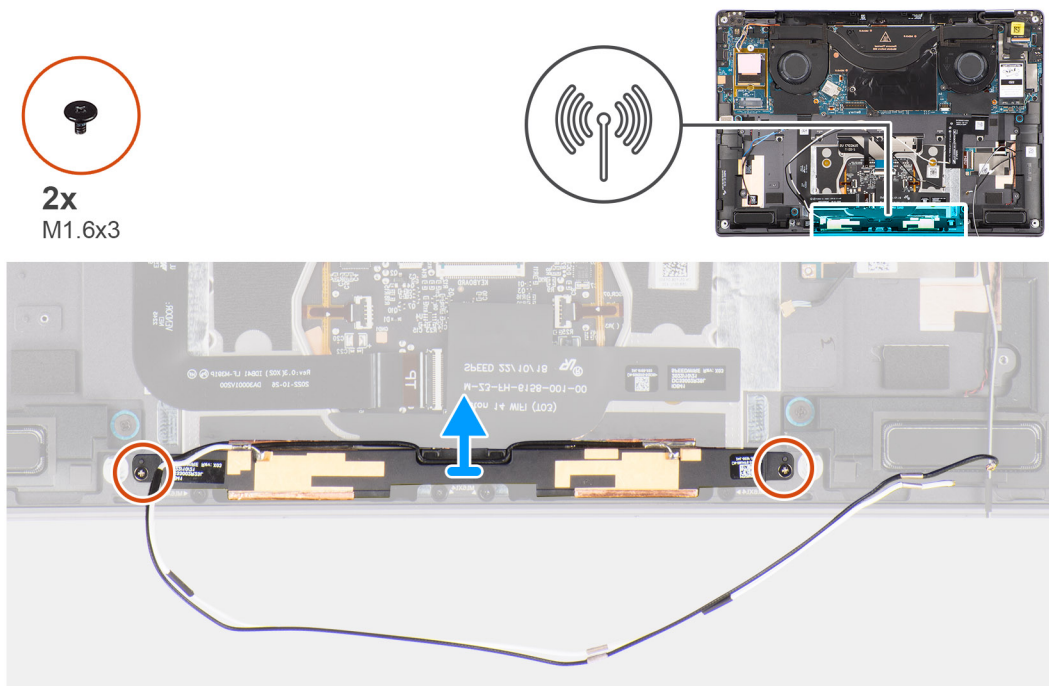

Figure 35. Removing the WLAN antenna module

## Steps

1. Peel off the piece of tape that secures the WLAN antenna module to the palm-rest assembly.
2. Remove the two (M1.6x3) screws that secure the WLAN antenna module to the palm-rest assembly.
3. Lift and remove the WLAN antenna module off the system.

## Installing the WLAN antenna module

### Prerequisites

If you are replacing a component, remove the existing component before performing the installation procedure.

### About this task

The following image indicates the location of the WLAN antenna module and provides a visual representation of the installation procedure.

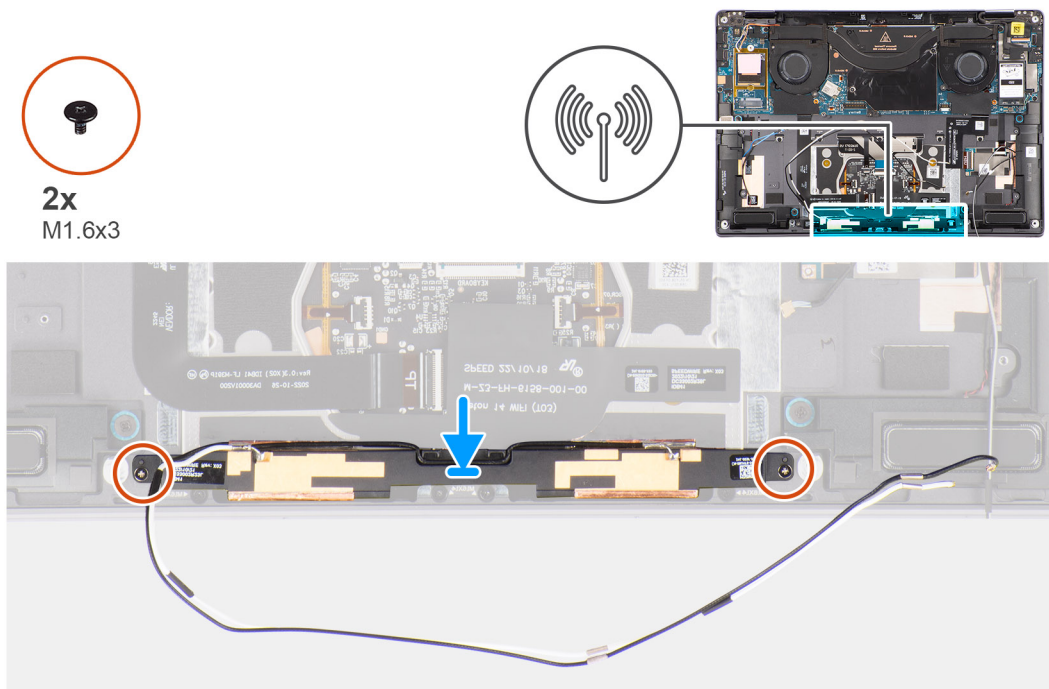

**Figure 36. Installing the WLAN antenna module**

## Steps

1. Align and place the WLAN antenna module in the slot on the system.
2. Replace the two (M1.6x3) screws to secure the WLAN antenna module to the palm-rest assembly.
3. Adhere the piece of tape that secures the WLAN antenna module to the palm-rest assembly.

## Next steps

1. Install the [battery](#).
2. Install the [WWAN card](#) if applicable.
3. Install the [base cover](#).
4. Install the [Nano-SIM card tray](#).
5. Follow the procedure in [after working inside your computer](#).



# Removing and installing Field Replaceable Units (FRUs)

The replaceable components in this chapter are Field Replaceable Units (FRUs).

**CAUTION:** The information in this section is intended for authorized service technicians only.

**CAUTION:** To avoid any potential damage to the component or loss of data, ensure that an authorized service technician replaces the Field Replaceable Units (FRUs).

**CAUTION:** Dell Technologies recommends that this set of repairs, if needed, to be conducted by trained technical repair specialists.

**CAUTION:** As a reminder, your warranty does not cover damages that may occur during FRU repairs that are not authorized by Dell Technologies.

**NOTE:** The images in this document may differ from your computer depending on the configuration you ordered.

## Battery

### Rechargeable Li-ion battery precautions

**CAUTION:**

- Exercise caution when handling rechargeable Li-ion batteries.
- Discharge the battery completely before removing it. Disconnect the AC power adapter from the computer and operate the computer solely on battery power—the battery is fully discharged when the computer no longer turns on when the power button is pressed.
- Do not crush, drop, mutilate, or penetrate the battery with foreign objects.
- Do not expose the battery to high temperatures, or disassemble battery packs and cells.
- Do not apply pressure to the surface of the battery.
- Do not bend the battery.
- Do not use tools of any kind to pry on or against the battery.
- Ensure any screws during the servicing of this product are not lost or misplaced, to prevent accidental puncture or damage to the battery and other computer components.
- If the battery gets stuck inside your computer as a result of swelling, do not try to release it as puncturing, bending, or crushing a rechargeable Li-ion battery can be dangerous. In such an instance, contact Dell technical support for assistance. See [www.dell.com/contactdell](http://www.dell.com/contactdell).
- Always purchase genuine batteries from [www.dell.com](http://www.dell.com) or authorized Dell partners and resellers.
- Swollen batteries should not be used and should be replaced and disposed properly. For guidelines on how to handle and replace swollen rechargeable Li-ion batteries, see [Handling swollen rechargeable Li-ion batteries](#).

### Removing the battery

**CAUTION:** The information in this removal section is intended for authorized service technicians only.

## Prerequisites

1. Follow the procedure in [before working inside your computer](#).

**NOTE:** Ensure that your computer is in Service Mode. For more information, see step 6 in [before working inside your computer](#).

2. Remove the [Nano-SIM card tray](#).
3. Remove the [base cover](#).
4. Remove the [WWAN card](#).

**NOTE:** If the battery is disconnected from the system board for servicing, the computer date and time (RTC) will be reset. As a result, when the computer is turned on, you are prompted to set the date and time.

## About this task

The following images indicate the location of the battery and provide a visual representation of the removal procedure.

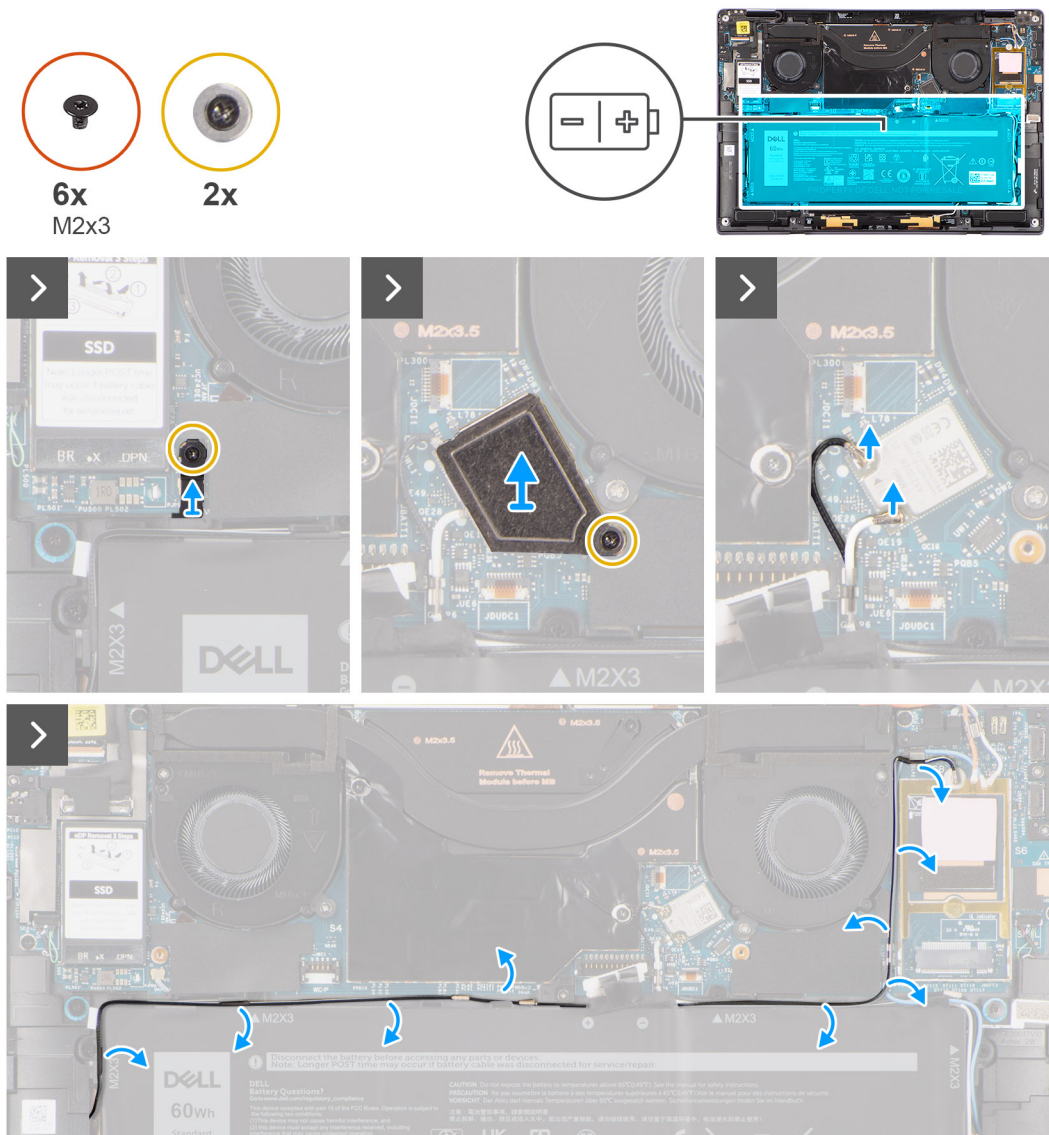

Figure 37. Removing the battery

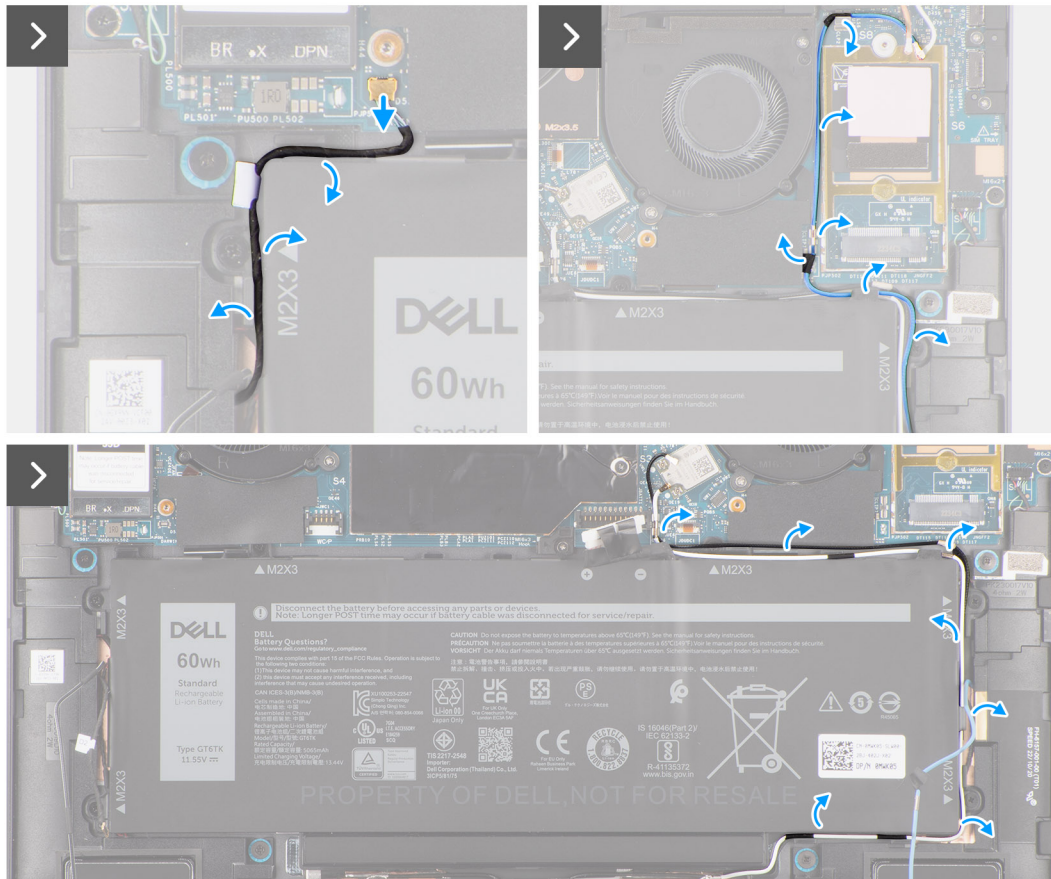

Figure 38. Removing the battery

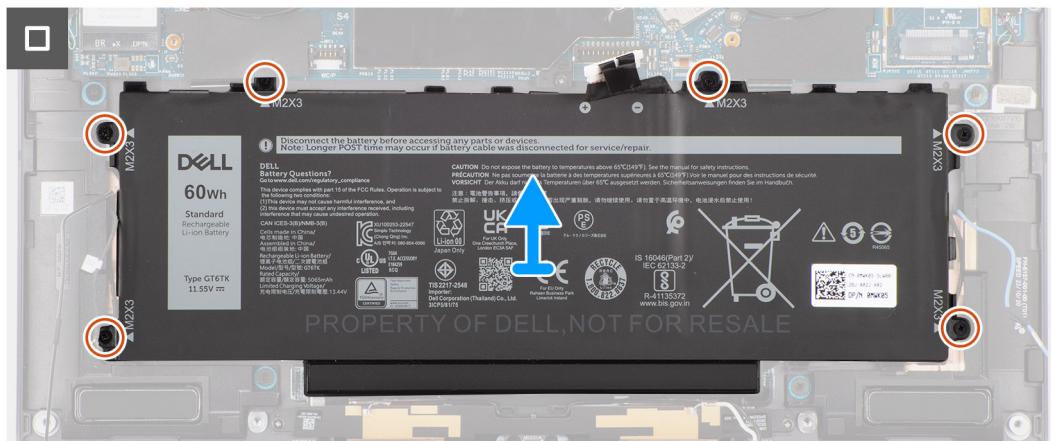

Figure 39. Removing the battery

### Steps

1. Remove the screw that secures the Darwin antenna cable (D2) bracket.
2. Lift the Darwin antenna cable (D2) bracket off the system board.
3. Loosen the captive screw that secures the WLAN bracket to the system board.
4. Lift the WLAN bracket off the system board.
5. Disconnect the black and white antenna cables that are connected to the WLAN module.
6. Unroute the black/grey D/G WWAN antenna cable from the routine guides along the sides of the battery.

**NOTE:** The cables for the WLAN antennas are routed over the plastic bracket at the upper-right corner and within the routing guides along the bottom-right side of the battery. You must be careful when unrouting the antenna cables from their routing guides while they are still attached to the WLAN card.

7. Remove the Darwin cable (D2) and unrout it from the routing guides along the top side of the battery.
8. Unroute the black and white WWAN antenna cables from the routing guides along the side of the battery.
9. Unroute the M1 blue WWAN antenna cable from the routing guides along the left side of the WWAN card and the upper-right corner of the battery.
10. Remove the six (M2x3) screws that secure the battery to the palm-rest and keyboard assembly.
11. Lift the battery away from the computer.

## Installing the battery

**CAUTION:** The information in this installation section is intended for authorized service technicians only.

### Prerequisites

If you are replacing a component, remove the existing component before performing the installation procedure.

### About this task

The following images indicate the location of the battery and provide a visual representation of the installation procedure.

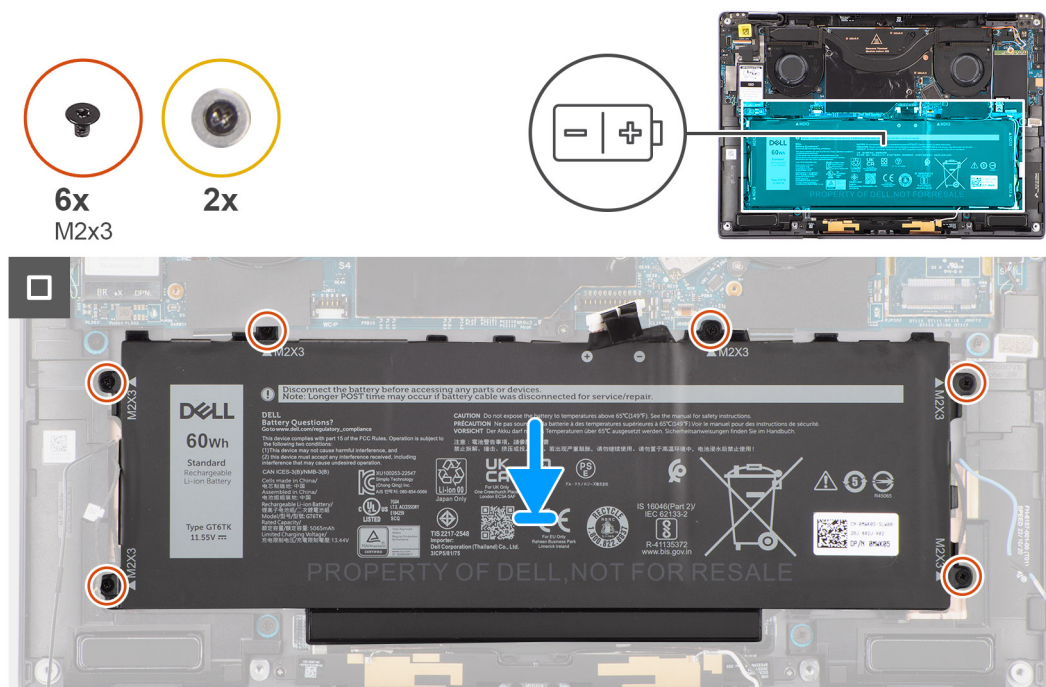
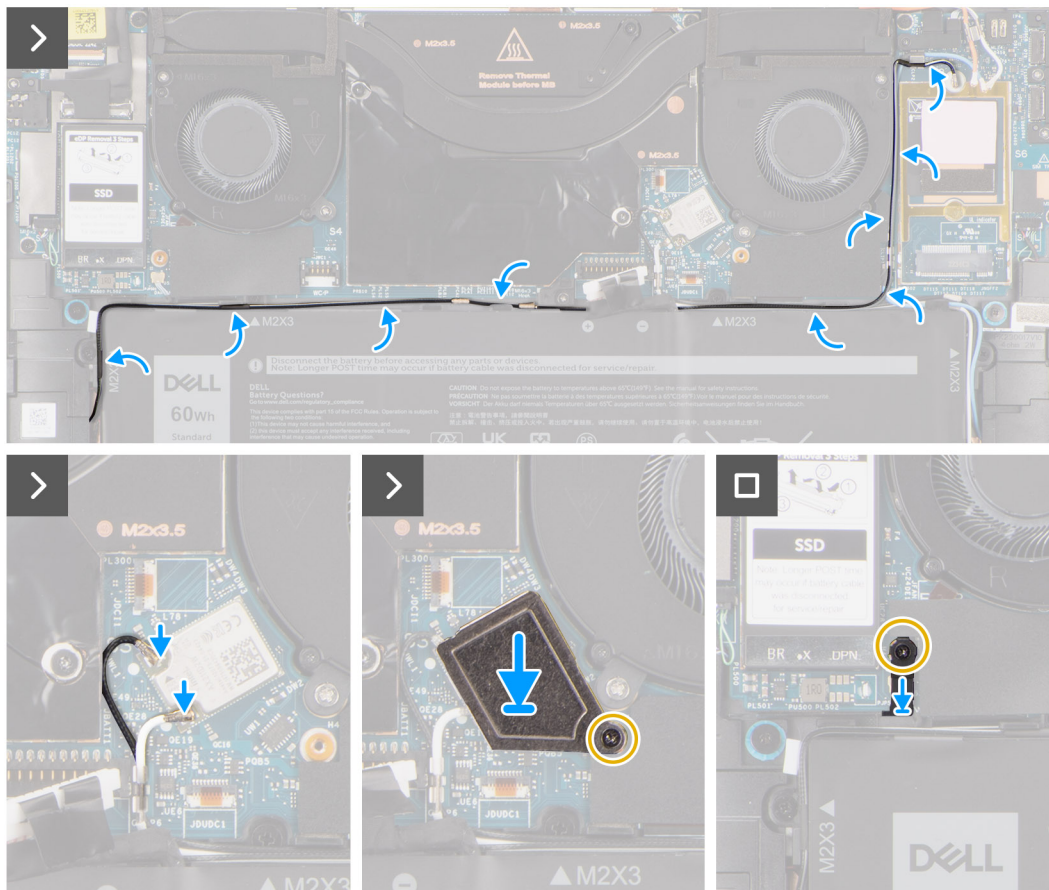

Figure 40. Installing the battery



Figure 41. Installing the battery



**Figure 42. Installing the battery**

**Steps**

1. Align and place the battery on the palm-rest assembly.
2. Replace the six (M2x3) screw to secure the battery to the palm-rest assembly.
3. Route the M1 blue WWAN antenna cable from the routing guides along the left side of the WWAN card and the upper-right corner of the battery.
4. Connect the battery cable to the connector (Battery) on the system board.
5. Route the speaker cables in the routing guides at the left and right side of the battery.
6. Adhere the piece of the tape securing the speaker cable in place at the left side of the battery.
7. Route the speaker cable in the routing guides along the top side of the battery and connect the speaker cable to the connector (SPKL and SPKR) on the system board.
8. Route the WLAN antenna cables and blue WWAN antenna cable in the metal clips on the system board and the routing guides along the sides of the battery.
9. Connect the antenna cables to the WLAN module.
10. Align and place the WLAN bracket on the system board.
11. Tighten the captive screws securing the WLAN bracket to the system board.
12. Adhere the piece of tape securing the WLAN antenna cables in place at the top side of the battery.
13. Adhere the two pieces of tape securing the gray WWAN antenna cable in place at the bottom of the CPU shielding cover and route the wireless antenna cables in the routing guides on the system board and the routing guides along the top side of the battery.

**NOTE:** If the battery was disconnected from system board for service, there will be a delay during computer boot as the computer undergoes RTC battery reset.

**Next steps**

- 1.

2. Install the [WWAN card](#).
3. Install the [base cover](#).
4. Install the [Nano-SIM card tray](#).
5. Follow the procedure in [after working inside your computer](#).

## Heat sink

### Removing the heat sink

**CAUTION:** The information in this removal section is intended for authorized service technicians only.

#### Prerequisites

1. Follow the procedure in [before working inside your computer](#).
  - NOTE:** Ensure that your computer is in Service Mode. For more information, see step 6 in [before working inside your computer](#).
2. Remove the [Nano-SIM card tray](#).
3. Remove the [base cover](#).

#### About this task

The following image indicates the location of the heat sink and provides a visual representation of the removal procedure.

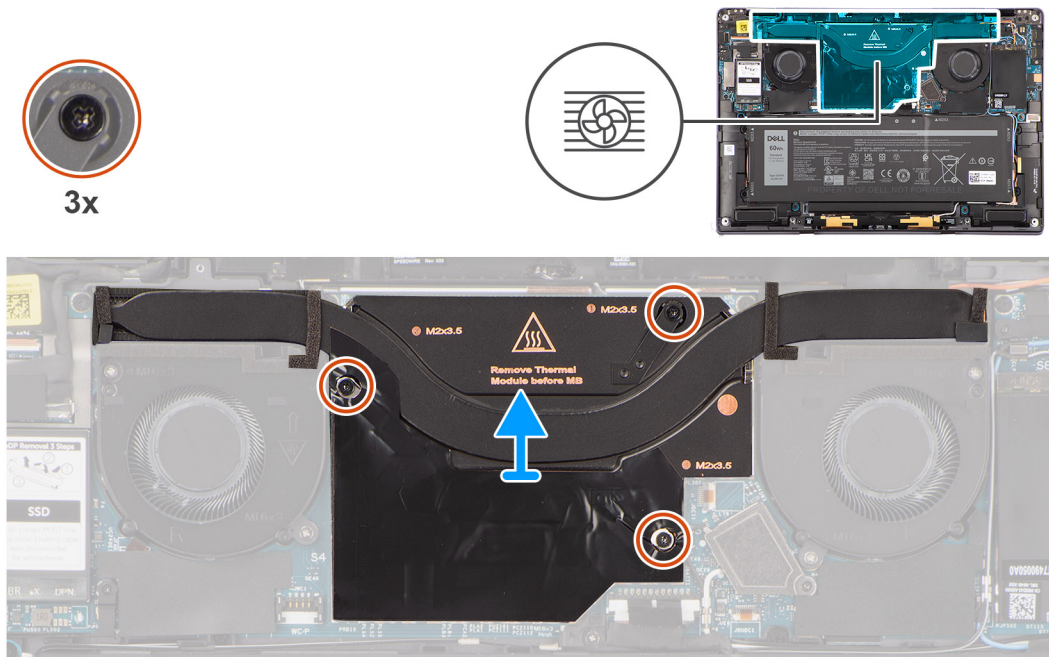

**Figure 43. Removing the heat sink**

**NOTE:** To remove the heat sink shielding cover, pry it open from the recess at its upper right corner.

#### Steps

1. Loosen the three captive screws that secure the heat sink to the system board.
2. Lift the heat sink off the system board.

## Installing the heat sink

**CAUTION:** The information in this installation section is intended for authorized service technicians only.

### Prerequisites

If you are replacing a component, remove the existing component before performing the installation procedure.

### About this task

The following image indicates the location of the heat sink and provides a visual representation of the installation procedure.

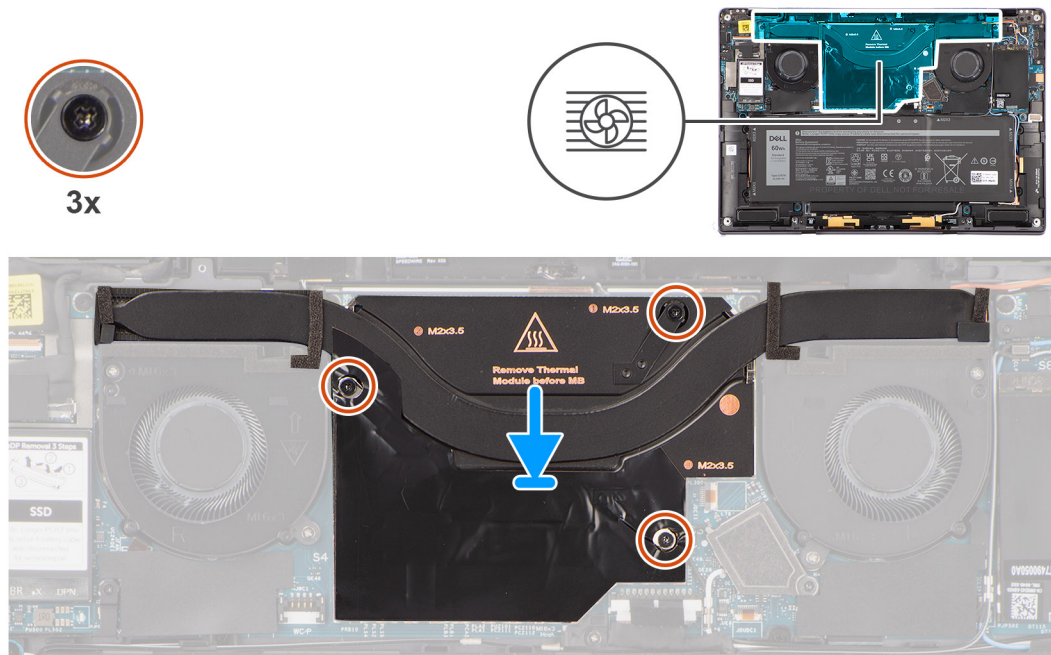

Figure 44. Installing the heat sink

### Steps

1. Align the screw holes on the heat sink with the screw holes on the system board.
2. Tighten the three captive screws that secure the heat sink to the system board.

### Next steps

1. Install the [base cover](#).
2. Install the [Nano-SIM card slot](#).
3. Follow the procedure in [after working inside your computer](#).

## Display assembly

### Removing the display assembly

**CAUTION:** The information in this removal section is intended for authorized service technicians only.

### Prerequisites

1. Follow the procedure in [before working inside your computer](#).



**NOTE:** Ensure that your computer is in Service Mode. For more information see, step 6 in [before working inside your computer](#).

2. Remove the [Nano-SIM card tray](#).
3. Remove the [base cover](#).

**About this task**

The following images indicate the location of the display assembly and provide a visual representation of the removal procedure.

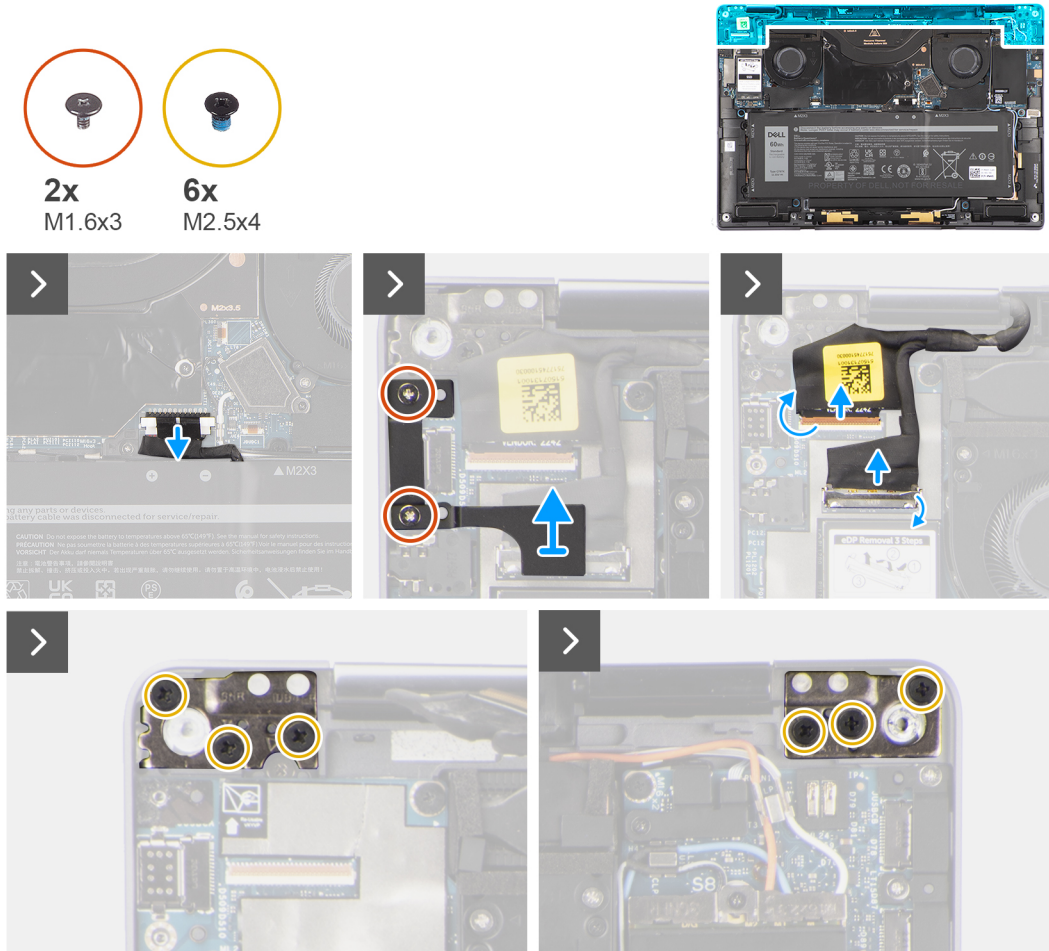

**Figure 45. Removing the display assembly**

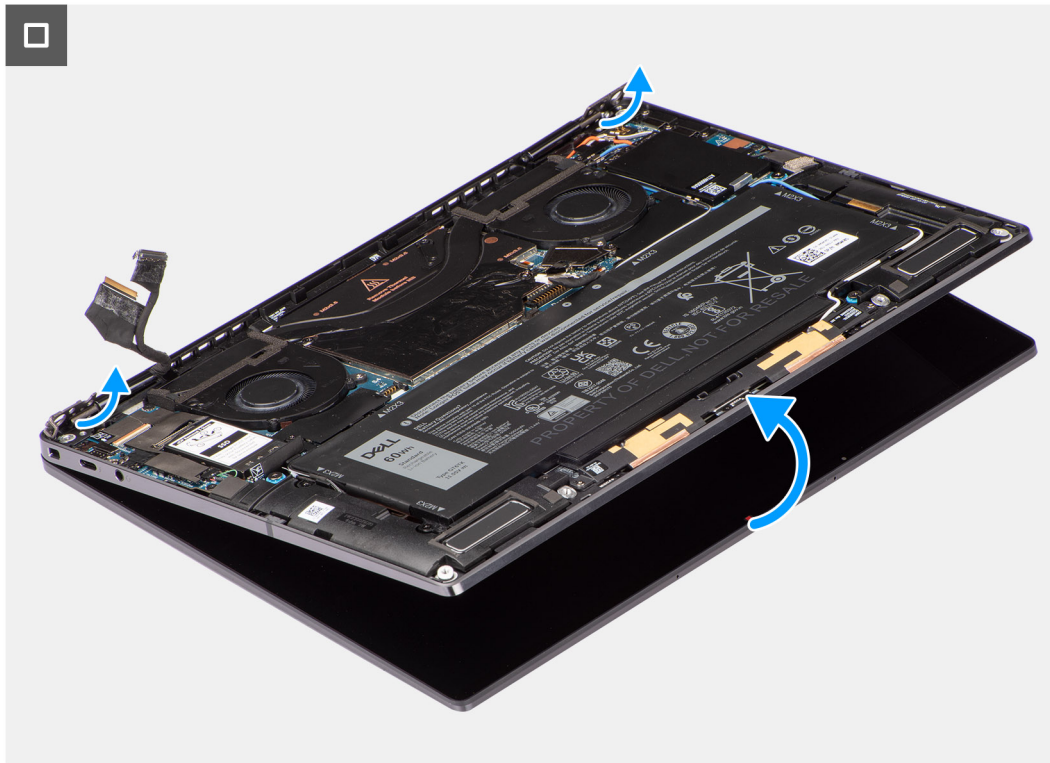

**Figure 46. Removing the display assembly**

#### Steps

1. Disconnect the battery cable from the battery cable connector on the system board.
2. Remove the two (M1.6x3) screws that secure the display cable/Type-C bracket in place.
3. Lift the display cable/Type-C bracket off the system board.
4. Disconnect the camera cable and display cable from the connector (CAMERA) on the system board.
  - i NOTE:** The connector for the display cable uses a latch that locks it in place on the system board which technicians must flip open to disconnect the display cable from the system board. After flipping open the latch, technicians must grasp the left and right sides of the cable's connector head and disconnect the display cable from the system board in a direct upward motion to prevent damage to the connector's pins.

**⚠ CAUTION:** Do not attempt to disconnect the display cable from the connector on the system board without flipping open the latch first.



**Figure 47. Disconnecting the display cable**

5. Open the display assembly to a 90-degree angle and lay the computer on the edge of the table so the palm-rest assembly is laying flat on the table and the display assembly is over the edge.
6. Remove the six (M2.5x4) screws that secure the display assembly to the computer.
7. Press the edges of the system near the hinges, and lift the hinges in the upward direction away from the computer.
8. Lift the display assembly off the computer.

**NOTE:** The display assembly is a Hinge-Up Design (HUD) assembly and it cannot be further disassembled once it is removed from the bottom chassis. If any components in the display assembly are malfunctioning and must be replaced, replace the entire display assembly.

## Installing the display assembly

**CAUTION:** The information in this installation section is intended for authorized service technicians only.

### Prerequisites

If you are replacing a component, remove the existing component before performing the installation procedure.

### About this task

The following images indicate the location of the display assembly and provide a visual representation of the installation procedure.

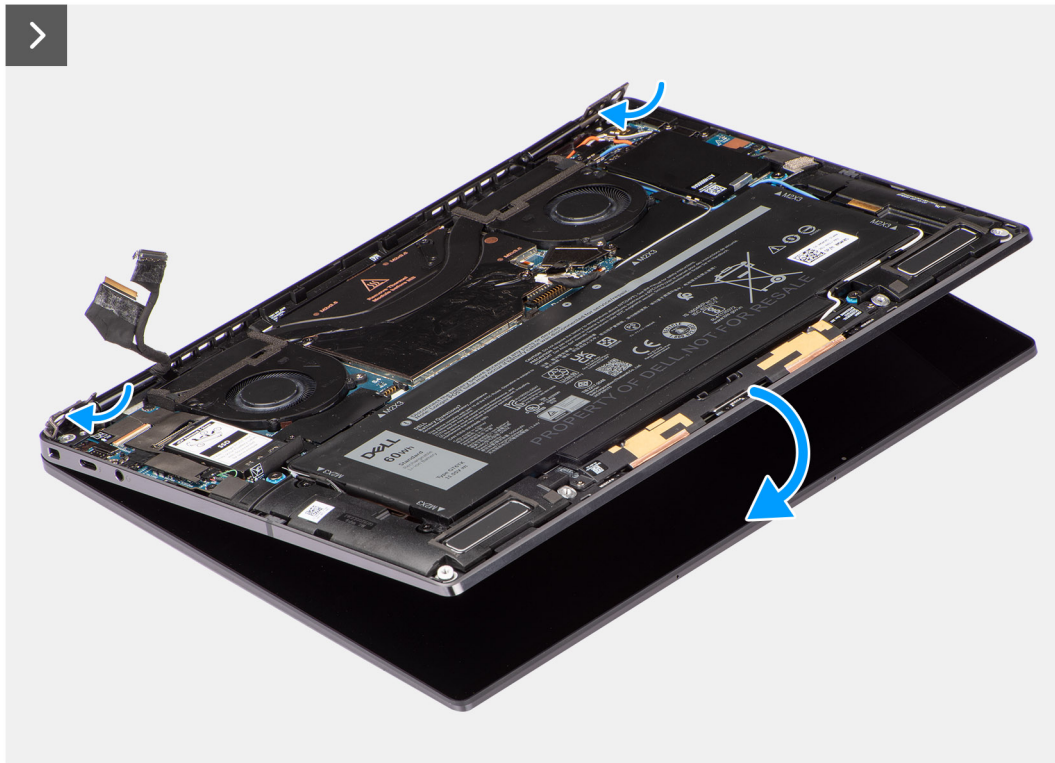
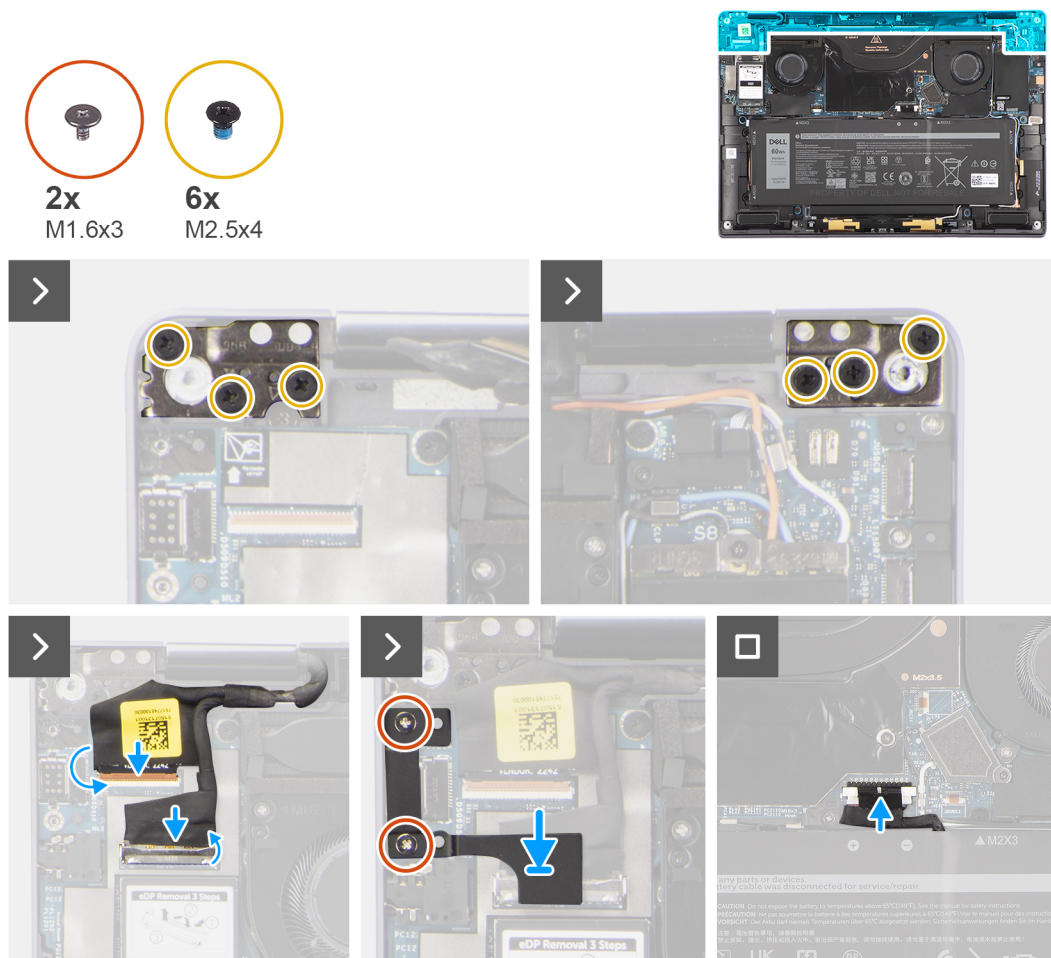

Figure 48. Installing the display assembly



**Figure 49. Installing the display assembly**

**Steps**

1. Align and place the palm-rest assembly under the hinges of the display assembly.
2. Replace the six (M2.5x4) screws to secure the display assembly to the computer.
3. Connect the display and camera cable to the connectors (CAMERA) on the system board.
4. Align and place the display cable/Type-C bracket over the screw holes on the system board.
5. Replace the two (M1.6x3) screws to secure the display cable and Type-C bracket in place.
6. Connect the battery cable to the battery cable connector on the system board.

**Next steps**

1. Install the [base cover](#).
2. Install the [Nano-SIM card tray](#).
3. Follow the procedure in [after working inside your computer](#).

## System-board

### Removing the system board

**⚠ CAUTION:** The information in this removal section is intended for authorized service technicians only.

## Prerequisites

1. Follow the procedure in [before working inside your computer](#)
  - NOTE:** Ensure that your computer is in Service Mode. For more information see, step 6 in [before working inside your computer](#).
2. Remove the [Nano-SIM card tray](#), if applicable.
3. Remove the [base cover](#).
4. Remove the [solid state drive](#).
5. Remove the [WWAN card](#), if applicable.
6. Remove the [right fan](#).
7. Remove the [left fan](#).
8. Remove the [heat sink](#).
9. Remove the [battery](#).

## About this task

**CAUTION:** The heat sink must be removed first before removing the system board, as there are two (M1.6x2) screws underneath the heat sink that secure the system board to the chassis.

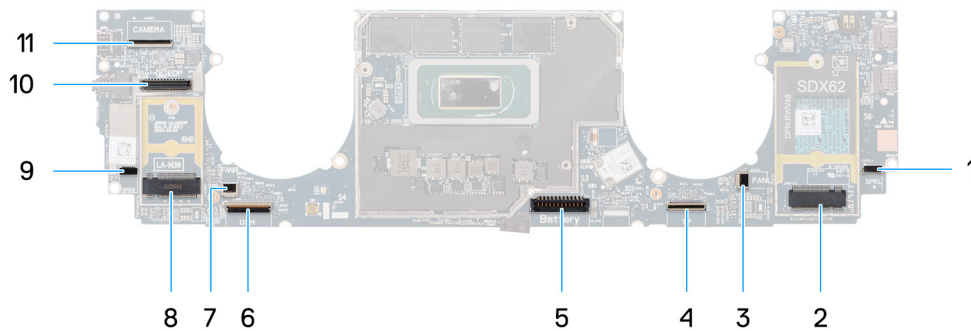

**Figure 50. System board**

1. Speaker-cable connector (SPKL)
2. WWAN-card connector (JNGFF2)
3. Fan-cable connector (FANL)
4. Touchpad-cable connector (TP)
5. Battery-cable connector (Battery)
6. U.S.B. I/O board-cable connector (USH)
7. Fan-cable connector (FANR)
8. M.2 2230 solid state drive connector (LA-M39)
9. Speaker-cable connector (SPKR)
10. Display-cable connector (EDP)
11. Camera-cable connector (CAMERA)

The following images indicate the location of the system board and provide a visual representation of the removal procedure.

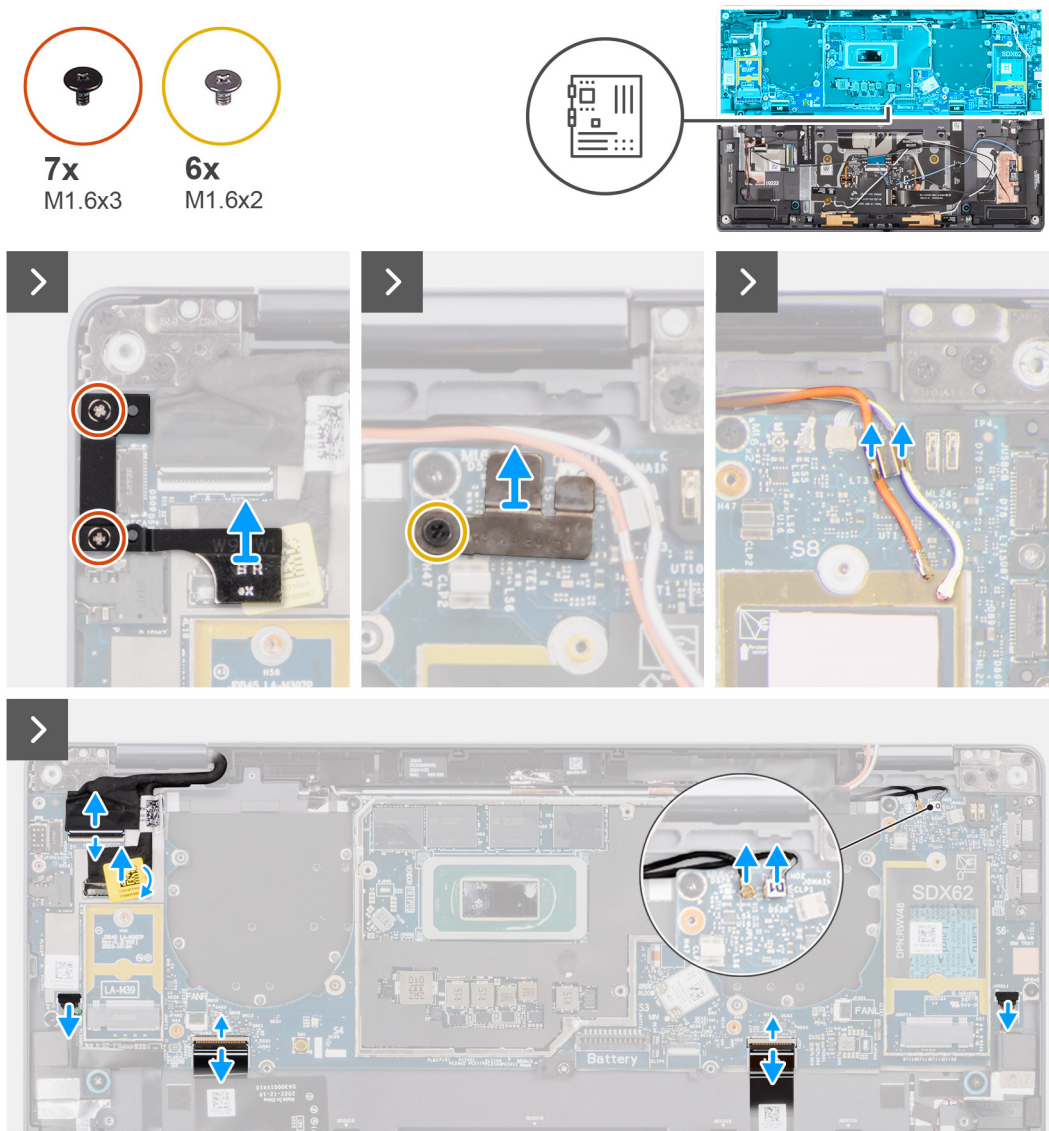

Figure 51. Removing the system board

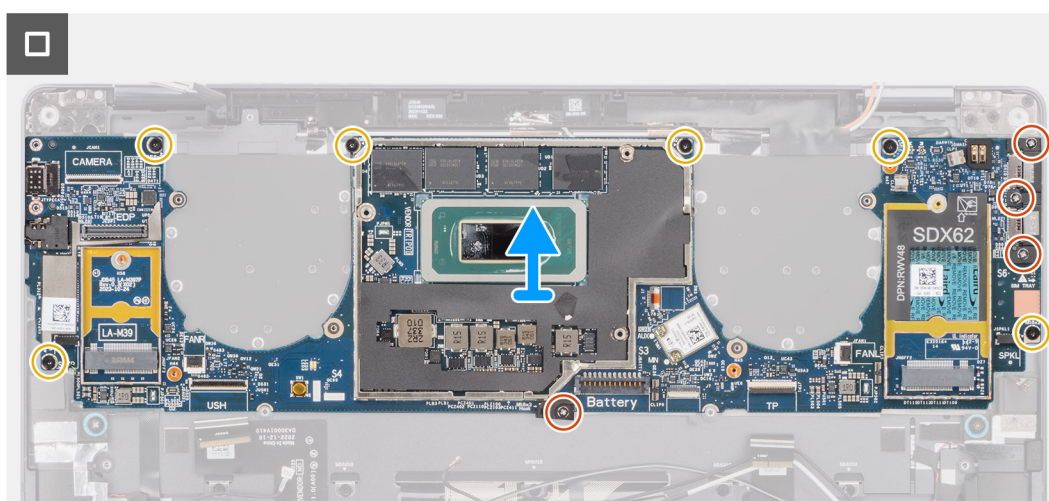

Figure 52. Removing the system board

## Steps

1. Remove the two (M1.6x3) screws that secure the display cable/Type-C bracket in place.
2. Lift the display cable/Type-C bracket off the system board.
3. For systems that shipped with the WWAN card:
  - a. Remove the single (M1.6x2) screw that secures the WWAN/Darwin-cable bracket to the system board.
  - b. Lift the WWAN/Darwin-cable bracket off the system board.
4. For systems shipped with WWAN, lift the WWAN Darwin cable bracket off the system board.
5. Disconnect the following from their connectors on the system board:
  - Display cable
  - Camera cable
  - Proximity sensor cable
  - Darwin (D1) antenna cable (for systems that shipped with the WWAN card)
  - Left-speaker cable
  - Right-speaker cable
  - Touchpad-FPC cable
  - Power-button FPC (for systems shipped without fingerprint reader) or USH I/O-board FPC cable (for systems shipped with a fingerprint reader)

**NOTE:** The connector for the display cable features a latch that locks it in place on the system board which technicians must flip open in order to disconnect the display cable from the system board. After flipping open the latch, technicians must grasp the left and right sides of the cable's connector head and disconnect the display cable from the system board in a direct upward motion to prevent damage to the connector's pins.

**CAUTION:** Do not attempt to disconnect the display cable from the system board without flipping open the latch first.



Figure 53. Display cable

6. For systems shipped with the WWAN card, unroute the white/grey (M) and orange (M2) WWAN antenna cables from their routing guides on the system board.
7. Remove the three (M1.6x3) screws that secure the USB Type-C bracket to the system board.
8. Lift the USB Type-C bracket off the system board.
9. Remove the single (M1.6x3) screw and six (M1.6x2) screws that secure the system board to the palm-rest assembly.



There are seven screws in two sizes that secure the system board in place.

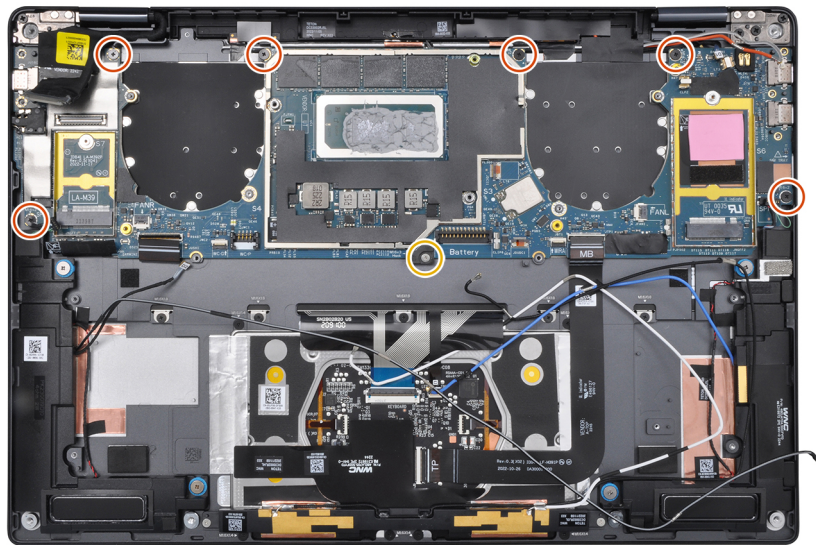

Figure 54. System board

10. Remove the system board off the chassis.

 **CAUTION:** Do not hold and bend the system board from its neck as it may damage the system board.

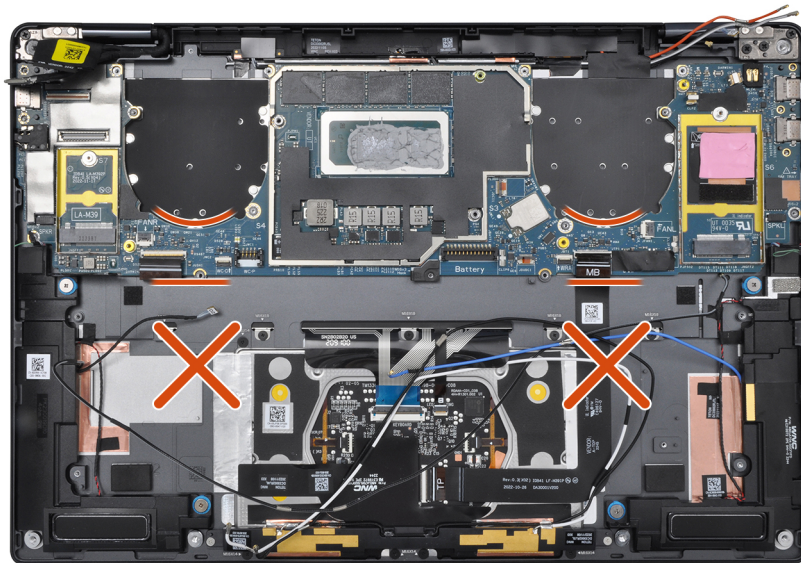



Figure 55. System board

11. Peel back the display absorber and WWAN thermal pad (for systems shipped with WWAN) from the system board.

 **NOTE:** All of the above mentioned absorbers/stickers on the system board are re-usable and must be immediately relocated to the replacement system board.

 **NOTE:** The following items MUST be transferred to the replacement system board.



**Figure 56. WWAN thermal pad**

- a. Display absorber (for computers shipped with WWAN antennas) or display mylar (for computers shipped without WWAN antennas)
- b. WWAN card thermal pad sticker (for computers shipped with WWAN antennas)

## Installing the system board

**CAUTION:** The information in this installation section is intended for authorized service technicians only.

### Prerequisites

If you are replacing a component, remove the existing component before performing the installation procedure.

### About this task

The following image indicates the location of the system board and provides a visual representation of the installation procedure.

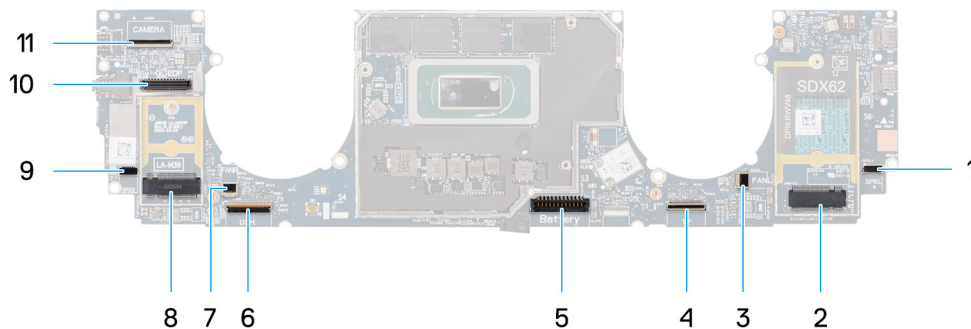

**Figure 57. Installing the system board**

1. Speaker cable connector (SPKL)
2. WWAN card connector (JNGFF2)
3. Fan cable connector (FANL)
4. Touchpad cable connector (TP)
5. Battery cable connector (Battery)
6. USH I/O board cable connector (USH)
7. Fan cable connector (FANR)
8. M.2 2230 solid state drive connector (LA-M39)
9. Speaker cable connector (SPKR)
10. Display cable connector (EDP)
11. Camera cable connector (CAMERA)

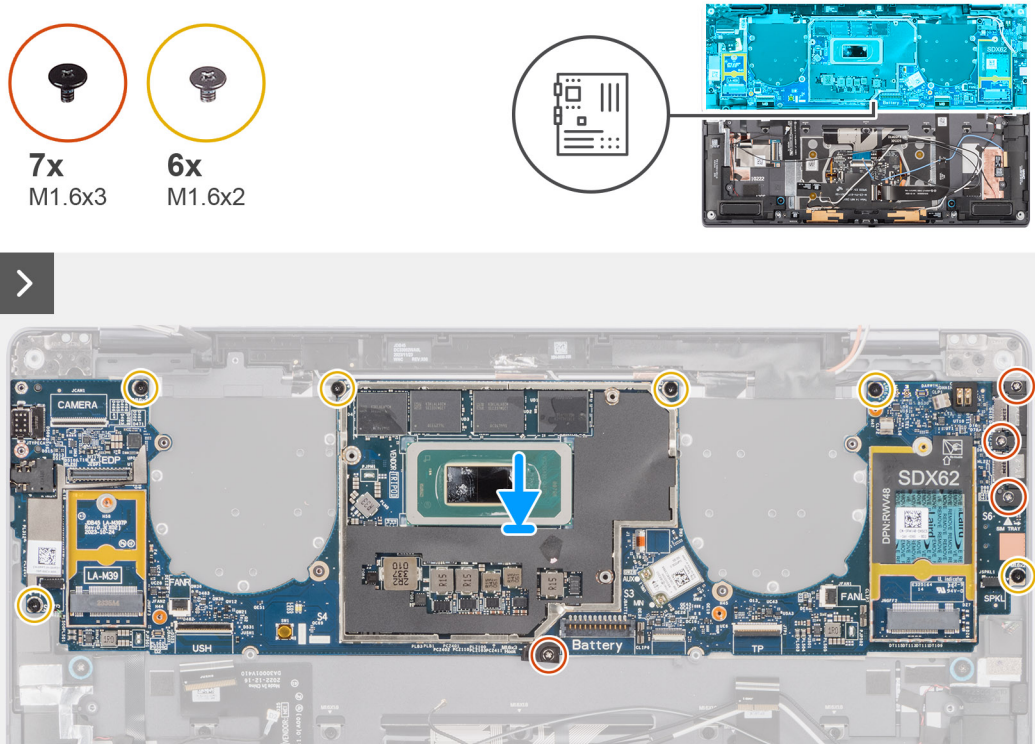
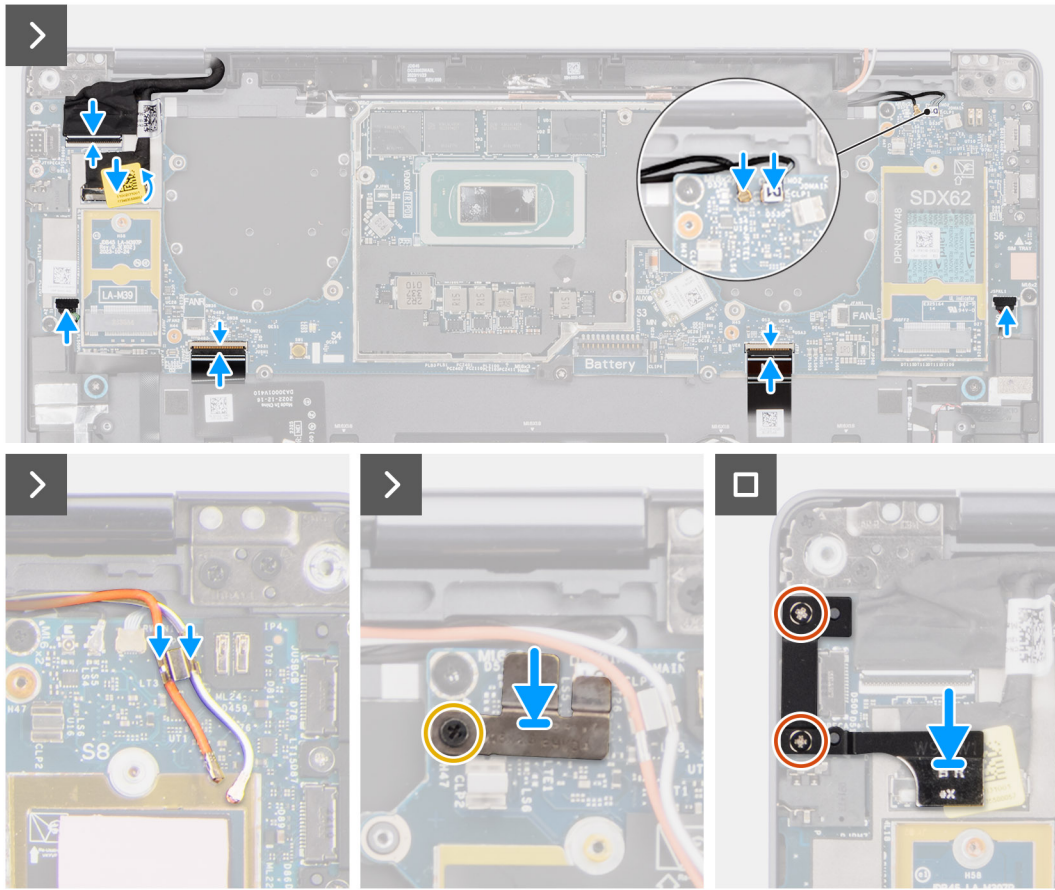

Figure 58. Installing the system board



**Figure 59. Installing the system board**

**Steps**

1. Adhere the display absorber and WWAN thermal pad (for systems shipped with WWAN) on the system board.
  - ① **NOTE:** All the above mentioned absorbers/stickers on the system board are re-usable and must be immediately relocated to the replacement system board.
  - ① **NOTE:** The following items **MUST** be transferred to the replacement system board.



**Figure 60. WWAN thermal pad**

- a. Display absorber (for models shipped with WWAN antennas) or display mylar (for models shipped without WWAN antennas)
  - b. WWAN card thermal pad sticker (for models shipped with WWAN antennas)
2. Align and place the system board on the palm-rest assembly.
  3.  **CAUTION: Do not hold and bend the system board from its necks as it may damage the system board.**

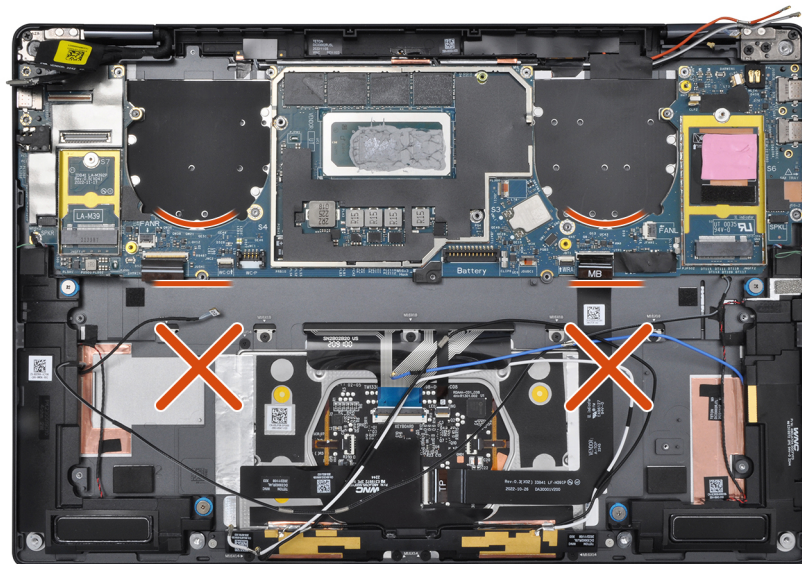

**Figure 61. System board**

Replace the single (M1.6x3) screw and six (M1.6x2) screws to secure the system board to the palm-rest assembly. There are seven screws in two sizes securing the system board in place.

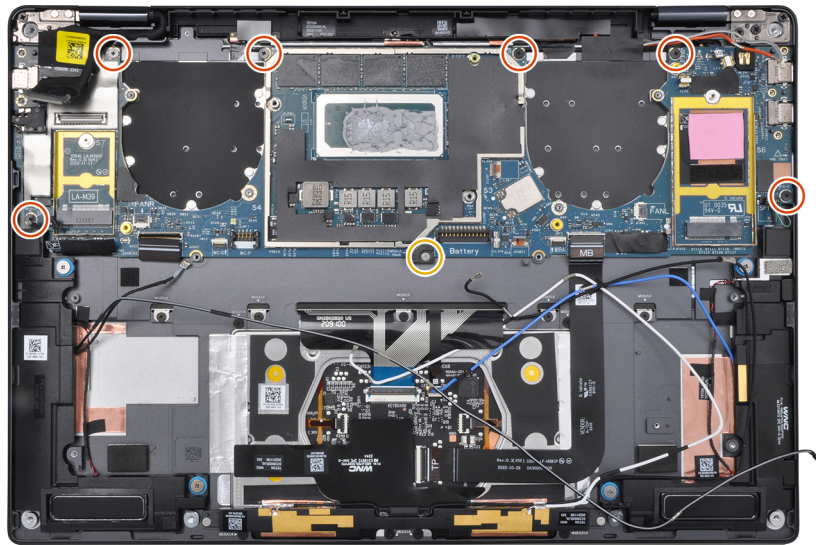

**Figure 62. System board**

4. Align and place the USB Type-C bracket on the system board.
5. Replace the three (1.6x3) screws to secure the USB Type-C bracket to the system board.
6. For systems shipped with WWAN, route the WWAN antenna cables through their routing guides on the system board.
7. Disconnect the following from their connectors on the system board:
  - Display cable
  - Camera cable
  - Proximity sensor cable
  - Darwin (D1) antenna cable (for systems that shipped with the WWAN card)
  - Left-speaker cable
  - Right-speaker cable
  - Touchpad-FPC cable
  - Power-button FPC (for systems shipped without fingerprint reader) or USH I/O-board FPC cable (for systems shipped with a fingerprint reader)

**NOTE:** The connector for the display cable features a latch that locks it in place on the system board which technicians must flip open in order to connect the display cable to the system board..

8. Align and place the WWAN Darwin cable bracket on the system board.
9. Tighten the (M1.6x2) screw to secure the WWAN Darwin cable bracket to the system board.
10. Align and place the display cable/Type-C bracket on the system board.
11. Replace the two (M1.6x3) screws to secure the display cable/Type-C bracket in place.
12. Adhere the left and right mylar stickers on the system board.

### Next steps

1. Install the [battery](#).
2. Install the [heat sink](#).
3. Install the [left fan](#).
4. Install the [right fan](#).
5. Install the [WWAN card](#) if applicable.
6. Install the [solid state drive](#).
7. Install the [base cover](#).

8. Install the Nano-SIM card tray if applicable.
9. Follow the procedure in [after working inside your computer](#).

## Power button with fingerprint-reader assembly

### Removing the power button with fingerprint-reader assembly

 **CAUTION:** The information in this removal section is intended for authorized service technicians only.

#### Prerequisites

1. Follow the procedure in [before working inside your computer](#).
  -  **NOTE:** Ensure that your computer is in Service Mode. For more information see, step 6 in [before working inside your computer](#).
2. Remove the Nano-SIM card tray.
3. Remove the base cover.
4. Remove the solid-state drive.
5. Remove the WWAN card, if applicable.
6. Remove the right fan.
7. Remove the left fan.
8. Remove the display assembly.
9. Remove the heat sink.
10. Remove the battery.
11. Remove the system board.

#### About this task

The following images indicate the location of the power-button with fingerprint-reader assembly and provide a visual representation of the removal procedure.

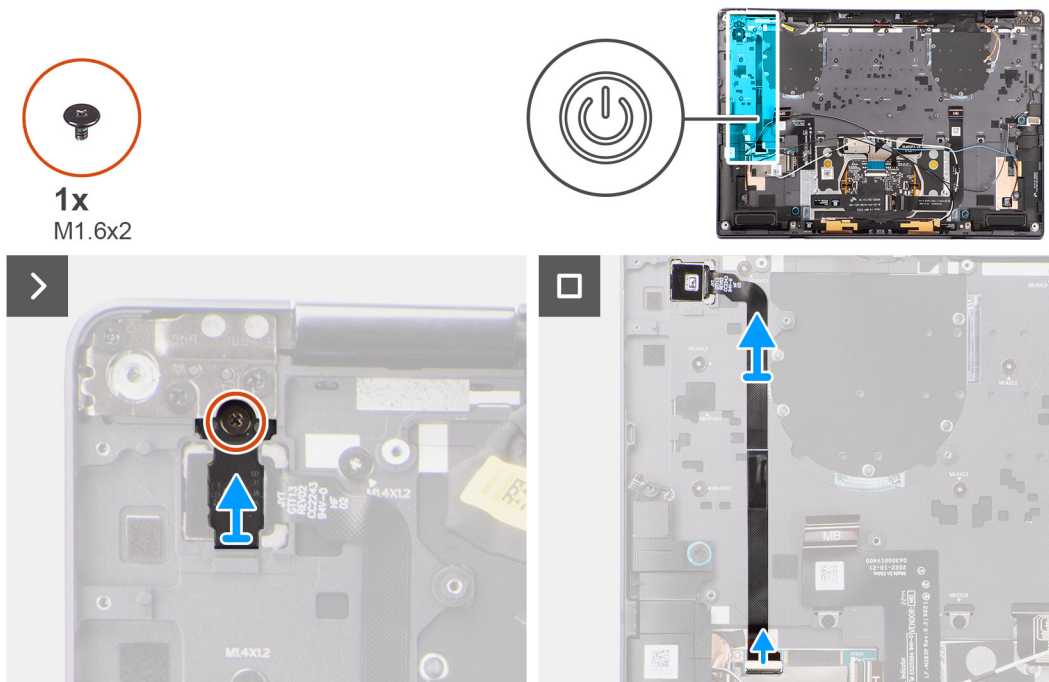

Figure 63. Removing the power button with fingerprint-reader assembly

## Steps

1. For models that are shipped with a fingerprint-reader, disconnect the power-button FPC cable from the connector (USH) on the USH I/O board. For models that are shipped without a fingerprint-reader, disconnect the power-button FPC cable from the connector on the system board.

**NOTE:** Power button with fingerprint-reader connects to the USH board and the USH-board FPC cable connects to the system board. Power button without fingerprint-reader connects directly to system board as it shares the same connector as the USH-FPC board connector on the system board.

2. Remove the single (M1.6x2) screw that secures the power-button bracket in place.
3. Lift the power-button bracket off the system.
4. Peel off the power button FPC from the palm-rest assembly and lift the power button off the system.

## Installing the power button with fingerprint reader assembly

**CAUTION:** The information in this installation section is intended for authorized service technicians only.

### Prerequisites

If you are replacing a component, remove the existing component before performing the installation procedure.

### About this task

The following image indicates the location of the power button and provides a visual representation of the installation procedure.

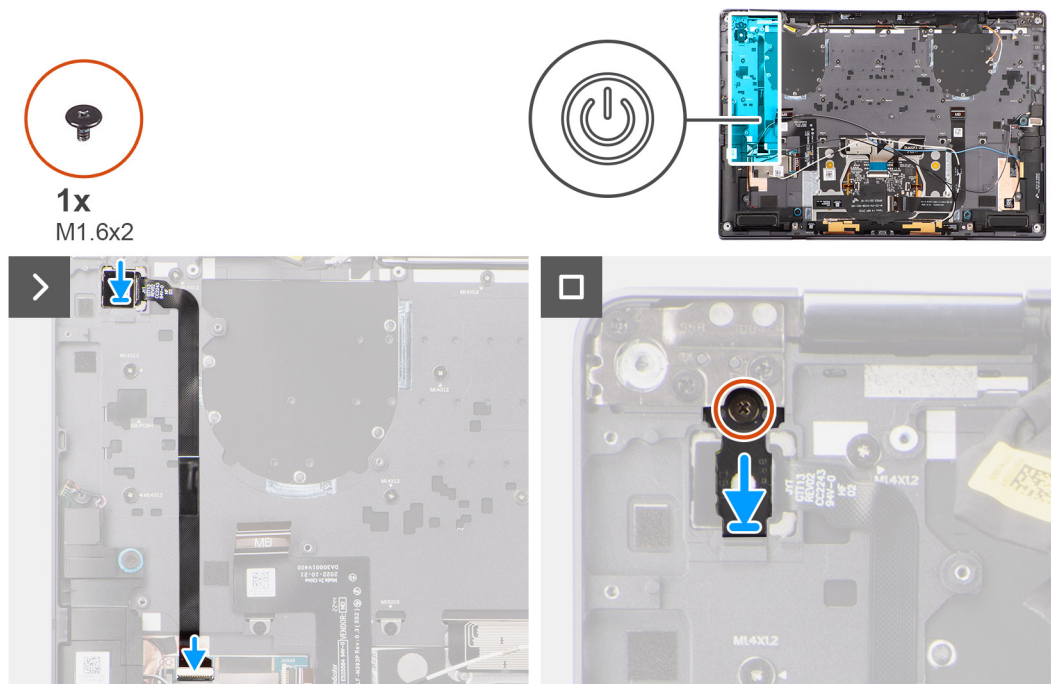

**Figure 64. Installing the power button with fingerprint-reader assembly**

## Steps

1. Align and place the power button on the computer.
2. Adhere the power-button FPC cable on the palm-rest assembly.
3. For models that are shipped with a fingerprint reader FPC, connect the power button with fingerprint-reader FPC cable to the connector on the USH daughter board. For models shipped without a fingerprint reader, connect the power-button FPC cable to the connector on the system board.



**NOTE:** The power button with fingerprint reader connects to the USH board and the USH-board FPC cable connects to the system board. The power button without fingerprint-reader FPC connects directly to system board and it uses the same connector as the USH-board FPC connector on the system board.

4. Place the power-button bracket on the power-button assembly.
5. Replace the single (M1.6x2) screw to secure the power-button bracket to the palm-rest assembly.

### Next steps

1. Install the [system board](#).
2. Install the [battery](#).
3. Install the [heat sink](#).
4. Install the [display assembly](#).
5. Install the [left fan](#).
6. Install the [right fan](#).
7. Install the [WWAN card](#), if applicable.
8. Install the [solid-state drive](#).
9. Install the [base cover](#).
10. Install the [Nano-SIM card tray](#) if applicable.
11. Follow the procedure in [after working inside your computer](#).

## Speaker

### Removing the right-speaker

**CAUTION:** The information in this removal section is intended for authorized service technicians only.

#### Prerequisites

1. Follow the procedure in [before working inside your computer](#).  
**NOTE:** Ensure that your computer is in Service Mode. For more information, see step 6 in [before working inside your computer](#).
2. Remove the [nanoSIM-card tray](#).
3. Remove the [base cover](#).
4. Remove the [WWAN card](#), if applicable.
5. Remove the [battery](#).

#### About this task

- NOTE:** For systems that are shipped with WWAN antennas, the right-speaker is integrated with the palm-rest assembly and it is not a separate replaceable part.
- NOTE:** For systems shipped with the WLAN card, the right speaker is a separate replaceable part. The following procedure is applicable only for systems that shipped with the WLAN card.

The following images indicate the location of the speaker and provide a visual representation of the removal procedure.

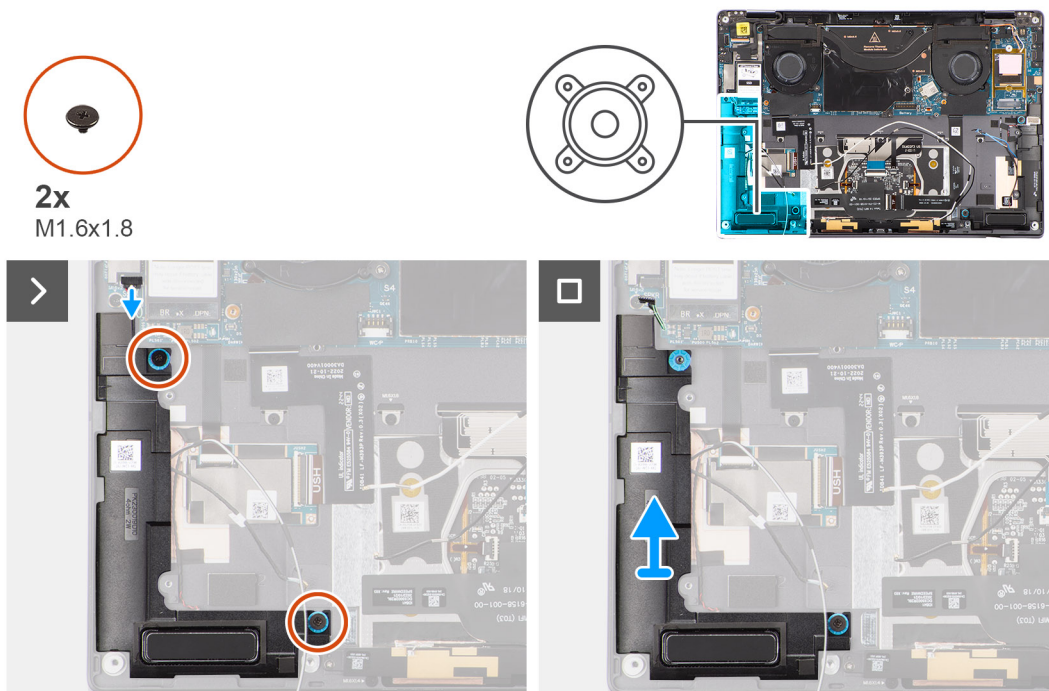

**Figure 65. Removing the right-speaker**

**Steps**

1. Peel the tape securing the right-speaker cable to the chassis.
2. Remove the two (M1.6x1.8) screws that secure the right-speaker in place.
3. Disconnect the right-speaker cable from connector (SPKL) on the system board.
4. Lift the right-speaker off the palm-rest assembly.

## Installing the right speaker

**⚠ CAUTION:** The information in this installation section is intended for authorized service technicians only.

**Prerequisites**

If you are replacing a component, remove the existing component before performing the installation procedure.

**About this task**

- i NOTE:** For systems that are shipped with WWAN antennas, the right-speaker is integrated with the palm-rest assembly and it is not a separate replaceable part.
- i NOTE:** For systems shipped with the WLAN card, the right-speaker is a separate replaceable part. The following procedure is applicable only for systems that shipped with the WLAN card.

The following image indicates the location of the speaker and provides a visual representation of the installation procedure.

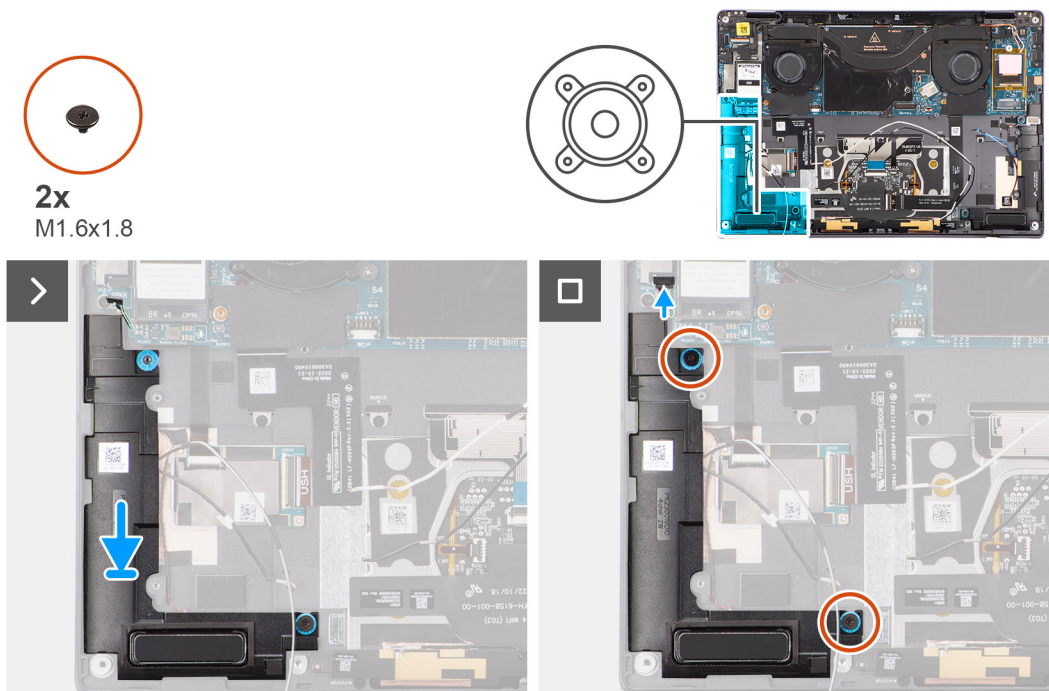
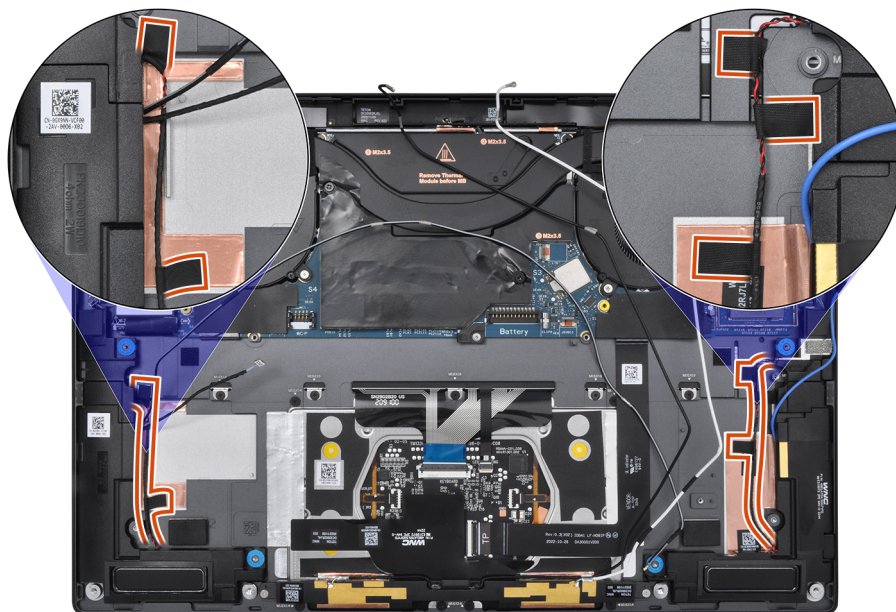

**Figure 66. Installing the right-speaker**

**Steps**

1. Align and place the right-speaker into the slot on the chassis.
2. Replace the two (M1.6x1.8) screws to secure the right-speaker to the system.
3. Connect the right-speaker cable to connector (SPKL) on the system board.
4. Adhere the tape to secure the right-speaker cable to the palm-rest assembly.

When installing the right-speaker, secure the speaker cables in place with pieces of tape adhered to the palm rest.



**Figure 67. Speaker cable tape**

### Next steps

1. Install the [battery](#).
2. Install the [WWAN card](#) if applicable.
3. Install the [base cover](#).
4. Follow the procedure in [after working inside your computer](#).

## Palm-rest and keyboard assembly

### Removing the palm-rest and keyboard assembly

 **CAUTION:** The information in this removal section is intended for authorized service technicians only.

#### Prerequisites

1. Follow the procedure in [before working inside your computer](#).

 **NOTE:** Ensure that your computer is in Service Mode. For more information, see step 6 in [before working inside your computer](#).

2. Remove the [nano-SIM card tray](#), if applicable.
3. Remove the [base cover](#).
4. Remove the [solid-state drive](#).
5. Remove the [WWAN card](#), if applicable.
6. Remove the [right fan](#).
7. Remove the [left fan](#).
8. Remove the [display assembly](#).
9. Remove the [heat sink](#).
10. Remove the [battery](#).
11. Remove the [system board](#).
12. Remove the [right-speaker](#).
13. Remove the [power button](#).

## About this task

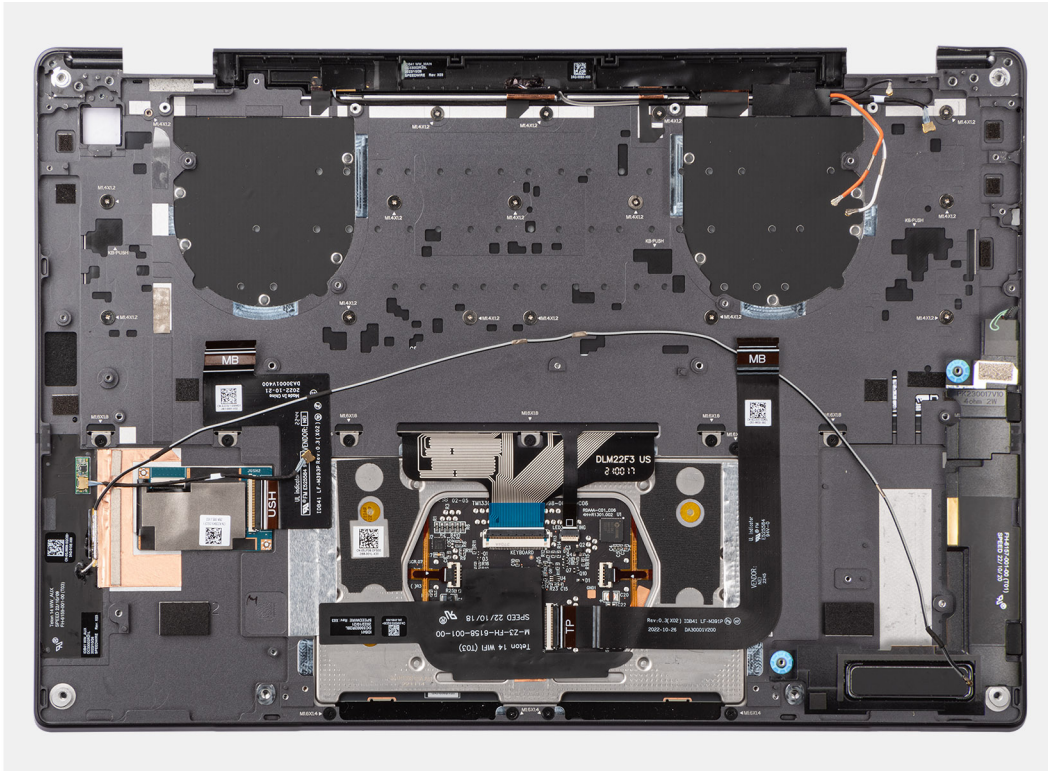

Figure 68. Palm-rest and keyboard assembly

## Installing the palm-rest and keyboard assembly

**CAUTION:** The information in this installation section is intended for authorized service technicians only.

### Prerequisites

If you are replacing a component, remove the existing component before performing the installation procedure.

### About this task

The following images indicate the location of the palm-rest and keyboard assembly and provide a visual representation of the removal procedure.

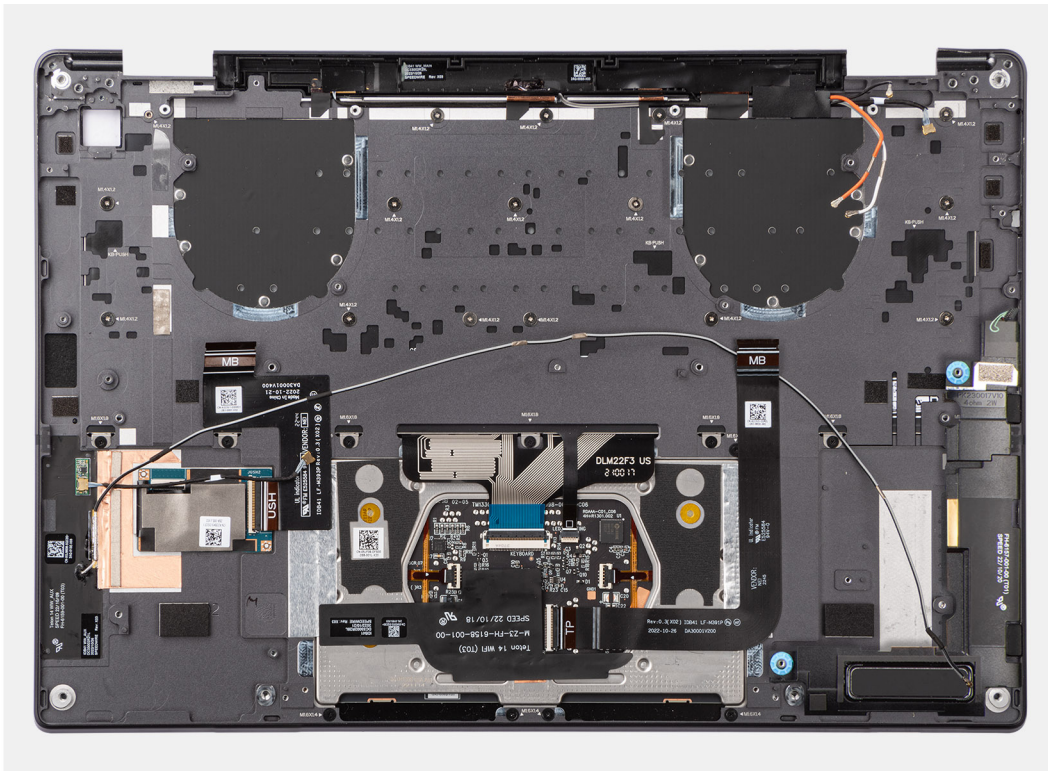

**Figure 69. Installing the palm-rest assembly and keyboard assembly**

### Steps

Place the palm-rest and keyboard assembly on a flat surface.

### Next steps

1. Install the [power button](#).
2. Install the [right-speaker](#).
3. Install the [system board](#).
4. Install the [battery](#).
5. Install the [heat sink](#).
6. Install the [display assembly](#).
7. Install the [left fan](#).
8. Install the [right fan](#).
9. Install the [WWAN card](#), if applicable.
10. Install the [solid-state drive](#).
11. Install the [base cover](#).
12. Install the [Nano-SIM card tray](#), if applicable.
13. Follow the procedure in [after working inside your computer](#).

# Software

This chapter details the supported operating systems along with instructions on how to install the drivers.

## Operating system

Your Latitude 9450 2-in-1 supports the following operating systems:

- Windows 11 22H2
- Windows 11 23H2

## Drivers and downloads

When troubleshooting, downloading, or installing drivers, it is recommended that you read the Dell Knowledge Base article Drivers and Downloads FAQs [000123347](#).

# BIOS Setup

**CAUTION:** Unless you are an expert computer user, do not change the settings in the BIOS Setup. Certain changes can make your computer work incorrectly.

**NOTE:** Depending on the computer and its installed devices, the items that are listed in this section may or may not be displayed.

**NOTE:** Before you change the settings in BIOS Setup, it is recommended that you note down the original settings for future reference.

Use BIOS Setup for the following purposes:

- Get information about the hardware installed in your computer, such as the amount of RAM and the size of the storage device.
- Change the system configuration information.
- Set or change a user-selectable option, such as the user password, type of hard drive installed, and enabling or disabling base devices.

## Entering BIOS setup program

### About this task

Turn on (or restart) your computer and press F2 immediately.

## Navigation keys

**NOTE:** For most of the System Setup options, changes that you make are recorded but do not take effect until you restart the computer.

**Table 26. Navigation keys**

Keys	Navigation
Up arrow	Moves to the previous field.
Down arrow	Moves to the next field.
Enter	Selects a value in the selected field (if applicable) or follows the link in the field.
Spacebar	Expands or collapses a drop-down list, if applicable.
Tab	Moves to the next focus area. <b>NOTE:</b> For the standard graphical user interface only.
Esc	Moves to the previous page until you view the main screen. Pressing Esc in the main screen displays a message that prompts you to save any unsaved changes and restart the computer.

## F12 One Time Boot menu

To enter the One Time Boot menu, turn on your computer, and then press F12 immediately.



 **NOTE:** It is recommended to shut down the computer, if it is on.

The F12 One Time Boot menu displays the devices that you can boot from including the diagnostic option. The boot menu options are:

- Removable Drive (if available)
- STXXXX Drive (if available)
  -  **NOTE:** XXX denotes the SATA drive number.
- Optical Drive (if available)
- SATA Hard Drive (if available)
- Diagnostics

The boot sequence screen also displays the option to access System Setup.

## View Advanced Setup options

### About this task

Some BIOS Setup options are only visible by enabling **Advanced Setup** mode, which is disabled by default.

 **NOTE:** BIOS Setup options, including **Advanced Setup** options, are described in [System setup options](#).

### To enable Advanced Setup

#### Steps

1. Enter BIOS Setup.  
The Overview menu appears.
2. Click the **Advanced Setup** option to move it to the **ON** mode.  
Advanced BIOS Setup options are visible.

## View Service options

### About this task

Service options are hidden by default and only visible by entering a hotkey command.

 **NOTE:** Service options are described in [System setup options](#).

### To view Service options:

#### Steps





1. Enter BIOS Setup.  
The Overview menu appears.
2. Enter the hotkey combination **Ctrl +Alt + s** to view the **Service** options.  
**Service** options are visible.

## System Setup options

 **NOTE:** For most of the System Setup options, changes that you make are recorded but do not take effect until you restart the computer.

 **NOTE:** Depending on your computer and its installed devices, the items that are listed in this section may differ.

**Table 27. System Setup options—Overview menu**

<b>Overview</b>	
Latitude 9450 2-in-1	
BIOS Version	Displays the BIOS version number.
Service Tag	Displays the Service Tag of the computer.
Asset Tag	Displays the Asset Tag of the computer.
Manufacture Date	Displays the manufacture date of the computer.
Ownership Date	Displays the ownership date of the computer.
Express Service Code	Displays the Express Service Code of the computer.
Ownership Tag	Displays the Ownership Tag of the computer.
Signed Firmware Update	Displays whether the Signed Firmware Update is enabled on your computer. By default, the <b>Signed Firmware Update</b> option is enabled.
<b>BATTERY</b> Information	
Primary	Displays the primary battery of the computer.
Battery Level	Displays the battery level of the computer.
Battery State	Displays the battery state of the computer.
Health	Displays the battery health of the computer.
AC Adapter	Displays whether an AC adapter is connected. If connected, displays the type of AC adapter that is connected.
Battery Life Type	Displays battery life as standard, long life cycle 1.0, and long life cycle 2.0. By default, battery life type is set as <b>standard</b> .
<b>PROCESSOR</b> Information	
Processor Type	Displays the processor type.
Maximum Clock Speed	Displays the maximum processor clock speed.  <b>NOTE:</b> To view this option, enable <b>Advanced Setup</b> mode as described in <a href="#">View Advanced Setup options</a> .
Minimum Clock Speed	Displays the minimum processor clock speed.  <b>NOTE:</b> To view this option, enable <b>Advanced Setup</b> mode as described in <a href="#">View Advanced Setup options</a> .
Current Clock Speed	Displays the current processor clock speed.  <b>NOTE:</b> To view this option, enable <b>Advanced Setup</b> mode as described in <a href="#">View Advanced Setup options</a> .
Core Count	Displays the number of cores on the processor.
Processor ID	Displays the processor identification code.
Microcode Version	Displays the microcode version.  <b>NOTE:</b> To view this option, enable <b>Advanced Setup</b> mode as described in <a href="#">View Advanced Setup options</a> .
Intel Hyper-Threading Capable	Displays whether the processor is Hyper-Threading (HT) capable.  <b>NOTE:</b> To view this option, enable <b>Advanced Setup</b> mode as described in <a href="#">View Advanced Setup options</a> .
<b>MEMORY</b> Information	
Memory Installed	Displays the total computer memory installed.

**Table 27. System Setup options—Overview menu (continued)**

<b>Overview</b>	
Memory Available	Displays the total computer memory available.
Memory Speed	Displays the memory speed. <b>i</b> <b>NOTE:</b> To view this option, enable <b>Advanced Setup</b> mode as described in <a href="#">View Advanced Setup options</a> .
Memory Channel Mode	Displays single or dual channel mode. <b>i</b> <b>NOTE:</b> To view this option, enable <b>Advanced Setup</b> mode as described in <a href="#">View Advanced Setup options</a> .
Memory Technology	Displays the technology that is used for the memory.
<b>DEVICES</b> Information	
Panel Type	Displays the panel type of the computer.
Panel Revision	Displays the panel revision of the computer.
Video Controller	Displays the video controller type of the computer.
Video Memory	Displays the video memory information of the computer.
Wi-Fi Device	Displays the wireless device information of the computer.
Native Resolution	Displays the native resolution of the computer.
Video BIOS Version	Displays the video BIOS version of the computer. <b>i</b> <b>NOTE:</b> To view this option, enable <b>Advanced Setup</b> mode as described in <a href="#">View Advanced Setup options</a> .
Audio Controller	Displays the audio controller information of the computer.
Bluetooth Device	Displays the Bluetooth device information of the computer.
Pass Through MAC Address	Displays the MAC address of the video pass-through.
Cellular Device	Displays the Cellular device information of the computer.

**Table 28. System Setup options—Boot Configuration menu**

<b>Boot Configuration</b>	
<b>Boot Sequence</b>	
Boot Mode: UEFI only	Displays the boot mode of the computer.
Enable PXE Boot Priority	Enables the PXE Boot Priority. By default, the <b>Enable PXE Boot Priority</b> option is disabled.
<b>Secure Boot</b>	
	Secure Boot is a method of guaranteeing the integrity of the boot path by performing additional validation of the operating system and PCI add-in cards. The computer stops booting to the operating system when a component is not authenticated during the boot process. Secure Boot can be enabled in BIOS setup or using management interfaces like Dell Command Configure, but can only be disabled from BIOS setup.
Enable Secure Boot	Enables the computer to boot using only validated boot software. By default, this <b>Enable Secure Boot</b> option is disabled. For additional security, Dell Technologies recommends keeping the <b>Secure Boot</b> option enabled to ensure that the UEFI firmware validates the operating system during the boot process. <b>i</b> <b>NOTE:</b> To view this option, enable <b>Advanced Setup</b> mode as described in <a href="#">View Advanced Setup options</a> .

**Table 28. System Setup options—Boot Configuration menu (continued)**

<b>Boot Configuration</b>	
	<p><b>i</b> <b>NOTE:</b> To enable Secure Boot, the computer is required to be in UEFI boot mode and the Enable Legacy Option ROMs option is required to be turned off.</p>
Enable Microsoft UEFI CA	<p>When disabled, the UEFI CA is removed from the BIOS UEFI Secure Boot database.</p> <p><b>i</b> <b>NOTE:</b> When disabled, the Microsoft UEFI CA can cause your computer to not boot, computer graphics may not function, some devices may not function properly, and the computer could become unrecoverable.</p> <p>By default, the <b>Enable Microsoft UEFI CA</b> option is enabled.</p> <p>For additional security, Dell Technologies recommends keeping the <b>Microsoft UEFI CA</b> option enabled to ensure the broadest compatibility with devices and operating systems.</p> <p><b>i</b> <b>NOTE:</b> To view this option, enable <b>Advanced Setup</b> mode as described in <a href="#">View Advanced Setup options</a>.</p>
Secure Boot Mode	<p>Enables or disables the Secure Boot operation mode.</p> <p>By default, the <b>Deployed Mode</b> is selected. <b>Deployed Mode</b> should be selected for normal operation of Secure Boot.</p> <p><b>i</b> <b>NOTE:</b> To view this option, enable <b>Advanced Setup</b> mode as described in <a href="#">View Advanced Setup options</a>.</p>
<b>Expert Key Management</b>	
Enable Custom Mode	<p>Enables or disables the keys in the PK, KEK, db, and dbx security key databases to be modified.</p> <p>By default, the <b>Enable Custom Mode</b> option is disabled.</p> <p><b>i</b> <b>NOTE:</b> To view this option, enable <b>Advanced Setup</b> mode as described in <a href="#">View Advanced Setup options</a>.</p>
Custom Mode Key Management	<p>Selects the custom values for expert key management.</p> <p>By default, the <b>PK</b> option is selected.</p> <p><b>i</b> <b>NOTE:</b> To view this option, enable <b>Advanced Setup</b> mode as described in <a href="#">View Advanced Setup options</a>.</p>

**Table 29. System Setup options—Integrated Devices menu**

<b>Integrated Devices</b>	
<b>Date/Time</b>	
Date	Sets the computer date in MM/DD/YYYY format. Changes to the date format take effect immediately.
Time	Sets the computer time in HH/MM/SS 24-hour format. You can switch between a 12-hour or 24-hour clock. Changes to the time format take effect immediately.
<b>Camera</b>	
Enable Camera	<p>Enables the camera.</p> <p>By default, the <b>Enable Camera</b> option is enabled.</p> <p><b>i</b> <b>NOTE:</b> Depending on the configuration ordered, the camera setup option may not be available.</p>
<b>Audio</b>	
Enable Audio	Enables all integrated audio controller.

**Table 29. System Setup options—Integrated Devices menu (continued)**

<b>Integrated Devices</b>	
	By default, all the options are enabled.
Enable Microphone	<p>Enables the microphone.</p> <p>By default, the <b>Enable Microphone</b> option is enabled.</p> <p><b>i</b> <b>NOTE:</b> Depending on the configuration ordered, the microphone setup option may not be available.</p>
Enable Internal Speaker	<p>Enables the internal speaker.</p> <p>By default, the <b>Enable Internal Speaker</b> option is enabled.</p>
<b>USB/Thunderbolt Configuration</b>	
Enable USB Boot Support	<p>Enables booting from USB mass storage devices that are connected to external USB ports.</p> <p>By default, the <b>Enable USB Boot Support</b> option is enabled.</p> <p><b>i</b> <b>NOTE:</b> To view this option, enable <b>Advanced Setup</b> mode as described in <a href="#">View Advanced Setup options</a>.</p>
Enable External USB Ports	<p>Enables the external USB ports.</p> <p>By default, the <b>Enable External USB Ports</b> option is enabled.</p> <p><b>i</b> <b>NOTE:</b> To view this option, enable <b>Advanced Setup</b> mode as described in <a href="#">View Advanced Setup options</a>.</p>
<b>Enable Thunderbolt Technology Support</b>	
Enable Thunderbolt Technology Support	<p>Enables the associated ports and adapters for Thunderbolt Technology support.</p> <p>By default, the <b>Enable Thunderbolt Technology Support</b> option is enabled.</p> <p><b>i</b> <b>NOTE:</b> To view this option, enable <b>Advanced Setup</b> mode as described in <a href="#">View Advanced Setup options</a>.</p>
<b>Enable Thunderbolt Boot Support</b>	
Enable Thunderbolt Boot Support	<p>Enables the Thunderbolt adapter-peripheral device and USB devices that are connected to the Thunderbolt adapter to be used during BIOS Preboot.</p> <p>By default, the <b>Enable Thunderbolt Boot Support</b> option is disabled.</p> <p><b>i</b> <b>NOTE:</b> To view this option, enable <b>Advanced Setup</b> mode as described in <a href="#">View Advanced Setup options</a>.</p>
<b>Enable Thunderbolt (and PCIe behind TBT) pre-boot modules</b>	<p>Enables the PCIe devices that are connected through a Thunderbolt adapter to run the PCIe devices UEFI Option ROM (if present) during preboot.</p> <p>By default, the <b>Enable Thunderbolt (and PCIe behind TBT) pre-boot modules</b> option is disabled.</p> <p><b>i</b> <b>NOTE:</b> To view this option, enable <b>Advanced Setup</b> mode as described in <a href="#">View Advanced Setup options</a>.</p>
<b>Disable USB4 PCIE Tunneling</b>	<p>Disables the USB4 PCIE Tunneling option.</p> <p>By default, the <b>Disable USB4 PCIE Tunneling</b> option is disabled.</p> <p><b>i</b> <b>NOTE:</b> To view this option, enable <b>Advanced Setup</b> mode as described in <a href="#">Entering BIOS Setup program</a>.</p>
<b>Video/Power only on Type-C Ports</b>	<p>Enables or disables the Type-C port functionality to video or only power.</p> <p>By default, the <b>Video/Power only on Type-C Ports</b> option is disabled.</p>

**Table 29. System Setup options—Integrated Devices menu (continued)**

<b>Integrated Devices</b>	
	<p><b>i</b> <b>NOTE:</b> To view this option, enable <b>Advanced Setup</b> mode as described in <a href="#">View Advanced Setup options</a>.</p>
<b>Type-C Dock</b>	
Type-C Dock Override	<p>Enables or disables to use connected Type-C Dell Dock to provide data stream with external USB ports disabled. When Type-C Dock override is enabled, the Video/Audio/LAN submenu is activated.</p> <p>By default, the <b>Type-C Dock Override</b> option is enabled.</p> <p><b>i</b> <b>NOTE:</b> To view this option, enable <b>Advanced Setup</b> mode as described in <a href="#">Entering BIOS Setup program</a>.</p>
Type-C Dock Audio	<p>Enables or disables the usage of audio inputs and outputs from the connected Type-C Dell docking station.</p> <p>By default, the <b>Type-C Dock Audio</b> option is enabled.</p> <p><b>i</b> <b>NOTE:</b> To view this option, enable <b>Advanced Setup</b> mode as described in <a href="#">View Advanced Setup options</a>.</p>
Type-C Dock LAN	<p>Enables or disables the usage of LAN on the external ports of the connected Type-C Dell docking station.</p> <p>By default, the <b>Type-C Dock LAN</b> option is enabled.</p> <p><b>i</b> <b>NOTE:</b> To view this option, enable <b>Advanced Setup</b> mode as described in <a href="#">View Advanced Setup options</a>.</p>
<b>Miscellaneous Devices</b>	
Enable Fingerprint Reader Device	<p>Enables or disables the Fingerprint Reader Device option.</p> <p>By default, the <b>Enable Fingerprint Reader Device</b> option is enabled.</p> <p><b>i</b> <b>NOTE:</b> To view this option, enable <b>Advanced Setup</b> mode as described in <a href="#">View Advanced Setup options</a>.</p>

**Table 30. System Setup options—Storage menu**

<b>Storage</b>	
<b>SATA/NVMe Operation</b>	
SATA/NVMe Operation	<p>Sets the operating mode of the integrated SATA hard drive controller.</p> <p>By default, the <b>Raid On</b> option is selected.</p>
<b>Storage Interface</b>	
Port Enablement	<p>Enables or disables the M.2 PCIe SSD option.</p> <p>By default, the <b>M.2 PCIe SSD</b> option is enabled.</p>
Smart Reporting	<p>Enables or disables the Smart reporting option.</p> <p>By default, the <b>Smart Reporting</b> option is disabled.</p> <p><b>i</b> <b>NOTE:</b> To view this option, enable <b>Advanced Setup</b> mode as described in <a href="#">View Advanced Setup options</a>.</p>
<b>Drive Information</b>	<p>Displays the information of onboard drives.</p>







**Table 31. System Setup options—Display menu**

Display	
<b>Display Brightness</b>	
Brightness on battery power	<p>Enables to set the screen brightness when the computer is running on battery power.</p> <p>By default, the screen brightness is set to 50 when the computer is running on battery power.</p> <p><b>NOTE:</b> To view this option, enable <b>Advanced Setup</b> mode as described in <a href="#">View Advanced Setup options</a>.</p>
Brightness on AC power	<p>Enables to set the screen brightness when the computer is running on AC power.</p> <p>By default, the screen brightness is set to 100 when the computer is running on AC power.</p> <p><b>NOTE:</b> To view this option, enable <b>Advanced Setup</b> mode as described in <a href="#">View Advanced Setup options</a>.</p>
<b>Touchscreen</b>	<p>Enables or disables the touch screen option.</p> <p>By default, the <b>Touchscreen</b> option is enabled.</p> <p><b>NOTE:</b> Only available on computers with touch screen displays.</p> <p><b>NOTE:</b> To view this option, enable <b>Advanced Setup</b> mode as described in <a href="#">View Advanced Setup options</a>.</p>
<b>Full Screen Logo</b>	<p>Enables or disables the computer to display full screen logo, if the image matches screen resolution.</p> <p>By default, the <b>Full Screen Logo</b> option is disabled.</p> <p><b>NOTE:</b> To view this option, enable <b>Advanced Setup</b> mode as described in <a href="#">View Advanced Setup options</a>.</p>

**Table 32. System Setup options—Connection menu**

Connection	
<b>Wireless Device Enable</b>	
WWAN/GPS	<p>Enables or disables the internal WWAN device.</p> <p>By default, the <b>WWAN/GPS</b> option is enabled.</p>
WLAN	<p>Enables or disables the internal WLAN device.</p> <p>By default, the <b>WLAN</b> option is enabled.</p>
Bluetooth	<p>Enables or disables the internal Bluetooth device.</p> <p>By default, the <b>Bluetooth</b> option is enabled.</p>
<b>Enable UEFI Network Stack</b>	<p>Enables or disables the UEFI Network Stack and controls the onboard LAN Controller.</p> <p>By default, the <b>Enable UEFI Network Stack</b> option is enabled.</p> <p><b>NOTE:</b> To view this option, enable <b>Advanced Setup</b> mode as described in <a href="#">View Advanced Setup options</a>.</p>
<b>Wireless Radio Control</b>	
Control WLAN Radio	<p>Enables to sense the connection of the computer to a wired network and then disables the selected WLAN radio. Upon disconnection from the wired network, the selected wireless radios are reenabled.</p> <p>By default, the <b>Control WLAN Radio</b> option is disabled.</p>

**Table 32. System Setup options—Connection menu (continued)**

Connection	
	<p> <b>NOTE:</b> To view this option, enable <b>Advanced Setup</b> mode as described in <a href="#">View Advanced Setup options</a>.</p>
Control WWAN Radio	<p>Enables to sense the connection of the computer to a wired network and then disables the selected WWAN radios.</p> <p>By default, the <b>Control WWAN Radio</b> option is disabled.</p> <p> <b>NOTE:</b> To view this option, enable <b>Advanced Setup</b> mode as described in <a href="#">View Advanced Setup options</a>.</p>
<b>Enable UEFI Bluetooth Stack</b>	<p>Enables or disables the UEFI Bluetooth Stack and controls the onboard LAN Controller.</p> <p>By default, the <b>Enable UEFI Bluetooth Stack</b> option is enabled.</p> <p> <b>NOTE:</b> To view this option, enable <b>Advanced Setup</b> mode as described in <a href="#">View Advanced Setup options</a>.</p>
Dynamic Wireless Transmit Power	<p>When enabled, the computer increases the transmit power of the WLAN device to improve performance in certain computer configurations.</p> <p>By default, the <b>Dynamic Wireless Transmit Power</b> is disabled.</p> <p> <b>NOTE:</b> To view this option, enable <b>Advanced Setup</b> mode as described in <a href="#">View Advanced Setup options</a>.</p>
HTTP(s) Boot	<p>When enabled, supports HTTP(s) boot on the client BIOS, which offers wired or wireless and HTTP/HTTPS connection options.</p> <p> <b>NOTE:</b> To view this option, enable <b>HTTP(s) Boot</b> as described in <a href="#">View Advanced Setup options</a>.</p>
HTTP(s) Boot Modes	<p>In Auto Mode, the boot URL is obtained from the DHCP response; the boot URL specifies the HTTP Boot Server and location of the Network Boot Program (NBP) file. In Manual mode, the user enters the URL in the text box, which must start with <code>http://</code> or <code>https://</code> and end with the NBP file name.</p> <p>By default, the <b>Control WWAN Radio</b> option is disabled.</p> <p>By default, <b>Auto Mode</b> is selected.</p> <p> <b>NOTE:</b> To view this option, enable <b>Advanced Setup</b> mode as described in <a href="#">View Advanced Setup options</a>.</p>

**Table 33. System Setup options—Power menu**

Power	
<b>Battery Configuration</b>	<p>Enables or disables the computer to run on battery during peak power usage hours. Use the table <b>Custom Charge Start</b> and <b>Custom Charge Stop</b>, to prevent AC power usage between certain times of each day.</p> <p>By default, the <b>Adaptive</b> option is selected. Battery settings are adaptively optimized based on your typical battery usage pattern.</p>
<b>Advanced Configuration</b>	
Enable Advanced Battery Charge Configuration	<p>Enables Advanced Battery Charge Configuration from the beginning of the day to a specified work period. When enabled, Advanced Battery Charged maximizes battery health while still supporting heavy use during the work day.</p> <p>By default, the <b>Enable Advanced Battery Charge Configuration</b> option is disabled.</p> <p> <b>NOTE:</b> To view this option, enable <b>Advanced Setup</b> mode as described in <a href="#">View Advanced Setup options</a>.</p>



**Table 33. System Setup options—Power menu (continued)**

<b>Power</b>	
<b>Peak Shift</b>	
Enable Peak Shift	<p>Enables or disables the computer to run on battery during peak power usage hours.</p> <p>By default, the <b>Enable Peak Shift</b> option is disabled.</p> <p><b>i</b> <b>NOTE:</b> To view this option, enable <b>Advanced Setup</b> mode as described in <a href="#">View Advanced Setup options</a>.</p>
<b>Thermal Management</b>	
	<p>Enables or disables cooling of the fan and manages the processor heat to adjust the system performance, noise, and temperature.</p> <p>By default, the <b>Optimized</b> option is selected. Standard settings for balanced performance, noise, and temperature.</p>
<b>USB Wake Support</b>	
Wake on Dell USB-C Dock	<p>When enabled, connecting a Dell USB-C Dock wakes the computer from Standby, Hibernate, and Power Off.</p> <p>By default, the <b>Wake on Dell USB-C Dock</b> option is enabled.</p> <p><b>i</b> <b>NOTE:</b> To view this option, enable <b>Advanced Setup</b> mode as described in <a href="#">View Advanced Setup options</a>.</p>
<b>Block Sleep</b>	
	<p>Enables or disables the computer from entering Sleep (S3) mode in the operating system.</p> <p>By default, the <b>Block Sleep</b> option is disabled.</p> <p><b>i</b> <b>NOTE:</b> When enabled, the computer does not go to Sleep, Intel Rapid Start is disabled automatically, and the operating system power option is blank if it was set to Sleep.</p> <p><b>i</b> <b>NOTE:</b> To view this option, enable <b>Advanced Setup</b> mode as described in <a href="#">View Advanced Setup options</a>.</p>
<b>Lid Switch</b>	
Enable Lid Switch	<p>Enables or disables the Lid Switch.</p> <p>By default, the <b>Enable Lid Switch</b> option is enabled.</p>
Power On Lid Open	<p>When enabled, allows the computer to turn on from the off state whenever the lid is opened.</p> <p>By default, the <b>Power On Lid Open</b> option is enabled.</p>
<b>Intel Speed Shift Technology</b>	
	<p>Enables or disables the Intel Speed Shift Technology support. When enabled, the operating system selects the appropriate processor performance automatically.</p> <p>By default, the <b>Intel Speed Shift Technology</b> option is enabled.</p> <p><b>i</b> <b>NOTE:</b> To view this option, enable <b>Service</b> options as described in <a href="#">View Service options</a>.</p>







**Table 34. System Setup options—Security menu**

<b>Security</b>	
<b>TPM 2.0 Security</b>	
	<p>Trusted Platform Module (TPM) is a security device that stores computer-generated keys for encryption and features such as BitLocker, Virtual Secure Mode, remote Attestation.</p> <p>By default, the <b>TPM 2.0 Security</b> option is enabled.</p>







**Table 34. System Setup options—Security menu (continued)**

Security	
	<p>For additional security, Dell Technologies recommends keeping the Trusted Platform Module (TPM) enabled to allow these security technologies to fully function.</p>
TPM 2.0 Security On	<p>Enables or disables the TPM.</p> <p>By default, the <b>TPM 2.0 Security On</b> option is enabled.</p> <p>For additional security, Dell Technologies recommends keeping TPM enabled to allow these security technologies to fully function.</p> <p><b>NOTE:</b> To view this option, enable <b>Advanced Setup</b> mode as described in <a href="#">View Advanced Setup options</a>.</p>
Attestation Enable	<p>The <b>Attestation Enable</b> option controls the endorsement hierarchy of TPM. Disabling the <b>Attestation Enable</b> option prevents TPM from being used to digitally sign certificates.</p> <p>By default, the <b>Attestation Enable</b> option is enabled.</p> <p>For additional security, Dell Technologies recommends keeping the <b>Attestation Enable</b> option enabled.</p> <p><b>NOTE:</b> When disabled, this feature may cause compatibility issues or loss of functionality in some operating systems.</p> <p><b>NOTE:</b> To view this option, enable <b>Advanced Setup</b> mode as described in <a href="#">View Advanced Setup options</a>.</p>
Key Storage Enable	<p>The <b>Key Storage Enable</b> option controls the storage hierarchy of TPM, which is used to store digital keys. Disabling the <b>Key Storage Enable</b> option restricts the ability of TPM to store owner's data.</p> <p>By default, the <b>Key Storage Enable</b> option is enabled.</p> <p>For additional security, Dell Technologies recommends keeping the <b>Key Storage Enable</b> option enabled.</p> <p><b>NOTE:</b> When disabled, this feature may cause compatibility issues or loss of functionality in some operating systems.</p> <p><b>NOTE:</b> To view this option, enable <b>Service</b> options as described in <a href="#">View Service options</a>.</p>
Clear	<p>When enabled, the <b>Clear</b> option clears information that is stored in the TPM after exiting the system's BIOS. This option returns to the disabled state when the computer restarts.</p> <p>By default, the <b>Clear</b> option is disabled.</p> <p>Dell Technologies recommends enabling the <b>Clear</b> option only when TPM data is required to be cleared.</p> <p><b>NOTE:</b> To view this option, enable <b>Advanced Setup</b> mode as described in <a href="#">View Advanced Setup options</a>.</p>
Physical Presence Interface (PPI) Bypass for Clear Commands	<p>The PPI Bypass for Clear Commands option allows the operating system to manage certain aspects of PTT. When enabled, you are not prompted to confirm changes to the PTT configuration.</p> <p>By default, the <b>PPI Bypass for Clear Commands</b> option is disabled.</p> <p>For additional security, Dell Technologies recommends keeping the <b>PPI Bypass for Clear Commands</b> option disabled.</p>
Intel Total Memory Encryption	<p>Enables or disables the processor's memory encryption feature.</p> <p>By default, the <b>Intel Total Memory Encryption</b> option is disabled.</p>

**Table 34. System Setup options—Security menu (continued)**

<b>Security</b>	
	<p> <b>NOTE:</b> To view this option, enable <b>Advanced Setup</b> mode as described in <a href="#">View Advanced Setup options</a>.</p>
<b>Chassis Intrusion</b>	
Chassis Intrusion	<p>Enables or disables the detection of chassis intrusion events. This feature notifies the user when the base cover has been removed from the computer.</p> <p>When set to <b>Enabled</b>, a notification is displayed on the next boot and the event is logged in the BIOS Events log.</p> <p>When set to <b>Disabled</b>, no notification is displayed and no event is logged in the BIOS Events log.</p> <p>When set to <b>On-Silent</b>, the event is logged in the BIOS Events log, but no notification is displayed.</p> <p>By default, the <b>Chassis Intrusion Detection</b> option is disabled.</p> <p>For additional security, Dell Technologies recommends keeping the <b>Chassis Intrusion</b> option enabled.</p> <p> <b>NOTE:</b> To view this option, enable <b>Advanced Setup</b> mode as described in <a href="#">View Advanced Setup options</a>.</p>
Block Boot Until Cleared	<p>The <b>Block Boot Until Clear</b> option is enabled when <b>Chassis Intrusion</b> is enabled. When enabled, the computer does not boot until the chassis intrusion is cleared.</p> <p>By default, the <b>Block Boot Until Clear</b> option is disabled.</p> <p> <b>NOTE:</b> To view this option, enable <b>Advanced Setup</b> mode as described in <a href="#">View Advanced Setup options</a>.</p>
Clear Intrusion Warning	<p><b>Clear Intrusion Warning</b> appears only after chassis intrusion is enabled and has been tripped.</p> <p>By default, the <b>Clear Intrusion Warning</b> option is disabled.</p> <p> <b>NOTE:</b> To view this option, enable <b>Advanced Setup</b> mode as described in <a href="#">View Advanced Setup options</a>.</p>
<b>SMM Security Mitigation</b>	
	<p>Enables or disables additional UEFI SMM Security Mitigation protections. This option uses the Windows SMM Security Mitigations Table (WSMT) to confirm to the operating system that security best practices have been implemented by the UEFI firmware.</p> <p>By default, the <b>SMM Security Mitigation</b> option is enabled.</p> <p>For additional security, Dell Technologies recommends keeping the <b>SMM Security Mitigation</b> option enabled unless you have a specific application which is not compatible.</p> <p> <b>NOTE:</b> This feature may cause compatibility issues or loss of functionality with some legacy tools and applications.</p> <p> <b>NOTE:</b> To view this option, enable <b>Service</b> options as described in <a href="#">View Service options</a>.</p>
<b>Data Wipe on Next Boot</b>	
Start Data Wipe	<p>Data Wipe is a secure wipe operation that deletes information from a storage device.</p> <p> <b>CAUTION:</b> The <b>Secure Data Wipe</b> operation erases information in a way that it cannot be reconstructed.</p> <p>Commands such as delete and format in the operating system may remove files from showing up in the file system, however they can be reconstructed through</p>

**Table 34. System Setup options—Security menu (continued)**

<b>Security</b>	
	<p>forensic means as they are still represented on the physical media. Data Wipe prevents this reconstruction and is not recoverable.</p> <p>When enabled, the BIOS will queue up a data wipe cycle for storage devices that are connected to the motherboard on the next reboot.</p> <p>By default, the <b>Start Data Wipe</b> option is disabled.</p> <p> <b>NOTE:</b> To view this option, enable <b>Advanced Setup</b> mode as described in <a href="#">View Advanced Setup options</a>.</p>
<b>HDD Security</b>	
SED Block SID Authentication	<p>Allows you to enable <b>SED Block SID Authentication</b>.</p> <p>By default, the <b>SED Block SID Authentication</b> option is enabled.</p>
PPI Bypass for SED Block SID Command	<p>Allows you to enable <b>PPI Bypass for SED Block SID Command</b>.</p> <p>By default, the <b>PPI Bypass for SED Block SID Command</b> option is disabled.</p>
<b>Absolute</b>	<p>Absolute Software provides various cyber security solutions, some requiring software preloaded on Dell computers and integrated into the BIOS. To use these features, you must enable the Absolute BIOS setting and contact Absolute for configuration and activation.</p> <p>By default, the <b>Absolute</b> option is enabled.</p> <p>For additional security, Dell Technologies recommends keeping the <b>Absolute</b> option enabled.</p> <p> <b>WARNING:</b> The <b>Permanently Disabled</b> option can only be selected once. When <b>Permanently Disabled</b> is selected, <b>Absolute Persistence</b> cannot be reenabled. No further changes to the <b>Enable/Disable</b> states are allowed.</p> <p> <b>NOTE:</b> The <b>Enable/Disable</b> options are unavailable while the computer is in the activated state.</p> <p> <b>NOTE:</b> When the Absolute features are activated, the Absolute integration cannot be disabled from the BIOS Setup screen.</p>
<b>UEFI Boot Path Security</b>	<p>Enables or disables the computer to prompt the user to enter the Administrator password (if set) when booting to a UEFI boot path device from the F12 boot menu.</p> <p>By default, the <b>Always Except Internal HDD</b> option is enabled.</p> <p> <b>NOTE:</b> To view this option, enable <b>Advanced Setup</b> mode as described in <a href="#">View Advanced Setup options</a>.</p>
<b>Firmware Device Tamper Detection</b>	<p>Allows you to control the firmware device tamper detection feature. This feature notifies the user when the firmware device is tampered. When enabled, a screen warning message is displayed on the computer and a tamper detection event is logged in the BIOS Events log. The computer fails to reboot until the event is cleared.</p> <p>By default, the <b>Firmware Device Tamper Detection</b> option is enabled.</p> <p>For additional security, Dell Technologies recommends keeping the <b>Firmware Device Tamper Detection</b> option enabled.</p> <p> <b>NOTE:</b> To view this option, enable <b>Advanced Setup</b> mode as described in <a href="#">View Advanced Setup options</a>.</p>
<b>SafeShutter</b>	

**Table 34. System Setup options—Security menu (continued)**

Security	
<b>Dynamic Shutter</b>	<p>Device camera shutter will automatically open when user grants application permission and closes when permission ends. Disable dynamic behavior by pressing F9 camera mute (LED on).</p> <p>By default, the <b>Dynamic Shutter</b> option is disabled.</p>
<b>Manual Shutter Control</b>	<p>Manual Shutter Control</p> <p>Disengage camera off by pressing F9 to open shutter (LED off).</p> <p>Engage camera on by pressing F9 to close shutter (LED on).</p> <p>By default, the <b>Manual Shutter Control</b> option is enabled.</p>
<b>Firmware Device Tamper Detection</b>	<p>The field controls the Firmware Device Temper Detection feature.</p> <p>By default, the <b>Firmware Device Tamper Detection</b> set to silent.</p> <p><b>i</b> <b>NOTE:</b> To view this option, enable <b>Advanced Setup</b> mode as described in <a href="#">View Advanced Setup options</a>.</p>
<b>Clear Firmware Device Tamper Detection</b>	<p>Select this option to clear the event and allow booting.</p> <p>By default, the <b>Clear Firmware Device Tamper Detection</b> option is disabled.</p> <p><b>i</b> <b>NOTE:</b> To view this option, enable <b>Advanced Setup</b> mode as described in <a href="#">View Advanced Setup options</a>.</p>
Intel Platform Trust Technology	
<b>PPI Bypass for Clear Commands</b>	<p>By default, the <b>PPI Bypass for Clear Commands</b> option is disabled.</p> <p><b>i</b> <b>NOTE:</b> To view this option, enable <b>Advanced Setup</b> mode as described in <a href="#">View Advanced Setup options</a>.</p>
<b>Intel Platform Trust Technology On</b>	<p>By default, the <b>Intel Platform Trust Technology On</b> option is enabled.</p> <p><b>i</b> <b>NOTE:</b> To view this option, enable <b>Advanced Setup</b> mode as described in <a href="#">View Advanced Setup options</a>.</p>
<b>Clear</b>	<p>By default, the <b>Clear</b> option is disabled.</p> <p><b>i</b> <b>NOTE:</b> To view this option, enable <b>Advanced Setup</b> mode as described in <a href="#">View Advanced Setup options</a>.</p>

**Table 35. System Setup options—Passwords menu**

Passwords	
<b>Administrator Password</b>	<p>The Administrator Password prevents unauthorized access to the BIOS Setup options. Once the administrator password is set, the BIOS Setup options can only be modified after providing the correct password.</p> <p>The following rules and dependencies apply to the Administrator Password -</p> <ul style="list-style-type: none"> <li>• The administrator password cannot be set if system and/or internal hard drive passwords are previously set.</li> <li>• The administrator password can be used in place of the system and/or internal hard drive passwords.</li> <li>• When set, the administrator password must be provided during a firmware update.</li> <li>• Clearing the administrator password also clears the system password (if set).</li> </ul> <p>Dell Technologies recommends using an administrator password to prevent unauthorized changes to BIOS Setup options.</p>

**Table 35. System Setup options—Passwords menu (continued)**

<b>Passwords</b>	
<b>System Password</b>	<p>The System Password prevents the computer from booting to an operating system without entering the correct password.</p> <p>The following rules and dependencies apply when the System Password is used -</p> <ul style="list-style-type: none"> <li>• The computer shuts down when idle for approximately 10 minutes at the system password prompt.</li> <li>• The computer shuts down after three incorrect attempts to enter the system password.</li> <li>• The computer shuts down when the <b>Esc</b> key is pressed at the <b>System Password</b> prompt.</li> <li>• The system password is not prompted when the computer resumes from standby mode.</li> </ul> <p>Dell Technologies recommends using the system password in situations where it is likely that a computer may be lost or stolen.</p>
<p><b>Hard Drive Password</b></p> <p> <b>NOTE:</b> On some computers, the <b>M.2 PCIe SSD-0 Password</b> option is shown.</p>	<p>The hard drive password can be set to prevent unauthorized access of the data stored on the solid-state drive. The computer prompts for the hard drive password during boot in order to unlock the drive. A password-secured hard drive stays locked even when removed from the computer or placed into another computer. It prevents an attacker from accessing data on the drive without authorization.</p> <p>The following rules and dependencies apply when the <b>Hard Drive Password</b> or <b>M.2 PCIe SSD-0 Password</b> option is used.</p> <ul style="list-style-type: none"> <li>• The hard drive password option cannot be accessed when the hard drive is disabled in the BIOS Setup.</li> <li>• The computer shuts down when idle for approximately 10 minutes at the hard drive password prompt.</li> <li>• The computer shuts down after three incorrect attempts to enter the hard drive password and treats the hard drive as not available.</li> <li>• The hard drive does not accept password unlock attempts after five incorrect attempts to enter the hard drive password from the BIOS Setup. The hard drive password must be reset for the new password unlock attempts.</li> <li>• The computer treats the hard drive as not available when the <b>Esc</b> key is pressed at the hard drive password prompt.</li> <li>• The hard drive password is not prompted when the computer resumes from standby mode. When the hard drive is unlocked by the user before the computer goes into standby mode, it remains unlocked after the computer resumes from standby mode.</li> <li>• If the system and hard drive passwords are set to the same value, the hard drive unlocks after the correct system password is entered.</li> </ul> <p>Dell Technologies recommends using a hard drive password to protect unauthorized data access.</p>
<b>Password Configuration</b>	<p>The Password configuration page includes several options for changing the requirements of BIOS passwords. You can modify the minimum and maximum length of the passwords as well as require passwords to contain certain character classes (upper case, lower case, digit, special character).</p> <p>When the <b>Lower Case Letter</b> option is enabled, the password requires at least one lower case letter.</p> <p>When the <b>Upper Case Letter</b> option is enabled, the password requires at least one upper case letter.</p> <p>When the <b>Digit</b> option is enabled, the password requires at least one numeric digit.</p> <p>When the <b>Special Character</b> option is enabled, the password requires at least one special character from the set: !"#%&amp;'()*+,-./:;&lt;=&gt;?@[\\]^_`{ }~.</p>

**Table 35. System Setup options—Passwords menu (continued)**

<b>Passwords</b>	
	<p>When setting <b>Minimum Characters</b> for password length, Dell Technologies recommends setting the minimum password length to at least eight characters.</p> <p><b>i</b> <b>NOTE:</b> To view this option, enable <b>Advanced Setup</b> mode as described in <a href="#">View Advanced Setup options</a>.</p>
<b>Password Bypass</b>	<p>The <b>Password Bypass</b> option allows the computer to reboot from the operating system without entering the system or hard drive password. If the computer has already booted to the operating system, it is presumed that the user has already entered the correct system or hard drive password.</p> <p><b>i</b> <b>NOTE:</b> This option does not remove the requirement to enter the password after shutting down.</p> <p>By default, the <b>Password Bypass</b> option is disabled.</p> <p>For additional security, Dell Technologies recommends keeping the <b>Password Bypass</b> option enabled.</p> <p><b>i</b> <b>NOTE:</b> To view this option, enable <b>Advanced Setup</b> mode as described in <a href="#">View Advanced Setup options</a>.</p>
<b>Password Changes</b>	
Allow Non-Admin Password Changes	<p>The <b>Allow Non-Admin Password Changes</b> option in BIOS Setup allows an end user to set or change the system or hard drive passwords without entering the administrator password. This gives an administrator control over the BIOS settings but enables an end user to provide their own password.</p> <p>By default, the <b>Allow Non-Admin Password Changes</b> option is enabled.</p> <p>For additional security, Dell Technologies recommends keeping the <b>Allow Non-Admin Password Changes</b> option disabled.</p> <p><b>i</b> <b>NOTE:</b> To view this option, enable <b>Advanced Setup</b> mode as described in <a href="#">View Advanced Setup options</a>.</p>
<b>Enable Admin Setup Lockout</b>	<p>The <b>Admin Setup Lockout</b> option prevents an end user from even viewing the BIOS Setup configuration without first entering the administrator password (if set).</p> <p>By default, the <b>Enable Admin Setup Lockout</b> option is disabled.</p> <p>For additional security, Dell Technologies recommends keeping the <b>Admin Setup Lockout</b> option disabled.</p> <p><b>i</b> <b>NOTE:</b> To view this option, enable <b>Advanced Setup</b> mode as described in <a href="#">View Advanced Setup options</a>.</p>
<b>Enable Master Password Lockout</b>	<p>The <b>Master Password Lockout</b> option allows you to disable the Recovery Password feature. If the system, administrator, or hard drive password is forgotten, the computer becomes unusable.</p> <p><b>i</b> <b>NOTE:</b> When the owner password is set, the Master Password Lockout option is not available.</p> <p><b>i</b> <b>NOTE:</b> When an internal hard drive password is set, it must first be cleared before Master Password Lockout can be changed.</p> <p>By default, the <b>Enable Master Password Lockout</b> option is disabled.</p> <p>Dell Technologies does not recommend enabling the <b>Master Password Lockout</b> unless you have implemented your own password recovery system.</p> <p><b>i</b> <b>NOTE:</b> To view this option, enable <b>Advanced Setup</b> mode as described in <a href="#">View Advanced Setup options</a>.</p>
<b>Enable Allow Non-Admin PSID Revert</b>	<p>The <b>Allow Non-Admin PSID Revert</b> option allows a user to clear the hard drive password without entering the BIOS Admin Password. When an Admin Password</p>

**Table 35. System Setup options—Passwords menu (continued)**

Passwords	
	<p>is set, the ability to enter the PSID is protected by requiring authentication with the Admin Password. If this option is enabled, any user can clear the drive without entering the Admin Password.</p> <p>By default, the <b>Enable Allow Non-Admin PSID Revert</b> option is disabled.</p> <p><b>i</b> <b>NOTE:</b> To view this option, enable <b>Advanced Setup</b> mode as described in <a href="#">View Advanced Setup options</a>.</p>

**Table 36. System Setup options—Update, Recovery menu**

Update, Recovery	
<b>UEFI Capsule Firmware Updates</b>	
Enable UEFI Capsule Firmware Updates	<p>Enables or disables BIOS updates through UEFI capsule update packages.</p> <p><b>i</b> <b>NOTE:</b> Disabling this option blocks the BIOS updates from services such as Microsoft Windows Update and Linux Vendor Firmware Service (LVFS).</p> <p>By default, the <b>Enable UEFI Capsule Firmware Updates</b> option is enabled.</p> <p><b>i</b> <b>NOTE:</b> To view this option, enable <b>Advanced Setup</b> mode as described in <a href="#">View Advanced Setup options</a>.</p>
<b>BIOS Recovery from Hard Drive</b>	<p>Enables or disables the user to recover from certain corrupted BIOS conditions from a recovery file on the user primary hard drive or an external USB drive.</p> <p>By default, the <b>BIOS Recovery from Hard Drive</b> option is enabled.</p> <p><b>i</b> <b>NOTE:</b> BIOS Recovery from Hard Drive is not available for self-encrypting drives (SED).</p> <p><b>i</b> <b>NOTE:</b> BIOS recovery is designed to fix the main BIOS block and cannot work if the Boot Block is damaged. In addition, this feature cannot work in the event of EC corruption, ME corruption, or a hardware issue. The recovery image must exist on an unencrypted partition on the drive.</p> <p><b>i</b> <b>NOTE:</b> To view this option, enable <b>Advanced Setup</b> mode as described in <a href="#">View Advanced Setup options</a>.</p>
<b>BIOS Downgrade</b>	
Allow BIOS Downgrade	<p>Allows downgrading of the system firmware to previous revisions.</p> <p>By default, the <b>Allow BIOS Downgrade</b> option is enabled.</p>
<b>SupportAssist OS Recovery</b>	<p>Enables or disables the boot flow for SupportAssist OS Recovery tool if certain system errors occur.</p> <p>By default, the <b>SupportAssist OS Recovery</b> option is enabled.</p>
<b>BIOSConnect</b>	<p>Enables or disables cloud service operating system recovery if the main operating system fails to boot with the number of failures equal to or greater than the value specified by the Auto operating system Recovery Threshold setup option and local service operating system does not boot or is not installed.</p> <p>By default, the <b>BIOSConnect</b> option is enabled.</p>
<b>Dell Auto OS Recovery Threshold</b>	<p>Allows the control of the automatic boot flow for the SupportAssist System Resolution Console and the Dell operating system Recovery Tool.</p> <p>By default, the <b>Dell Auto OS Recovery Threshold</b> value is set to <b>2</b>.</p> <p><b>i</b> <b>NOTE:</b> To view this option, enable <b>Advanced Setup</b> mode as described in <a href="#">View Advanced Setup options</a>.</p>



**Table 37. System Setup options—System Management menu**

System Management	
<b>Service Tag</b>	Displays the Service Tag of the computer.
<b>Asset Tag</b>	Creates a computer Asset Tag that an IT administrator can use to uniquely identify a particular computer. <b>NOTE:</b> Once set in the BIOS, the Asset Tag cannot be changed.
<b>Wake on AC</b>	Enables or disables the computer to turn on and go to boot when AC power is supplied to the computer. By default, the <b>Wake on AC</b> option is disabled. <b>NOTE:</b> To view this option, enable <b>Advanced Setup</b> mode as described in <a href="#">View Advanced Setup options</a> .
<b>Wake on LAN</b>	Enables or disables the computer to turn on by a special LAN signal. By default, the <b>Wake on LAN</b> option is disabled. <b>NOTE:</b> To view this option, enable <b>Advanced Setup</b> mode as described in <a href="#">View Advanced Setup options</a> .
<b>Auto On Time</b>	Enable to set the computer to turn on automatically every day or on a preselected date and time. This option can be configured only if the Auto On Time is set to Everyday, Weekdays, or Selected Days. By default, the <b>Auto On Time</b> option is disabled. <b>NOTE:</b> To view this option, enable <b>Advanced Setup</b> mode as described in <a href="#">View Advanced Setup options</a> .
<b>Intel AMT capability</b>	Configure Intel Active Management Technology (AMT) options, which can be enabled, disabled, or restricted. <b>NOTE:</b> To view this option, enable <b>Advanced Setup</b> mode as described in <a href="#">View Advanced Setup options</a> .
<b>Diagnostics OS agent requests</b>	Enable or disable the option for applications running in the operating system to run with preboot diagnostics on subsequent boots. <b>NOTE:</b> To view this option, enable <b>Advanced Setup</b> mode as described in <a href="#">View Advanced Setup options</a> .
<b>First Power On Date</b>	Allows you to set ownership date. By default, the <b>First Power On Date</b> option is disabled.
<b>Power-On-Self-Test Automatic Recovery</b>	Enable or disable the automatic recovery of the computer from no power or no-POST failure by applying mitigation steps. By default, the <b>Power-On-Self-Test Automatic Recovery</b> option is enabled. <b>NOTE:</b> To view this option, enable <b>Advanced Setup</b> mode as described in <a href="#">View Advanced Setup options</a> .

**Table 38. System Setup options—Keyboard menu**

Keyboard	
<b>Fn Lock Options</b>	Enables or disables the Fn Lock option. By default, the <b>Fn Lock</b> option is enabled.
<b>Lock Mode</b>	By default, the <b>Lock Mode Secondary</b> option is enabled. With this option, the F1-F12 keys scan the code for their secondary functions.
<b>Keyboard Illumination</b>	Configures the operating mode of the keyboard illumination feature.

**Table 38. System Setup options—Keyboard menu (continued)**

Keyboard	
	By default, the <b>Dim</b> option is selected. Enables the keyboard illumination feature at 100% brightness level.
<b>Keyboard Backlight Timeout on AC</b>	<p>Sets the timeout value for the keyboard backlight when an AC adapter is connected to the computer.</p> <p>By default, the <b>10 seconds</b> option is selected.</p> <p><b>i</b> <b>NOTE:</b> To view this option, enable <b>Advanced Setup</b> mode as described in <a href="#">View Advanced Setup options</a>.</p>
<b>Keyboard Backlight Timeout on Battery</b>	<p>Sets the timeout value for the keyboard backlight when the computer is running only on the battery power. The keyboard backlight timeout value is only effective when the backlight is enabled.</p> <p>By default, the <b>10 seconds</b> option is selected.</p> <p><b>i</b> <b>NOTE:</b> To view this option, enable <b>Advanced Setup</b> mode as described in <a href="#">View Advanced Setup options</a>.</p>
<b>Device Configuration HotKey Access</b>	<p>Allows you to control whether you can access device configuration screens through hotkeys during system startup.</p> <p>By default, the <b>Device Configuration HotKey Access</b> option is enabled.</p> <p><b>i</b> <b>NOTE:</b> This setting controls only the Intel RAID (CTRL+I), MEBX (CTRL+P), and LSI RAID (CTRL+C) Option ROMs. Other preboot Option ROMs, which support entry using a key sequence, are not affected by this setting.</p> <p><b>i</b> <b>NOTE:</b> To view this option, enable <b>Advanced Setup</b> mode as described in <a href="#">View Advanced Setup options</a>.</p>

**Table 39. System Setup options—Pre-boot Behavior menu**

Pre-boot Behavior	
<b>Adapter Warnings</b>	
Enable Dock Warning Messages	<p>Enables the warning messages during boot when the adapters with less power capacity are detected.</p> <p>By default, the <b>Enable Dock Warning Messages</b> option is enabled.</p> <p><b>i</b> <b>NOTE:</b> To view this option, enable <b>Advanced Setup</b> mode as described in <a href="#">View Advanced Setup options</a>.</p>
<b>Warnings and Errors</b>	<p>Enables or disables the action to be taken when a warning or error is encountered.</p> <p>By default, the <b>Prompt on Warnings and Errors</b> option is selected. Stop, prompt, and wait for user input when warnings or errors are detected.</p> <p><b>i</b> <b>NOTE:</b> Errors deemed critical to the operation of the computer hardware stop the functioning of the computer.</p> <p><b>i</b> <b>NOTE:</b> To view this option, enable <b>Advanced Setup</b> mode as described in <a href="#">View Advanced Setup options</a>.</p>
<b>Extend BIOS POST Time</b>	<p>Sets the BIOS POST (Power-On Self-Test) load time.</p> <p>By default, the <b>0 seconds</b> option is selected.</p> <p><b>i</b> <b>NOTE:</b> To view this option, enable <b>Advanced Setup</b> mode as described in <a href="#">View Advanced Setup options</a>.</p>
<b>MAC Address Pass-Through</b>	Replaces the external NIC MAC address (in a supported dock or dongle) with the selected MAC address from the computer.

**Table 39. System Setup options—Pre-boot Behavior menu (continued)**

<b>Pre-boot Behavior</b>	
	By default, the <b>System Unique MAC Address</b> option is selected.
<b>Sign of Life</b>	
Early Logo Display	Displays the Logo Sign of Life. By default, the <b>Early Logo Display</b> option is enabled. <b>i</b> <b>NOTE:</b> To view this option, enable <b>Advanced Setup</b> mode as described in <a href="#">View Advanced Setup options</a> .
Early Keyboard Backlight	Enables or disables the Keyboard Backlight Sign of Life. By default, the <b>Early Keyboard Backlight</b> option is enabled. <b>i</b> <b>NOTE:</b> To view this option, enable <b>Advanced Setup</b> mode as described in <a href="#">View Advanced Setup options</a> .
<b>Collaboration Touchpad</b>	This field allows you to enable the collaboration features of the Collaboration Touchpad. By default, the <b>Collaboration Touchpad</b> option is enabled.

**Table 40. System Setup options—Virtualization menu**

<b>Virtualization Support</b>	
<b>Intel Virtualization Technology</b>	
Enable Intel Virtualization Technology (VT)	When enabled, the computer can run a Virtual Machine Monitor (VMM). By default, the <b>Enable Intel Virtualization Technology (VT)</b> option is enabled. <b>i</b> <b>NOTE:</b> To view this option, enable <b>Advanced Setup</b> mode as described in <a href="#">View Advanced Setup options</a> .
<b>VT for Direct I/O</b>	
Enable Intel VT for Direct I/O	When enabled, the computer can perform Virtualization Technology for Direct I/O (VT-d). VT-d is an Intel method that provides virtualization for memory map I/O. By default, the <b>Enable Intel VT for Direct I/O</b> option is enabled. <b>i</b> <b>NOTE:</b> To view this option, enable <b>Advanced Setup</b> mode as described in <a href="#">View Advanced Setup options</a> .
<b>Intel Trusted Execution Technology (TXT)</b>	Specifies whether a measured Virtual Machine Monitor (MVMM) can use the additional hardware capabilities provided by Intel Trusted Execution Technology. The following must be enabled in order to enable Intel TXT - <ul style="list-style-type: none"> <li>● Trusted Platform Module (TPM)</li> <li>● Intel Hyper-Threading</li> <li>● All CPU cores (Multi-Core Support)</li> <li>● Intel Virtualization Technology</li> <li>● Intel VT for Direct I/O</li> </ul> By default, the <b>Intel Trusted Execution Technology (TXT)</b> option is disabled. <b>i</b> <b>NOTE:</b> To view this option, enable <b>Advanced Setup</b> mode as described in <a href="#">View Advanced Setup options</a> .
<b>DMA Protection</b>	
Enable Pre-Boot DMA Support	Allows you to control the Pre-Boot DMA protection for both internal and external ports. This option does not directly enable DMA protection in the operating system.





**Table 40. System Setup options—Virtualization menu (continued)**

<b>Virtualization Support</b>	
	<p><b>i</b> <b>NOTE:</b> This option is not available when the virtualization setting for IOMMU is disabled (VT-d/AMD Vi).</p> <p>By default, the <b>Enable Pre-Boot DMA Support</b> option is enabled.</p> <p>For additional security, Dell Technologies recommends keeping the <b>Enable Pre-Boot DMA Support</b> option enabled.</p> <p><b>i</b> <b>NOTE:</b> This option is provided only for compatibility purposes, since some older hardware is not DMA capable.</p> <p><b>i</b> <b>NOTE:</b> To view this option, enable <b>Advanced Setup</b> mode as described in <a href="#">View Advanced Setup options</a>.</p>
Enable OS Kernel DMA Support	<p>Allows you to control the Kernel DMA protection for both internal and external ports. This option does not directly enable DMA protection in the operating system. For operating systems that support DMA protection, this setting indicates to the operating system that the BIOS supports the feature.</p> <p><b>i</b> <b>NOTE:</b> This option is not available when the virtualization setting for IOMMU is disabled (VT-d/AMD Vi).</p> <p>By default, the <b>Enable OS Kernel DMA Support</b> option is enabled.</p> <p><b>i</b> <b>NOTE:</b> This option is provided only for compatibility purposes, since some older hardware is not DMA capable.</p> <p><b>i</b> <b>NOTE:</b> To view this option, enable <b>Advanced Setup</b> mode as described in <a href="#">View Advanced Setup options</a>.</p>
Internal Port DMA Compatibility Mode	<p>Allows you to control the Internal Port DMA Compatibility for both internal and external ports.</p> <p>By default, the <b>Internal Port DMA Compatibility Mode</b> option is disabled.</p> <p><b>i</b> <b>NOTE:</b> To view this option, enable <b>Advanced Setup</b> mode as described in <a href="#">View Advanced Setup options</a>.</p>



**Table 41. System Setup options—Performance menu**

<b>Performance</b>	
<b>Multi-Core Support</b>	
Multiple Atom Cores	<p>Change the number of Atom cores available to the operating system. The default value is set to the maximum number of cores.</p> <p>By default, the <b>All Cores</b> option is selected.</p> <p><b>i</b> <b>NOTE:</b> To view this option, enable <b>Advanced Setup</b> mode as described in <a href="#">View Advanced Setup options</a>.</p>
<b>Intel SpeedStep</b>	
Enable Intel SpeedStep Technology	<p>Enables the computer to dynamically adjust processor voltage and core frequency, decreasing average power consumption and heat production.</p> <p>By default, the <b>Enable Intel SpeedStep Technology</b> option is enabled.</p> <p><b>i</b> <b>NOTE:</b> To view this option, enable <b>Service</b> options as described in <a href="#">View Service options</a>.</p>
<b>C-State Control</b>	
Enable C-State Control	<p>Enables or disables the ability of the CPU to enter and exit low-power state. When disabled, it disables all C-states. When enabled, it enables all C-states that the chipset or platform allows.</p> <p>By default, the <b>Enable C-State Control</b> option is enabled.</p>

**Table 41. System Setup options—Performance menu (continued)**

<b>Performance</b>	
<p> <b>NOTE:</b> To view this option, enable <b>Advanced Setup</b> mode as described in <a href="#">View Advanced Setup options</a>.</p>	
<b>Intel Turbo Boost Technology</b>	
Enable Intel Turbo Boost Technology	<p>Enables or disables the Intel TurboBoost mode of the processor. When enabled, the Intel TurboBoost driver increases the performance of the CPU or graphics processor.</p> <p>By default, the <b>Enable Intel Turbo Boost Technology</b> option is enabled.</p> <p> <b>NOTE:</b> To view this option, enable <b>Advanced Setup</b> mode as described in <a href="#">View Advanced Setup options</a>.</p>
<b>Intel Hyper-Threading Technology</b>	
Enable Intel Hyper-Threading Technology	<p>Enables or disables the Intel Hyper-Threading mode of the processor. When enabled, the Intel Hyper-Threading increases the efficiency of the processor resources when multiple threads run on each core.</p> <p>By default, the <b>Intel Hyper-Threading Technology</b> option is enabled.</p> <p> <b>NOTE:</b> To view this option, enable <b>Advanced Setup</b> mode as described in <a href="#">View Advanced Setup options</a>.</p>
<b>Dynamic Tuning: Machine Learning</b>	
Enable Dynamic Tuning: Machine Learning	<p>Enables or disables operating system capability to enhance power tuning capabilities depending on the detected workloads.</p> <p> <b>NOTE:</b> This option is available for development only and is not customer visible.</p> <p>By default, the <b>Enable Dynamic Tuning: Machine Learning</b> option is disabled.</p>

**Table 42. System Setup options—System Logs menu**

<b>System Logs</b>	
<b>BIOS Event Log</b>	
Clear BIOS Event Log	<p>Select the option to keep or clear BIOS events logs.</p> <p>By default, the <b>Keep Log</b> option is selected.</p> <p> <b>NOTE:</b> To view this option, enable <b>Advanced Setup</b> mode as described in <a href="#">View Advanced Setup options</a>.</p>
<b>Thermal Event Log</b>	
Clear Thermal Event Log	<p>Select the option to keep or clear Thermal events logs.</p> <p>By default, the <b>Keep Log</b> option is selected.</p> <p> <b>NOTE:</b> To view this option, enable <b>Advanced Setup</b> mode as described in <a href="#">View Advanced Setup options</a>.</p>
<b>Power Event Log</b>	
Clear Power Event Log	<p>Select the option to keep or clear Power events logs.</p> <p>By default, the <b>Keep Log</b> option is selected.</p> <p> <b>NOTE:</b> To view this option, enable <b>Advanced Setup</b> mode as described in <a href="#">View Advanced Setup options</a>.</p>

# Updating the BIOS

## Updating the BIOS in Windows

### Steps

1. Go to [www.dell.com/support](http://www.dell.com/support).
2. Click **Product support**. In the **Search support** box, enter the Service Tag of your computer, and then click **Search**.  
 **NOTE:** If you do not have the Service Tag, use the SupportAssist feature to automatically identify your computer. You can also use the product ID or manually browse for your computer model.
3. Click **Drivers & Downloads**. Expand **Find drivers**.
4. Select the operating system installed on your computer.
5. In the **Category** drop-down list, select **BIOS**.
6. Select the latest version of BIOS, and click **Download** to download the BIOS file for your computer.
7. After the download is complete, browse the folder where you saved the BIOS update file.
8. Double-click the BIOS update file icon and follow the on-screen instructions.  
For more information about how to update the system BIOS, search in the Knowledge Base Resource at [www.dell.com/support](http://www.dell.com/support).

## Updating the BIOS using the USB drive in Windows

### Steps

1. Follow the procedure from step 1 to step 6 in [Updating the BIOS in Windows](#) to download the latest BIOS setup program file.
2. Create a bootable USB drive. For more information, search the Knowledge Base Resource at [www.dell.com/support](http://www.dell.com/support).
3. Copy the BIOS setup program file to the bootable USB drive.
4. Connect the bootable USB drive to the computer that needs the BIOS update.
5. Restart the computer and press **F12**.
6. Select the USB drive from the **One Time Boot Menu**.
7. Type the BIOS setup program filename and press **Enter**.  
The **BIOS Update Utility** appears.
8. Follow the on-screen instructions to complete the BIOS update.

## Updating the BIOS from the F12 One Time Boot menu

Update your computer BIOS using the BIOS update.exe file that is copied to a FAT32 USB drive and booting from the F12 **One Time Boot** menu.

### About this task

#### BIOS Update

You can run the BIOS update file from Windows using a bootable USB drive or you can also update the BIOS from the F12 **One Time Boot** menu on the computer.

Most of the Dell computers built after 2012 have this capability, and you can confirm by booting your computer to the F12 **One Time Boot** Menu to see if BIOS FLASH UPDATE is listed as a boot option for your computer. If the option is listed, then the BIOS supports this BIOS update option.

 **NOTE:** Only computers with the BIOS Flash Update option in the F12 **One Time Boot** menu can use this function.

#### Updating from the One Time Boot menu

To update your BIOS from the F12 **One Time Boot** menu, you need the following:

- USB drive formatted to the FAT32 file system (key does not have to be bootable)

- BIOS executable file that you downloaded from the Dell Support website and copied to the root of the USB drive
- AC power adapter that is connected to the computer
- Functional computer battery to flash the BIOS

Perform the following steps to perform the BIOS update flash process from the F12 menu:

 **CAUTION: Do not turn off the computer during the BIOS update process. The computer may not boot if you turn off your computer.**

### Steps

1. From a turn off state, insert the USB drive where you copied the flash into a USB port of the computer.
2. Turn on the computer and press F12 to access the **One Time Boot** Menu, select BIOS Update using the mouse or arrow keys then press Enter.  
The flash BIOS menu is displayed.
3. Click **Flash from file**.
4. Select an external USB device.
5. Select the file and double-click the flash target file, and then click **Submit**.
6. Click **Update BIOS**. The computer restarts to flash the BIOS.
7. The computer will restart after the BIOS update is completed.

## System and setup password

**Table 43. System and setup password**

Password type	Description
System password	Password that you must enter to log in to your system.
Setup password	Password that you must enter to access and make changes to the BIOS settings of your computer.

You can create a system password and a setup password to secure your computer.

 **CAUTION: The password features provide a basic level of security for the data on your computer.**

 **CAUTION: Anyone can access the data that is stored on your computer, when not locked and left unattended.**

 **NOTE:** System and setup password feature is disabled.

## Assigning a System Setup password

### Prerequisites

You can assign a new System or Admin Password only when the status is in **Not Set**.

### About this task

To enter BIOS System Setup, press F2 immediately after a power-on or reboot.

### Steps

1. In the **System BIOS** or **System Setup** screen, select **Security** and press Enter.  
The **Security** screen is visible.
2. Select **System/Admin Password** and create a password in the **Enter the new password** field.  
Use the following guidelines to assign the system password:
  - A password can have up to 32 characters.
  - At least one special character: "( ! " # \$ % & ' \* + , - . / : ; < = > ? @ [ \ ] ^ \_ ` { | } )"
  - Numbers 0 to 9.
  - Upper case letters from A to Z.

- Lower case letters from a to z.
3. Type the system password that you entered earlier in the **Confirm new password** field and click **OK**.
  4. Press Esc and save the changes as prompted by the message.
  5. Press Y to save the changes.  
The computer restarts.

## Deleting or changing an existing system setup password

### Prerequisites

Ensure that the **Password Status** is Unlocked (in the System Setup) before attempting to delete or change the existing System and/or Setup password. You cannot delete or change an existing System or Setup password, if the **Password Status** is Locked.

### About this task

To enter the System Setup, press F2 immediately after a power-on or reboot.

### Steps

1. In the **System BIOS** or **System Setup** screen, select **System Security** and press Enter.  
The **System Security** screen is displayed.
2. In the **System Security** screen, verify that the Password Status is **Unlocked**.
3. Select **System Password**, update, or delete the existing system password, and press Enter or Tab.
4. Select **Setup Password**, update, or delete the existing setup password, and press Enter or Tab.  
 **NOTE:** If you change the System and/or Setup password, reenter the new password when prompted. If you delete the System and/or Setup password, confirm the deletion when prompted.
5. Press Esc. A message prompts you to save the changes.
6. Press Y to save the changes and exit from System Setup.  
The computer restarts.

## Clearing Chassis Intrusion Alert

The system features a chassis intrusion switch which can detect whenever the base cover has been removed from the system.

Alerts to notify you of any intrusions can be enabled through the **Chassis Intrusion** field in the **Security** sub-menu of the BIOS setup menu.

When enabled, the **Block Boot Until Cleared** field allows you to choose whether to prevent normal boot up of the system until the intrusion alert is cleared.



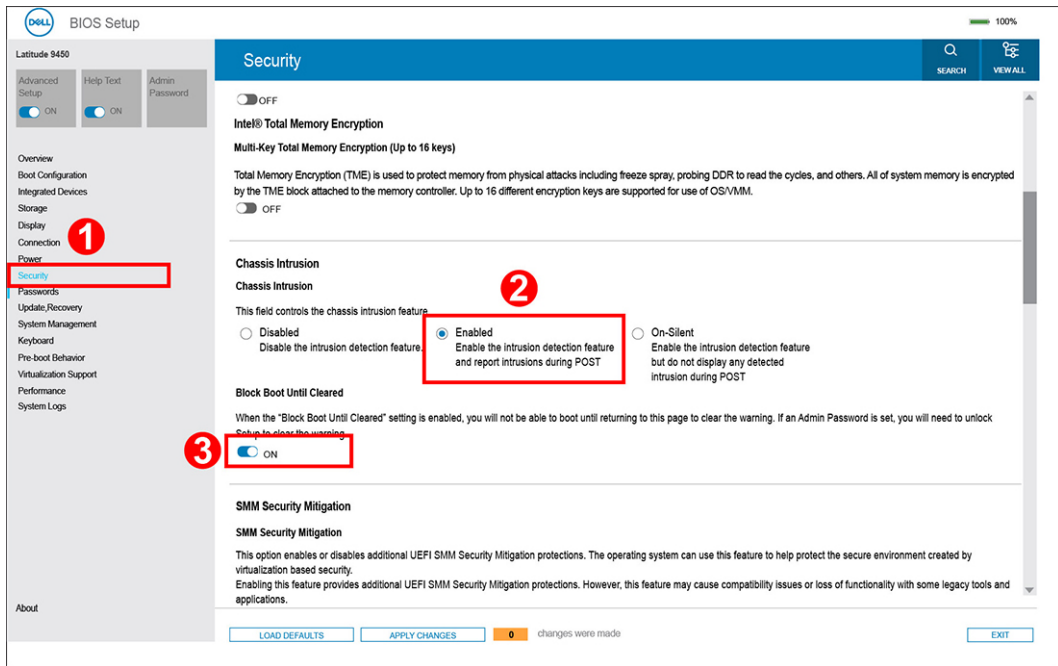

Figure 70. Security tab

- If **Block Boot Until Cleared** is set to **ON**, the user must select BIOS-Setup and clear the intrusion alert in order to boot.

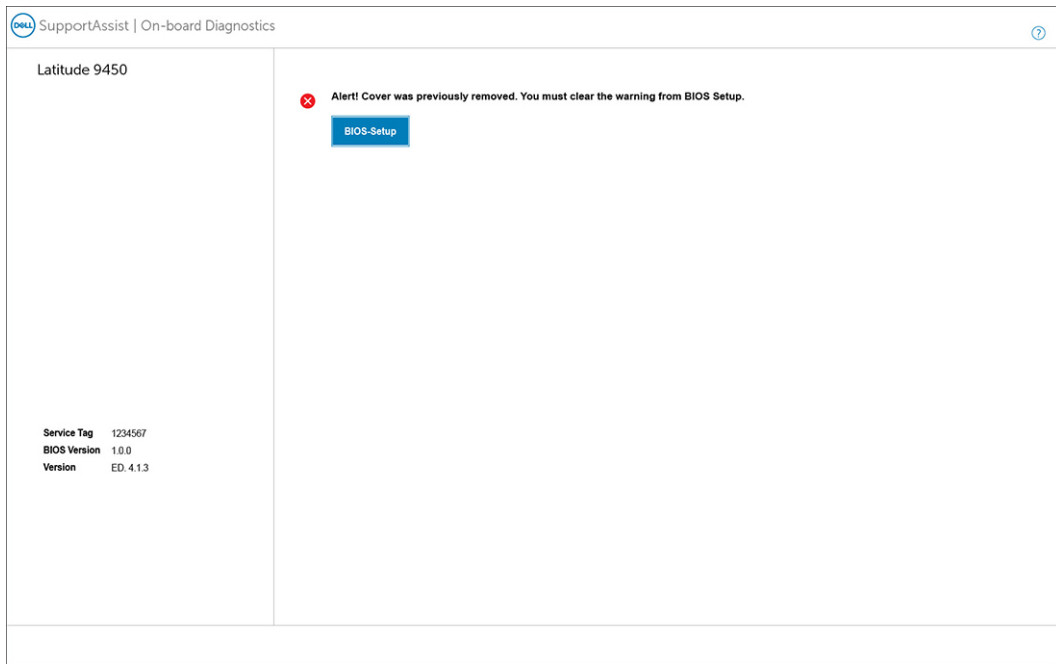

Figure 71. Block Boot Until Cleared is set to ON

- If **Block Boot Until Cleared** is set to **OFF**, select **Continue** to boot or BIOS-Setup to clear the alert.

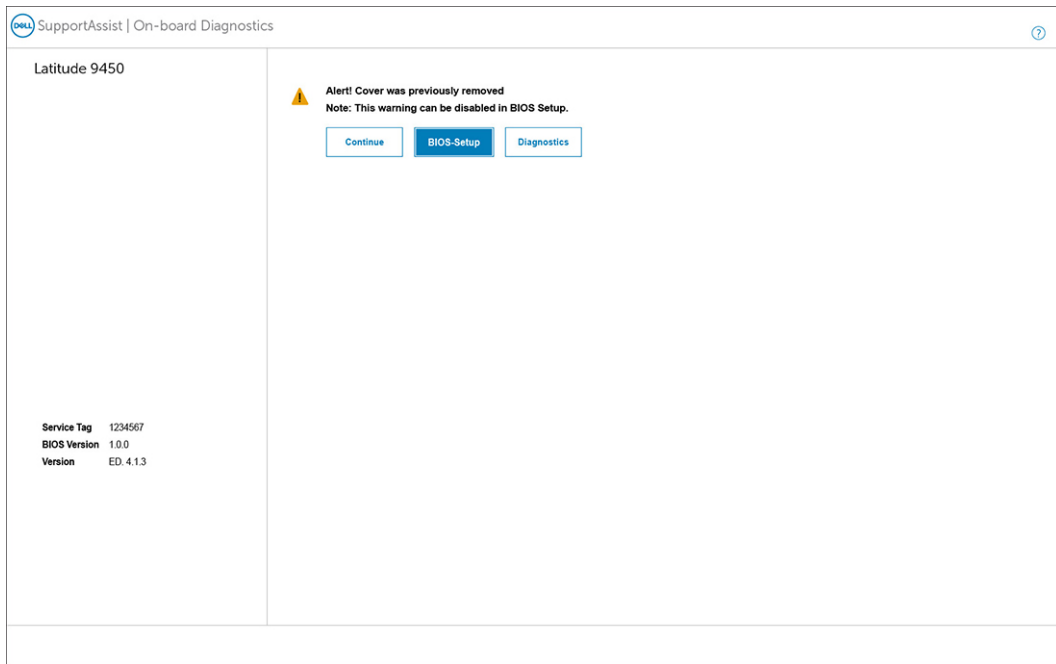

Figure 72. Block Boot Until Cleared is set to OFF

**NOTE:** If **Continue** is selected, the user continues to see the alert each time the system is powered on until the alert is cleared.

To clear the alert, select **ON** in the **Clear Intrusion Warning** field in the **Security** sub-menu of the BIOS setup menu.

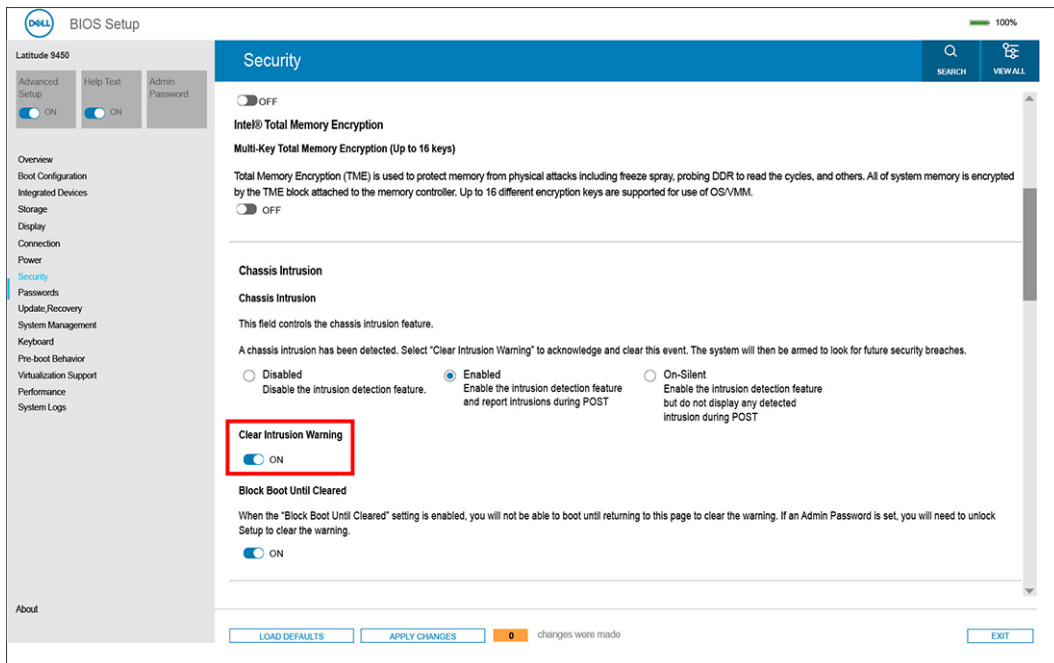

Figure 73. Clear Intrusion Warning

## Clearing CMOS settings

### About this task

**CAUTION:** Clearing CMOS settings resets the BIOS settings on your computer.

### Steps

1. Remove the [base cover](#).
2. Remove the [battery](#).
3. Wait for one minute.
4. Replace the [battery](#).
5. Replace the [base cover](#).

## Clearing BIOS (System Setup) and System passwords

### About this task

To clear the system or BIOS passwords, contact Dell technical support as described at [www.dell.com/contactdell](http://www.dell.com/contactdell).

 **NOTE:** For information about how to reset Windows or application passwords, see the documentation accompanying Windows or your application.

# Troubleshooting

## Handling swollen rechargeable Li-ion batteries

Like most laptops, Dell laptops use Lithium-ion batteries. One type of Lithium-ion battery is the rechargeable Li-ion battery. Rechargeable Li-ion batteries have increased in popularity in recent years and have become standard in the electronics industry due to customer preferences for a slim form factor (especially with newer ultra-thin laptops) and long battery life. Inherent to rechargeable Li-ion battery technology is the potential for swelling of the battery cells.

A swollen battery may impact the performance of the laptop. To prevent possible further damage to the device enclosure or internal components leading to malfunction, discontinue the use of the laptop and discharge it by disconnecting the AC adapter and letting the battery drain.

Swollen batteries should not be used and should be replaced and disposed of properly. We recommend contacting Dell product support for options to replace a swollen battery under the terms of the applicable warranty or service contract, including options for replacement by a Dell authorized service technician.

The guidelines for handling and replacing rechargeable Li-ion batteries are as follows:

- Exercise caution when handling rechargeable Li-ion batteries.
- Discharge the battery before removing it from the system. To discharge the battery, unplug the AC adapter from the system and operate the system only on battery power. When the system will no longer turn on when the power button is pressed, the battery is fully discharged.
- Do not crush, drop, mutilate, or penetrate the battery with foreign objects.
- Do not expose the battery to high temperatures, or disassemble battery packs and cells.
- Do not apply pressure to the surface of the battery.
- Do not bend the battery.
- Do not use tools of any type to pry on or against the battery.
- If a battery gets stuck in a device as a result of swelling, do not try to free it as puncturing, bending, or crushing a battery can be dangerous.
- Do not attempt to reassemble a damaged or swollen battery into a laptop.
- Swollen batteries that are covered under warranty should be returned to Dell in an approved shipping container (provided by Dell)—this is to comply with transportation regulations. Swollen batteries that are not covered under warranty should be disposed of at an approved recycling center. Contact Dell product support at <https://www.dell.com/support> for assistance and further instructions.
- Using a non-Dell or incompatible battery may increase the risk of fire or explosion. Replace the battery only with a compatible battery purchased from Dell that is designed to work with your Dell computer. Do not use a battery from other computers with your computer. Always purchase genuine batteries from <https://www.dell.com> or otherwise directly from Dell.

Rechargeable Li-ion batteries can swell for various reasons such as age, number of charge cycles, or exposure to high heat. For more information about how to improve the performance and lifespan of the laptop battery and to minimize the possibility of occurrence of the issue, search Dell Laptop Battery in the Knowledge Base Resource at [www.dell.com/support](http://www.dell.com/support).

## Locate the Service Tag or Express Service Code of your Dell computer

Your Dell computer is uniquely identified with a Service Tag or Express Service Code. To view relevant support resources for your Dell computer, we recommend entering the Service Tag or Express Service Code at [www.dell.com/support](http://www.dell.com/support).

For more information about how to find the Service Tag for your computer, see [Locate the Service Tag on your computer](#).

# Dell SupportAssist Pre-boot System Performance Check diagnostics

## About this task

SupportAssist diagnostics (also known as system diagnostics) performs a complete check of your hardware. The Dell SupportAssist Pre-boot System Performance Check diagnostics is embedded with the BIOS and launched by the BIOS internally. The embedded system diagnostics provides options for particular devices or device groups allowing you to:

- Run tests automatically or in an interactive mode.
- Repeat the tests.
- Display or save test results.
- Run thorough tests to introduce additional test options to provide extra information about one or more failed devices.
- View status messages that inform you the tests are completed successfully.
- View error messages that inform you of problems encountered during testing.

 **NOTE:** Some tests for specific devices require user interaction. Always ensure that you are present at the computer terminal when the diagnostic tests are performed.

For more information, see the knowledge base article [000180971](#).

## Running the SupportAssist Pre-Boot System Performance Check

### Steps

1. Turn on your computer.
2. As the computer boots, press the F12 key as the Dell logo appears.
3. On the boot menu screen, select the **Diagnostics** option.
4. Click the arrow at the bottom left corner.  
Diagnostics front page is displayed.
5. Click the arrow in the lower-right corner to go to the page listing.  
The items that are detected are listed.
6. To run a diagnostic test on a specific device, press Esc and click **Yes** to stop the diagnostic test.
7. Select the device from the left pane and click **Run Tests**.
8. If there are any issues, error codes are displayed.  
Note the error code and validation number and contact Dell.

## Built-in self-test (BIST)

### M-BIST

M-BIST (Built In Self-Test) is the system board built-in self-test diagnostics tool that improves the diagnostics accuracy of system board Embedded Controller (EC) failures.

 **NOTE:** M-BIST can be manually initiated before Power On Self-Test (POST).

### How to run M-BIST

 **NOTE:** M-BIST must be initiated on the computer from a power-off state that is either connected to AC power or with a battery only.

1. Press and hold both the **M** key on the keyboard and the **power button** to initiate M-BIST.
2. The battery indicator LED may exhibit two states:
  - a. OFF: No fault was detected with the system board.
  - b. AMBER: Amber indicates a problem with the system board.

- If there is a failure with the system board, the battery status LED flashes one of the following error codes for 30 seconds:

**Table 44. LED error codes**

Blinking Pattern		Possible Problem
Amber	White	
2	1	CPU Failure
2	8	LCD Power Rail Failure
1	1	TPM Detection Failure
2	4	Memory/RAM failure

- If there is no failure with the system board, the LCD cycles through the solid color screens that are described in the LCD-BIST section for 30 seconds and then turn off.

## LCD Power rail test (L-BIST)

L-BIST is an enhancement to the single LED error code diagnostics and is automatically initiated during POST. L-BIST will check the LCD power rail. If there is no power being supplied to the LCD (that is if the L-BIST circuit fails), the battery status LED flashes either an error code [2,8] or an error code [2,7].

**NOTE:** If L-BIST fails, LCD-BIST cannot function as no power will be supplied to the LCD.

### How to invoke the L-BIST Test:

- Press the power button to start the computer.
- If the computer does not start up normally, look at the battery status LED:
  - If the battery status LED flashes an error code [2,7], the display cable may not be connected properly.
  - If the battery status LED flashes an error code [2,8], there is a failure on the LCD power rail of the system board, hence there is no power that is supplied to the LCD.
- For cases, when a [2,7] error code is shown, check to see if the display cable is properly connected.
- For cases when a [2,8] error code is shown, replace the system board.

## LCD Built-in Self-Test (BIST)

Dell laptops have a built-in diagnostic tool that helps you determine if the screen abnormality you are experiencing is an inherent problem with the LCD (screen) of the Dell laptop or with the video card (GPU) and computer settings.

When you notice screen abnormalities like flickering, distortion, clarity issues, fuzzy or blurry image, horizontal or vertical lines, color fade and so on, it is always a good practice to isolate the LCD (screen) by running the Built-In Self-Test (BIST).

### How to invoke the LCD BIST Test

- Power off the Dell laptop.
- Disconnect any peripherals that are connected to the laptop. Connect only the AC adapter (charger) to the laptop.
- Ensure that the LCD (screen) is clean (no dust particles on the surface of the screen).
- Press and hold the **D** key and **Power on** the laptop to enter LCD built-in self-test (BIST) mode. Continue to hold the D key until the computer boots up.
- The screen displays solid colors and change colors on the entire screen to white, black, red, green, and blue twice.
- Then it displays the colors white, black, and red.
- Carefully inspect the screen for abnormalities (any lines, fuzzy color, or distortion on the screen).
- At the end of the last solid color (red), the computer shuts down.

**NOTE:** Dell SupportAssist Preboot diagnostics upon launch initiates an LCD BIST first, expecting a user intervention to confirm functionality of the LCD.

# System-diagnostic lights

This section lists the system-diagnostic lights of your Latitude 9450 2-in-1.

## Battery-status light

Indicates the power and battery-charge status.

**Solid white**—Power adapter is connected and the battery has more than 5 percent charge.

**Amber**—Computer is running on battery and the battery has less than 5 percent charge.

### Off

- Power adapter is connected and the battery is fully charged.
- Computer is running on battery and the battery has more than 5 percent charge.
- Computer is in sleep state, hibernation, or turned off.

The power and battery-status light blinks amber along with beep codes indicating failures.

For example, the power and battery-status light blinks amber two times followed by a pause, and then blinks white three times.

Followed by a pause. This 2,3 pattern continues until the computer is turned off indicating no memory or RAM is detected.

**Table 45. System-diagnostic lights**

Blinking pattern		Problem description	Suggested resolution
Amber	White		
1	1	TPM detection failure	Replace the system board.
1	2	Unrecoverable SPI Flash Failure	Replace the system board.
1	5	EC unable to program i-Fuse	Replace the system board.
1	6	Generic catch-all for ungraceful EC code flow errors	Disconnect all power source (AC, battery, coin cell) and drain flea power by pressing and holding down the power button for 3~5 seconds.
2	1	CPU failure	<ul style="list-style-type: none"> <li>• Run the Dell SupportAssist or Dell Diagnostics tool.</li> <li>• If the problem persists, replace the system board.</li> </ul>
2	2	System board failure (included BIOS corruption or ROM error)	<ul style="list-style-type: none"> <li>• Flash latest BIOS version</li> <li>• If the problem persists, replace the system board.</li> </ul>
2	3	No memory or RAM detected	<ul style="list-style-type: none"> <li>• Confirm that the memory module is installed properly.</li> <li>• If the problem persists, replace the memory module.</li> </ul>
2	4	Memory or RAM failure	<ul style="list-style-type: none"> <li>• Reset and swap memory modules among the slots.</li> <li>• If the problem persists, replace the memory module.</li> </ul>
2	5	Invalid memory installed	<ul style="list-style-type: none"> <li>• Reset and swap memory modules among the slots.</li> <li>• If the problem persists, replace the memory module.</li> </ul>

**Table 45. System-diagnostic lights (continued)**

Blinking pattern		Problem description	Suggested resolution
Amber	White		
2	6	System board or Chipset Error	Replace the system board.
2	7	LCD failure (SBIOS message)	Replace the LCD module.
2	8	LCD failure (EC detection of power rail failure)	Replace the system board.
3	1	CMOS battery failure	<ul style="list-style-type: none"> <li>Reset the main battery connection.</li> <li>If the problem persists, replace the main battery.</li> </ul>
3	2	PCI or Video card or chip failure	Replace the system board.
3	3	BIOS Recovery image not found	<ul style="list-style-type: none"> <li>Flash latest BIOS version</li> <li>If the problem persists, replace the system board.</li> </ul>
3	4	BIOS Recovery image found but invalid	<ul style="list-style-type: none"> <li>Flash latest BIOS version</li> <li>If the problem persists, replace the system board.</li> </ul>
3	5	Power rail failure	Replace the system board.
3	6	Flash corruption is detected by SBIOS.	<ul style="list-style-type: none"> <li>Press the power button for over 25 seconds to do RTC reset. If the problem persists, replace the system board.</li> <li>Disconnect all power source (AC, battery, coin cell) and drain flea power by pressing and holding down the power button 3~5 seconds to ensure all power are drained.</li> <li>Run "BIOS recovery from USB", and the instructions are in the website <a href="#">Dell support</a>.</li> <li>If the problem persists, replace the system board.</li> </ul>
3	7	Timeout waiting on ME to reply to HECI message.	Replace the system board.

**NOTE:** Blinking 3-3-3 LEDs on Lock LED (Caps-Lock or Num-Lock), Power button LED (without Fingerprint reader), and Diagnostic LED indicates failure to provide input during LCD panel test on Dell SupportAssist Pre-boot System Performance. Check diagnostics.

## Recovering the operating system

When your computer is unable to boot to the operating system even after repeated attempts, it automatically starts Dell SupportAssist OS Recovery.

Dell SupportAssist OS Recovery is a stand-alone tool that is preinstalled in all Dell computers that are installed with the Windows operating system. It consists of tools to diagnose and troubleshoot issues that may occur before your computer boots to the



operating system. It enables you to diagnose hardware issues, repair your computer, back up your files, or restore your computer to its factory state.

You can also download it from the Dell Support website to troubleshoot and fix your computer when it fails to boot into their primary operating system due to software or hardware failures.

For more information about the Dell SupportAssist OS Recovery, see *Dell SupportAssist OS Recovery User's Guide* at [www.dell.com/serviceabilitytools](http://www.dell.com/serviceabilitytools). Click **SupportAssist** and then, click **SupportAssist OS Recovery**.

## Recovering the operating system

When your Chromebook operating system is not working properly, you can recover it. Recovery is removing and reinstalling the operating system.

To know how to recover your Chromebook operating system, see [Recover your Chromebook](https://support.google.com/chromebook) at <https://support.google.com/chromebook>.

## Real-Time Clock (RTC Reset)

The Real Time Clock (RTC) reset function allows you or the service technician to recover Dell computers from No POST/No Power/No Boot situations. The legacy jumper enabled RTC reset has been retired on these models.

Start the RTC reset with the computer powered off and connected to AC power. Press and hold the power button for thirty (30) seconds

. The computer RTC Reset occurs after you release the power button.

## Backup media and recovery options

It is recommended to create a recovery drive to troubleshoot and fix problems that may occur with Windows. Dell proposes multiple options for recovering the Windows operating system on your Dell computer. For more information, see [Dell Windows Backup Media and Recovery Options](#).

## Wi-Fi power cycle

### About this task

If your computer is unable to access the Internet due to Wi-Fi connectivity issues a Wi-Fi power cycle procedure may be performed. The following procedure provides the instructions on how to conduct a Wi-Fi power cycle:

 **NOTE:** Some Internet Service Providers (ISPs) provide a modem or router combo device.

### Steps

1. Turn off your computer.
2. Turn off the modem.
3. Turn off the wireless router.
4. Wait for 30 seconds.
5. Turn on the wireless router.
6. Turn on the modem.
7. Turn on your computer.

# Drain residual flea power (perform hard reset)

## About this task

Flea power is the residual static electricity that remains in the computer even after it has been powered off and the battery is removed.

For your safety, and to protect the sensitive electronic components in your computer, you are requested to drain residual flea power before removing or replacing any components in your computer.

Draining residual flea power, also known as a performing a "hard reset", is also a common troubleshooting step if your computer does not turn on or boot into the operating system.

## Procedure to drain residual flea power (perform a hard reset)

### Steps

1. Turn off your computer.
2. Disconnect the power adapter from your computer.
3. Remove the base cover.
4. Remove the battery.
5. Press and hold the power button for 20 seconds to drain the flea power.
6. Install the battery.
7. Install the base cover.
8. Connect the power adapter to your computer.
9. Turn on your computer.

 **NOTE:** For more information about performing a hard reset, search in the Knowledge Base Resource at [www.dell.com/support](http://www.dell.com/support).

# Getting help and contacting Dell

## Self-help resources

You can get information and help on Dell products and services using these self-help resources:

**Table 46. Self-help resources**

Self-help resources	Resource location
Information about Dell products and services	<a href="http://www.dell.com">www.dell.com</a>
Tips	
Contact Support	In Windows search, type <code>Contact Support</code> , and press Enter.
Online help for operating system	<a href="http://www.dell.com/support/windows">www.dell.com/support/windows</a> <a href="http://www.dell.com/support/linux">www.dell.com/support/linux</a>
Access top solutions, diagnostics, drivers and downloads, and learn more about your computer through videos, manuals, and documents.	Your Dell computer is uniquely identified by a Service Tag or Express Service Code. To view relevant support resources for your Dell computer, enter the Service Tag or Express Service Code at <a href="http://www.dell.com/support">www.dell.com/support</a> .  For more information about how to find the Service Tag for your computer, see <a href="#">Locate the Service Tag on your computer</a> .
Dell knowledge base articles	<ol style="list-style-type: none"> <li>1. Go to <a href="http://www.dell.com/support">www.dell.com/support</a>.</li> <li>2. On the menu bar at the top of the Support page, select <b>Support &gt; Knowledge Base</b>.</li> <li>3. In the Search field on the Knowledge Base page, type the keyword, topic, or model number, and then click or tap the search icon to view the related articles.</li> </ol>

## Contacting Dell

To contact Dell for sales, technical support, or customer service issues, see [www.dell.com/contactdell](http://www.dell.com/contactdell).

 **NOTE:** Availability varies by country/region and product, and some services may not be available in your country/region.

 **NOTE:** If you do not have an active Internet connection, you can find contact information about your purchase invoice, packing slip, bill, or Dell product catalog.