

XPS 13 9340

Owner's Manual

Notes, cautions, and warnings

 **NOTE:** A NOTE indicates important information that helps you make better use of your product.

 **CAUTION:** A CAUTION indicates either potential damage to hardware or loss of data and tells you how to avoid the problem.

 **WARNING:** A WARNING indicates a potential for property damage, personal injury, or death.

Chapter 1: Views of XPS 13 9340	6
Right	6
Left	6
Top	7
Active areas of the touchpad	8
Display	9
Bottom	10
Service Tag	10
Battery charge and status light	11
Chapter 2: Set up your XPS 13 9340	12
Chapter 3: Specifications of XPS 13 9340	14
Dimensions and weight	14
Processor	14
Chipset	15
Operating system	15
Memory	15
External ports	16
Internal slots	16
Wireless module	16
Audio	17
Storage	18
Keyboard	18
Keyboard shortcuts of XPS 13 9340	18
Camera	19
Touchpad	20
Power adapter	20
Battery	21
Display	22
Fingerprint reader	22
Fingerprint reader	23
Sensor	23
GPU—Integrated	23
Multiple display support matrix	24
Hardware security	24
Operating and storage environment	24
Dell support policy	25
Dell low blue light display	25
Chapter 4: Working inside your computer	26
Safety instructions	26
Before working inside your computer	26
Safety precautions	27

Electrostatic discharge—ESD protection.....	27
ESD Field Service kit	28
Transporting sensitive components.....	29
After working inside your computer.....	29
BitLocker.....	29
Recommended tools.....	29
Screw list.....	30
Major components of XPS 13 9340.....	31
Chapter 5: Removing and installing Field Replaceable Units (FRUs).....	33
Base cover.....	33
Removing the base cover.....	33
Installing the base cover.....	36
Battery.....	37
Rechargeable Li-ion battery precautions.....	37
Removing the battery.....	38
Installing the battery.....	41
Solid-state drive.....	44
Removing the M.2 2230 solid-state drive.....	44
Installing the M.2 2230 solid-state drive.....	44
Removing the M.2 2280 solid-state drive.....	45
Installing the M.2 2280 solid-state drive.....	46
Fans.....	47
Removing the fans.....	47
Installing the fans.....	49
Heat sink.....	50
Removing the heat sink.....	50
Installing the heat sink.....	51
Display assembly.....	52
Removing the display assembly.....	52
Installing the display assembly.....	54
System board.....	56
Removing the system board.....	56
Installing the system board.....	60
Power button with fingerprint reader.....	64
Removing the power button with fingerprint reader.....	64
Installing the power button with fingerprint reader.....	65
Keyboard.....	67
Removing the keyboard.....	67
Installing the keyboard.....	70
Palm-rest assembly.....	73
Removing the palm-rest assembly.....	73
Installing the palm-rest assembly.....	74
Chapter 6: Software.....	76
Operating system.....	76
Drivers and downloads.....	76
Chapter 7: Technology and components.....	77

Intel Arc Graphics.....	77
Chapter 8: BIOS Setup.....	78
Entering BIOS Setup program.....	78
Navigation keys.....	78
F12 One Time Boot menu.....	78
System setup options.....	79
Updating the BIOS.....	93
Updating the BIOS in Windows.....	93
Updating the BIOS using the USB drive in Windows.....	93
Updating the BIOS in Linux and Ubuntu.....	94
Updating the BIOS from the F12 One Time Boot menu.....	94
System and setup password.....	95
Assigning a System Setup password.....	95
Deleting or changing an existing system setup password.....	95
Clearing BIOS (System Setup) and System passwords.....	96
Chapter 9: Troubleshooting.....	97
Handling swollen rechargeable Li-ion batteries.....	97
Locate the Service Tag or Express Service Code of your Dell computer	97
Dell SupportAssist Pre-boot System Performance Check diagnostics.....	98
Running the SupportAssist Pre-Boot System Performance Check.....	98
Built-in self-test (BIST).....	98
M-BIST.....	98
LCD Power rail test (L-BIST).....	99
LCD Built-in Self-Test (BIST).....	99
Diagnostic error codes.....	100
Recovering the operating system.....	100
Real Time Clock—RTC reset.....	100
Backup media and recovery options.....	101
Wi-Fi power cycle.....	101
Drain residual flea power (perform hard reset).....	101
Chapter 10: Getting help and contacting Dell.....	103

Views of XPS 13 9340

Right



Figure 1. Right view

1. Thunderbolt 4 port with Power Delivery (Type-C)

Supports USB4, DisplayPort 1.4, Thunderbolt 4 and also enables you to connect to an external display using a display adapter. Provides data transfer rates of up to 40 Gbps for USB4 and Thunderbolt 4.

NOTE: A USB Type-C to DisplayPort adapter (sold separately) is required to connect a DisplayPort device.

NOTE: USB4 is backward compatible with USB 3.2, USB 2.0, and Thunderbolt 3.

NOTE: Thunderbolt 4 supports four 4K displays, one 5K display, or one 8K display.

Left



Figure 2. Left view

1. Thunderbolt 4 port with Power Delivery (Type-C)

Supports USB4, DisplayPort 1.4, Thunderbolt 4 and also enables you to connect to an external display using a display adapter. Provides data transfer rates of up to 40 Gbps for USB4 and Thunderbolt 4.

NOTE: A USB Type-C to DisplayPort adapter (sold separately) is required to connect a DisplayPort device.

NOTE: USB4 is backward compatible with USB 3.2, USB 2.0, and Thunderbolt 3.

NOTE: Thunderbolt 4 supports four 4K displays, one 5K display, or one 8K display.

Top



Figure 3. Top view

1. Microphones (2)

Provide digital sound input for audio recording, voice calls, and so on.

NOTE: The microphones are optional, depending on the configuration ordered.

2. Capacitive touch panel

Displays media and display control keys or standard function keys, with **esc** and **delete** keys.

Press and hold the **fn** key on the physical keyboard to switch to the next set of keys.

Press the **fn** key on the physical keyboard and the **esc** key on the capacitive touch panel to switch to the next set of keys and lock the mode of the panel.

3. Power button with fingerprint reader

Press to turn on the computer if it is turned off, in sleep state, or in hibernate state.

When the computer is turned on, press the power button to put the computer into a sleep state; press and hold the power button for 10 seconds to force shut-down the computer.

If the power button has a fingerprint reader, place your finger on the power button steadily to log in.

NOTE: You can customize the power-button behavior in Windows.

4. Haptic touchpad

Move your finger on the touchpad to control the cursor. For more information about the active areas of the touchpad, see the section on [Active areas of the touchpad controls](#).

5. Service LED

The service LED is used for troubleshooting with a Dell service representative. The LED emits amber or white light.

Active areas of the touchpad



Figure 4. Active areas of the touchpad

1. Left-click area of the touchpad

Move your finger on the touchpad within this area to control the cursor. Tap this area to left-click.

2. Right-click area of the touchpad

Move your finger on the touchpad within this area to control the cursor. Tap this area to right-click.

Display



Figure 5. Display view

1. Infrared emitter

Emits infrared light, which enables the infrared camera to sense and track motion.

i **NOTE:** The infrared emitter is not available if the camera is not included in the configuration ordered.

2. Infrared camera

Enhances security when paired with Windows Hello face authentication.

3. RGB and infrared camera

Enables you to video chat, capture photos, and record videos in RGB and infrared.

i **NOTE:** The RGB and infrared camera is optional, depending on the configuration ordered.

4. Camera-status light

Turns on when the camera is in use.

i **NOTE:** The camera-status light is not available if the camera is not included in the configuration ordered.

5. Ambient-light sensor

The sensor detects the ambient light and automatically adjusts the keyboard backlight and display brightness.

6. Infrared emitter

Emits infrared light, which enables the infrared camera to sense and track motion.

i **NOTE:** The infrared emitter is not available if the camera is not included in the configuration ordered.

Bottom



Figure 6. Bottom view

1. Left speaker

Provides audio output.

2. MyDell QR code

MyDell provides a consolidated application experience housing capability that helps you get the most out of your computer. Intelligent, AI-based optimization features automatically fine-tune your computer for the best audio, video, battery, and performance. Each MyDell user experience is unique as the software learns and responds to the way you use your computer.

3. Service Tag label

The Service Tag is a unique alphanumeric identifier that enables Dell service technicians to identify the hardware components in your computer and access warranty information.

4. Right speaker

Provides audio output.

Service Tag

The service tag is a unique alphanumeric identifier that allows Dell service technicians to identify the hardware components in your computer and access warranty information.



Figure 7. Service tag location

Battery charge and status light

The following table lists the battery charge and status light behavior of your XPS 13 9340.

Table 1. Battery charge and status light behavior

Power Source	LED Behavior	System Power State	Battery Charge Level
AC Adapter	Off	S0 - S5	Fully Charged
AC Adapter	Solid White	S0 - S5	< Fully Charged
Battery	Off	S0 - S5	11-100%
Battery	Solid Amber (590+/-3 nm)	S0 - S5	< 10%

- S0 (ON) - System is turned on.
- S4 (Hibernate) - The system consumes the least power compared to all other sleep states. The system is almost at an OFF state, except for a trickle power. The context data is written to a hard drive.
- S5 (OFF) - The system is in a shutdown state.

Set up your XPS 13 9340

About this task

NOTE: The images in this document may differ from your computer depending on the configuration you ordered.

Steps

1. Connect the power adapter and press the power button.



Figure 8. Connect the power adapter and press the power button.

NOTE: The battery may go into power-saving mode during shipment to conserve charge on the battery. Ensure that the power adapter is connected to your computer when it is turned on for the first time.

2. Finish the operating system setup.

For Ubuntu:

Follow the on-screen instructions to complete the setup. For more information about installing and configuring Ubuntu, search in the Knowledge Base Resource at [Dell Support Site](#).





For Windows:

Follow the on-screen instructions to complete the setup. When setting up, Dell Technologies recommends that you:

- Connect to a network for Windows updates.
 - NOTE:** If connecting to a secured wireless network, enter the password for the wireless network access when prompted.
- If connected to the Internet, sign in with or create a Microsoft account.
- On the **Support and Protection** screen, enter your contact details.

3. Locate and use Dell apps from the Windows Start menu—Recommended.

Table 2. Locate Dell apps in Windows

Resources	Description
 <p>Figure 9. My Dell</p>	<p>My Dell</p> <p>MyDell is a software application that offers you a single streamlined engagement platform including account access, device information, and hardware settings. This software delivers intelligent features that automatically fine-tune your computer for the best possible audio, power, and performance. Get the most out of your Dell device with intelligent, personalized technology from MyDell. Following are the key features of MyDell:</p> <ul style="list-style-type: none"> ● Application ● Audio ● Power ● Color and Display ● Presence detection <p>For more information about how to use MyDell, see product guides at Dell Support Site.</p>
 <p>Figure 10. Dell Update</p>	<p>Dell Update</p> <p>Updates your computer with critical fixes and latest device drivers as they become available. For more information about using Dell Update, see the product guides and third-party license documents at Dell Support Site.</p>
 <p>Figure 11. Dell Digital Delivery</p>	<p>Dell Digital Delivery</p> <p>Download software applications, which are purchased but not preinstalled on your computer. For more information about using Dell Digital Delivery, search in the Knowledge Base Resource at Dell Support Site.</p>
 <p>Figure 12. Support Assist</p>	<p>SupportAssist</p> <p>SupportAssist proactively and predictively identifies hardware and software issues on your computer and automates the engagement process with Dell Technical support. It addresses performance and stabilization issues, prevents security threats, monitors, and detects hardware failures. For more information, see <i>SupportAssist for Home PCs User's Guide</i> at SupportAssist for Home PCs.</p> <p>NOTE: In SupportAssist, click the warranty expiry date to renew or upgrade your warranty.</p>

Specifications of XPS 13 9340

Dimensions and weight

The following table lists the height, width, depth, and weight of your XPS 13 9340.

Table 3. Dimensions and weight

Description	Values
Height	<ul style="list-style-type: none"> 14.8 mm (0.58 in.) with OLED 15.3 mm (0.60 in.) with FHD+ and QHD+
Width	295.3 mm (11.63 in.)
Depth	199.1 mm (7.84 in.)
Weight  NOTE: The weight of your computer depends on the configuration that is ordered and manufacturing variability.	<ul style="list-style-type: none"> 1.19 kg (2.6 lbs) with OLED 1.22 kg (2.7 lbs) with FHD+ and QHD+

Processor

The following table lists the details of the processors that are supported for your XPS 13 9340.

Table 4. Processor

Description	Option one	Option two	Option three
Processor type	Intel Core Ultra 5 125H	Intel Core Ultra 7 155H	Intel Core Ultra 7 165H
Processor wattage	28 W	28 W	28 W
Processor core count	14	16	16
Processor thread count	18	22	22
Processor speed	Up to 4.50 GHz	Up to 4.80 GHz	Up to 5.0 GHz
Processor cache	18 MB	24 MB	24 MB
Integrated graphics	Intel Arc Graphics	Intel Arc Graphics	Intel Arc Graphics

Chipset

The following table lists the details of the chipset that is supported for your XPS 13 9340.

Table 5. Chipset

Description	Values
Chipset	Integrated in the processor
Processor	Intel Core Ultra 5/7
DRAM bus width	128-bit
Flash EPROM	64 MB
PCIe bus	Up to Gen4

Operating system

Your XPS 13 9340 supports the following operating systems:

- Windows 11 Pro
- Windows 11 Pro National Education
- Windows 11 Home
- Ubuntu Linux 22.04 LTS

Memory

The following table lists the memory specifications of your XPS 13 9340.





Table 6. Memory specifications

Description	Values
Memory slots	No memory slots  NOTE: The memory is integrated on the system board and is not upgradeable.
Memory type	LPDDR5/LPDDR5x
Memory speed	<ul style="list-style-type: none">• 6400 MT/s• 7467 MT/s
Maximum memory configuration	64 GB
Minimum memory configuration	8 GB
Memory configurations supported	<ul style="list-style-type: none">• 8 GB: LPDDR5, 6400 MT/s, dual-channel (onboard)• 16 GB: LPDDR5x, 7467 MT/s, dual-channel (onboard)• 32 GB: LPDDR5x, 7467 MT/s, dual-channel (onboard)• 64 GB: LPDDR5x, 7467 MT/s, dual-channel (onboard)

External ports

The following table lists the external ports on your XPS 13 9340.

Table 7. External ports

Description	Values
USB ports	Two Thunderbolt 4 ports with Power Delivery (Type-C)  NOTE: Connect the USB Type-C power adapter to only one of the two USB Type-C ports.  NOTE: You can connect a Dell Docking Station to this port. For more information, see the knowledge base article 000124295 at Dell Support Site .
Audio port	Two Thunderbolt 4 ports with Power Delivery (Type-C)  NOTE: A USB-C to 3.5 mm AUX audio adapter can be purchased separately to connect an audio device.
Video port/ports	Two Thunderbolt 4 ports with Power Delivery (Type-C)  NOTE: A USB-C to DisplayPort adapter (sold separately) is required to connect a DisplayPort device.
Media-card reader	Not supported
Power-adapter port	DC-IN through one of the two Thunderbolt 4 USB Type-C ports  NOTE: You can connect a Dell Docking Station to this port. For more information, see the knowledge base article 000124295 at Dell Support Site .
Security-cable slot	Not supported

Internal slots

The following table lists the internal slots of your XPS 13 9340.

Table 8. Internal slots

Description	Values
M.2	One M.2 slot for M.2 2230 or M.2 2280 solid-state drive  NOTE: To learn more about the features of different types of M.2 cards, search in the Knowledge Base Resource at Dell Support Site .

Wireless module

The following table lists the Wireless Local Area Network (WLAN) module that is supported on your XPS 13 9340.

Table 9. Wireless module specifications

Description	Values
Model number	Intel BE200

Table 9. Wireless module specifications (continued)

Description	Values
Transfer rate	Up to 5760 Mbps
Frequency bands supported	2.4 GHz/5 GHz/6 GHz
Wireless standards	<ul style="list-style-type: none"> • WiFi 802.11a/b/g • Wi-Fi 4 (WiFi 802.11n) • Wi-Fi 5 (WiFi 802.11ac) • Wi-Fi 6E (WiFi 802.11ax) • Wi-Fi 7 (WiFi 802.11be)
Encryption	<ul style="list-style-type: none"> • 64-bit/128-bit WEP • AES-CCMP • TKIP
Bluetooth wireless card	Bluetooth 5.4 wireless card
	<p>i NOTE: The version of the Bluetooth wireless card may vary depending on the operating system that is installed on your computer.</p>

Audio

The following table lists the audio specifications of your XPS 13 9340.

Table 10. Audio specifications

Description	Values
Audio controller	USB Type-C digital audio/SoundWire codecs
Stereo conversion	Supported
Internal audio interface	SoundWire interface
External audio interface	Two Thunderbolt 4 USB Type-C ports with Power Delivery i NOTE: A USB-C to 3.5 mm AUX audio adapter can be purchased separately to connect an audio device.
Number of speakers	<ul style="list-style-type: none"> • Two tweeter speakers • Two woofer speakers
Internal-speaker amplifier	Realtek ALC1318
External volume controls	Keyboard shortcut controls
Speaker output:	
	Average speaker output
	Peak speaker output
Subwoofer output	Not supported
Microphone	Dual digital-array microphones

Storage

This section lists the storage options on your XPS 13 9340.

Your XPS 13 9340 supports one M.2 2230 or M.2 2280 solid-state drive.

Table 11. Storage specifications

Storage type	Interface type	Capacity
M.2 2230 solid-state drive	Gen 4 PCIe NVMe	512 GB
M.2 2280 solid-state drive	Gen 4 PCIe NVMe	1 TB/2 TB/4 TB

Keyboard

The following table lists the keyboard specifications of your XPS 13 9340.

Table 12. Keyboard specifications

Description	Values
Keyboard type	AI hotkey backlit keyboard <i>i</i> NOTE: The top row of the keyboard is a capacitive touch panel. It can display standard Function buttons or media and display control buttons.
Keyboard layout	QWERTY
Number of keys	<ul style="list-style-type: none"> • United States and Canada: 64 keys • United Kingdom: 65 keys • Japan: 68 keys
Keyboard size	X=19.05 mm key pitch Y=18.05 mm key pitch
Keyboard shortcuts	<p>Some keys on your keyboard have two symbols on them. These keys can be used to type alternate characters or to perform secondary functions. To type the alternate character, press Shift and the desired key. To perform secondary functions, press Fn and the desired key.</p> <p><i>i</i> NOTE: You can define the primary behavior of the function keys (F1–F12) changing Function Key Behavior in BIOS setup program.</p> <p><i>i</i> NOTE: If Copilot in Windows is not available on your computer, the Copilot key launches Windows Search. For more information about Copilot in Windows, search in the Knowledge Base Resource at dell support.</p>

Keyboard shortcuts of XPS 13 9340

i **NOTE:** Keyboard characters may differ depending on the keyboard language configuration. Keys that are used for shortcuts remain the same across all language configurations.

Some keys on your keyboard have two symbols on them. These keys can be used to type alternate characters or to perform secondary functions. The symbol that is shown on the lower part of the key refers to the character that is typed out when the

key is pressed. If you press **shift** and the key, the symbol that is shown on the upper part of the key is typed out. For example, if you press **2**, **2** is typed out; if you press **Shift + 2**, **@** is typed out.

The top row of the keyboard is a capacitive touch panel. The **fn** mechanical key toggles between the keys **F1-F12** and keys for multimedia control. Releasing the **fn** key switches back to the previous mode.

Pressing the **fn** key and the **esc** key locks the "mode" of the capacitive touch panel. If the computer restarts, the default mode is the last mode set by the user before the computer is restarted.

The **fn** key is also used with selected keys on the keyboard to invoke other secondary functions.

Table 13. List of keyboard shortcuts

Keyboard shortcut	Behavior
Copilot	Launch Copilot in Windows. NOTE: If Copilot in Windows is not available on your computer, the Copilot key launches Windows Search. For more information about Copilot in Windows, search in the Knowledge Base Resource at Dell Support Site .
fn	Switch between modes of the capacitive touch panel
fn + B	Pause
fn + S	Toggle scroll lock.
fn + R	System request
fn + ctrl + B	Break
fn + esc	Lock the mode of the capacitive touch panel.
fn + left arrow	Home
fn + left arrow	End

Camera

The following table lists the camera specifications of your XPS 13 9340.

Table 14. Camera specifications

Description	Values
Number of cameras	Two
Camera type	<ul style="list-style-type: none"> FHD RGB + IR camera IR camera
Camera location	Front
Camera sensor type	CMOS sensor technology
Camera resolution:	
Still image	0.92 megapixel
Video	1280 x 720 at 30 fps
Infrared camera resolution:	
Still image	0.25 megapixel
Video	640 x 400 at 30 fps
Diagonal viewing angle:	

Table 14. Camera specifications (continued)

Description		Values
	Camera	75.8 degrees
	Infrared camera	75.8 degrees

Touchpad

The following table lists the touchpad specifications of your XPS 13 9340.

Table 15. Touchpad specifications

Description		Values
Touchpad resolution:		
	Horizontal	1300
	Vertical	722
Touchpad dimensions:		
	Horizontal	112.30 mm (4.42 in.)
	Vertical	64.15 mm (2.53 in.)
Touchpad gestures		For more information about touchpad gestures available on Windows, see the Microsoft Knowledge Base article at Microsoft Support Site .

Power adapter

The following table lists the power adapter specifications of your XPS 13 9340.

Table 16. Power adapter specifications

Description		Values
Type		60 W AC adapter, USB Type-C
Power-adapter dimensions:		
	Height	22 mm (0.87 in.)
	Width	55 mm (2.17 in.)
	Depth	66 mm (2.60 in.)
Input voltage		100 VAC–240 VAC
Input frequency		50 Hz–60 Hz
Input current (maximum)		1.70 A
Output current (continuous)		3 A
Rated output voltage		<ul style="list-style-type: none"> • 20 VDC • 15 VDC



Table 16. Power adapter specifications (continued)

Description		Values
		<ul style="list-style-type: none"> • 9 VDC • 5 VDC
Temperature range:		
	Operating	0°C to 40°C (32°F to 104°F)
	Storage	-20°C to 70°C (-4°F to 158°F)
 CAUTION: Operating and storage temperature ranges may differ among components, so operating or storing the device outside these ranges may impact the performance of specific components.		

Battery

The following table lists the battery specifications of your XPS 13 9340.

Table 17. Battery specifications

Description		Values
Battery type		3-cell, 55 Wh "smart" lithium-ion
Battery voltage		11.55 VDC
Battery weight (maximum)		0.219 kg (0.483 lb)
Battery dimensions:		
	Height	238.40 mm (9.39 in.)
	Width	4.86 mm (0.19 in.)
	Depth	97.41 mm (3.84 in.)
Temperature range:		
	Operating	0°C to 65°C (32°F to 149°F)
	Storage	-20°C to 65°C (-4°F to 149°F)
Battery operating time		Varies depending on operating conditions and can significantly reduce under certain power-intensive conditions.
Battery charging time (approximate)  NOTE: Control the charging time, duration, start and end time, and so on using the Power feature of MyDell application. For more information about the Power feature see, <i>Me and My Dell</i> on Dell Support Site .		3 hours (when the computer is off)
Coin-cell battery		Not applicable
 CAUTION: Operating and storage temperature ranges may differ among components, so operating or storing the device outside these ranges may impact the performance of specific components.		
 CAUTION: Dell Technologies recommends that you charge the battery regularly for optimal power consumption. If your battery charge is completely depleted, connect the power adapter, turn on your computer, and then restart your computer to reduce the power consumption.		

Display

The following table lists the display specifications of your XPS 13 9340.

Table 18. Display specifications

Description		Option one	Option two	Option three
Display type		Quad High Definition (QHD+), Eyesafe, low blue light	Full High Definition (FHD+), Eyesafe, low blue light	2.8K, OLED, Eyesafe low blue light display technology
Touch options		Yes	No	Yes
Display-panel technology		Wide Viewing Angle (WVA)	Wide Viewing Angle (WVA)	Wide Viewing Angle (WVA)
Display-panel dimensions (active area):				
	Height	288 mm (11.34 in.)	288 mm (11.34 in.)	288 mm (11.34 in.)
	Width	180 mm (7.09 in.)	180 mm (7.09 in.)	180 mm (7.09 in.)
	Diagonal	339.60 mm (13.37 in.)	339.60 mm (13.37 in.)	339.60 mm (13.37 in.)
Display-panel native resolution		2560 x 1600	1920 x 1200	2880 x 1800
Luminance (typical)		500 nits	500 nits	400 nits
Megapixels		4.096	2.304	5.184
Color gamut		<ul style="list-style-type: none"> • DCI-P3 100% typical • 95% minimum 	<ul style="list-style-type: none"> • sRGB 100% typical • 95% minimum 	<ul style="list-style-type: none"> • DCI-P3 100% typical • 95% minimum
Pixels Per Inch (PPI)		225.7	169.3	254
Contrast ratio (typical)		2000:1	2000:1	1000000:1
Response time (maximum)		35 ms	35 ms	2 ms
Refresh rate		120 Hz (maximum)	120 Hz (maximum)	60 Hz (maximum)
Horizontal view angle		85 degrees	85 degrees	85 degrees
Vertical view angle		85 degrees	85 degrees	85 degrees
Pixel pitch		0.1125 mm	0.150 mm	0.10002 mm
Power consumption (maximum)		3.91 W	2.2 W	6.07 W
Anti-glare vs glossy finish		Anti-reflective	Anti-glare	Anti-reflective

Fingerprint reader

The following table lists the fingerprint-reader specifications of your XPS 13 9340.

 **NOTE:** The fingerprint reader is on the power button.

Table 19. Fingerprint reader specifications

Description	Values
Fingerprint-reader sensor technology	Trans-capacitive sensing
Fingerprint-reader sensor resolution	500 dpi
Fingerprint-reader sensor pixel size	88 x 108

Fingerprint reader

The following table lists the fingerprint-reader specifications of your XPS 13 9340.

Table 20. Fingerprint reader specifications

Description	Values
Fingerprint-reader sensor technology	Trans-capacitive sensing
Fingerprint-reader sensor resolution	500 dpi
Fingerprint-reader sensor pixel size	88 x 108

Sensor

The following table lists the sensor of your XPS 13 9340.

Table 21. Sensor

Sensor support
Ambient Light Sensor
Adaptive Thermal Performance
Dell ExpressSign-in 2.0 (via Intel Camera Sensing Technology)
Wake/Power on with lid open
Hall sensor

GPU—Integrated

The following table lists the specifications of the integrated Graphics Processing Unit (GPU) supported by your XPS 13 9340.

Table 22. GPU—Integrated

Controller	Memory size	Processor
Intel Arc Graphics	Shared system memory	Intel Core Ultra 5/7

Multiple display support matrix

The following table lists the multi-monitor support matrix that is supported by your XPS 13 9340.

Table 23. Integrated - Multiple display support matrix

Description	Values
Video ports on Integrated Graphics Card	Two Thunderbolt 4 ports with Power Delivery
Number of displays (with computer internal display on)	Three 4K external displays using the Thunderbolt 4 (USB-C) ports available on your XPS 13 9340
Number of displays (with computer internal display off)	Four 4K external displays, one 5K, or one 8K and above displays using the Thunderbolt 4 (USB-C) ports available on your XPS 13 9340

Hardware security

The following table lists the hardware security of your XPS 13 9340.

Table 24. Hardware security

Hardware security
NIST 800-147 protocol
Trusted Platform Module (TPM) 2.0 FIPS-140-2 Certified/TCG Certified
Touch Fingerprint Reader (in Power Button) with Control Vault 3.0 Advanced Authentication with FIPS 140-2 Level 3 Certification (Optional)
Face IR camera (Windows Hello compliant) with ExpressSign-in 2.0 (Camera Sensing) (Optional)
Intel vPro Technology (iAMT 12) (optional, requires Intel WiFi Link WLAN and a vPro compatible processor)
Intel Platform Trust Technology
Support for Absolute module interface and external SmartCard Reader

Operating and storage environment

This table lists the operating and storage specifications of your XPS 13 9340.

Airborne contaminant level: G1 as defined by ISA-S71.04-1985

Table 25. Computer environment

Description	Operating	Storage
Temperature range	0°C to 35°C (32°F to 95°F)	-40°C to 65°C (-40°F to 149°F)
Relative humidity (maximum)	10% to 90% (non-condensing)	0% to 95% (non-condensing)
Vibration (maximum)*	0.66 GRMS	1.30 GRMS
Shock (maximum)	110 G†	160 G†
Altitude range	-15.2 m to 3048 m (-49.87 ft to 10,000 ft)	-15.2 m to 10668 m (-49.87 ft to 35,000 ft)

 **CAUTION:** Operating and storage temperature ranges may differ among components, so operating or storing the device outside these ranges may impact the performance of specific components.

* Measured using a random vibration spectrum that simulates the user environment.

† Measured using a 2 ms half-sine pulse.

Dell support policy

For information about Dell support policy, search in the Knowledge Base Resource at [Dell Support Site](#).

Dell low blue light display

 **WARNING: Prolonged exposure to blue light from the display may lead to long-term effects such as eye strain, eye fatigue, or damage to the eyes.**

Blue light is a color in the light spectrum which has a short wavelength and high energy. Chronic exposure to blue light, particularly from digital sources may disrupt sleep patterns and cause long-term effects such as eye strain, eye fatigue, or damage to the eyes.

The display on this computer is designed to minimize blue light and complies with TÜV Rheinland's requirement for low blue light displays.

Low blue light mode is enabled at the factory, so no further configuration is necessary.











To reduce the risk of eye strain, it is also recommended that you:

- Position the display at a comfortable viewing distance between 20 and 28 inches (50 cm and 70 cm) from your eyes.
- Blink frequently to moisten your eyes, wet your eyes with water, or apply suitable eye drops.
- Look away from your display, and gaze at a distant object at 20 ft (609.60 cm) away for at least 20 seconds during each break.
- Take an extended break for 20 minutes every two hours.

Working inside your computer



Safety instructions

Use the following safety guidelines to protect your computer from potential damage and to ensure your personal safety. Unless otherwise noted, each procedure in this document assumes that you have read the safety information that shipped with your computer.

-  **WARNING:** Before working inside your computer, read the safety information that is shipped with your computer. For more safety best practices, see [Dell Regulatory Compliance Home Page](#).
-  **WARNING:** Disconnect your computer from all power sources before opening the computer cover or panels. After you finish working inside the computer, replace all covers, panels, and screws before connecting your computer to an electrical outlet.
-  **CAUTION:** To avoid damaging the computer, ensure that the work surface is flat, dry, and clean.
-  **CAUTION:** To avoid damaging the components and cards, handle them by their edges, and avoid touching the pins and the contacts.
-  **CAUTION:** You should only perform troubleshooting and repairs as authorized or directed by the Dell technical assistance team. Damage due to servicing that is not authorized by Dell is not covered by your warranty. See the safety instructions that is shipped with the product or at [Dell Regulatory Compliance Home Page](#).
-  **CAUTION:** Before touching anything inside your computer, ground yourself by touching an unpainted metal surface, such as the metal at the back of the computer. While you work, periodically touch an unpainted metal surface to dissipate static electricity which could harm internal components.
-  **CAUTION:** When you disconnect a cable, pull it by its connector or its pull tab, not the cable itself. Some cables have connectors with locking tabs or thumbscrews that you must disengage before disconnecting the cable. When disconnecting cables, keep them evenly aligned to avoid bending the connector pins. When connecting cables, ensure that the ports and the connectors are correctly oriented and aligned.
-  **CAUTION:** Press and eject any installed card from the media-card reader.
-  **CAUTION:** Exercise caution when handling rechargeable Li-ion batteries in laptops. Swollen batteries should not be used and should be replaced and disposed properly.
-  **NOTE:** The color of your computer and certain components may differ from what is shown in this document.

Before working inside your computer

Steps

1. Save and close all open files and exit all open applications.
2. Shut down your computer. For Windows operating system, click **Start** >  **Power** > **Shut down**.
 -  **NOTE:** If you are using a different operating system, see the documentation of your operating system for shut-down instructions.
3. Disconnect your computer and all attached devices from their electrical outlets.
4. Disconnect all attached network devices and peripherals, such as keyboard, mouse, and monitor from your computer.
5. Remove any media card and optical disk from your computer, if applicable.

6. Enter the service mode, if you can turn on your computer.

Service Mode

Service Mode is used to cut off power, without disconnecting the battery cable from the system board prior to conducting repairs in the computer.

 **CAUTION:** If you are unable to turn on the computer to put it into Service Mode, or the computer does not support Service Mode, proceed to disconnect the battery cable. To disconnect the battery cable, follow the steps in [Removing the battery](#).

 **NOTE:** Ensure that your computer is shut down and the AC adapter is disconnected.

- a. Hold the **** key on the keyboard and press the power button for 3 seconds or until the Dell logo appears on the screen.
- b. Press any key to continue.
- c. If the AC adapter is not disconnected, a message prompting you to remove the AC adapter appears on the screen. Remove the AC adapter and then press any key to continue the **Service Mode** process. The **Service Mode** process automatically skips the following step if the **Owner Tag** of the computer is not set up in advance by the user.
- d. When the **ready-to-proceed** message appears on the screen, press any key to proceed. The computer emits three short beeps and shuts down immediately.
- e. Once the computer shuts down, it has successfully entered Service Mode.

 **NOTE:** If you are unable to turn on your computer or unable to enter Service Mode, skip this process.

Safety precautions

The safety precautions chapter details the primary steps to be taken before performing any disassembly instructions.

Observe the following safety precautions before you perform any installation or break-fix procedures involving disassembly or reassembly:

- Turn off the computer and all attached peripherals.
- Disconnect the computer and all attached peripherals from AC power.
- Disconnect all network cables, telephone, and telecommunications lines from the computer.
- Use an ESD field service kit when working inside any to avoid electrostatic discharge (ESD) damage.
- After removing any computer component, carefully place the removed component on an anti-static mat.
- Wear shoes with non-conductive rubber soles to reduce the chance of getting electrocuted.
- Unplugging, pressing, and holding the power button for 15 seconds should discharge residual power in the system board.

Standby power

Dell products with standby power must be unplugged before you open the case. Systems that incorporate standby power are powered while turned off. The internal power enables the computer to be remotely turned on (Wake-on-LAN) and suspended into a sleep mode and has other advanced power management features.

Bonding

Bonding is a method for connecting two or more grounding conductors to the same electrical potential. This is done by using a field service electrostatic discharge (ESD) kit. When connecting a bonding wire, ensure that it is connected to bare metal and never to a painted or nonmetal surface. The wrist strap should be secure and in full contact with your skin, and ensure that you remove all jewelry such as watches, bracelets, or rings prior to bonding yourself and the equipment.

Electrostatic discharge—ESD protection

ESD is a major concern when you handle electronic components, especially sensitive components such as expansion cards, processors, memory modules, and system boards. Slight charges can damage circuits in ways that may not be obvious, such as intermittent problems or a shortened product life span. As the industry pushes for lower power requirements and increased density, ESD protection is an increasing concern.

Due to the increased density of semiconductors used in recent Dell products, the sensitivity to static damage is now higher than in previous Dell products. For this reason, some previously approved methods of handling parts are no longer applicable.

Two recognized types of ESD damage are catastrophic and intermittent failures.

- **Catastrophic** – Catastrophic failures represent approximately 20 percent of ESD-related failures. The damage causes an immediate and complete loss of device functionality. An example of catastrophic failure is a memory DIMM that has received a static shock and immediately generates a "No POST/No Video" symptom with a beep code that is emitted for missing or nonfunctional memory.
- **Intermittent** – Intermittent failures represent approximately 80 percent of ESD-related failures. The high rate of intermittent failures means that most of the time when damage occurs, it is not immediately recognizable. The DIMM receives a static shock, but the tracing is merely weakened and does not immediately produce outward symptoms that are related to the damage. The weakened trace may take weeks or months to melt, and in the meantime may cause degradation of memory integrity, intermittent memory errors, and so on.

The more difficult type of damage to recognize and troubleshoot is the intermittent (also called latent or "walking wounded") failure.

Perform the following steps to prevent ESD damage:

- Use a wired ESD wrist strap that is properly grounded. Wireless anti-static straps do not provide adequate protection. Touching the chassis before handling parts does not ensure adequate ESD protection on parts with increased sensitivity to ESD damage.
- Handle all static-sensitive components in a static-safe area. If possible, use anti-static floor pads and workbench pads.
- When unpacking a static-sensitive component from its shipping carton, do not remove the component from the anti-static packing material until you are ready to install the component. Before unwrapping the anti-static packaging, ensure that you discharge static electricity from your body.
- Before transporting a static-sensitive component, place it in an anti-static container or packaging.

ESD Field Service kit

The unmonitored Field Service kit is the most commonly used service kit. Each Field Service kit includes three main components: anti-static mat, wrist strap, and bonding wire.

Components of an ESD field service kit

The components of an ESD field service kit are:

- **Anti-Static Mat** – The anti-static mat is dissipative and parts can be placed on it during service procedures. When using an anti-static mat, your wrist strap should be snug and the bonding wire should be connected to the mat and to any bare metal on the computer being worked on. Once deployed properly, service parts can be removed from the ESD bag and placed directly on the mat. ESD-sensitive items are safe in your hand, on the ESD mat, in the computer, or inside an ESD bag.
- **Wrist Strap and Bonding Wire** – The wrist strap and bonding wire can be either directly connected between your wrist and bare metal on the hardware if the ESD mat is not required, or connected to the anti-static mat to protect hardware that is temporarily placed on the mat. The physical connection of the wrist strap and bonding wire between your skin, the ESD mat, and the hardware is known as bonding. Use only Field Service kits with a wrist strap, mat, and bonding wire. Never use wireless wrist straps. Always be aware that the internal wires of a wrist strap are prone to damage from normal wear and tear, and must be checked regularly with a wrist strap tester in order to avoid accidental ESD hardware damage. It is recommended to test the wrist strap and bonding wire at least once per week.
- **ESD Wrist Strap Tester** – The wires inside an ESD strap are prone to damage over time. When using an unmonitored kit, it is a best practice to regularly test the strap prior to each service call, and at a minimum, test once per week. A wrist strap tester is the best method for doing this test. If you do not have your own wrist strap tester, check with your regional office to find out if they have one. To perform the test, plug the bonding-wire of wrist-strap into the tester while it is strapped to your wrist and push the button to test. A green LED is lit if the test is successful; a red LED is lit and an alarm sounds if the test fails.
- **Insulator Elements** – It is critical to keep ESD sensitive devices, such as plastic heat sink casings, away from internal parts that are insulators and often highly charged.
- **Working Environment** – Before deploying the ESD Field Service kit, assess the situation at the customer location. For example, deploying the kit for a server environment is different than for a desktop or laptop environment. Servers are typically installed in a rack within a data center; desktops or laptops are typically placed on office desks or cubicles. Always look for a large open flat work area that is free of clutter and large enough to deploy the ESD kit with additional space to accommodate the type of computer that is being repaired. The workspace should also be free of insulators that can cause an ESD event. On the work area, insulators such as Styrofoam and other plastics should always be moved at least 12 inches or 30 centimeters away from sensitive parts before physically handling any hardware components.

- **ESD Packaging** – All ESD-sensitive devices must be shipped and received in static-safe packaging. Metal, static-shielded bags are preferred. However, you should always return the damaged part using the same ESD bag and packaging that the new part arrived in. The ESD bag should be folded over and taped shut and all the same foam packing material should be used in the original box that the new part arrived in. ESD-sensitive devices should be removed from packaging only at an ESD-protected work surface, and parts should never be placed on top of the ESD bag because only the inside of the bag is shielded. Always place parts in your hand, on the ESD mat, in the computer, or inside an anti-static bag.
- **Transporting Sensitive Components** – When transporting ESD sensitive components such as replacement parts or parts to be returned to Dell, it is critical to place these parts in anti-static bags for safe transport.

ESD protection summary

It is recommended to always use the traditional wired ESD grounding wrist strap and protective anti-static mat when servicing Dell products. In addition, it is critical to keep sensitive parts separate from all insulator parts while performing service and use anti-static bags for transporting sensitive components.

Transporting sensitive components

When transporting ESD sensitive components such as replacement parts or parts to be returned to Dell, it is critical to place these parts in anti-static bags for safe transport.

After working inside your computer

About this task

 **CAUTION:** Leaving stray or loose screws inside your computer may severely damage your computer.

Steps

1. Replace all screws and ensure that no stray screws remain inside your computer.
2. Connect any external devices, peripherals, or cables you removed before working on your computer.
3. Replace any media cards, discs, or any other parts that you removed before working on your computer.
4. Connect your computer and all attached devices to their electrical outlets.
 -  **NOTE:** To exit service mode, ensure to connect the AC adapter to the power-adapter port on your computer.
5. Press the power button to turn on the computer. Your computer will automatically return to normal functioning mode.

BitLocker

 **CAUTION:** If BitLocker is not suspended before updating the BIOS, the next time you reboot the system it will not recognize the BitLocker key. You will then be prompted to enter the recovery key to progress, and the system will ask for the recovery key on each reboot. If the recovery key is not known, this can result in data loss or an unnecessary operating system reinstall. For more information about this subject, see Knowledge Article: [updating the BIOS on Dell systems with BitLocker enabled](#).

The installation of the following components triggers BitLocker:

- Hard disk drive or solid-state drive
- System board

Recommended tools















The procedures in this document may require the following tools:

- Phillips screwdriver #0
- Torx #5 (T5) screwdriver

Screw list

- NOTE:** When removing screws from a component, it is recommended to note the screw type, and the quantity of screws, and then place them in a screw storage box. This is to ensure that the correct number of screws and correct screw type is restored when the component is replaced.
- NOTE:** Some computers have magnetic surfaces. Ensure that the screws are not left attached to such surfaces when replacing a component.
- NOTE:** Screw color may vary with the configuration ordered.

Table 26. Screw list

Component	Secured to	Screw type	Quantity	Screw image
Base cover	Palm-rest and keyboard assembly	M2x3, T5	6	
Battery	Palm-rest and keyboard assembly	M1.6x2.5	6	
Battery-connector bracket	System board	Captive	1	
Solid-state drive shield	System board	M2x3	1	
Fans	System board	M1.6x2.5	4	
Heat sink	System board	Captive	4	
Display-assembly cable bracket	System board	Captive	3	
Display-assembly cable holder	System board	M1.6x2.5	3	
Display-assembly hinges	Palm-rest and keyboard assembly	M2.5x5	6	
Wireless-card bracket	System board	Captive	1	
System board	Palm-rest and keyboard assembly	M1.6x3	4	
System board	Palm-rest and keyboard assembly	M1.6x2.3	7	
Power button with fingerprint reader	Palm-rest and keyboard assembly	M1.4x2	4	
Keyboard	Palm-rest and keyboard assembly	M1.4x1.2	17	
Keyboard	Palm-rest and keyboard assembly	M1.6x2	7	

Major components of XPS 13 9340

The following image shows the major components of XPS 13 9340.

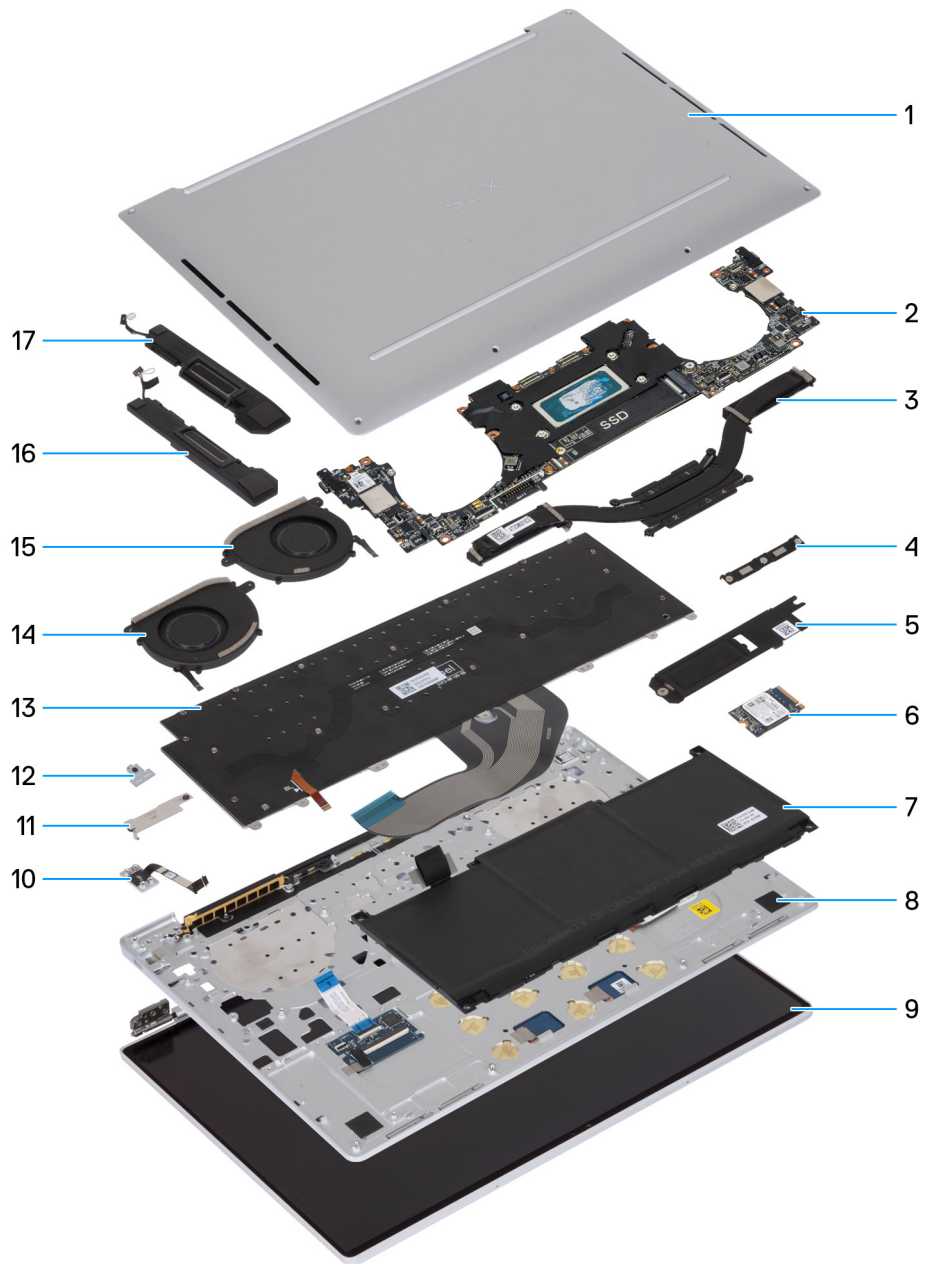



Figure 13. Major components of your computer

1. Base cover
2. System board
3. Heat sink
4. Display assembly-cable bracket
5. M.2 solid-state drive thermal plate
6. M.2 solid-state drive
7. Battery
8. Palm-rest and keyboard assembly
9. Display assembly
10. Power button

11. Battery-connector bracket
12. Wireless-module bracket
13. Keyboard
14. Right fan
15. Left fan
16. Right speaker
17. Left speaker

 **NOTE:** Dell provides a list of components and their part numbers for the original computer configuration purchased. These parts are available according to warranty coverage purchased by the customer. Contact your Dell sales representative for purchase options.

Removing and installing Field Replaceable Units (FRUs)

The replaceable components in this chapter are Field Replaceable Units (FRUs).

 **CAUTION:** The information in this section is intended for authorized service technicians only.

 **CAUTION:** To avoid any potential damage to the component or loss of data, ensure that an authorized service technician replaces the Field Replaceable Units (FRUs).

 **CAUTION:** Dell Technologies recommends that this set of repairs, if needed, to be conducted by trained technical repair specialists.

 **CAUTION:** As a reminder, your warranty does not cover damages that may occur during FRU repairs that are not authorized by Dell Technologies.

 **NOTE:** The images in this document may differ from your computer depending on the configuration you ordered.

Base cover

Removing the base cover

 **CAUTION:** The information in this removal section is intended for authorized service technicians only.

Prerequisites

Follow the procedure in [Before working inside your computer](#).

 **NOTE:** Ensure that your computer is in Service Mode. For more information, see [Before working inside your computer](#).

About this task

The following images indicate the location of the base cover and provide a visual representation of the removal procedure.



6x
M2x3, T5



Figure 14. Removing the base cover



Figure 15. Removing the base cover



Figure 16. Removing the base cover

Steps

1. Remove the six screws (M2x3, T5) that secure the base cover to the palm-rest and keyboard assembly.

NOTE: A Torx #5 (T5) screwdriver is necessary to remove the six screws (M2x3, Torx 5).

2. Place your thumbs and fingers into the recess at the top edge of the base cover.
3. Use both thumbs to pry the base cover in order to release it from the palm-rest and keyboard assembly.

NOTE: Do not pull on or pry the base cover from where the display assembly hinges are, doing so may damage the base cover.

4. Move your hands to both sides of the base cover and lift the base cover off the palm-rest and keyboard assembly.

Installing the base cover

Prerequisites

If you are replacing a component, remove the existing component before performing the installation process.

About this task

The following images indicate the location of the base cover and provide a visual representation of the installation procedure.



6x
M2x3, T5



Figure 17. Installing the base cover

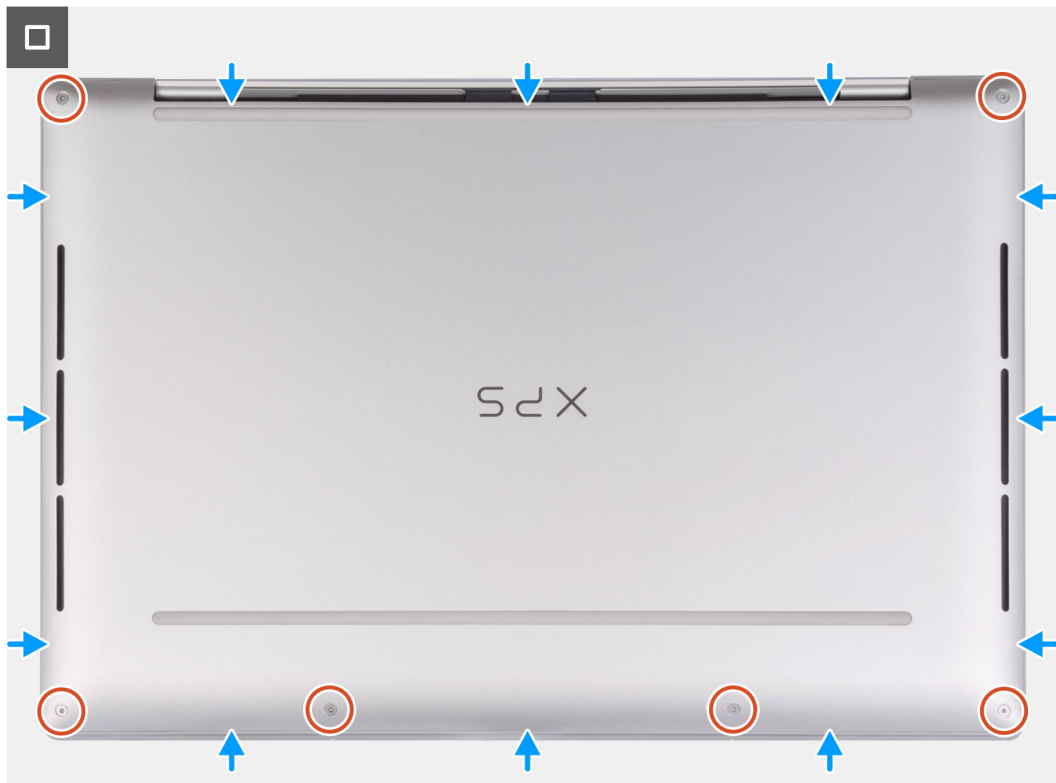

Figure 18. Installing the base cover

Steps

1. Place and snap the base cover into place on the palm-rest and keyboard assembly.
 - NOTE:** Align the screw holes on the base cover with the screw holes on the palm-rest and keyboard assembly before applying slight pressure to the base cover.
2. Replace the six screws (M2x3, T5) that secure the base cover to the palm-rest and keyboard assembly.
 - NOTE:** A Torx #5 (T5) screwdriver is necessary to install the six screws (M2x3, Torx 5).

Next steps

1. Follow the procedure in [After working inside your computer](#).

Battery

Rechargeable Li-ion battery precautions

CAUTION:

- Exercise caution when handling rechargeable Li-ion batteries.
- Discharge the battery completely before removing it. Disconnect the AC power adapter from the computer and operate the computer solely on battery power—the battery is fully discharged when the computer no longer turns on when the power button is pressed.
- Do not crush, drop, mutilate, or penetrate the battery with foreign objects.
- Do not expose the battery to high temperatures, or disassemble battery packs and cells.
- Do not apply pressure to the surface of the battery.
- Do not bend the battery.

- Do not use tools of any kind to pry on or against the battery.
- Ensure any screws during the servicing of this product are not lost or misplaced, to prevent accidental puncture or damage to the battery and other computer components.
- If the battery gets stuck inside your computer as a result of swelling, do not try to release it as puncturing, bending, or crushing a rechargeable Li-ion battery can be dangerous. In such an instance, contact Dell technical support for assistance. See [Contact Support at Dell Support Site](#).
- Always purchase genuine batteries from [Dell Site](#) or authorized Dell partners and resellers.
- Swollen batteries should not be used and should be replaced and disposed properly. For guidelines on how to handle and replace swollen rechargeable Li-ion batteries, see [Handling swollen rechargeable Li-ion batteries](#).

Removing the battery

Prerequisites

1. Follow the procedure in [Before working inside your computer](#).
2. Remove the [base cover](#).

About this task

The following images indicate the location of the battery and provide a visual representation of the removal procedure.

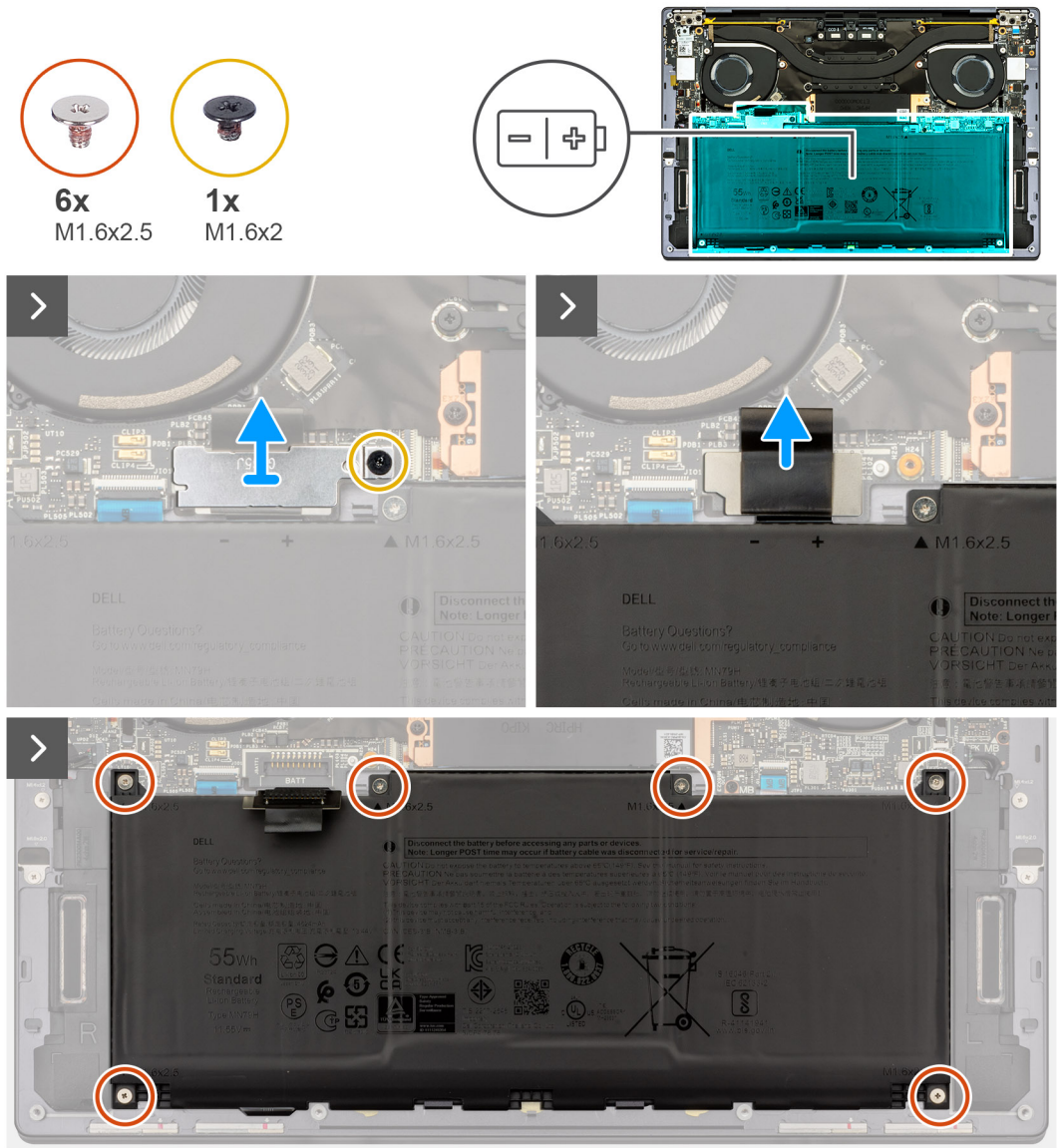

Figure 19. Removing the battery

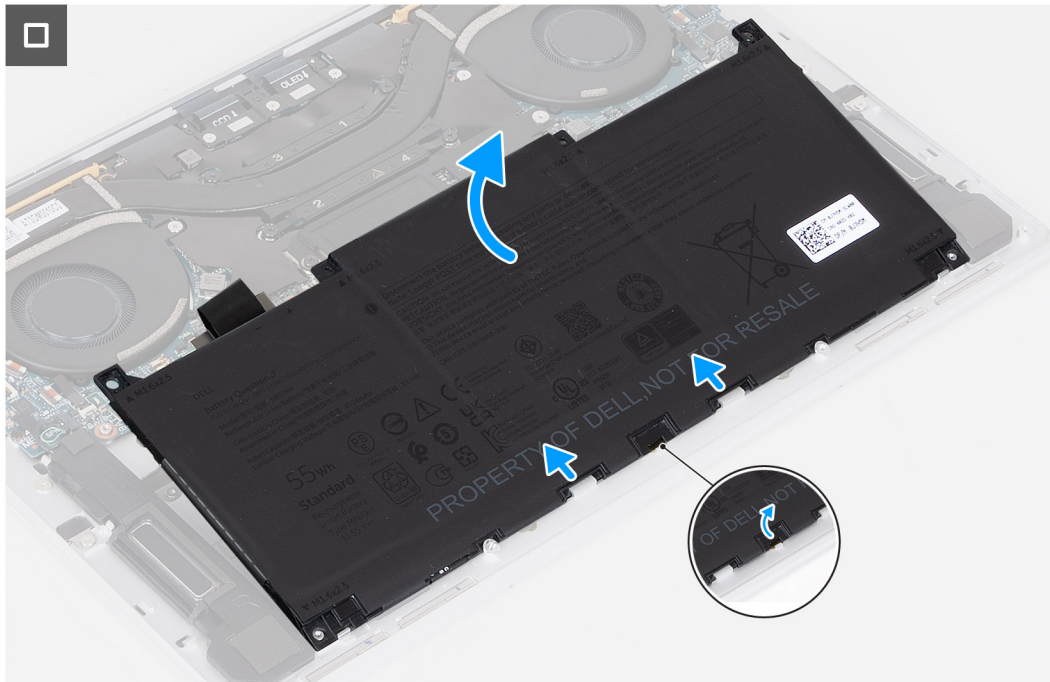

Figure 20. Removing the battery

Steps

1. Loosen the captive screw (M1.6x2) that secures the battery-connector bracket to the system board.
2. Unhook and lift the battery-connector bracket off the system board.

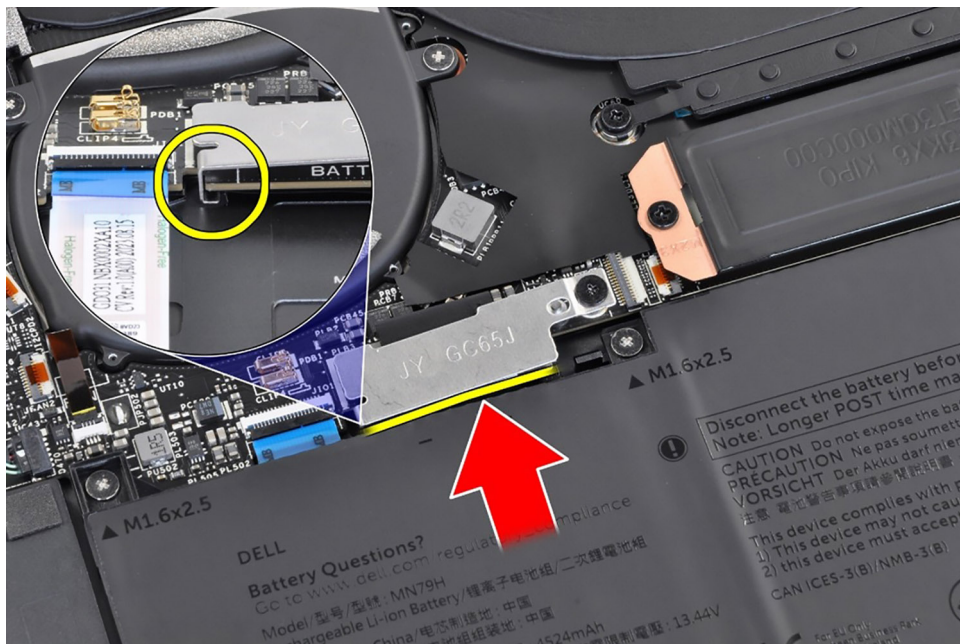

Figure 21. Battery-connector bracket

3. Use the pull tab on the battery power cable to disconnect the battery cable from the battery connector.
4. Remove the six screws (M1.6x2.5) that secure the battery to the palm-rest and keyboard assembly.
5. Use the pull tab to lift the battery slightly from its top edge. This action releases the battery from the two hooks that are located near the bottom edge of the palm-rest and keyboard assembly.

⚠ CAUTION: Do not lift the battery at more than an angle of 30 degrees to avoid damage to the battery and the palm-rest and keyboard assembly.

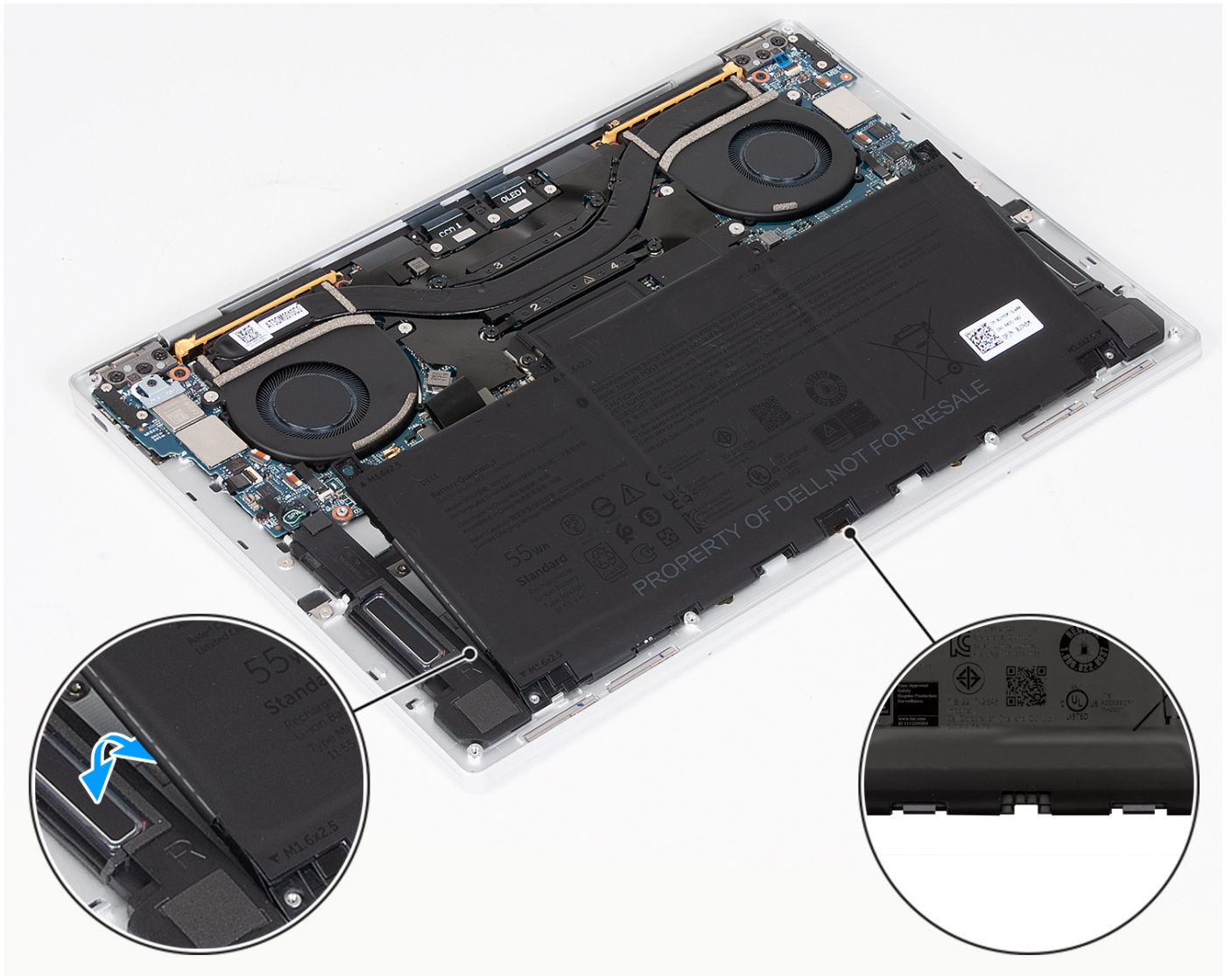

Figure 22. Lift the battery at an angle less than 30 degrees

6. Slide the battery towards the back and lift the battery off the palm-rest and keyboard assembly.

Installing the battery

Prerequisites

If you are replacing a component, remove the existing component before performing the installation process.

About this task

The following images indicate the location of the battery and provide a visual representation of the installation procedure.

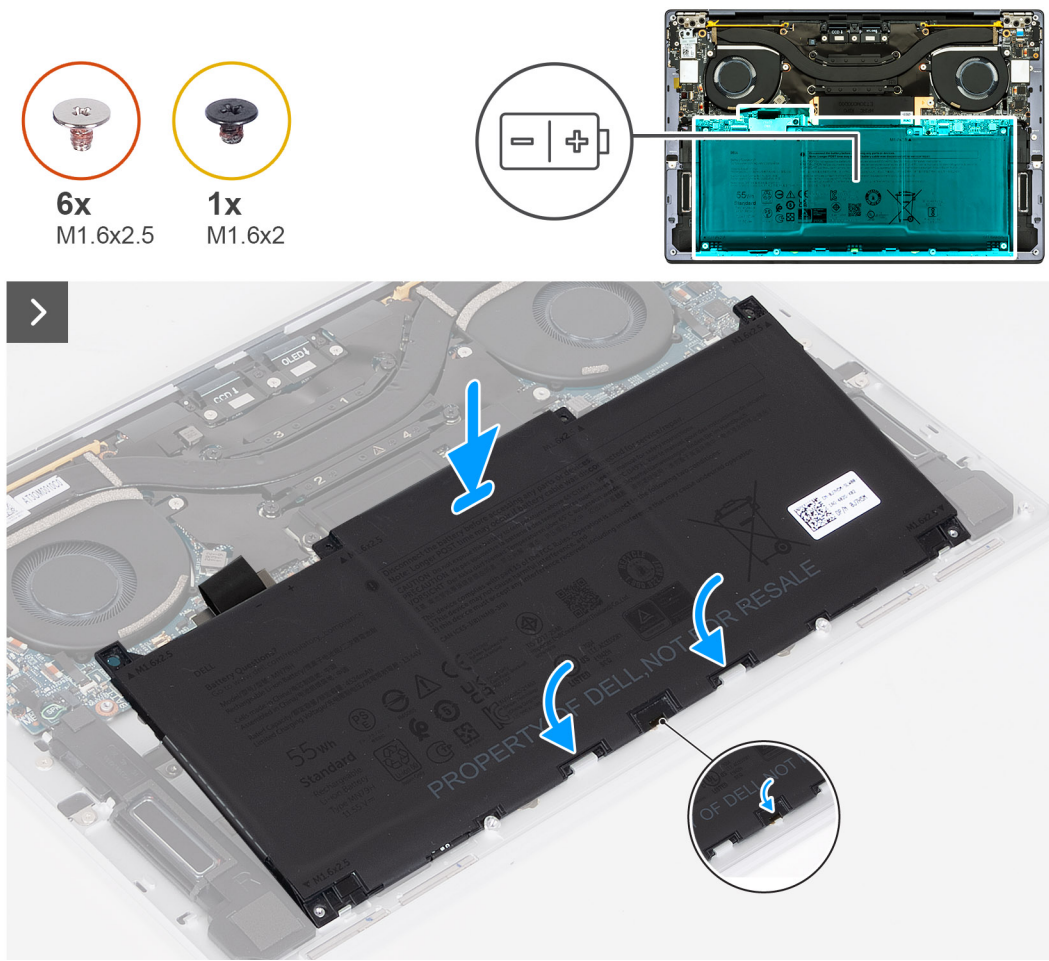

Figure 23. Installing the battery

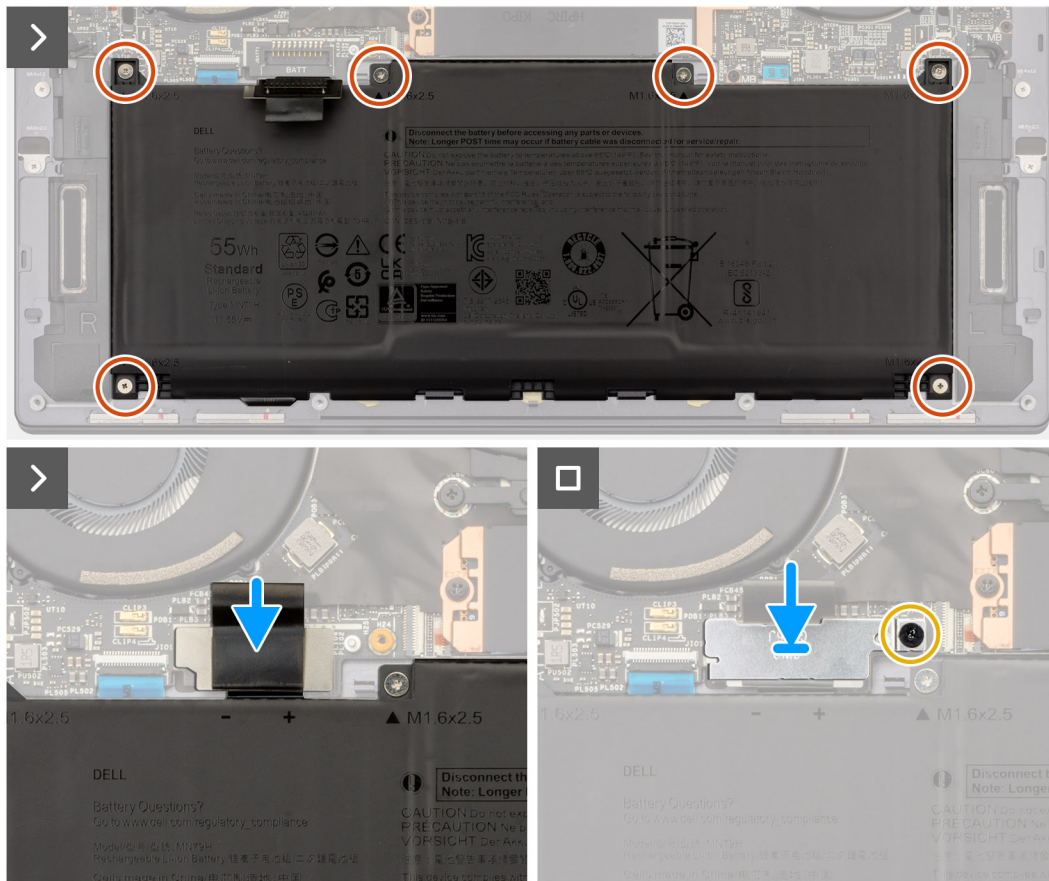

Figure 24. Installing the battery

Steps

1. Align the edge of the battery at an angle so that the cutouts on the battery fit into the hooks on the palm-rest and keyboard assembly. Align the two screw holes on the battery with the screw holes on the palm-rest and keyboard assembly as well.
2. Lower the battery to the palm-rest and keyboard assembly until it fits into the battery section of the palm-rest and keyboard assembly.
3. Replace the six screws (M1.6x2.5) to secure the battery to the palm-rest and keyboard assembly.
 - NOTE:** Align the screw holes on the base cover with the screw holes on the palm-rest and keyboard assembly before replacing the screws.
4. Connect the battery cable to the system board.
5. Line up the battery-connector bracket over the battery connector on the system board.
6. Slide the hook at the end of the battery-connector bracket under the system board. Ensure the hook fits into the underside of the system board.
7. Tighten the captive screw (M1.6x2) to secure the bracket to the system board. Ensure that the stud on the system board fits into its opening on the battery-connector bracket.

Next steps

1. Install the [base cover](#).
2. Follow the procedure in [After working inside your computer](#).

Solid-state drive

Removing the M.2 2230 solid-state drive

Prerequisites

1. Follow the procedure in [Before working inside your computer](#).
2. Remove the [base cover](#).

About this task

NOTE: Depending on the configuration ordered, your computer may support an M.2 2230 solid-state drive or an M.2 2280 solid-state drive.

NOTE: This procedure applies only to computers shipped with an M.2 2230 solid-state drive.

The following images indicate the location of the M.2 2230 solid-state drive and provide a visual representation of the removal procedure.

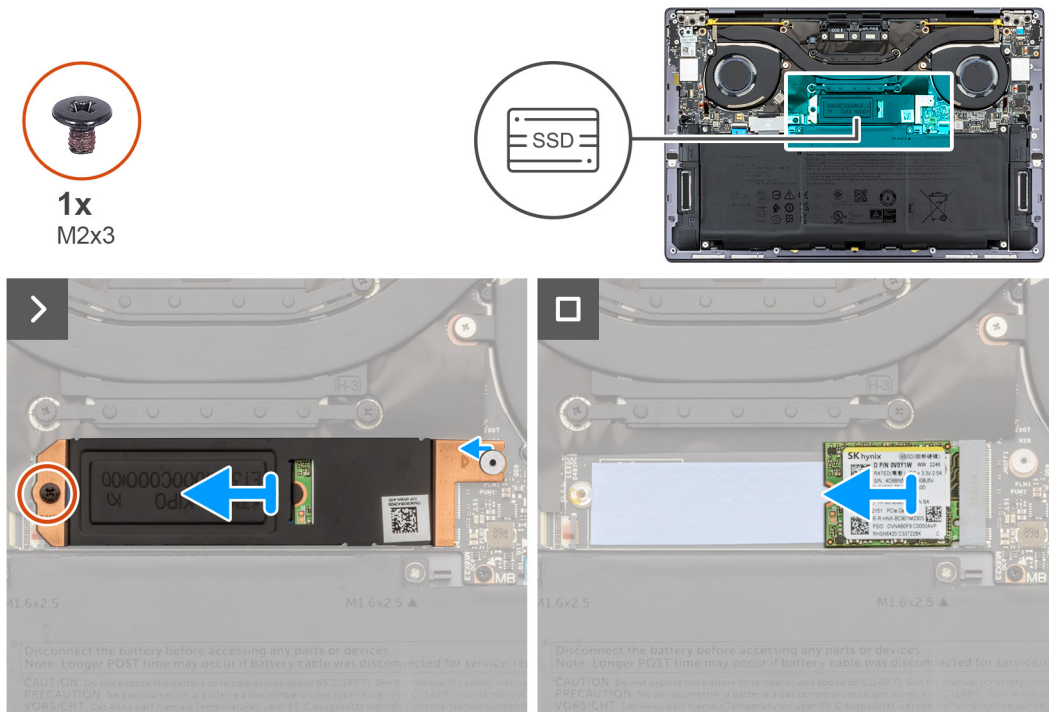

Figure 25. Removing the M.2 2230 solid-state drive

Steps

1. Remove the screw (M2x3) that secures the M.2 solid-state drive shield to the system board.
2. Slide the M.2 solid-state drive shield off the system board.
3. Slide the M.2 2230 solid-state drive out of the solid-state drive slot.

Installing the M.2 2230 solid-state drive

Prerequisites

If you are replacing a component, remove the existing component before performing the installation process.

About this task

The following images indicate the location of the M.2 2230 solid-state drive and provide a visual representation of the installation procedure.

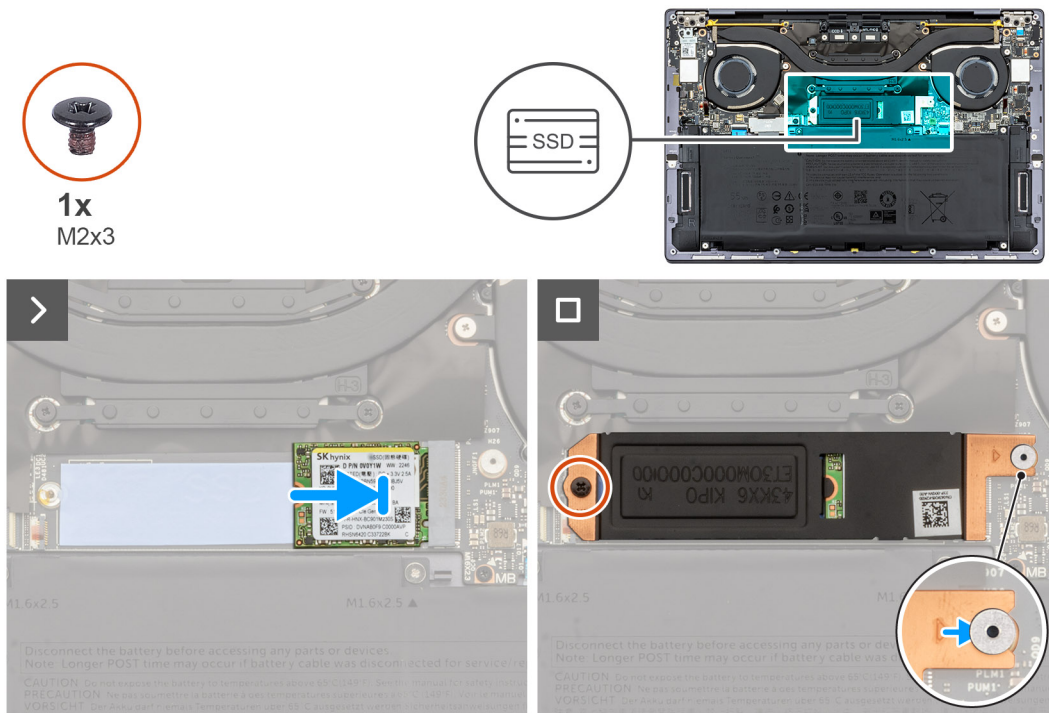

Figure 26. Installing the M.2 2230 solid-state drive

Steps

1. Align the notch on the M.2 2230 solid-state drive with the tab on the solid-state drive slot.
2. Slide the M.2 2230 solid-state drive into the solid-state drive slot.
3. Insert the tab of the M.2 solid-state drive shield into the peg on the system board.
4. Replace the screw (M2x3) that secures the M.2 solid-state drive shield to the system board.

Next steps

1. Install the [base cover](#).
2. Follow the procedure in [After working inside your computer](#).

Removing the M.2 2280 solid-state drive

Prerequisites

1. Follow the procedure in [Before working inside your computer](#).
2. Remove the [base cover](#).

About this task

NOTE: Depending on the configuration ordered, your computer may support an M.2 2230 solid-state drive or an M.2 2280 solid-state drive.

NOTE: This procedure applies only to computers shipped with an M.2 2280 solid-state drive.

The following images indicate the location of the M.2 2280 solid-state drive and provide a visual representation of the removal procedure.

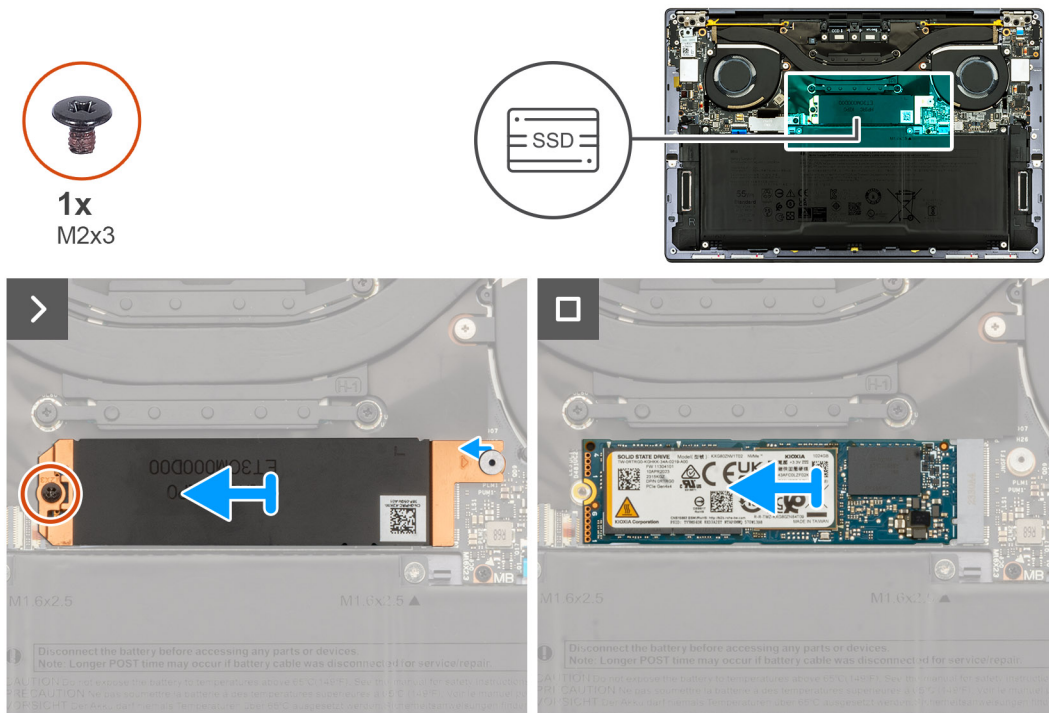

Figure 27. Removing the M.2 2280 solid-state drive

Steps

1. Remove the screw (M2x3) that secures the M.2 solid-state drive shield to the system board.
2. Lift the M.2 solid-state drive shield off the system board.
3. Slide the M.2 2280 solid-state drive out of the solid-state drive slot.
4. Lift the M.2 2280 solid-state drive assembly off the system board.

Installing the M.2 2280 solid-state drive

Prerequisites

If you are replacing a component, remove the existing component before performing the installation process.

About this task

NOTE: Depending on the configuration ordered, your computer may support an M.2 2230 solid-state drive or an M.2 2280 solid-state drive.

NOTE: This procedure applies only to computers shipped with an M.2 2230 solid-state drive.

The following image(s) indicate the location of the M.2 2280 solid-state drive and provides a visual representation of the installation procedure.

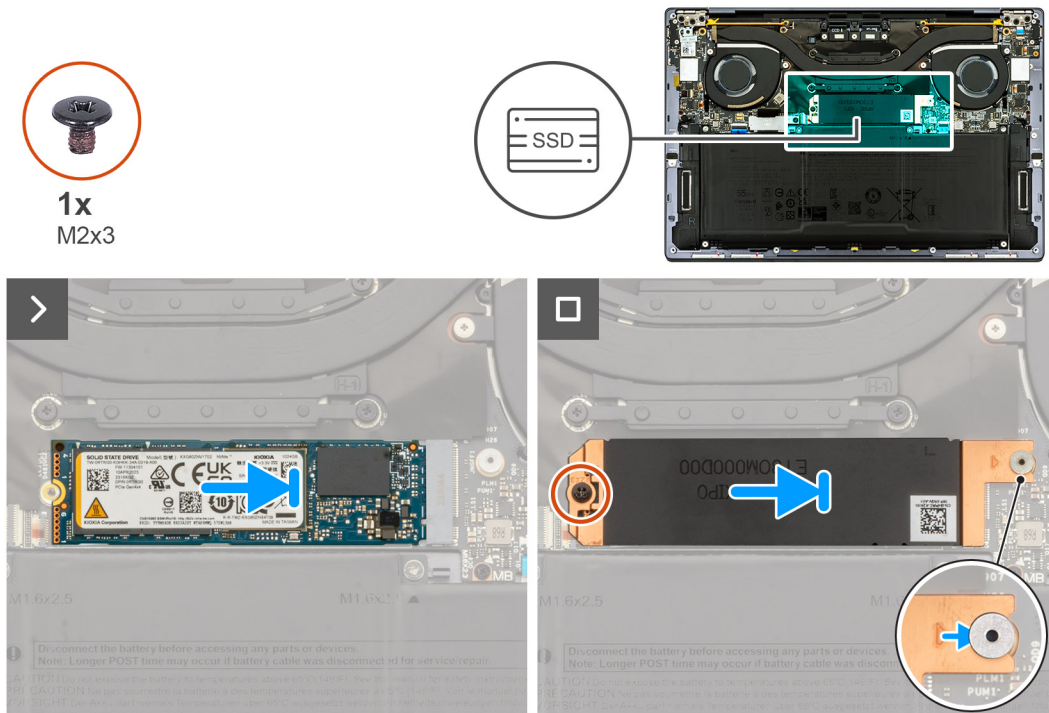

Figure 28. Installing the M.2 2280 solid-state drive

Steps

1. Align the notch on the M.2 2280 solid-state drive with the tab on the solid-state drive slot.
2. Slide the M.2 2280 solid-state drive into the solid-state drive slot.
3. Insert the tab of the M.2 solid-state drive shield into the peg on the system board.
4. Replace the screw (M2x3) that secures the M.2 solid-state drive shield to the system board.

Next steps

1. Install the [base cover](#).
2. Follow the procedure in [After working inside your computer](#).

Fans

Removing the fans

Prerequisites

1. Follow the procedure in [Before working inside your computer](#).
2. Remove the [base cover](#).

About this task

The following images indicate the location of the fans and provide a visual representation of the removal procedure.

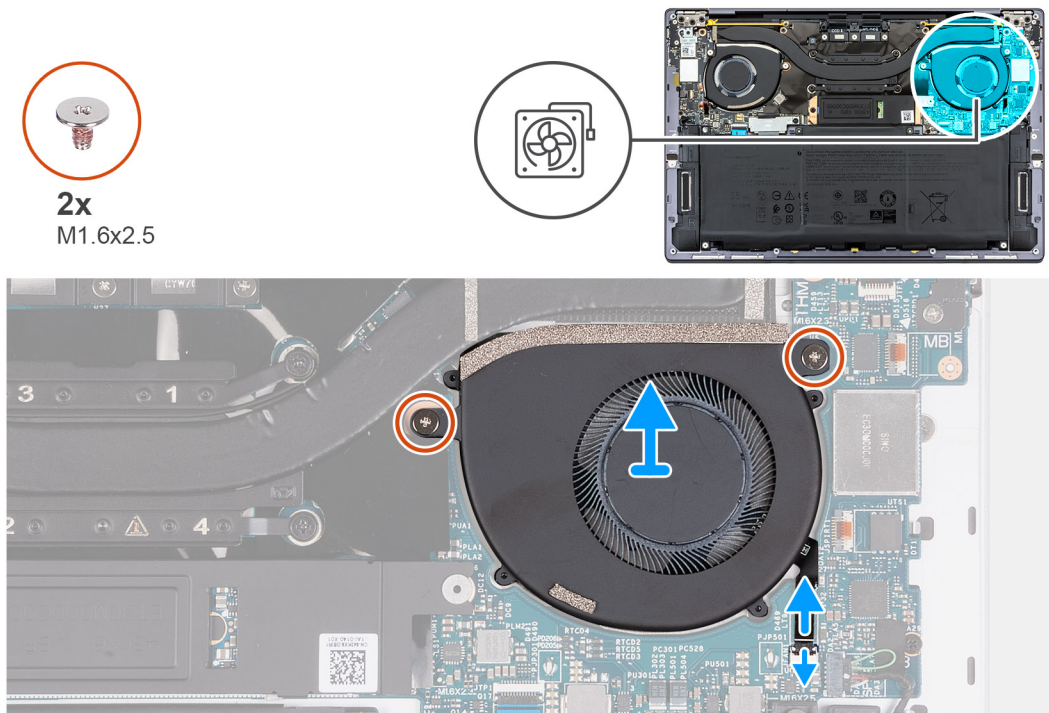

Figure 29. Removing the left fan

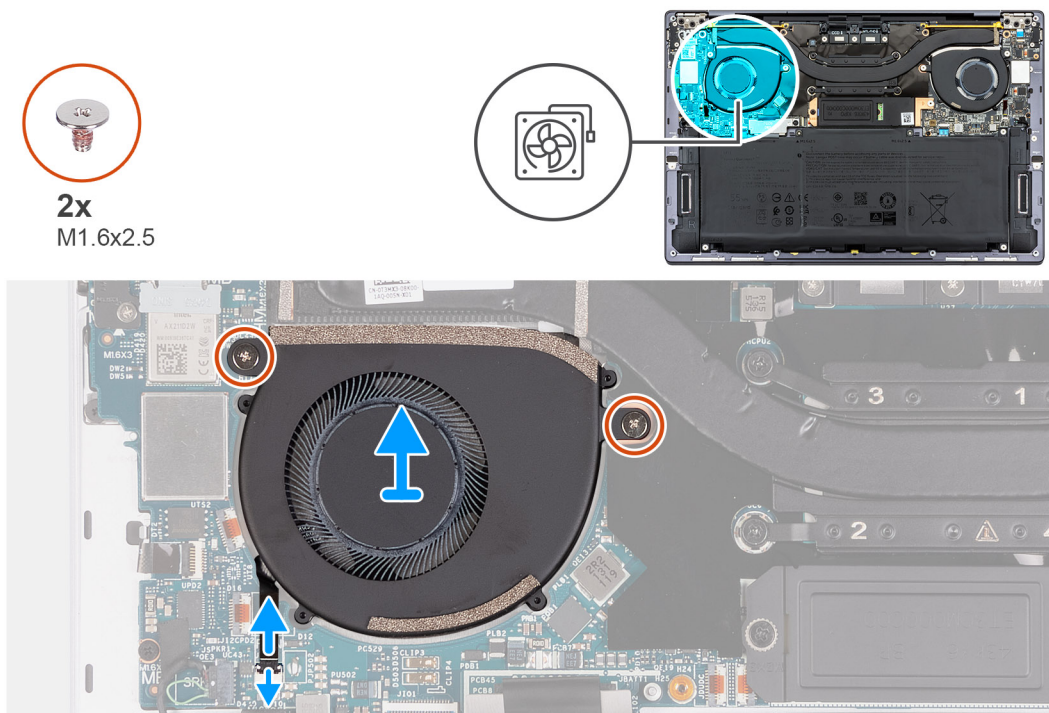

Figure 30. Removing the right fan

Steps

1. Lift the latch of left-fan cable connector, use the pull tab of the left-fan cable to disconnect it from the system board.
2. Remove the two screws (M1.6x2.5) that secure the left fan to the system board.
3. Lift the left fan off the system board.
4. Lift the latch of right-fan cable connector, use the pull tab of the right-fan cable to disconnect it from the system board.
5. Remove the two screws (M1.6x2.5) that secure the right fan to the system board.
6. Lift the right fan off the system board.

Installing the fans

Prerequisites

If you are replacing a component, remove the existing component before performing the installation process.

About this task

The following image(s) indicate the location of the fans and provides a visual representation of the installation procedure.

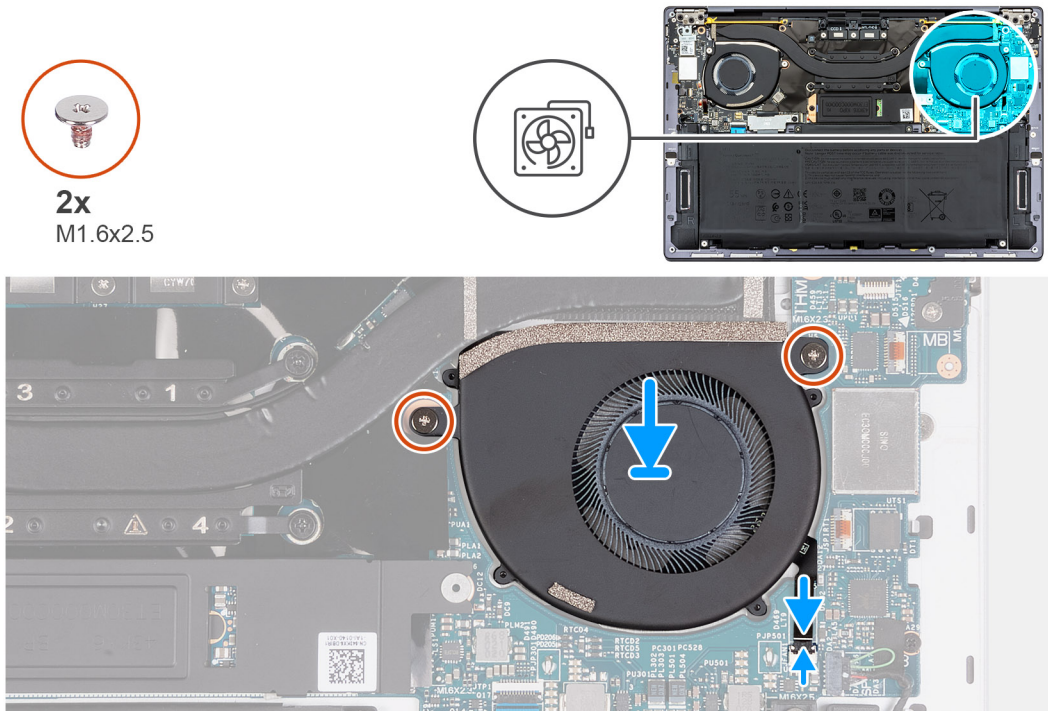

Figure 31. Installing the left fan

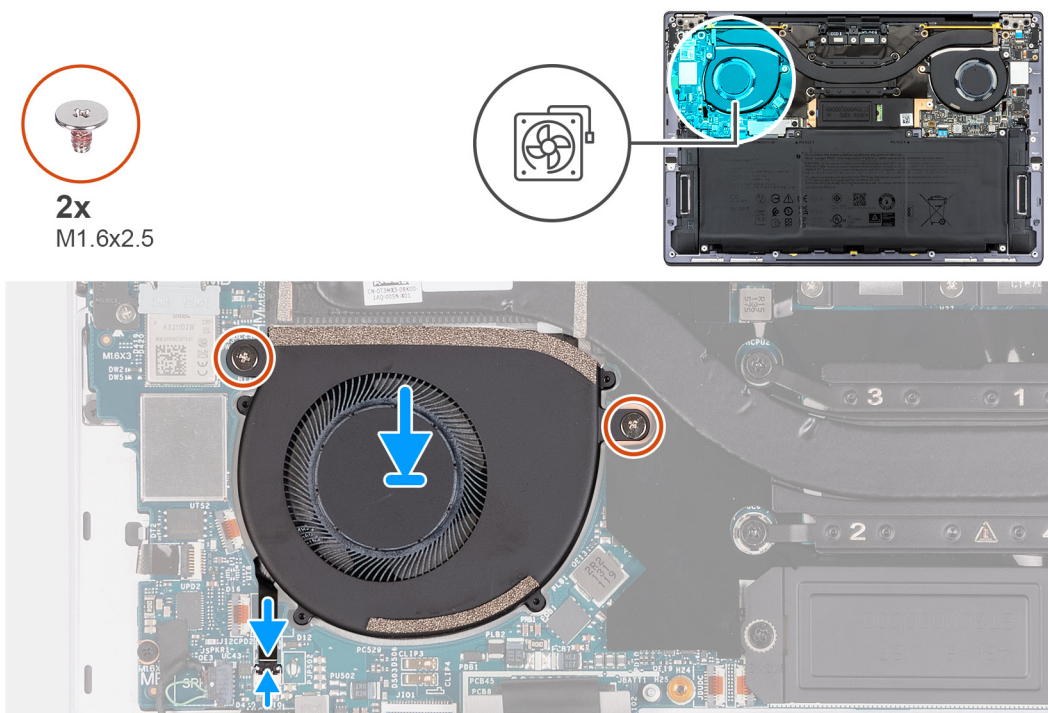

Figure 32. Installing the right fan

Steps

1. Align the screw holes of the left fan with the screw holes of the system board.
2. Replace the two screws (M1.6x2.5) that secure the left fan to the system board.
3. Connect the left fan cable to the system board.
4. Align the screw holes of the right fan with the screw holes of the system board.
5. Replace the two screws (M1.6x2.5) that secure the right fan to the system board.
6. Connect the right fan cable to the system board.

Next steps

1. Install the [base cover](#).
2. Follow the procedure in [After working inside your computer](#).

Heat sink

Removing the heat sink

Prerequisites

1. Follow the procedure in [Before working inside your computer](#).
2. Remove the [base cover](#).

About this task

CAUTION: The heat sink may become hot during normal operation. Allow sufficient time for the heat sink to cool before you touch it.

NOTE: For maximum cooling of the processor, do not touch the heat transfer areas on the heat sink. The oils in your skin can reduce the heat transfer capability of the thermal grease.

The following images indicate the location of the heat sink and provide a visual representation of the removal procedure.

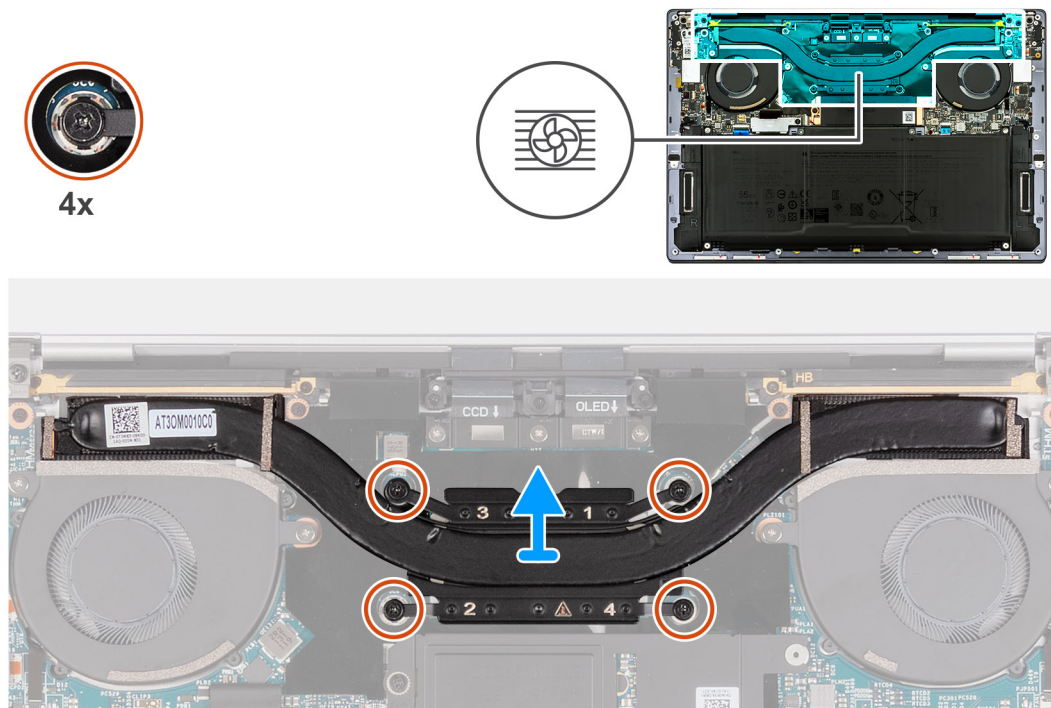

Figure 33. Removing the heat sink

Steps

1. In reverse sequential order (4>3>2>1) as indicated on the heat sink, loosen the four captive screws that secure the heat sink to the system board.
2. Lift the heat sink off the system board.

Installing the heat sink

Prerequisites

If you are replacing a component, remove the existing component before performing the installation process.

About this task

- NOTE:** Incorrect alignment of the heat sink can damage the system board and processor.
- NOTE:** If either the system board or the heat sink is replaced, use the thermal grease that is provided in the kit to ensure that that thermal conductivity is achieved.

The following images indicate the location of the heat sink and provide a visual representation of the installation procedure.

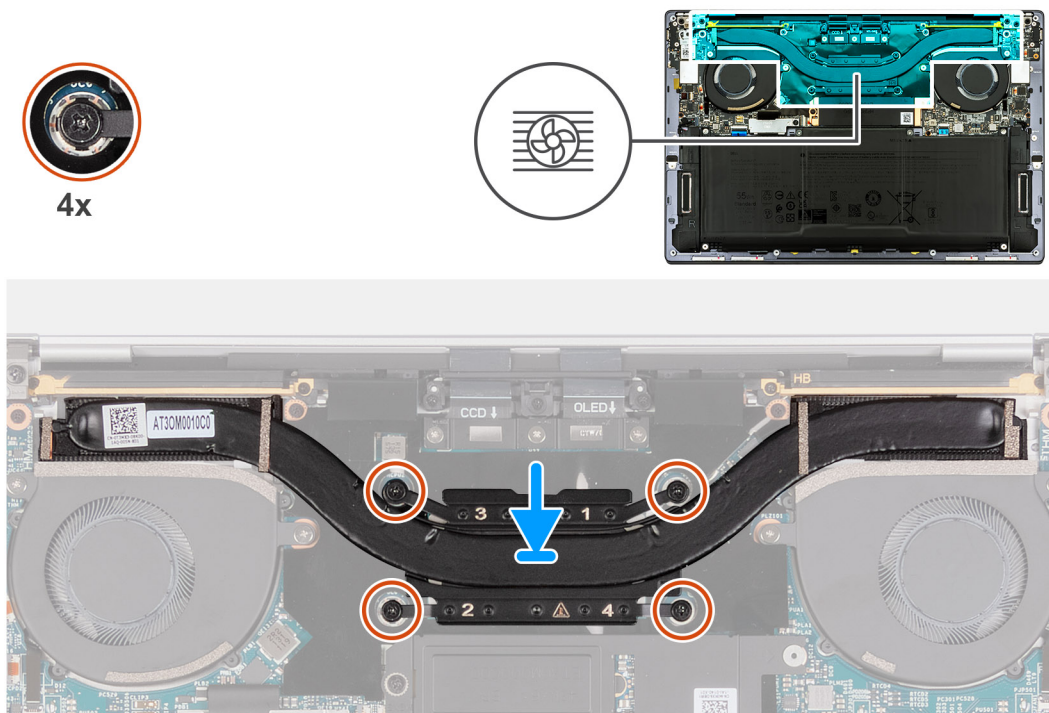

Figure 34. Installing the heat sink

Steps

1. Align the screw holes of the heat sink with the screw holes of the system board.
2. In sequential order (1>2>3>4) as indicated on the heat sink, tighten the four captive screws that secure the heat sink to the system board.

Next steps

1. Install the [base cover](#).
2. Follow the procedure in [After working inside your computer](#).

Display assembly

Removing the display assembly

Prerequisites

1. Follow the procedure in [Before working inside your computer](#).
2. Remove the [base cover](#).

About this task

The following images indicate the location of the display assembly and provide a visual representation of the removal procedure.

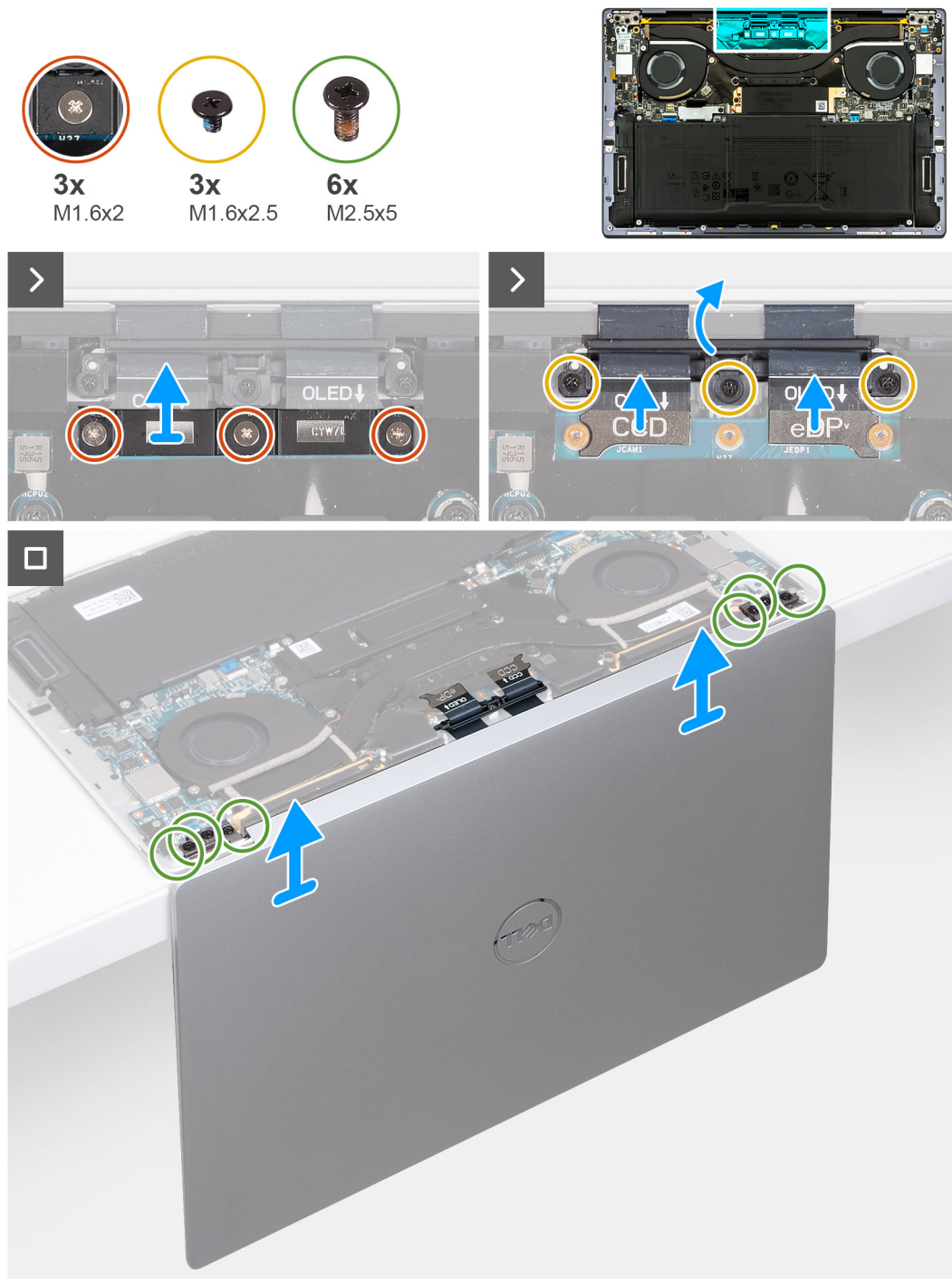

Figure 35. Removing the display assembly

Steps

1. Loosen the three captive screws (M1.6x2) that secure the display-assembly cable bracket to the system board.
2. Lift the display-assembly cable bracket off the system board.
3. Disconnect the camera cable and the display cable from the system board.
4. Remove the three screws (M1.6x2.5) that secure the camera and display-assembly cable holder to the system board.
5. Open the display to a 90-degree angle and place the computer at the edge of a flat table.
6. Remove the three screws (M2.5x5) that secure the left hinge to the system board and the palm-rest and keyboard assembly.
7. Remove the three screws (M2.5x5) that secure the right hinge to the system board and the palm-rest and keyboard assembly.

8. Lift the display assembly off the palm-rest and keyboard assembly.
9. After performing all the above steps, you are left with the display assembly.

Installing the display assembly

Prerequisites

If you are replacing a component, remove the existing component before performing the installation process.

About this task

The following images indicate the location of the display assembly and provide a visual representation of the installation procedure.



Figure 36. Installing the display assembly

Steps

1. Open the display assembly to a 90-degree angle and place the computer on the edge of a flat surface.
2. Place the palm-rest and keyboard assembly at the edge of a flat table.
3. Open the hinges of the display assembly to a 90-degree angle.
4. Align the screw holes of the palm-rest and keyboard assembly with the screw holes on the hinges of the display assembly.
5. Replace the three screws (M2.5x5) to secure the left hinge to the palm-rest and keyboard assembly.
6. Replace the three screws (M2.5x5) to secure the right hinge to the palm-rest and keyboard assembly.
7. Close the display assembly, turn the computer over and place it on the flat surface.
8. Slide the camera and display-assembly cable holder back to the system board.

9. Replace three screws (M1.6x2.5) that secure the camera and display-assembly cable holder to the system board.
10. Connect the camera cable and the display cable to the system board.
11. Align the screw holes on the display-assembly cable bracket with the screw holes on the system board and tighten the three captive screws (M1.6x2).

Next steps

1. Install the [base cover](#).
2. Follow the procedure in [After working inside your computer](#).

System board

Removing the system board

Prerequisites

1. Follow the procedure in [Before working inside your computer](#).
2. Remove the [base cover](#).
3. Remove the [M.2 2230 solid-state drive](#) or [M.2 2280 solid-state drive](#) from M.2 slot, whichever is applicable.
4. Remove the [battery](#).
5. Remove the [fans](#).
6. Remove the [heat sink](#).

About this task

The following image indicates the connectors and components on your system board.

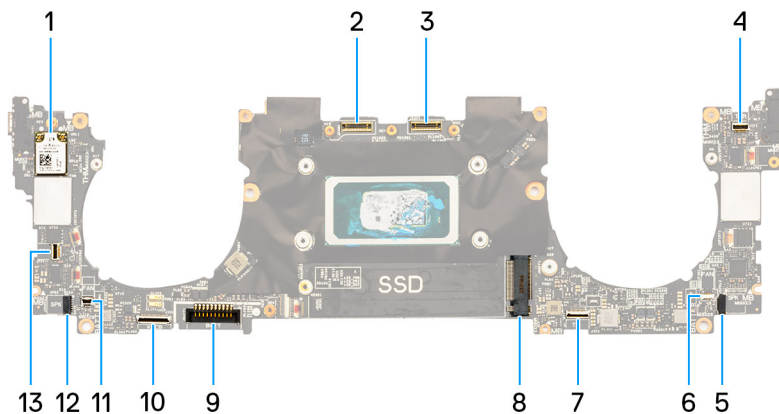

Figure 37. System-board connectors

- | | |
|---|--|
| 1. Wireless card | 2. Camera-assembly cable connector |
| 3. Display-assembly cable connector | 4. Capacitive touch-panel cable connector |
| 5. Left-speaker cable connector | 6. Left-fan cable connector |
| 7. Haptic-module cable connector | 8. M.2 solid-state drive slot |
| 9. Battery cable connector | 10. Keyboard-daughterboard cable connector |
| 11. Right-fan cable connector | 12. Right-speaker cable connector |
| 13. Power-button and fingerprint-reader cable connector | |

The following images indicate the location of the system board and provide a visual representation of the removal procedure.

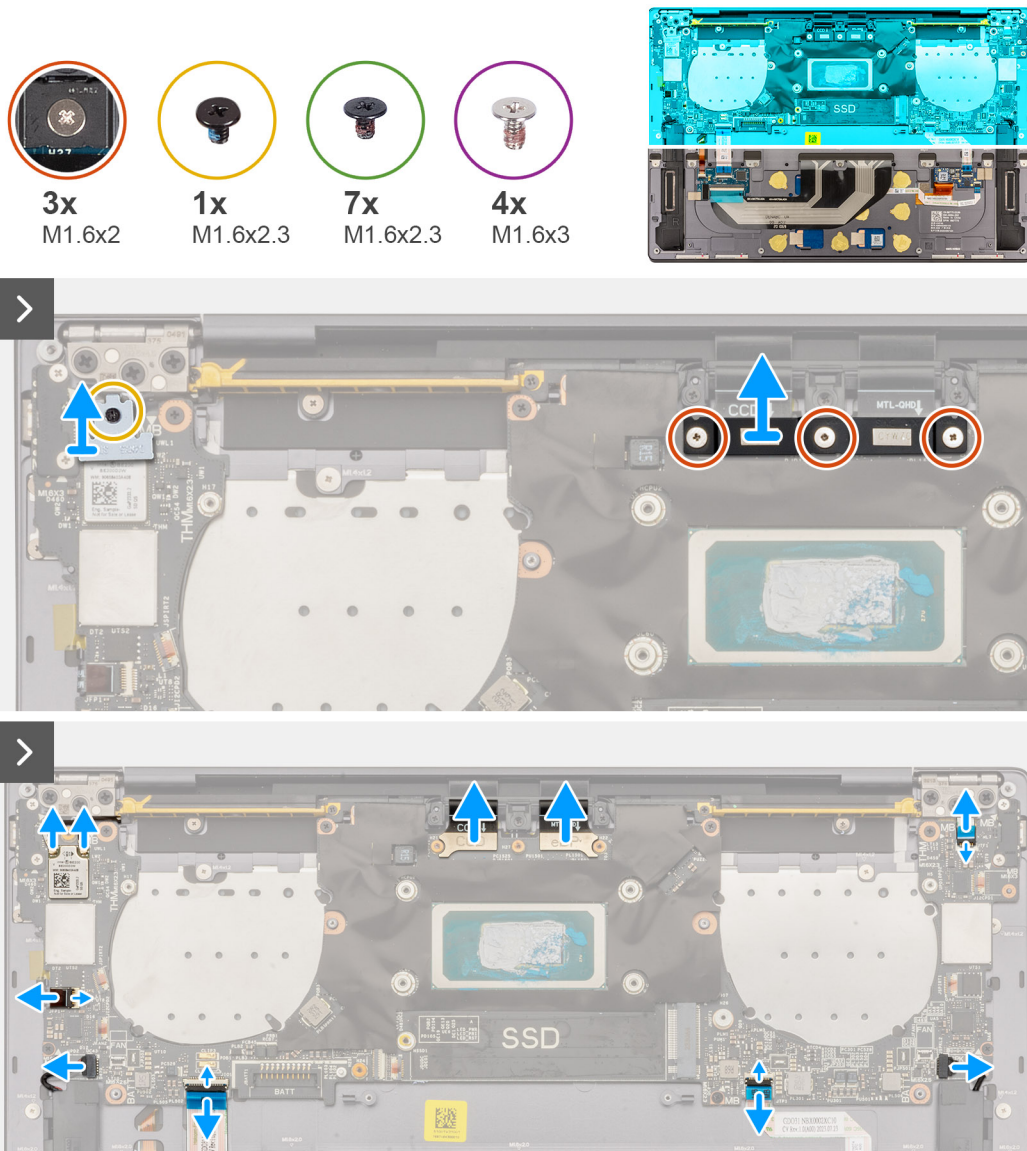

Figure 38. Removing the system board

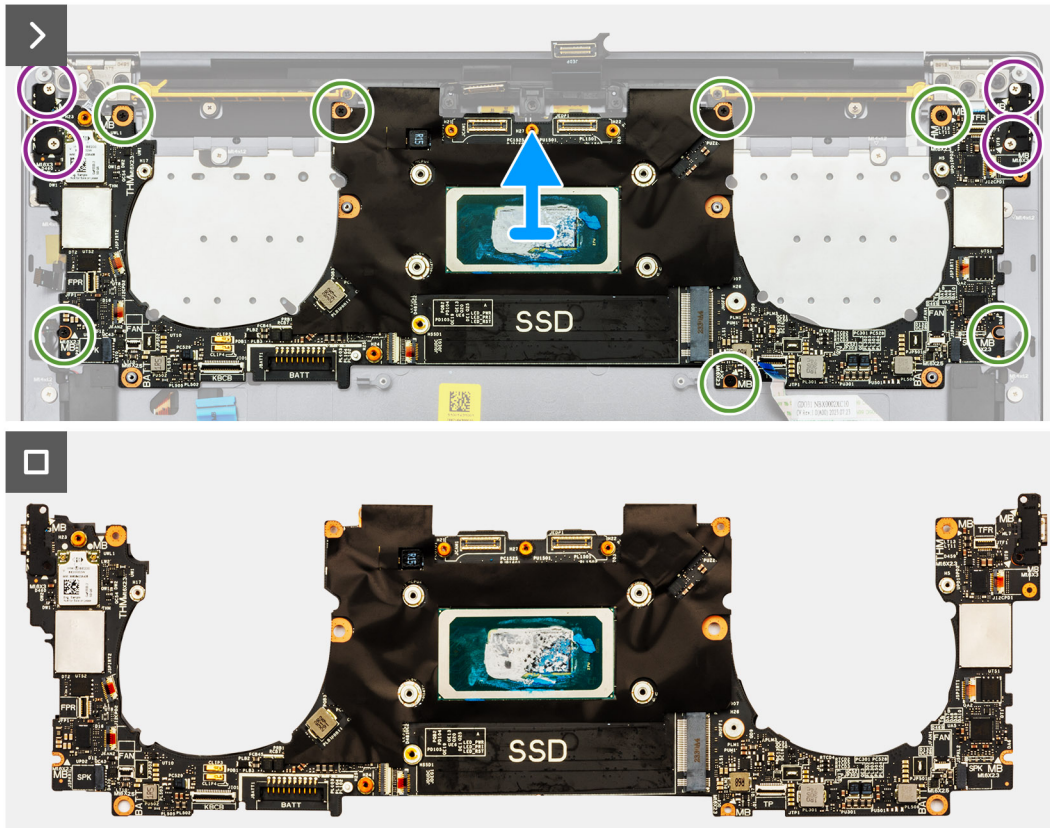

Figure 39. Removing the system board

Steps

- NOTE:** When removing the system board, open the display assembly to a 90-degree angle and then place the computer on the edge of a flat surface. Ensure to maintain the angle throughout the removal process to minimize the risk of damaging the thin display panel when applying torque to install and remove screws from the computer.



Figure 40. Opening the display assembly to a 90-degree angle

1. Loosen the captive screw (M1.6x2.3) that secures the wireless-module bracket to the system board.
i **NOTE:** Be sure that the small, clear washer that holds the captive screw in place does not fall off.
2. Lift the wireless-module bracket off the system board.
3. Disconnect the wireless-module cables from the wireless module.
4. Loosen the three captive screws (M1.6x2) that secure the display-assembly cable bracket to the system board.
5. Lift the display-assembly cable bracket off the system board.
6. Disconnect the camera cable and the display cable from the system board.
7. Lift the latch of the capacitive touch-panel connector and use the pull tab of the cable to disconnect the capacitive touch-panel cable.
8. Use the pull tab to disconnect the left-speaker cable.
9. Lift the latch of the haptic-module cable connector and use the pull tab of the cable to disconnect the haptic-module cable.
10. Lift the latch of the keyboard control-board connector and use the pull tab of the cable to disconnect the keyboard control-board cable.
11. Use the pull tab to disconnect the right-speaker cable.
12. Lift the latch of the power-button connector and use the pull tab of the cable to disconnect the power-button cable.
13. Remove the four screws (M1.6x3) that secure the system board to the palm-rest and keyboard assembly.
14. Remove the seven screws (M1.6x2.3) that secure the system board to the palm-rest and keyboard assembly.
15. Hold the system board by the short edges, as shown in the image, and lift the board off the palm-rest and keyboard assembly with care.

Installing the system board

Prerequisites

If you are replacing a component, remove the existing component before performing the installation process.

About this task

The following image indicates the connectors and components on your system board.

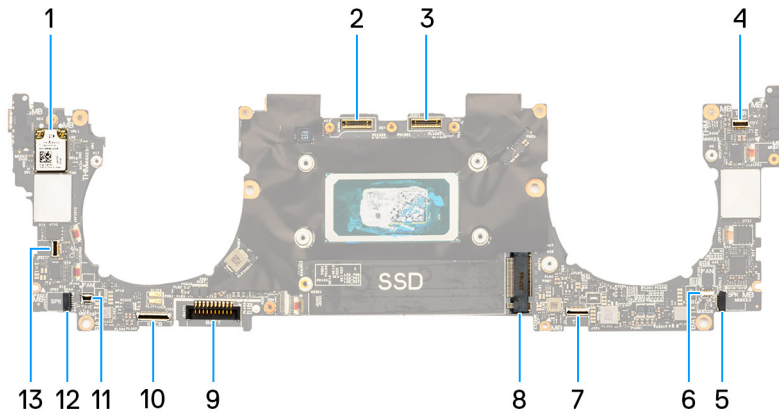

Figure 41. System-board connectors

- 1. Wireless card
- 2. Camera-assembly cable connector
- 3. Display-assembly cable connector
- 4. Capacitive touch-panel cable connector
- 5. Left-speaker cable connector
- 6. Left-fan cable connector
- 7. Haptic-module cable connector
- 8. M.2 solid-state drive slot
- 9. Battery cable connector
- 10. Keyboard-daughterboard cable connector
- 11. Right-fan cable connector
- 12. Right-speaker cable connector
- 13. Power-button and fingerprint-reader cable connector

The following images indicate the location of the system board and provide a visual representation of the installation procedure.

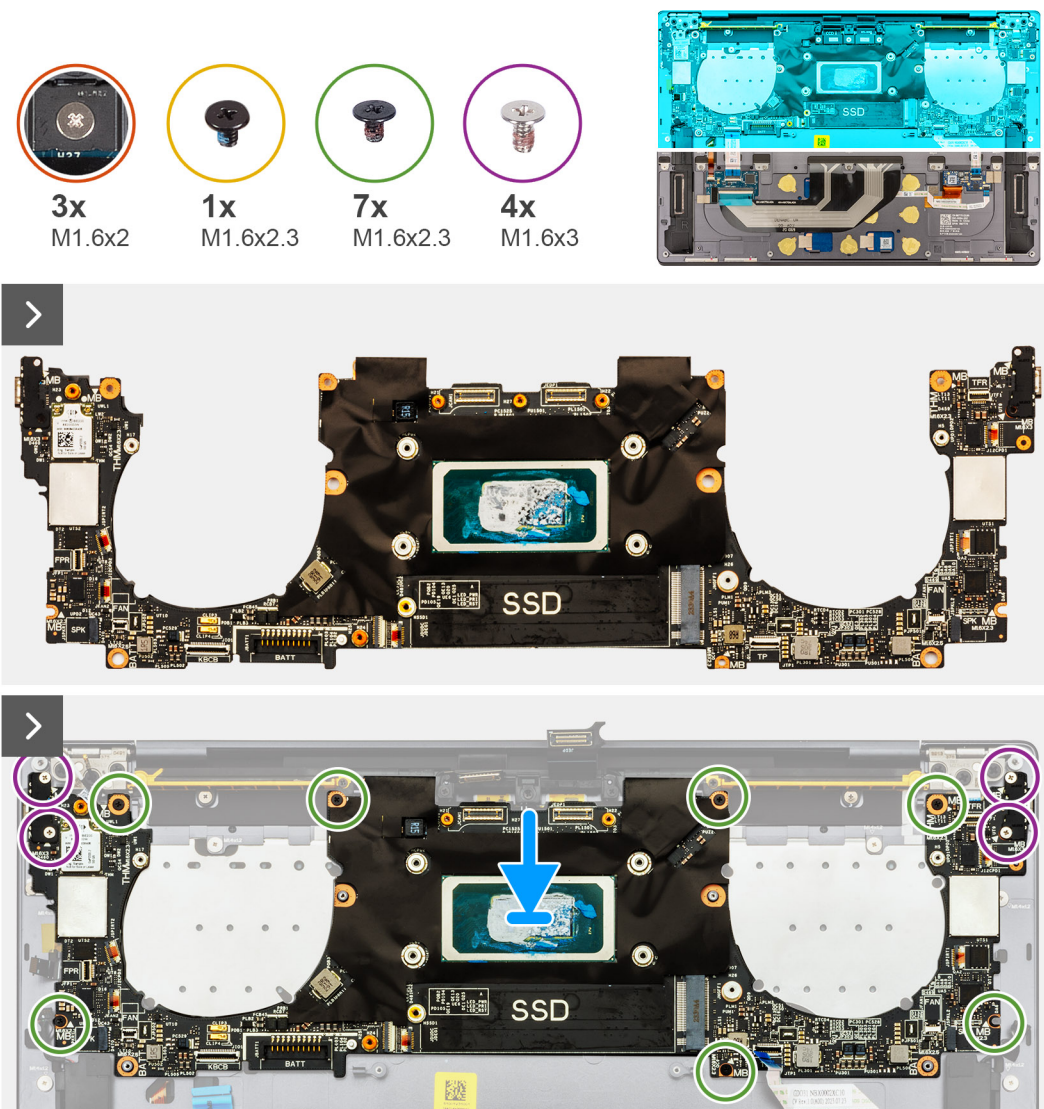

Figure 42. Installing the system board

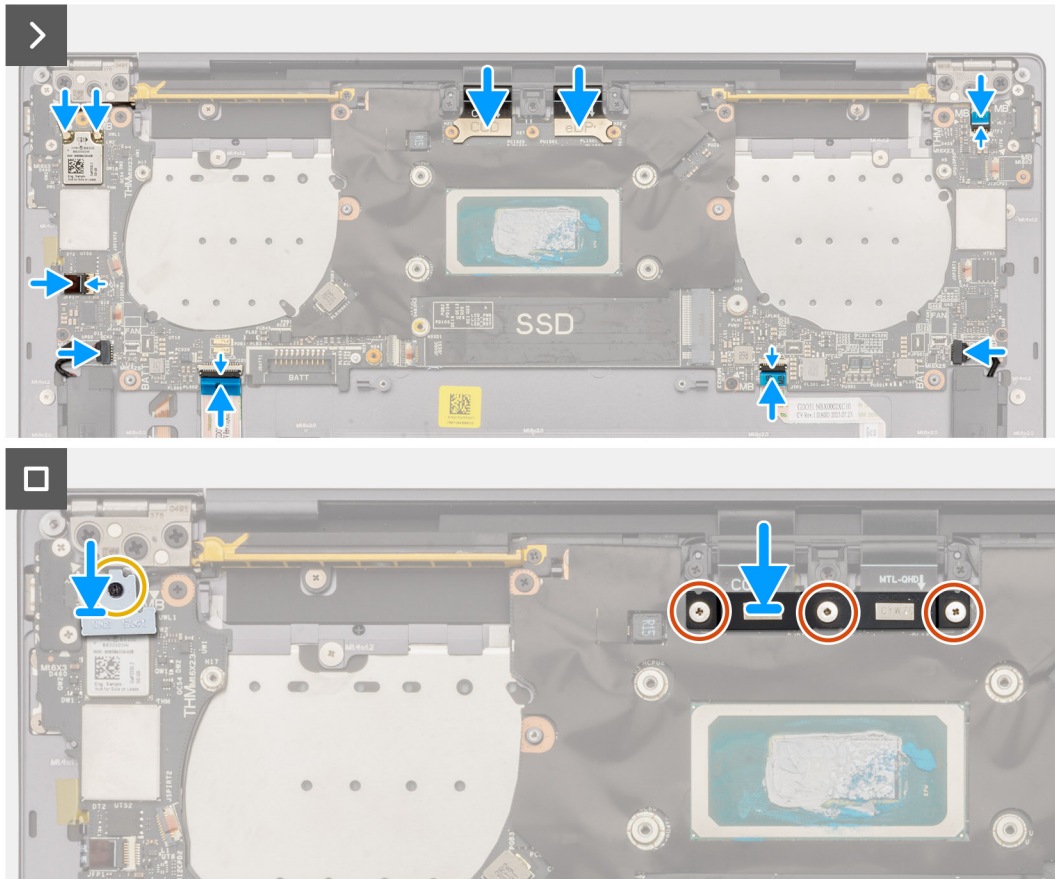

Figure 43. Installing the system board

Steps

i **NOTE:** When installing the system board, open the display assembly to a 90-degree angle and then place the computer on the edge of a flat surface. Ensure to maintain the angle throughout the installation process to minimize the risk of damaging the thin display panel when applying torque to install and remove screws from the computer.



Figure 44. Opening the display assembly to a 90-degree angle

1. Align the screw holes on the system board with the screw holes on the palm-rest and keyboard assembly.
2. Hold the system board by the short edges, as shown in the image, and place the system board on the palm-rest and keyboard assembly. Ensure that the Thunderbolt 4 ports are aligned with their corresponding port holes on the palm-rest and keyboard assembly.
3. Replace the seven screws (M1.6x2.3) that secure the system board to the palm-rest and keyboard assembly.
4. Replace the four screws (M1.6x3) that secure the system board to the palm-rest and keyboard assembly.
5. Connect the power-button cable and close the latch of the power-button connector.
6. Connect the right-speaker cable.
7. Connect the keyboard control-board cable and close the latch of the keyboard control-board connector.
8. Connect the touchpad cable and close the latch of the touchpad connector.
9. Connect the left-speaker cable.
10. Connect the capacitive touch-panel cable and close the latch of the capacitive touch-panel connector.
11. Connect the camera cable and the display cable to the system board.
12. Connect the wireless-module cables from the wireless module.
13. Replace the display-assembly cable bracket on the system board.
14. Tighten the three captive screws (M1.6x2) that secure the display-assembly cable bracket to the system board.
15. Replace the wireless-module bracket on the system board.
16. Tighten the captive screw (M1.6x2.3) that secures the wireless-module bracket to the system board.

NOTE: Be sure that the small, clear washer that holds the captive screw is in place before tightening the screw.

Next steps

1. Install the [heat sink](#).
2. Install the [fans](#).

3. Install the [battery](#).
4. Install the [M.2 2230 solid-state drive](#) or [M.2 2280 solid-state drive](#) from M.2 slot, whichever is applicable.
5. Install the [base cover](#).
6. Follow the procedure in [After working inside your computer](#).

Power button with fingerprint reader

Removing the power button with fingerprint reader

Prerequisites

1. Follow the procedure in [Before working inside your computer](#).
2. Remove the [base cover](#).
3. Remove the [battery](#).
4. Remove the [system board](#).

NOTE: The system board can be removed with the following components attached:

- heat sink
- fans
- solid-state drive

About this task

The following images indicate the location of the power button with fingerprint reader and provide a visual representation of the removal procedure.

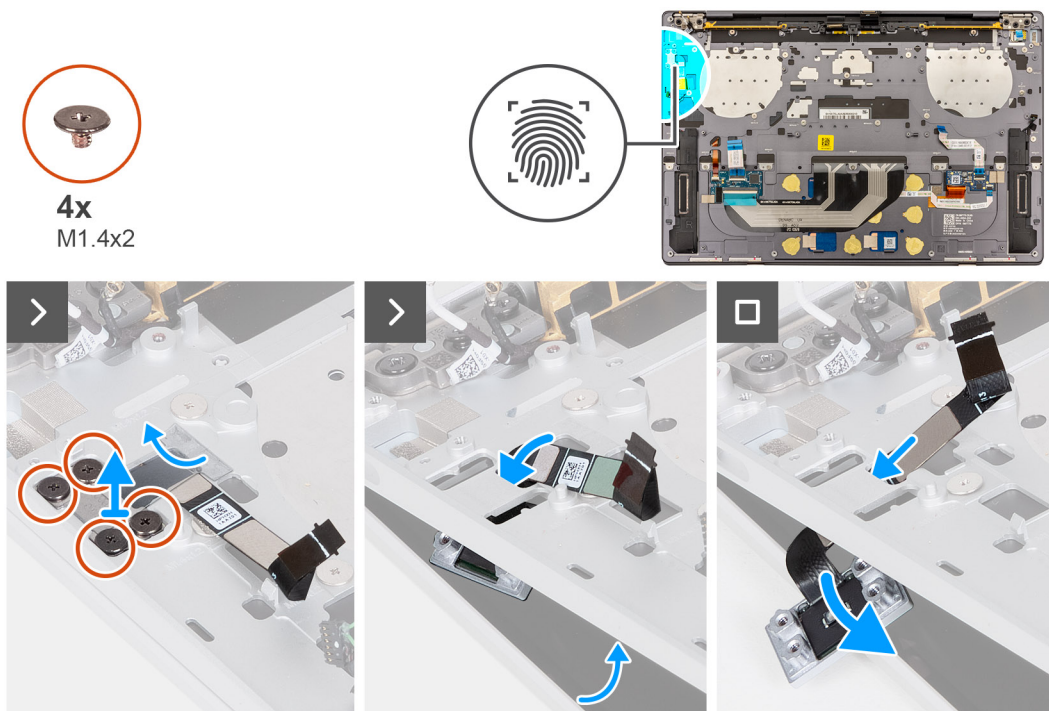

Figure 45. Removing the power button with fingerprint reader

Steps

NOTE: When removing the power button with fingerprint reader, open the display assembly to a 90-degree angle and then place the computer on the edge of a flat surface. Ensure to maintain the angle throughout the removal process to minimize the risk of damaging the thin display panel when applying torque to install and remove screws from the computer.



Figure 46. Opening the display assembly to a 90-degree angle

1. Open the display assembly to a 90-degree angle and place the computer on the edge of a flat surface.
2. Remove the four screws (M1.4x2) that secure the power-button bracket to the palm-rest and keyboard assembly.
3. Lift the power-button bracket off the palm-rest and keyboard assembly.
4. Lift the palm-rest and keyboard assembly slightly.
5. Unthread the power-button cable through the opening on the palm-rest and keyboard assembly and remove the power button with fingerprint reader.

Installing the power button with fingerprint reader

Prerequisites

If you are replacing a component, remove the existing component before performing the installation process.

About this task

The following images indicate the location of the power button with fingerprint reader and provide a visual representation of the installation procedure.

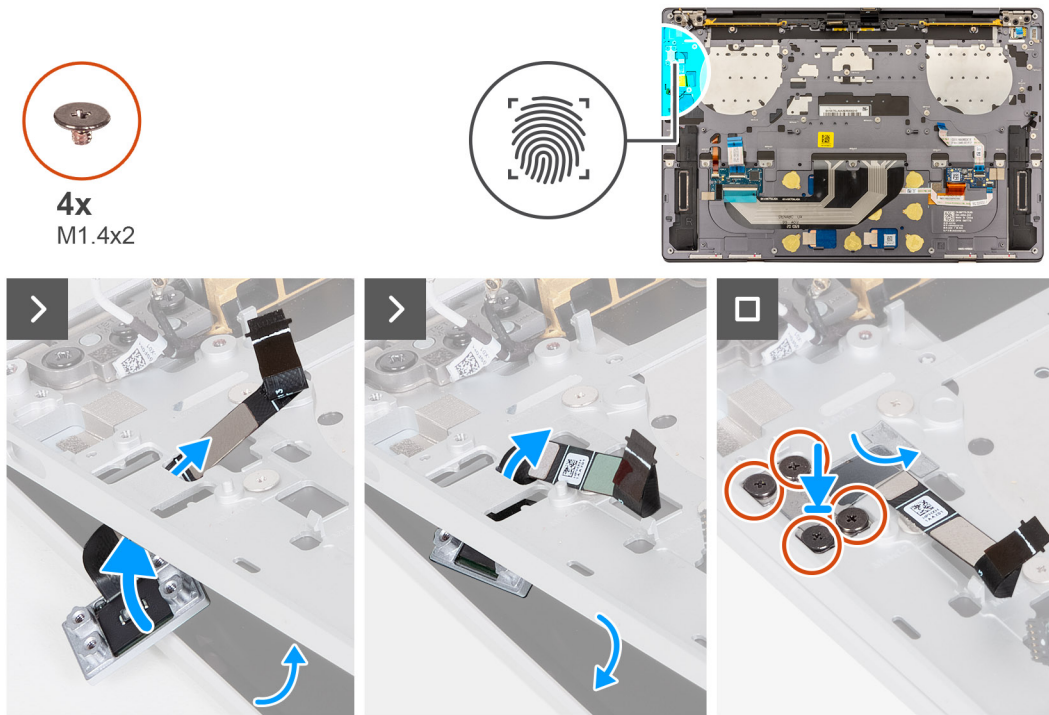

Figure 47. Installing the power button with fingerprint reader

Steps

i NOTE: When installing the power button with fingerprint reader, open the display assembly to a 90-degree angle and then place the computer on the edge of a flat surface. Ensure to maintain the angle throughout the installation process to minimize the risk of damaging the thin display panel when applying torque to install and remove screws from the computer.



Figure 48. Opening the display assembly to a 90-degree angle

1. Open the display assembly to a 90-degree angle and place the computer on the edge of a flat surface.
2. Thread the power-button cable through the opening on the palm-rest and keyboard assembly.
3. Place the power button with fingerprint reader on the palm-rest and keyboard assembly.
4. Align the screw holes of the power button with the screw holes of the power-button bracket.
5. Replace the four screws (M1.4x2) that secure the power-button bracket to the palm-rest and keyboard assembly.

Next steps

1. Install the [system board](#).
 - i** **NOTE:** The system board can be replaced with the following components attached:
 - heat sink
 - fans
 - solid-state drive
2. Install the [battery](#).
3. Install the [base cover](#).
4. Follow the procedure in [After working inside your computer](#).

Keyboard

Removing the keyboard

Prerequisites

1. Follow the procedure in [Before working inside your computer](#).
2. Remove the [base cover](#).

3. Remove the [battery](#).
4. Remove the [system board](#).
 - i** **NOTE:** The system board can be removed with the following components attached:
 - heat sink
 - fans
 - solid-state drive
5. Remove the [power button with fingerprint reader](#).

About this task

The following images indicate the location of the keyboard and provide a visual representation of the removal procedure.

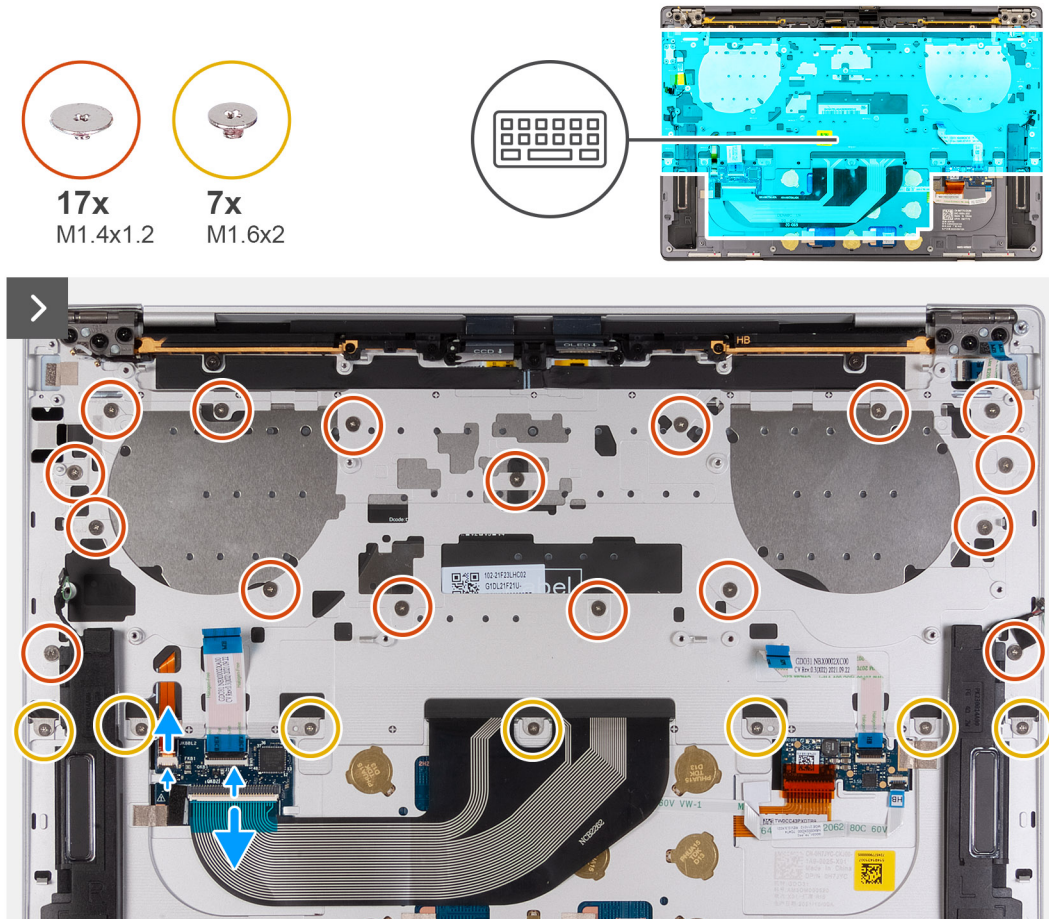

Figure 49. Removing the keyboard

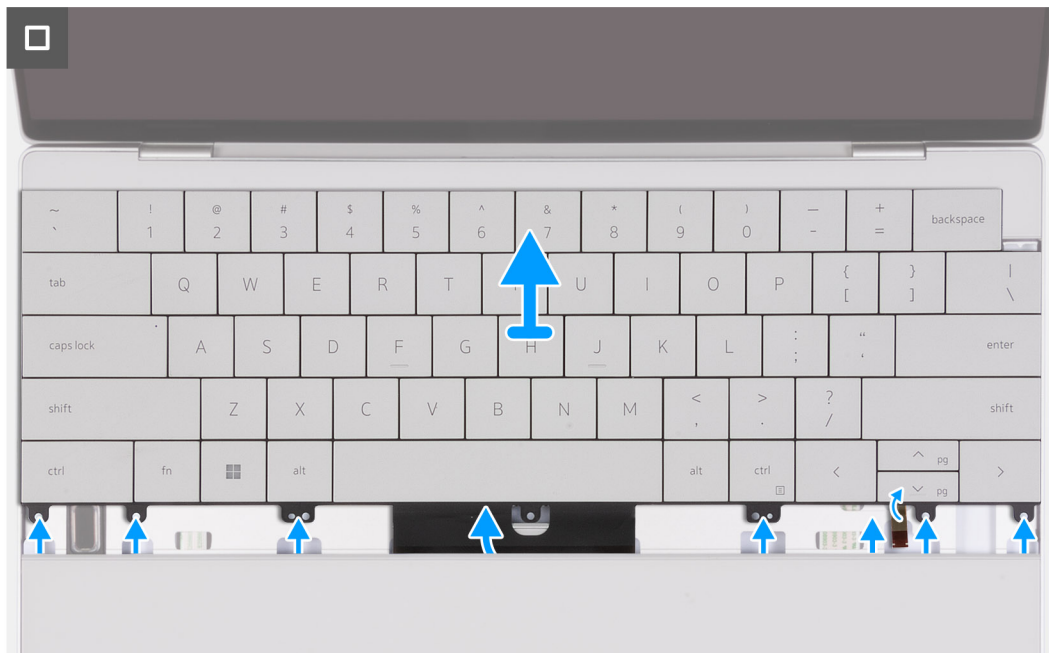

Figure 50. Removing the keyboard

Steps

NOTE: When removing the keyboard, open the display assembly to a 90-degree angle and then place the computer on the edge of a flat surface. Ensure to maintain the angle throughout the removal process to minimize the risk of damaging the thin display panel when applying torque to install and remove screws from the computer.



Figure 51. Opening the display assembly to a 90-degree angle

1. Remove the 17 screws (M1.4x1.2) that secure the keyboard to the palm-rest assembly.
2. Remove the seven screws (M1.6x2) that secure the keyboard to the palm-rest assembly.
3. Lift the latch of the keyboard-backlight connector and use the pull tab of the cable to disconnect the keyboard-backlight cable.
4. Lift the latch of the keyboard connector and use the pull tab of the cable to disconnect the keyboard cable.
5. Unthread the keyboard-backlight cable and the keyboard cable through the openings of the palm-rest assembly.
6. Lift the keyboard off the palm-rest assembly until the tabs of the keyboard are out from the openings on the palm-rest assembly.

Installing the keyboard

Prerequisites

If you are replacing a component, remove the existing component before performing the installation process.

About this task

The following images indicate the location of the keyboard and provide a visual representation of the installation procedure.

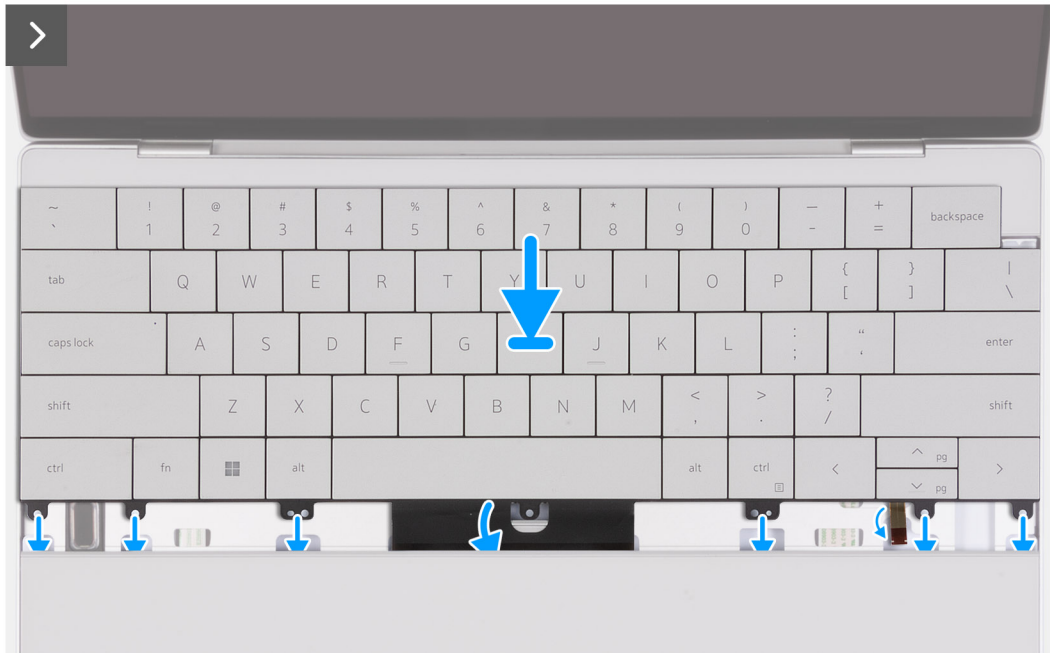

Figure 52. Installing the keyboard

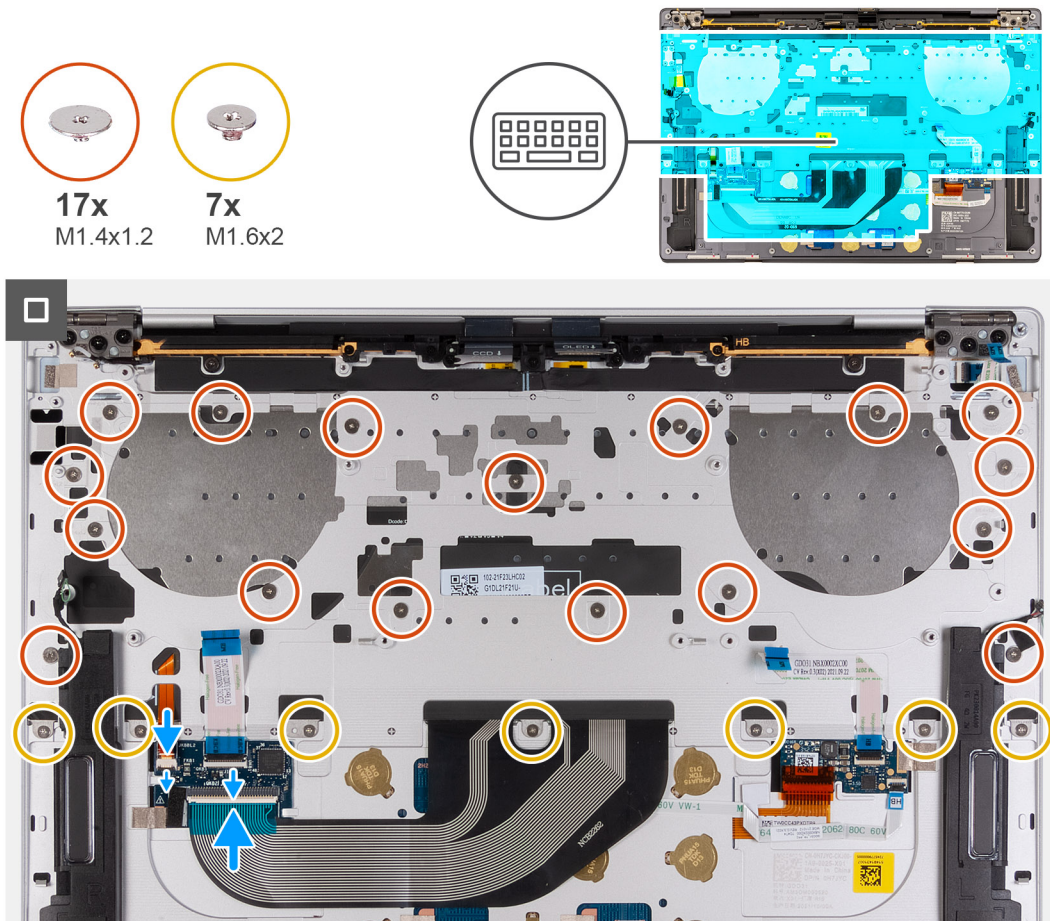

Figure 53. Installing the keyboard

Steps

- NOTE:** When installing the keyboard, open the display assembly to a 90-degree angle and then place the computer on the edge of a flat surface. Ensure to maintain the angle throughout the installation process to minimize the risk of damaging the thin display panel when applying torque to install and remove screws from the computer.



Figure 54. Opening the display assembly to a 90-degree angle

1. Align the screw holes of the keyboard with the screw holes of the palm-rest assembly.
2. Thread the keyboard-backlight cable and the keyboard cable through the openings at the center and right side of the palm rest and insert the tabs on the keyboard into the openings on the palm rest.
3. Replace the seven screws (M1.6x2) to secure the keyboard to the palm-rest assembly.
4. Replace the 17 screws (M1.4x1.2) to secure the keyboard to the palm-rest assembly.
5. Connect the keyboard-backlight cable and close the latch of the keyboard-backlight connector.
6. Connect the keyboard cable and close the latch of the keyboard connector.

Next steps

1. Install the [power button with fingerprint reader](#).
2. Install the [system board](#).

NOTE: The system board can be replaced with the following components attached:

- heat sink
 - fans
 - solid-state drive
3. Install the [battery](#).
 4. Install the [base cover](#).
 5. Follow the procedure in [After working inside your computer](#).

Palm-rest assembly

Removing the palm-rest assembly

Prerequisites

1. Follow the procedure in [Before working inside your computer](#).
2. Remove the [base cover](#).
3. Remove the [battery](#).
4. Remove the [display assembly](#).
5. Remove the [system board](#).

i NOTE: The system board can be removed with the following components attached:

- heat sink
- fans
- solid-state drive

6. Remove the [power button with fingerprint reader](#).
7. Remove the [keyboard](#).

About this task

The following images indicate the location of the palm-rest assembly and provide a visual representation of the removal procedure.

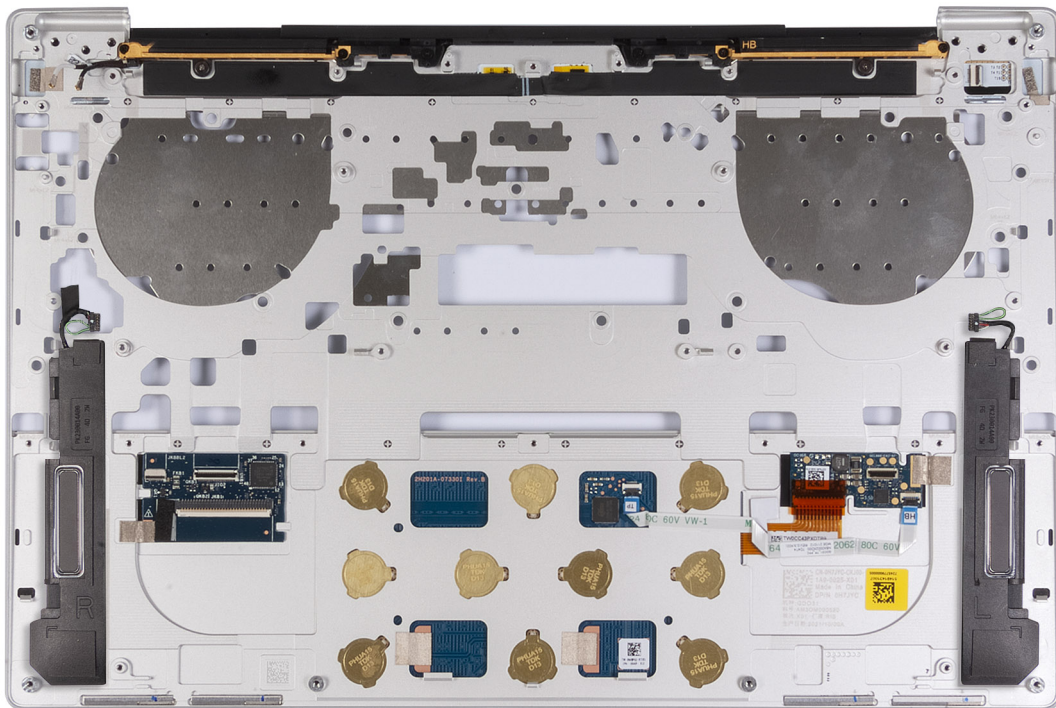

Figure 55. Removing the palm-rest assembly

Steps

After performing the steps in the pre-requisites, you are left with the palm-rest assembly.

Installing the palm-rest assembly

Prerequisites

If you are replacing a component, remove the existing component before performing the installation process.

About this task

NOTE: The replacement palm-rest assembly comes preassembled with the following components that include the following:

- palm rest
- speakers
- wireless-antenna modules
- touchpad
- haptic module
- keyboard control daughterboard

The following images indicate the location of the palm-rest assembly and provide a visual representation of the installation procedure.

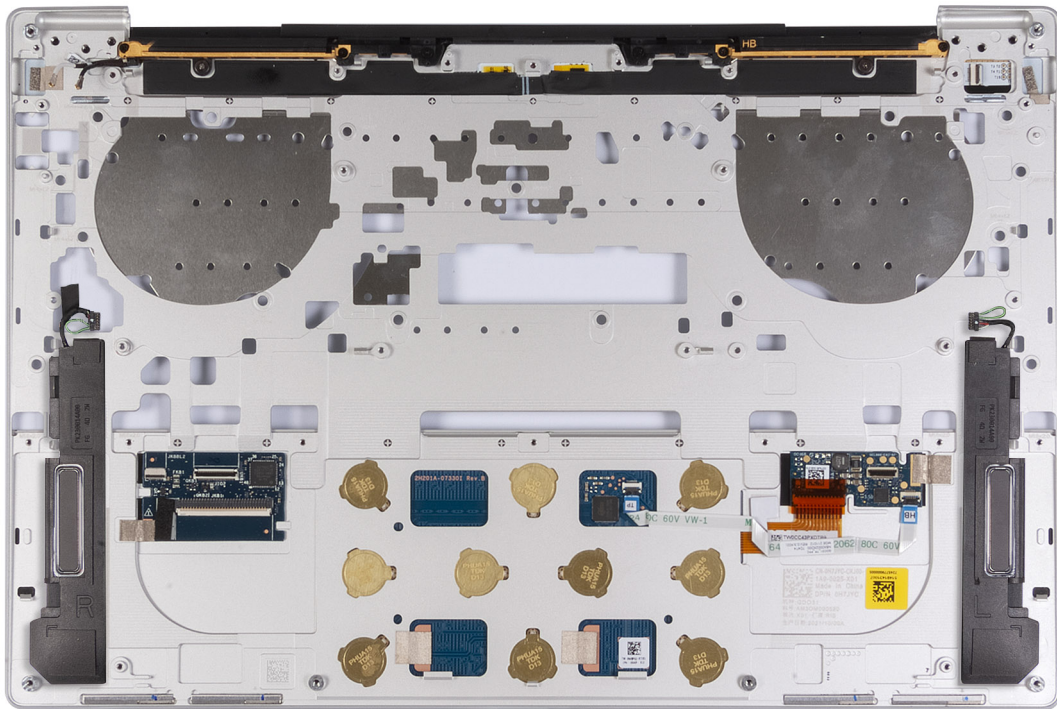

Figure 56. Installing the palm-rest assembly

Steps

Place the palm-rest assembly on a flat surface.

Next steps

1. Install the [keyboard](#).
2. Install the [power button with fingerprint reader](#).
3. Install the [system board](#).

NOTE: The system board can be replaced with the following components preattached:

- heat sink
- fans
- solid-state drive

4. Install the [display assembly](#).

5. Install the [battery](#).
6. Install the [base cover](#).
7. Follow the procedure in [After working inside your computer](#).

Software

This chapter details the supported operating systems along with instructions on how to install the drivers.

Operating system

Your XPS 13 9340 supports the following operating systems:

- Windows 11 Pro
- Windows 11 Pro National Education
- Windows 11 Home
- Ubuntu Linux 22.04 LTS

Drivers and downloads

When troubleshooting, downloading, or installing drivers, it is recommended that you read the Dell Knowledge Base article [Drivers and Downloads FAQs 000123347](#).

Technology and components

NOTE: Instructions that are provided in the following section are applicable on computers that are shipped with the Windows operating system. Windows is factory-installed with this computer.

Intel Arc Graphics

The following table lists the Intel Arc Graphics specifications.

Table 27. Intel Arc Graphics specifications

Description	Values
Bus type	Integrated graphics NOTE: Intel Arc Graphics uses the computers memory as video memory.
Memory type	LPDDR5/LPDDR5x
Memory interface	N/A (Unified Memory Architecture)
Estimated maximum power consumption (TDP)	12 W-28 W, included in the CPU power
Maximum color depth	10 bits
Maximum vertical refresh rate	Up to 120 Hz NOTE: The refresh rate depends on the resolution.
External ports	DisplayPort over USB Type-C
Multiple display support	Up to 4 displays including laptop display or four external displays with the internal display off.

BIOS Setup

CAUTION: Unless you are an expert computer user, do not change the settings in the BIOS Setup. Certain changes can make your computer work incorrectly.

NOTE: Depending on the computer and its installed devices, the items that are listed in this section may or may not be displayed.

NOTE: Before you change the settings in BIOS Setup, it is recommended that you note down the original settings for future reference.

Use BIOS Setup for the following purposes:

- Get information about the hardware installed in your computer, such as the amount of RAM and the size of the storage device.
- Change the system configuration information.
- Set or change a user-selectable option, such as the user password, type of hard drive installed, and enabling or disabling base devices.

Entering BIOS Setup program

About this task

Turn on (or restart) your computer and press F2 immediately.

Navigation keys

NOTE: For most of the System Setup options, changes that you make are recorded but do not take effect until you restart the computer.

Table 28. Navigation keys

Keys	Navigation
Up arrow	Moves to the previous field.
Down arrow	Moves to the next field.
Enter	Selects a value in the selected field (if applicable) or follows the link in the field.
Spacebar	Expands or collapses a drop-down list, if applicable.
Tab	Moves to the next focus area. NOTE: For the standard graphical user interface only.
Esc	Moves to the previous page until you view the main screen. Pressing Esc in the main screen displays a message that prompts you to save any unsaved changes and restart the computer.

F12 One Time Boot menu

To enter the One Time Boot menu, turn on your computer, and then press F12 immediately.

 **NOTE:** It is recommended to shut down the computer, if it is on.

The F12 One Time Boot menu displays the devices that you can boot from including the diagnostic option. The boot menu options are:

- Removable Drive (if available)
- STXXXX Drive (if available)
 -  **NOTE:** XXX denotes the SATA drive number.
- Optical Drive (if available)
- SATA Hard Drive (if available)
- Diagnostics

The boot sequence screen also displays the option to access System Setup.

System setup options

 **NOTE:** Depending on your computer and its installed devices, the items that are listed in this section may or may not be displayed.

Table 29. System setup options—Overview menu

Overview	
XPS 13 9340	
BIOS Version	Displays the BIOS version number.
Service Tag	Displays the Service Tag of the computer.
Asset Tag	Displays the Asset Tag of the computer.
Manufacture Date	Displays the manufacture date of the computer.
Ownership Date	Displays the ownership date of the computer.
Express Service Code	Displays the Express Service Code of the computer.
Ownership Tag	Displays the Ownership Tag of the computer.
Signed Firmware Update	Displays whether the Signed Firmware Update is enabled on your computer. By default, the Signed Firmware Update option is enabled.
Battery Information	
Primary	Displays the primary battery of the computer.
Battery Level	Displays the battery level of the computer.
Battery State	Displays the battery state of the computer.
Health	Displays the battery health of the computer.
AC Adapter	Displays whether an AC adapter is connected. If connected, displays the type of AC adapter that is connected.
Battery Life Type	Displays the battery life type of the computer.
Processor Information	
Processor Type	Displays the processor type.
Maximum Clock Speed	Displays the maximum processor clock speed.
Minimum Clock Speed	Displays the minimum processor clock speed.
Current Clock Speed	Displays the current processor clock speed.
Core Count	Displays the number of cores on the processor.

Table 29. System setup options—Overview menu (continued)

Overview	
Processor ID	Displays the processor identification code.
Processor L2 Cache	Displays the processor L2 Cache size.
Processor L3 Cache	Displays the processor L3 Cache size.
Microcode Version	Displays the microcode version.
Intel Hyper-Threading Capable	Displays whether the processor is Hyper-Threading (HT) capable.
64-Bit Technology	Displays whether 64-bit technology is used.
Memory Information	
Memory Installed	Displays the total computer memory installed.
Memory Available	Displays the total computer memory available.
Memory Speed	Displays the memory speed.
Memory Channel Mode	Displays single or dual channel mode.
Memory Technology	Displays the technology that is used for the memory.
Devices Information	
Panel Type	Displays the panel type of the computer.
Panel Revision	Displays the panel revision of the computer.
Video Controller	Displays the video controller type of the computer.
Video Memory	Displays the video memory information of the computer.
Wi-Fi Device	Displays the wireless device information of the computer.
Native Resolution	Displays the native resolution of the computer.
Video BIOS Version	Displays the video BIOS version of the computer.
Audio Controller	Displays the audio controller information of the computer.
Bluetooth Device	Displays the Bluetooth device information of the computer.
LOM MAC Address	Displays the LOM MAC address of the computer.
Pass Through MAC Address	Displays the MAC address of the video pass-through.

Table 30. System setup options—Boot Configuration menu

Boot Configuration	
Boot Sequence	
Boot Mode: UEFI only	Displays the boot mode of the computer.
Boot Sequence	Displays the boot sequence.
Enable PXE Boot Priority	When enabled, the new PXE boot option is detected and added to the top of the boot sequence. By default, the PXE Boot priority option is disabled.
Secure Boot	
	Secure Boot is a method of guaranteeing the integrity of the boot path by performing additional validation of the operating system and PCI add-in cards. The computer stops booting to the operating system when a component is not authenticated during the boot process. Secure Boot can be enabled in BIOS setup or using management interfaces like Dell Command Configure, but can only be disabled from BIOS setup.
Enable Secure Boot	Enables the computer to boot using only validated boot software.

Table 30. System setup options—Boot Configuration menu (continued)

Boot Configuration	
	<p>By default, the Enable Secure Boot option is enabled.</p> <p>For additional security, Dell Technologies recommends keeping the Secure Boot option enabled to ensure that the UEFI firmware validates the operating system during the boot process.</p> <p>i NOTE: For Secure Boot to be enabled, the computer is required to be in UEFI boot mode and the Enable Legacy Option ROMs option is required to be turned off.</p>
Secure Boot Mode	<p>Enables or disables the Secure Boot operation mode.</p> <p>By default, the Deployed Mode is selected.</p> <p>i NOTE: Deployed Mode should be selected for normal operation of Secure Boot.</p>
Enable Microsoft UEFI CA	<p>When disabled, the UEFI CA is removed from the BIOS UEFI Secure Boot database.</p> <p>i NOTE: When disabled, the Microsoft UEFI CA could render your computer unable to boot, computer graphics may not function, some devices may not function properly, and the computer could become unrecoverable.</p> <p>By default, the Enable Microsoft UEFI CA option is enabled.</p> <p>For additional security, Dell Technologies recommends keeping the Microsoft UEFI CA option enabled to ensure the broadest compatibility with devices and operating systems.</p>
Expert Key Management	
Enable Custom Mode	<p>Enables or disables the keys in the PK, KEK, db, and dbx security key databases to be modified.</p> <p>By default, the Enable Custom Mode option is disabled.</p>
Custom Mode Key Management	<p>Selects the custom values for expert key management.</p> <p>By default, the PK option is selected.</p>

Table 31. System setup options—Integrated Devices menu

Integrated Devices	
Date/Time	
Date	Sets the computer date in MM/DD/YYYY format. Changes to the date format take effect immediately.
Time	Sets the computer time in HH/MM/SS 24-hour format. You can switch between a 12-hour and 24-hour clock. Changes to the time format take effect immediately.
Camera	
Enable Camera	<p>Enables the camera.</p> <p>By default, the Enable Camera option is enabled.</p> <p>i NOTE: Depending on the configuration ordered, the camera setup option may not be available.</p>
Audio	
Enable Audio	<p>Enables all integrated audio controller.</p> <p>By default, all the options are enabled.</p>
Enable Microphone	Enables the microphone.

Table 31. System setup options—Integrated Devices menu (continued)

Integrated Devices	
	By default, the Enable Microphone option is enabled.  NOTE: Depending on the configuration ordered, the microphone setup option may not be available.
Enable Internal Speaker	Enables the internal speaker. By default, the Enable Internal Speaker option is enabled.
USB/Thunderbolt Configuration	
Enable USB Boot Support	Enables booting from USB mass storage devices that are connected to external USB ports. By default, the Enable USB Boot Support option is enabled.
Enable External USB Ports	Enables the external USB ports. By default, the Enable External USB Ports option is enabled.
Enable Thunderbolt Technology Support	
Enable Thunderbolt Technology Support	Enables the associated ports and adapters for Thunderbolt Technology support. By default, the Enable Thunderbolt Technology Support option is enabled.
Enable Thunderbolt Boot Support	
Enable Thunderbolt Boot Support	Enables the Thunderbolt adapter-peripheral device and USB devices that are connected to the Thunderbolt adapter to be used during BIOS Preboot. By default, the Enable Thunderbolt Boot Support option is disabled.
Enable Thunderbolt (and PCIe behind TBT) pre-boot modules	Enables the PCIe devices that are connected through a Thunderbolt adapter to run the PCIe devices UEFI Option ROM (if present) during preboot. By default, the Enable Thunderbolt (and PCIe behind TBT) pre-boot modules option is disabled.
Disable USB4 PCIE Tunneling	Disables the USB4 PCIE Tunneling option. By default, the Disable USB4 PCIE Tunneling option is disabled.
Video/Power only on Type-C Ports	Enables or disables the Type-C port functionality to video or only power. By default, the Video/Power only on Type-C Ports option is disabled.
Type-C Dock	
Type-C Dock Override	Enables or disable to use connected Type-C Dell Dock to provide data stream with external USB ports disabled. When Type-C Dock override is enabled, the Video/Audio/LAN submenu is activated. By default, the Type-C Dock Override option is enabled.
Type-C Dock Audio	Enables or disables the usage of audio inputs and outputs from the connected Type-C Dell docking station. By default, the Type-C Dock Audio option is enabled.
Type-C Dock LAN	Enables or disables the usage of LAN on the external ports of the connected Type-C Dell docking station. By default, the Type-C Dock LAN option is enabled.
Miscellaneous Devices	
Enable Fingerprint Reader Device	Enables the Fingerprint Reader Device option. By default, the Enable Fingerprint Reader Device option is enabled.

Table 32. System setup options—Storage menu

Storage	
SATA/NVMe Operation	
SATA/NVMe Operation	Sets the operating mode of the integrated SATA hard drive controller. By default, the RAID ON option is selected. The storage device is configured to support RAID functions.
Storage Interface	
Port Enablement	Enables or disables the M.2 PCIe SSD option. By default, the M.2 PCIe SSD-0 option is enabled.
SMART Reporting	
Enable SMART Reporting	When enabled, the BIOS can receive analytical information from the integrated devices and send notifications during startup about possible future failure of the hard drive. By default, the SMART Reporting option is disabled.
Drive Information	
	Displays the information of onboard drives.

Table 33. System setup options—Display menu

Display	
Display Brightness	
Brightness on battery power	Enables to set the screen brightness when the computer is running on battery power. By default, the screen brightness is set to 50 when the computer is running on battery power.
Brightness on AC power	Enables to set the screen brightness when the computer is running on AC power. By default, the screen brightness is set to 100 when the computer is running on AC power.
Touchscreen	
	Enables or disables the touch screen option. By default, the Touchscreen option is enabled.
Full Screen Logo	
	Enables or disables the computer to display a full-screen logo, if the image matches screen resolution. By default, the Full Screen Logo option is disabled.

Table 34. System setup options—Connection menu

Connection	
Wireless Device Enable	
WLAN	Enables or disables the internal WLAN device. By default, the WLAN option enabled.
Bluetooth	Enables or disables the internal Bluetooth device. By default, the Bluetooth option enabled.
Enable UEFI Network Stack	
	Enables or disables the UEFI Network Stack and controls the onboard LAN Controller. By default, the Enable UEFI Network Stack option is enabled.
Wireless Radio Control	

Table 34. System setup options—Connection menu (continued)

Connection	
Control WLAN Radio	<p>Enables to sense the connection of the computer to a wired network and then disables the selected wireless radios (WLAN and/or WWAN). Upon disconnection from the wired network, the selected wireless radios are reenabled.</p> <p>By default, the Control WLAN Radio option is disabled.</p>
HTTP(s) Boot Feature	
HTTP(s) Boot	<p>Enables or disables the HTTP(s) boot feature.</p> <p>By default, the HTTP(s) Boot option is enabled.</p>
HTTP(s) Boot Modes	<p>Enables or disables the HTTP(s) boot modes.</p> <p>By default, the Auto Mode is enabled.</p>

Table 35. System setup options—Power menu

Power	
Battery Configuration	<p>Enables or disables the computer to run on battery during peak power usage hours. Use the table Custom Charge Start and Custom Charge Stop, to prevent AC power usage between certain times of each day.</p> <p>By default, the Adaptive option is selected. Battery settings are adaptively optimized based on your typical battery usage pattern.</p>
Advanced Configuration	
Enable Advanced Battery Charge Configuration	<p>Enables Advanced Battery Charge Configuration from the beginning of the day to a specified work period. When enabled, Advanced Battery Charged maximizes battery health while still supporting heavy use during the work day.</p> <p>By default, the Enable Advanced Battery Charge Configuration option is disabled.</p>
Peak Shift	
Enable Peak Shift	<p>Enables the computer to run on battery during peak power usage hours.</p> <p>By default, the Enable Peak Shift option is disabled.</p>
Thermal Management	<p>Enables or disables cooling of fan and manages processor heat to adjust the computer performance, noise, and temperature.</p> <p>By default, the Optimized option is selected. Standard settings for balanced performance, noise, and temperature.</p>
USB Wake Support	
Wake on Dell USB-C Dock	<p>When enabled, connecting a Dell USB-C Dock wakes the computer from Standby, Hibernate, and Power Off.</p> <p>By default, the Wake on Dell USB-C Dock option is enabled.</p>
Block Sleep	<p>Enables or disables the computer from entering Sleep (S3) mode in the operating system.</p> <p>By default, the Block Sleep option is disabled.</p> <p>i NOTE: When enabled, the computer does not go to Sleep, Intel Rapid Start is disabled automatically, and the operating system power option is blank if it was set to Sleep.</p>
Lid Switch	
Enable Lid Switch	<p>Enables or disables the Lid Switch.</p> <p>By default, the Enable Lid Switch option is enabled.</p>

Table 35. System setup options—Power menu (continued)

Power	
Power On Lid Open	<p>When enabled, it allows the computer to turn on from the off state whenever the lid is opened.</p> <p>By default, the Power On Lid Open option is enabled.</p>
Intel Speed Shift Technology	<p>Enables or disables the Intel Speed Shift Technology support. When enabled, the operating system selects the appropriate processor performance automatically.</p> <p>By default, the Intel Speed Shift Technology option is enabled.</p>

Table 36. System setup options—Security menu

Security	
TPM 2.0 Security	
TPM 2.0 Security On	<p>Allows you to enable or disable TPM.</p> <p>By default, the TPM 2.0 Security On option is enabled.</p> <p>For additional security, Dell Technologies recommends keeping TPM On enabled to allow these security technologies to fully function.</p>
Attestation Enable	<p>The Attestation Enable option controls the endorsement hierarchy of TPM. Disabling the Attestation Enable option prevents TPM from being used to digitally sign certificates.</p> <p>By default, the Attestation Enable option is enabled.</p> <p>For additional security, Dell Technologies recommends keeping the Attestation Enable option enabled.</p> <p>i NOTE: When disabled, this feature may cause compatibility issues or loss of functionality in some operating systems.</p>
Key Storage Enable	<p>The Key Storage Enable option controls the storage hierarchy of TPM, which is used to store digital keys. Disabling the Key Storage Enable option restricts the ability of TPM to store owner's data.</p> <p>By default, the Key Storage Enable option is enabled.</p> <p>For additional security, Dell Technologies recommends keeping the Key Storage Enable option enabled.</p> <p>i NOTE: When disabled, this feature may cause compatibility issues or loss of functionality in some operating systems.</p>
SHA-256	<p>Allows you to control the hashing algorithm that is used by the TPM. When enabled, the TPM uses the SHA-256 hashing algorithm. When disabled, the TPM uses the SHA-1 hash algorithm.</p> <p>By default, the SHA-256 option is enabled.</p> <p>For additional security, Dell Technologies recommends keeping the SHA-256 option enabled.</p>
Clear	<p>When enabled, the Clear option clears information that is stored in the TPM after exiting the computer's BIOS. This option returns to the disabled state when the computer restarts.</p> <p>By default, the Clear option is disabled.</p> <p>Dell Technologies recommends enabling the Clear option only when TPM data is required to be cleared.</p>
Physical Presence Interface (PPI) Bypass for Clear Commands	<p>By default, the PPI Bypass for Clear Commands option is disabled.</p> <p>For additional security, Dell Technologies recommends keeping the PPI Bypass for Clear Commands option disabled.</p>

Table 36. System setup options—Security menu (continued)

Security	
Chassis intrusion	
Chassis Intrusion Detection	<p>The chassis intrusion detection enables a physical switch that triggers an event when the computer cover is opened.</p> <p>When set to Enabled, a notification is displayed on the next boot and the event is logged in the BIOS Events log.</p> <p>When set to On-Silent, the event is logged in the BIOS Events log, but no notification is displayed.</p> <p>When set to Disabled, no notification is displayed and no event is logged in the BIOS Events log.</p> <p>By default, the Chassis Intrusion Detection option is enabled.</p> <p>For additional security, Dell Technologies recommends keeping the Chassis Intrusion Detection option enabled.</p>
TPM State	<p>Enables or disables the Trusted Platform Module (TPM). This is the normal operating state for the Trusted Platform Module (TPM) when you want to use its complete array of capabilities.</p> <p>By default, the TPM State option is enabled.</p>
Intel Platform Trust Technology (PTT)	<p>Intel PTT is a firmware-based Trusted Platform Module (fTPM) device that is part of Intel chipsets. It provides credential storage and key management that can replace the equivalent functionality of a discrete TPM chip.</p> <p>NOTE: The options that are listed apply to computers with a discrete Trusted Platform Module (TPM).</p>
PTT On	<p>Enables or disables the Intel PTT option.</p> <p>By default, the PTT On option is enabled.</p> <p>For additional security, Dell Technologies recommends keeping the PTT On option enabled.</p>
Physical Presence Interface (PPI) Bypass for Clear Commands	<p>The PPI Bypass for Clear Commands option allows the operating system to manage certain aspects of PTT. When enabled, you are not prompted to confirm changes to the PTT configuration.</p> <p>By default, the PPI Bypass for Clear Commands option is disabled.</p> <p>For additional security, Dell Technologies recommends keeping the PPI Bypass for Clear Commands option disabled.</p>
Clear	<p>When enabled, the Clear option clears the information that is stored in the PTT fTPM after exiting the computer's BIOS. This option returns to the disabled state when the computer restarts.</p> <p>By default, the Clear option is disabled.</p> <p>Dell Technologies recommends enabling the Clear option only when PTT fTPM data needs to be cleared.</p>
Block Boot Until Cleared	<p>Enables or disables the Block Boot Until Cleared option.</p> <p>By default, the Block Boot Until Cleared option is disabled.</p> <p>NOTE: When enabled, the computer does not boot until the chassis intrusion is cleared. If the administrator password is set, Setup has to be unlocked before the warning can be cleared.</p>
SMM Security Mitigation	<p>Enables or disables additional UEFI SMM Security Mitigation protections. This option uses the Windows SMM Security Mitigations Table (WSMT) to confirm to the operating system that security best practices have been implemented by the UEFI firmware.</p> <p>By default, the SMM Security Mitigation option is enabled.</p>

Table 36. System setup options—Security menu (continued)

Security	
	<p>For additional security, Dell Technologies recommends keeping the SMM Security Mitigation option enabled unless you have a specific application which is not compatible.</p> <p>i NOTE: This feature may cause compatibility issues or loss of functionality with some legacy tools and applications.</p>
Absolute	<p>Absolute Software provides various cyber security solutions, some requiring software preloaded on Dell computers and integrated into the BIOS. To use these features, you must enable the Absolute BIOS setting and contact Absolute for configuration and activation.</p> <p>By default, the Absolute option is enabled.</p> <p>For additional security, Dell Technologies recommends keeping the Absolute option enabled.</p> <p>i NOTE: When the Absolute features are activated, the Absolute integration cannot be disabled from the BIOS setup screen.</p>
UEFI Boot Path Security	
UEFI Boot Path Security	<p>Enables or disables the computer to prompt the user to enter the Administrator password (if set) when booting to a UEFI boot path device from the F12 boot menu.</p> <p>By default, the Always Except Internal HDD option is enabled.</p>
Firmware Device Tamper Detection	
Firmware Device Tamper Detection	<p>Allows you to control the firmware device tamper detection feature. This feature notifies the user when the firmware device is tampered. When enabled, a screen warning messages are displayed on the computer and a tamper detection event is logged in the BIOS Events log. The computer fails to reboot until the event is cleared.</p> <p>By default, the Firmware Device Tamper Detection option is enabled.</p> <p>For additional security, Dell Technologies recommends keeping the Firmware Device Tamper Detection option enabled.</p>
Clear Firmware Device Tamper Detection	<p>Clears the event and allows booting.</p> <p>By default, the option is disabled.</p>

Table 37. System setup options—Passwords menu

Passwords	
Administrator Password Hard Drive Password	<p>The Administrator Password prevents unauthorized access to the BIOS Setup options. Once the administrator password is set, the BIOS setup options can only be modified after providing the correct password.</p> <p>The following rules and dependencies apply to the Administrator Password -</p> <ul style="list-style-type: none"> • The administrator password cannot be set if computer and/or internal hard drive passwords are previously set. • The administrator password can be used in place of the computer and/or internal hard drive passwords. • When set, the administrator password must be provided during a firmware update. • Clearing the administrator password also clears the computer password (if set). <p>Dell Technologies recommends using an administrator password to prevent unauthorized changes to BIOS setup options.</p>

Table 37. System setup options—Passwords menu (continued)



Passwords	
System Password	<p>The System Password prevents the computer from booting to an operating system without entering the correct password.</p> <p>The following rules and dependencies apply when the System Password is used -</p> <ul style="list-style-type: none"> • The computer shuts down when idle for approximately 10 minutes at the computer password prompt. • The computer shuts down after three incorrect attempts to enter the computer password. • The computer shuts down when the Esc key is pressed at the System Password prompt. • The computer password is not prompted when the computer resumes from standby mode. <p>Dell Technologies recommends using the computer password in situations where it is likely that a computer may be lost or stolen.</p>
Password Configuration	<p>The Password configuration page includes several options for changing the requirements of BIOS passwords. You can modify the minimum and maximum length of the passwords and require passwords to contain certain character classes (upper case, lower case, digit, special character).</p> <p>Dell Technologies recommends setting the minimum password length to at least eight characters.</p>
Password Bypass	<p>The Password Bypass option allows the computer to reboot from the operating system without entering the computer or hard drive password. If the computer has already booted to the operating system, it is presumed that the user has already entered the correct computer or hard drive password.</p> <p> NOTE: This option does not remove the requirement to enter the password after shutting down.</p> <p>By default, the Password Bypass option is enabled.</p> <p>For additional security, Dell Technologies recommends keeping the Password Bypass option enabled.</p>
Password Changes	
Allow Non-Admin Password Changes	<p>The Allow Non-Admin Password Changes option in BIOS setup allows an end user to set or change the computer or hard drive passwords without entering the administrator password. This gives an administrator control over the BIOS settings but enables an end user to provide their own password.</p> <p>By default, the Allow Non-Admin Password Changes option is enabled.</p> <p>For additional security, Dell Technologies recommends keeping the Allow Non-Admin Password Changes option disabled.</p>
Admin Setup Lockout	<p>The Admin Setup Lockout option prevents an end user from even viewing the BIOS setup configuration without first entering the administrator password (if set).</p> <p>By default, the Admin Setup Lockout option is disabled.</p> <p>For additional security, Dell Technologies recommends keeping the Admin Setup Lockout option disabled.</p>
Master Password Lockout	
Enable Master Password Lockout	<p>The Master Password Lockout setting allows you to disable the Recovery Password feature. If the computer, administrator, or hard drive password is forgotten, the computer becomes unusable.</p> <p> NOTE: When the owner password is set, the Master Password Lockout option is not available.</p>

Table 37. System setup options—Passwords menu (continued)

Passwords	
	<p>i NOTE: When an internal hard drive password is set, it must first be cleared before Master Password Lockout can be changed.</p> <p>By default, the Enable Master Password Lockout option is disabled.</p> <p>Dell does not recommend enabling the Master Password Lockout unless you have implemented your own password recovery computer.</p>

Table 38. System setup options—Update, Recovery menu

Update, Recovery	
UEFI Capsule Firmware Updates	
Enable UEFI Capsule Firmware Updates	<p>Enables or disables BIOS updates through UEFI capsule update packages.</p> <p>i NOTE: Disabling this option blocks the BIOS updates from services such as Microsoft Windows Update and Linux Vendor Firmware Service (LVFS).</p> <p>By default, the Enable UEFI Capsule Firmware Updates option is enabled.</p>
BIOS Recovery from Hard Drive	<p>Enables or disables the user to recover from certain corrupted BIOS conditions from a recovery file on the user primary hard drive or an external USB key.</p> <p>By default, the BIOS Recovery from Hard Drive option is enabled.</p> <p>i NOTE: BIOS Recovery from Hard Drive is not available for self-encrypting drives (SED).</p> <p>i NOTE: BIOS recovery is designed to fix the main BIOS block and cannot work if the Boot Block is damaged. In addition, this feature cannot work in the event of EC corruption, ME corruption, or a hardware issue. The recovery image must exist on an unencrypted partition on the drive.</p>
BIOS Downgrade	
Allow BIOS Downgrade	<p>Controls flashing of the computer firmware to previous revisions.</p> <p>By default, the Allow BIOS Downgrade option is enabled.</p>
SupportAssist OS Recovery	<p>Enables or disables the boot flow for SupportAssist OS Recovery tool in the event of certain computer errors.</p> <p>By default, the SupportAssist OS Recovery option is enabled.</p>
BIOSConnect	<p>Enables or disables cloud Service operating system recovery if the main operating system fails to boot with the number of failures equal to or greater than the value specified by the Auto operating system Recovery Threshold setup option and the local Service operating system does not boot or is not installed.</p> <p>By default, the BIOSConnect option is enabled.</p>
Dell Auto OS Recovery Threshold	<p>Allows you to control the automatic boot flow for SupportAssist System Resolution Console and for Dell operating system Recovery Tool.</p> <p>By default, the Dell Auto OS Recovery Threshold value is set to 2.</p>

Table 39. System setup options—System Management menu

System Management	
Service Tag	Displays the Service Tag of the computer.
Asset Tag	<p>Creates a computer Asset Tag that can be used by an IT administrator to uniquely identify a particular computer.</p> <p>i NOTE: Once set in the BIOS, the Asset Tag cannot be changed.</p>
AC Behavior	

Table 39. System setup options—System Management menu (continued)

System Management	
Wake on AC	Enables or disables the computer to turn on and go to boot when AC power is supplied to the computer. By default, the Wake on AC option is disabled.
Wake on LAN	Enables or disables the computer to turn on by a special LAN signal. By default, the Wake on LAN option is disabled.
Auto On Time	Enable to set the computer to turn on automatically every day or on a preselected date and time. This option can be configured only if the Auto On Time is set to Everyday, Weekdays, or Selected Days. By default, the Auto On Time option is disabled.
Intel AMT Capability	Enable or disable the Intel AMT capability. By default, the Restrict Preboot Access option is enabled.
Diagnostics	
OS Agent Requests	Enable and disable the OS Agent Requests feature. By default, the OS Agent Requests option is enabled.
Power-on-self-Test Automation Recovery	Enable and disable the power-on-self-test automation recovery option. By default, the Power-on-self-Test Automation Recovery option is enabled.

Table 40. System setup options—Keyboard menu

Keyboard	
Fn Lock Options	Enables or disables the Fn Lock option. By default, the Fn Lock option is enabled.
Lock Mode	By default, the Lock Mode Secondary option is enabled. With this option, the F1-F12 keys scan the code for their secondary functions.
Keyboard Illumination	Configures the operating mode of the keyboard illumination feature. By default, the Auto option is selected. Enables the keyboard illumination feature at 100% brightness level.
Keyboard Backlight Timeout on AC	Sets the timeout value for the keyboard backlight when an AC adapter is connected to the computer. By default, the 10 seconds option is selected.
Keyboard Backlight Timeout on Battery	Sets the timeout value for the keyboard backlight when the computer is running only on the battery power. The keyboard backlight timeout value is only effective when the backlight is enabled. By default, the 10 seconds option is selected.
Device Configuration HotKey Access	Allows you to control whether you can access device configuration screens through hotkeys during computer startup. By default, the Device Configuration HotKey Access option is enabled. i NOTE: This setting controls only the Intel RAID (CTRL+I), MEBX (CTRL+P), and LSI RAID (CTRL+C) Option ROMs. Other preboot Option ROMs, which support entry using a key sequence, are not affected by this setting.

Table 41. System setup options—Preboot Behavior menu

Preboot Behavior	
Adapter Warnings	
Enable Adapter Warnings	Enables the warning messages during boot when the adapters with less power capacity are detected. By default, the Enable Adapter Warnings option is enabled.
Warnings and Errors	Enables or disables the action to be taken when a warning or error is encountered. By default, the Prompt on Warnings and Errors option is selected. Stop, prompt, and wait for user input when warnings or errors are detected.  NOTE: Errors deemed critical to the operation of the computer hardware stop the functioning of the computer.
USB-C Warnings	
Enable Dock Warning Messages	Enables the warning messages during boot when the USB-C adapters with less power capacity are detected. By default, the Enable Dock Warning Messages option is enabled.
Extend BIOS POST Time	Sets the BIOS POST (Power-On Self-Test) load time. By default, the 0 seconds option is selected.
MAC Address Pass-Through	Replaces the external NIC MAC address (in a supported dock or dongle) with the selected MAC address from the computer. By default, the System Unique MAC Address option is selected.
Sign of Life	
Early Logo Display	Display Logo Sign of Life. By default, the Early Logo Display option is enabled.
Early Keyboard Backlight	Keyboard Backlight Sign of Life. By default, the Early Keyboard Backlight option is enabled.

Table 42. System setup options—Virtualization menu

Virtualization Support	
Intel Virtualization Technology	
Enable Intel Virtualization Technology (VT)	When enabled, the computer can run a Virtual Machine Monitor (VMM). By default, the Enable Intel Virtualization Technology (VT) option is enabled.
VT for Direct I/O	
Enable Intel VT for Direct I/O	When enabled, the computer can perform Virtualization Technology for Direct I/O (VT-d). VT-d is an Intel method that provides virtualization for memory map I/O. By default, the Enable Intel VT for Direct I/O option is enabled.
Intel Trusted Execution Technology (TXT)	
Enable Intel Trusted Execution Technology (TXT)	Intel Trusted Execution Technology (TXT) is a set of hardware extensions to Intel processors and chipsets. It provides a hardware-based root of trust to ensure that a platform boots with a known good configuration of firmware, BIOS, virtual machine monitor, and operating system. The following must be enabled in order to enable Intel TXT - <ul style="list-style-type: none"> • Intel Virtualization Technology - X

Table 42. System setup options—Virtualization menu (continued)

Virtualization Support	
	<ul style="list-style-type: none"> • Intel Virtualization Technology - Direct <p>By default, the Enable Intel Trusted Execution Technology (TXT) option is disabled.</p> <p>For additional security, Dell Technologies recommends keeping the Intel Trusted Execution Technology (TXT) option enabled.</p>
DMA Protection	
Enable Pre-Boot DMA Support	<p>Allows you to control the Pre-Boot DMA protection for both internal and external ports. This option does not directly enable DMA protection in the operating system.</p> <p>NOTE: This option is not available when the virtualization setting for IOMMU is disabled (VT-d/AMD Vi).</p> <p>By default, the Enable Pre-Boot DMA Support option is enabled.</p> <p>For additional security, Dell Technologies recommends keeping the Enable Pre-Boot DMA Support option enabled.</p> <p>NOTE: This option is provided only for compatibility purposes, since some older hardware is not DMA capable.</p>
Enable OS Kernel DMA Support	<p>Allows you to control the Kernel DMA protection for both internal and external ports. This option does not directly enable DMA protection in the operating system. For operating systems that support DMA protection, this setting indicates to the operating system that the BIOS supports the feature.</p> <p>NOTE: This option is not available when the virtualization setting for IOMMU is disabled (VT-d/AMD Vi).</p> <p>By default, the Enable OS Kernel DMA Support option is enabled.</p> <p>NOTE: This option is provided only for compatibility purposes, since some older hardware is not DMA capable.</p>

Table 43. System setup options—Performance menu

Performance	
Multi-Core Support	
Active Multiple Performance Cores (P-Cores) Select	<p>Enables to change the number of CPU cores available for the operating system.</p> <p>By default, the All Active option is selected.</p>
Active Efficient Cores (E-Cores) Select	<p>Enables to change the number of CPU E-cores available for the operating system.</p> <p>By default, the All Active option is selected.</p>
Intel SpeedStep	
Enable Intel SpeedStep Technology	<p>Enables the computer to dynamically adjust processor voltage and core frequency, decreasing average power consumption and heat production.</p> <p>By default, the Enable Intel SpeedStep Technology option is enabled.</p>
C-State Control	
Enable C-State Control	<p>Enables or disables the ability of the CPU to enter and exit low-power state. When disabled, it disables all C-states. When enabled, it enables all C-states that the chipset or platform allows.</p> <p>By default, the Enable C-State Control option is enabled.</p>
Intel Turbo Boost Technology	
Enable Intel Turbo Boost Technology	<p>Enables the Intel TurboBoost mode of the processor. When enabled, the Intel TurboBoost driver increases the performance of the CPU or graphics processor.</p>

Table 43. System setup options—Performance menu (continued)

Performance	
	By default, the Enable Intel Turbo Boost Technology option is enabled.
Intel Hyper-Threading Technology	
Enable Intel Hyper-Threading Technology	Enables the Intel Hyper-Threading mode of the processor. When enabled, the Intel Hyper-Threading increases the efficiency of the processor resources when multiple threads run on each core. By default, the Intel Hyper-Threading Technology option is enabled.

Table 44. System setup options—System Logs menu

System Logs	
BIOS Event Log	
Clear BIOS Event Log	Allows you to select option to keep or clear BIOS events logs. By default, the Keep Log option is selected.
Thermal Event Log	
Clear Thermal Event Log	Allows you to select option to keep or clear Thermal events logs. By default, the Keep Log option is selected.
Power Event Log	
Clear Power Event Log	Allows you to select option to keep or clear Power events logs. By default, the Keep Log option is selected.

Updating the BIOS

Updating the BIOS in Windows

Steps

1. Go to [Dell Support Site](#).
2. Click **Product support**. In the **Search support** box, enter the Service Tag of your computer, and then click **Search**.
 **NOTE:** If you do not have the Service Tag, use the SupportAssist feature to automatically identify your computer. You can also use the product ID or manually browse for your computer model.
3. Click **Drivers & Downloads**. Expand **Find drivers**.
4. Select the operating system installed on your computer.
5. In the **Category** drop-down list, select **BIOS**.
6. Select the latest version of BIOS, and click **Download** to download the BIOS file for your computer.
7. After the download is complete, browse the folder where you saved the BIOS update file.
8. Double-click the BIOS update file icon and follow the on-screen instructions.
 For more information about how to update the system BIOS, search in the Knowledge Base Resource at [Dell Support Site](#).

Updating the BIOS using the USB drive in Windows

Steps

1. Follow the procedure from step 1 to step 6 in [Updating the BIOS in Windows](#) to download the latest BIOS Setup program file.

2. Create a bootable USB drive. For more information, search the Knowledge Base Resource at [Dell Support Site](#).
3. Copy the BIOS Setup program file to the bootable USB drive.
4. Connect the bootable USB drive to the computer that needs the BIOS update.
5. Restart the computer and press **F12**.
6. Select the USB drive from the **One Time Boot Menu**.
7. Type the BIOS Setup program filename and press **Enter**.
The **BIOS Update Utility** appears.
8. Follow the on-screen instructions to complete the BIOS update.

Updating the BIOS in Linux and Ubuntu

To update the system BIOS on a computer that is installed with Linux or Ubuntu, see the knowledge base article [000131486](#) at [Dell Support Site](#).

Updating the BIOS from the F12 One Time Boot menu

Update your computer BIOS using the BIOS update.exe file that is copied to a FAT32 USB drive and booting from the F12 **One Time Boot** menu.

About this task

BIOS Update

You can run the BIOS update file from Windows using a bootable USB drive or you can also update the BIOS from the F12 **One Time Boot** menu on the computer.

Most of the Dell computers built after 2012 have this capability, and you can confirm by booting your computer to the F12 **One Time Boot** Menu to see if BIOS FLASH UPDATE is listed as a boot option for your computer. If the option is listed, then the BIOS supports this BIOS update option.

 **NOTE:** Only computers with the BIOS Flash Update option in the F12 **One Time Boot** menu can use this function.

Updating from the One Time Boot menu

To update your BIOS from the F12 **One Time Boot** menu, you need the following:

- USB drive formatted to the FAT32 file system (key does not have to be bootable)
- BIOS executable file that you downloaded from the Dell Support website and copied to the root of the USB drive
- AC power adapter that is connected to the computer
- Functional computer battery to flash the BIOS

Perform the following steps to perform the BIOS update flash process from the F12 menu:

 **CAUTION:** Do not turn off the computer during the BIOS update process. The computer may not boot if you turn off your computer.

Steps

1. From a turn off state, insert the USB drive where you copied the flash into a USB port of the computer.
2. Turn on the computer and press F12 to access the **One Time Boot** Menu, select BIOS Update using the mouse or arrow keys then press Enter.
The flash BIOS menu is displayed.
3. Click **Flash from file**.
4. Select an external USB device.
5. Select the file and double-click the flash target file, and then click **Submit**.
6. Click **Update BIOS**. The computer restarts to flash the BIOS.
7. The computer will restart after the BIOS update is completed.

System and setup password

Table 45. System and setup password

Password type	Description
System password	Password that you must enter to log in to your system.
Setup password	Password that you must enter to access and make changes to the BIOS settings of your computer.

You can create a system password and a setup password to secure your computer.

 **CAUTION:** The password features provide a basic level of security for the data on your computer.

 **CAUTION:** Anyone can access the data that is stored on your computer, when not locked and left unattended.

 **NOTE:** System and setup password feature is disabled.

Assigning a System Setup password

Prerequisites

You can assign a new System or Admin Password only when the status is in **Not Set**.

About this task

To enter BIOS System Setup, press F2 immediately after a power-on or reboot.

Steps

1. In the **System BIOS** or **System Setup** screen, select **Security** and press Enter.
The **Security** screen is visible.
2. Select **System/Admin Password** and create a password in the **Enter the new password** field.
Use the following guidelines to assign the system password:
 - A password can have up to 32 characters.
 - At least one special character: "(! " # \$ % & ' * + , - . / : ; < = > ? @ [\] ^ _ ` { | })"
 - Numbers 0 to 9.
 - Upper case letters from A to Z.
 - Lower case letters from a to z.
3. Type the system password that you entered earlier in the **Confirm new password** field and click **OK**.
4. Press Esc and save the changes as prompted by the message.
5. Press Y to save the changes.
The computer restarts.

Deleting or changing an existing system setup password

Prerequisites

Ensure that the **Password Status** is Unlocked (in the System Setup) before attempting to delete or change the existing System and/or Setup password. You cannot delete or change an existing System or Setup password, if the **Password Status** is Locked.

About this task

To enter the System Setup, press F2 immediately after a power-on or reboot.

Steps

1. In the **System BIOS** or **System Setup** screen, select **System Security** and press Enter.
The **System Security** screen is displayed.
2. In the **System Security** screen, verify that the Password Status is **Unlocked**.
3. Select **System Password**, update, or delete the existing system password, and press Enter or Tab.
4. Select **Setup Password**, update, or delete the existing setup password, and press Enter or Tab.
 **NOTE:** If you change the System and/or Setup password, reenter the new password when prompted. If you delete the System and/or Setup password, confirm the deletion when prompted.
5. Press Esc. A message prompts you to save the changes.
6. Press Y to save the changes and exit from System Setup.
The computer restarts.

Clearing BIOS (System Setup) and System passwords

About this task

To clear the computer or BIOS passwords, contact Dell technical support as described at [Contact Support](#). For more information, go to [Dell Support Site](#).

-  **NOTE:** For information about how to reset Windows or application passwords, see the documentation accompanying Windows or your application.

Troubleshooting

Handling swollen rechargeable Li-ion batteries

Like most laptops, Dell laptops use Lithium-ion batteries. One type of Lithium-ion battery is the rechargeable Li-ion battery. Rechargeable Li-ion batteries have increased in popularity in recent years and have become standard in the electronics industry due to customer preferences for a slim form factor (especially with newer ultra-thin laptops) and long battery life. Inherent to rechargeable Li-ion battery technology is the potential for swelling of the battery cells.

A swollen battery may impact the performance of the laptop. To prevent possible further damage to the device enclosure or internal components leading to malfunction, discontinue the use of the laptop and discharge it by disconnecting the AC adapter and letting the battery drain.

Swollen batteries should not be used and should be replaced and disposed of properly. We recommend contacting Dell product support for options to replace a swollen battery under the terms of the applicable warranty or service contract, including options for replacement by a Dell authorized service technician.

The guidelines for handling and replacing rechargeable Li-ion batteries are as follows:

- Exercise caution when handling rechargeable Li-ion batteries.
- Discharge the battery before removing it from the system. To discharge the battery, unplug the AC adapter from the system and operate the system only on battery power. When the system will no longer turn on when the power button is pressed, the battery is fully discharged.
- Do not crush, drop, mutilate, or penetrate the battery with foreign objects.
- Do not expose the battery to high temperatures, or disassemble battery packs and cells.
- Do not apply pressure to the surface of the battery.
- Do not bend the battery.
- Do not use tools of any type to pry on or against the battery.
- If a battery gets stuck in a device as a result of swelling, do not try to free it as puncturing, bending, or crushing a battery can be dangerous.
- Do not attempt to reassemble a damaged or swollen battery into a laptop.
- Swollen batteries that are covered under warranty should be returned to Dell in an approved shipping container (provided by Dell)—this is to comply with transportation regulations. Swollen batteries that are not covered under warranty should be disposed of at an approved recycling center. Contact Dell product support at [Dell Support Site](#) for assistance and further instructions.
- Using a non-Dell or incompatible battery may increase the risk of fire or explosion. Replace the battery only with a compatible battery purchased from Dell that is designed to work with your Dell computer. Do not use a battery from other computers with your computer. Always purchase genuine batteries from [Dell Site](#) or otherwise directly from Dell.

Rechargeable Li-ion batteries can swell for various reasons such as age, number of charge cycles, or exposure to high heat. For more information about how to improve the performance and lifespan of the laptop battery and to minimize the possibility of occurrence of the issue, search Dell Laptop Battery in the Knowledge Base Resource at [Dell Support Site](#).

Locate the Service Tag or Express Service Code of your Dell computer

Your Dell computer is uniquely identified with a Service Tag or Express Service Code. To view relevant support resources for your Dell computer, we recommend entering the Service Tag or Express Service Code at [Dell Support Site](#).

For more information about how to find the Service Tag for your computer, see [Instructions on how to find your Service Tag or Serial Number](#).

Dell SupportAssist Pre-boot System Performance Check diagnostics

About this task

SupportAssist diagnostics (also known as system diagnostics) performs a complete check of your hardware. The Dell SupportAssist Pre-boot System Performance Check diagnostics is embedded with the BIOS and launched by the BIOS internally. The embedded system diagnostics provides options for particular devices or device groups allowing you to:

- Run tests automatically or in an interactive mode.
- Repeat the tests.
- Display or save test results.
- Run thorough tests to introduce additional test options to provide extra information about one or more failed devices.
- View status messages that inform you the tests are completed successfully.
- View error messages that inform you of problems encountered during testing.

 **NOTE:** Some tests for specific devices require user interaction. Always ensure that you are present at the computer terminal when the diagnostic tests are performed.

For more information, see the knowledge base article [000180971](#).

Running the SupportAssist Pre-Boot System Performance Check

Steps

1. Turn on your computer.
2. As the computer boots, press the F12 key as the Dell logo appears.
3. On the boot menu screen, select the **Diagnostics** option.
4. Click the arrow at the bottom left corner.
Diagnostics front page is displayed.
5. Click the arrow in the lower-right corner to go to the page listing.
The items that are detected are listed.
6. To run a diagnostic test on a specific device, press Esc and click **Yes** to stop the diagnostic test.
7. Select the device from the left pane and click **Run Tests**.
8. If there are any issues, error codes are displayed.
Note the error code and validation number and contact Dell.

Built-in self-test (BIST)

M-BIST

M-BIST (Built In Self-Test) is the system board built-in self-test diagnostics tool that improves the diagnostics accuracy of system board Embedded Controller (EC) failures.

 **NOTE:** M-BIST can be manually initiated before Power On Self-Test (POST).

How to run M-BIST

 **NOTE:** M-BIST must be initiated on the computer from a power-off state that is either connected to AC power or with a battery only.

1. Press and hold both the **M** key on the keyboard and the **power button** to initiate M-BIST.
2. The battery indicator LED may exhibit two states:
 - a. OFF: No fault was detected with the system board.
 - b. AMBER: Amber indicates a problem with the system board.

- If there is a failure with the system board, the battery status LED flashes one of the following error codes for 30 seconds:

Table 46. LED error codes

Blinking Pattern		Possible Problem
Amber	White	
2	1	CPU Failure
2	8	LCD Power Rail Failure
1	1	TPM Detection Failure
2	4	Memory/RAM failure

- If there is no failure with the system board, the LCD cycles through the solid color screens that are described in the LCD-BIST section for 30 seconds and then turn off.

LCD Power rail test (L-BIST)

L-BIST is an enhancement to the single LED error code diagnostics and is automatically initiated during POST. L-BIST will check the LCD power rail. If there is no power being supplied to the LCD (that is if the L-BIST circuit fails), the battery status LED flashes either an error code [2,8] or an error code [2,7].

NOTE: If L-BIST fails, LCD-BIST cannot function as no power will be supplied to the LCD.

How to invoke the L-BIST Test

- Press the power button to start the computer.
- If the computer does not start up normally, look at the battery status LED:
 - If the battery status LED flashes an error code [2,7], the display cable may not be connected properly.
 - If the battery status LED flashes an error code [2,8], there is a failure on the LCD power rail of the system board, hence there is no power that is supplied to the LCD.
- For cases, when a [2,7] error code is shown, check to see if the display cable is properly connected.
- For cases when a [2,8] error code is shown, replace the system board.

LCD Built-in Self-Test (BIST)

Dell laptops have a built-in diagnostic tool that helps you determine if the screen abnormality you are experiencing is an inherent problem with the LCD (screen) of the Dell laptop or with the video card (GPU) and computer settings.

When you notice screen abnormalities like flickering, distortion, clarity issues, fuzzy or blurry image, horizontal or vertical lines, color fade and so on, it is always a good practice to isolate the LCD (screen) by running the Built-In Self-Test (BIST).

How to invoke the LCD BIST Test

- Power off the Dell laptop.
- Disconnect any peripherals that are connected to the laptop. Connect only the AC adapter (charger) to the laptop.
- Ensure that the LCD (screen) is clean (no dust particles on the surface of the screen).
- Press and hold the **D** key and **Power on** the laptop to enter LCD built-in self-test (BIST) mode. Continue to hold the D key until the computer boots up.
- The screen displays solid colors and change colors on the entire screen to white, black, red, green, and blue twice.
- Then it displays the colors white, black, and red.
- Carefully inspect the screen for abnormalities (any lines, fuzzy color, or distortion on the screen).
- At the end of the last solid color (red), the computer shuts down.

NOTE: Dell SupportAssist Preboot diagnostics upon launch initiates an LCD BIST first, expecting a user intervention to confirm functionality of the LCD.

Diagnostic error codes

The Service LED is used for system diagnostics, and it emits amber or white light. A Dell service representative uses the LED light patterns to troubleshoot your device.

The following table shows different Service LED light patterns and associated problems.

Table 47. Diagnostic error codes

Diagnostic light codes	Problem description
2,1	Processor failure
2,2	System board: BIOS or ROM (Read-Only Memory) failure
2,3	No memory or RAM (Random-Access Memory) detected
2,4	Memory or RAM (Random-Access Memory) failure
2,5	Invalid memory installed
2,6	System-board or chipset error
2,7	Display failure
2,8	Display power failure - EC detection of power-rail failure
3,2	PCI, video card or chip failure
3,3	Recovery image not found
3,4	Recovery image found but invalid
3,5	EC power-rail error
3,6	System BIOS Flash incomplete
3,7	Management Engine (ME) error

 **NOTE:** An error code of **35** indicates an EC power-rail error. This may occur during POST (Power-On Self-Test). Contact [Dell Support](#) for assistance.

Recovering the operating system

When your computer is unable to boot to the operating system even after repeated attempts, it automatically starts Dell SupportAssist OS Recovery.

Dell SupportAssist OS Recovery is a stand-alone tool that is preinstalled in all Dell computers that are installed with the Windows operating system. It consists of tools to diagnose and troubleshoot issues that may occur before your computer boots to the operating system. It enables you to diagnose hardware issues, repair your computer, back up your files, or restore your computer to its factory state.

You can also download it from the Dell Support website to troubleshoot and fix your computer when it fails to boot into their primary operating system due to software or hardware failures.

For more information about the Dell SupportAssist OS Recovery, see *Dell SupportAssist OS Recovery User's Guide* at [Serviceability Tools at the Dell Support Site](#). Click **SupportAssist** and then, click **SupportAssist OS Recovery**.

Real Time Clock—RTC reset

The Real Time Clock (RTC) reset function allows you or the service technician to recover the recently launched model Dell XPS systems from **No POST/No Boot/No Power** situations. You can initiate the RTC reset on the system from a power-off state only if it is connected to AC power. Press and hold the power button for 25 seconds. The system RTC reset occurs after you release the power button.

 **NOTE:** If AC power is disconnected from the system during the process or the power button is held longer than 40 seconds, the RTC reset process gets aborted.

The RTC reset will reset the BIOS to Defaults, un-provision Intel vPro and reset the system date and time. The following items are unaffected by the RTC reset:

- Service Tag
- Asset Tag
- Ownership Tag
- Admin Password
- System Password
- HDD Password
- Key Databases
- System Logs

 **NOTE:** The IT administrator's vPro account and password on the system will be un-provisioned. The system needs to go through the setup and configuration process again to reconnect it to the vPro server.

The below items may or may not reset based on your custom BIOS setting selections:

- Boot List
- Enable Legacy Option ROMs
- Secure Boot Enable
- Allow BIOS Downgrade

Backup media and recovery options

It is recommended to create a recovery drive to troubleshoot and fix problems that may occur with Windows. Dell proposes multiple options for recovering the Windows operating system on your Dell computer. For more information, see [Dell Windows Backup Media and Recovery Options](#).

Wi-Fi power cycle

About this task

If your computer is unable to access the Internet due to Wi-Fi connectivity issues a Wi-Fi power cycle procedure may be performed. The following procedure provides the instructions on how to conduct a Wi-Fi power cycle:

 **NOTE:** Some Internet Service Providers (ISPs) provide a modem or router combo device.

Steps

1. Turn off your computer.
2. Turn off the modem.
3. Turn off the wireless router.
4. Wait for 30 seconds.
5. Turn on the wireless router.
6. Turn on the modem.
7. Turn on your computer.

Drain residual flea power (perform hard reset)

About this task

Flea power is the residual static electricity that remains in the computer even after it has been powered off and the battery is removed.

For your safety, and to protect the sensitive electronic components in your computer, you are requested to drain residual flea power before removing or replacing any components in your computer.

Draining residual flea power, also known as a performing a "hard reset," is also a common troubleshooting step if your computer does not turn on or boot into the operating system.

Perform the following steps to drain the residual flea power:

Steps

1. Turn off your computer.
2. Disconnect the power adapter from your computer.
3. Remove the base cover.
4. Remove the battery.



CAUTION: The battery is a Field Replaceable Unit (FRU) and the removal/installation is intended for authorized service technicians only.

5. Press and hold the power button for 20 seconds to drain the flea power.
6. Install the battery.
7. Install the base cover.
8. Connect the power adapter to your computer.
9. Turn on your computer.





NOTE: For more information about performing a hard reset, search in the Knowledge Base Resource at [Dell Support Site](#).

Getting help and contacting Dell

Self-help resources

You can get information and help on Dell products and services using these self-help resources:

Table 48. Self-help resources

Self-help resources	Resource location
Information about Dell products and services	Dell Site
My Dell app	
Tips	
Contact Support	In Windows search, type <code>Contact Support</code> , and press Enter.
Online help for operating system	Windows Support Site Linux Support Site
Access top solutions, diagnostics, drivers and downloads, and learn more about your computer through videos, manuals, and documents.	Your Dell computer is uniquely identified using a Service Tag or Express Service Code. To view relevant support resources for your Dell computer, enter the Service Tag or Express Service Code at Dell Support Site . For more information about how to find the Service Tag for your computer, see Locate the Service Tag on your computer .
Dell knowledge base articles	<ol style="list-style-type: none"> 1. Go to Dell Support Site. 2. On the menu bar at the top of the Support page, select Support > Support Library. 3. In the Search field on the Support Library page, type the keyword, topic, or model number, and then click or tap the search icon to view the related articles.

Contacting Dell

To contact Dell for sales, technical support, or customer service issues, see [Contact Support at Dell Support Site](#).

 **NOTE:** Availability of the services may vary depending on the country or region, and product.

 **NOTE:** If you do not have an active Internet connection, you can find contact information about your purchase invoice, packing slip, bill, or Dell product catalog.