

SAMSUNG

User Manual

SBB-CX4B
SBB-CV4B
SBB-CS4B

The colour and the appearance may differ depending on the product, and the content in the manual is subject to change without prior notice to improve the performance.

Table of contents

Before Using the Product

Safety Precautions	4
Safety symbols	4
Electricity and Safety	5
Installation	6
Operation	6
Cleaning	8

Preparations

Checking the Components	9
SBB-CX4B	9
SBB-CV4B / SBB-CS4B	10

Parts	11
Front Side	11
Reverse Side	12
Interface Gender Card (I/G Card)	15

Prior to Installation	16
Precautions for installation	16

Installing S-Box on Rack Case	16
-------------------------------	----

Remote Control	17
----------------	----

Connecting and using devices

Before Connecting	19
Pre-connection Checkpoints	19

Connecting to a PC	19
Connection Using an HDMI Cable	19
Connection Using an HDMI-DVI Cable	20
Connection Using an DP Cable	20

Connecting to a Video Device	21
Connection Using an HDMI-DVI Cable	21
Connection Using an HDMI Cable	21
Connection Using an DP Cable	22
Connection Using a Coaxial Cable	22
Connection Using an Aux Cable	23

Connecting the LAN Cable	24
--------------------------	----

Connecting a Optical Cable	24
----------------------------	----

Connecting to the One Connect	24
-------------------------------	----

Changing the Input source	25
Source	25
SMARTVIEW+	25
Web Browser	26

Multiple Display Control

Cable Connection	28
LAN Cable	28
Control Codes	29

Using LED Signage Manager	33
Installing / Uninstalling the software	33

Player feature

Player	34
Viewing content	34
When content is running	35
Available menu	35
File Formats Compatible with Player	36

Schedule	40
----------	----

Clone Product	41
---------------	----

ID Settings	42
Device ID	42
PC Connection Cable	42

Table of contents

Video Wall	43
Video Wall	43
Network Status	44
Picture Mode	45
On/Off Timer	46
On Timer	46
Off Timer	47
Holiday Management	47
Ticker	48

Menu

Picture	49
OnScreen Display	56
Network	57
Network Settings (Wired)	58
System	61
Support	71

Troubleshooting Guide

Requirements Before Contacting Samsung Customer Service Centre	72
Testing the Product	72
Checking the Resolution and Frequency	72
Check the followings.	73

Specifications

General	77
Preset Timing Modes	78

Appendix

Responsibility for the Pay Service (Cost to Customers)	81
Not a product defect	81
A Product damage caused by customer's fault	81
Others	81
Licence	82





Chapter 01

Before Using the Product

Safety Precautions

The following safety instructions are to ensure your personal safety and prevent property damage. Please read the following to ensure the proper use of the product.







Safety symbols

Symbol	Name	Meaning
	Warning	A serious or fatal injury may result if instructions are not followed.
	Caution	Personal injury or damage to properties may result if instructions are not followed.
	Prohibition	Do NOT attempt.
	Instruction	Follow directions.

CAUTION

RISK OF ELECTRIC SHOCK. DO NOT OPEN.

CAUTION: TO REDUCE THE RISK OF ELECTRIC SHOCK, DO NOT REMOVE COVER (OR BACK). THERE ARE NO USER SERVICEABLE PARTS INSIDE. REFER ALL SERVICING TO QUALIFIED PERSONNEL.

	This symbol indicates that high voltage is present inside. It is dangerous to make any kind of contact with any internal part of this product.		AC voltage: Rated voltage marked with this symbol is AC voltage.
	This symbol indicates that this product has included important literature concerning operation and maintenance.		DC voltage: Rated voltage marked with this symbol is DC voltage.
	Class II product: This symbol indicates that a safety connection to electrical earth (ground) is not required. If this symbol is not present on a product with a mains lead, the product MUST have a reliable connection to protective earth (ground).		Caution. Consult instructions for use: This symbol instructs the user to consult the user manual for further safety related information.

Electricity and Safety

 The following images are for reference only. Real-life situations may differ from what is shown in the images.

Warning





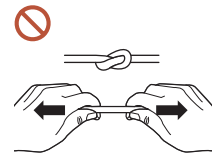

Do not touch the power plug with wet hands. Otherwise, an electric shock may result.

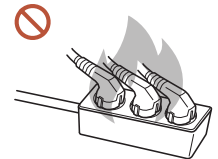

Do not bend or pull the power cable with force. Be careful not to leave the power cable under a heavy object. Product failure, an electric shock or fire may result from a damaged cable.



Do not connect multiple products to a single power socket. Overheated power sockets may cause a fire.

-  Insert the power plug all the way in so it is not loose. An unsecure connection may cause a fire.
-  Clean any dust around the pins of the power plug or the power socket with a dry cloth. A fire may result.
-  Connect the power plug to a grounded power socket. (Except for devices that do not provide grounding) An electric shock or injury may result.
-  Do not use a damaged power plug or a loose power socket. An electric shock or fire may result.

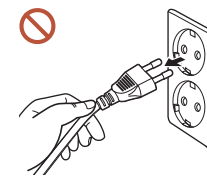

Caution

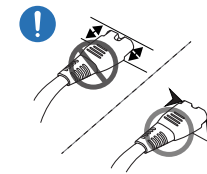

Hold the plug when disconnecting the power cable from the power socket. An electric shock or fire may result.









When connecting the power plug to the port, be sure to connect it completely. If the power plug is not completely connected to the port, the plug may be unexpectedly disconnected, or there is a risk of overheating due to overcurrent, leading to safety accidents.

-  Only use the power cable provided with your product by Samsung. Do not use the power cable with other products. An electric shock or fire may result.
-  Keep the power socket where the power cord is connected unobstructed. When a problem occurs with the product, the power cord must be unplugged to completely cut off power to the product. The power is not completely cut off by using only the Power button on the body of the product.
-  Do not disconnect the power cable while the product is being used. The product may become damaged by an electric shock.









Installation



Warning

-  Before moving the product, turn off the power switch and disconnect the power cable and all other connected cables.
Damage to the cable may cause a fire or electric shock.
-  When installing the product, keep it at a distance from the wall so that it is well ventilated.
An increased internal temperature may cause a fire.
-  If the product is installed in an unusual location, the surrounding environment may cause a serious quality problem. Therefore, be sure to contact Samsung Customer Service Centre before installation.
(Places where many fine dusts are generated, places where chemicals are used, places with too high or low temperatures, places with a lot of moisture or water, transportation equipment such as vehicles, airports and stations used continuously for a long time, and more)
-  Do not install the product in a poorly ventilated space such as bookcase or closet.
An increased internal temperature may cause a fire.
-  Keep the plastic packaging out of the reach of children.
Children's misuse of the plastic packaging may cause suffocation.
-  Do not install the power cable (DC power supply) and the product near heat sources.
(Candles, mosquito repellents, cigarettes, sprays, heating devices, places exposed to direct sunlight, and more)



Operation

Warning

-  If the product generates a strange noise, a burning smell, or smoke, unplug the power plug immediately and contact your Samsung Customer Service Centre.
An electric shock or fire may result.
-  If a gas leakage is found, do not touch the product or the power plug, and ventilate the room immediately.
Sparks can cause an explosion or fire.
-  Keep the remote control batteries and the small accessories out of the reach of children. Ensure children do not swallow any of them.
If children have had the battery in their mouths, consult your doctor immediately.
-  If the product is dropped or its appearance is damaged, turn off the power switch and disconnect the power cord. Then contact Samsung Customer Service Centre.
Continued use can result in an electric shock or a fire.
-  Do not move the product by pulling the power cord or any cable.
Product failure, an electric shock or fire may result from a damaged cable.
-  Ensure the vents are not blocked by tablecloths or curtains.
An increased internal temperature may cause a fire.
-  Do not apply an impact to the product.
 - The screen display may be damaged.
 - An electric shock or fire may result.
-  Do not insert metallic objects (chopsticks, coins, hairpins, etc) or objects that burn easily (paper, matches, etc) into the product (via the vent or input/output ports, etc).
 - If foreign substances enter the product, be sure to power off the product and disconnect the power cord. Then contact Samsung Customer Service Centre.
 - Product failure, an electric shock or fire may result.

-
-  Do not place objects containing liquid (vases, pots, bottles, etc) or metallic objects on top of the product.
 - If foreign substances such as water enter the product, be sure to disconnect the power cord. Then contact Samsung Customer Service Centre.
 - Product failure, an electric shock or fire may result.
 -  During a lightning or thunderstorm, power off the product and disconnect the power cord.

An electric shock or fire may result.
 -  While the power plug is plugged into a power socket, do not insert a chopstick or other conductor into a remaining power socket. Also, after disconnecting the power plug from the power socket, do not touch the pins of the plug immediately.

Otherwise, an electric shock may result.
 -  There is a high voltage inside the product. Never disassemble, repair or modify the product yourself.
 - Contact Samsung Customer Service Centre for repairs.
 - An electric shock or fire may result.
 -  Do not use humidifiers or stoves around the product.

An electric shock or fire may result.





Caution

-  Insert each battery so that its polarity (+, -) is correct.

If the polarity is not correct, the battery may rupture or the internal fluid may leak, causing contamination and damage to the surroundings, fire, or personal injury.
-  When you do not use the product for a long time due to vacation or other reason, disconnect the power cord from the power socket.

Dust accumulation combined with heat can cause a fire, electric shock or electric leakage.
-  The batteries (and rechargeable batteries) are not ordinary refuse and must be returned for recycling purposes. The customer is responsible for returning the used or rechargeable batteries for recycling.

The customer can return used or rechargeable batteries to a nearby public recycling centre or to a store selling the same type of the battery or rechargeable battery.
-  Do not use or keep combustible spray or an inflammable substance near the product.

An explosion or fire may result.
-  Do not place heavy objects on the product.

Product failure or personal injury may result.
-  Use only the specified standardised batteries, and do not use a new battery and a used battery at the same time.

Otherwise, the batteries may be damaged or cause fire, personal injury or damage due to a leakage of the internal liquid.
-  Do not lift or move the product when it is in operation.

Cleaning

Warning

-  Do not spray water or cleaner directly on the product.
 - The product's surface may be damaged, or the markings may be erased.
 - An electric shock or fire may result.

Caution

-  When cleaning, be sure to disconnect the power plug and wipe gently with a soft and dry cloth such as superfine fibers or cotton flannels to prevent scratches.

The product's surface may be damaged, or the markings may be erased.
-  Only use a soft cloth (e.g. microfiber, flannel) on the surface of the product to avoid scratches.

The product's surface or the screen display can be easily scratched with foreign substances.
-  Do not apply chemicals containing alcohol, solvent, or surfactant such as wax, benzene, thinner, pesticide, air freshener, lubricant, or cleaner to the product.

The product's exterior may be discoloured or cracked, the surface of the panel may be peeled off, or the markings may be erased.

Chapter 02

Preparations

Checking the Components

- Contact the vendor where you purchased the product if any components are missing.
- The appearance of the components may differ from the images shown.
- The RS232C adapter can be used to connect using the D-SUB(9-pin) to Stereo type RS232C cable.

SBB-CX4B



Simple User Guide



Warranty card
(Not available in some locations)



Regulatory guide



Power cord

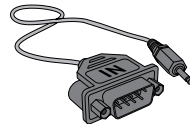

RS232C adapter



AC/DC adapter

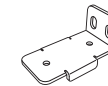

Rack case mounting bracket x 2



Screw (M4 x L8) x 4



Screw (M5 x L12) x 4

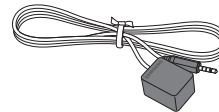

External IR cable

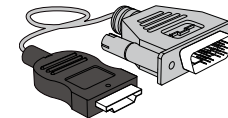

HDMI-DVI cable

- Contact the vendor where you purchased the product if any components are missing.
- The appearance of the components may differ from the images shown.
- The RS232C adapter can be used to connect using the D-SUB(9-pin) to Stereo type RS232C cable.
- Use either the back-side magnet or the double-sided tape depending on where you want to attach the external ambient light sensor. The warranty for adhesiveness of the double-sided tape applies to first-time-use only.
- The external ambient light sensor is marked with the label on the sensor cable.

SBB-CV4B / SBB-CS4B



Simple User Guide



Warranty card
(Not available in some locations)



Regulatory guide



Power cord

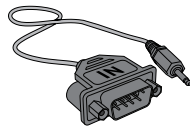

RS232C adapter



AC/DC adapter

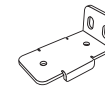

Rack case mounting bracket x 2



Screw (M4 x L8) x 4



Screw (M5 x L12) x 4

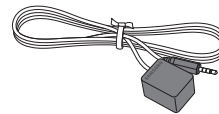

External IR cable

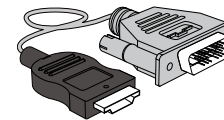

HDMI-DVI cable

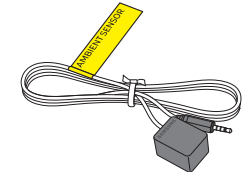

External ambient light sensor
(Supported model: SBB-CS4B)

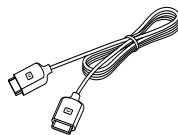

OCM cable x 4

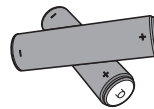

Batteries (AAA x 2)
(Not available in some locations)







Remote Control

Parts

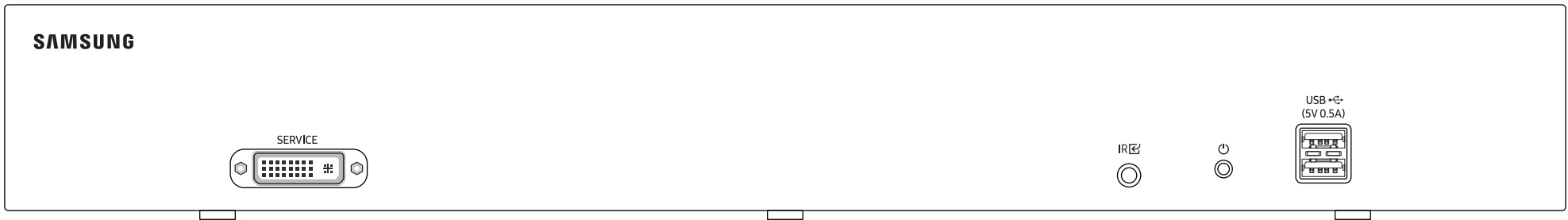
Front Side

 The colour and shape of parts may differ from what is shown. Specifications are subject to change without notice to improve quality.



Parts	Description
SERVICE	Dedicated to service technicians.  This port is for servicing only and has no user function. Do not connect a cable to this port.
	Turn the product on or off.
USB (5V 0.5A)	Connect to a USB memory device.
IR 	Connect to the external IR cable.

Reverse Side

SBB-CX4B

 The colour and shape of parts may differ from what is shown. Specifications are subject to change without notice to improve quality.

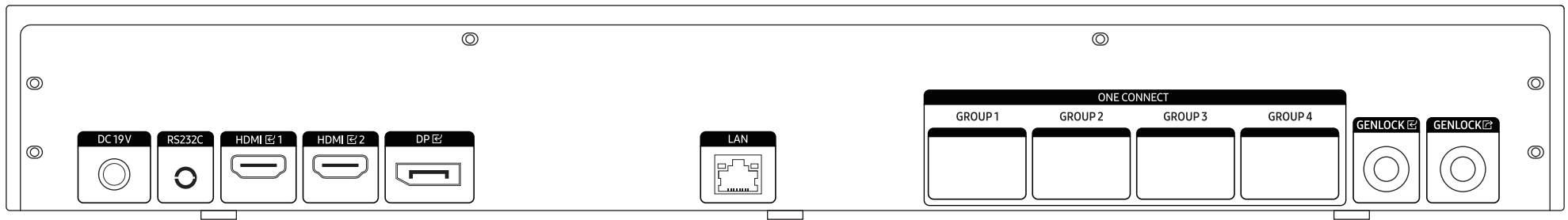



Parts	Description
DC 19V	Connects to the AC/DC adapter.
RS232C	Used for service purposes.
HDMI 1 HDMI 2	Connects to a source device using a HDMI cable or HDMI-DVI cable.
DP	Connects to a PC using a DP cable.
LAN	Connect to a network using the LAN cable. (10/100 Mbps)
ONE CONNECT (Group 1, Group 2, Group 3, Group 4)	Connects to a cabinet using an optical cable.
GENLOCK	Used for synchronizing the S-Box with an external sync generator.
GENLOCK	

 For more information about connecting some terminals, refer to the installation guide or contact the installer.

SBB-CV4B

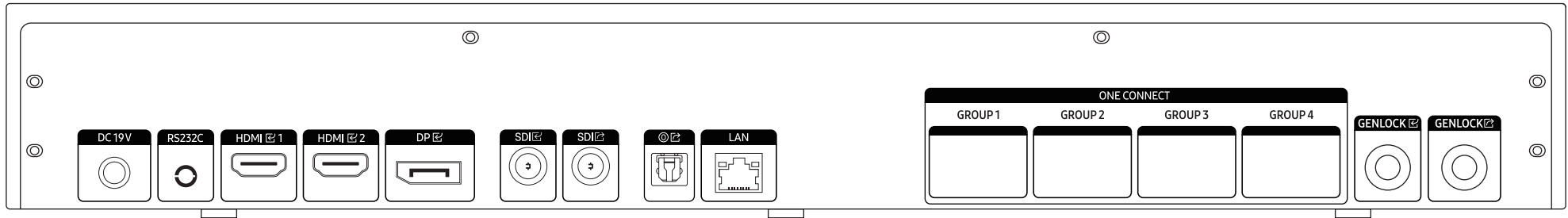
 The colour and shape of parts may differ from what is shown. Specifications are subject to change without notice to improve quality.









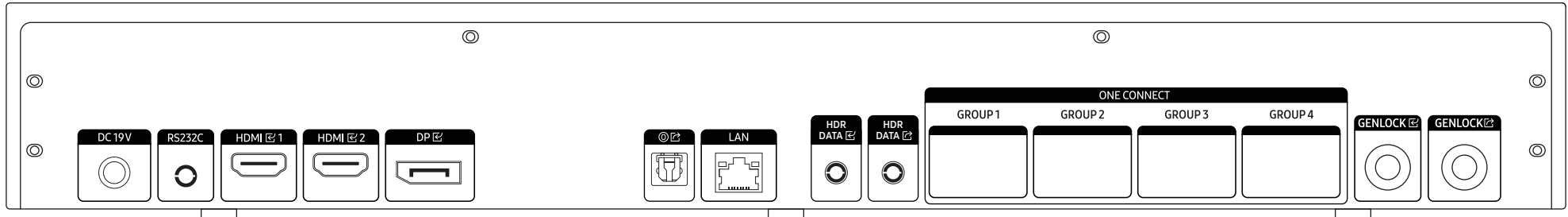

Parts	Description
DC19V	Connects to the AC/DC adapter.
RS232C	Used for service purposes.
HDMI 1 HDMI 2	Connects to a source device using a HDMI cable or HDMI-DVI cable.
DP	Connects to a PC using a DP cable.
SDI	Connects to a source device using an SDI cable.
SDI	Connects to a device using an SDI cable.
	Connects to a audio device using the optical(digital) cable.
LAN	Connect to a network using the LAN cable. (10/100 Mbps)
ONE CONNECT (Group 1, Group 2, Group 3, Group 4)	Connects to the I/G card using optical modules.
GENLOCK	Used for synchronizing the S-Box with an external sync generator.
GENLOCK	

 For more information about connecting some terminals, refer to the installation guide or contact the installer.

SBB-CS4B

 The colour and shape of parts may differ from what is shown. Specifications are subject to change without notice to improve quality.



Parts	Description
DC19V	Connects to the AC/DC adapter.
RS232C	Used for service purposes.
HDMI 1 HDMI 2	Connects to a source device using a HDMI cable or HDMI-DVI cable.
DP	Connects to a PC using a DP cable.
	Connects to a audio device using the optical(digital) cable.
LAN	Connect to a network using the LAN cable. (10/100 Mbps)
HDR DATA 	Connects to the HDR DATA  port on the next S-Box.
HDR DATA 	Connects to the HDR DATA  port on the previous S-Box to receive video data.
ONE CONNECT (Group 1, Group 2, Group 3, Group 4)	Connects to the I/G card using optical modules.
GENLOCK 	Used for synchronizing the S-Box with an external sync generator.
GENLOCK 	





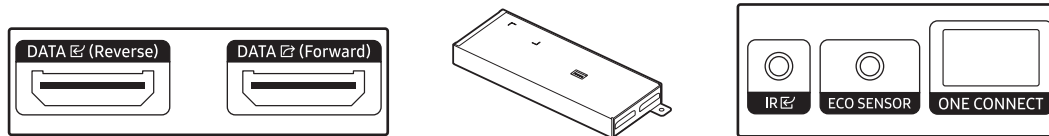

 For more information about connecting some terminals, refer to the installation guide or contact the installer.

Interface Gender Card (I/G Card)

 SBB-CV4B / SBB-CS4B model only

 The colour and shape of parts may differ from what is shown. Specifications are subject to change without notice to improve quality.



Parts	Description
DATA (Reverse)	Connects to the DATA port on the last cabinet using an OCM cable.
DATA (Forward)	Connects to the DATA port on the first cabinet using an OCM cable.
IR	Connects to an external IR cable that receives signals from the remote control.
ECO SENSOR	<p>Connects an external ambient light sensor to the ECO SENSOR port. Automatically recognises the ambient brightness and adjusts the brightness of the cabinet connected to the I/G card. To turn off this function, set Eco Sensor to Off at System → Eco Solution.</p> <p> The ECO SENSOR port is only available for SBB-CS4B.</p> <p> Only one external ambient light sensor is provided. (SBB-CS4B model only) The external ambient light sensor operates with only one of multiple I/G cards. Even if multiple I/G cards are connected, external ambient light sensor operates with only the one I/G card connected at the top.</p> <p> After connecting to or disconnecting from the ECO SENSOR port on the I/G card, reboot S-Box.</p> <p> Note that the cabinet may be subject to shadows or light interferences depending on the installation position.</p> <p> The external ambient light sensor is marked with the label on the sensor cable.</p>
ONE CONNECT	<p>Use to connect the optical cable to the ONE CONNECT (Group 1, Group 2, Group 3, Group 4) port after connecting the optical modules for the I/G card.</p> <p> See “Connecting a Optical Cable” in “Connecting and using devices”</p> <p> The optical cable is not provided.</p>

Prior to Installation

Precautions for installation

- It is recommended that this device be installed in a 19-inch rack case, rather than under general consumer environment conditions.
- Make sure that the ambient temperature inside the rack does not exceed 35°C.
- If installing more than one S-Box, ensure that there is a space of at least 1U (approximately 44.45 mm) between the S-Boxes to prevent the vent on top of each S-Box from being blocked.
- Make sure the vent faces upward. Do NOT install the device in portrait orientation or upside down.
- Make sure the vent on top is not blocked to prevent the device from overheating.
- Exercise caution to ensure that no foreign material enters the vent on top of the device.
- If installing the device close to a wall, make sure that there is a space of at least 10 mm between the wall and the four sides of the device to ensure good ventilation.
- Make sure that there is a space of at least 50 mm between the wall and the rear ports of the device to gain access for connection of cables.

for example) SBB-CX4B

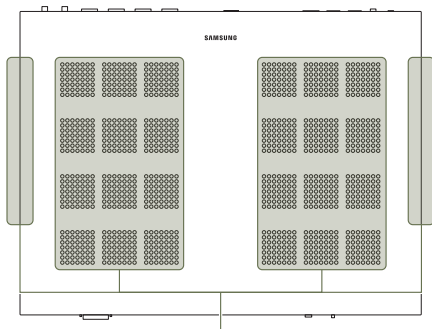

Air outlet

Installing S-Box on Rack Case

 The colour and shape of parts may differ from what is shown. Specifications are subject to change without notice to improve quality.

for example) SBB-CX4B

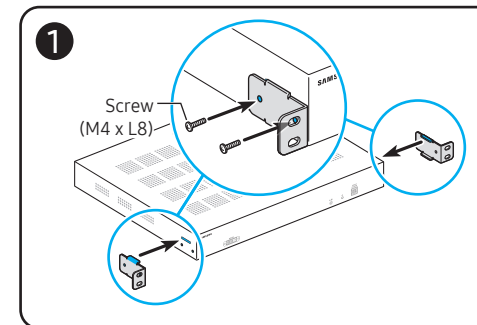
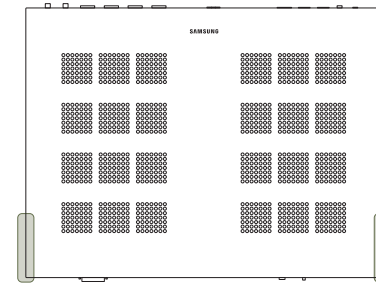



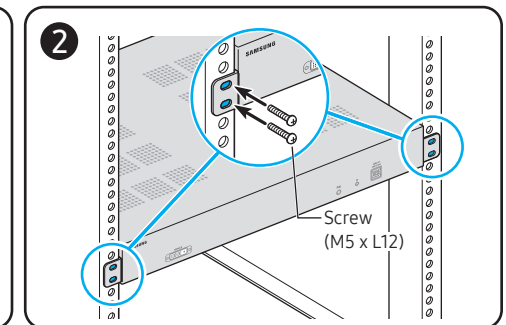

1 Attach the brackets to both sides of the S-Box main unit.







2 Fix the S-Box to the rack case.

 Use appropriate screws that are compatible with the rack case size.

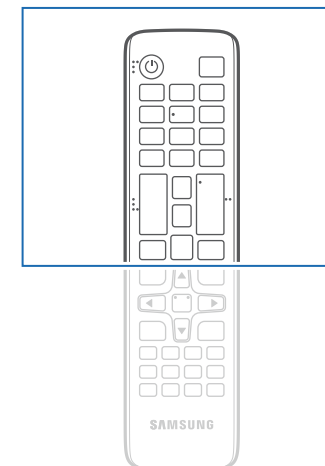
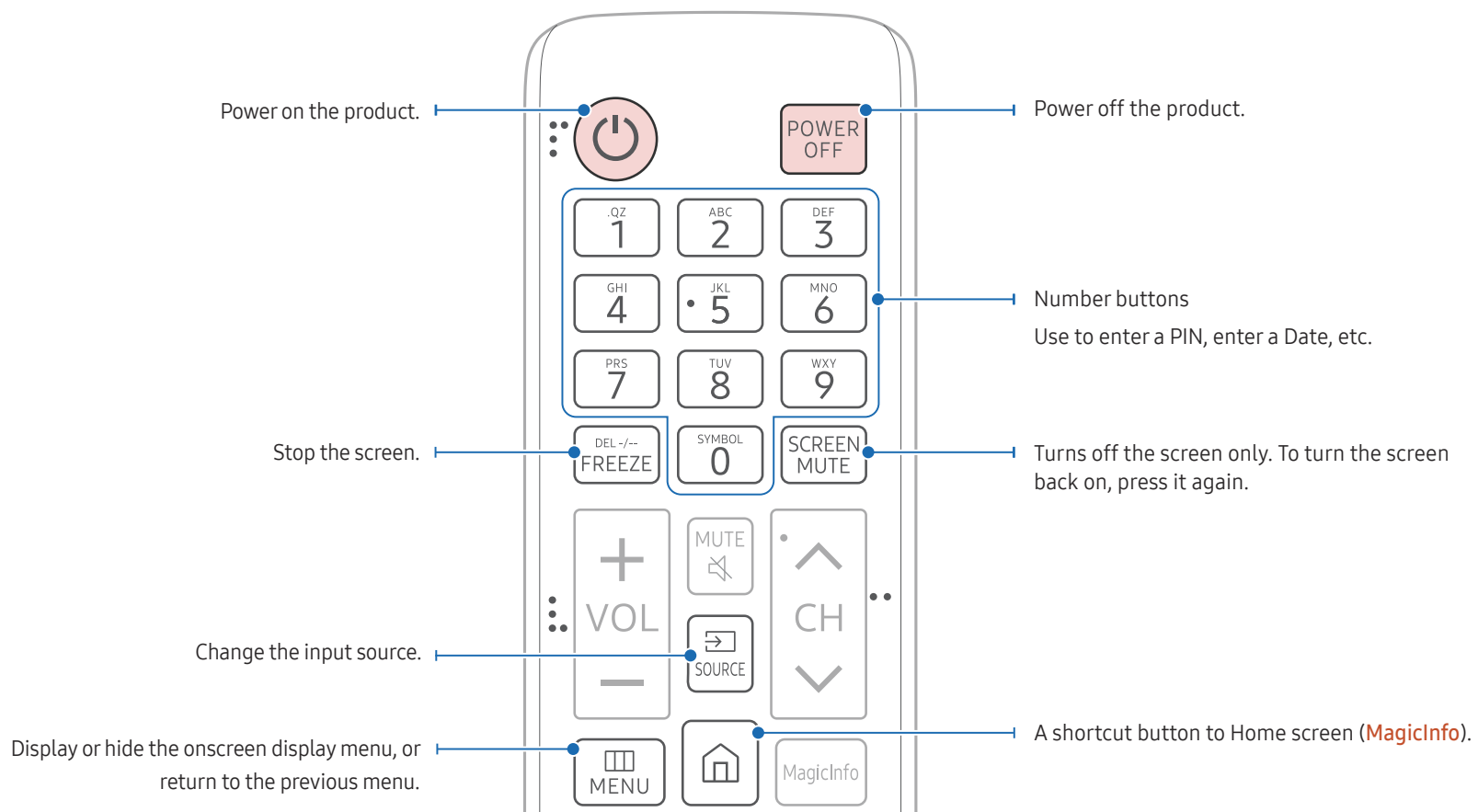

Remote Control

-  SBB-CV4B / SBB-CS4B model only
-  Using other display devices in the same space as the remote control of this product can cause the other display devices to be inadvertently controlled.
-  A button without a description in the image below is not supported on the product.
-  The FREEZE function is only available for **Source**.

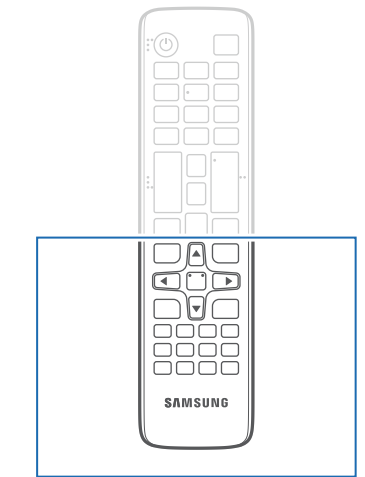
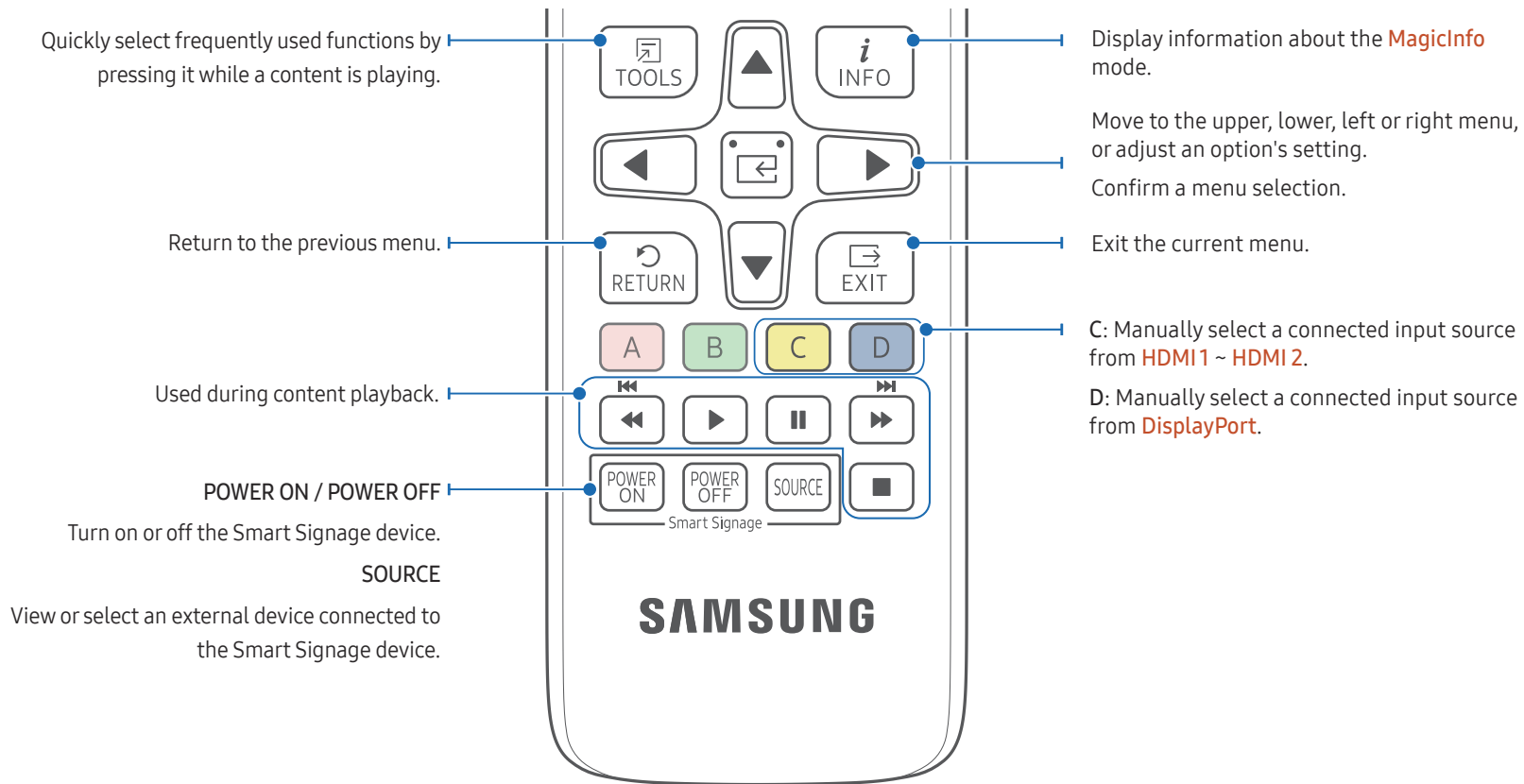

-  Remote control button functions may differ for different products.
-  Press a button on the remote control pointing at the sensor of the IR cable to perform the corresponding function.
-  Use the remote control within 7 m to 10 m from the sensor on the product at an angle of 30° from the left and right.



-  Remote control button functions may differ for different products.
-  Remove batteries when the remote control is not to be used for an extended period of time.

To place batteries in the remote control (AAA x 2)

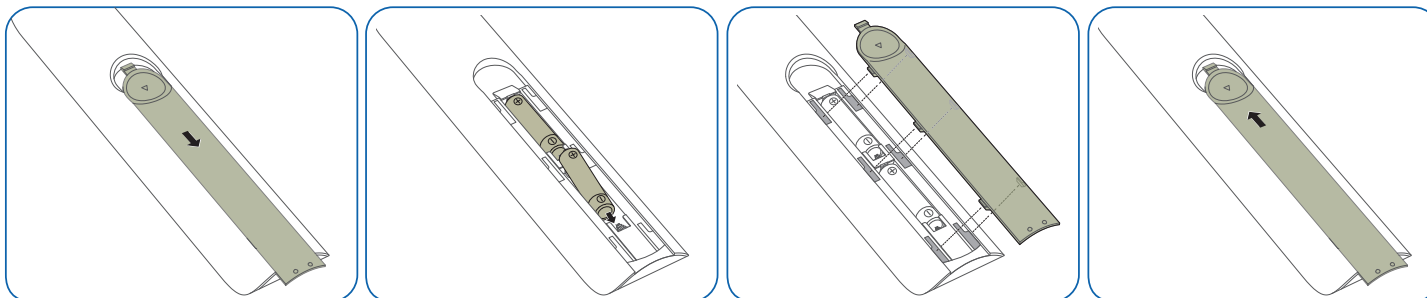

Chapter 03

Connecting and using devices

Before Connecting

Pre-connection Checkpoints

- ✎ Also refer to the user guide for the source device you want to connect with. The number and location of ports available on the source device may vary.
- ✎ Do not connect the power cable until all connections are completed. Connecting the power cable during connection may damage the product.
- ✎ Check the types of ports at the back of the product you want to connect.

For more information about connecting some terminals, refer to the installation guide or contact the installer.

Connecting to a PC

- Do not connect the power cable before connecting all other cables. Ensure you connect a source device first before connecting the power cable.
- A PC can be connected to the product in a variety of ways. Select a connection method suitable for your PC.

Connection Using an HDMI Cable

- ✎ Connecting parts may differ in different products.

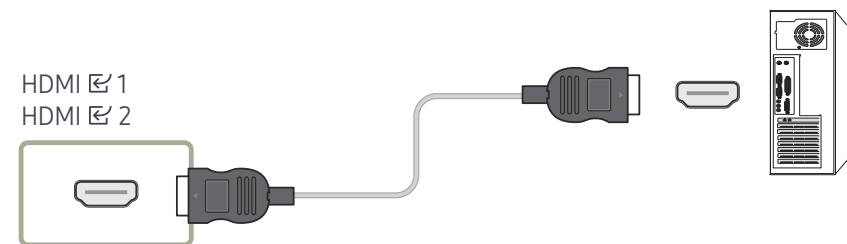

Connection Using an HDMI-DVI Cable

 Connecting parts may differ in different products.

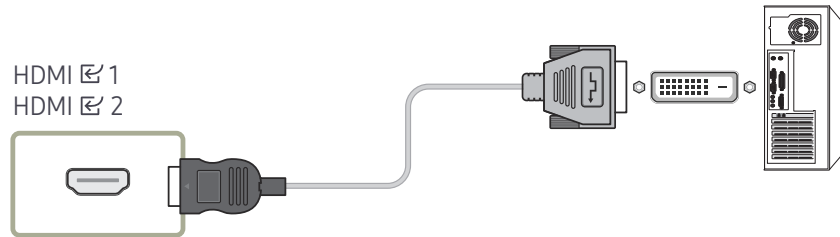

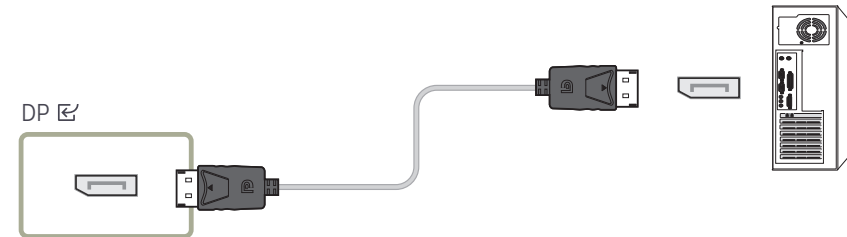

Connection Using an DP Cable

 Connecting parts may differ in different products.



- Precautions for using DP

-  To increase the standby power capacity, the product stops DP communication when it is turned off or in power-saving mode.
If the product in dual monitor mode is turned off or goes into power-saving mode, monitor setting changes may not be updated. As a result, screen output may not be displayed properly.
-  Some graphics cards that are not compliant with the DP standard may prevent the Windows Booting/Bios screen from being displayed when the product is in power-saving mode. If this is the case, make sure to turn on the product first before turning on your PC.
-  Using a DP cable that is not VESA compliant may cause the product to function improperly. Samsung shall not be held responsible for any issues from using a cable that is not VESA compliant.
Make sure to use a DP cable that is VESA compliant.

Connecting to a Video Device

- Do not connect the power cable before connecting all other cables. Ensure you connect a source device first before connecting the power cable.
 - You can connect a video device to the product using a cable.
-  Press the SOURCE button on the remote control to change the source.

Connection Using an HDMI-DVI Cable

 Connecting parts may differ in different products.

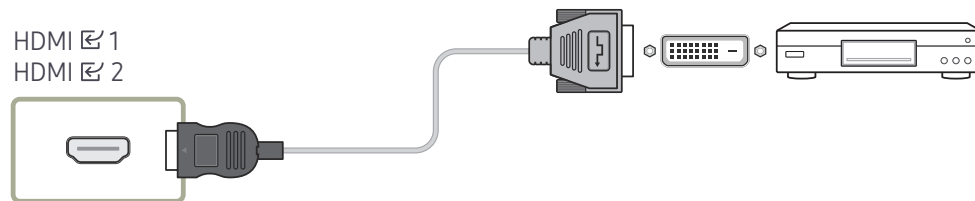

Connection Using an HDMI Cable

 Connecting parts may differ in different products.

Using an HDMI Cable or HDMI to DVI Cable

- For better picture and audio quality, connect to a digital device using an HDMI cable.
- If the product is connected to an external device that is compatible with an older HDMI version, the product may not display screen colours properly. It may also display a blank screen. If such a problem occurs, ask the manufacturer of the external device about the HDMI version and, if out of date, request an upgrade.
- Be sure to use an HDMI cable with a thickness of 14 mm or less.
- Be sure to purchase a certified HDMI cable. Otherwise, the picture may not display or a connection error may occur.
- A basic high-speed HDMI cable or one with ethernet is recommended. This product does not support the ethernet function via HDMI.

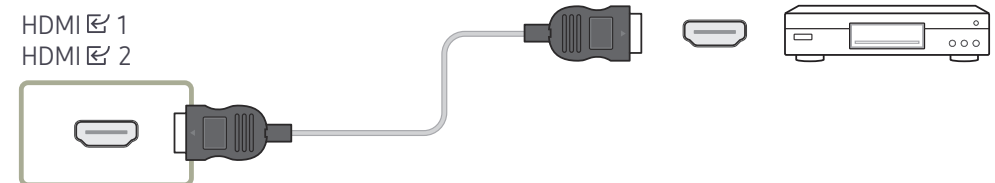

Connection Using a DP Cable

 Connecting parts may differ in different products.

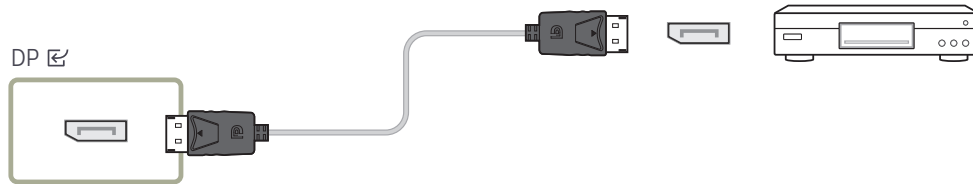

Connection Using a Coaxial Cable

GENLOCK Port

 Connecting parts may differ in different products.

- Reference signals are received from an external input device (video device), and the received signals are synchronized with a different video device through GENLOCK.
- Only the S-Box can be connected to the Genlock output port.
- The Genlock loop output connector can cascade a maximum of eight S-Box units. However, it is best to connect up to four S-Box units only.

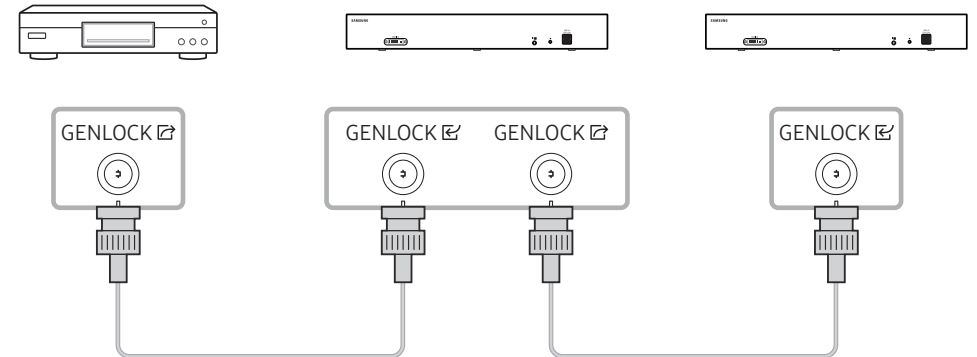

SDI Port

 SBB-CV4B model only

 Connecting parts may differ in different products.

- Signals are received from an external input device (video device) through SDI , and the received signals are sent to a different video device through SDI .
-  To receive SDI signals from broadcasting equipment that sends SDI signals, make sure to connect to the equipment by using an SDI cable that meets the following specifications: 75 Ω Coaxial, 12G SDI.

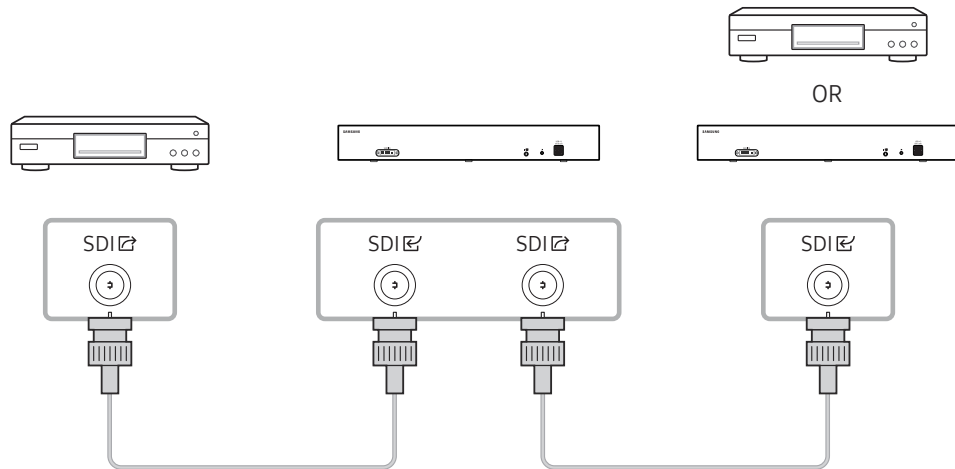

Connection Using an Aux Cable

HDR DATA Port

 SBB-CS4B model only

 Connecting parts may differ in different products.

- Perfect Sync timing between S-Box by sharing Master Box's LED HDR metadata

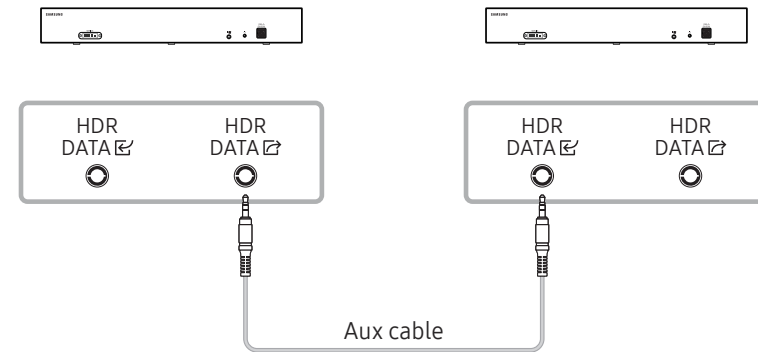

Connecting the LAN Cable

 Connecting parts may differ in different products.

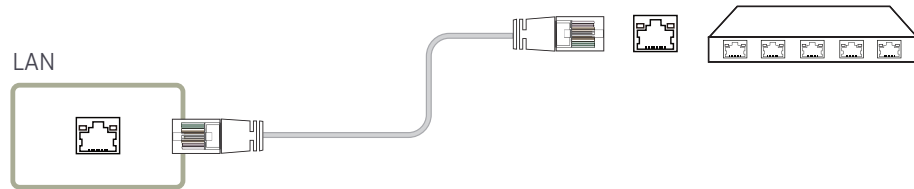

- Use Cat7(*STP Type) cable for the connection. (10/100 Mbps)
*Shielded Twisted Pair

Connecting a Optical Cable

 SBB-CV4B / SBB-CS4B model only

 Connecting parts may differ in different products.



Connecting to the One Connect

 Connecting parts may differ in different products.

 For more information refer to the installation guide.

SBB-CX4B

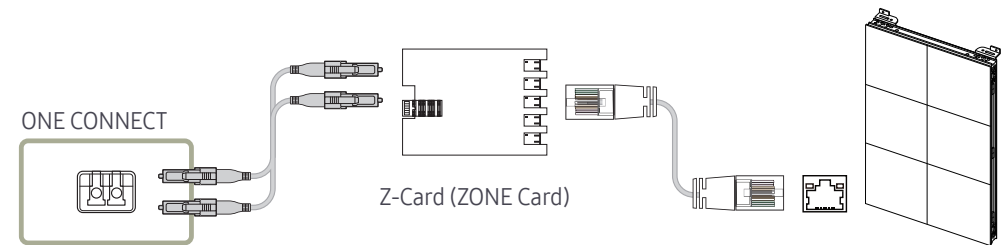

SBB-CV4B / SBB-CS4B

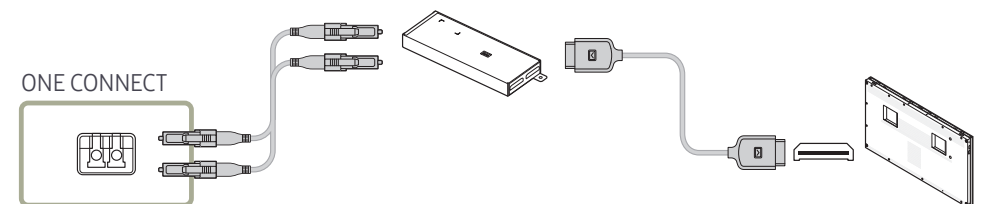

- Use special caution to ensure that the connector is connected correctly. Incorrect connection may cause malfunction.
Connect the cable to the connector in the direction shown in the figure. Insert the cable gently until a “click” sound is audible.

Changing the Input source

Source

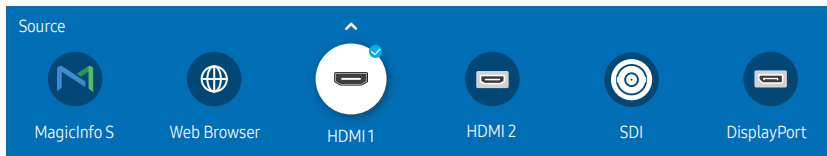

☰ SOURCE → Source



 The displayed image may differ depending on the model.

Source allows you to select a variety of sources and change source device names.

You can display the screen of a source device connected to the product. Select a source from source list to display the screen of the selected source.

-  The input source can also be changed by using the SOURCE button on the remote control.
-  The screen may not display correctly if an incorrect source is selected for the source device you want to convert to.

Edit

☰ SOURCE → ▲ → Edit → ↵

Edit the name and device type of a connected external device.

- The list can include the following source devices (**HDMI 1** / **HDMI 2** / **SDI** / **DisplayPort**). Source devices on the list differ depending on the selected source.
Cable Box / **Game Console** / **PC** / **Blu-ray player**
- You cannot edit the following sources.
MagicInfo S

SMARTVIEW+

☰ SOURCE →  SMARTVIEW+ → ↵

- You can view multiple content items through **SMARTVIEW+**.
 - To start the function, select **SMARTVIEW+**, and then select the content to add in Select content. or select a desired combination in Preset at the top of **SMARTVIEW+**. Or run screen sharing for your mobile device.
-  SBB-CS4B model only

Web Browser

☰ SOURCE → 🌐 Web Browser → ↗

✎ Connect the network to access the Internet from the product like accessing the Internet from a computer.

Settings

☰ SOURCE → 🌐 Web Browser → ▲ → Settings → ↗

Refresh Interval

Set the time for the web browser to wait before returning to the home page.

- Off / 5 min / 10 min / 15 min / 30 min

Zoom

Set the zoom scale to apply when the web browser is refreshed.

- 50% / 75% / 100% / 125% / 150% / 200% / 300%

Home Page

Set the website to display when the web browser is refreshed.

- Samsung Display / Custom

Custom

Enter the URL to set as the home page.

- Enter URL

✎ Available only when Home Page is set to Custom.

Advanced Settings

General

Hide Tabs and Toolbar automatically	If the browser tabs, menu or toolbar are not used for a while, they will automatically disappear. To make them appear again, move the pointer or focus to the top of the screen. <ul style="list-style-type: none">• Use / Do not use
Hide Cursor in Touch Mode	Hide the cursor to prevent interference with touch operation. <ul style="list-style-type: none">• Use / Do not use
Pop-up Blocker	Make your browsing experience more pleasant by blocking pop-up windows. <ul style="list-style-type: none">• Use / Do not use
Reset Settings	All your customised Web Browser settings will be reset to their default values. Your bookmarks and history won't be affected.

Search Engine

If you enter a keyword in the URL/keyword input field, Web Browser will open the Search Results page. Choose the search engine you want to use.

- Google / Bing

Privacy & Security	
Do Not Track	Ask websites not to track you. <ul style="list-style-type: none"> Use / Do not use
Delete History	Delete your entire browsing history.
JavaScript	Allow all sites to run JavaScript for a better browsing experience. <ul style="list-style-type: none"> Use / Do not use
Delete browsing data	Delete all browsing data such as cookies, cached images and data. Your bookmarks and history won't be affected.

Encoding	
Encoding	Choose an encoding method for web pages. The current setting is Auto. <ul style="list-style-type: none"> Auto / Manual (Current: Unicode)

About	
Display the current version of Web Browser.	

Read Before Using the Web Browser Function

Read this information before using the Web Browser function.

- File download is not supported.
- The **Web Browser** function may not be able to access certain websites, including websites operated by certain companies.
- The product does not support playback of flash videos.
- E-commerce for online purchases is not supported.
- ActiveX is not supported.
- Only a limited number of fonts are supported. Certain symbols and characters may not be displayed properly.
- The response to remote commands and the resulting on-screen display may be delayed while a web page is loading.
- Loading a web page may be delayed or suspended completely depending on the status of the participating systems.
- Copy and paste operations are not supported.
- When composing an email or a simple message, certain functions such as the font size and colour selection may not be available.
- There is a limit to the number of bookmarks and the size of the log file that can be saved.
- The number of windows that can be opened concurrently is limited.
- Web browsing speed will differ with the network environment.
- Browsing history is saved from latest to oldest, with the oldest entries being overwritten first.
- Depending on the types of video/audio codecs supported, you may not be able to play certain HTML5 video and audio files.
- Video sources from PC-optimised streaming service providers may not play properly on our proprietary **Web Browser** browser.

Chapter 04

Multiple Display Control

Control multiple display devices connected to a PC simultaneously.

Cable Connection

LAN Cable

- Pin assignment

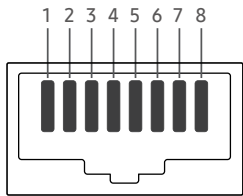

Pin No	Standard Colour	Signal
1	White and orange	TX+
2	Orange	TX-
3	White and green	RX+
4	Blue	NC
5	White and blue	NC
6	Green	RX-
7	White and brown	NC
8	Brown	NC

- Connector: RJ45

Direct LAN cable (PC to HUB)

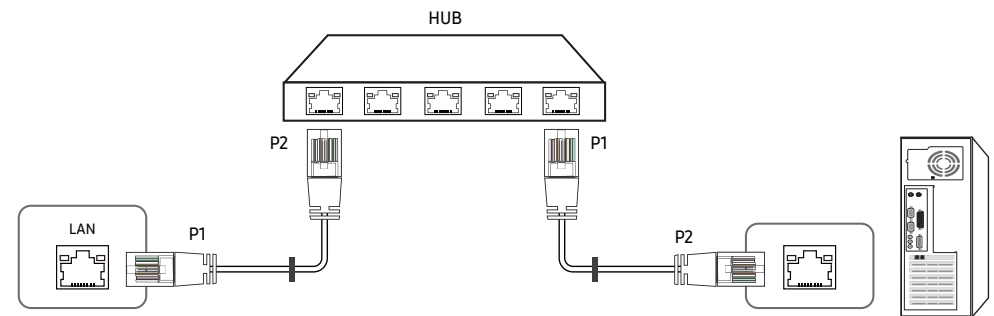

Signal	P1		P2	Signal
TX+	1	↔	1	TX+
TX-	2	↔	2	TX-
RX+	3	↔	3	RX+
RX-	6	↔	6	RX-

Cross LAN cable (PC to PC)

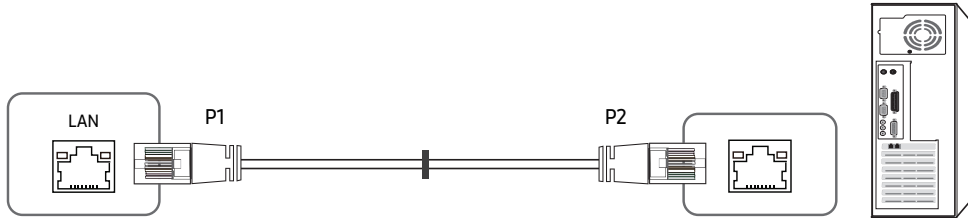

Signal	P1		P2	Signal
TX+	1	↔	3	RX+
TX-	2	↔	6	RX-
RX+	3	↔	1	TX+
RX-	6	↔	2	TX-

Control Codes

Viewing control state (Get control command)

Header	Command	ID	Data length	Checksum
0xAA	Command type		0	

Controlling (Set control command)

Header	Command	ID	Data length	Data	Checksum
0xAA	Command type		1	Value	

Command

No.	Command type	Command	Value range
1	Power control	0x11	0~1
2	Input source control	0x14	-
3	Screen mode control	0x18	-
4	Safety Lock	0x5D	0~1

- All communications take place in hexadecimals. The checksum is calculated by adding up all values except the header. If a checksum adds up to be more than 2 digits as shown below (11+FF+01+01=112), the first digit is removed.

E.g. Power On & ID=0

Header	Command	ID	Data length	Data 1	Checksum
0xAA	0x11		1	"Power"	

Header	Command	ID	Data length	Data 1	12
0xAA	0x11		1	1	

- To control all devices connected by a serial cable simultaneously irrespective of IDs, set the ID as "0xFE" and transmit commands. Commands will be executed by each device but ACK will not respond.

Power control

- Function
A product can be powered on and off using a PC.
- Viewing power state (Get Power ON / OFF Status)

Header	Command	ID	Data length	Checksum
0xAA	0x11		0	

- Setting power ON/Off (Set Power ON / OFF)

Header	Command	ID	Data length	Data	Checksum
0xAA	0x11		1	"Power"	

"Power": Power code to be set on a product.

1: Power ON

0: Power OFF

- Ack

Header	Command	ID	Data length	Ack/Nak	r-CMD	Val1	Checksum
0xAA	0xFF		3	'A'	0x11	"Power"	

"Power": Power code to be set on a product.

- Nak

Header	Command	ID	Data length	Ack/Nak	r-CMD	Val1	Checksum
0xAA	0xFF		3	'N'	0x11	"ERR"	

"ERR": A code showing what error has occurred.

Input source control

- **Function**
The input source of a product can be changed using a PC.
- **Viewing input source state (Get Input Source Status)**

Header	Command	ID	Data length	Checksum
0xAA	0x14		0	

- **Setting the input source (Set Input Source)**

Header	Command	ID	Data length	Data	Checksum
0xAA	0x14		1	"Input Source"	

"Input Source": An input source code to be set on a product.

Header	Input source	Description
0x0C	Input source	At present, supports only reading the input source status.
0x21	HDMI1	
0x23	HDMI2	
0x25	DISPLAY PORT	
0x60	MagicInfo	
0x63	URL Launcher	Operates only with URL Launcher.
0x65	Web Browser	

 This model does not support HDMI1 and HDMI2.

 **MagicInfo** is only available with models that contain the **MagicInfo** function.

- **Ack**

Header	Command	ID	Data length	Ack/Nak	r-CMD	Val1	Checksum
0xAA	0xFF		3	'A'	0x14	"Input Source"	

"Input Source": An input source code to be set on a product.

- **Nak**

Header	Command	ID	Data length	Ack/Nak	r-CMD	Val1	Checksum
0xAA	0xFF		3	'N'	0x14	"ERR"	

"ERR": A code showing what error has occurred.

Safety Lock

- Function
PC can be used to turn the **Safety Lock On** function on or off on a product.
This control is available regardless of whether or not the power is turned on.
- Viewing the safety lock state (Get Safety Lock Status)

Header	Command	ID	Data length	Checksum
0xAA	0x5D		0	

- Enabling or disabling safety lock (Set Safety Lock Enable / Disable)

Header	Command	ID	Data length	Data	Checksum
0xAA	0x5D		1	"Safety Lock"	

"Safety Lock": Safety lock code to be set on a product

1: ON

0: OFF

- Ack

Header	Command	ID	Data length	Ack/Nak	r-CMD	Val1	Checksum
0xAA	0xFF		3	'A'	0x5D	"Safety Lock"	

"Safety Lock": Safety lock code to be set on a product

- Nak



Header	Command	ID	Data length	Ack/Nak	r-CMD	Val1	Checksum
0xAA	0xFF		3	'N'	0x5D	"ERR"	

"ERR": A code showing what error has occurred

Using LED Signage Manager

The **LED Signage Manager** software allows you to easily control multiple display devices from your computer.

For details on how to use the **LED Signage Manager** software, refer to the Help after installing the software. The **LED Signage Manager** software is available on the website.

-  The installation process for **LED Signage Manager** may be affected by the graphics card, motherboard, and network environment.
-  Make sure that Windows 7 or higher and Microsoft .NET Framework 4.5 are installed on the computer, before installing **LED Signage Manager**.

Installing / Uninstalling the software

-  Installing and uninstalling steps can vary depending on the OS.

Installing

- 1 Run the **LED Signage Manager** installation file.
- 2 When the installation window appears, read the instructions and click **Next**.
- 3 Agree to the licence agreement and click **Yes**.
- 4 Set the installation folder and click **Next**.
 - If an installation folder is not specified, the software will be installed in the default folder.
- 5 Check that the user information and installation folder have been correctly configured. Click **Next**.
- 6 After installation is complete, click **Finish**.
 - To start LSM immediately, select the **Launch LED Signage Manager** checkbox.
 - After the software is installed, the shortcut icon is created on the desktop.
 - The shortcut icon may not appear, depending on the computer system and product specifications. If the shortcut icon does not appear, press the F5 key.

Uninstalling

If there is an issue with the software, follow the steps below to uninstall the software.

-  The uninstall process may vary, depending on the computer operating system. This user guide assumes that Windows 7 is used.

- 1 Select **Start** → **Control Panel** → **Programs and Features**.
- 2 From the list, select **LED Signage Manager** and click **Uninstall**.
- 3 When the delete confirmation dialog box appears, click **Yes**.
- 4 After uninstallation is complete, click **Finish**.

Chapter 05

Player feature

Accessible using the  button on the remote control.



Player

 → **Player** → 

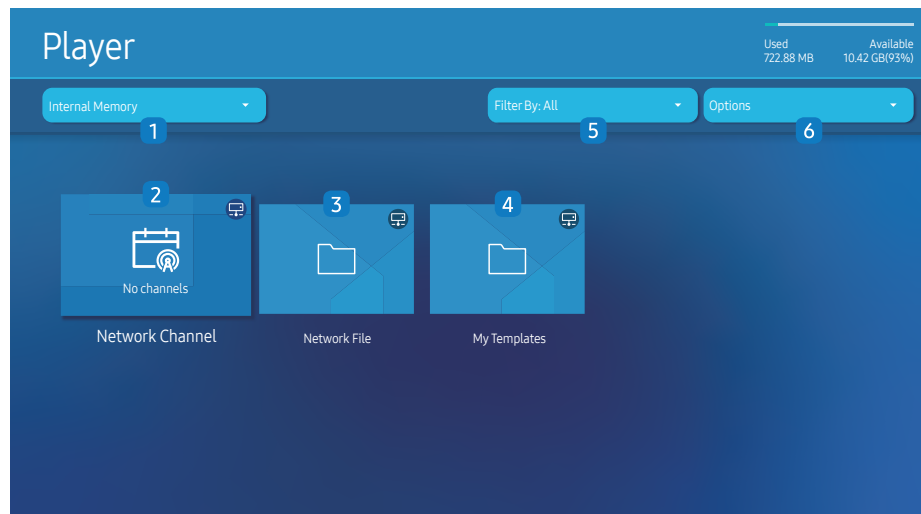
Play a range of content such as channels with schedules assigned, templates or files.



 The displayed image may differ depending on the model.

 To use the **Player** feature, set **Play via** to **MagicInfo** in **System**.
( MENU → **System** → **Play via** → **MagicInfo**)

 You must set **Clock Set** before you can use this feature.

No.	Description
1	Select between internal or external memory.
2	Play content, templates and schedules configured on the server. <ul style="list-style-type: none"> You can view whether the server is connected (approval) in the Player screen. To view whether the server is connected when a Network Channel is running, press INFO on the remote control. <ol style="list-style-type: none"> Select Network Channel from the Player screen. The No channels message appears if no channel has been registered in Network Channel. Network Channel will run.
3	Play content stored on the server.
4	Play templates stored in My Templates folder in the Internal Memory.
5	Select a content type as criterion to search for a desired content list.
6	Set different options for Player .

Viewing content

- 1 Select either internal or external memory. The files saved in the selected memory appear.
- 2 Select the desired file. The content appears on the screen. (For more information on compatible file formats, see the "File formats compatible with Player" section.)

When content is running

Control buttons on the remote control

You can play, pause, or skip the content on the playlist by pressing buttons on the remote control.

Button	Function
TOOLS	Brings up the menu bar.
INFO	Displays the information of device and server connection.
▶	Goes to next file or page.
◀	Goes to previous file or page.
◀ / ▶ / ⏸	Plays or pauses slide show or video content.
■	Stops displaying content and goes to the Player screen.
◀◀	Rewinds the video content.
▶▶	Fast forwards the video content.

 If there is only one image file in the Internal Memory or USB, the Slide Show will not play.

 If the name of a folder is too long on the USB, you cannot select the folder.

Available menu

Press the TOOLS button on the remote control during content playback to configure settings.

Menu	Description
Playlist	View a list of content items currently playing.
Channel List	Network Channel / Internal Channel / USB
Repeat All / Repeat One	Set the repeat mode.
Background Music	Set the background music to be played when content is running.
Reset	Reset the background music.
Pause	Pause the background music.
Prev	Play the previous background music on the list.
Next	Play the next background music on the list.

 **Reset, Pause, Prev, Next** only appear when the background music is set.

File Formats Compatible with Player

- Supported file systems include FAT32 and NTFS.
- A file with a vertical and horizontal resolution larger than the maximum resolution cannot be played. Check the vertical and horizontal resolution of the file.
- Check supported video codec types and versions.
- Check the supported file versions.
 - ✎ PowerPoint version up to 97 – 2013 is supported
 - ✎ Audio file is not supported.
 - ✎ For USB-**Internal Memory** file transfer, click **Options** → **Send**.
 - Location of template files
 - **Internal Memory** → USB transfer: USB → under MagicinfoSlide folder
 - USB → **Internal Memory** transfer: **Internal Memory** → under My Templates folder
 - Location of other files (non-template)
 - **Internal Memory** → USB transfer: USB → under MagicinfoSlide folder
 - USB → **Internal Memory** transfer: Under the root folder

Network Schedule Multiframe

Playback restrictions

- 1 to 3 FHD video files can be played simultaneously or only one UHD video file and one FHD video file at a time. In portrait playback mode, 3 FHD video files can be played simultaneously or only one UHD video file at a time.
- For **Office** files (PPT and Word files) and **PDF** files, only one file type is supported at a time.
- LFD(*.LFD) files are not supported.

Template files(*.LFD)

Restrictions

- Check that you have **Contents** and **Schedules** folders published to the USB storage device.
- ✎ A properly published content appears as **Published Content** (📁) in the USB device.
- ✎ When copying a content you published to a USB device (**Published Content** (📁)) to the **Internal Memory**, the content appears in **Internal Memory** as **Published Content** (📁) only. **Contents** and **Schedules** folders are not visible under **Internal Memory**.

Playback restrictions

- A maximum of two video (**Video**) files can be played.
- For **Office** files (PPT and Word files) and **PDF** files, only one file type is supported at a time.
- When playing more than one video files simultaneously, make sure that the display areas are not overlapping one another.

Content

File format	Container	Video codecs	Resolution	Frame rate (fps)	Bit rate (Mbps)	Audio codecs			
*.avi	AVI MKV ASF MP4 3GP MOV FLV VRO VOB PS TS SVAF	H.264 BP/MP/HP	3840 x 2160	60	60	Dolby Digital LPCM ADPCM(IMA, MS) AAC HE-AAC WMA Dolby Digital+ MPEG(MP3) AC-4 G.711(A-Law, μ -Law) OPUS			
*.mkv		HEVC (H.265 - Main, Main10)		30	80				
*.asf		Motion JPEG		1920 x 1080	60		20		
*.wmv		MVC							
*.mp4		MPEG4 SP/ASP							
*.mov		Window Media Video v9 (VC1)							
*.3gp		MPEG2							
*.vro		MPEG1							
*.mpg		Microsoft MPEG-4 v1, v2, v3	30						
*.mpeg		Window Media Video v7(WMV1), v8(WMV2)							
*.ts		H 263 Sorenson							
*.tp		VP6							
*.trp		AV1	3840 x 2160					60	80
*.flv									
*.vob									
*.svi	WebM	VP8	1920 x 1080	60	20				
*.m2ts						VP9 (Profile 0, profile 2 supported)	3840 x 2160	60	80
*.mts									
*.rmvb	RMVB	RV8/9/10 (RV30/40)	1920 x 1080	60	20	RealAudio 6			

Video	Image
<ul style="list-style-type: none"> • 3D video is not supported. • Content with a resolution larger than the resolution specified in the table above is not supported. • Video content with a Bit rate or Frame rate larger than the rate specified in the table above can cause choppy video during playback. • Video content will not play, or not play correctly, if there is an error in the content or the container. • Some USB/digital camera devices may not be compatible with the player. • H.264 UHD is supported up to Level 5.1, and H.264 FHD is supported up to Level 4.2 (TV does not support FMO / ASO / RS). • HEVC UHD is supported up to Level 5.2, and HEVC FHD is supported up to Level 4.1. • HEVC 8K is supported up to Level 6.1. • VC1 AP L4 is not supported. • GMC 2 or above is not supported. • When a single video file is playing, Seamless mode is not supported under the following conditions: <ul style="list-style-type: none"> – Incompatible codec (MVC, VP3, MJPEG) ↔ Incompatible codec – Incompatible codec ↔ Compatible codec – The resolution is different from that of the monitor – The frequency is different from that of the monitor 	<ul style="list-style-type: none"> • Compatible image file format: JPEG, PNG, BMP <ul style="list-style-type: none"> ✎ 32-bit, 24-bit and 8-bit BMP files are supported. • Supported maximum resolution: [PNG, BMP] 4096 x 4096, [JPEG] 7680 x 4320 • Supported maximum file size: 20MB • Supported Slideshow Effect: 9 effects (Fade1, Fade2, Blind, Spiral, Checker, Linear, Stairs, Wipe, Random)

Power Point	PDF	WORD
<ul style="list-style-type: none"> • Compatible document file formats <ul style="list-style-type: none"> – Extension: ppt, pptx – Version: Office 97 ~ Office 2013 • Functions not supported <ul style="list-style-type: none"> – Animation effect – 3D shapes (which will be displayed in 2D) – Header and footer (some subitems are not supported) – Word Art – Align <ul style="list-style-type: none"> A group alignment error may occur – Office 2007 <ul style="list-style-type: none"> SmartArt is not fully supported. 97 out of 115 subitems are supported. – Object insertion – Half-width characters – Letter spacing – Charts – Vertical text <ul style="list-style-type: none"> Some subitems are not supported – Slide notes and handout 	<ul style="list-style-type: none"> • Compatible document file formats <ul style="list-style-type: none"> – Extension: pdf • Functions not supported <ul style="list-style-type: none"> – Content less than 1 pixel not supported because of performance degradation issue. – Masked Image, Tiled Image content not supported. – Content with Rotated Text, not supported. – 3D Shadow Effects not supported. – Some characters not supported (Special characters may be corrupted) 	<ul style="list-style-type: none"> • Compatible document file formats <ul style="list-style-type: none"> – Extension: .doc, .docx – Version: Office 97 ~ Office 2013 • Functions not supported <ul style="list-style-type: none"> – Page background effect – Some paragraph styles – Word Art – Align <ul style="list-style-type: none"> A group alignment error may occur – 3D shapes (which will be displayed in 2D) – Office 2007 <ul style="list-style-type: none"> SmartArt is not fully supported. 97 out of 115 subitems are supported. – Charts – Half-width characters – Letter spacing – Vertical text <ul style="list-style-type: none"> Some subitems are not supported – Slide notes and handout

Schedule

Home → Schedule →

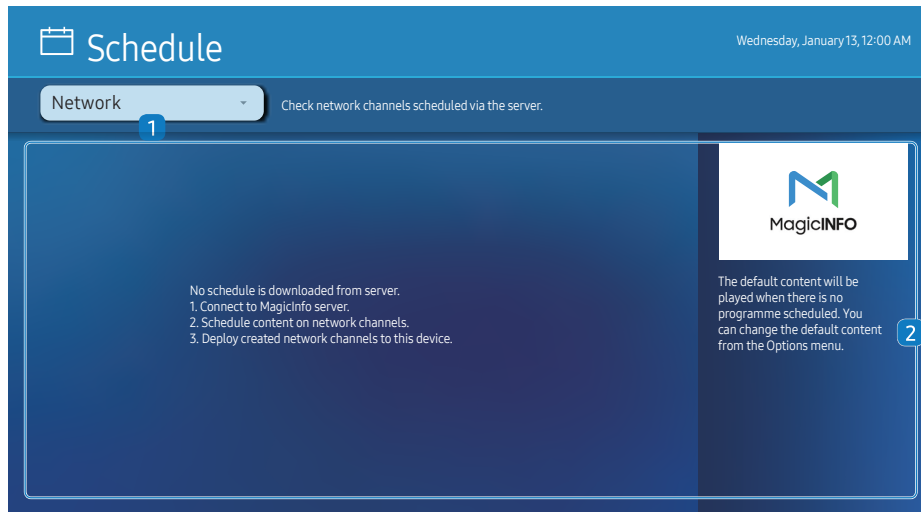

The displayed image may differ depending on the model.

You can check the schedule imported from a selected storage device.

To play the schedule, you must enter the channel that created the schedule.

No.	Description
1	Select the saved location of the schedule.
2	Create/Edit/Delete/View schedule of content playback.

Clone Product

🏠 → Clone Product → 📄

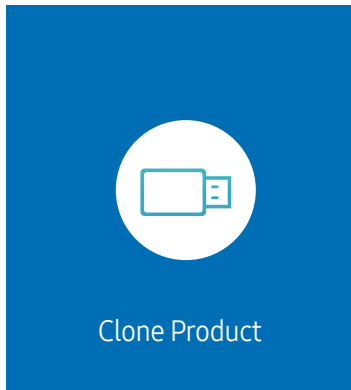

 The displayed image may differ depending on the model.

Export settings on the product to an external storage device. You can also import settings from an external storage device.

This option is useful when assigning the same settings to several products.

When a duplicate file is not found on the external storage device

- 1 Connect the external storage device, then run the **Clone Product** function.
- 2 The **No cloning file found on the external storage device. Export this device's settings to the external storage device?** message appears.
- 3 Select **Export** to export the settings.

When a duplicate file is found on the external storage device

- 1 Connect the external storage device, then run the **Clone Product** function.
 - 2 The **Cloning file found. Please select an option.** message appears.
Run the **Import from External Storage** or **Export to External Storage** function.
 - **Import from External Storage:** Copy settings saved on an external storage device to the product.
 - **Export to External Storage:** Copy settings on the product to an external storage device.
-  After configuration is complete, the product is rebooted automatically.

ID Settings

🏠 → ID Settings → ⏪

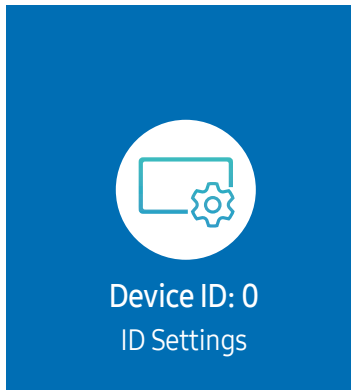

✎ The displayed image may differ depending on the model.

Assign an ID to a set.

Device ID

Set a unique ID number for each product. (Range: 1~225)

✎ Press ▲/▼ to select a number, and press ⏪.

✎ Enter the number you want using the number buttons on the remote control.

PC Connection Cable

Select which type of cable you are using to connect the display to the PC.

- **RS232C cable**
Communicate with MDC via the RS232C cable.
- **RJ-45 (LAN) or RJ-45 (LAN) Cable**
Communicate with MDC via the RJ45 cable.

Video Wall

🏠 → Video Wall → 📺

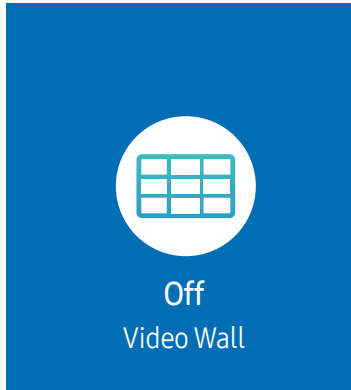

 The displayed image may differ depending on the model.

Customise the layout of multiple displays that are connected to form a video wall.

In addition, display part of a whole picture or repeat the same picture on each of the connected multiple displays.

To display multiple images, refer to MDC Help or the MagicInfo user guide. Some models may not support the MagicInfo function.

Video Wall

You can activate or deactivate **Video Wall**.

To organise a video wall, select **On**.

- **Off / On**

Network Status

Check the current network and Internet connection.

🏠 → Network Status → 🖥️

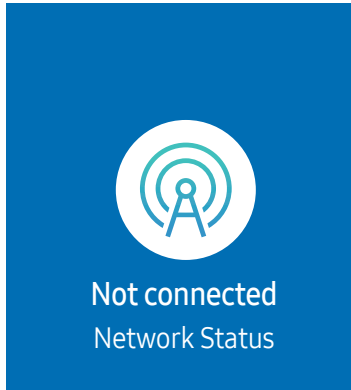

 The displayed image may differ depending on the model.

Picture Mode

🏠 → Picture Mode → 🖱️

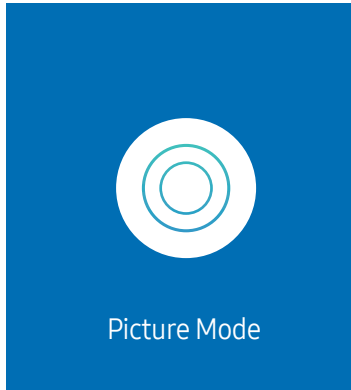

 The displayed image may differ depending on the model.

This menu provides an optimum picture quality suitable for the environment where the product will be used.

- **Dynamic / Standard / Movie / Live / Calibration**

On/Off Timer

🏠 → On/Off Timer → 📄

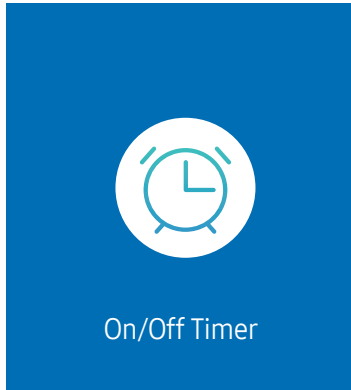

✎ The displayed image may differ depending on the model.

✎ You must set **Clock Set** before you can use this feature.

On Timer

Set **On Timer** so that your product turns on automatically at a time and on a day of your choice.

The product turns on according to the settings of the specified input source.

On Timer: Set the on timer by making a selection from one of the seven options. Ensure you set the current time first.

(**On Timer1** ~ **On Timer7**)

✎ While the internal/USB memory option can be used with **On Timer** for **MagicInfo** mode, it is recommended to use an internal memory.

✎ Proper operation of **On Timer** feature cannot be guaranteed if used with a battery powered USB device, which can take longer to be recognised.

- **Setup**: Select **Off**, **Once**, **Everyday**, **Mon~Fri**, **Mon~Sat**, **Sat~Sun** or **Manual**. If you select **Manual**, you can choose the days you want **On Timer** to turn on your product.
 - The check mark indicates days you've selected.
- **Time**: Set the hour and minute. Use the number buttons or the up and down arrow keys to enter numbers. Use the left and right arrow buttons to change entry fields.
- **Source**: Select the input source of your choice.
- **Content** (when the **Source** is set to **Internal/USB** for **MagicInfo** mode): From the USB device or internal memory, select a file (e.g. music, photo, or video) to play just after the product is turned on.

Off Timer

Set the off timer (**Off Timer**) by making a selection from one of the seven options. (**Off Timer1 ~ Off Timer 7**)

- **Setup:** Select **Off, Once, Everyday, Mon~Fri, Mon~Sat, Sat~Sun** or **Manual**. If you select **Manual**, you can choose the days you want **Off Timer** to turn off your product.
 - The check mark indicates days you've selected.
- **Time:** Set the hour and minute. Use the number buttons or the up and down arrow keys to enter numbers. Use the left and right arrow buttons to change entry fields.

Holiday Management

Timer will be disabled during a period specified as a holiday.

- **Add Holiday:** Specify the period you want to add as a holiday.
Select the start and end dates of the holiday you want to add using the ▲/▼ buttons, and click the **Done** button.
The period will be added to the list of holidays.
 - **Start Date:** Set the start date of the holiday.
 - **End Date:** Set the end date of the holiday.
- **Delete:** Delete selected items from the list of holidays.
- **Edit:** Select a holiday item and then change the date.
- **Set Applied Timer:** Set the **On Timer** and **Off Timer** to not activate on public holidays.
 - Press to select the **On Timer** and **Off Timer** settings you do not want to activate.
 - The selected **On Timer** and **Off Timer** will not activate.

Ticker

🏠 → Ticker → 📄

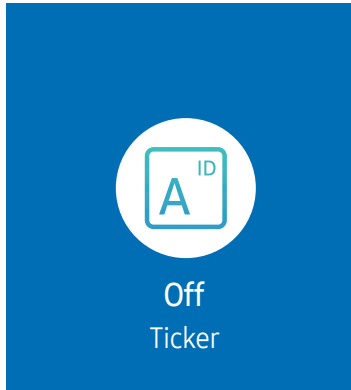

 The displayed image may differ depending on the model.







Input text while a video or image is displayed and display the text on the screen.



- **Off / On:** Set whether or not to use **Ticker**.
- **Message:** Enter a message to display on the screen.
- **Time:** Set the **Start Time** and **End Time** to display a **Message**.
- **Font options:** Specify the text font and colour for the message.
- **Position:** Select a position to display a **Message**.
- **Scroll:** Turn scroll effects of **Ticker** on or not. Specify the scroll **Direction** and **Speed** for the message.
- **Preview:** Preview your **Ticker** settings.





Chapter 06



Menu

Picture

2nd	3rd	Description
Picture Mode		Select the picture mode that best suits your viewing environment. <ul style="list-style-type: none">• Dynamic / Standard / Movie / Live / Calibration  This function may not be supported depending on the model.
LED Brightness		Adjust the brightness of the LED Screen.  Lowering the brightness of the LED screen reduces power consumption.
Backlight / Contrast / Sharpness		Your product has several options for adjusting picture quality.  You can adjust and store settings for each external device you have connected to an input on the product.  Lowering picture brightness reduces power consumption.  Backlight : This function may not be supported depending on the model.
Colour Temperature		It sets colour temperature. The value and temperature increase simultaneously, so the ratio of blue colour rises. (Range: 2800K–10000K)  Enabled when Colour Tone is set to Off .  Available only when Picture Mode is set to Calibration .

2nd	3rd	Description
Advanced Settings		Configure advanced picture settings to create your preferred picture.
	Picture Enhancer	Displays enhanced colour and sharpness.
	Colour	Adjust the colour saturation levels. Colour saturation intensifies as the value nears 100. (Range: 0~100)
	Tint (G/R)	Adjust the ratio of green to red tint levels. Increasing values intensifies the saturation of red and green colours. (Range: 0~50)
	White Balance	<p>Adjust the colour temperature of the picture so that white objects appear brighter.</p> <p> This function may not be supported depending on the model.</p> <ul style="list-style-type: none"> • 2 Point Adjust red, green, and blue luminosity levels in two sections for precise white balance optimisation. • 20 Point Settings Controls the white balance in 20 point interval by adjusting the red, green, and blue brightness. <ul style="list-style-type: none"> – 20 Point Adjust red, green, and blue luminosity levels in twenty sections for precise white balance optimisation. <p> Some external devices may not support this function.</p>

2nd	3rd	Description
Advanced Settings	Gamma	<p>Adjust the mid-range brightness of the picture.</p> <ul style="list-style-type: none"> HLG / ST.2084 / BT.1886 / 2.2 / DICOM Adjust the HLG, ST.2084, BT.1886, 2.2, DICOM levels of the picture.  DICOM: This function may not be supported depending on the model.  Available functions may differ depending on the port type.
	Contrast Enhancer	Automatically balance the contrast to prevent excessive differences between bright and dark areas.
	Black Tone	Select the black level to adjust the screen depth.
	Flesh Tone	<p>Adjust the flesh tone colour by increasing or decreasing red levels.</p> <p> This function may not be supported depending on the model.</p>
	RGB Only Mode	<p>Fine-tune the saturation and tint of the red, green, and blue colour channels.</p> <p> This function may not be supported depending on the model.</p>
	Colour Space Settings	<p>Configure colour space settings to refine the spectrum of colours on your screen.</p> <ul style="list-style-type: none"> Colour Space Choose a colour space.  To adjust Colour, Red, Green, Blue and Reset, set Colour Space to Custom.

2nd	3rd	Description
Advanced Settings	Input Signal Plus	<p>Expands the input signal range for HDMI connections.</p> <ul style="list-style-type: none">  To use a resolution of 3840 x 2160 @ 60 Hz, set Input Signal Plus to On.  This function may not be supported depending on the model.  Connecting parts may differ depending on the model.
LED Picture Size		Choose size and aspect ratio picture displayed on screen.
	Output Resolution	<p>Provides optimised pictures according to the LED screen resolution.</p> <ul style="list-style-type: none"> • UHD • FHD
	LED Picture Size	<p>Choose size and aspect ratio picture displayed on screen.</p> <p>To manually adjust the LED picture size, select Custom.</p> <ul style="list-style-type: none"> • Original Display images in the original picture quality.

2nd	3rd	Description
-----	-----	-------------





LED Picture Size

LED Picture Size





- **Custom**
Changes the resolution to suit the user's preferences.
- **Resolution**
Set the width and height of the LED picture. (Max: 3840 x 2160)

Output Resolution	Width x Height	
	Max	Min
UHD	3840 x 2160	126 x 42
FHD	1920 x 1080	126 x 42

 Available only when **LED Picture Size** is set to **Custom**.

- **Screen Position**
To rearrange split screens, adjust the number for each product in the matrix using the **Screen Position** feature. Selecting **Screen Position** will display the videowall matrix with the numbers assigned to the products that form the videowall.
To rearrange products, use the direction buttons on the remote control to move a product to another desired number. Press the  button.
-  **Screen Position** allows you to split the screen into a maximum of 225 views (15 x 15).
-  The **Screen Position** option is only enabled when **Video Wall** is set to **On**.
-  To use the function, make sure **Horizontal x Vertical** is configured.
- **Fit to Screen**
Adjusts the picture position. When selected, the full programme image will be displayed. No part of the image will be cut off.

2nd	3rd	Description
LED HDR		<p>Set options to provide an optimal HDR effect.</p> <p>To prevent this, set the sub functions of LED HDR to Off.</p> <p> SBB-CS4B model only</p>
	Inverse Tone Mapping	Make the dark elements of the image darker and the bright elements brighter to make the image as realistic as possible.
	Dynamic Peaking	<p>Enlarge the difference of instantaneous maximum/minimum luminance so that the bright parts can be expressed more clearly.</p> <ul style="list-style-type: none"> • Off / Low / Medium / High
	Multi-link HDR Settings	<p>Set the options to provide an HDR effect when the resolution is higher than 4K.</p> <ul style="list-style-type: none"> • Multi-link HDR: Turn on to provide an HDR effect for all connected devices when the resolution is higher than 4K. • Number of Devices: Select the number of linked devices. • Device ID: Select the ID of this device.

2nd	3rd	Description
Picture Options	Colour Tone	<p>Select the colour tone that best suits your viewing preferences.</p> <ul style="list-style-type: none">  Settings can be adjusted and stored for each external device connected to an input on the product.  Available options may vary depending on the product.
	Digital Clean View	<p>Reduce picture noise to avoid distractions such as flickering.</p> <ul style="list-style-type: none">  This function may not be supported depending on the model.
	HDMI Black Level	<p>Adjust the black level to optimise the HDMI picture brightness and contrast.</p>
	Film Mode	<p>Make frame transitions from older video sources smoother. This function is only available when the input signal is TV, AV, Component (480i, 1080i), or HDMI (1080i).</p> <ul style="list-style-type: none">  This function may not be supported depending on the model.
	Auto Motion Plus Settings	<p>Enhance picture sharpness to optimise for fast-moving images.</p> <ul style="list-style-type: none">  This function may not be supported depending on the model. <ul style="list-style-type: none"> • Auto Motion Plus Removes blur and judder from scenes with larger amounts of rapid movement to provide a clearer picture. The menu names may vary depending on the country.
Apply Picture Settings	<p>Apply the picture settings to all external devices connected to the device or to the current source only.</p>	
Reset Picture	<p>Restore all picture settings to the factory default.</p>	

OnScreen Display

2nd	3rd	Description
Display Orientation	Onscreen Menu Orientation	Select in landscape or portrait mode.
	Source Content Orientation	Select in landscape or portrait mode.
Screen Protection	Screen Saver	Activate a screensaver when your device displays a still image for two hours or more.
Message Display	Source Info	Select whether to display the source OSD when the input source changes.
	No Signal Message	Select whether to display the no-signal OSD when no signal is detected. The message No Cable Connected will appear if no source device is connected.
	MDC Message	Select whether to display the MDC OSD when the product is controlled by the MDC.
Language		Set the menu language.  A change to the language setting will only be applied to the onscreen menu display. It will not be applied to other functions on your PC.
Reset OnScreen Display		This option returns the current settings under OnScreen Display to the default factory settings.

Network

2nd	3rd	Description
Network Status		You can check the current network and Internet status.
Open Network Settings		Configure network settings to connect to an available network.
	Network Type	You can check the current network and Internet status.  Network Type menu may not be available in Wired models.

Network Settings (Wired)

Connecting to a Wired Network

There are three ways to attach your product to your LAN using cable.

- You can attach your product to your LAN by connecting the LAN port on the back of your product to an external modem using a LAN cable. See the diagram below.

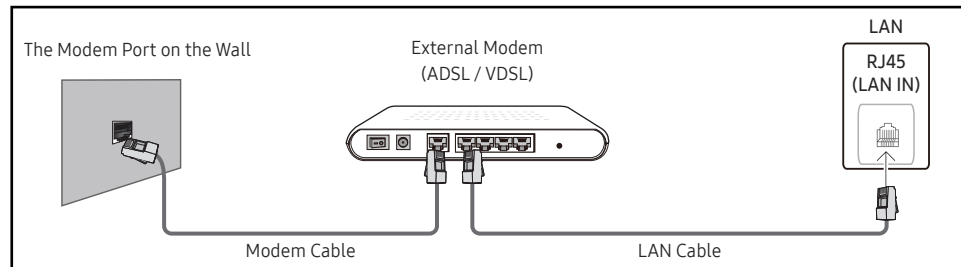

- You can attach your product to your LAN by connecting the LAN port on the back of your product to an IP Sharer which is connected to an external modem. Use LAN cable for the connection. See the diagram below.

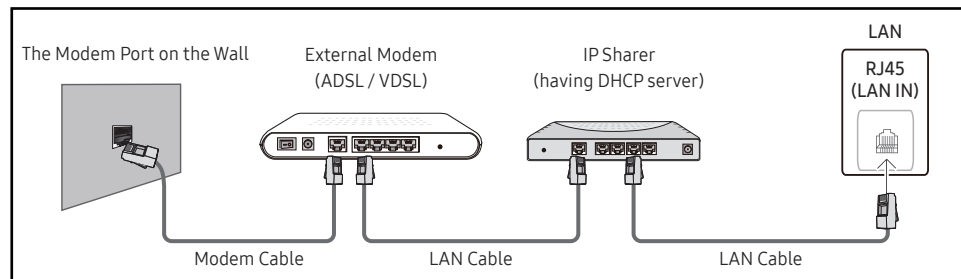

- Depending on how your network is configured, you may be able to attach your product to your LAN by connecting the LAN port on the back of your product directly to a network wall outlet using a LAN cable. See the diagram below. Note that the wall outlet is attached to a modem or router elsewhere in your house.

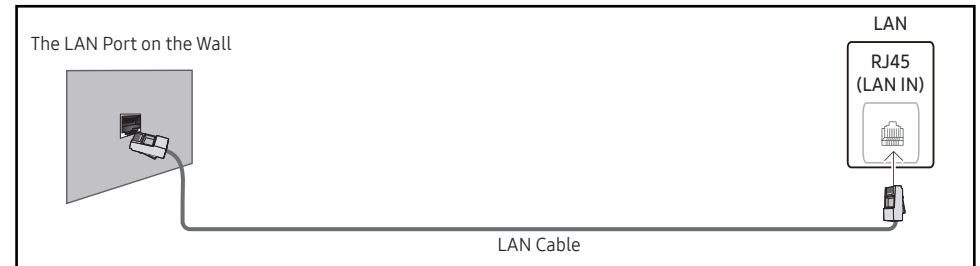

If you have a Dynamic Network, you should use an ADSL modem or router that supports the Dynamic Host Configuration Protocol (DHCP). Modems and routers that support DHCP automatically provide the **IP Address**, **Subnet Mask**, **Gateway**, and DNS values your product needs to access the Internet so you do not have to enter them manually. Most home networks are Dynamic Networks.

Some networks require a Static IP address. If your network requires a Static IP address, you must enter the **IP Address**, **Subnet Mask**, **Gateway**, and DNS values manually on your product **IP Settings** when you set up the network connection. To get the **IP Address**, **Subnet Mask**, **Gateway**, and DNS values, contact your Internet Service Provider (ISP).

If you have a Windows computer, you can also get these values through your computer.

- 🔧 You can use ADSL modems that support DHCP if your network requires a Static IP address.
- 🔧 ADSL modems that support DHCP also let you use Static IP addresses.

Set the network connection to use Internet services such as perform software upgrades.

Automatic Open Network Settings (Wired)

Connect to the network using a LAN cable.

Make sure a LAN cable is connected first.

How to set up automatically

- 1 Set **Network Type** to **Wired** from the **Open Network Settings** page.

 For wired models, select **Network Status** menu.

- 2 The network test screen appears and verifies the network connection.

When the connection has been verified, the **“Success! Your device is connected to the Internet. If you have any problems using online services, please contact your Internet service provider.”** message appears.

 If the connection process fails, check the LAN port connection.

 If the automatic process cannot find the network connection values or if you want to set the connection manually, go to the next section(Manual Open Network Settings (Wired)).

Manual Open Network Settings (Wired)

Offices may use static IP addresses.

If this is the case, ask the network administrator for the **IP Address**, **Subnet Mask**, **Gateway** and DNS server address. Enter these values manually.

Getting the Network Connection Values

To view the Network connection values on most Windows computers, follow these steps.

- 1 Right click the Network icon on the bottom right of the screen.
- 2 In the pop-up menu that appears, click Status.
- 3 On the dialog that appears, click the **Support** tab.
- 4 On the **Support** Tab, click the **Details** button. The Network connection values are displayed.

 The path to the settings depends on the installed OS.

How to set up manually

- 1 Set **Network Type** to **Wired** from the **Open Network Settings** page.

The network test screen appears and the verification process starts. Press **Cancel**. The verification process stops.

 For wired models, select **Network Status** menu.







- 2 Select **IP Settings** on network connection screen. The **IP Settings** screen appears.

- 3 Select the field at the top, press , and then set **IP setting** to **Enter manually**. Repeat the entry process for each field in the **IP Address**.





 Setting **IP setting** to **Enter manually** automatically changes **DNS setting** to **Enter manually**.







- 4 When done, select **OK** at the bottom of the page, and then press . The network test screen appears and the verification process starts.









- 5 When the connection has been verified, the **“Success! Your device is connected to the Internet. If you have any problems using online services, please contact your Internet service provider.”** message appears.



2nd	3rd	Description
Server Network Settings	Connect to server	<p>Connect to MagicInfo server.</p> <ul style="list-style-type: none">  This function may not be supported depending on the model.  If you do use the TLS option, the server is configured to use https and data transfer is encrypted. (Port number: 7002)  If you don't use the TLS option, enter the server IP address and port number. Use 7001 as the port number. (If you are unable to connect to the server using port number 7001, check with your server administrator to find the correct port number and then change the port number.)  Enter the server IP address and port number. Use 7001 as the port number. (If unable to connect to the server using port number 7001, check with your server administrator to find the correct port number and then change the port number.)  For the MagicInfo Server user guide, visit the following website: http://displaysolutions.samsung.com → Support → Resources → MagicInfo Web Manual.
	Verify MagicINFO Server	Enable this option to block HTTPS communication if the domain name of the MagicINFO Server URL is different from the domain name of the MagicINFO Server certificate.
	MagicInfo Mode	<p>Select the appropriate MagicInfo Mode depending on the environment where you are using the product.</p> <ul style="list-style-type: none">  This function may not be supported depending on the model.
	Server Access	Allow or deny access to MagicInfo server.
	FTP Mode	Specify the FTP operating mode.
	Proxy server	<p>Set up your proxy server connection and related functions.</p> <ul style="list-style-type: none">  Address / Port / ID and Password are enabled only when Proxy server is set to On.
Embedded Server Settings	Embedded Server	Turn on to enable the embedded server. Turn off to delete registered server information.
	Server Mode	To use this device as a local web server, set it to 'Server'. If you already have a server device nearby, set it as 'Client' to connect this device to the server.
Device Name		Select or enter a device name.
		This name can be shown on network device over the network.



System









2nd	3rd	Description
Accessibility	Voice Guide Settings	<p> This function may not be supported depending on the model.</p> <ul style="list-style-type: none">Voice Guide Switch Voice Guide on or off. The language used for Voice Guide will be the same as the current menu language.<ul style="list-style-type: none"> Volume, Speed and Pitch are enabled only when Voice Guide is set to On. This function may not be supported depending on the model.Volume Set the volume level for the Voice Guide.Speed Set the speed of the Voice Guide.Pitch Tune the pitch of the Voice Guide.Background Sound Volume Adjust background sound volume during voice guidance.
	High Contrast	Set the background and font to high-contrast colours in Menu. Menu transparencies become opaque when the option is selected.
	Enlarge	Enlarge the size of the Menu area.
Start Setup		<p>Go through the initial setup steps like you did the first time you used this product.</p> <ul style="list-style-type: none"> Enter your 6 digit PIN number. The default PIN number is "0-0-0-0-0-0". If you want to change the PIN number, use the Change PIN function. Change the PIN to keep your device secure.







2nd	3rd	Description
Time		You can configure Clock Set or DST . Configure various time-related settings.
	Clock Set	Select Clock Set . Select Date or Time , and then press  Use the number buttons to enter numbers or press the up and down arrow buttons. Use the left and right arrow buttons to move from one entry field to the next. Press  when done.  You can set the Date and Time directly by pressing the number buttons on the remote control.
	NTP Settings	Set up the server URL and time zone to use the network time.
	DST	Switches the DST (Daylight Saving Time) function on or off.  Start Date , End Date and Time Offset are enabled only when DST is set to On .
	Power On Delay	When connecting multiple products, adjust the power-on time for each product to prevent power overload (within the range 0–50 seconds).
Auto Source Switching	Auto Source Switching	Switch to preset source or another source when the main source device gets disconnected.
	Primary Source Recovery	Select whether to restore the selected primary input source when a primary input source is activated.  The Primary Source Recovery function is disabled if Primary Source is set to All .
	Primary Source	Select a primary source to switch to when no signals are received from the current input.
	Secondary Source	Select a secondary source to switch to when no signals are received from the current input.  The Secondary Source function is disabled if Primary Source is set to All .
	Default Input	Select the default input to switch to when the new input is disconnected. The Last Input option only includes external inputs connected via cables.  Auto Source Switching must be set to New Input to enable the Default Input option.

2nd	3rd	Description
Power Control	Auto Power On	This feature automatically turns on the product as soon as it is plugged in. Pressing the power button is not needed.
	Remote Configuration	Keep the network connection active when the product is turned off.
	Power Button	The power button on the remote control  can be set to turn on the power or turn on or off the power.
Power and Energy Saving	Brightness Optimization	<p>Automatically adjust the picture brightness based on the ambient light level.</p> <ul style="list-style-type: none">  This function may not be supported depending on the model.  If the screen contrast is not sufficient, set the Brightness Optimization to Off.  If the Brightness Optimization is Off, it may not comply with energy standards. <ul style="list-style-type: none"> • Minimum Brightness Set the minimum brightness for the signage screen. This function only works if its value is lower than the value set in the Picture menu's Backlight setting.  If Brightness Optimization is On, the display brightness may change (become slightly darker or brighter) depending on the surrounding light intensity.  Available only when Brightness Optimization is set to On.
	No Signal Power Off	<p>Save power by turning the product off when no signal is received from any source.</p> <ul style="list-style-type: none">  This function may not be supported depending on the model.  This function does not operate if the display is in the standby mode.  The product will automatically power off at a specified time. The time can be changed as required.
	Auto Power Off	Choose how long the display will wait before turning off after no user interaction is detected.
Fan Control		Set the speed adjustment mode of the fan inside the product.

2nd	3rd	Description
External Device Manager		Manage external devices connected to your signage.  This function may not be supported depending on the model.
	Input Device Manager	Set up keyboards to use with your product. You can add keyboards and configure their setting.  Available for Bluetooth enabled models only. <ul style="list-style-type: none"> • Bluetooth Device List Connect a Bluetooth keyboard, mouse or gamepad to your product. • Keyboard Settings Configure the connected keyboard settings. <ul style="list-style-type: none"> – Keyboard Language Set the language of your keyboard. – Keyboard type Set the type of your keyboard. • Mouse Settings Configure the connected mouse settings. <ul style="list-style-type: none"> – Primary Button Select the button you want to use as the primary button to click and select. – Pointer Speed Set the speed of the mouse pointer.







2nd	3rd	Description
Play via		<p>Select the appropriate Play via mode depending on the environment where you are using the product.</p> <p>The home screen may be different depending on the setting.</p> <p> This function may not be supported depending on the model.</p>
Change PIN		<p>Change your 6-digit Personal Identification Number (PIN).</p> <p>Choose any 6 digits for your PIN and enter it in Enter a new PIN.. Reenter the same 6 digits in Enter the PIN again..</p> <p>The product has memorised your new PIN.</p> <p> The default PIN number is "0-0-0-0-0-0".</p> <p> Change the PIN to keep your device secure.</p>







2nd	3rd	Description
Security		<p> Enter your 6 digit PIN number. The default PIN number is "0-0-0-0-0-0". If you want to change the PIN number, use the Change PIN function.</p> <p> Change the PIN to keep your device secure.</p>
	Safety Lock On	<p>Turn Safety Lock On on or off. Safety Lock On restricts the actions that can be carried out by the remote control. The correct PIN must be entered to turn Safety Lock On off.</p> <ul style="list-style-type: none"> • Power On Button Turn on this feature to enable the remote control's Power button to turn on the product while Safety Lock On is enabled.
	Button Lock	<p>This menu can be used to lock the buttons on the product.</p> <p>Only the remote control can control the product if Button Lock is set to On.</p> <p> This function may not be supported depending on the model.</p>
	Screen Monitoring Lock	<p>Blocks screen images from being monitored by MagicINFO Server.</p>
	USB Auto Play Lock	<p>Select whether to automatically play MagicInfo content saved on a connected USB device.</p> <p> Your content should be a Published Content  that is authored by using MagicInfo Premium application and published to the USB device you are using. The MagicInfo Premium application programme is available on the website. (http://displaysolutions.samsung.com)</p> <p> When published to a USB device, your Published Content  is saved to Contents and Schedules folders in the root folder of the connected USB device.</p> <p> Connecting a USB device containing MagicInfo content displays "USB Auto Play Lock : On" for five seconds.</p>

2nd	3rd	Description
Security	Remote Management	You can Allow or Deny external commands to access your product via a network.
	Secured Protocol	Secure the protocol between this device and other devices.
	Server Security Status	You can view the MagicINFO server information.
	Network Lock	Block external network access. You can register networks on the server to allow access.
	USB Lock	Block connection to external USB ports.
	Certificate Manager	<p>Manage the certificates installed on this device.</p> <ul style="list-style-type: none">  Limited supports for Enterprise WPA2 (TLS/TTLS/PEAP) certified models only.  This function may not be supported depending on the model. • App Certificate View and manage the app certificates installed on this device. Connect a USB flash drive that contains certificates to install them on this device. • Wi-Fi Certificate View and manage the Wi-Fi certificates Certificates installed on this device.  This function may not be supported depending on the model.
General	Anynet+ (HDMI-CEC)	<p>Anynet+ is a function that enables you to control all connected Samsung devices that support Anynet+ with your Samsung product remote control. The Anynet+ system can be used only with Samsung devices that have the Anynet+ feature. To be sure your Samsung device has this feature, check if there is an Anynet+ logo on it.</p> <ul style="list-style-type: none">  You can only control Anynet+ devices using the product remote control, not the buttons on the product.  The product remote control may not work under certain conditions. If this occurs, reselect the Anynet+ device.  Anynet+ works when the AV device supporting Anynet+ is in the standby or on status.  Anynet+ supports up to 12 AV devices in total. Note that you can connect up to 3 devices of the same type.

Troubleshooting for Anynet+

Problem	Possible Solution
Anynet+ does not work.	<ul style="list-style-type: none"> • Check if the device is an Anynet+ device. The Anynet+ system supports Anynet+ devices only. • Check if the Anynet+ device power cord is properly connected. • Check the Anynet+ device's Video/Audio/HDMI cable connections. • Check whether Anynet+ (HDMI-CEC) is set to On in the System menu. • Check whether the remote control is Anynet+ compatible. • Anynet+ doesn't work in certain situations. (initial setup) • If you have removed and then reconnected the HDMI cable, please make sure to search devices again or turn your product off and on again. • Check if the Anynet+ function of the Anynet device is set on.
I want to start Anynet+.	<ul style="list-style-type: none"> • Check if the Anynet+ device is properly connected to the product and check if the Anynet+ (HDMI-CEC) is set to On in the System menu.
I want to exit Anynet+.	<ul style="list-style-type: none"> • Press the SOURCE button on the product remote control and select a non- Anynet+ device.
The message " Disconnecting Anynet+ device ... " appears on the screen.	<ul style="list-style-type: none"> • You cannot use the remote control when you are configuring Anynet+ or switching to a view mode. • Use the remote control after the product has completed Anynet+ configuration or has finished switching to Anynet+.
The Anynet+ device does not play.	<ul style="list-style-type: none"> • You cannot use the play function when initial setup is in progress.
The connected device is not displayed.	<ul style="list-style-type: none"> • Check whether or not the device supports Anynet+ functions. • Check whether or not the HDMI cable is properly connected. • Check whether Anynet+ (HDMI-CEC) is set to On in the System menu. • Search Anynet+ devices again. • Anynet+ requires an HDMI connection. Make sure the device is connected to your product with an HDMI cable. • Some HDMI cables may not support Anynet+ functions. • If the connection is terminated because there has been a power failure or the HDMI cable has been disconnected, please repeat the device scan.

2nd	3rd	Description
General	HDMI Hot Plug	This feature is used to activate the time delay to turn on a HDMI source device.
	Custom Logo	<p>You can download, select, and set the display time of a custom logo that appears when the product turns on.</p> <ul style="list-style-type: none"> Custom Logo <ul style="list-style-type: none">  You can select a custom logo (image/video) or turn off the custom logo display.  You must download the custom logo from an external USB device to set the custom logo. Logo Display Time <ul style="list-style-type: none">  If the type of custom logo is Image, you can set the Logo Display Time. Download Logo File <ul style="list-style-type: none">  You can download a custom logo into the product from an external USB device.  The file name of the custom logo you want to download must be saved as “samsung” in all small letters.  When there are multiple numbers of external USB connections, the product will attempt to download the custom logo from the last device that has been connected to the product. <div style="border: 1px solid black; padding: 5px; margin-top: 10px;"> <p>Custom logo file restrictions</p> <ul style="list-style-type: none"> Images up to 50 MB in size can be used. <ul style="list-style-type: none"> Supported image file: samsung_image.* Supported file extensions: jpg, jpeg, bmp, png Videos up to 150 MB in size can be used. The recommendation is under 20 seconds in length. <ul style="list-style-type: none"> Supported video file: samsung_video.* Supported file extensions: avi, mpg, mpeg, mp4, ts, wmv, asf </div>

2nd	3rd	Description
General	DICOM Simulation Mode	Adjust the display mode to output a picture close to the GSDF standard of DICOM Part 14.  This device cannot be used as a medical diagnostic device, even if the DICOM Simulation Mode is enabled.  This function may not be supported depending on the model.
	Director Mode	Minimises image processing to display the movie director's original intention on screen.  This function may not be supported depending on the model.
	Adaptive Picture	Optimises brightness and provides the best picture quality in real time, based on the light level of the surrounding environment. When this function is on, some picture settings are not supported.  This function may not be supported depending on the model.
	Empty Storage	Delete files to make space for new content. Recently played files will not be deleted.
	Audio Delay	Adjust the delay time between the audio and video tracks. (Range: 0~250)  This function may not be supported depending on the model.
	Digital Output Audio Format	Select the digital audio output format.  This function may not be supported depending on the model.
Reset System		Reset all system settings to default.

Support

2nd	3rd	Description
Software Update		<p>The Software Update menu lets you upgrade your product software to the latest version.</p> <ul style="list-style-type: none">✎ Be careful not to turn off the power until the upgrade is complete. The product will turn off and on automatically after completing the software upgrade.✎ When you upgrade software, all video and audio settings you have made will return to their default settings. We advise you to write down your settings so that you can easily reset them after the upgrade.
	Update Now	<p>Update the software to the latest version.</p> <ul style="list-style-type: none">✎ Current version: This is the software version already installed in the product.
Contact Samsung		<p>You can view the address of the Samsung website, the call centre phone number, your product's model number, software version, Open Source Licence and other information.</p> <ul style="list-style-type: none">✎ Go to Contact Samsung and find the product Model Code and Software Version.
Terms & Privacy		<p>View and set the privacy policy for MagicInfo and other services.</p> <ul style="list-style-type: none">✎ Make sure that the product is connected to the network.✎ Menu items may vary depending on the model.✎ The availability may vary depending on the region.
Device Care		<p>Optimize and diagnose the condition of your Signage. You can check and clean your storage space, diagnose problems or request technical support.</p>
Reset All		<p>This option returns all the current settings for a display to the default factory settings.</p>

Chapter 07

Troubleshooting Guide

 Before calling Samsung Customer Service Centre, test your product as follows. If the problem persists, contact Samsung Customer Service Centre.

Requirements Before Contacting Samsung Customer Service Centre

Testing the Product

Check if your product is operating normally by using the product test function.

If the screen remains blank while the power indicator blinks even when the product is correctly connected to a PC, perform product testing.

- 1 Power off both the PC and product.
- 2 Disconnect all the cables from the product.
- 3 Power on the product.
- 4 If **No Signal** is displayed, the product is operating normally.

If the screen remains blank, check the PC system, video controller and cable.

Checking the Resolution and Frequency

For modes that exceed the supported resolutions, the message "**Not Optimum Mode**" appears briefly.

Set the PC resolution by referring to [Preset Timing Modes](#).

Check the followings.

Installation issue (PC mode)	
The screen keeps switching on and off.	Check that the cable between the product and the PC is connected correctly.
Blank spaces are found on all four sides of the screen when a DP, an HDMI, or an HDMI-DVI cable is connected between the product and PC.	The blank spaces found on the screen have nothing to do with the product.
	Blank spaces on the screen are caused by the PC or graphics card. To resolve the problem, adjust the screen size in the HDMI or DVI settings for the graphics card.
	If the graphics card settings menu does not have an option to adjust the screen size, update the graphics card driver to the latest version. (Please contact the graphics card or computer manufacturer for further details about how to adjust the screen settings.)
Screen issue	
The power indicator is off. The screen will not switch on.	Make sure that the power cord is connected.
Cable not connected or device power confirmation message appear on the screen.	Check that the product is connected correctly with a cable.
	Check that the source device connected to the product is powered on.
No cable signal or device power confirmation message appear on the screen.	When using a USB Type C adapter, a gender that supports HDMI 2.0 (DP1.2 or higher) is recommended. If the message is displayed on the screen, please check by disconnecting the gender from the source device and connecting it. If the problem persists, contact the gender producer.
	For resolutions included in Preset Timing Modes Table, select ⏏ MENU → Picture → Advanced Settings → Input Signal Plus to check the corresponding port is enabled.
The images on the screen look distorted.	Check the cable connection to the product.
The screen is not clear. The screen is blurry.	Set the resolution and frequency to the recommended level.

Screen issue	
The screen appears unstable and shaky.	Check that the resolution and frequency of the PC and graphics card are set within a range compatible with the product. Then, change the screen settings if required by referring to 'Preset Timing Modes'.
There are shadows or ghost images left on the screen.	
The screen is too bright. The screen is too dark.	Go to Picture and adjust the Brightness and Contrast settings.
Screen colour is inconsistent.	Go to Picture and adjust the Colour Space settings.
White does not really look white.	Go to Picture and adjust the White Balance settings.
There is no image on the screen and the power indicator blinks every 0.5 to 1 second.	The status of product is in power-saving mode.
	Press any key on the keyboard or move the mouse to return to the previous screen.
The product will turn off automatically.	If a PC is connected to the product, check the power status of the PC.
	Make sure the power cable is connected properly to the product and power outlet.
	If the signal from a connected device is not detected, the product automatically turns off after 10 to 15 minutes.
The screen display does not look normal.	Encoded video content may cause the display to appear corrupted in scenes featuring fast moving objects such as in a sports event or action video.
	Low signal level or low picture quality may cause the display to appear corrupted. This does not mean the product is defective.
	A cell phone within a distance of one-meter radius may cause static on analogue and digital products.

Screen issue	
The brightness and colour do not look normal.	Go to Picture and adjust the screen settings such as Picture Mode , Colour , Brightness and Sharpness .
	Reset the screen settings to the default settings. (P.55)
I see red, green, and blue.	Check the cable connections.
	This issue may happen when the panel of the product is defective. Contact a Samsung Service Centre to resolve the issue.
The display looks unstable and then freezes.	The screen may freeze when a resolution other than the recommended resolution is used or if the signal is not stable. To resolve the issue, change the PC resolution to the recommended resolution.
The screen cannot be displayed in full screen.	A scaled SD (4:3) content file can cause black bars on both sides of an HD channel screen.
	A video with an aspect ratio different from the product can cause a black bar to appear at the top and bottom of the screen.
	Change the screen size setting to full screen on the product or source device.
The cabinet screen blinks.	Check the LAN cable connected to the device.
	Check that the LAN cable is correctly connected to the device.
	Check that there is no foreign material found in the LAN port on the device.
Remote control issue	
The remote control does not work.	Make sure that the batteries are correctly in place (+/-).
	Check if the batteries are flat.
	Check for power failure.
	Make sure that the power cord is connected.
	Check for any special lighting or neon signs switched on in the vicinity.

Source device issue	
A beeping sound is heard when my PC is booting.	If a beeping sound is heard when your PC is booting, have your PC serviced.
Other issue	
The product smells like plastic.	The plastic smell is normal and disappears over time.
Video playback is choppy.	Check the cable connection and connect it again if required.
	Use a standard cable.
Small particles are found on the edges of the product.	The particles are part of the product design. The product is not defective.
When I try to change the PC resolution, a message "The defined resolution is not supported." appears.	The message "The defined resolution is not supported." appears if the input source resolution exceeds the maximum resolution of the display. To resolve the issue, change the PC resolution to a resolution supported on the display.
HDMI Black Level is not functioning properly on an external device with HDMI YCbCr output.	This function is available only when a source device with RGB signal, such as a DVD player and STB, is connected to the product to HDMI cable.
The IR sensor is not functioning.	Press a button on the remote control and check that the power indicator blinks.
	<ul style="list-style-type: none"> If the power indicator does not blink, check the connection between the external IR cable and the device, and turn off and then on the power switch of the device. If the power indicator does not blink although the cable is connected correctly and the power switch has been turned off and then on again, contact the nearest service centre.
When booting the PC with the input source set to DisplayPort, the BIOS and booting screens do not appear.	Boot the PC when the product is turned on or when the input source is not DisplayPort.

Chapter 08

Specifications

General

Model Name	SBB-CX4B	SBB-CV4B	SBB-CS4B
Power Supply	AC100-240V~ 50/60Hz * Based on the AC voltage of the adapter. For the DC voltage of the product, refer to the product label.		
Environmental considerations	Operating	Temperature: 0 °C to 40 °C (32 °F to 104 °F) Humidity: 10% to 80%, non-condensing	
	Storage	Temperature: -20 °C to 45 °C (-4 °F to 113 °F) Humidity: 5% to 95%, non-condensing * Applicable before the product package is unpacked.	

- Plug-and-Play
This monitor can be installed and used with any Plug-and-Play compatible systems. Two-way data exchange between the monitor and PC system optimises the monitor settings. Monitor installation takes place automatically. However, you can customise the installation settings if desired.
- For detailed device specifications, visit the Samsung website.
- Update the software to the latest version.



Preset Timing Modes

Horizontal Frequency

The time required to scan a single line from the left to the right side of the screen is called a horizontal cycle. The reciprocal number of a horizontal cycle is called horizontal frequency. Horizontal frequency is measured in kHz.

Vertical Frequency

The product displays a single image multiple times per second (like a fluorescent light) to display what the viewer sees. The rate of a single image being displayed repeatedly per second is called vertical frequency or refresh rate. Vertical frequency is measured in Hz.

-  This product can be set to only one resolution for each screen size to obtain the optimum picture quality due to the nature of the panel. Using a resolution other than the specified resolution may degrade the picture quality. To avoid this, it is recommended that you select the optimum resolution specified for your product.
-  To use a resolution of 3840 x 2160 @ 60 Hz, set **Input Signal Plus** to **On**.

Model Name		SBB-CX4B / SBB-CV4B / SBB-CS4B
Synchronization	Horizontal Frequency	15 ~ 135 kHz
	Vertical Frequency	24 ~ 75 Hz

The screen will automatically be adjusted if a signal that belongs to the following standard signal modes is transmitted from your PC. If the signal transmitted from the PC does not belong to the standard signal modes, the screen may be blank with the power indicator on. In such a case, change the settings according to the following table by referring to the graphics card user manual.

Resolution	Horizontal Frequency (kHz)	Vertical Frequency (Hz)	Pixel Clock (MHz)	Sync Polarity (H/V)	HDMI1~2	DP	SDI (SBB-CV4B model only)	S-Box Grouping Supported
IBM/VESA, 640 x 480	31.469	59.940	21.175	N / N	0	0	X	-
Mac, 640 x 480	35.000	66.667	30.240	N / N	0	0	X	-
VESA 640 x 480	37.861	72.809	31.500	N / N	0	0	X	-
VESA, 640 x 480	37.500	75.000	31.500	N / N	0	0	X	-
IBM, 720 x 400	31.469	70.087	28.322	N / P	0	0	X	-
VESA, 800 x 600	37.879	60.317	40.000	P / P	0	0	X	-
VESA, 800 x 600	48.077	72.188	50.000	P / P	0	0	X	-
VESA, 800 x 600	46.875	75.000	49.500	P / P	0	0	X	-
Mac, 832 x 624	49.726	74.551	57.284	N / N	0	0	X	-
VESA, 1024 x 768	48.363	60.004	65.000	N / N	0	0	X	0

Resolution	Horizontal Frequency (kHz)	Vertical Frequency (Hz)	Pixel Clock (MHz)	Sync Polarity (H/V)	HDMI 1~2	DP	SDI (SBB-CV4B model only)	S-Box Grouping Supported
VESA, 1024 x 768	56.476	70.069	75.000	N / N	0	0	X	-
VESA, 1024 x 768	60.023	75.029	78.750	P / P	0	0	X	-
VESA, 1152 x 864	67.500	75.000	108.000	P / P	0	0	X	-
VESA, 1280 x 720	45.000	60.000	74.250	P / P	0	0	0	0
VESA, 1280 x 800	49.702	59.810	83.500	N / P	0	0	X	-
VESA, 1280 x 1024	63.981	60.020	108.000	P / P	0	0	X	0
VESA, 1280 x 1024	79.976	75.025	135.000	P / P	0	0	X	-
VESA, 1440 x 900	55.935	59.887	106.500	N / P	0	0	X	-
VESA, 1600 x 900	60.000	60.000	108.000	P / P	0	0	X	0
VESA, 1680 x 1050	65.290	59.945	146.250	N / P	0	0	X	-
VESA, 1920 x 1080	67.500	60.000	148.500	P / P	0	0	0	0
VESA, 2560 x 1440	88.787	59.951	241.500	P / N	0	0	X	-
VESA, 3840 x 2160	67.500	30.000	297.000	P / P	0	0	0	-
VESA, 3840 x 2160	133.312	59.997	533.250	P / N	0	0	X	-
CEA-861 VIC 3, 720x480	31.469	59.940	27.000	N / N	0	0	0	-
CEA-861 VIC 4, 1280x720	45.000	60.000	74.250	P / P	0	0	0	0
CEA-861 VIC 5, 1920x1080i	33.750	60.000	74.250	P / P	0	X	0	-
CEA-861 VIC 7, 720(1440)x480i	31.469	59.940	27.000	P / P	0	X	0	-
CEA-861 VIC 16, 1920 x 1080	67.500	60.000	148.500	P / P	0	0	0	0
CEA-861 VIC 18, 720x576	31.250	50.000	27.000	N / N	0	0	0	0
CEA-861 VIC 19, 1280x720	37.500	50.000	74.250	P / P	0	0	0	0

Resolution	Horizontal Frequency (kHz)	Vertical Frequency (Hz)	Pixel Clock (MHz)	Sync Polarity (H/V)	HDMI 1~2	DP	SDI (SBB-CV4B model only)	S-Box Grouping Supported
CEA-861 VIC 20, 1920x1080i	28.125	50.000	47.250	P / P	0	X	0	-
CEA-861 VIC 22, 720(1440)x576i	31.250	50.000	27.000	P / P	0	X	0	-
CEA-861 VIC 31, 1920x1080	56.250	50.000	148.500	P / P	0	0	0	0
CEA-861 VIC 32, 1920x1080	27.000	24.000	74.250	P / P	0	0	0	-
CEA-861 VIC 33, 1920x1080	28.125	25.000	74.250	P / P	0	0	0	-
CEA-861 VIC 34, 1920x1080	33.750	30.000	74.250	P / P	0	0	0	-
CEA-861 VIC 93, 3840x2160	54.000	24.000	297.000	P / P	0	0	0	-
CEA-861 VIC 94, 3840x2160	56.250	25.000	297.000	P / P	0	0	0	-
CEA-861 VIC 95, 3840x2160	67.500	30.000	297.000	P / P	0	0	0	-
CEA-861 VIC 96, 3840x2160	112.500	50.000	594.000	P / P	0	0	0	0
CEA-861 VIC 97, 3840x2160	135.000	60.000	594.000	P / P	0	0	0	0

Chapter 09

Appendix

Responsibility for the Pay Service (Cost to Customers)

 When the service is requested, in spite of in warranty, we may charge you for a visit from a service technician in the following cases.

Not a product defect

Cleaning of the product, Adjustment, Explanation, Re-installation and etc.

- If a service technician is requested to give instructions on how to use product or simply adjusts options without disassembling product.
- If a defect is caused by external environmental factors (Internet, Antenna, Wired Signal, etc.)
- If a product is reinstalled or devices are connected additionally after installing the purchased product for the first time.
- If a product is reinstalled to move to a different spot or to move to a different house.
- If customer requests instructions on how to use because of another company's product.
- If customer requests instructions on how to use the network or another company's programme.
- If customer requests software installation and setup for the product.
- If a service technician removes/cleans dusts or foreign materials inside of the product.
- If customer requests an installation additionally after purchasing a product through home-shopping or online.

A Product damage caused by customer's fault

Product damage caused by customer's mishandling or wrong repair

If a product damage is caused by;

- External impact or drop.
- Use of supplies or separately sold product unspecified by Samsung.
- Repair from a person besides an engineer of outsourcing service company or partner of Samsung Electronics Co., Ltd.
- Remodeling or repairing the product by customer.
- Using it with incorrect voltage or non-authorized electrical connections.
- Not following the "cautions" in User Manual.

Others

- If product fails by natural disaster. (lightning, fire, earthquake, flood damage, etc)
- If consumable components are all used up. (Battery, Toner, Fluorescent lights, Head, Vibrator, Lamp, Filter, Ribbon, etc.)
-  If customer requests a service in case the product has no defect, service fee may be charged. So please read User Manual first.

Licence



Dolby, Dolby Atmos, Dolby Audio and the double-D symbol are registered trademarks of Dolby Laboratories Licensing Corporation. Manufactured under license from Dolby Laboratories. Confidential unpublished works. Copyright © 2012-2021 Dolby Laboratories. All rights reserved.



The terms HDMI, HDMI High-Definition Multimedia Interface, HDMI trade dress and the HDMI Logos are trademarks or registered trademarks of HDMI Licensing Administrator, Inc.

Open Source License Notice

Open Source used in this product can be found on the following webpage (<https://opensource.samsung.com>).



THIS PRODUCT IS SOLD WITH A LIMITED LICENCE AND IS AUTHORISED TO BE USED ONLY IN CONNECTION WITH HEVC CONTENT THAT MEETS EACH OF THE THREE FOLLOWING QUALIFICATIONS: (1) HEVC CONTENT ONLY FOR PERSONAL USE; (2) HEVC CONTENT THAT IS NOT OFFERED FOR SALE; AND (3) HEVC CONTENT THAT IS CREATED BY THE OWNER OF THE PRODUCT.

THIS PRODUCT MAY NOT BE USED IN CONNECTION WITH HEVC ENCODED CONTENT CREATED BY A THIRD PARTY, WHICH THE USER HAS ORDERED OR PURCHASED FROM A THIRD PARTY, UNLESS THE USER IS SEPARATELY GRANTED RIGHTS TO USE THE PRODUCT WITH SUCH CONTENT BY A LICENSED SELLER OF THE CONTENT.

YOUR USE OF THIS PRODUCT IN CONNECTION WITH HEVC ENCODED CONTENT IS DEEMED ACCEPTANCE OF THE LIMITED AUTHORITY TO USE AS NOTED ABOVE.
