

SAMSUNG

User Guide

HW-LS60D

To receive more complete service, please register your product at www.samsung.com/register

Figures and illustrations in this User Guide are provided for reference only and may differ from actual product appearance.

CONTENTS

01	Checking the Components	3	10	Software Update	19
	Auto Update			Auto Update	19
02	Assembling Music Frame	3		USB Update	19
	Attaching the Stand	3		Reset	19
	Attaching the Photo Frame	4		Security updates information	19
	Changing the photo from the Photo Frame	4	11	Troubleshooting	20
	Inserting an Art Panel	5	12	License	21
03	Product Overview	6			
	Front	6			
	Rear	6			
04	Connecting Electrical Power	7			
05	Connecting a Mobile Device	7			
	Method 1. Connecting the SmartThings App (Wireless Network)	7			
	Using Group Play	8			
	Using the SmartThings Hub	9			
	Connecting via Apple AirPlay	9			
	Method 2. Connecting via Bluetooth	10			
	Using the Tap Sound	11			
06	Connecting to a TV	12			
	Connecting via Wi-Fi	12			
	Connecting to a TV that supports Dolby Atmos	12			
	Using the Q-Symphony Function	13			
	Connecting via Bluetooth	13			
	Connecting using an Optical Cable	14			
	Using the Spacefit sound	15			
07	Connecting an External Device	15			
	Connecting using an Optical Cable	15			
08	Additional Features	16			
	Adjusting the Wireless Speaker volume with a TV remote control	16			
	Activate/Deactivate Wi-Fi and Bluetooth	16			
09	Installing the Wall Mount	17			
	Installation Precautions	17			
	Wallmount Components	17			

01 CHECKING THE COMPONENTS

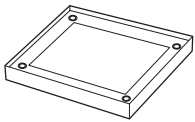

Wireless Speaker
main unit



AC/DC Adapter
(AH81-17248A)



Power Cord
(3903-001117)

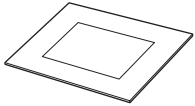
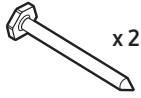

Photo Frame
(AH82-02601A)



Stand
(AH82-02603A)



Screw
(6011-008215)



Anchor
(BN61-17904A)



Holder-Screw
(AH61-03164A)

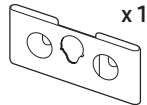

Bracket-Wall Rear
(AH61-04298A)

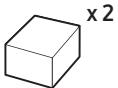

Spacer
(AH81-17402A)

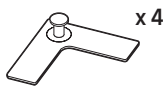

Holder-Plate
(AH61-04296A)

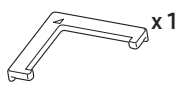

Holder-Guide
(AH61-04299A)

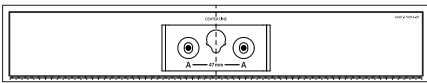

Wall Mount Guide (AH81-17401A)

- For more information about the power supply and power consumption, refer to the label attached to the product. (Label: Bottom of the Wireless Speaker Main Unit)
- To purchase additional components or optional cables, contact a Samsung Service Center or Samsung Customer Care.
- For more information about the wallmount or rubber-foot, see pages 17~18.
- Design, specifications, and App screen are subject to change without prior notice.
- The appearance of the accessories may differ slightly from the illustrations above.

02 ASSEMBLING MUSIC FRAME

Attaching the Stand

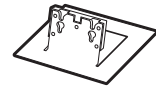
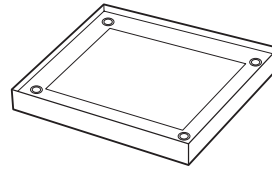

1.

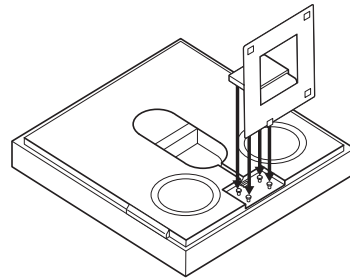

2.

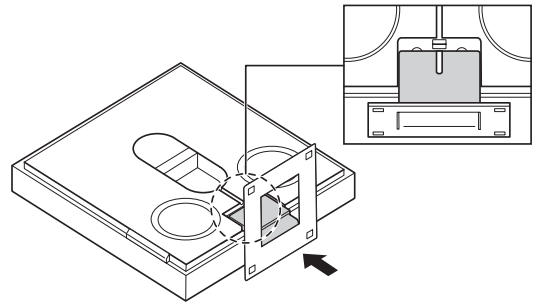

3.

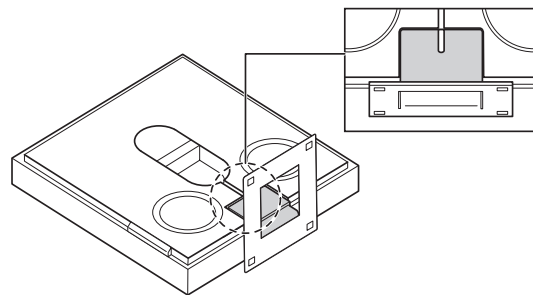

4.

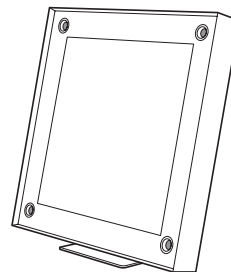

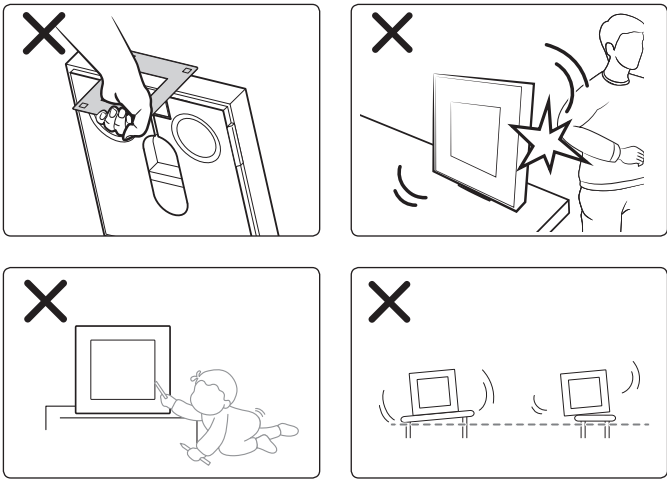

Attaching the Photo Frame

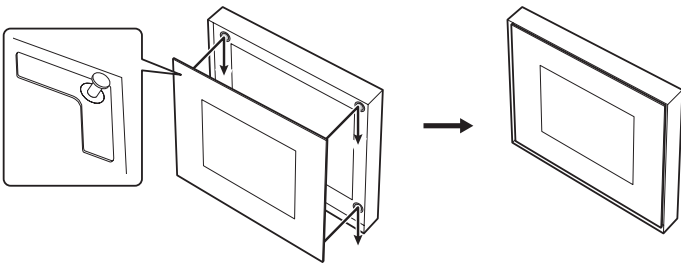

- Be sure to secure the photo frame properly. Otherwise, it may fall off and cause damage or physical injury. Any accident resulting from carelessness by the user shall not be covered by the warranty.

Detaching the Photo Frame

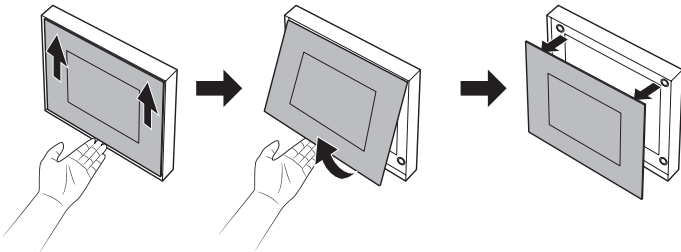

Changing the photo from the Photo Frame

You can change the picture anytime you want. (Size: 8x10 inch)

1. Press one of the marked positions with your finger to remove the cover.

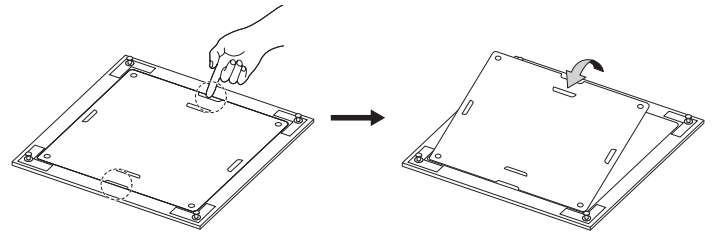

2. Slide out the old photo and insert a new one.

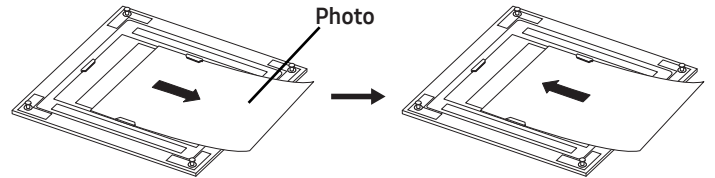

3. Close the cover and press the four locking tabs to lock.

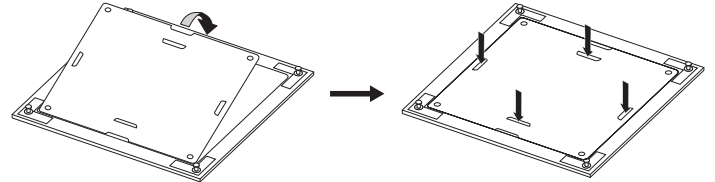

4. Push down four corners evenly.

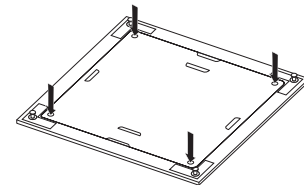

Inserting an Art Panel

You can insert an art panel (not included) into the music frame.

- panel size: 330.0 mm x 330.0 mm x 5.0 mm
- The art panel is available on the Marpple online shop (www.marpple.com/kr/x/musicframe), and the availability may differ with your region. For regional retailers, visit your local Samsung web site (www.samsung.com).
- Distribution of the art panel is performed by third-part businesses that has nothing to do with the company. And the panel's quality and safety is solely subject to the third-party businesses. Regional retailers may change depending on their business situation.

⚠ CAUTION

- Attach the plate (G) on a site without scratches or impurities. Otherwise, the plate (G) may fall off.
- Make sure you secure the plate (G) firmly.
- Use the acrylic Diasec panel only. Other panels may have the risk of detaching the holder, which leads to the panel falling off. Any accident regarding improper material shall not be covered by the warranty.

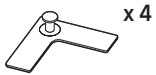
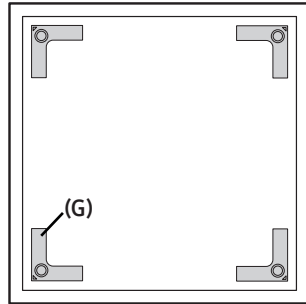

(G)

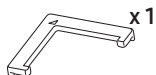

(H)

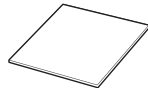

Art Panel (sold separately)

Use the Holder-Guide (H) to attach the Holder-Plate (G) in every corner of the art panel.

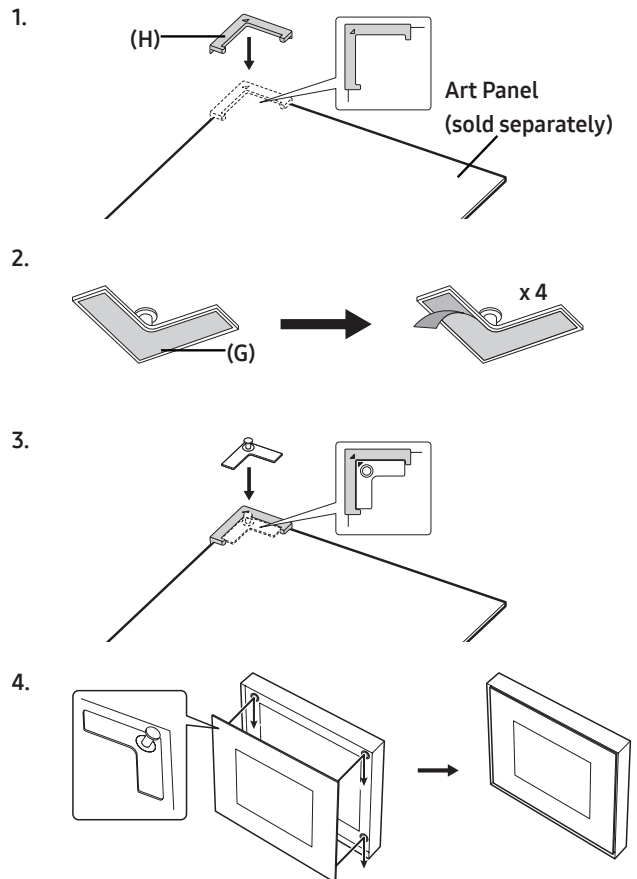

03 PRODUCT OVERVIEW

Front

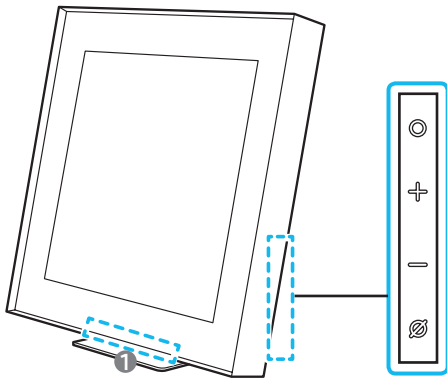

<p>①</p>	<p>LED indicator The LED Indicator flashes, glows, or changes color depending on the Wireless Speaker's current mode or status. The color of the LED indicator and the number of lights indicate the active mode as described below.</p> <p>LED indicator (W : White, M : Multicolor)</p>  <ul style="list-style-type: none"> The Multicolor LED changes to White, Cyan, Green, Red, and Blue depending on the mode or status. 								
<p>○</p>	<p>(Multi Function) Button</p> <ul style="list-style-type: none"> In standby mode, press the ○ (Multi Function) button to turn on the Wireless Speaker. Press the ○ (Multi Function) button to change the mode. Each time you change the mode, the LED lights in white and then turns off. <table border="1" data-bbox="181 1301 774 1585"> <thead> <tr> <th>LED indicator</th> <th></th> </tr> </thead> <tbody> <tr> <td>○ ● ○ ○ ○</td> <td>White On → Off Wi-Fi</td> </tr> <tr> <td>○ ● ● ○ ○</td> <td>White On → Off Bluetooth</td> </tr> <tr> <td>○ ● ● ● ○</td> <td>White On → Off Digital Audio In</td> </tr> </tbody> </table>	LED indicator		○ ● ○ ○ ○	White On → Off Wi-Fi	○ ● ● ○ ○	White On → Off Bluetooth	○ ● ● ● ○	White On → Off Digital Audio In
LED indicator									
○ ● ○ ○ ○	White On → Off Wi-Fi								
○ ● ● ○ ○	White On → Off Bluetooth								
○ ● ● ● ○	White On → Off Digital Audio In								
<p>— +</p>	<p>(Volume) Button Adjusts the volume.</p>								



(Mic On/Off) Button

Press the button to turn the microphone on or off. When the microphone is off, the LED indicator will light red.

LED indicator	
○ ○ ● ○ ○	Mic Off
○ ○ ○ ○ ○	Mic On

- To switch to Bluetooth Pairing state in **Bluetooth** mode, press and hold the ○ **(Mic On/Off)** button on the side of the Wireless Speaker for more than 5 seconds.

Rear

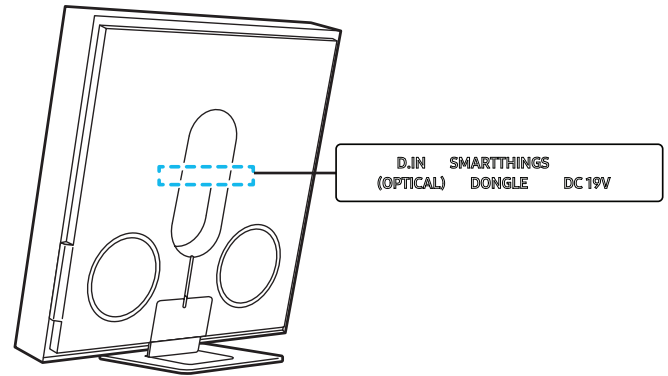

<p>D. IN (OPTICAL)</p>	<p>Connect to the digital (optical) output of an external device. (See page 14)</p>
<p>SMARTTHINGS DONGLE</p>	<p>Connect the SmartThings dongle (Purchase separately) to use the SmartThings Hub function. (See page 9)</p>
<p>DC 19V</p>	<p>Connect the AC/DC power adaptor. (Power Supply In) (See page 7)</p>

- When disconnecting the power cable of the AC/DC power adaptor from a wall outlet, pull the plug. Do not pull the cable.
- Do not connect this unit or other components to an AC outlet until all connections between components are complete.
- When you plug in the AC cord, the power button will begin working in 4 to 6 seconds.
- When you turn on this unit, there will be a 4 to 5 second delay before it produces sound.

04 CONNECTING ELECTRICAL POWER

Use the power components to connect the Wireless Speaker to an electrical outlet in the following order:

- For more information about the required electrical power and power consumption, refer to the label attached to the product. (Label: Bottom of the Wireless Speaker Main Unit)
1. First connect the power cable to the AC/DC adapter. Connect the AC/DC adapter (with the power cable) to the Wireless Speaker.
 2. Connect the power cord to a wall socket.

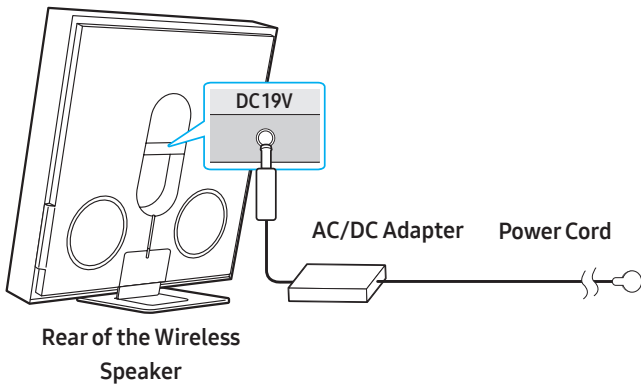

NOTE

- If you unplug and reconnect the power cord when the product is turned on, the Wireless Speaker turns on automatically.
- Make sure to rest the AC/DC Adapter flat on a table or the floor. If you place the AC/DC Adapter so that it is hanging with the AC cord input facing upwards, water or other foreign substances could enter the Adapter and cause the Adapter to malfunction.

05 CONNECTING A MOBILE DEVICE

Method 1. Connecting the SmartThings App (Wireless Network)

To connect a Wireless Speaker to a mobile device via a wireless network (Wi-Fi), the **SmartThings** app is required.

- It is required to have a certain higher version of OS for the smooth use of SmartThings. For more version informations, please refer to the SmartThings App description in the OS-specific market.

1 - Installation

- The SmartThings app allows you to control the functionality of and adjust the settings of the Wireless Speaker.
- Download the SmartThings app from the app store of your mobile device, or simply scan the provided QR code and download the app.



2 - Device registration

1. Run the SmartThings app on your mobile device.
2. Follow the on screen instructions and add the Wireless Speaker to your mobile device.
If the automatic pop-up window does not appear, press (+) on the Home screen to register the Wireless Speaker.

If device search is not possible

1. Connect the Wireless Speaker from the mobile device to Bluetooth.
2. Tap "Devices" on the SmartThings App.
3. Slide the screen to the left to select the Wireless Speaker card from "Personal Devices" and click "Register device in Samsung account" to register the device.

3 - Control with SmartThings

1. With the SmartThings app open on your device, select the Wireless Speaker that you have added.
2. The settings menu of the Wireless Speaker appears, where you can adjust the various settings including volume, sound mode or fine-tuning.

NOTE

- The illustration below may differ with the app version.

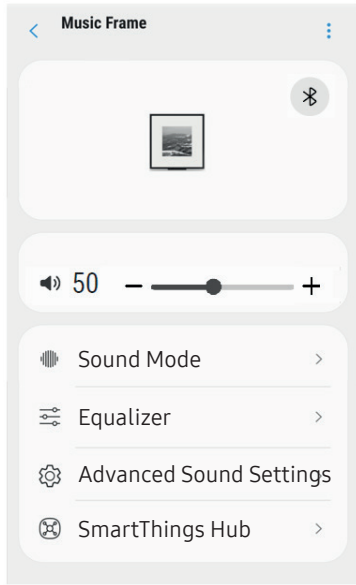

Sound Mode	<ul style="list-style-type: none"> Music : Provides more natural and room filling sound for music content. Standard : Outputs the original sound. Adaptive Sound : Analyzes the content in real time and automatically provides the optimal sound field based on the characteristics of the content.
Equalizer	You can set the Bass and Treble .
SpaceFit Sound	Provides optimized sound quality by analyzing the listening spaces.
Active Voice Amplifier	<p>Analyzes external noise in real time while Wireless Speaker is playing, so that voice audio can always be heard clearly.</p> <ul style="list-style-type: none"> No data is saved during the analysis
Advanced Sound Settings	<ul style="list-style-type: none"> Voice enhancement makes it easier to hear spoken dialog in movies and TV. Night mode is optimized for night time viewing with the settings adjusted to bring the volume down but keep the dialog clear.

Output specifications for the SOUND MODE

Effect	Input	Output
Adaptive Sound	2.0 ch	2.0 ch
	5.1 ch	2.0 ch
	Dolby Atmos®	2.0 ch
Music	2.0 ch	2.0 ch
	5.1 ch	2.0 ch
	Dolby Atmos®	2.0 ch
Standard	2.0 ch	2.0 ch
	5.1 ch	2.0 ch
	Dolby Atmos®	2.0 ch

To change your Wi-Fi connection

- Launch the **SmartThings** app from your mobile device (smartphone or tablet).
- Tap the Wireless Speaker’s card and tap the () icon.
- Go to **Device Settings** > **Network Status** > **Change Wi-Fi network**, and follow the onscreen instructions.

Using Group Play

- To benefit from this feature, add your Wireless Speaker to the SmartThings app.
- To enable this, connect at least two audio devices to the same Wi-Fi network at 5 GHz.
- This is available on Samsung Sound devices that support Wi-Fi released year 2024 or later.
- This feature does not support TV sound.

Configuring Group Play

- Run the **SmartThings** app on your mobile device.
- Add the Wireless Speaker in the **SmartThings** app according to the instructions in the “**Method 1. Connecting the SmartThings App (Wireless Network)** > **2 - Device registration**” section.
- Tap the Wireless Speaker’s card.
- On your mobile device, tap **Create Group** under the audio device icon.
 - Create Group** button appears only when Wireless Speaker is in Wi-Fi mode.
 - If the Wireless Speaker is playing the TV sound, the connection to the TV is disconnected when creating a group.
- Enable **Group Play**.
- Select a desired device in the list, and tap **Apply**.
 - You can add a maximum of 4 devices.
 - With **Group Play**, the audio will be output through the host device alone.
 - When a device connected to the host device switches to a different source, the device will be deleted from the group automatically.
 - When the host device is connected to a TV, the generated group will be deleted automatically.

Disabling Group Play

1. Tap the audio device's card.
2. On your mobile device, tap **Edit Group** under the audio device icon.
3. Disable **Group Play**.
 - To disable an individual device, uncheck the device from the list and tap **Apply**.

Using the SmartThings Hub

- This feature is available only with connection to the Samsung SmartThings dongle. The dongle is not included with this product, and may not be available depending on the region.
- You can use the Wireless Speaker's **SmartThings Hub** function to connect the IoT devices (bulbs, plugs, sensors etc.) that require **SmartThings Hub**.
- To use the **SmartThings Hub** function, you must register the Wireless Speaker in the **SmartThings** app.

Connecting the SmartThings dongle

1. Connect the SmartThings dongle (sold separately) to the USB port on the Wireless Speaker. SmartThings Hub is automatically registered.

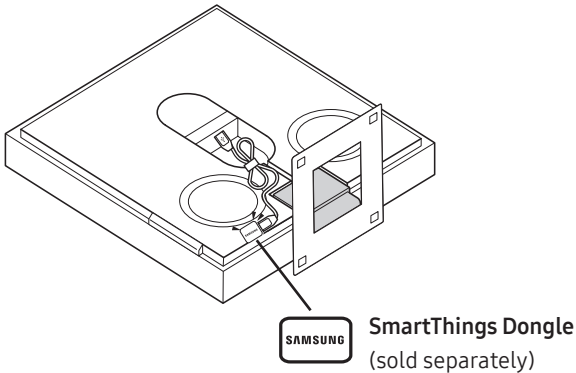

Registering an IoT device on the SmartThings app

1. On the mobile device, run the **SmartThings** app.
2. Add the Wireless Speaker in the **SmartThings** app according to the instructions in the "**Method 1. Connecting the SmartThings App (Wireless Network) > 1 - Installation**" section.
3. Tap the Wireless Speaker device card.
4. Tap **SmartThings Hub** at the bottom of the screen.
5. Tap **Using SmartThings Hub**, and then tap **Set up** to activate the **SmartThings Hub** function.
 - When the **SmartThings Hub** function activates, **unset** changes to **using**.
 - **SmartThings Hub** device card will appear next to the Wireless Speaker device card.
6. On the **Home** screen, tap "**+**" to add an IoT device.
 - An IoT device card appears on the app when you successfully add an IoT device.
 - If you unplug the Wireless Speaker, devices connected through the **SmartThings Hub** may be disconnected. You must reconnect the devices once they get disconnected.

Deleting SmartThings Hub from the SmartThings app

1. On the devices screen, tap the Wireless Speaker device card.
2. Tap **SmartThings Hub** at the bottom of the screen.
3. Tap **Removing SmartThings Hub** to deactivate the **SmartThings Hub** function.
 - When the **SmartThings Hub** function deactivates, **using** changes to **unset**.

Connecting via Apple AirPlay

With AirPlay®, you can enjoy music, podcasts, and other audio on your Samsung Wireless Speaker, right from your Apple devices.

1. Select  from an AirPlay-supported app or Control Center on your iPhone®, iPad®, or Mac®.
2. Select the Wireless Speaker from the list of available devices to play the current audio to.
 - This feature may not be available in some countries.
 - To use AirPlay with your Samsung Wireless Speaker, the latest version of iOS, iPadOS, or macOS is recommended.
 - To enable AirPlay in your Wireless Speaker, you must first register the device with the Samsung Smart Things app by agreeing with the app's terms and conditions.
 - Make sure the Wireless Speaker is powered on and connected to the same Wi-Fi network as your Apple® device.

Method 2. Connecting via Bluetooth

When a mobile device is connected using Bluetooth, you can hear stereo sound without the hassle of cabling.

- When you connect a paired Bluetooth device with the Wireless Speaker off, the Wireless Speaker automatically turns on.

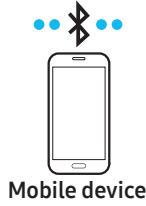

The initial connection

When connecting to a new Bluetooth device, make sure the device is within 3.28 ft (1 m) distance.

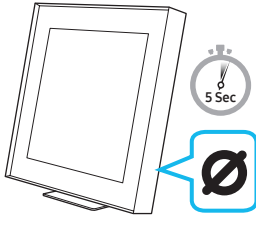
Bluetooth Pairing button	LED Indicator
<p>When in "Bluetooth" mode</p> 	<p>[Pairing]</p> <p>○ ○ ● ○ ○</p> <p>– Red → Green → Blue Blinks</p> <p style="text-align: center;">↓</p> <p>[Connection is complete]</p> <p>○ ○ ● ○ ○</p> <p>– Cyan Blinks X3</p> <hr/> <p>🔊 Ready to connect via Bluetooth.</p>

2. On your device, select "Music Frame" from the list that appears.
3. Play music files from the device connected via Bluetooth through the Wireless Speaker.

If the device fails to connect

- If you have an existing Wireless Speaker (e.g., "Music Frame") in the list of speakers on the Mobile device, delete it.
- Repeat steps 1 and 2.

Notes on Bluetooth connection

- Locate a new device within 3.28 ft (1 m) to connect via Bluetooth communication.
- If asked for a PIN code when connecting a Bluetooth device, enter <0000>.
- The Wireless Speaker automatically turns off after 18 minutes in the Ready state.
- The Wireless Speaker may not perform Bluetooth search or connection correctly under the following circumstances:
 - If there is a strong electrical field around the Wireless Speaker.
 - If several Bluetooth devices are simultaneously paired with the Wireless Speaker.
 - If the Bluetooth device is turned off, not in place, or malfunctions.
- Electronic devices may cause radio interference. Devices that generate electromagnetic waves must be kept away from the Wireless Speaker main unit - e.g., microwaves, wireless LAN devices, etc.
- The Wireless Speaker supports SBC data (44.1kHz, 48kHz).
- Connect only to a Bluetooth device that supports the A2DP (AV) function.
- You cannot connect the Wireless Speaker to a Bluetooth device that supports only the HF (Hands Free) function.
- When connecting the Wireless Speaker to a Bluetooth device, place them as close to each other as possible.
- The farther the Wireless Speaker and Bluetooth device are from each other, the lower the sound quality will become. The Bluetooth connection may break when the devices are out of the effective range.
- The Bluetooth connection may not function as intended in areas with poor reception.
- A Bluetooth device may experience noise or malfunction under in the following conditions:
 - When the body is in contact with the signal transceiver on the Bluetooth device or Wireless Speaker
 - In corners or when there is an obstacle in proximity, such as a wall or partition, where electrical changes may occur.
 - When exposed to radio interferences by other products operating on the same frequency ranges, such as medical equipment, microwave ovens, and wireless LAN devices.
 - Obstacles such as doors and walls may still impact the sound quality even when the devices are within the effective range.
- Note that your Wireless Speaker cannot be paired with other Bluetooth devices while using the Bluetooth option.
- This wireless device may cause electrical interference during operation.

Disconnecting the Bluetooth device from a Wireless Speaker

You can disconnect a Bluetooth device from the Wireless Speaker. For instructions, see the Bluetooth device's user manual.

- The Wireless Speaker will be disconnected.
- If the Wireless Speaker is disconnected from the Bluetooth device, the multicolor LED indicator on the Wireless Speaker blinks "Red" three times.

Disconnecting the Wireless Speaker from the Bluetooth device

Press the **○ (Multi Function)** button on the top of the Wireless Speaker to switch the mode from "Bluetooth".

- Disconnecting takes time because the Bluetooth device must receive a response from the Wireless Speaker. (Disconnection time may differ, depending on the Bluetooth device)

Using the Tap Sound

Tap the Wireless Speaker with your mobile device to play the sound of content on the mobile device through the Wireless Speaker.

- This function may not be supported, depending on the mobile device.
- This function is only compatible with Samsung mobile devices with Android 8.1 or later.

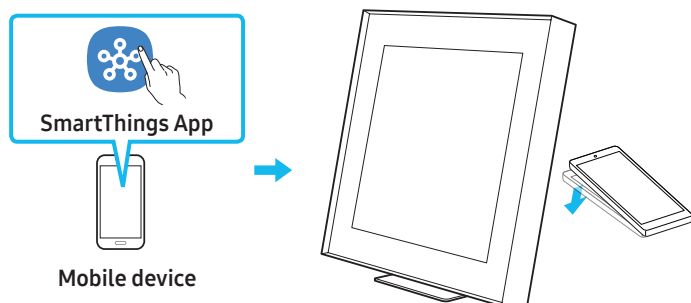

1. Turn on the **Tap Sound** function on your mobile device.
 - For details on how to turn on the function, refer to "**Setting the Tap Sound function**" below.
2. Tap the Wireless Speaker with the mobile device. Select "**Start now**" in the displayed message window.
A connection is established between the mobile device and Wireless Speaker via Bluetooth.

3. Play the sound of content on the mobile device through the Wireless Speaker.
 - This function connects a mobile device to the Wireless Speaker via Bluetooth by detecting vibration that occurs when the device touches the Wireless Speaker.
 - Make sure the mobile device does not tap a sharp corner of the Wireless Speaker. The Wireless Speaker or mobile device may become scratched or damaged.
 - It is recommended that the mobile device be covered with a case. Lightly tap the wide area in the upper portion of the Wireless Speaker, without using excessive force.
 - To use this function, update the **SmartThings** app to the latest version.
The function may not be supported, depending on the app version.

Setting the Tap Sound function

Use the **SmartThings** app to turn on the **Tap View, Tap Sound** function.

1. On the mobile device, run the **SmartThings** app.
2. Select (**☰** → **⚙**) in the **SmartThings** app screen displayed on the mobile device.
3. Set "**Tap View, Tap Sound**" to On to allow the function to work when a mobile device moves close to the Wireless Speaker. The function is turned on.

NOTE

- When the mobile device is in power-saving mode, the **Tap Sound** function does not work.
- The **Tap Sound** function may not work if there are devices near the Wireless Speaker that cause radio interference such as electric devices. Make sure devices that may cause radio interference are placed at a sufficient distance away from the Wireless Speaker.

06 CONNECTING TO A TV

Connecting via Wi-Fi

Pre-connection Checklist

- Wi-Fi connection is available only on Samsung TV.
 - Check whether **the wireless router (Wi-Fi)** is turned on and **the TV is connected to the router**.
 - The TV and Wireless Speaker must be connected to the same wireless network (Wi-Fi).
 - If your wireless router (Wi-Fi) uses a DFS channel, you will not be able to establish a Wi-Fi connection between the TV and Wireless Speaker. Contact your Internet service provider for details.
 - Because the menus may differ depending on the year of manufacture, refer to your TV manual.
 - To connect the TV to the Wireless Speaker via Wi-Fi, connect the Wireless Speaker to the wireless router first. See page 7, for details on how to establish a Wi-Fi connection.
1. For more information about Wi-Fi connection to the Wireless Speaker, see page 7, “**Method 1. Connecting the SmartThings App (Wireless Network)**”.
 2. Change the input source of the TV by using the Audio menu to Wireless Speaker.
 - **Samsung TVs released in 2017 or later**
Sound → Sound Output → Music Frame (Wi-Fi)

Connecting to a TV that supports Dolby Atmos

Pre-connection Checklist

- Make sure that the content supports Dolby Atmos®.

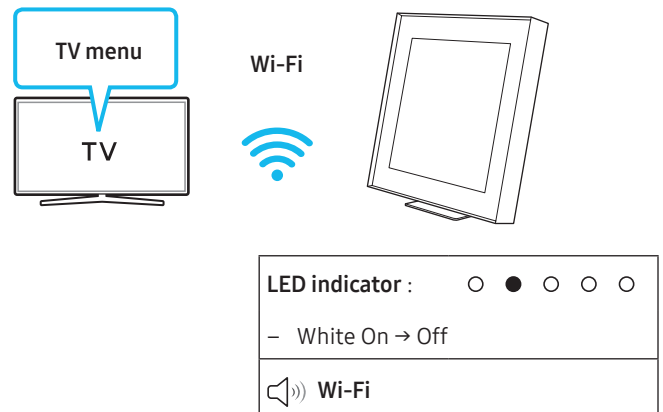

1. Connect the Wireless Speaker and TV to the same wireless network (Wi-Fi).
2. For sound output of the TV, select Wireless Speaker.
3. TV sound is output from the Wireless Speaker.

NOTE

- **When you use Dolby Atmos®:** If the input source is Dolby Atmos®, refer to “**Output specifications for the SOUND MODE**” on page 8.
- **Configuring Dolby Atmos® on your BD player or other device connected to the TV.**
Open the audio output options on the settings menu of your BD player or other device and make sure that “No Encoding” is selected for Bitstream. For example, on a Samsung BD Player, go to Home Menu → Sound → Digital Output and then select Bitstream (unprocessed).
- This function is available in some Samsung TVs and some Wireless Speaker models.

Using the Q-Symphony Function

- When the Wireless Speaker connects to a Samsung TV that supports the Q-Symphony function you can play the sound simultaneously through the Wireless Speaker and the TV. If you use the Q-Symphony function, the surround sound played on the TV allows you to enjoy a richer, more three-dimensional surround sound effect.

- When the Wireless Speaker is connected “**Q-Symphony**” menu appears on the TV.

Settings (⚙️) → All Settings (⚙️) → Sound → Sound Output

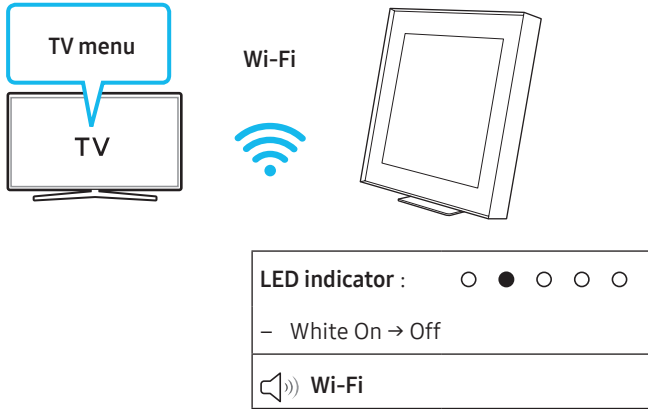

NOTE

- It can operate according to the Codec supported by TV.
- This function is supported only when Wi-Fi is connected.
- Ensure that your TV and Wireless Speaker are connected to the same wireless router/frequency.
- It is available with new Samsung TV models to be released 2024.

Connecting via Bluetooth

When a Samsung TV is connected using Bluetooth, you can hear stereo sound without the hassle of cabling.

- Only one Samsung TV can be connected at a time.
- Samsung TV that supports Bluetooth can be connected. Check the specifications of your TV.



The initial connection

Bluetooth Pairing button	LED Indicator
<p>1. When in “Bluetooth” mode</p>	<p>[Pairing]</p> <p>○ ○ ● ○ ○</p> <p>– Red → Green → Blue Blinks</p> <p style="text-align: center;">↓</p> <p>[Connection is complete]</p> <p>○ ○ ● ○ ○</p> <p>– Cyan Blinks X3</p>
	<p>Ready to connect via Bluetooth.</p>

- Until pairing is complete, the Multicolor LED changes as **Red** → **Green** → **Blue** in turn.
- Select Bluetooth mode on the Samsung TV.
(e.g. Home (🏠) → Menu → Settings (⚙️) → All Settings (⚙️) → Sound → Sound Output → Bluetooth Speaker List → Music Frame (Bluetooth))
 - Select “**Music Frame**” from the list on TV’s screen.
An available Wireless Speaker is indicated with **Need Pairing** or **Paired** on the TV’s Bluetooth device list. To connect the Samsung TV to the Wireless Speaker, select the message, and then establish a connection.
 - You can now hear Samsung TV sound from the Wireless Speaker.
 - If there is a connection log between the Wireless Speaker and Samsung TV, the Wireless Speaker is automatically connected by changing its mode to **Bluetooth**.

If the device fails to connect

- If you have an existing Wireless Speaker (e.g., **Music Frame**) on the list of speakers on the Samsung TV, delete it.
- Then repeat steps 1 through 3.

Disconnecting the Wireless Speaker from the Samsung TV

Press the **○ (Multi Function)** button at the top of the Wireless Speaker to select the mode other than "Bluetooth".

- Disconnecting takes time because the Samsung TV must receive a response from the Wireless Speaker. (The time required may differ, depending on the Samsung TV model.)

Notes on Bluetooth connection

- Locate a new device within 3.28 ft (1 m) to connect via Bluetooth communication.
- If asked for a PIN code when connecting a Bluetooth device, enter <0000>.
- The Wireless Speaker automatically turns off after 18 minutes in the Ready state.
- The Wireless Speaker may not perform Bluetooth search or connection correctly under the following circumstances:
 - If there is a strong electrical field around the Wireless Speaker.
 - If several Bluetooth devices are simultaneously paired with the Wireless Speaker.
 - If the Bluetooth device is turned off, not in place, or malfunctions.
- Electronic devices may cause radio interference. Devices that generate electromagnetic waves must be kept away from the Wireless Speaker main unit - e.g., microwaves, wireless LAN devices, etc.

Connecting using an Optical Cable

Pre-connection Checklist

When you use an optical cable and the terminals have covers, be sure to remove the covers.

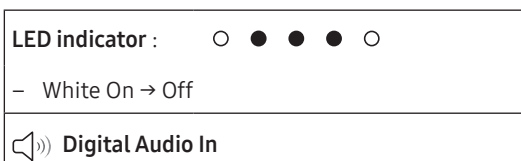
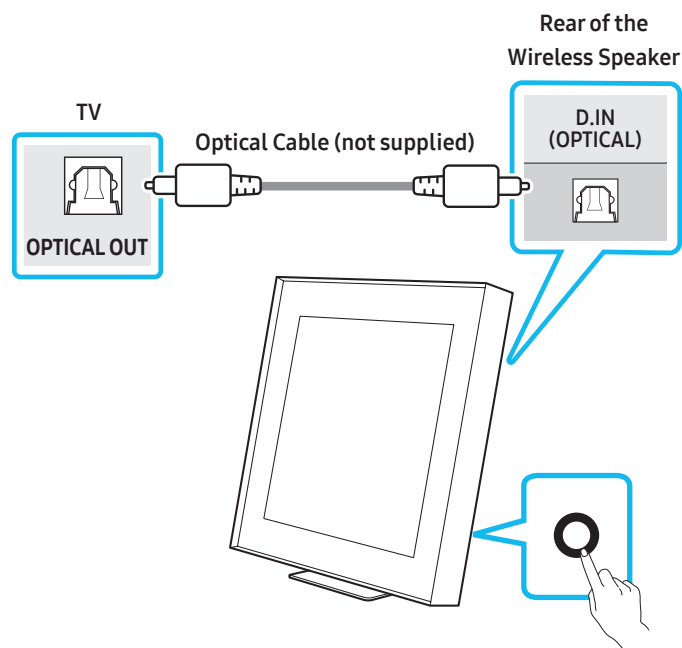

1. With the TV and Wireless Speaker turned off, connect the **D.IN (OPTICAL)** port on the Wireless Speaker and the **OPTICAL** output port on the TV with the optical cable (not supplied), as shown in the figure.
2. Turn on the Wireless Speaker and TV.
3. Press the **○ (Multi Function)** button on the Wireless Speaker unit and then select the "Digital Audio In" mode. Then the announcement, "Digital Audio In" is output.
4. The TV sound is output from the Wireless Speaker.

Using the Spacefit sound

Provides optimized sound quality by analyzing the listening spaces.

Method 1. Connecting via Wireless Speaker

1. Run the **SmartThings** app on your mobile device.
2. Tap Wireless Speaker's card.
3. Enable **Spacefit sound**.
 - This is available in all Sound modes.

Method 2. Connecting via TV

To enable this function, turn on the Adaptive Sound+ mode on your Samsung TV menu.

(Home (🏠) → Menu → Settings (⚙️) → All Settings (⚙️) → General → Intelligent Mode Settings → Adaptive Sound+)

- The sound mode on your Wireless Speaker will automatically change to **Adaptive Sound+** if you enable the **Adaptive Sound+** mode on your TV.

NOTE

- This function works when the Wireless Speaker connects to some of the Samsung TVs.

07 CONNECTING AN EXTERNAL DEVICE

Connecting using an Optical Cable

Pre-connection Checklist

Make sure both the external device and the Wireless Speaker are turned off.

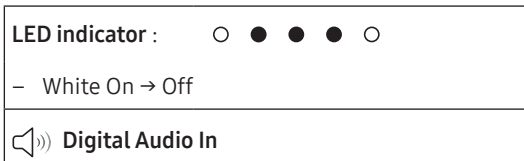
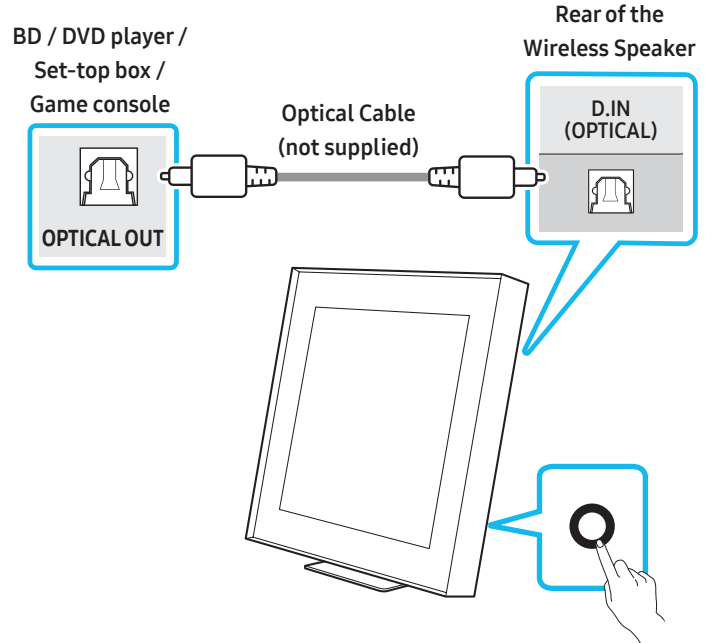

1. Use an optical cable (not supplied) to connect the **D.IN (OPTICAL)** port of the Wireless Speaker and the optical output port of the external device. See the figure below.
2. Turn on both the Wireless Speaker and the external device.
3. Press the **○ (Multi Function)** button on the Wireless Speaker unit and then select the "Digital Audio In" mode. Then the announcement, "Digital Audio In" is output.
4. The audio signal of the external device will sound from the Wireless Speaker.

08 ADDITIONAL FEATURES

Adjusting the Wireless Speaker volume with a TV remote control

Adjust the Wireless Speaker volume using the TV's remote control.

- This function can be used with IR remote controls only. Bluetooth remote controls (remote controls that require pairing) are not supported.
 - Set the TV speaker to **External Speaker** to use this function.
 - Manufacturers supporting this function: Samsung, VIZIO, LG, Sony, Sharp, PHILIPS, PANASONIC, TOSHIBA, Hisense, RCA
1. Turn Off the Wireless Speaker.
 - To do this, tap the **⏻ (Power)** button on the SmartThings app. Alternatively, press and hold both the **⊙ (Multi Function)** button and the **🎤 (Mic On/Off)** button simultaneously on the Wireless Speaker for 5 seconds.
 2. Press the **⊙ (Multi Function)** button on the unit for 5 seconds.

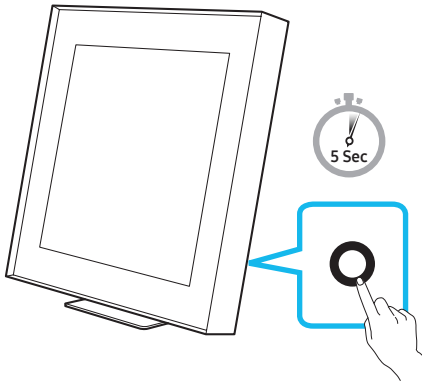

- Each time you press the **⊙ (Multi Function)** button for 5 seconds, the mode switches in the following order: **"OFF-TV REMOTE"** (Default mode), **"SAMSUNG-TV REMOTE"**, **"ALL-TV REMOTE"**.

LED Indicator	🔊	Status
○ ○ ● ○ ○ – Red Blinks X1	Off-TV Remote (Default mode)	Disable the TV remote control.
○ ○ ● ○ ○ – Cyan Blinks X1	Samsung-TV Remote	Enable a Samsung TV's IR remote control.
○ ○ ● ○ ○ – Blue Blinks X1	All-TV Remote	Enable a third-party TV's IR remote control.

Activate/Deactivate Wi-Fi and Bluetooth

To activate/deactivate Wi-Fi connection

Press and hold the **🎤 (Mic On/Off)** button and the **(-)** button on the side panel simultaneously for more than 30 seconds. This will turn on or off the Wi-Fi connection.

To activate/deactivate Bluetooth connection

Press and hold the **🎤 (Mic On/Off)** button and the **(+)** button on the side panel simultaneously for more than 30 seconds. This will turn on or off the Bluetooth connection.

09 INSTALLING THE WALL MOUNT

Installation Precautions

- Install on a vertical wall only.
- Do not install in a place with high temperature or humidity.
- Verify whether the wall is strong enough to support the product's weight. If not, reinforce the wall or choose another installation point.
- Connect cables from the unit to external devices before you install the Wireless Speaker on the wall.
- Make sure the unit is turned off and unplugged before you install it. Otherwise, it may cause an electric shock.
- Make sure you use the wall-mount component parts provided with this product. Under any circumstances, any accident resulting from using third-party parts shall not be covered by the warranty.

Wallmount Components

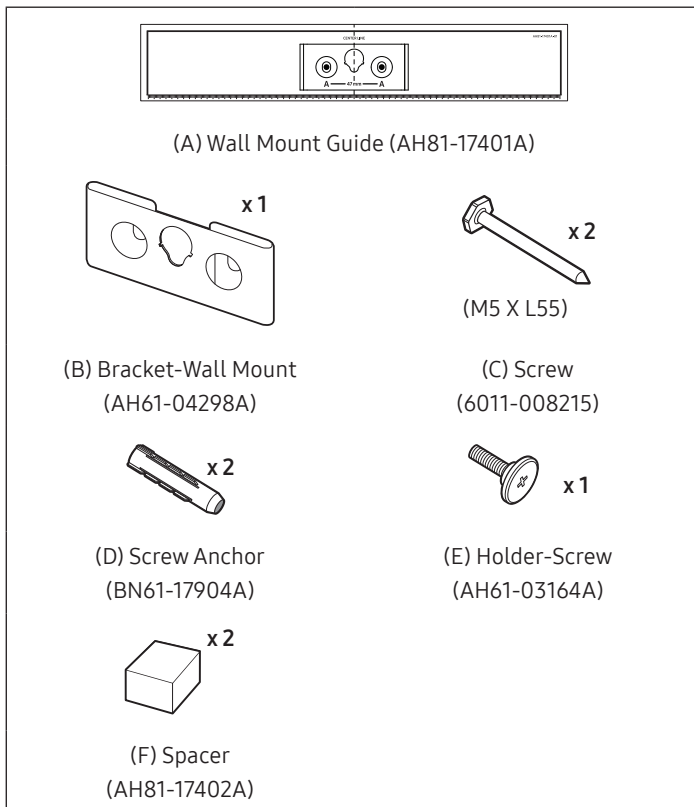

1. Place the **Wall Mount Guide** against the wall surface.
 - The **Wall Mount Guide** must be level.
 - If you are mounting a device below a mounted object, install at least 4 inches (10cm) apart.

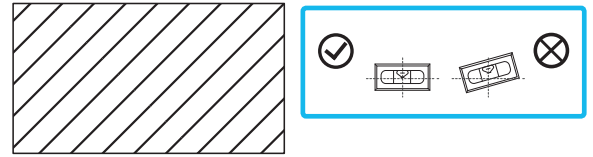

4 inches (10 cm) or more

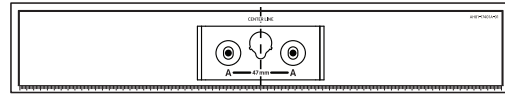

2. Use a pen to mark the positions of the holes and remove the **Wall Mount Guide**.

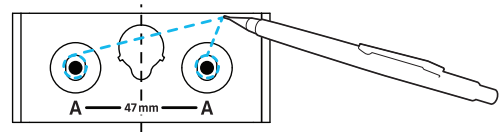

3. Using an appropriately sized drill bit, drill a hole in the wall at each marking.
 - If the markings do not correspond to the positions of studs, make sure you insert appropriate anchors or mollies into the holes before you insert the support screws. If you use anchors or mollies, make sure the holes you drill are large enough for the anchors or mollies you use.
4. Push a screw (not supplied) through each **Screw**, and then screw each screw firmly into a support screw hole.

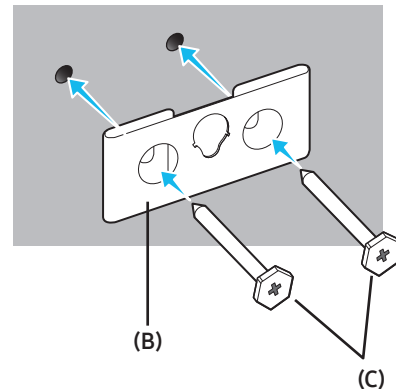

5. Tighten the wall-mounting holder screw (E) on the back of the product.

⚠ CAUTION

- Tighten the screw firmly until it does not move at all. Otherwise, the product may fall off and cause damage or physical injury. Any accident resulting from improper installation shall not be covered by the warranty.

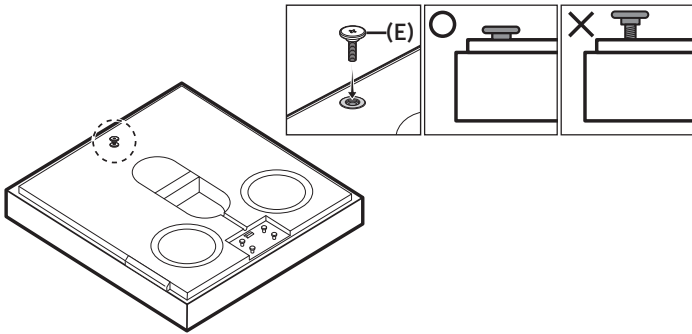

6. Remove the liners (x4) of the double-sided adhesive tape from the spacers (F). Then, put them on the marked sites (x4) on the back of the product.

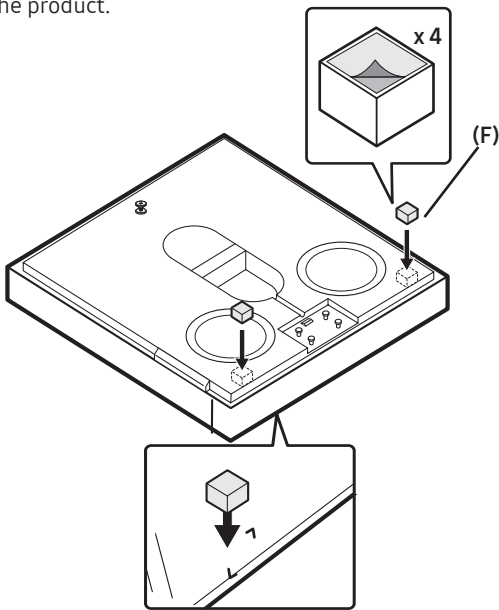

7. Place the Wireless Speaker on the wall-mount bracket. Make sure the holder screw is inserted properly on the Wireless Speaker.

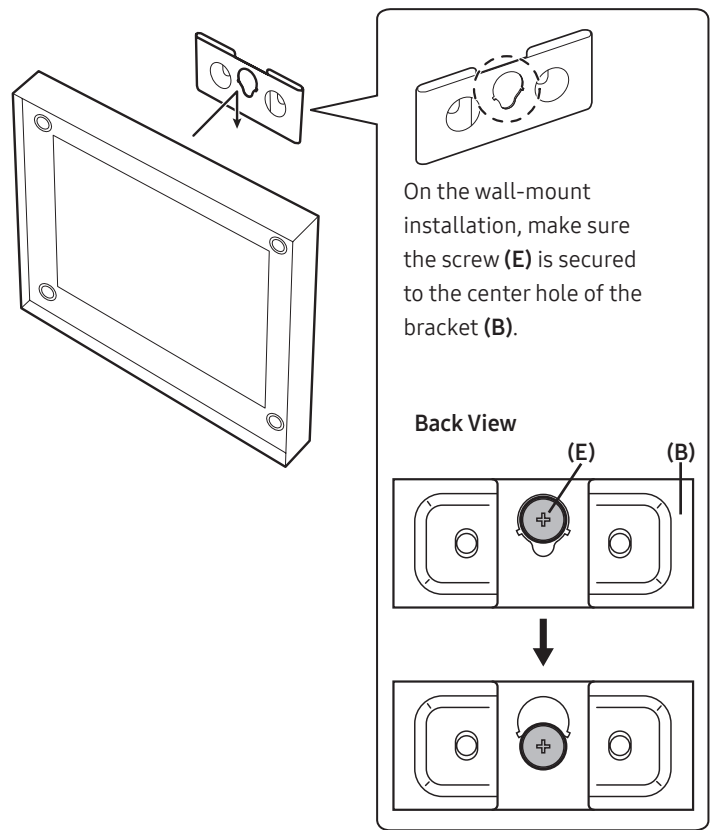

- The part (F) must be attached to prevent the product from moving out of the wall-mount installation. On the stand installation, it must be kept safely for later use. When reusing it, use a double-sided adhesive tape for attachment.

10 SOFTWARE UPDATE

Auto Update

When the Wireless Speaker is connected to the Internet, software updates automatically occur even when the Wireless Speaker is turned off.

- To use the Auto Update function, the Wireless Speaker must be connected to the Internet.
The Wi-Fi connection to the Wireless Speaker will be terminated if the Wireless Speaker's power cord is disconnected or the power is cut off. If the power is cut off, when the power comes back on or you reconnect the power cord, turn on the Wireless Speaker, and then reconnect it to the Internet.

USB Update

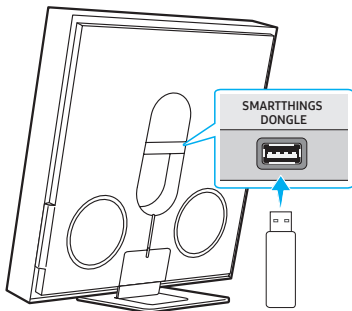

Rear of the Wireless Speaker

Samsung may offer updates for the Wireless Speaker's system firmware in the future.

When an update is available, you can update the Wireless Speaker by connecting the USB drive that contains the update firmware to the **SMARTHINGS DONGLE** port of the Wireless Speaker.

- Go to (www.samsung.com) → search for the model name from the customer support menu option.
 - For more information about update, refer to Upgrade Guide.
- Download the upgrade file (USB type).
- Unzip the file to create a folder with the file name.
- Store the created folder in a USB and then connect it to the Wireless Speaker.
- Turn on the Wireless Speaker. Then the product is updated within 3 minutes.

LED indicator : ○ ● ○ ○ ○
 ← →
 – White moves from left to right and right to left

- During update, do not turn it off or remove the USB.
- If the yellow LED is on after the software update is completed, this means that an additional update is in progress. When this happens, don't turn off the power or remove the USB.
- If update does not proceed, reconnect the Wireless Speaker power cord.
- When the latest version is installed, no update is performed.
- Depending on the USB type, update may not be supported.

- If there is no update file available, the indicator blinks red 3 times.

LED indicator : ○ ○ ● ○ ○
 – Red Blinks X3

- If the update file is in the same or lower version than the existing, the indicator blinks cyan 3 times.

LED indicator : ○ ○ ● ○ ○
 – Cyan Blinks X3

Reset

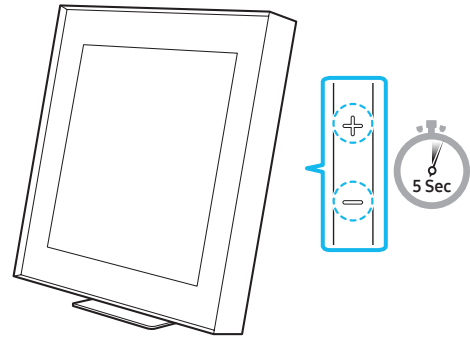

With the Wireless Speaker on, press the **– + (Volume)** buttons on the body at the same time for at least 5 seconds. The LED indicator changes as shown below and then the Wireless Speaker is reset.

LED indicator

○ ● ○ ○ ○ – White moves from left to right and right to left
 ← →
 ↓
 ○ ○ ● ○ ○ – Cyan Blinks X3
 ↓
 ○ ○ ● ○ ○ – Red Blinks X3

⚠ CAUTION

- All the settings of the Wireless Speaker are reset. Be sure to perform this only when a reset is required.

Security updates information

Security updates are provided to strengthen the security of your device and protect your personal information. For more information on security updates, visit <https://security.samsungtv.com>.

- The website supports only some languages.

11 TROUBLESHOOTING

Refer to the instructions below if this product does not function properly. If the problem you are experiencing is not listed below or if the instructions below do not help, turn off the product, disconnect the power cord, and contact Samsung Electronics at 1-800-SAMSUNG (1-800-726-7864).

Wireless Speaker does not turn on.

- Check whether the power cord of the Wireless Speaker is correctly inserted into the outlet.

Wireless Speaker works erratically.

- After removing the power cord, insert it again.
- Power cycle the external device and try again.
- If there is no signal, the Wireless Speaker automatically turns off after a certain period of time. Turn on the power.

The Wireless Speaker indicator turns solid red.

- The microphone is turned off.
Turn on the microphone. (See page 6.)

Sound is not output from the Wireless Speaker.

- The volume of the Wireless Speaker is too low or muted. Adjust the volume.
- When any external device (STB, Bluetooth device, mobile device, etc.) is connected, adjust the volume of the external device.
- For sound output of the TV, select Wireless Speaker. (Samsung TV:
Home (🏠) → Menu → Settings (⚙️) → All Settings (⚙️) → Sound → Sound Output → Select Wireless Speaker)
- The cable connection to the Wireless Speaker may not be loose. Remove the cable and connect again.
- Remove the power cord completely, reconnect, and turn the power on.
- Reset the product and try again. (See page 19.)

I want to hear the audio signal from the Wireless Speaker alone.

- If you hear sounds from both the TV and Wireless Speaker, go to the **Settings** menu for the TV audio and change the TV speaker to **External Speaker**.

Wireless Speaker will not connect via Bluetooth.

- When connecting a new device, switch to “**Bluetooth Pairing**” for connection. (Press the **⏻ (Mic On/Off)** button on the body for at least 5 seconds.)
- If the Wireless Speaker is connected to another device, disconnect that device first to switch the device.
- Reconnect it after removing the Bluetooth speaker list on the device to connect. (Samsung TV: Home (🏠) → Menu → Settings (⚙️) → All Settings (⚙️) → Sound → Sound Output → Bluetooth Speaker List)
- Remove and reconnect the power plug, then try again.
- Reset the product and try again. (For more information, refer to “**Reset**”.)

Sound drops out when connected via Bluetooth.

- Some devices can cause radio interference if they are located too close to the Wireless Speaker. e. g. microwaves, wireless routers, etc.
- If your device that is connected via Bluetooth moves too far away from the Wireless Speaker, it may cause the sound to drop out. Move the device closer to the Wireless Speaker.
- If a part of your body is in contact with the Bluetooth transceiver or the product is installed on metal furniture, the sound may drop out. Check the installation environment and conditions for use.

Wireless Speaker will not connect to Wi-Fi.

- Check whether your wireless router is on.
- Turn off the router, turn it back on, and then try again.
- The Wireless Speaker will not connect if the wireless signal is too weak. Try moving the router closer to the Wireless Speaker, or eliminating any obstacles that are between the Wireless Speaker and the router, if possible.
- If your wireless router is new, you will need to reconfigure the speaker’s network settings.
- Wireless Speaker does not support Wi-Fi 6.

The Wireless Speaker does not turn on automatically with the TV.

- When you turn off the Wireless Speaker while watching TV, power synchronization with the TV is disabled. First turn off the TV.

The AVA function is not available in the following cases.

- The AVA function will not be available using Q-symphony function.
- The AVA function will not be available when the microphone is turned off.

After connecting the TV to the Wireless Speaker, I switched the Wireless Speaker mode. Then no sound is output from the TV.

- If you connect your Wireless Speaker to a mobile device while the Wireless Speaker is connected to the TV, the Wireless Speaker outputs sound from the mobile device while keeping the TV connection. So the TV sound will not be delivered anywhere.
- Disconnect the mobile device, and the TV sound will be output from the Wireless Speaker again.

Group Play is not enabled

- Check if the audio devices are newer models released year 2024 or later.
- Check if the host device is connected to a Wi-Fi network as source.
- Make sure that all audio devices are connected to the same Wi-Fi network (at 5 GHz).

12 LICENSE



Dolby, Dolby Atmos, and the double-D symbol are registered trademarks of Dolby Laboratories Licensing Corporation. Manufactured under license from Dolby Laboratories. Confidential unpublished works. Copyright © 2012-2021 Dolby Laboratories. All rights reserved.



- Apple® and AirPlay® are trademarks of Apple Inc., registered in the U.S. and other countries and regions.
 - Use of the Works with Apple AirPlay badge means that an accessory has been designed to work specifically with the technology identified in the badge and has been certified by the developer to meet Apple performance standards.
-



- Use your phone, tablet or computer as a remote control for Spotify. Go to [spotify.com/connect](https://www.spotify.com/connect) to learn how
 - The Spotify Software is subject to third party licenses found here: <https://www.spotify.com/connect/third-party-licenses>.
-



Being Roon Tested means that Samsung and Roon have collaborated to ensure you have the best experience using Roon software and Samsung equipment together, so you can just enjoy the music.

Open Source License Notice

Open Source used in this product can be found on the following webpage (<http://opensource.samsung.com>).

LIMITED WARRANTY TO ORIGINAL CONSUMER PURCHASER WITH PROOF OF PURCHASE AND/OR PROOF OF DELIVERY

This SAMSUNG brand product, as supplied and distributed by SAMSUNG and delivered new, in the original carton to the original consumer purchaser, is warranted by SAMSUNG against manufacturing defects in materials and workmanship for a limited warranty period of:

One (1) Year Parts and Labor*
(*90 Days Parts and Labor for Commercial Use)

This limited warranty begins on the date of delivery to the original consumer purchaser, and is valid only on products purchased and used in the United States. To receive warranty service, the purchaser must contact SAMSUNG for problem determination and service procedures. Warranty service can only be performed by a SAMSUNG authorized service center. The original dated bill of sale and/or proof of delivery must be presented upon request to SAMSUNG or SAMSUNG's authorized service center. Transportation of the product to and from the service center is the responsibility of the purchaser.

SAMSUNG will repair or replace this product, at our option and at no charge as stipulated herein, with new or reconditioned parts or products if found to be defective during the limited warranty period specified above.

All replaced parts and products become the property of SAMSUNG and must be returned to SAMSUNG. Replacement parts and products assume the remaining original warranty, or ninety (90) days, whichever is longer.

SAMSUNG's obligations with respect to software products distributed by SAMSUNG under the SAMSUNG brand name are set forth in the applicable end user license agreement. Non-SAMSUNG hardware and software products, if provided, are on an "AS IS" basis.

Non-SAMSUNG manufacturers, suppliers, publishers, and service providers may provide their own warranties.

This limited warranty covers manufacturing defects in materials and workmanship encountered in normal, and except to the extent otherwise expressly provided for in this statement, noncommercial use of this product, and shall not apply to the following, including, but not limited to: damage which occurs in shipment; delivery and installation; applications and uses for which this product was not intended; altered product or serial numbers; cosmetic damage or exterior finish; accidents, abuse, neglect, fire, water, lightning or other acts of nature; use of products, equipment, systems, utilities, services, parts, supplies, accessories, applications, installations, repairs, external wiring or connectors not supplied and authorized by SAMSUNG, or which damage this product or result in service problems; incorrect electrical line voltage, fluctuations and surges; customer adjustments and failure to follow operating instructions, cleaning, maintenance and environmental instructions that are covered and prescribed in the instruction book; product removal or reinstallation; reception problems and distortion related to noise, echo, interference or other signal transmission and delivery problems. SAMSUNG does not warrant uninterrupted or error-free operation of the product.

THERE ARE NO EXPRESS WARRANTIES OTHER THAN THOSE LISTED AND DESCRIBED ABOVE, AND NO WARRANTIES WHETHER EXPRESS OR IMPLIED, INCLUDING, BUT NOT LIMITED TO, ANY IMPLIED WARRANTIES OF MERCHANTABILITY OR FITNESS FOR A PARTICULAR PURPOSE, SHALL APPLY AFTER THE EXPRESS WARRANTY PERIODS STATED ABOVE, AND NO OTHER EXPRESS WARRANTY OR GUARANTY GIVEN BY ANY PERSON, FIRM OR CORPORATION WITH RESPECT TO THIS PRODUCT SHALL BE BINDING ON SAMSUNG. SAMSUNG SHALL NOT BE LIABLE FOR LOSS OF REVENUE OR PROFITS, FAILURE TO REALIZE SAVINGS OR OTHER BENEFITS, OR ANY OTHER SPECIAL, INCIDENTAL OR CONSEQUENTIAL DAMAGES CAUSED BY THE USE, MISUSE OR INABILITY TO USE THIS PRODUCT, REGARDLESS OF THE LEGAL THEORY ON WHICH THE CLAIM IS BASED, AND EVEN IF SAMSUNG HAS BEEN ADVISED OF THE POSSIBILITY OF SUCH DAMAGES. NOR SHALL RECOVERY OF ANY KIND AGAINST SAMSUNG BE GREATER IN AMOUNT THAN THE PURCHASE PRICE OF THE PRODUCT SOLD BY SAMSUNG AND CAUSING THE ALLEGED DAMAGE. WITHOUT LIMITING THE FOREGOING, PURCHASER ASSUMES ALL RISK AND LIABILITY FOR LOSS, DAMAGE OR INJURY TO PURCHASER AND PURCHASER'S PROPERTY AND TO OTHERS AND THEIR PROPERTY ARISING OUT OF THE USE, MISUSE OR INABILITY TO USE THIS PRODUCT SOLD BY SAMSUNG NOT CAUSED DIRECTLY BY THE NEGLIGENCE OF SAMSUNG. THIS LIMITED WARRANTY SHALL NOT EXTEND TO ANYONE OTHER THAN THE ORIGINAL PURCHASER OF THIS PRODUCT, IS NONTRANSFERABLE AND STATES YOUR EXCLUSIVE REMEDY.

Some states do not allow limitations on how long an implied warranty lasts, or the exclusion or limitation of incidental or consequential damages, so the above limitations or exclusions may not apply to you. This warranty gives you specific legal rights, and you may also have other rights which vary from state to state.

To obtain warranty service, please contact SAMSUNG customer care center.

The benefits of this Limited Warranty extend only to the original purchaser of Samsung products from an authorized Samsung reseller. THIS LIMITED WARRANTY SHALL NOT APPLY TO ANY SAMSUNG PRODUCTS PURCHASED FROM UNAUTHORIZED RESELLERS OR RETAILERS, EXCEPT IN STATES WHERE SUCH RESTRICTION MAY BE PROHIBITED. For a list of Samsung authorized retailers, please go to:

http://www.samsung.com/us/peaceofmind/authorized_resellers.html.