



## User's Manual

---

1. Usage Notice

---

2. Introduction

---

3. Basic Operations

---

4. User Settings

---

5. LAN Control

---

6. Troubleshooting

---

7. Replacing the filter

---

8. Appendices

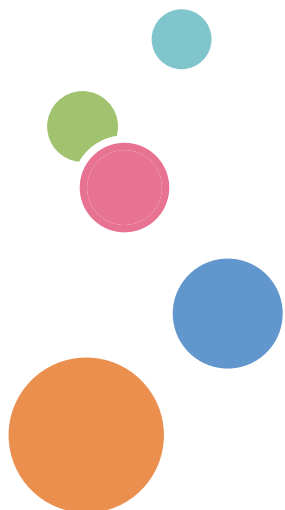

Read this manual carefully before you use this machine and keep it handy for future reference. For safe and correct use, be sure to read the Precautions in this manual before using the machine.

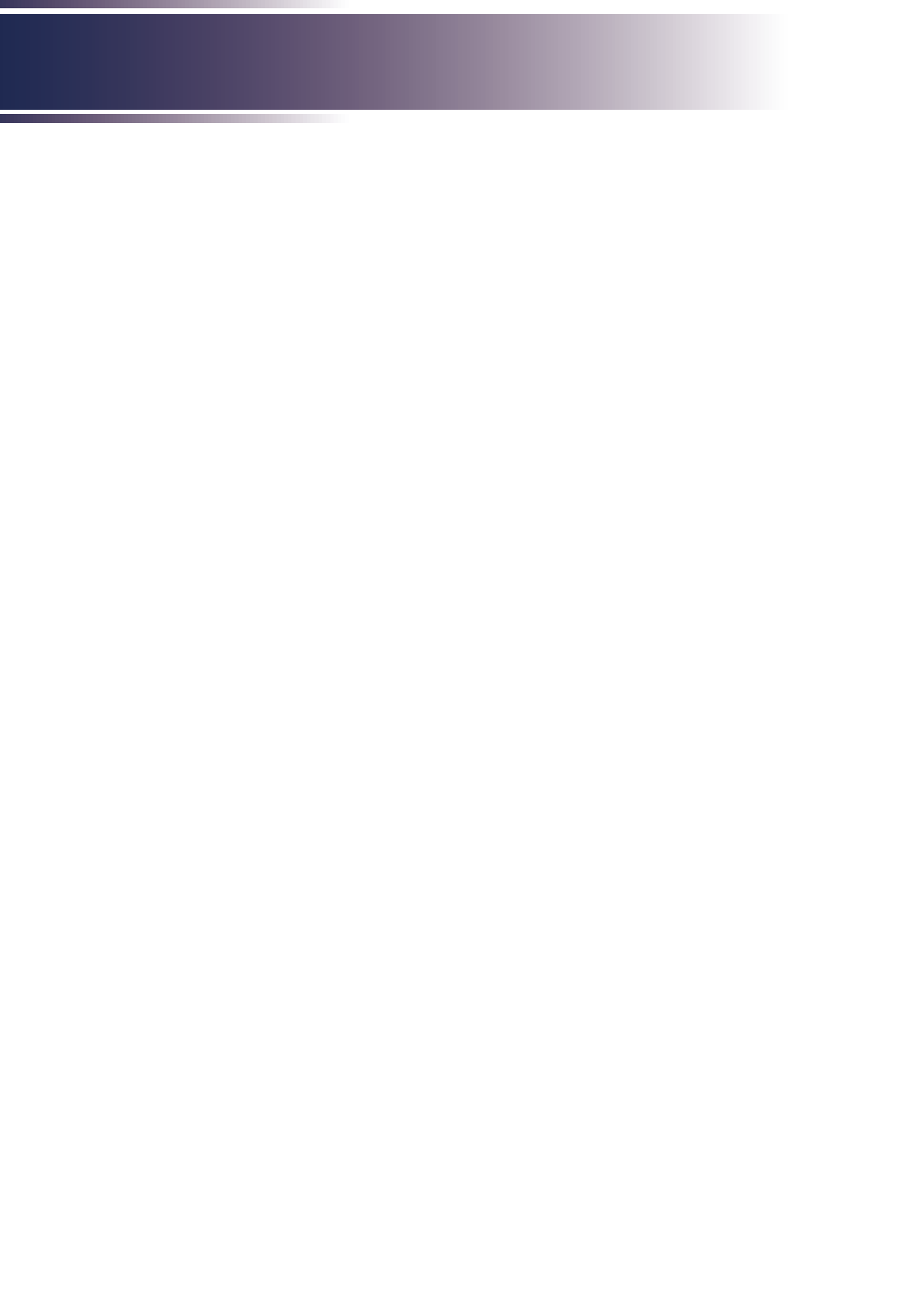

# Table of Contents

<b>Table of Contents</b> .....	<b>1</b>
<b>Usage Notice</b> .....	<b>3</b>
Precautions .....	3
Remote Control Battery.....	10
Laser safety caution .....	12
Laser Notice .....	12
Light Module .....	13
Safety Labels of This Machine .....	13
Regulation & Safety Notices.....	16
Air ventilation .....	21
Place your projector correctly .....	21
Power Switch Symbols .....	22
Other Information.....	23
Copyrights .....	23
<b>Introduction</b> .....	<b>24</b>
Package Overview.....	24
Product Overview.....	25
Connection Ports .....	27
Control Panel and Indicators.....	28
Remote Control .....	29
Installation of Remote Control Batteries .....	31
Remote Control Operating Range .....	32
Angle sensor .....	33
Installing the Projector .....	34
Connecting a Computer (Connect to Computer/Notebook) .....	35
<b>Basic Operations</b> .....	<b>35</b>
Connecting a Audio Device (Audio) .....	36
Connecting a USB Device .....	37
Powering On/Off the Projector .....	38
Powering on the Projector.....	38
Power off the projector.....	40
Input Source Signal Selection .....	41
Adjust the Projector Zoom function.....	42
Adjust the Projector Focus function.....	42
Adjust the Projector Lens shift function .....	43
Adjust the projected image .....	45
Adjust the position of the projected image .....	45

# Table of Contents

Adjust the screen size .....	46
<b>User Settings.....</b>	<b>47</b>
On Screen Display (OSD).....	47
How to operate the OSD .....	47
Image adjustment .....	48
Display Setting.....	51
Default settings .....	57
Audio .....	62
Options .....	63
USB Memory.....	67
Viewing via USB Memory.....	69
<b>LAN Control .....</b>	<b>71</b>
Controlling this Device with Web Browser.....	71
Connecting to the device.....	71
Access from the Web Browser.....	72
Login.....	72
System Status.....	72
General Setup .....	73
Picture Setup.....	73
Image Setup.....	74
Network Setup.....	75
Control the Projector via the Projector Management Utility .....	76
Installing Projector Management Utility.....	77
Control the projector with the projector Management Utility.....	79
<b>Troubleshooting .....</b>	<b>80</b>
<b>Cleaning the case &amp; lens .....</b>	<b>85</b>
Before Maintenance .....	85
Clean casing of your projector .....	85
Clean the projection window .....	85
Filter Cleaning and Replacement .....	86
Cleaning the filter.....	86
Replacing the filter .....	87
<b>Appendices .....</b>	<b>88</b>
List of Compatible Signals .....	88
Configurations of Terminals.....	91
Specifications .....	93
External Dimensions .....	95
Trademarks .....	96

## Precautions

*Follow all warnings, precautions and maintenance as recommended in this user's guide to maximize the life of your unit.*

- **Warning-** Indicates a potentially hazardous situation which, if instructions are not followed, could result in death or serious injury.
  
- **Caution-** Indicates a potentially hazardous situation which, if instructions are not followed, may result in minor or moderate injury or damage to property.
  - **Warning-** Do not place vases, plant pots, cups, toiletries, medicines, small metal objects, or containers holding water or any other liquids, on or close to this machine. Fire or electric shock could result from spillage or if such objects or substances fall inside this machine.
  - **Warning-** Do not use flammable sprays or solvents in the vicinity of this machine. Also, avoid placing these items in the vicinity of this machine. Doing so could result in fire or electric shock.
  - **Warning-** Keep the machine and attachments out of the reach of children. If the machine is near children, it may cause injury.
  - **Warning-** Plastic bags can be dangerous, please do not leave near babies and young children. To avoid the threat of suffocation, please keep away from their nose and mouth.
  - **Warning-** Do not use any power sources other than those that match the specifications shown in this manual. Doing so could result in fire or electric shock.
  - **Warning-** Do not damage, break, or modify the power cord. Also, do not place heavy objects on the power cord, or pull the cord or bend it severely. Doing so could result in fire or electric shock.
  - **Warning-** Touching the prongs of the power cable's plug with anything metallic constitutes a fire and electric shock hazard.
  - **Warning-** The supplied power cord is for use with this machine only. Do not use it with other appliances. Also, do

# Usage Notice

- not use power cord other than the one supplied with this machine. Doing so could result in fire or electric shock.
- Warning- It is dangerous to handle the power cord plug with wet hands. Doing so could result in electric shock.
  - Warning- Be sure to disconnect the plug from the wall outlet at least once a year and check for the following:
    - There are burn marks on the plug.
    - The prongs on the plug are deformed.If any of the above conditions exist, do not use the plug and consult your dealer or service representative. Use of the plug could result in fire or electric shock.
  - Warning- Be sure to disconnect the power cord from the wall outlet at least once a year and check for the following:
    - The power cord's inner wires are exposed, broken, etc.
    - The power cord's coating has a crack or dent.
    - When bending the power cord, the power turns off and on.
    - Part of the power cord becomes hot.
    - The power cord is damaged.If any of the above conditions exist, do not use the power cord and consult your dealer or service representative. Use of the power cord could result in fire or electric shock.
  - Warning- Do not use the connection cable if it is deformed, cracked, or damaged. Doing so could result in fire or electric shock. If the connection cable is deformed, cracked, or damaged, contact your service representative to request a replacement cable.
  - Warning- When using an extension cord or power strip, only connect equipment whose total power consumption is within the power rating for the extension cord or power strip. If the power rating is exceeded, it may cause heat buildup and result in fire.
  - Warning- If the machine emits smoke or odours, or if it behaves unusually, you must turn off its power immediately. After turning off the power, be sure to disconnect the power cord plug from the wall outlet. Then contact your service representative and report the problem. Do not use the machine. Doing so could result in fire or electric shock.

# Usage Notice

- Warning- If metal objects, or water or other fluids fall inside this machine, you must turn off its power immediately. After turning off the power, be sure to disconnect the power cord plug from the wall outlet. Then contact your service representative and report the problem. Do not use the machine. Doing so could result in fire or electric shock.
- Warning- Never operate this unit on AC power during a thunderstorm. If you see lightning or hear thunder, never touch the unit, cables and/or peripherals. An electric surge caused by the storm, may result in an electrical shock or damage to the unit.
- Warning- If the machine topples, or if a cover or other part gets broken, you must turn off its power immediately. After turning off the power, be sure to disconnect the power cord plug from the wall outlet. Then contact your service representative and report the problem. Do not use the machine. Doing so could result in fire or electric shock.
- Warning- Never push objects of any kind into this product through openings as they may touch dangerous voltage points or short-out parts that could result in a fire or electric shock. Never spill liquid of any kind on the product.
- Warning- Do not remove any covers or screws that are not mentioned in this manual. There are high voltage components inside the machine that may cause electric shock. Contact your service representative if any of the machine's internal components require maintenance, adjustment, or repair.
- Warning- Do not disassemble or modify the machine. Doing so may cause injury or malfunction.
- Warning- Installing the Projector on a Wall or Ceiling:
  - a) Do not attempt to clean or replace parts for a machine that is installed in a high location on a wall or ceiling. Doing so may cause it to fall down, resulting in an injury.
  - b) Contact your sales or service representative to clean or replace parts for a machine that is installed on a wall or ceiling.
  - c) If a machine is incorrectly installed on a wall or ceiling, it may fall down and cause an injury. Contact your sales or service representative if you want to install a machine on a wall or ceiling.

# Usage Notice

- d) Do not obstruct the machine's vents. Doing so risks fire caused by overheated internal components.
  - e) For users, do not install the projector by yourself. Contact your sales or service representative if you want to install the projector on a wall or ceiling.
  - f) For sales or service representatives:
    - Use brackets that are strong enough to support the projector. Projector's weight including lens is approx. 8.1kg.
    - The projector must be installed in a location that is sturdy enough to support the full weight of the projector and brackets.
    - Use only the M4 screws for fixing to the brackets. Use all four of the projector's screw holes to the brackets, and make sure the screws are tightened.
  - g) Do not use the projector in oil-mist or smoke environment. Doing so may cause the projector case to crack and fall from its ceiling mount. This may cause serious injury.
- Caution- Use the drop proof chain to prevent projector dropping:
    - a) Connect the safety bolt of the projector to the solid part of the building with a drop proof chain by using common tools.
    - b) Make sure to use a drop chain that can support the weight of the projector and the drop tool.
  - Caution- Keep the machine away from humidity and dust. Otherwise a fire or an electric shock might occur.
  - Caution- Do not place any objects on the machine. Doing so may cause the machine to topple over, possibly resulting in injury.
  - Caution- Do not place the machine on an unstable or tilted surface. If it topples over, an injury might occur.
  - Caution- Do not place the machine or use it in an environment where it might get wet such as from snow, rain, or being near water. Doing so could result in fire or electric shock.
  - Caution- Do not put your face or hand near the exhaust vents. Doing so could result in burns or an accident due to hot air coming from the exhaust vents.
  - Caution- Do not use the machine on soft material such as paper or cloth that might get sucked into the intake vents. Doing so may cause heat buildup inside the machine,



# Usage Notice

- Caution- resulting in malfunction, burns, or fire.  
Do not place the machine in a location where air flow is poor. Doing so may cause fire due to internal components becoming overheated.
- Caution- Do not place or store the machine in a location where direct sunlight or heat generation might occur. The heat may deform or wear out the exterior parts or negatively affect internal parts. Doing so could result in fire.
- Caution- Do not place low heat resistant material near the exhaust vents. Hot air may come from the exhaust vents, resulting in damage to the machine or an accident.
- Caution- Do not obstruct the machine's vents. Doing so risks fire caused by overheated internal components.
- Caution- Push the power plug all the way into the power outlet. Do not use a power outlet with a loose connection. Doing so may result in heat buildup. Plug the power cord in the correct direction into the base. If they are not plugged in correctly, it could result in smoke, fire, or electric shock.
- Caution- If this machine is not going to be used for several days or longer at a time, disconnect its power cord from the wall outlet.
- Caution- When disconnecting the power cord from the wall outlet, always pull the plug, not the cord. Pulling the cord can damage the power cord. Use of damaged power cords could result in fire or electric shock.
- Caution- Be sure to disconnect the plug from the wall outlet and clean the prongs and the area around the prongs at least once a year. Allowing dust to build up on the plug constitutes a fire hazard.
- Caution- When performing maintenance on the machine, always disconnect the power cord from the wall outlet.
- Caution- Do not place the power cord and connection cable in a way that might cause someone to trip and fall. The machine might fall over and cause an injury.
- Caution- The machine may be very hot after it is turned off, especially the vents.
- Caution- Do not place the machine on other equipment or vice versa. Doing so may cause heat buildup inside the machine or cause the other equipment to malfunction.

# Usage Notice

- Caution- Do not increase the volume unless you are listening while increasing the volume. Also, lower the volume before turning off the power, because a loud sound may be emitted when the power is turned on and cause hearing damage.
- Caution- If the machine's interior is not cleaned regularly, dust will accumulate. Fire and breakdown can result from heavy accumulation of dust inside this machine. Contact your sales or service representative for details about and charges for cleaning the machine's interior.
- Caution- Unplug the power cord from the wall outlet before you move the machine. While moving the machine, take care that the power cord is not damaged under the machine. Failing to take these precautions could result in fire or electric shock.
- Caution- Do not use attachments not recommended by RICOH. Use of an incompatible attachments could cause hazards or damage to the product.
- Caution- Unplug this product from the wall outlet and take the product to qualified service personnel if you encounter any of the following conditions:
  - a) The power supply cord or plug is damaged.
  - b) Liquid has been spilled, or objects have fallen into the product.
  - c) The product has been exposed to rain or water.
  - d) The product does not operate normally when following the operating instructions. Adjust only those controls that are covered by the operating instructions.
  - e) The product has been dropped or damaged in any way. (If the cabinet should break, please handle with care to avoid injury.)
- Caution- This product incorporates glass components, including a lens. If this should break, please handle with care to avoid injury and contact your sales representative for repair service. Avoid any broken pieces of glass since they may cause injury.
- Caution- Do not place anything in front of the lens while the projector is operating. Things placed in front of the lens may overheat and burn or start a fire.
- Caution- Unauthorized substitutions may result in fire, electric shock, or other hazards.  
Upon completion of any service or repairs to this product, ask the service technician to perform safety

# Usage Notice

checks to verify that the product is in proper operating condition.

- **Caution-** Do not use the product in a closed installation location. Do not place the product in a box or in any other closed installation location. Otherwise it may overheat, which could result in a risk of fire.
- **Warning-** Do not look into the lens or vent when the product is on. The bright light may damage your eyes. Be especially careful in an environment with children.
- **Caution-** Do not block the projection light when it is on. If you do so, the part that is blocking the projection light may get quite hot and deform, deteriorate or cause a burn or fire. The reflected light may make the lens hot and cause a product failure. To temporarily suspend projection, select the mute function. To suspend longer, turn off the product.
- **Caution-** Be sure to reserve proper space at the top, sides, and rear of the shell for ventilation and projector cooling. The following figure shows minimum distances to be reserved. If the projector is placed in a cabinet or an enclosed environment, the requirements for minimum distances must be satisfied.

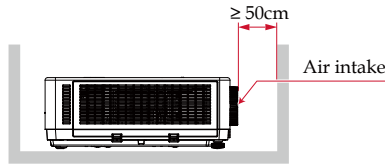
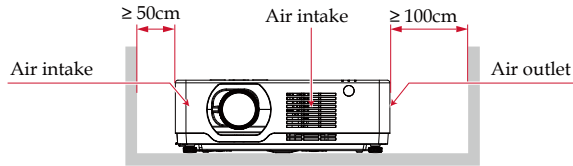

- **Caution-** Do not block the ventilation holes to prevent overheating.

# Usage Notice

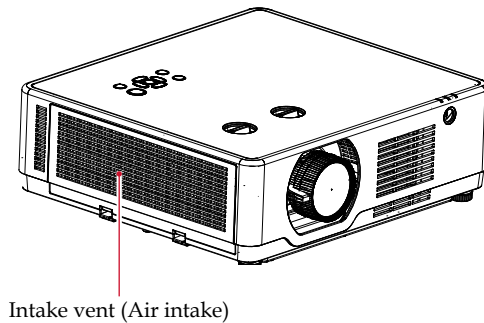
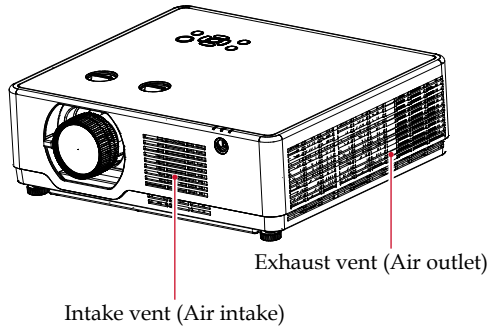

## Remote Control Battery

### Warning

- Do not touch the battery directly with bare hands if it leaks. If the liquid gets into your eyes, do not rub them. It may cause blindness. Immediately wash with clean water and consult a doctor.
- Never throw batteries into a fire.  
Using the batteries improperly may cause them to explode or leak and may result in serious injury. If battery-leaking fluid contacts skin, wash the fluid off immediately with clean water and consult a doctor. If the fluid spills on an instrument, avoid contact and wipe it off using tissue paper. Then dispose of the used tissue paper as flammable garbage after moistening the tissue with water.
- Keep new and used batteries away from children.  
If the battery compartment does not close securely, stop using the product and keep it away from children. If you think batteries might have been swallowed or placed inside any part of the body, seek immediate medical attention.
- Do not mix new batteries with used batteries, old batteries, or

# Usage Notice

batteries of different types. Otherwise, fluid leakage may occur.

- Risk of an explosion if battery is replaced by an incorrect type.
- Remove the batteries from the remote control when they are used up. Otherwise, fluid leakage may occur.

## Notes

- Be sure to use AAA/R03 size batteries.
- Dispose of batteries in a designated disposal area.
- Attention should be drawn to the environmental aspects of battery disposal.
- If the remote control does not operate correctly, or if the operating range becomes reduced, replace the batteries.
- Avoid contact with water or liquid.
- Do not expose the remote control to moisture or heat.
- Do not drop the remote control.
- If the batteries have leaked in the remote control, carefully wipe the case clean and install new batteries.
- Dispose of used batteries according to the instructions.
- The remote control may fail to operate if the infrared remote sensor is exposed to bright sunlight or fluorescent lighting.

**Important:**

*Contents of this manual are subject to change without prior notice. In no event will the company be liable for direct, special, incidental, or consequential damage as a result of handing or operating this product.*

## Laser safety caution



### WARNING

- The laser module is equipped in this product. Use of controls or adjustments of procedures other than those specified herein may result in hazardous radiation exposure.
- This product is classified as Class 1 of IEC 60825-1 Third edition (2014) and RG2 of IEC/EN62471-5 First edition. Obey the laws and regulations of your country in relation to the installation and management of the device.
- Regarding the installation and management of the equipment, please comply with the relevant laws and regulations of your country.
- Outline of laser emitted from the built-in light module:  
Wavelength: 455 nm  
Maximum power: 105W
- Radiation pattern from the protective housing:  
Wavelength: 455 nm  
Maximum laser output: : 333mW
- The laser module is equipped in this product. Use of controls or adjustments of procedures other than those specified herein may result in hazardous radiation exposure.

## Laser Notice

IEC 60825-1:2014, EN 60825-1:2014+A11:2021: CLASS 1 LASER  
PRODUCT - RISK GROUP 2.

The product's intended use as a consumer laser product and  
compliant with EN 50689:2021.

CLASS 1 CONSUMER LASER PRODUCT

EN 50689:2021

## Light Module

- A light module containing multiple laser diodes is equipped in the product as the light source.
- These laser diodes are sealed in the light module. No maintenance or service is required for the performance of the light module.
- End user is not allowed to replace the light module.
- Contact qualified distributor for light module replacement and further information.

## Safety Labels of This Machine

1. Do not look into the lens while the light source is on. The strong light from the light source may cause damage to your eyesight.
2. Do not place anything in front of the lens while the projector is operating. Things placed in front of the lens may overheat and burn or start a fire. If you want to temporarily stop the projected image, use the AV mute on the remote control.
3. Laser aperture warning:
  - CLASS 1 LASER PRODUCT - RISK GROUP 2 IEC62471-5:2015
  - Do not stare into the beam, maybe harmful to the eyes.
  - Do not look into the light source light using optical instruments (such as magnifying glasses and mirrors). Visual impairment could result.
  - When turning on the projector, make sure no one within projection range is looking at the lens.

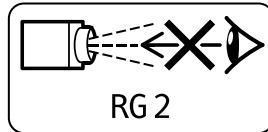

- Keep any items (magnifying glass etc.) out of the light path of the projector. The light path being projected from the lens is extensive, therefore any kind of abnormal objects that can redirect light coming out of the lens, can cause an unpredictable outcome such as a fire or injury to the eyes.
  - Do not remove any screws. Do not block or cover the vents.
4. Do not remove any screws. Do not block or cover the vents.
  5. WARNING: MOUNT ABOVE THE HEADS OF CHILDREN. (For USA and Canada only)

The use of a ceiling mount is recommended with this product to place it above the eyes of children.

# Usage Notice

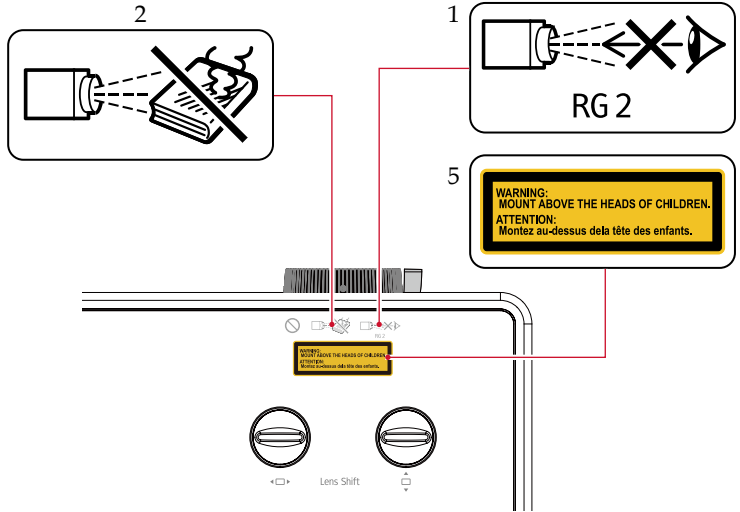

**3**

CLASS 1 CONSUMER LASER PRODUCT - BE 60825-1-2014, EN60824-1-2014+A11-2021, EN60889-2021  
 RPPANEL A LASER CONSOMMATEUR DE CLASSE 1- BE 60825-1-2014, EN60824-1-2014+A11-2021, EN60889-2021

for USA / pour les USA

This device complies with Part 15 of the FCC Rules. Operation is subject to the following two conditions:  
 (1) this device may not cause harmful interference, and (2) this device must accept any interference received,  
 including interference that may cause undesired operation.

for Europe / pour l'Europe

Importer (USA making Prod): FUJIFILM AMERICA, INC. 100 Corporate Park Drive Berkeley, CA 94710 FUJIFILM AMERICA, INC. 100 Mont Road, Uxbridge, UK	Apparatet skal anvendes til private brug. Apparatet må ikke bruges offentligt. Dette er et laserprodukt og skal bruges forsigtigt. Apparatet skal bruges på sikker afstand med jule. som gælder for alle laserprodukter.	
--	--	---

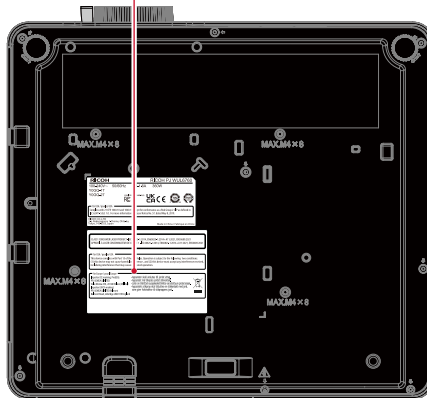



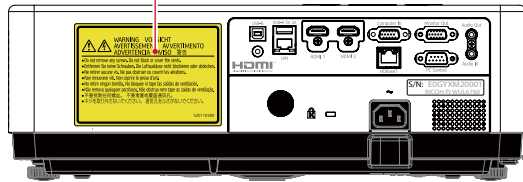

## Regulation & Safety Notices

This appendix lists the general notices of your Projector.

### *Notice: Users in the United States of America FCC notice*

MODEL NAME: RICOH PJ WUL6760

TRADE NAME: PROJECTOR  
MODEL NAME: RICOH PJ WUL6760  
Tested To Comply with FCC Standards  
FOR HOME OR OFFICE USE

This device complies with Part 15 of the FCC Rules. Operation is subject to the following two conditions:

1. This device may not cause harmful interference and
2. This device must accept any interference received, including interference that may cause undesired operation.

NOTE: This equipment has been tested and found to comply with the limits for a Class A digital device, pursuant to Part 15 of the FCC Rules. These limits are designed to provide reasonable protection against harmful interference when the equipment is operated in a commercial environment. This equipment generates, uses, and can radiate radio frequency energy and, if not installed and used in accordance with the instruction manual, may cause harmful interference to radio communications. Operation of this equipment in a residential area is likely to cause harmful interference in which case the user will be required to correct the interference at his own expense.

- Caution- Changes or modifications not expressly approved by the party responsible for compliance could void the user's authority to operate the equipment.

RESPONSIBLE PARTY: PFU America, Inc.  
3900 Freedom Circle, Suit 240, Santa Clara, CA 95054  
Telephone number: (408)992-2900

# Usage Notice

## ***Notice: Shielded cables***

All connections to other computing devices must be made using shielded cables to maintain compliance with FCC regulations.

## ***Caution***

Changes or modifications not expressly approved by the manufacturer could void the user's authority, which is granted by the Federal Communications Commission, to operate this projector.

## ***Notes to Users in the State of California***

Perchlorate Material - special handling may apply,

See [www.dtsc.ca.gov/hazardouswaste/perchlorate](http://www.dtsc.ca.gov/hazardouswaste/perchlorate).

## ***Notes to Users in Canada***

The Class A digital apparatus meets all requirements of the Canadian Interference-Causing Equipment Regulation. Interference-Causing Equipment Regulation.

# Usage Notice

## ***Declaration of Conformity for EU countries***

- EMC Directive 2014/30/EU (including amendments)
- Low Voltage Directive 2014/35/EU

## ***Notice: Users in EU countries CE Marking Traceability Information (For EU Countries Only)***

Manufacturer:

Ricoh Co., Ltd.

3-6 Nakamagome 1-chome, Ohta-ku, Tokyo. 143-8555, Japan

Importer:

PFU (EMEA) LIMITED Viale Monza 259, 20126 Milano (MI) Italy

## ***Notice: Users in UK UKCA Marking Traceability Information (For UK Only)***

Manufacturer:

Ricoh Co., Ltd.

3-6 Nakamagome 1-chome, Ohta-ku, Tokyo. 143-8555, Japan

Importer:

PFU (EMEA) LIMITED Belmont, Belmont Road, Uxbridge UB8  
1HE England

## ***User Information on Electrical and Electronic Equipment***

Users in the countries where this symbol shown in this section has been specified in national law on collection and treatment of E-waste.

Our Products contain high quality components and are designed to facilitate recycling.

Our products or product packaging are marked with the symbol below.

# Usage Notice



This product contains substances which are harmful to humans and the environment.

The symbol indicates that the product must not be treated as municipal waste. It must be disposed of separately via the appropriate return and collection systems available. By following these instructions you ensure that this product is treated correctly and help to reduce potential impacts on the environment and human health, which could otherwise result from inappropriate handling. Recycling of products helps to conserve natural resources and protect the environment.

For more detailed information on collection and recycling systems for this product, please contact the shop where you purchased it, your local dealer or sales/service representatives.

## *Notice: Users in Turkey*

AEEE Yönetmeliğine Uygundur.

Bu sistem sarf malzemeleri ve yedek parçaları da dahil olmak üzere AEEE Yönetmeliğine Uygundur.

## *All Other Users*

If you wish to discard this product, please contact your local authorities, the shop where you bought this product, your local dealer or sales/service representatives.

## *Laser Notice*

IEC 60825-1:2014, EN 60825-1:2014+A11:2021: CLASS 1 LASER PRODUCT - RISK GROUP 2.

The product's intended use as a consumer laser product and compliant with EN 50689:2021.

CLASS 1 CONSUMER LASER PRODUCT

EN 50689:2021

# Usage Notice

*Warning*

*This equipment is compliant with Class A of CISPR 32. In a residential environment this equipment may cause radio interference.*

*Properly shielded and grounded cables and connectors must be used for connections to a host computer (and/or peripheral) in order to meet emission limits.*

## ***Notice: Users in the EU and the UK Note for the Battery and/or Accumulator Symbol***



In accordance with the Battery Directive 2006/66/EC Article 20 Information for end-users Annex II, the above symbol is printed on batteries and accumulators. This symbol means that in the European Union, used batteries and accumulators should be disposed of separately from your household waste.

In the EU, there are separate collection systems for not only used electrical and electronic products but also batteries and accumulators. Please dispose of them correctly at your local community waste collection/recycling centre.

## ***COMMISSION REGULATION (EU) 2019/2020***

The light source of this product is not intended for applications other than image projection.

## Air ventilation

Openings in the casing are designed for ventilation and overheating prevention. **DO NOT** block or cover these openings to keep your projector in normal operation and from overheating.



Note:

Heat exhaust at the air outlet Keep the following in mind when using or installing your projector:

- **DO NOT** place flammable materials or sprayers near your projector.
- Keep the air outlet one meter away from other objects.
- **DO NOT** touch the area close to the air outlet especially the metal components, e.g. screws. This area and parts will get very hot once your projector starts operating.
- **DO NOT** place any object atop your projector. They may not only be damaged but also lead to fire after being overheated.

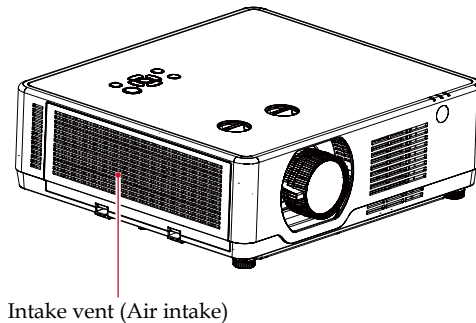
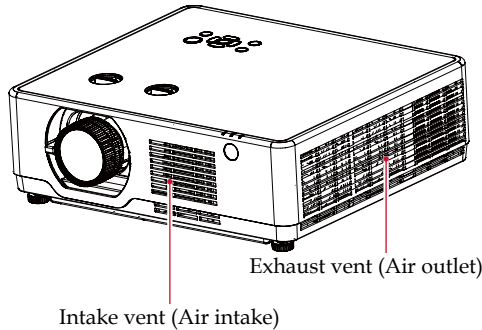

## Place your projector correctly

Use your projector at specified location in correct way. Invalid projector location may shorten light source 's life-cycle or even lead to severe incidents or fire.

# Usage Notice

## Power Switch Symbols

The meaning of the symbols for the switches on this machine as follows:



: On/Standby(Off)



## Other Information

### Copyrights to Images

When projecting images using the projector, be careful not to infringe the copyright of protected materials. The following are examples that may infringe the copyright of protected materials.

- Broadcasting images or movies for commercial purposes
- Modifying images or movies using functions such as freeze, magnify, or zoom to broadcast images for commercial purposes or public viewing
- Varying the aspect ratio of images or movies using a function that changes the screen size to broadcast images for commercial purposes or public viewing

## Copyrights

This projector uses open source and/or third party software. To check the information about software copyrights, see 'Options' - 'Information' - 'License' in the MENU.

You can also view and download the source code from:  
[http://www.support-download.com/bb/html/direct\\_e/oss/index.htm](http://www.support-download.com/bb/html/direct_e/oss/index.htm)

**CAUTION:**

- *When connecting to a LAN, be sure to read and understand the security risks described in the manual and use the unit as safe as possible.*

# Introduction

## Package Overview

*The projector is provided with the following accessories. Make sure that everything is included in the package. If anything is missing, contact your dealer immediately.*

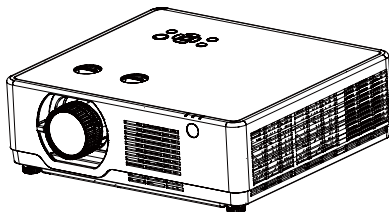

Projector



Remote control &  
AAA/R03 battery x2

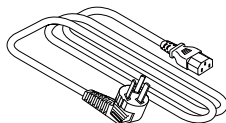

Power Cord (1.8m)

\* Models for Europe are packed with two different codes, one for EU and one for UK.

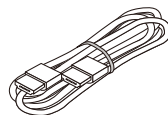

HDMI cable (1.5m)

Documents:

Quick start guide

## Product Overview

Front/Top/Side

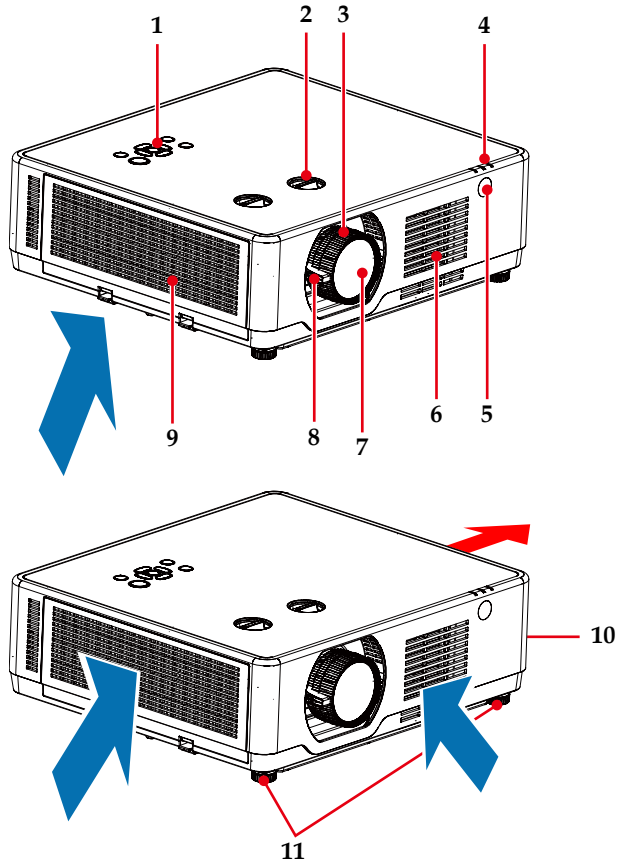

- |                        |                        |
|------------------------|------------------------|
| 1. Control panel       | 7. Projection window   |
| 2. Lens shift dial     | 8. Zoom lever          |
| 3. Focus ring          | 9. Filter (Air intake) |
| 4. Indicator           | 10. Air intake         |
| 5. Front Remote Sensor | 11. Adjustment feet    |
| 6. Air intake          |                        |

# Introduction

## Rear

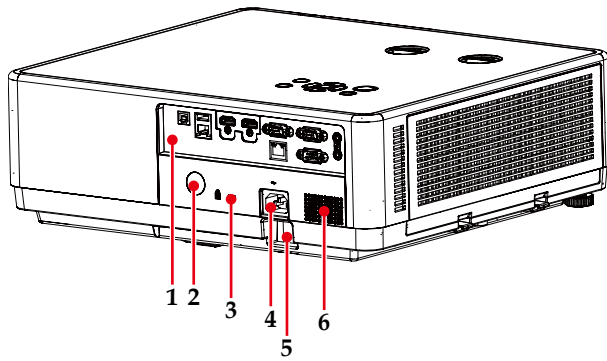

- |                               |                                      |
|-------------------------------|--------------------------------------|
| 1. Connection ports           | 5. Safety bar (for fixing with wire) |
| 2. Rear Remote Sensor         | 6. Speaker (16W*1)                   |
| 3. Built-in Security Slot (R) |                                      |
| 4. Indicator                  |                                      |

## Connection Ports

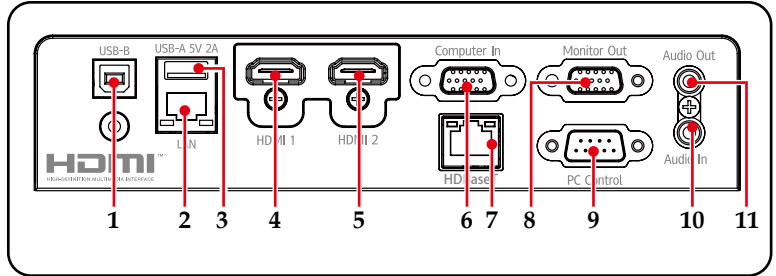

1. USB-B terminal
2. LAN terminal
3. USB-A terminal (5V/2A)
4. HDMI1 In terminal
5. HDMI2 In terminal
6. Computer In terminal
7. HDBaseT terminal (\*)
8. Monitor Out terminal
9. PC-Control terminal
10. Audio In terminal
11. Audio Out terminal

## Control Panel and Indicators

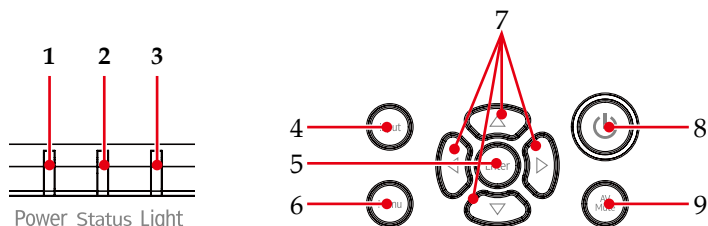

1	Power indicator	This indicator informs the power status of the projector.
2	Status indicator	This indicator lights/blinks when a button is pressed while the key lock function is utilized, or while performing the specific operations.
3	Light indicator	This indicator informs the state of light source, used time of the light source.
4	Input	Select the input source.
5	Enter button	Select or confirm settings.
6	Menu	Press “Menu” to launch the on screen display (OSD), or go back to the previous menu. (See page 47)
7	Four directional key	Use ▲, ▼, ◀ or ▶ to select items or make adjustments to your selection.
8	Power 	Refer to the “Power On/Off the Projector” section. (See page 38~40)
9	AV Mute	Pause the audio and video

### Note

❖ For detail indicator, please see page 82.

## Remote Control

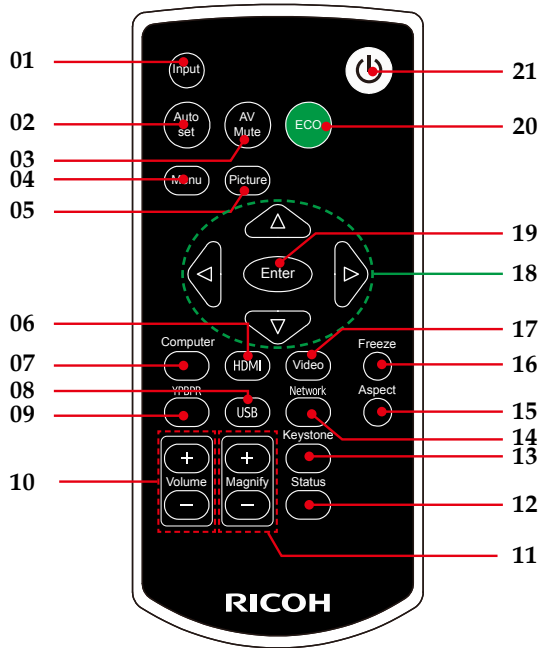

1	Input	Press "Input" to choose your desired input source.
2	Auto set	Automatically synchronize the projector to the input source.
3	AV Mute	Momentarily turn off/on the audio and video.
4	Menu	Press "Menu" to launch the On Screen Display (OSD), back to the top level of OSD for the OSD main menu operation. (See page 47)
5	Picture	Select the preset picture mode.
6	HDMI	Press "HDMI" to choose HDMI1 and HDMI2 source.

# Introduction

7	Computer	Press “Computer” to choose Computer In terminal.
8	USB	Press “USB” to choose Memory Viewer as input source.
9	YPBPR	This button is not supported with this machine.
10	Volume +/-	Increase or decrease speaker volume.
11	Magnify +/-	- Zoom in or out the projector display image. - Magnified area can be moved by four directional keys.
12	Status	Display the projector status.
13	Keystone	Adjust the image to compensate for distortion caused by tilting the projector.
14	Network	This button is not supported with this machine.
15	Aspect	Use this function to choose your desired aspect ratio.
16	Freeze	Pause the screen image. Press again to resume the screen image.
17	Video	This button is not supported with this machine.
18	Four Directional Select Keys	Use ▲, ▼, ◀, or ▶ to select items or make adjustments to your selection.
19	Enter	Confirm your section of items in sub menu operation.
20	ECO	Use this function to choose your desired Light Source Power Mode. (See page 53)
21	Power	Refer to the “Power On/Off the Projector” section. (See page 38~40)



## Installation of Remote Control Batteries

- 1 Push the clip to release the battery cover.
- 2 Install new batteries (AAA/R03 or LR03). Ensure that you have the batteries' polarity (+/-) aligned correctly.

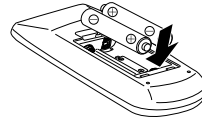
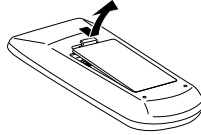

- 3 Close the battery cover and press it down until it clicks into place. Do not mix different types of batteries or new and old batteries.

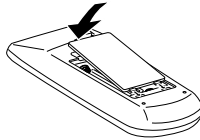

For safe operation, note the following precautions:

- Use two AAA/R03 or LR03 batteries.
- Keep the remote control away from water or other liquid.
- Do not place the remote control in an overly hot or humid place.
- Do not drop the remote control.
- Do not use a new battery and a used one at the same time.
- Using a different battery than specified in this manual may cause an explosion.
- Handle used batteries according to instructions on the battery or local regulations or guide.
- Remove the batteries when the remote control will not be used for a long time.
- An infrared remote control may not work if it is exposed to strong light or fluorescent light.
- If battery liquid leaks in the remote control, carefully clean the battery holder before installing new batteries.
- Keep batteries out of the reach of children. (Children may swallow or choke on the batteries. If this happens, contact a doctor immediately.)

## Remote Control Operating Range

Point the remote control at the remote control sensing windows (front and rear) on the projector.

When the remote control is pointed at the signal receiver on the projector, the effective range of the remote control is an area of radius 7 meters or about 8 meters in straight line from the receiver.

The remote control is effective within vertical and horizontal  $\pm 15^\circ$  to the receiving direction of the remote control signal receiver. When the angle exceeds this range, the effective control distance will be reduced.

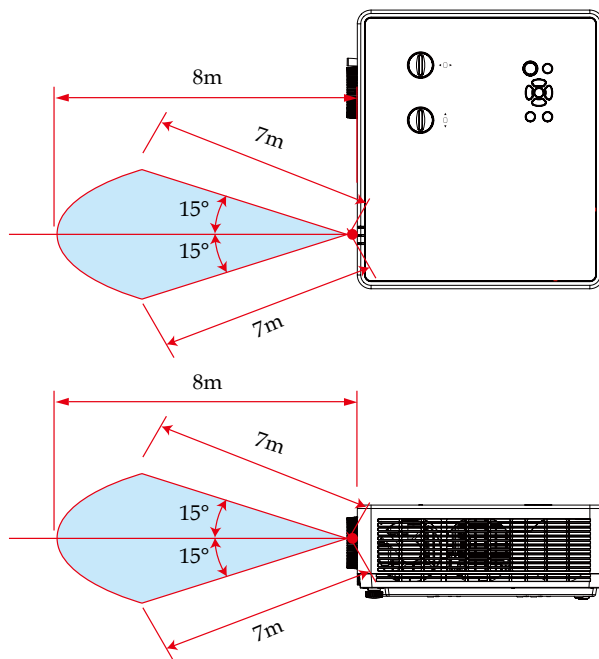

## Angle sensor

The installation angle range that the built-in angle sensor of the projector can detect is shown in the figure below.

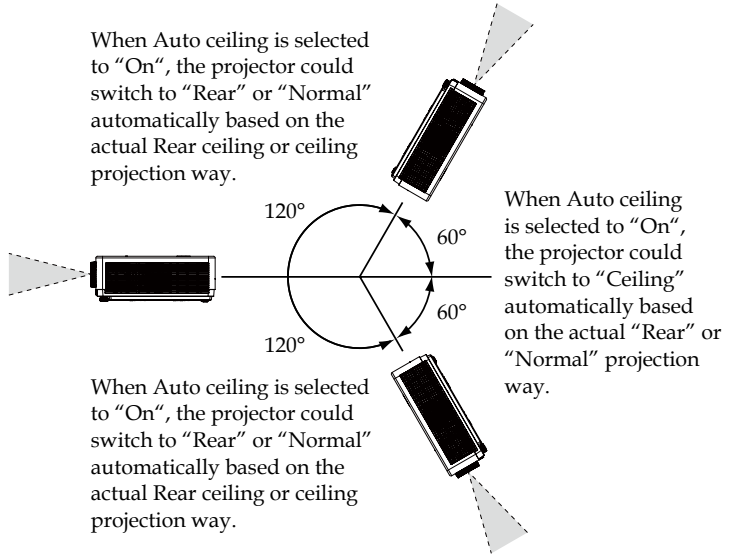

## Installing the Projector

When you select a position for the projector, consider the size and shape of your screen, the location of your power outlets, and the distance between the projector and the rest of your equipment. Follow these general guidelines:

### Note

- ❖ When using a LAN, use the network separated by a firewall to prevent unauthorized access from the Internet.
  - ❖ Pay careful attention to the installation location, management of the devices, and the network device to which the device is connected, in order to prevent malicious third parties from viewing the communication data.
  - ❖ Pay careful attention to the installation location and management of the devices, in order to prevent unauthorized tampering by a malicious third party who can operate the devices.
- ❖ Position the projector on a flat surface at a right angle to the screen. The projector (with the standard lens) must be at least 4.3 feet (1.3 m) from the projection screen.
  - ❖ Position the projector to the desired distance from the screen. The distance from the lens of the projector to the screen, the zoom setting, and the video format determine the size of the projected image.

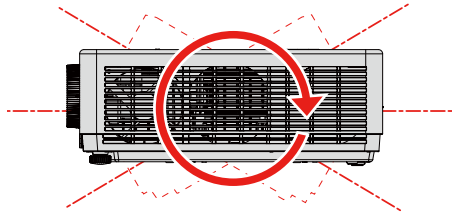

Vertical 360°

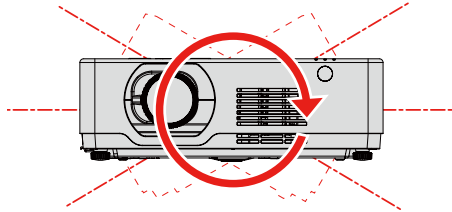

Horizontal 360°



Vertical & Horizontal 360°

# Basic Operations

## Connecting a Computer (Connect to Computer/ Notebook)

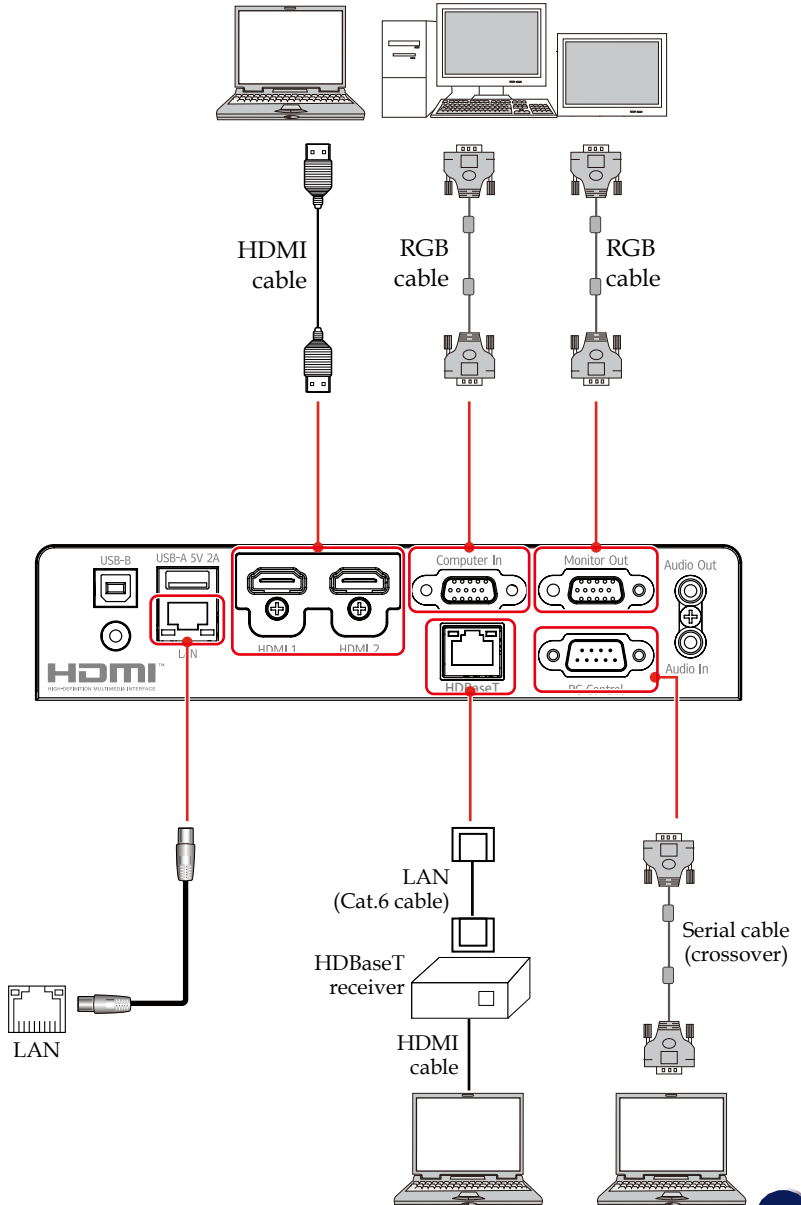

### Note

❖ To ensure the projector works well with your computer, please make sure the timing of the display mode is compatible with your projector. (See page 88~90)

# Basic Operations

## Connecting a Audio Device (Audio)

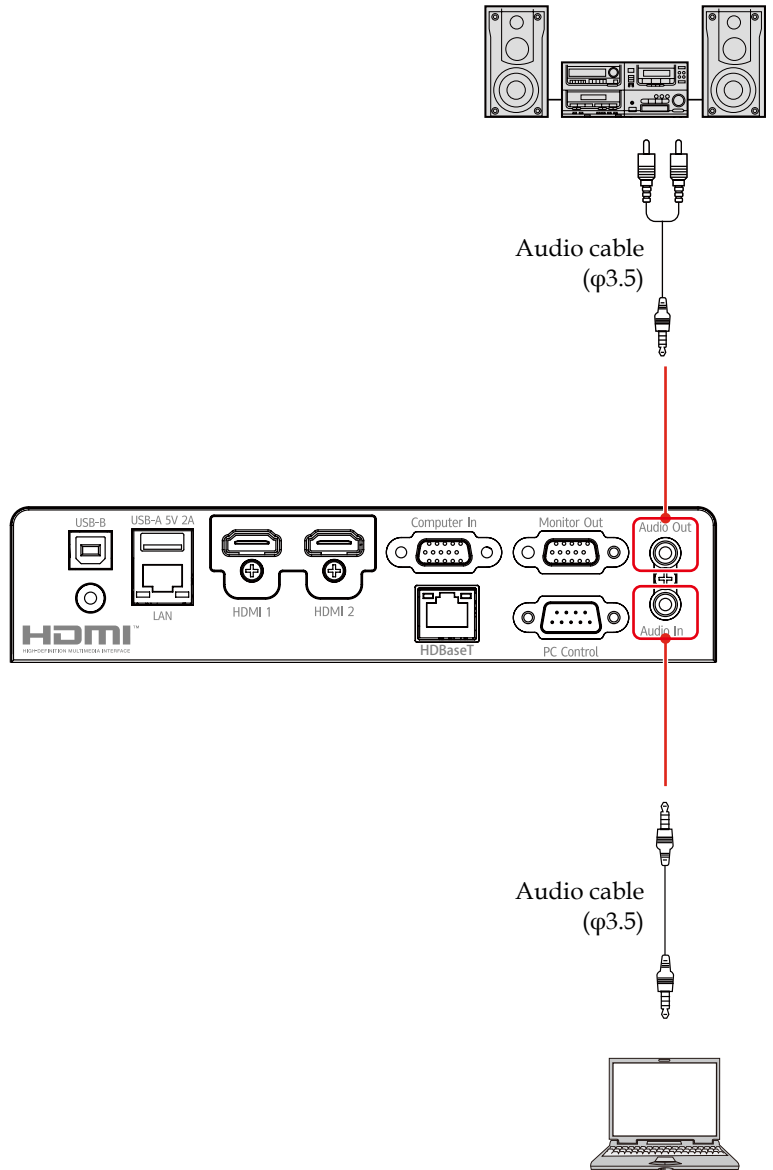

# Basic Operations

## Connecting a USB Device

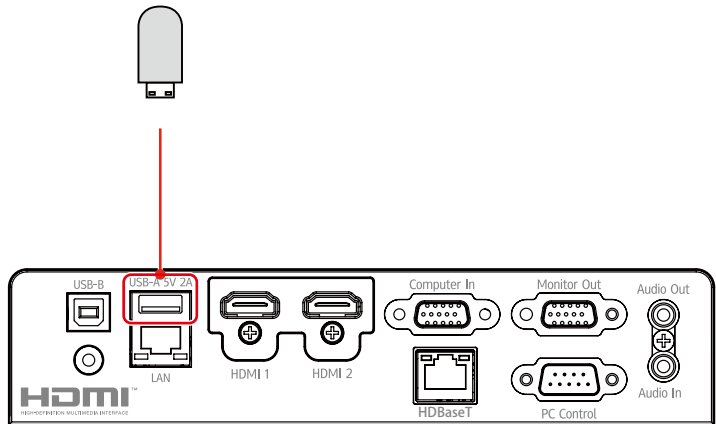

# Basic Operations



## Powering On/Off the Projector

### Powering on the Projector

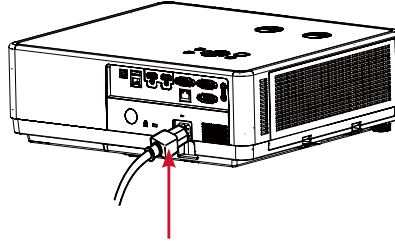
1. Ensure that the power cord and signal cable are securely connected. The Power indicator will flash orange.



Connect the AC power cord to the projector.

2. Turn on the projector by pressing the “” button on the control panel or the “” button remote control. The Power indicator will flash orange when standby power is set to “ECO”.

The startup screen will display and the Power indicator will turn blue and the Light indicator will turn or blink green.

3. The first time you use the projector, you will be asked to select the preferred language. Turn on your source (computer, notebook, video player, etc.) The projector will detect your source automatically.

Make sure that the “Auto Source” has been set to “On”.

#### Note

- ❖ Make sure that the power plug is fully inserted into both the projector AC inlet and the wall outlet.
- ❖ The AC outlet must be near this equipment and must be easily accessible.

#### Note

- ❖ If you connect multiple sources at the same time, press “Input” to switch inputs.

#### Note

- ❖ Turn on the projector first and then the signal sources.

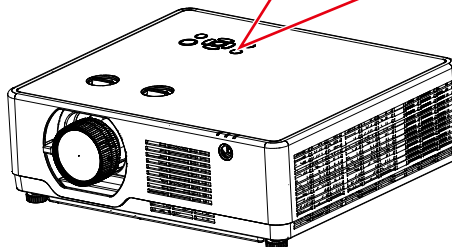
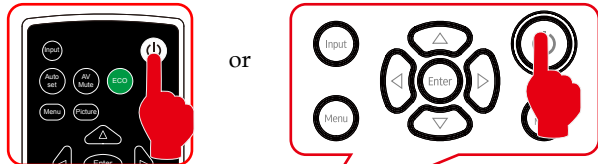





# Basic Operations

**CAUTION:**

- *Do not look into the lens while the light source is on. The strong light from the lens may cause damage to your eyesight.*
- *Do not block the air intake or exhaust. Doing so could cause a fire due to internal overheating.*
- *Do not place your hands, face, or other objects near the air exhaust. Doing so could result in injury and/or damage the object.*

# Basic Operations



## Power off the projector

1. Press the “” button on the control panel or the “” button on the remote control. The following dialog box will pop up.



### Note

❖ When the Power indicator flashes green, the light source is cooling down, and the projector cannot be turned on at this moment. When the Power indicator glows red steadily, the projector can be turned on again.

2. Press the “” or “” button again. The projector will shut down.
  - The Power indicator will blink orange when the projector goes to standby mode.
3. Unplug the power cord out of the socket and projector connector.

## Input Source Signal Selection

### Basic Operations

Press the Input button on the remote control or the control panel and choose Computer, HDMI1, HDMI2 or Memory Viewer as the input source.

#### Note

❖ You can also change the input source by direct keys on the remote control.

### Menu operation

- 1) Press the Input  button on the remote control to enter the input source menu.
- 2) Press ▲▼ buttons to choose Computer, HDMI1, HDMI2 or Memory Viewer and press Enter to select the input source.

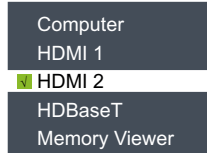

### Computer

If the input source is a computer that connects to Computer In port with a RGB cable, choose "Computer".

### HDMI1

If the input source is a device that connects to the HDMI 1 In terminal with an HDMI cable, choose "HDMI 1".

#### Note

- ❖ Automatic search does not support "Memory Viewer".
- ❖ When the signal source is "Memory Viewer", Still, Scale, Auto setting and Image functions are unavailable.

### HDMI 2

If the input source is a device that connects to the HDMI 2 In terminal with an HDMI cable, choose "HDMI 2".

### Memory Viewer

If the input source is a device that connects to the USB terminal, choose Memory Viewer.  
To use Memory Viewer, see page 69 for instruction.

### HDBaseT

Select input HDBaseT if a device is connected to the HDBaseT terminal

# Basic Operations

## Adjust the Projector Zoom function

Use the Zoom lever to adjust the image size on the screen.

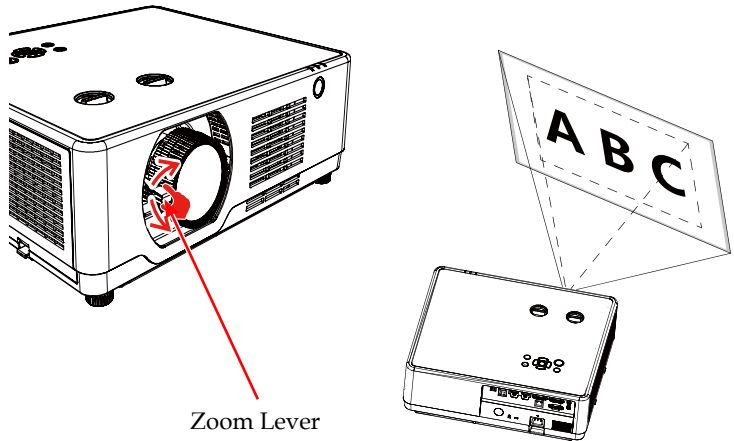

## Adjust the Projector Focus function

Use the Focus ring to obtain the best focus.

### Note

- ❖ The image is not stable immediately after the projector is turned on. Adjust the image at least 30 minutes after the projector is turned on.
- ❖ The projected image becomes unsharp when Keystone correction is enabled. This is a limitation of digital correction.

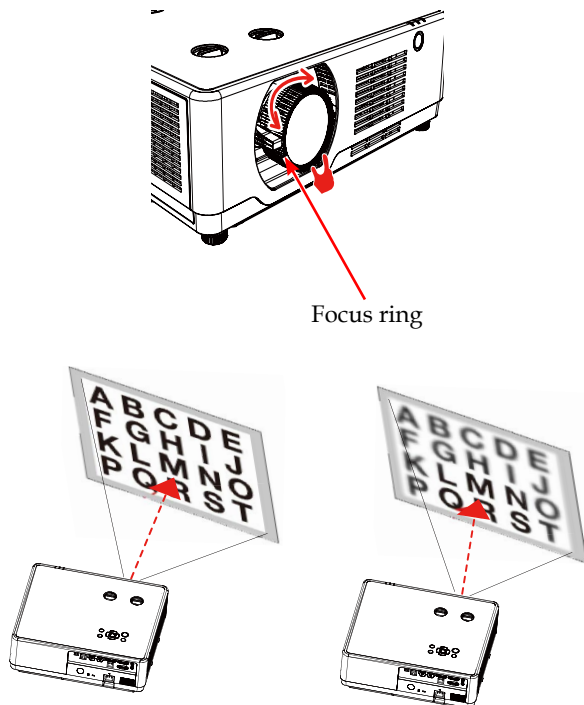

# Basic Operations

## Adjust the Projector Lens shift function

### Note

❖ After turning the lens shift dial to align the projection position, turn the lens shift dial slightly to the opposite side to loosen it.

❖ If the lens shift dial is stopped at the aligned position, the lens shift position may drift due to vibrations or environmental temperature.

❖ Keep hands away from the lens mounting portion while performing a lens shift. Failure to do so could result in fingers being pinched by the moving lens.

❖ The image is not stable immediately after the projector is turned on. Adjust the image at least 30 minutes after the projector is turned on.

❖ The projected image becomes unsharp when Keystone correction is enabled. This is a limitation of digital correction.

Use the Zoom lever to adjust the image size on the screen.

Rotate the ① and ② dial to make Lens shift adjustment manually.

Rotate ① dial, then you can move upward and downward the image with a distance up to 60% between the upper and lower range of the image.

Rotate ② dial, then you can move rightward and leftward the image with a distance up to -29% ~ +29% of the width of the image.

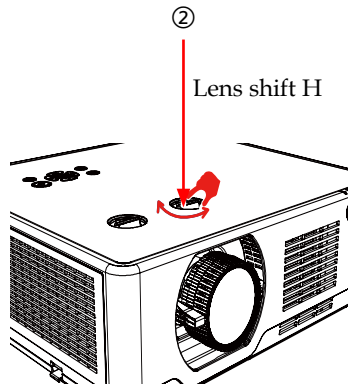
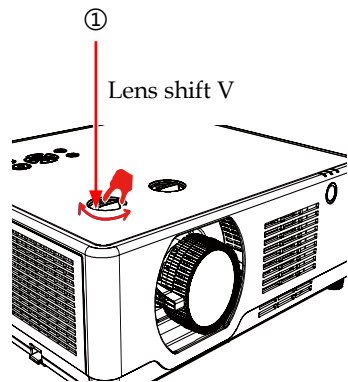
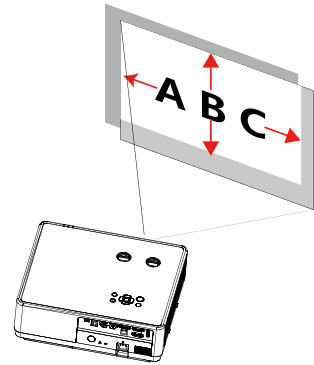

# Basic Operations

The diagram below shows the lens shift adjustment range ([ORIENTATION]: [DESKTOP FRONT]).

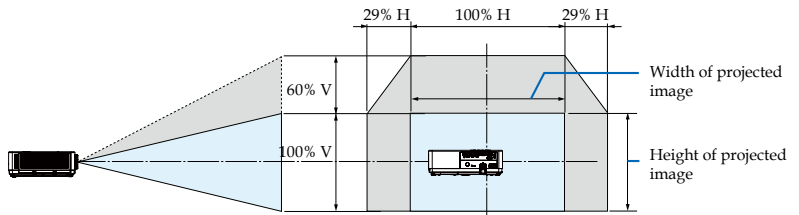
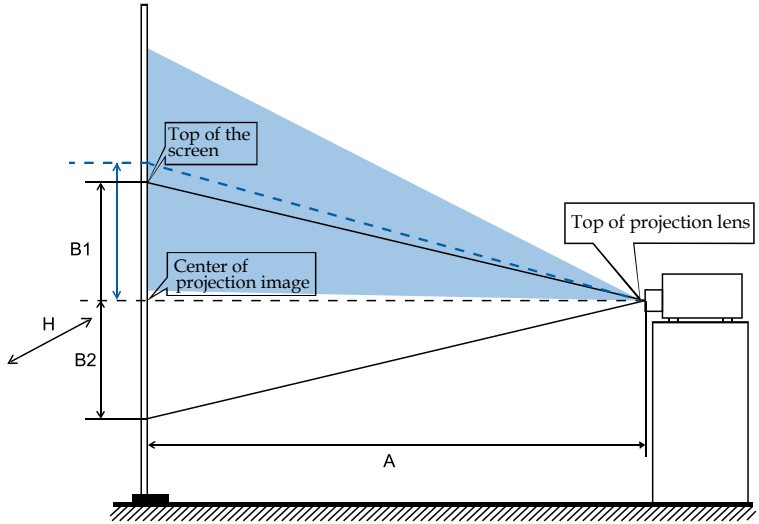

# Basic Operations

## Adjust the projected image

### Adjust the position of the projected image

1. Place the projector so that it is perpendicular to the screen.
2. Rotate the adjustable feet and tilt the projector to an appropriate height, the max height will up to 20mm, just as follow Image ①.
3. To raise the projector, rotate the two feet clockwise. To lower the projector or retract the adjustable feet, rotate the two feet counterclockwise, just as follow Image ②.
4. Using the adjustable feet, you can adjust the projection angle up to 3.5 degrees, just as follow Image ③.

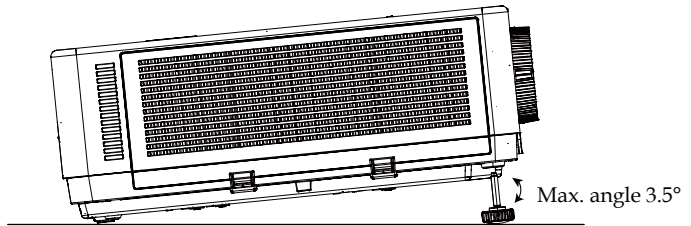

Image ①

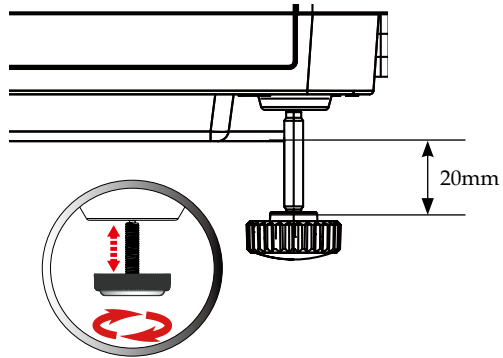

Image ②

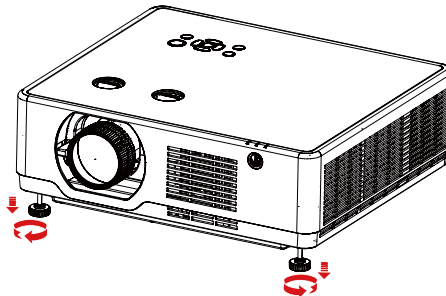
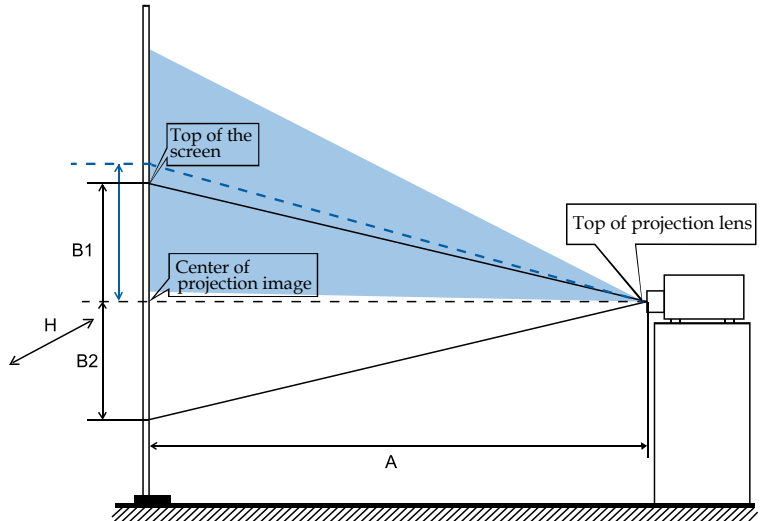

Image ③

# Basic Operations

## Adjust the screen size

- ▶ Projection size (diagonal):  
- RICOH PJ WUL6760 series : 30" to 300"



Diagonal Size (inch)	Screen size				Throw Distance	
	Width H (mm)	Height B1+B2 (mm)	B2 Max	B2 Min	Wide A (mm)	Tele A (mm)
30	646	404	202	-40	765	1258
40	862	538	269	-54	1031	1689
60	1292	808	404	-81	1564	2550
80	1723	1077	538	-108	2098	3411
90	1939	1212	606	-121	2364	3842
100	2154	1346	673	-135	2631	4273
120	2585	1615	808	-162	3164	5134
150	3231	2019	1010	-202	3964	6426
180	3877	2423	1212	-242	4764	7718
200	4308	2692	1346	-269	5297	8579
240	5169	3231	1615	-323	6364	10301
270	5816	3635	1817	-363	7164	11593
300	6462	4039	2019	-404	7964	12885



## On Screen Display (OSD)

The Projector has a multilingual On Screen Display that allows you to make image adjustments and change a variety of settings

### How to operate the OSD

1. To open the OSD, press "Menu" on the Control Panel or Remote Control.
2. When OSD is displayed, use ▲ ▼ keys to select any item in the main menu. While making a selection on a particular page, press ► or "Enter" key to enter sub menu.
3. Use ▲ ▼ keys to select the desired item in the sub menu and press ► or "Enter" key to view further settings. Adjust the settings by using ◀▶ key or ▲ ▼ key.
4. Select the next item to be adjusted in the sub menu and adjust as described above.
  - When there is no next menu in the submenu, press the ◀▶ buttons to set related options.
  - When there is a next menu in the submenu, the screen will display the icon . Press the ▲ ▼ buttons to set related options. If the next submenu contains option settings, press the "ENTER" button to proceed with the next submenu option setting (as above).
5. Press the "MENU" button to return to the previous menu setting.
6. Press the ◀▶ buttons to change or adjust the setting and press "ENTER" button to confirm the change.
7. After exiting, press the "MENU" button again, the OSD will close, and the projector will automatically save the new settings.

#### Note

❖ If no button operation is made for approximately 10 seconds, the OSD will be closed automatically.

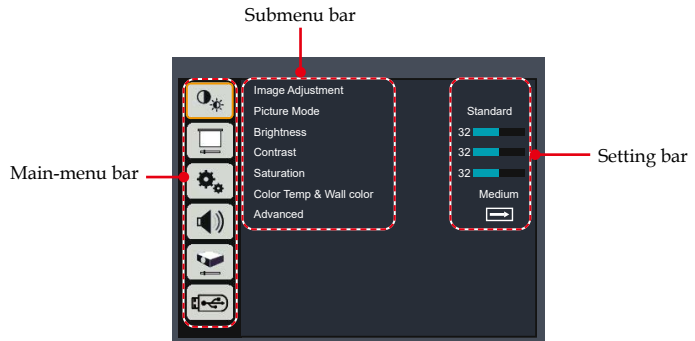

# User Settings

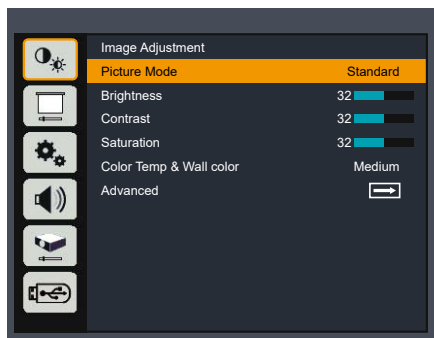

## Image adjustment

### Picture Mode

There are factory presets optimized for various types of images. The available options:

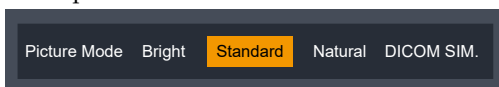

- ▶ **Bright:** Mode for emphasizing brightness.
- ▶ **Standard:** Mode for optimizing the balance between brightness and color reproduction.
- ▶ **Natural:** Images suitable for natural portraits.
- ▶ **DICOM SIM.:** This mode is suitable for projecting a monochrome medical image such as an X ray radiography, MRI, etc.

### Brightness

Adjust the brightness of the image.



- ▶ Press the ◀ key to darken image.
- ▶ Press the ▶ key to lighten the image.

# User Settings

## Contrast

The contrast controls the degree of difference between the lightest and darkest parts of the picture. Adjusting the contrast changes the amount of black and white in the image.



- ▶ Press the ◀ key to decrease the contrast.
- ▶ Press the ▶ key to increase the contrast.

## Saturation

Adjust the color saturation of the image.



- ▶ Press the ◀ key to decrease the amount of color in the image.
- ▶ Press the ▶ key to increase the amount of color in the image.

## Color temp & wall color

Use this function to set the color temperature of the image or to obtain an optimized screen image according to the wall color. The available options: low/medium/high/dark green/light yellow/light blue.

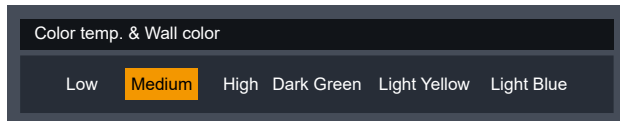

## Advanced

Adjust the white balance of the image.

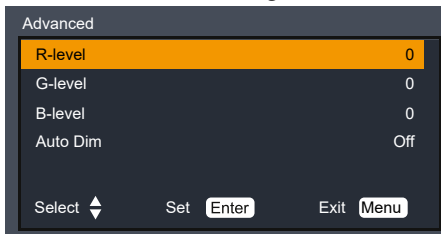

# User Settings

- ▶ R-level: press the ◀ button to decrease the red level.  
Press the ▶ button to increase the red level.



- ▶ G-level: press the ◀ button to decrease the green level.  
Press the ▶ button to increase the green level.



- ▶ B-level: press the ◀ button to decrease the blue level.  
Press the ▶ button to increase the blue level.



- ▶ Auto Dim: Set the option to "On" to optimize contrast.  
Set the option to "Off" to off contrast function.  
Auto Dim is only valid for the following settings.
  - 1) picture mode = Bright.
  - 2) Laser mode = Normal.
  - 3) White field of external signal

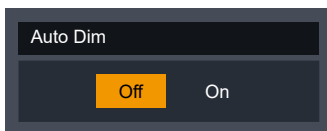

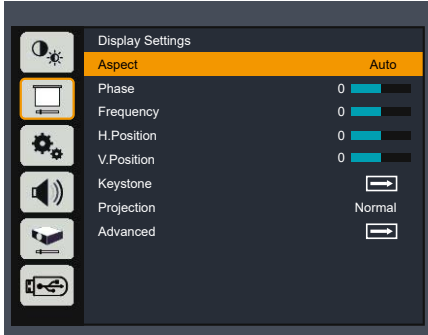

## Display Setting

### Aspect

Use this function to choose your desired aspect ratio.

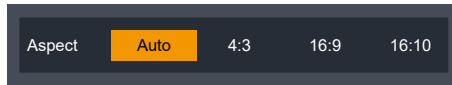

- ▶ Auto: Automatically selects the appropriate display format.
- ▶ 4:3: Displays 4:3 aspect ratio.
- ▶ 16:9: Displays 16:9 aspect ratio.
- ▶ 16:10: Displays 16:10 aspect ratio.

### Note

❖ "Phase" and "Frequency" functions are only supported under Computer Signal source.

### Phase

Eliminate flicker from the image displayed. Use the ◀ or ▶ key to adjust the value.



### Frequency

This function is used to adjust or diminish the disruption from patterns formed by projected vertical stripes.



# User Settings

## H. Position (Horizontal Position)

Shift the projected image position horizontally.

### Note

❖ “H. Position” and “V. Position” functions are only supported under Signal source.



- ▶ Press the ◀ key to move the image left.
- ▶ Press the ▶ key to move the image right.

## V. Position (Vertical Position)

Shift the projected image position vertically.



- ▶ Press the ◀ key to move the image down.
- ▶ Press the ▶ key to move the image up.

## Keystone

Adjust image distortion caused by tilting the projector.

### Note

❖ White arrow means no correction.  
❖ Red arrow indicates the corrected direction and will disappear when the maximum value is reached.  
❖ H/V keystone function may not adjust correctly. Please use Four Corners correction instead.

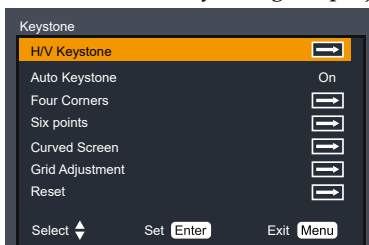

- ▶ H/V keystone: Adjust the keystone of projected images in horizontal and vertical directions.



### Horizontal keystone correction

- Press the ◀ key to adjust the left.
- Press the ▶ key to adjust the right.

### Vertical keystone correction

- Press the ▲ key to adjust the top.
- Press the ▼ key to adjust the bottom.

- ▶ Auto keystone: Press the ◀ or ▶ key to turn on or turn off the auto keystone function.

# User Settings

## Note

- ❖ White arrow means no correction.
- ❖ Red arrow indicates the corrected direction and will disappear when the maximum value is reached.

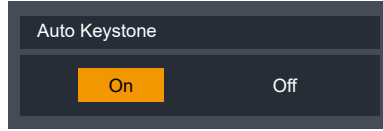

- ▶ Four Corner: Compensate for image distortion by adjusting one corner at a time.



Press the Enter key to select the corner and press the ▲ ▼ ◀ ▶ keys for adjustment.

- ▶ Six points: Compensate for image distortion by adjusting one corner at a time.

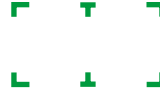

Press the Enter key to select the corner and press the ▲ ▼ ◀ ▶ keys for adjustment.

- ▶ Curved Screen: For uneven linearity or bending deformation of projected images in vertical/horizontal directions.



Press ▲ ▼ key to enter the "Curved Screen" option and press the ▲ ▼ ◀ ▶ keys for adjustment.

--- X/Y gain

- Press the ▶ key: stretch the vertical line leftward/rightward.
- Press the ◀ key: indent the vertical line leftward/rightward.

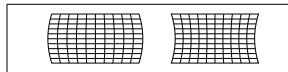

- Press the ▲ key: stretch the horizontal line upward/downward.
- Press the ▼ key: indent the horizontal line upward/downward.

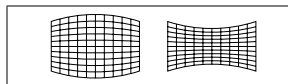

--- X offset

- Press the ▶ key: correct the vertical line on the right, and leave the center area unchanged while expanding the top and bottom.
- Press the ◀ key: correct the vertical line on the left, and leave the center area unchanged while expanding the top and bottom.

# User Settings

- Press the ▲ key: correct the vertical line on both sides, and leave the center area above unchanged while expanding the lower corners.
- Press the ▼ key: correct the vertical line on both sides, and leave the center area above unchanged while expanding the upper corners.

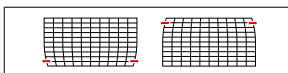

--- Y offset

- Press the ► key: correct the horizontal line on the right, and keep the center area unchanged while expanding the top and bottom.
- Press the ◀ key: correct the horizontal line on the left, and leave the center area unchanged while expanding the top and bottom.

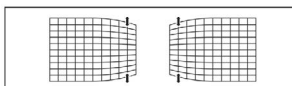

- Press the ▲ key: correct the horizontal lines on both sides, and keep the center area and area above unchanged while expanding the lower corners.
- Press the ▼ key: correct the horizontal lines on both sides, and keep the center area and area below unchanged while expanding the upper corners.

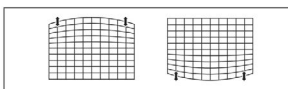

- ▶ Grid adjustment: Select this function to adjust the local points of the projected image .

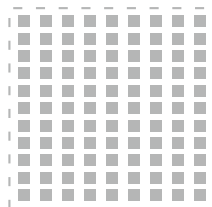

Press ▲▼ key to enter the “Grid adjustment” option and press the ▲▼◀► keys for adjustment.

- ▶ Reset: Restore all modified parameters to the factory settings.

## Projection

Use this function to select the projector mode, depending upon how the projector is mounted.



# User Settings

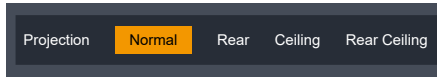

## Note

❖ When auto ceiling is "On", ceiling and rear ceiling are disabled.

- ▶ Normal: This is the default selection. The image is projected directly onto the screen.
- ▶ Ceiling: When selected, the image will appear upside down.
- ▶ Rear: When selected, the image will appear reversed.
- ▶ Rear Ceiling: When selected, the image will appear reversed in upside down position.

## Advanced

Preset advanced screen setting.

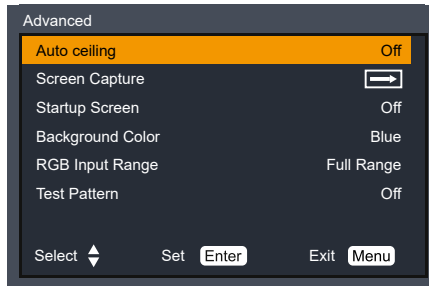

## Note

❖ When the input source is "Memory Viewer", "User" function is invalid.

- ▶ Auto ceiling: Press the ◀ or ▶ key to turn on/of the ceiling function.

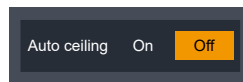

- ▶ Screen Capture: This function is used to capture the projected image and set it as the startup screen picture.

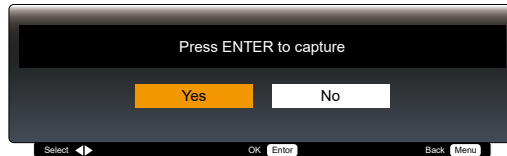

- ▶ Startup Screen: Use this function to choose your desired startup screen.

# User Settings



- Logo: Display logo on the start-up screen.
- Off: Display an empty start-up screen.
- ▶ Background Color: Use this function to choose your desired background color between Logo, User logo, Blue, and Black.

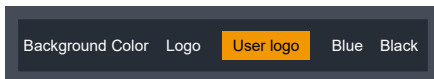

- ▶ RGB input range: Adjust the RGB aberration range in the HDMI input source.

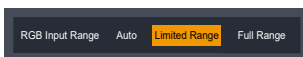

- Auto: Automatically detect RGB range.
- Full Range: Select this mode when computer signal or full range signal from AV equipment is input.
- Limited Range: Process the input image with a limited RGB range.
- ▶ Test pattern: Display the test patterns built in the projector. Position, size and other element settings are not reflected in the patterns. Make sure that the input signal has been displayed before all types of adjustments are done. Select the mode of the needed patterns: off, grid, color bar, white and black. Select "Off" to cancel this function.

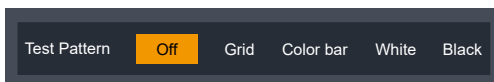

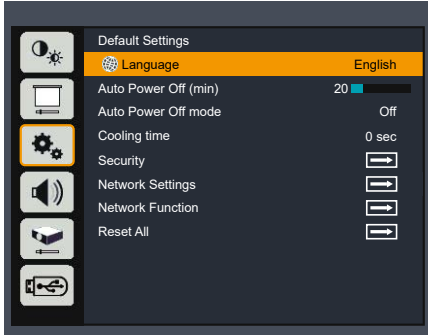

## Default settings

### Language

This function is used for multi-language switch. Enter "Default settings" OSD > "Language", press "ENTER" to enter the sub-menu, and press the ▲ or ▼ key to select the language. Press "ENTER" again for confirmation.

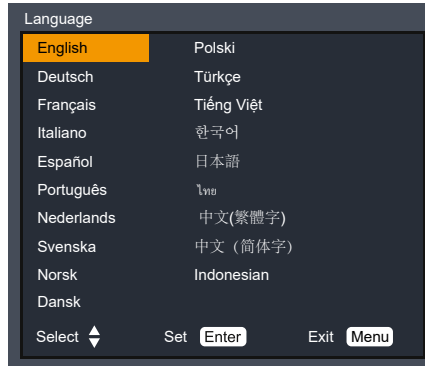

### Auto Power Off (min)

Set the time interval of screen countdown. The projector will enter the state of countdown when there is no signal input. Auto Power Off is activated when the set time interval is due. The light source will turn off to cool down, and enter the standby mode. The adjustable range is 0-120 min.

#### Note

❖ Default value of "Auto Power Off (min)" is 20 min.

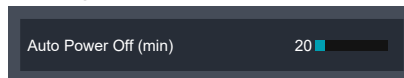

# User Settings

## Auto Power Off mode

This function is to set power off method of the auto power off function.

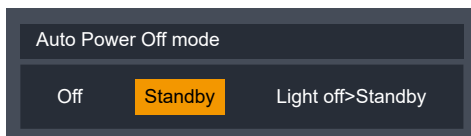

- ▶ Off: Disable the auto power-off function.
- ▶ Standby: Enter standby mode when input become no signal and set time has elapsed.
- ▶ Light off > Standby: Enter Light Off mode for one hour when input become no signal and set time has elapsed. In this mode, the power indicator light become twinkling green and the Light turn On again when input signal is detected or Any key (except power key).

## Cooling Time

After your projector is powered off, select cooling fan speed to shorten the cooling time .

60 sec: Running in normal way.

5 sec: Projector runs faster than in 60 sec mode with shorter time but with a louder sound.

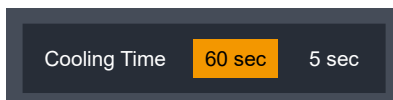

## Security

Configure the security settings.



❖ The default security code is "111".

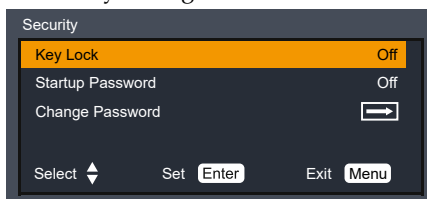

- ▶ Key Lock: This function disables keys on the control panel or remote control to avoid undesired operation.
  - Off: The key on the control panel or remote control is operable
  - Key: The key on the control panel is not operable.

# User Settings

- Remote control: the key on the remote control is not operable.
- ▶ Startup Password: Select “On” to use the security verification when the turning on the projector. Select “Off” to be able to switch on the projector without security verification.



- ▶ Change password

You may change the password into 3 digits as needed, press the indicator ◀▶ key, and select “Password change”. After the password prompt box displays, press the indicator ◀▶ key and enter the correct password. “New password” prompt box disappears. Set new password.



## Network Settings

Configure the network settings.

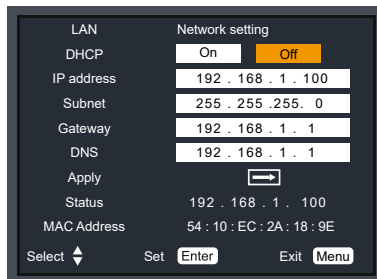

- ▶ DHCP: Select “On” to allow the projector to obtain an IP address automatically from your network. Select “Off” to manually assign IP, Subnet Mask and Gateway configuration.
- ▶ IP Address: Set an IP address.
- ▶ Subnet mask: Set subnet mask.
- ▶ Default gateway: Set default gateway.

# User Settings

- ▶ DNS: Set DNS address.
- ▶ Apply: Execute all settings.
- ▶ Status: Display the current IP address.
- ▶ MAC address Display the projector's MAC address.

## Network Function

Configure some network functions.

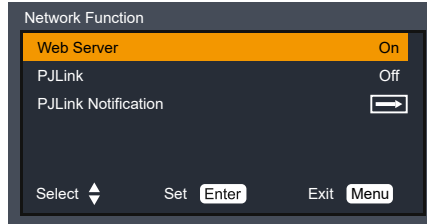

### Note

❖ To prevent unauthorized access, it is recommended to disable features that are not used.

❖ If the LAN Projection settings have been changed, the new settings will take effect when the power is turned on after turned off.

- ▶ Web Server: Set the option to "On" to enable web server function.

Set the option to "Off" to disable web server function

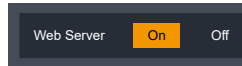

- ▶ LAN Projection: Set the option to "On" to enable LAN projection function..

Set the option to "Off" to disable LAN projection function.

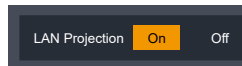

- ▶ PJLink: Set the option to "On" to enable PJ Link function.  
Set the option to "Off" to disable PJ Link function.



- ▶ PJLink Notification: You can manually set the IP address of the computer currently communicating with the projector.

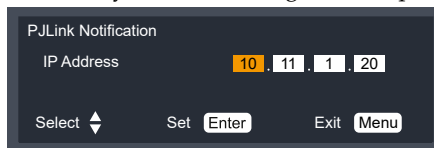

# User Settings

## Reset all

Return the adjustments and settings to the factory default values. (not including the language and Security setting) Choose "Select" to return the display parameters on all menus except Language to the factory default settings.

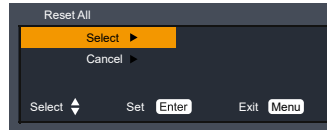

# User Settings

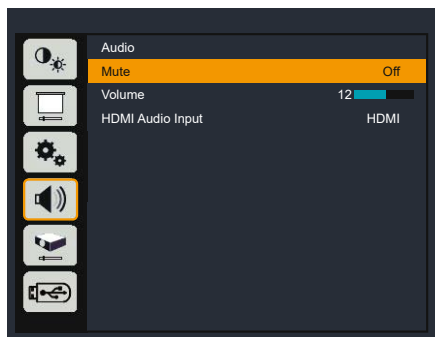

## Audio

### Mute

Disable audio temporarily.



❖ “Mute” function affects both internal and external speaker volume.

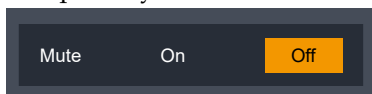

- ▶ Select "Off" to output audio.
- ▶ Select "On" to disable audio.

### Volume

Adjust the volume



- ▶ Press the ◀ button to turn down the volume.
- ▶ Press the ▶ button to turn up the volume.

### HDMI Audio Input

You can connect an external device to the <HDMI 1 In>/<HDMI 2 In > or Audio In terminal of the projector to output the audio.



- ▶ When HDMI is selected, audio from the “HDMI 1 In” and “HDMI 2 In” terminal will be output.
- ▶ When Audio 1 In is selected, audio input into the “Audio In” terminal will be output.



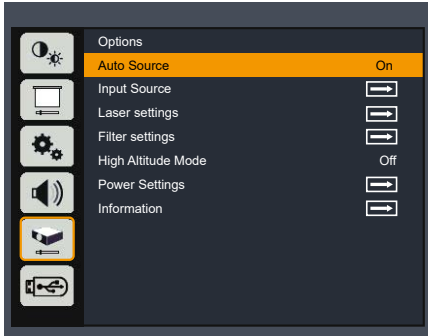

## Options

### Note

- ❖ Auto Source does not support "Memory Viewer".

### Auto Source

When this function is turned "On", the projector will search for other signals if the current input signal is lost. When this function is turned "Off", it will only search a specified connection terminal.

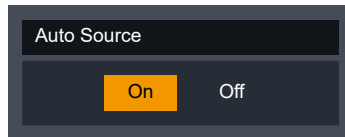

### Input Source

Use this option to enable/disable input sources. Press the ► key to enter the sub menu and select which sources you require. Press "Enter" to finalize the selection. The projector will only search for inputs that are enabled.

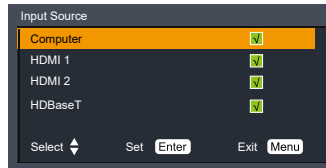

### Laser settings

This function is used to set the laser mode.

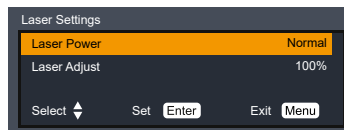

- Laser Power: Select "Normal" mode and the machine displays normal

# User Settings

brightness. Select “ECO 1/ECO 2” mode, the machine display low brightness, reduce the electric power consumption of the light source, thus extending the service life of the light source.

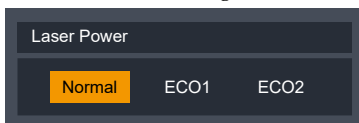

- ▶ Laser Adjust: Laser adjustment: When this function is turned on, if the service life of the bulb is exceeded, the alarm menu will automatically pop up.



## Filter Settings

Use this option to view the filter status and configure the filter settings. Press the ▶ key to enter the sub menu and configure the desired settings.

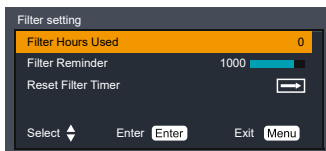

- ▶ Filter Hours Used: Displays the use duration of the filter.
- ▶ Filter Reminder: You can specify the maximum use duration of the filter (that is, specify the cleaning cycle for the filter).



If the [Filter Reminder] is specified and the use duration exceeded the specified maximum value, the screen displays an alert and a message, until any key is pressed.

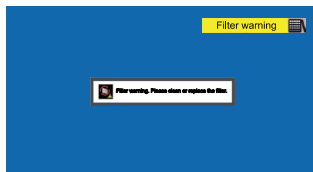

- ▶ Reset Filter Timer: Resets the count of filter hours used.

# User Settings



## High Altitude Mode

If the projector is used at altitudes below 1400m, select [Off]. If the projector is used at altitudes from 1400m to 3000m, select [On].

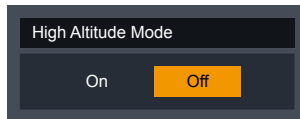

## Power Settings

Use this option to configure the power settings. Press the ► key to enter the sub menu and configure the desired settings.

If changes are made, they will take effect the next time the projector is powered on.

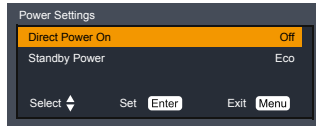

- ▶ Direct Power On: When it is set to [On], the projector is automatically powered on when an AC power supply is connected. Wait at least 30 seconds before connecting the power cord again, after disconnecting the power cord.
- ▶ Standby Power: Specify the standby mode.
  - Eco: In the Eco mode, network functions and RS-232C serial communication (except powering-on instructions) functions are unavailable.
  - Normal: In the Normal mode, serial communication functions and network functions are not limited.

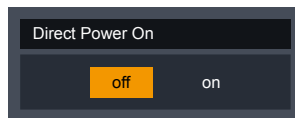

Direct Power On

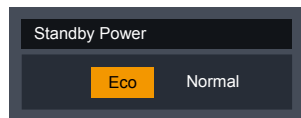

Standby Power

## Information

Displays information related to the projector. Detects projected image signals and operating status of the projector.

# User Settings

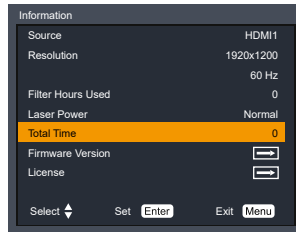

- ▶ Source: Displays selected input source.
- ▶ Resolution: Displays the resolution of input signals in the unit of Hz. And displays [----] when no input signal is detected.
- ▶ Filter Hours Used: Display the used hours of the filter.
- ▶ Laser Power: Displays the mode of the laser light source.
- ▶ Total Time: Displays the number of hours the light source has been used.
- ▶ Firmware Version: Displays the firmware versions of the system and MCU.



- ▶ License: Displays open source software license.

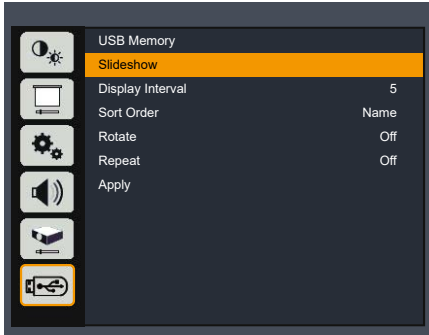

## USB Memory

### Slide show

If you want to project a slide show of images, the display effects for switching slides can be customized.



❖ “USB memory” function is available when [Memory Viewer] input is selected.

### Display Interval

If you want to project a slide show of images, you can specify the slide switching interval.



### Sort Order

If you want to project a slide show of images, the display effects for switching slides can be customized.

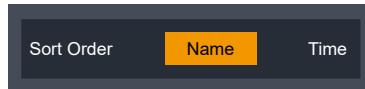

- ▶ Name: Displays by file name and folder name.
- ▶ Time: Displays by file time and folder time.

### Rotate

You can specify the rotation mode for images.

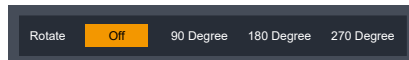

# User Settings

- ▶ Off: Invalid option.
- ▶ 90 Degree: Rotates the image 90 Degree to the right.
- ▶ 180 Degree: Rotates the image 180 Degree.
- ▶ 270 Degree: Rotates the image 270 Degree to the right.

## Repeat

You can specify whether to repeat display slides.

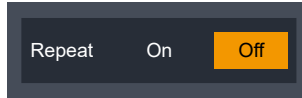

- ▶ Off: Returns to the thumbnail display after the last file is displayed.
- ▶ On: Displays the first file again after the last file is displayed.

## Apply

Apply the settings in [USB Memory].

## Viewing via USB Memory

When a USB memory device is inserted into the projector, the Memory Viewer function enables the projector to project images stored in the USB memory device.

### Content Supported by Memory Viewer

	Extension	Format	Description
Image	JPG/JPEG	Baseline encoded, 24-bit Non-interlaced RGB, 24-bit	Maximum image resolution: 10000x10000 pixels Maximum display resolution: WUXGA

#### Note

- ❖ USB HDD is not supported.
- ❖ Connecting with USB hub is not supported.

For USB memory requirement

#### 1. Format and Memory size

Format	Memory Size	File Size
FAT	4GB	2GB
FAT32	32GB	4GB

#### 2. Supported USB Version : USB 2.0

3. Maximum number of folders/files that can be displayed is 500.
4. Cannot play digital rights management (DRM) protected files.

### Displaying the Memory Viewer Screen

1. Press the [Input] button on the remote control or the [Input] button on the rear control panel, and select [Memory Viewer] from [Input Source].
2. Directly insert a USB memory device into the <USB > terminal.
  - The projector displays the standby screen "please press RC ENTER TER ".

please press RC ENTER 

3. Press the <Enter> button.
  - The root directory of the USB memory device is displayed in thumbnail mode.
4. Press the ◀▶ buttons to select a file.
5. Press the <Enter> button.
  - Images are displayed in full-screen mode.

# User Settings

6. Press the ► button to switch to next image, and press the ◀ button to return to the previous image.
7. Press the <Enter> button.
  - The screen returns to the thumbnail display.

## **Memory Viewer setting**

### **OSD menu operation**

Here are some option settings for Memory Viewer on OSD menu.

### **Unplug the USB memory**

1. Press the ◀► buttons on the remote control to select the thumbnail on the top left.
2. Press the <Enter> button .
  - The projector displays the standby screen [please press RC Enter] 
3. The USB memory can be removed from the projector.



## Controlling this Device with Web Browser

You can control this device from a PC by using a web browser.

### Note

- ❖ To control with web browser, set to “ON” of Network Function>Web Server in the menu of this device.
- ❖ If you click the “Download” button on the left, you will see a file, but this file is cannot be used on this machine.

### Connecting to the device

#### 1. Confirmation of the IP address of the device

Select the “Default Settings” → “Network” in the menu of this device, and verify the IP address. (See pages 59).

Network setting	
LAN	
DHCP	<input type="checkbox"/> On <input checked="" type="checkbox"/> Off
IP address	192 . 168 . 1 . 100
Subnet	255 . 255 . 255 . 0
Gateway	192 . 168 . 1 . 1
DNS	192 . 168 . 1 . 1
Apply	<input type="button" value="→"/>
Status	192 . 168 . 1 . 100
MAC Address	54 : 10 : EC : 2A : 18 : 9E
Select	<input type="button" value="↓"/>
Set	<input type="button" value="Enter"/>
Exit	<input type="button" value="Menu"/>

#### 2. Connection

Enter the IP address that was verified by opening the web browser.

For example, enter `http://192.168.1.100/` if the IP address is displayed as shown above.

## Note

❖ Communication with the web server is not encrypted. Avoid using the same password as other information devices.

## Access from the Web Browser

### Login

Open the network control page.

Enter the password in [New Password] and [Confirm Password] field, and click [OK].

\* The password setting screen will be displayed when you start up for the first time. Please set a password to use the web page.

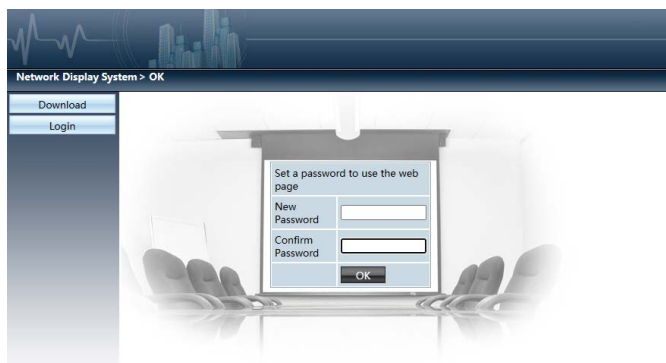

Enter the password in [Passwor] field, and click [Login]



When you log in, a navigation bar for setting the projector will be displayed on the left side of the home screen.

### System Status

The current status of the projector is displayed.

You can check information such as firmware version number of

the projector and IP address.

Network Display System > System Status		
System Status	Model Name	RICOH PJ RU5600 Series
General Setup	Versions	
Picture Setup	Firmware Version	1.07 -1001
Image Setup	LAN Status	
Network Setup	IP Address	10.11.1.97
	Subnet Mask	255.255.255.0
	Default Gateway	10.11.1.1
	MAC Address	00:64:00:00:00:00

## General Setup

You can change the password for the projector.

And you can control the Power and Input Source of the projector.

Network Display System > General Setup	
System Status	Change Password for Webpage
General Setup	Enter Old password
Picture Setup	Enter New password
Image Setup	Confirm New password
Network Setup	Power & Source
	Power <input checked="" type="radio"/> On <input type="radio"/> Off
	Source Select <input type="text" value="HDMI 1"/>

- ▶ Enter Old password: Enter the existing password.
- ▶ Enter New password: Enter a new password.
- ▶ Confirm New password: Enter the new password again for confirmation.
- ▶ Apply: Updates the settings.
- ▶ Power: Switches the power of the projector between On and Off.
- ▶ Source Select: Switches the input source of the projector.

## Picture Setup

You can change the values to adjust the projected image.

Network Display System > Picture Setup	
System Status	Brightness (0 --- 63)
General Setup	Contrast (0 --- 63)
Picture Setup	Saturation (0 --- 63)
Image Setup	Advanced
Network Setup	R-level (-16 --- 16)
	G-level (-16 --- 16)
	B-level (-16 --- 16)

# LAN Control

- ▶ Brightness: Adjust the brightness of the projected image.
- ▶ Contrast: Adjust the contrast of the projected image.
- ▶ Saturation: Adjust the saturation of the projected image.
- ▶ Advanced: Adjust the white balance of the image.
  - R-level: Adjust the red level.
  - G-level: Adjust the green level.
  - B-level: Adjust the blue level.

## Image Setup

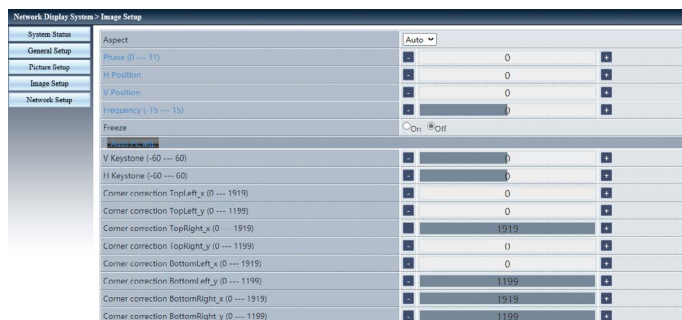

- ▶ Aspect: Switches the aspect ratio of the projected image.
- ▶ Phase: Adjust the phase of the projected image.
- ▶ H Position: Adjust the horizontal position of the projected image.
- ▶ V Position: Adjust the vertical position of the projected image.
- ▶ Frequency: Adjust the frequency of the projected image.
- ▶ Freeze: Switches the image freezing function between on and off.
- ▶ Auto PC Adj.: Implements automatic adjustment by the PC.
- ▶ V Keystone: Adjust the vertical keystone distortion.
- ▶ H Keystone: Adjust the horizontal keystone distortion.
- ▶ Corner correction: Adjust the screen when the linearity is uneven or the vertical or horizontal curves of the projected image are deformed.

## Network Setup

### Note

- ❖ IPv6 cannot be used in this device.
- ❖ After [Reset] is implemented, [LAN Settings] will be restored to factory defaults

Network Display System > Network Setup	
<b>System Status</b>	
<b>General Setup</b>	
<b>Picture Setup</b>	
<b>Image Setup</b>	
<b>Network Setup</b>	
<b>LAN Setup</b>	<input checked="" type="radio"/> Obtain an IP address automatically <input type="radio"/> Use the following IP address
	IP Address: 10   11   1   97
	Subnet: 255   255   255   0
	Gateway: 10   11   1   1
	DNS: 172   16   90   1 <input type="button" value="Apply"/>
<b>PjLink Setup</b>	<input checked="" type="radio"/> Password Enable <input type="radio"/> Password Disable
	Input Password: <input type="text"/>
	Confirm Password: <input type="text"/> <input type="button" value="Apply"/>

- ▶ LAN Setup:
  - If you want to enable the DHCP, select [Obtain the IP address automatically].
  - IP address: If no DHCP is used, enter the IP address.
  - Subnet: If no DHCP is used, enter the subnet.
  - Gateway: If no DHCP is used, enter the gateway IP address.
  - DNS: If no DHCP is used, enter the DNS server IP address. Supported characters: Digits (0-9) .
- ▶ PjLink Setup:
  - If you want to setup the Password, select [Password Enable].
  - Input password: Input the PjLink password.
  - Confirm password: Input the PjLink password once again and confirm.
- ▶ Apply
  - Updates the settings.

## Control the Projector via the Projector Management Utility

### Note

- ❖ This software is to control and monitor projectors manufactured by our company. The software may not work properly when used to control other projectors.
- ❖ The projector management utility function is available only “PJLink” in “Network Function” is On.

Projector Management Utility conforms to the PJLink class 1 standards, and is compatible with all class 1 commands.

A maximum of 100 projectors connected to the network can be managed using one computer.

Projector Management Utility operating environment is described below.

- Supported operating system
  - Windows 10 (32-bit/64-bit version) , Windows 11
- Memory size
  - Recommended memory size for the operating system of the computer you are using
- Display resolution
  - 800 × 600 pixels or more

## Installing Projector Management Utility

### Register projectors

#### 1. Registers the projectors with Auto search

-Click [Register Projector] button.

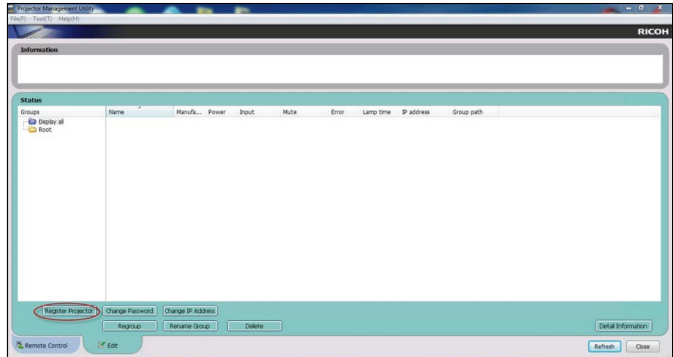

-Click [Auto Search] button.

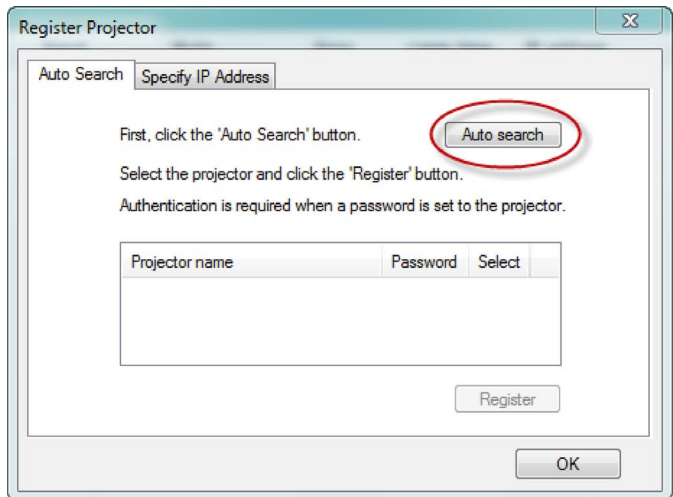

-List of projectors which support PJLink are displayed in the window. Projector name is displayed as "\*\*\*\*\*" until authorization if password is enable.

# LAN Control

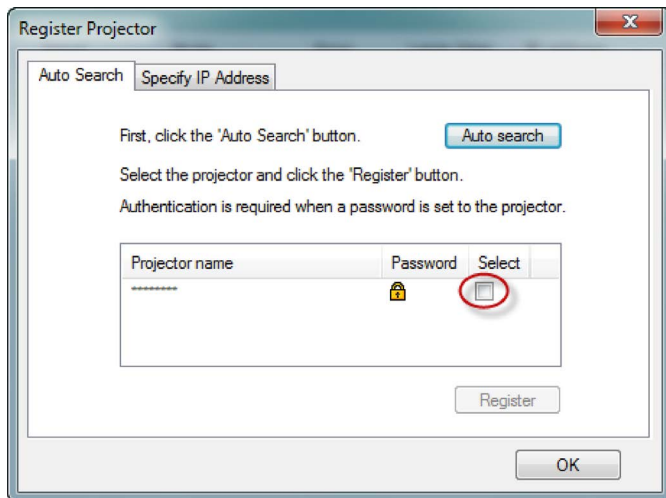

-Select the desired projector and click [**Register**] button.  
Password authorization is required if password of the projector is set to enable.

-Click [**OK**] button to return to the original screen.

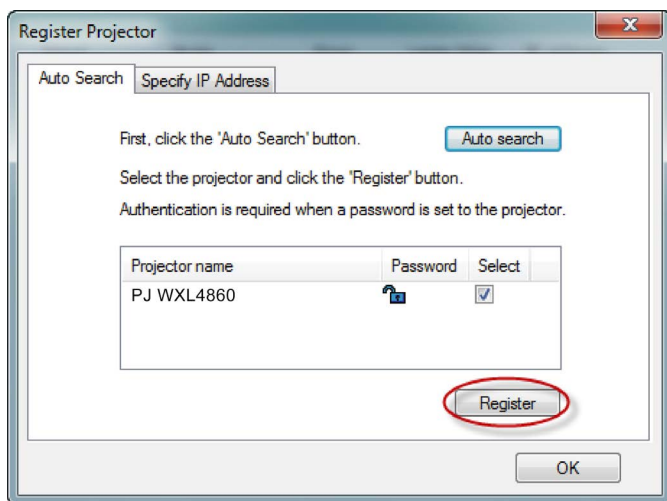

## 2. Directly specifies the IP address and registers the projector.

-Enter IP address of the desired projector and click [Confirm] button then the projector name will be displayed. After confirming the projector name, click [**Register**] button.



## Control the projector with the projector Management Utility

Click [**Remote Control**] tab and select the desired projector in the list. You can control the selected projector by clicking control buttons in the bottom of the window.

### [**Power**] button

Turn "On/Off" the power of the projectors or groups selected from the Projector (/Group) List.



### [**Input**] button

Switches the input source of the projectors or groups selected from the Projector (/Group) List.

Input source will not be changed if the projector doesn't support the selected input source.



A Table of input source name in the projector and the projector management utility.

The projector	The projector Management Utility
Computer	RGB 1
HDMI1	DIGITAL 1
HDMI2	DIGITAL 2
Memory Viewer	STORAGE 1
HDBaseT	NETWORK 3

### [**Detail Information**] button

Show detail information of the selected projector.

# Troubleshooting

*If you experience trouble with the projector, refer to the following information. If the problem persists, please contact your local dealer or service center.*

- Ensure that the projector is correctly connected to the peripheral device.
- Ensure that all devices are connected to an AC power socket and the power supply is connected.
- If the projector fails to project an image from the computer connected to it, restart the computer.

## Problem: Image cannot be displayed

- ▶ Check whether the projector is correctly connected to the computer or the video device and the power supply is normally connected.
- ▶ Check whether the computer input signal is correct. When the projector is connected with some portable computers, the display output settings usually need to be changed. For details on the settings, see the user manual for the computer.
- ▶ Images can be displayed only 10s after the projector is turned on.
- ▶ Check the input signal, color system, video system, or computer system modes.
- ▶ Check whether the temperature exceeds the specified operating temperature.
- ▶ Images cannot be displayed when the [Mute] button is enabled. You need to press the [Mute] button or other related buttons on the remote control.

## Problem: Image is displayed partially, incorrectly, or in rolling mode

- ▶ Press [Auto Set] on the remote control.
- ▶ Adjust the display settings of the computer. Ensure that the resolution is set to less than or equal to 1600x1200 pixels. View the operating system help file.

## Problem: Image is blurred

- ▶ Adjust the focus of the projector.
- ▶ Adjust the projection distance appropriately.
- ▶ Check whether the projection window is free from dust.

# Troubleshooting

- ▶ Ensure that there is no condensation in the projection window. For example, if the projector is moved from a cool environment to a warmer environment, there might be condensation on the projection lens or projection window. If this happens, wait until the condensation disappears before turning on the projector.

## Problem: Image is not bright enough

- ▶ Check whether the contrast or brightness is appropriate.
- ▶ Check whether an appropriate image mode is specified.
- ▶ Check whether the image source power is appropriate.
- ▶ Ensure that the projection screen is within the required projection range.

## Problem: Image is deformed or disappears

- ▶ Press the [Aspect] button on the remote control, or on the OSD menu, choose [Image Adjustment] > [Image Mode], and specify an appropriate display aspect ratio.

## Problem: Projected image is too small or too big

- ▶ Check if the projector is placed perpendicular to the screen.
- ▶ Adjust the distance between the projector and the projection screen.
- ▶ Press the [Aspect] button on the remote control, or on the OSD menu, choose [Display Settings] > [Aspect], and specify an appropriate display aspect ratio.

## Problem: Projected image rotated upside down.



- ▶ Press the [Menu] button on the control or on the remote control, then choose [Display Settings] > [Projection].





































# Troubleshooting

## Problem: Indicators lights up or blinks











































### Note

- ❖ The time marked in the preceding table is an Indicators blinking interval.
- ❖ Blink\*1 Repetition to light on for 1.5 seconds / off for 1.5 seconds.
- ❖ Blink\*2 Repetition to light on for 1.5 seconds / off for 7.5 seconds.
- ❖ Blink\*3 Repetition to light on for 2.5 seconds / off for 0.5 seconds.
- ❖ Blink\*4 Repetition to light on for 0.5 seconds / off for 0.5 seconds.









-  ...Green
-  ...Blinks green
-  ...Red
-  ...Blinks red
-  ...Orange
-  ... Blinks orange
-  ...Blue
-  ...Blinks blue
-  ...Off

Projector status	NO.	Details	Indicators			Content (condition, sequence, check item, etc.)
			POWER	STATUS 1	STATUS 2	
Normal	1	OFF				AC is not connected to the projector state
	2	Standby (ECO)	 Orange (Blink*2)			Normal Standby
	3	Standby(Sleep)	 Orange (Blink*1)			Sleep Standby
	4	Laser ON (ECO ON)	 Blue (Light)		 Green (Blink*3)	Laser ON (Laser power ECO1/ECO2)
	5	Laser ON (ECO OFF)	 Blue (Light)		 Green (Light)	Laser ON(Laser power Normal)
	6	Warm Up	 Blue (Blink*4)			Warm Up
	7	Keylock		 Orange (Light)		A button has been pressed while the KEY LOCK is activated.
Warning	8	Laser Timer Waring			 Orange (Blink*4)	Laser replacement grace period.
Abnormal	9	Laser Timer Error			 Red (Blink*4)	Laser replacement time exceeded.
	10	Laser Retry	 Blue (Blink*4)		 Green (Blink*4)	Preparing to relight laser after lighting has failed.
	11	Laser Low Current error	 Red (Blink*4)	 Green (Light)	 Red (Light)	When LD-Driver current value is too low
	12	LD Driver SPI Comm error	 Red (Blink*4)	 Green (Blink*4)	 Red (Light)	When LD-Driver SPI communication error

# Troubleshooting

Abnormal	13	LD Driver status error	 Red (Blink*4)	 Green (Light)	 Red (Blink*4)	When LD driver is in standby state
	14	LD Driver voltage error	 Red (Blink*4)	 Green (Blink*1)	 Red (Light)	When LD-Driver 13V or 55V error
	15	LD Driver current output error	 Red (Blink*4)	 Green (Light)	 Red (Blink*1)	When LD-Driver output current is abnormal
	16	LD-status ready error	 Red (Blink*4)	 Green (Blink*3)	 Red (Light)	When LD driver is not ready
	17	Laser Error (other)	 Red (Blink*4)	 Green (Light)	 Red (Blink*3)	when LD Driver error
	18	Temp Error	 Red (Blink*4)	 ○	 ○	When Temperature status is error
	19	Fan1 Error	 Red (Light)	 Orange (Light)	 ○	When Fan-1 status is error
	20	Fan2 Error	 Red (Light)	 Orange (Blink*4)	 ○	When Fan-2 status is error
	21	Fan3 Error	 Red (Light)	 ○	 Orange (Blink*4)	When Fan-3 status is error
	22	Fan4 Error	 Red (Light)	 Orange (Blink*1)	 ○	When Fan-4 status is error
	23	Fan5 Error	 Red (Light)	 ○	 Orange (Blink*1)	When Fan-5 status is error
	24	Fan6 Error	 Red (Light)	 Orange (Blink*3)	 ○	When Fan-6 status is error
	25	Power Error	 Red (Light)	 Red (Blink*4)	 ○	When power status is error
	Normal	26	Cooling	 Green (Blink*4)	 ○	 ○

# Troubleshooting

Normal	27	Light Off mode	 Green (Light)			Power Save Standby
Abnormal	28	Color wheel Error	 Red (Blink*4)	 Red (Blink*4)		When phosphor wheel status is error
Warning	29	Filter Warning	 Red (Light)	 Red (Blink*3)		Filter over time Warning

# Replacing the filter

## **Before Maintenance**

Before maintaining or replacing a component, ensure that the power is turned off. For details, see the section of "Turn off the projector".

## **Clean casing of your projector**

Gently wipe the casing with clean and soft cloth dampened with small amount of neutral detergent to remove heavy dirt. Do not over apply cleaner to the casing. Abrasive cleaner, solution, or other rough chemical may scratch the casing surface.

Place your projector in proper container after use to protect it from dirt and dust and being scratched.

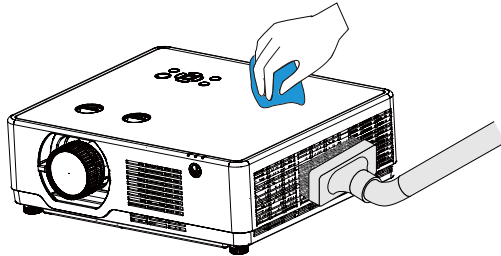

## **Clean the projection window**

Wipe the lens with clean cloth dampened with non-abrasive camera lens cleaner or clean it with lens cleaning paper or air blower.

Do not over apply cleaner to the lens. Abrasive cleaner, solution, or other rough chemical may scratch the lens.

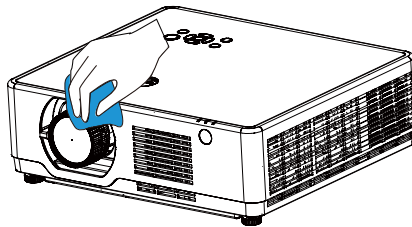

# Replacing the filter

## Filter Cleaning and Replacement

### Note

❖ When installing the filter, install the rib on the filter upward and outside of the projector.

In the following cases, maintain the filter and reset the number of hours the filter is used:

- When the filter hours used reaches the filter timer value;
- When the indicator shows filter warning (See page 64) or filter warning message is displayed at power on (See page 84).

## Cleaning the filter

1. Turn off the projector and unplug the AC power supply from the power socket.
2. Push button to release the filter cover and pull it out.

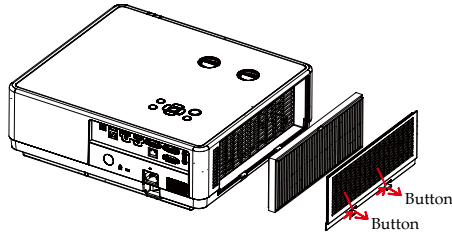

3. Remove the filter.
  - Remove the filter from the filter cover.
4. Remove dust from the filter and the filter cover.
  - Clean both outside and inside.

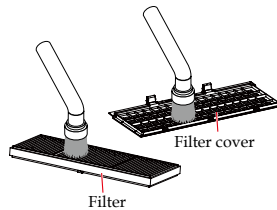

### Note

- ❖ Whenever you dust the filter, use the soft brush attachment to dust. This is to avoid damage to the filter.
- ❖ Do not wash the filter with water. Doing so can result in filter clogging.



# Replacing the filter

## Replacing the filter

1. Attach the filter to the projector.

### Note

- ❖ When installing the filter, please make sure that the catch of the filter is facing outwards, otherwise the installation is reversed.

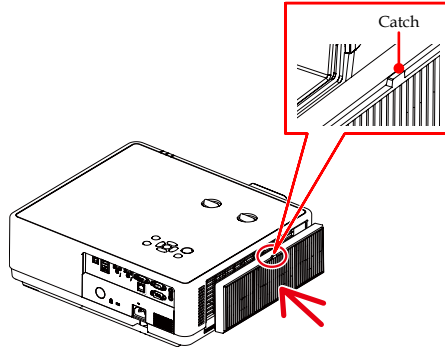

2. Put the filter cover back to the projector cabinet.

Insert the three catches of the tip of the filter cover into the groove of the cabinet, and then push the A button to close the filter cover.

- Push the filter cover until it clicks into place.

### Note

- ❖ After installing the filter cover to the cabinet, please press the left and right ends (B) of the filter cover manually to ensure that it is fully installed.

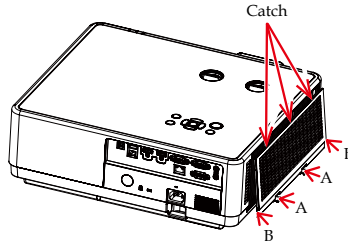

## Reset the Filter timer

Plug the power cord into the wall outlet, and then turn on the projector.

From the menu, select [Options] → [Filter Settings] → [Reset Filter Timer]. (→ page 64)

The interval time to clean the filter is set to [1000H] at time of shipment. When using the projector as it is, you do not clear the filter usage.

# Appendices

## List of Compatible Signals

A. RGB Signal					
(1) Computer Input					
Mode	Resolution	V frequency (Hz)	H frequency (kHz)	Clock (MHz)	Note
VGA	640x480	60	31.5	25.2	
	640x480	67	35	26.8	
	640x480	72	37.9	31.5	
	640x480	75	37.5	31.5	
	640x480	85	43.3	36	
SVGA	800x600	56	35.1	36	
	800x600	60	37.9	40	
	800x600	72	48.1	50	
	800x600	75	46.9	49.5	
	800x600	85	53.7	56.3	
Mac	832x624	75	49.1	57.3	
XGA	1024x768	60	48.4	65	
	1024x768	70	56.5	75	
	1024x768	75	60	78.8	
	1024x768	85	68.7	94.5	
MAC	1152x864	75	67.5	108	
SXGA	1280x1024	60	64	108	
	1280x1024	72	77	133	
	1280x1024	75	80	135	
QVGA	1280x960	60	60	101.3	
SXGA+	1400x1050	60	65.3	121.8	
UXGA	1600x1200	60	75	162	
	1920x1080	60	67.5	148.5	
WUXGA	1920x1200	60	74	154	
(2) Extended Wide Timing					
WXGA	1280x720	60	44.8	74.2	
	1280x800	60	49.6	83.5	
	1366x768	60	47.7	84.8	
	1440x900	60	59.9	106.5	
WSXGA+	1680x1050	60	65.3	146.3	

## B. HDMI Input

### (1) Computer input signal

Mode	Resolution	V frequency (Hz)	H frequency (kHz)	Clock (MHz)	Note
VGA	640 x 480	60	31.5	25.2	
	640 x 480	67	35	26.8	
	640 x 480	72	37.9	31.5	
	640 x 480	75	37.5	31.5	
	640 x 480	85	43.3	36	
SVGA	800 x 600	56	35.1	36	
	800 x 600	60	37.9	40	
	800 x 600	72	48.1	50	
	800 x 600	75	46.9	49.5	
	800 x 600	85	53.7	56.3	
MAC	832 x 624	75	49.1	57.3	
XGA	1024 x 768	60	48.4	65	
	1024 x 768	70	56.5	75	
	1024 x 768	75	60	78.8	
	1024 x 768	85	68.7	94.5	
MAC	1152 x 864	75	67.5	108	
SXGA	1280 x 1024	60	64	108	
	1280 x 1024	72	77	133	
	1280 x 1024	75	80	135	
QVGA	1280 x 960	60	60	101.3	
SXGA+	1400 x 1050	60	65.3	121.8	
UXGA	1600 x 1200	60	75	162	
	1920 x 1080	60	67.5	148.5	
WUXGA	1920x1200 (RB)	60	74	154	
4K	3840x2160	30	67.5	297	
(2) Extended Wide Timing					
WXGA	1280x720	60	44.8	74.2	
	1280x800	60	49.6	83.5	
	1366x768	60	47.7	84.8	
	1440x900	60	59.9	106.5	
WSXGA+	1680x1050	60	65.3	146.3	



# Appendices

(3) Component Signal					
480i	1440x480	59.94	15.7	13.5	
576i	1440x576	50	15.6	13.5	
480p	720x480	59.94	31.5	27	
576p	720x576	50	31.3	27	
720p	1280x720	60	45	74.25	
	1280x720	50	37.5	74.25	
1080i	1920x1080	60	33.8	74.25	
	1920x1080	50	28.1	74.25	
1080p	1920x1080	23.98/24	27	74.25	
	1920x1080	60	67.5	148.5	
	1920x1080	50	56.3	148.5	

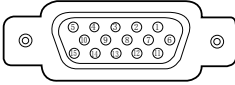
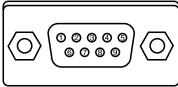

## C. Memory Viewer

		Description
Display Resolution		1920X1200
Format		jpeg
Maximum Image Size	pixel	10000 x 10000
	MB	2048MB

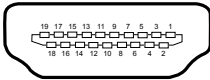
## Configurations of Terminals

MONITOR OUT terminal RGB (D-sub 15)				
	1	Red (Output)	9	----
	2	Green (Output)	10	Grounding (field synchronizing)
	3	Blue ((Output)	11	Grounding
	4	----	12	DDC data
	5	Grounding (line synchronizing)	13	Horizontal synchronizing (compound sync.) output
	6	Grounding (red)	14	Vertical synchronizing output
	7	Grounding (green)	15	DDC Clock
	8	Grounding (blue)		
PC Control Terminal (D-SUB-9)				
	1	----	6	----
	2	RXD	7	----
	3	TXD	8	----
	4	----	9	----
	5	GND		
LAN terminal				
 87654321	1	TX +	5	----
	2	TX -	6	RX -
	3	RX +	7	----
	4	----	8	----
HDMI terminal (HDMI Type A 19)				
	1	TMDS Data2+	11	TMDS Clock Shield
	2	TMDS Date2 Shield	12	TMDS Clock-
	3	TMDS Date2-	13	CEC
	4	TMDS Date1+	14	Reserved(N.C. on device)
	5	TMDS Date1 Shield	15	SCL
	6	TMDS Date1-	16	SDA
	7	TMDS Date0+	17	DDC/CEC Ground
	8	TMDS Date0 Shield	18	+5V Power
	9	TMDS Date0-	19	Hot Plug Detect
	10	TMDS Clock+		

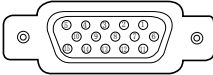
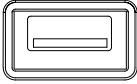
# Appendices

Computer In terminal			
	1	Red/S-C input	9 VCC
	2	Green input	10 Grounding(field synchronizing)
	3	B input	11 Grounding
	4	-----	12 DDC data
	5	Grounding(line synchronizing)	13 Horizontal synchronizing (compound sync.)input
	6	Grounding(red)	14 Vertical synchronizing input
	7	Grounding(green)	15 DDC clock
	8	Grounding(blue)	
USB-A terminal			
	1	VBUS	5 -----
	2	D-	6 -----
	3	D+	7 -----
	4	GND	8 -----
USB-B terminal			
	1	VBUS	6 -----
	2	D-	7 -----
	3	D+	8 -----
	4	ID	9 -----
	5	GND	10 -----

## Specifications

### ■ List of general Specifications

Item	RICOH PJ WUL6760 series				
<b>Optical</b>					
LCD system	3x0.64"				
Display Resolution	1920x1200				
Light source life	Normal: 20,000h, ECO1/ECO2: 30,000h				
Projection lens	RICOH Lens				
F	1.5~2.08				
f	17.2~27.7mm				
Throw Ratio	1.2 (wide)-2.0 (tele)				
Zoom Ratio	1.6				
Zoom	Manual				
Focus	Manual				
Lens shift	H: ±29% V: +60%~-0%				
Throw Distance(m)	0.765m~7.964m (Wide) 1.258m~12.885m (Tele)				
Image Size(inch)	30"~300"				
<b>Electrical</b>					
Terminal Interface	<ul style="list-style-type: none"> <li>• Computer In</li> <li>• PC Control</li> <li>• HDBaseT(*)</li> </ul>	<ul style="list-style-type: none"> <li>• Monitor Out</li> <li>• HDMI 1 In</li> </ul>	<ul style="list-style-type: none"> <li>• Audio Out</li> <li>• HDMI 2 In</li> </ul>	<ul style="list-style-type: none"> <li>• Audio In</li> <li>• USB-B</li> </ul>	<ul style="list-style-type: none"> <li>• LAN</li> <li>• USB-A</li> </ul>
Speaker	1×16 W (monaural)				
Power consumption	<ul style="list-style-type: none"> <li>• Normal : 315W(100V)/312W(110V)/305W(220V)/305W(240V)</li> <li>• ECO1: 207W(100V)/206W(110V)/202W(220V)/202W(240V)</li> <li>• ECO2: 182W(100V)/181W(110V)/178W(220V)/178W(240V)</li> <li>• Maximum: ≤360W</li> <li>• Standby: ≤0.5W</li> <li>• Network Standby: ≤2W</li> </ul>				
Rating Current(A)	3.6A-1.6A (100-240V~ 50/60Hz)				
Noise	<ul style="list-style-type: none"> <li>• Normal: Typ 37dB(A)</li> <li>• ECO 1/ECO 2: Typ 27dB(A)</li> </ul>				
<b>Mechanical</b>					

# Appendices

Keystone	H: $\pm 30^\circ$ V: $\pm 30^\circ$
Adjust feet	Max 3.5°
Dimensions(WxDxH)	405 mm (W)×358mm (D)×137 mm(H) (Not including feet)
Net. Weight (KG)	Approx. 7.9kg
Gross. Weight (KG)	Approx. 10.4kg
Environment	<ul style="list-style-type: none"><li>• Operating temperature: 5°C~40°C (0-1400m Altitude)/ 5°C~30°C (1400-3000m Altitude)</li><li>• Operating Humidity: 20~80%RH (non-condensing)</li><li>• Storage temperature: -10°C~50°C</li><li>• Storage Humidity: 10~85%RH (non-condensing)</li></ul>

## Note

- This model complies with the above specifications.
- Designs and specifications are subject to change without notice.
- This model may not be compatible with features and/or specifications that may be added in the future.

### ■ Separately sold product

Replacement Air Filter Type 15.



## External Dimensions

Tapped holes used for ceiling installation.

Screw: M4

Depth: 8mm

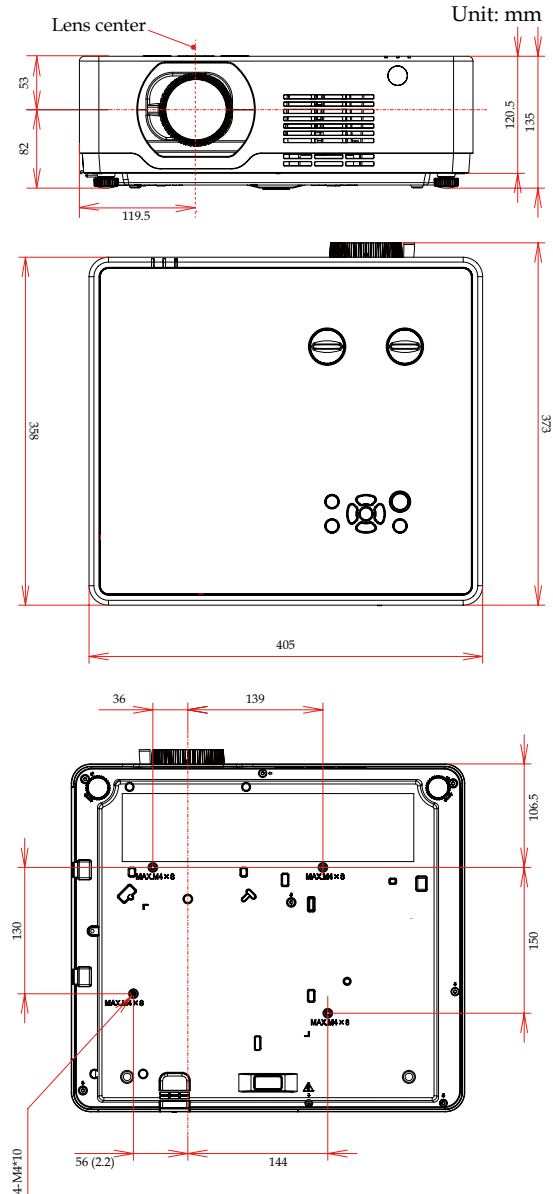

## Trademarks

- Microsoft, Windows, Windows Vista, Internet Explorer and PowerPoint are either a registered trademark or trademark of Microsoft Corporation in the United States and/or other countries.
- HDMI, the HDMI Logo and High-Definition Multimedia Interface are trademarks or registered trademarks of HDMI Licensing Administrator, Inc.
- Kensington is a trademark or registered trademark of ACCO Brands.
- Blu-ray is a trademark of Blu-ray Association.
- Other product and company names mentioned in this user's manual may be the trademarks or registered trademarks of their respective holders.
- Trademark PLink is a trademark applied for trademark rights in Japan, the United States of America and other countries and areas.

