



# **PRO Series**

## **All-in-One PC**

PRO AP242 14M (MS-AE06)

PRO AP242P 14M (MS-AE06)

PRO AP272 14M (MS-AF83)

PRO AP272P 14M (MS-AF83)

User Guide

# Contents

Getting Started.....	3
Package Contents.....	3
Safety & Comfort Tips .....	3
System Overview.....	4
Installing the Monitor Stand.....	9
Connecting the Power .....	10
Adjusting the Monitor .....	11
Component Replacement & Upgrade .....	12
Windows 11 System Operations.....	13
Power Management .....	13
Network Connections .....	17
System Recovery .....	25
F3 Hotkey Recovery (Optional) .....	27
Troubleshooting.....	28
Safety Instructions.....	30
TÜV Rheinland Certification.....	32
Regulatory Notices.....	33

## Revision

V1.2, 2023/12

# Getting Started

This chapter provides you with the information on hardware setup procedures. While connecting devices, be careful in holding the devices and use a grounded wrist strap to avoid static electricity.

## Package Contents

All-in-One PC	PRO AP242 14M
	PRO AP242P 14M
	PRO AP272 14M
	PRO AP272P 14M
Documentation	User Guide (Optional)
	Quick Start Guide (Optional)
	Warranty Card (Optional)
	Warranty Book (Optional)
Accessories	Power Cord
	External Power Supply
	Mouse (Optional)
	Keyboard (Optional)



### **Important**

- Contact your place of purchase or local distributor if any of the items is damaged or missing.
- Package contents may vary by country.
- The included power cord is exclusively for this personal computer and should not be used with other products.

## Safety & Comfort Tips

- Choosing a good workspace is important if you have to work with your PC for a long period of time.
- Your work area should have enough illumination.
- Choose the proper desk and chair and adjust their height to fit your posture when operating.
- When sitting on the chair, sit straight and keep a good posture. Adjust the chair's back (if available) to support your back comfortably.
- Place your feet flat and naturally on the floor, so that your knees and elbows have the proper position (about 90-degree) when operating.
- Put your hands on the desk naturally to support your wrists.
- Avoid using your PC in a place where discomfort may occur (such as on the bed).
- The PC is an electrical device. Please treat it with great care to avoid personal injury.

# System Overview

## Front View

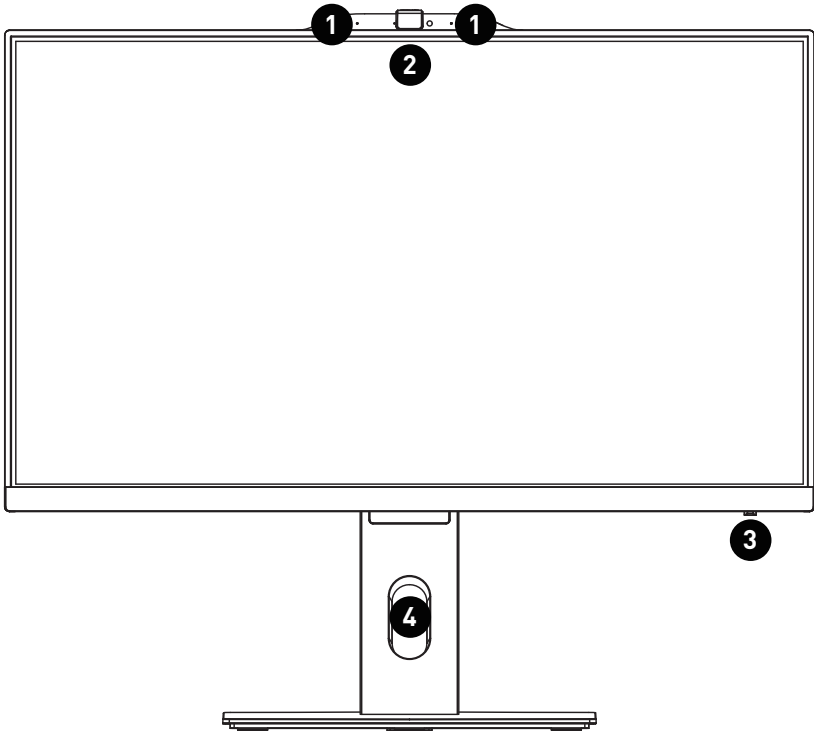



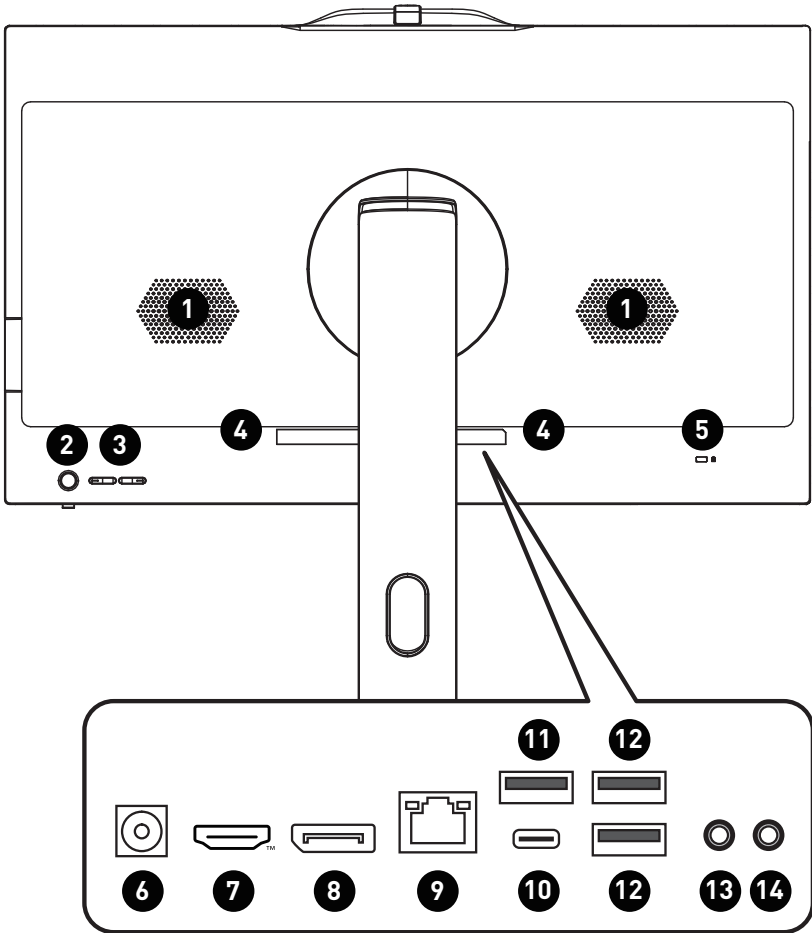

<b>1</b>	<b>Digital Microphone</b> The built-in microphone can be used for video chatting online.
<b>2</b>	<b>IR Webcam Module/ Webcam Privacy Shutter</b> The IR Webcam Module supports infrared-based facial recognition for instant access to your computer.
<b>3</b>	<b>Power LED</b> The power LED glows when the system is turned on and goes off when the system is shut down. In terms of power saving, the LED blinks in S3 (Suspend to RAM) mode and goes off in S4 (Suspend to Disk) mode.
<b>4</b>	<b>Cable Routing Hole</b> Route the cables through the cable routing hole to avoid cable spaghetti when connecting devices.

# Rear View

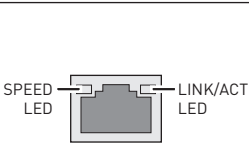
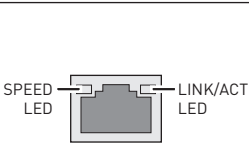
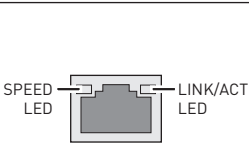

<p><b>1</b></p>	<p><b>Ventilator</b> The ventilator on the enclosure is used for air convection and to prevent the equipment from overheating. Do not cover the ventilator.</p>
<p><b>2</b></p>	<p><b>Power Button</b> Press the power button to turn the system on and off.</p>
<p><b>3</b></p>	<p><b>Brightness Button</b> These buttons adjust the brightness level.</p>

4	<p><b>Stereo Speakers</b></p> <p>The built-in stereo speakers deliver high quality sound with stereo system.</p>																		
5	<p><b>Kensington Lock Port</b></p> <p>This PC provides a Kensington lock port, which allows users to secure the PC in place with a key or some mechanical PIN device and attached through a rubberised metal cable. The end of the cable has a small loop which allows the whole cable to be looped around a permanent object, such as a heavy table or other similar equipment, thus securing the PC in place.</p>																		
6	<p><b>Power Jack</b></p> <p>Power supplied through this jack supplies power to your system.</p> <p> <b>Important</b></p> <p><i>We suggest that you connect the AC/DC adapter to your PC first and then connect the AC power cord to the socket-outlet for safety concerns.</i></p>																		
7	<p><b>HDMI™ Connector</b> <b>HDMI™</b> <small>HIGH-DEFINITION MULTIMEDIA INTERFACE</small></p> <p>Supports 4K@60Hz as specified in HDMI™ 2.1.</p> <p> <b>Important</b></p> <ul style="list-style-type: none"> <li>• Available for the processor with integrated graphics.</li> <li>• Graphics specifications may vary depending on the installed CPU.</li> </ul>																		
8	<p><b>DisplayPort</b></p> <p>Supports 4K@60Hz as specified in DisplayPort 1.4.</p> <p> <b>Important</b></p> <ul style="list-style-type: none"> <li>• Available for the processor with integrated graphics.</li> <li>• Graphics specifications may vary depending on the installed CPU.</li> </ul>																		
9	<p><b>LAN Jack</b></p> <p>The standard RJ-45 LAN jack is provided for connection to the Local Area Network (LAN). You can connect a network cable to it.</p> <table border="1" data-bbox="210 1123 921 1337"> <tr> <td data-bbox="210 1123 483 1337" rowspan="6">  </td> <td data-bbox="483 1123 625 1155"><b>LED</b></td> <td data-bbox="625 1123 727 1155"><b>Status</b></td> <td data-bbox="727 1123 921 1155"><b>Description</b></td> </tr> <tr> <td data-bbox="483 1155 625 1251" rowspan="2">Link/ Activity LED</td> <td data-bbox="625 1155 727 1187">Off</td> <td data-bbox="727 1155 921 1187">No link</td> </tr> <tr> <td data-bbox="625 1187 727 1251">Yellow</td> <td data-bbox="727 1187 921 1219">Linked</td> </tr> <tr> <td data-bbox="483 1251 625 1337" rowspan="3">Speed LED</td> <td data-bbox="625 1219 727 1251">Blinking</td> <td data-bbox="727 1219 921 1251">Data activity</td> </tr> <tr> <td data-bbox="625 1251 727 1283">Off</td> <td data-bbox="727 1251 921 1283">10 Mbps</td> </tr> <tr> <td data-bbox="625 1283 727 1315">Green</td> <td data-bbox="727 1283 921 1315">100 Mbps</td> </tr> <tr> <td data-bbox="625 1315 727 1337">Orange</td> <td data-bbox="727 1315 921 1337">1 Gbps</td> </tr> </table>		<b>LED</b>	<b>Status</b>	<b>Description</b>	Link/ Activity LED	Off	No link	Yellow	Linked	Speed LED	Blinking	Data activity	Off	10 Mbps	Green	100 Mbps	Orange	1 Gbps
	<b>LED</b>		<b>Status</b>	<b>Description</b>															
	Link/ Activity LED		Off	No link															
			Yellow	Linked															
	Speed LED		Blinking	Data activity															
			Off	10 Mbps															
		Green	100 Mbps																
Orange	1 Gbps																		
10	<p><b>USB 3.2 Gen 2 Type-C Port</b></p> <p>This connector is provided for USB peripheral devices. This connector can provide up to 5V/3A of power. (Speed up to 10 Gbps)</p>																		

<b>11</b>	<b>USB 3.2 Gen 2 Port</b> This connector is provided for USB peripheral devices. (Speed up to 10 Gbps)
<b>12</b>	<b>USB 2.0 Port</b> This connector is provided for USB peripheral devices. (Speed up to 480 Mbps)   <b>Important</b> <i>High-speed devices are recommended for USB 3.2 ports whereas low-speed devices, such as mouse or keyboard, are suggested to be plugged into the USB 2.0 ports.</i>
<b>13</b>	<b>Microphone Jack</b> This connector is provided for microphones.
<b>14</b>	<b>Headphone Jack</b> This connector is provided for headphones or speakers.

## Side View

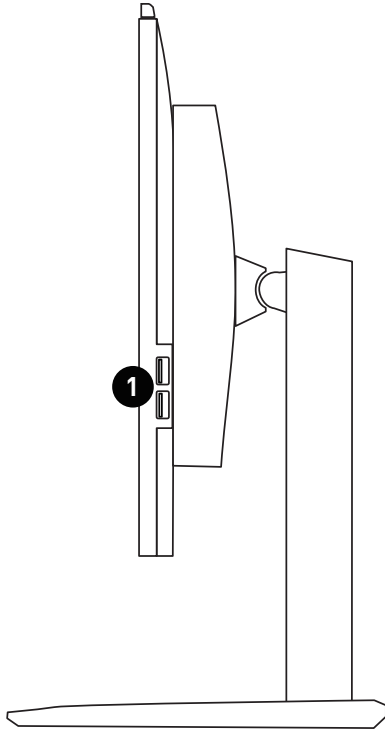

1

### USB 3.2 Gen 1 Port

This connector is provided for USB peripheral devices. (Speed up to 5 Gbps)



## Installing the Monitor Stand

1. Leave the monitor in its protective packaging. Align the stand to the monitor groove.
2. Push the stand towards the monitor groove until it locks in place.
3. Connect the base to the stand and tighten the base screws to secure the base.
4. Make sure the stand assembly is properly installed before setting the monitor upright.

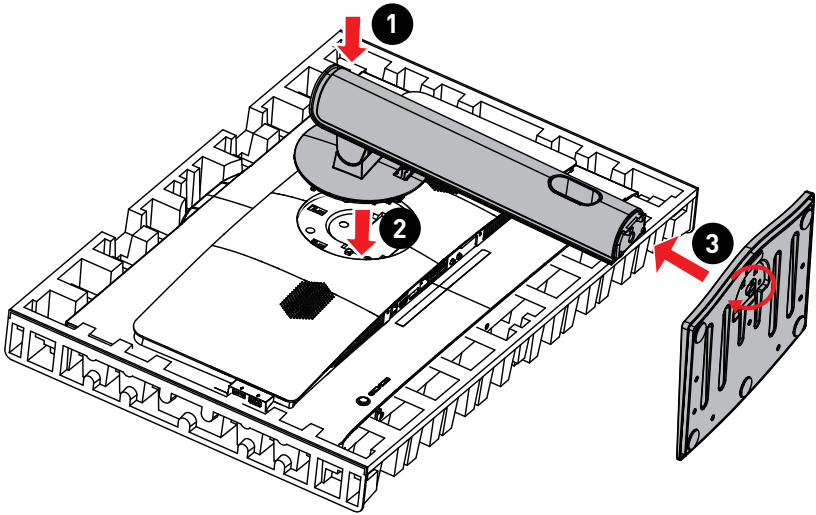

### **Important**

- Do not use any sharp objects on the panel.

## Connecting the Power

Connect the external power supply to the AIO PC and plug in the power cord.

- External Power Supply 120W
  - Input: 100-240V~, 50-60Hz
  - Output: 19.5V  6.15A

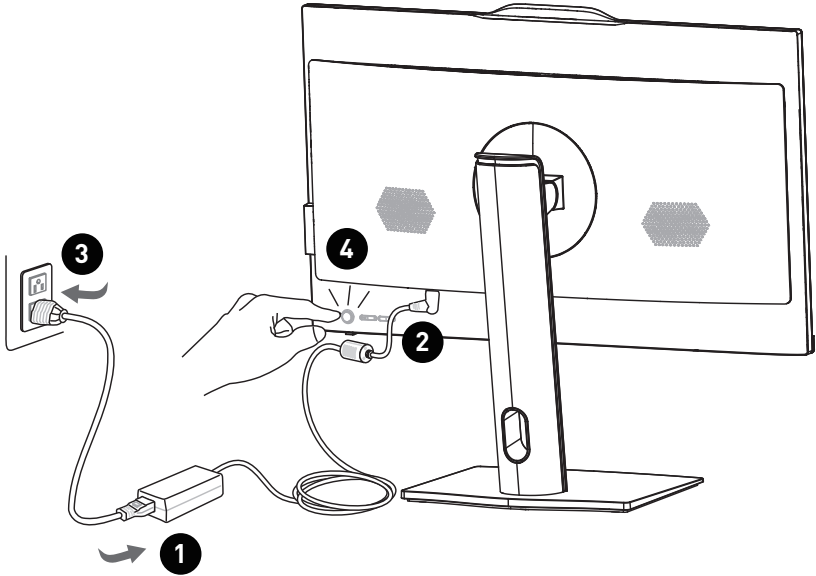

### Important

- The illustrations are for reference only. Your AIO PC may vary in appearance.
- Please make sure the AIO PC has been grounded to earth through the AC power cord and the electrical outlet before powering on the AIO PC.

## Adjusting the Monitor

This AIO PC is designed to maximize your viewing comfort with its adjustment capabilities.

### PRO AP242/ AP242P 14M

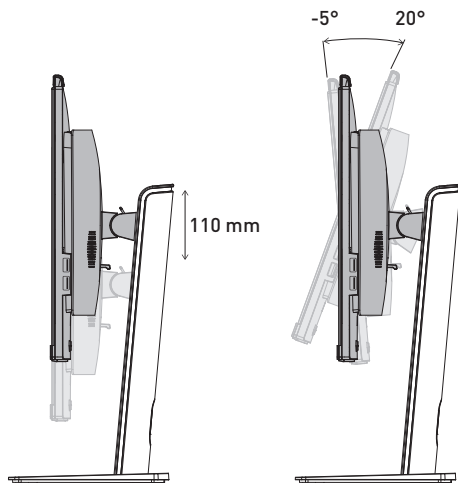

### PRO AP272/ AP272P 14M

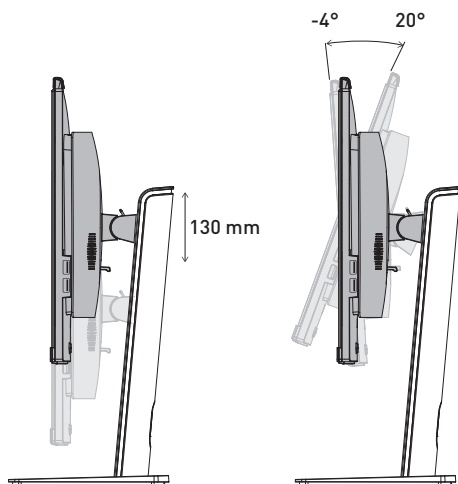

### Important

- Do not use any sharp objects on the display panel.
- Avoid pressing the display panel when adjusting.

# Component Replacement & Upgrade

Please note that certain components preinstalled in the product may be upgradable or replaceable by user's request depending on the models users purchased.

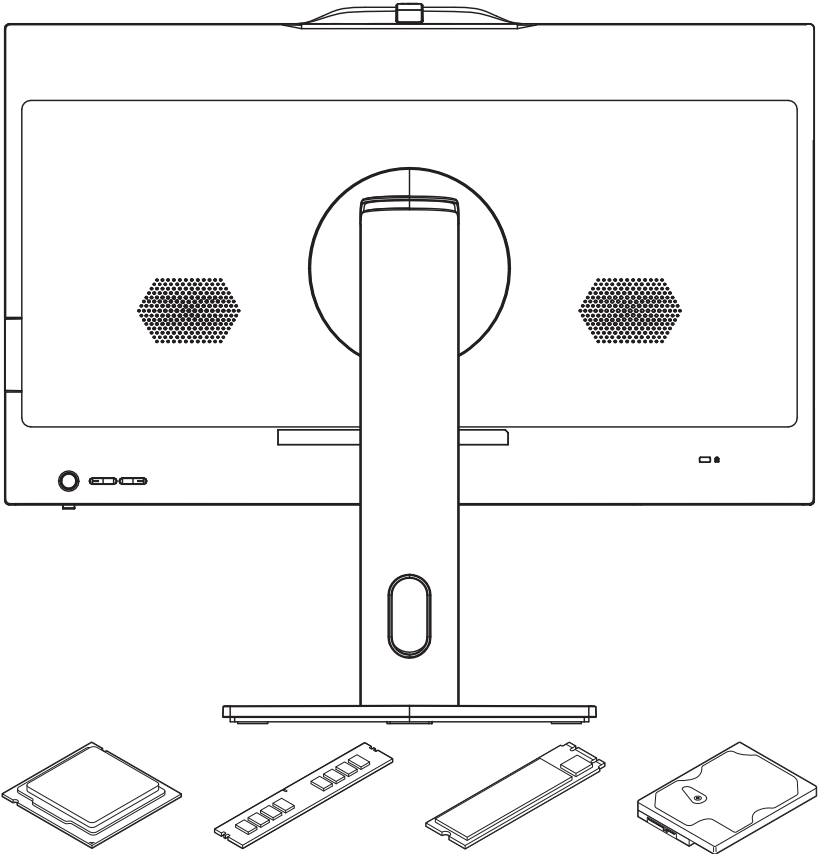

For any further information on the product users purchased, please contact the local dealer. Do not attempt to upgrade or replace any component of the product if you are not an authorized dealer or service center, since it may cause the warranty void. It is strongly recommended that you contact the authorized dealer or service center for any upgrade or replace service.

# Windows 11 System Operations



All information and Windows screenshots are subject to change without prior notice.

## Power Management

Power management of personal computers (PCs) and monitors has the potential to save significant amounts of electricity as well as deliver environmental benefits.

To be energy efficient, turn off your display or set your PC to sleep mode after a period of user inactivity.

1. Right-click [Start] and select [Power Options] from the list.
2. Adjust [Screen and sleep] settings and select a power mode from the list.
3. To choose or customize a power plan, type control panel in the search box and select [Control Panel].
4. Open up [All Control Panel Items] window. Select [Large icons] under [View by] drop-down menu.
5. Select [Power Options] to continue.
6. Select a power plan and fine-tune the settings by clicking [Change plan settings].
7. To create your own power plan, select [Create a power plan].
8. Select an existing plan and give it a new name.
9. Adjust settings for your new power plan.
10. The [Shut down or sign out] menu also presents power saving options for rapid and easy management of your system power.

## Energy Savings

The power management feature allows the computer to initiate a low-power or “Sleep” mode after a period of user inactivity. To take advantage of these potential energy savings, the power management feature has been preset to behave in the following ways when the system is operating on AC power:

- Turn off the display after 10 minutes
- Initiate Sleep after 30 minutes

## Waking the System Up

The computer shall be able to wake up from power saving mode in response to a command from any of the following:

- the power button,
- the network (Wake On LAN),
- the mouse,
- the keyboard.



### Energy Saving Tips:

- Turn off the monitor by pressing the monitor power button after a period of user inactivity.

- Tune the settings in Power Options under Windows OS to optimize your PC's power management.
- Install power saving software to manage your PC's energy consumption.
- Always disconnect the AC power cord or switch the wall socket off if your PC would be left unused for a certain time to achieve zero energy consumption.

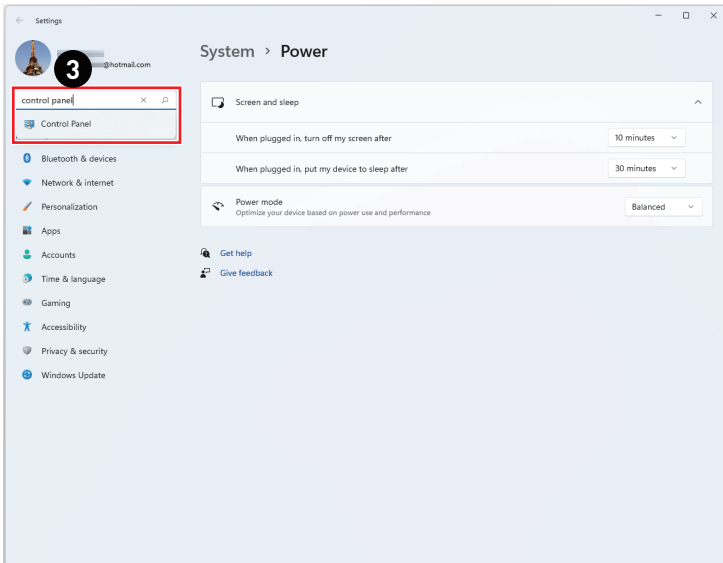
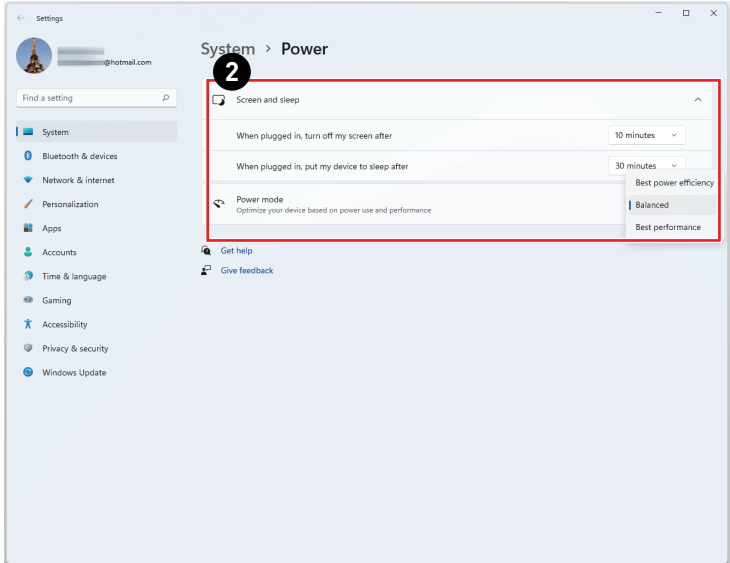
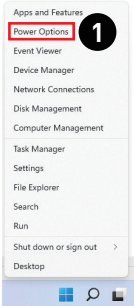



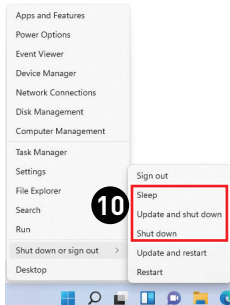
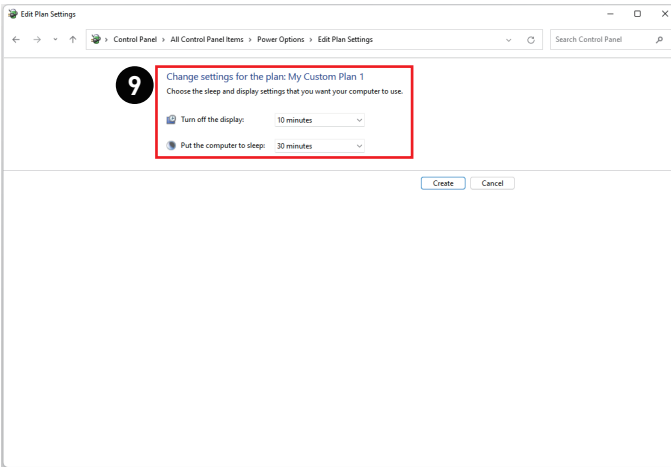
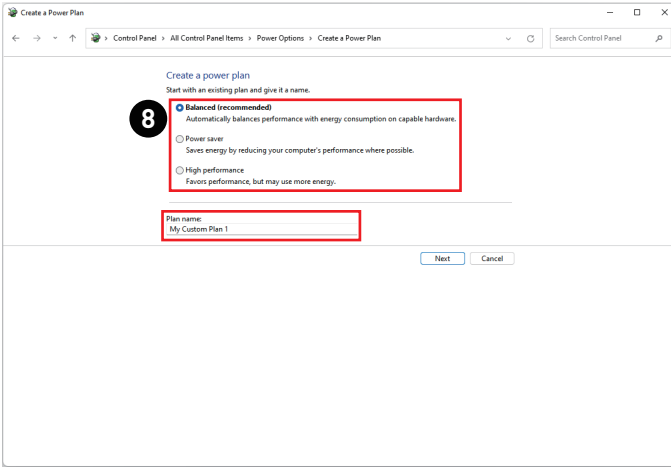



# Network Connections

## Wi-Fi

1. Right-click [Start] and select [Network Connections] from the list.
2. Select and turn on [Wi-Fi].
3. Select [Show available networks]. A list of available wireless networks pops up. Choose a connection from the list.
4. To establish a new connection, select [Manage known networks].
5. Select [Add network].
6. Enter information for the wireless network you intend to add and click [Save] to establish a new connection.

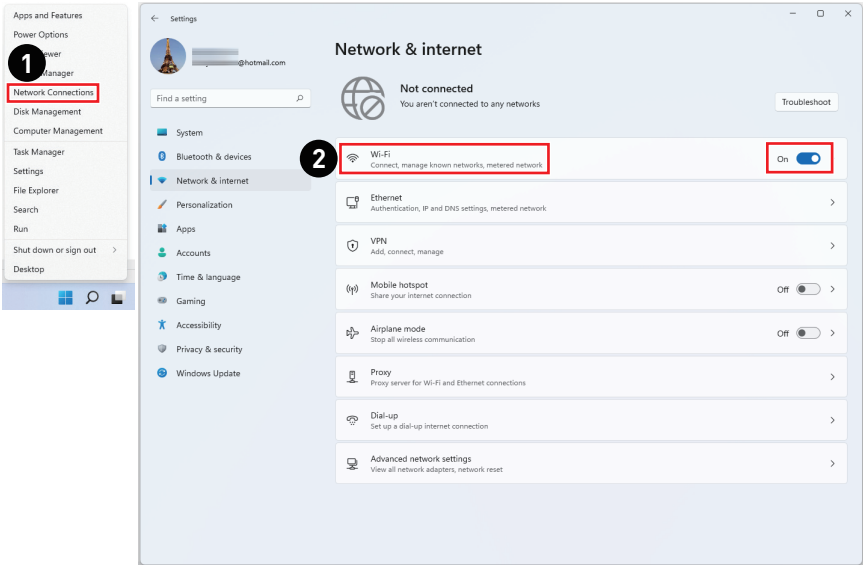

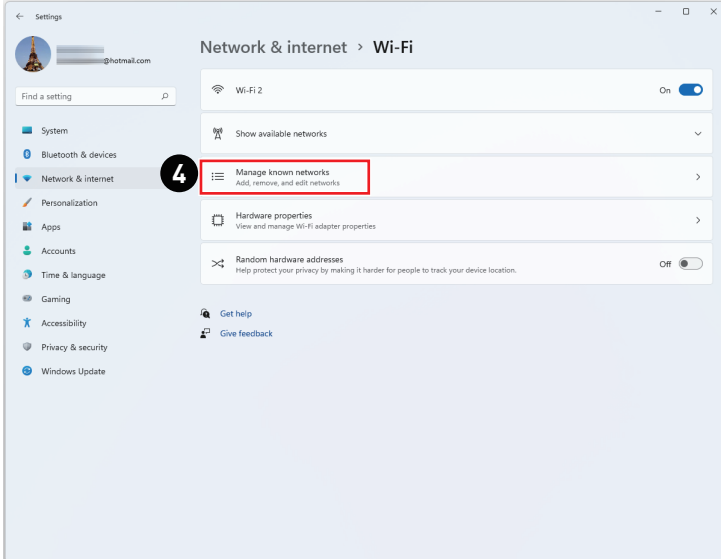
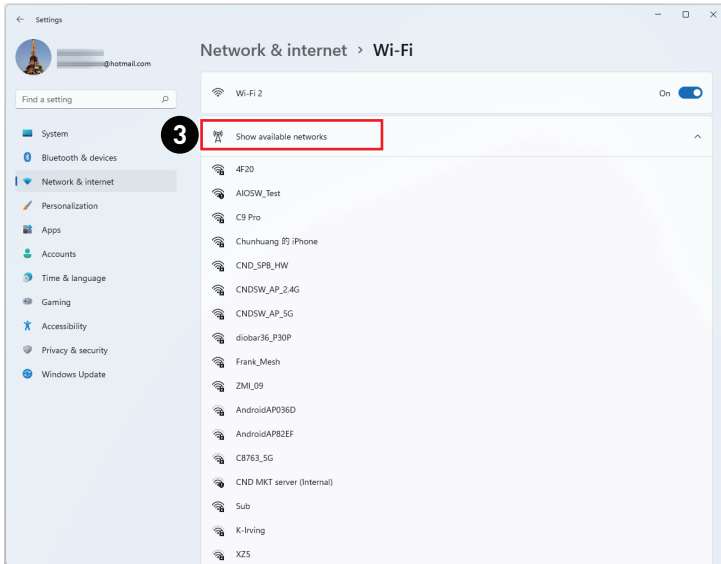

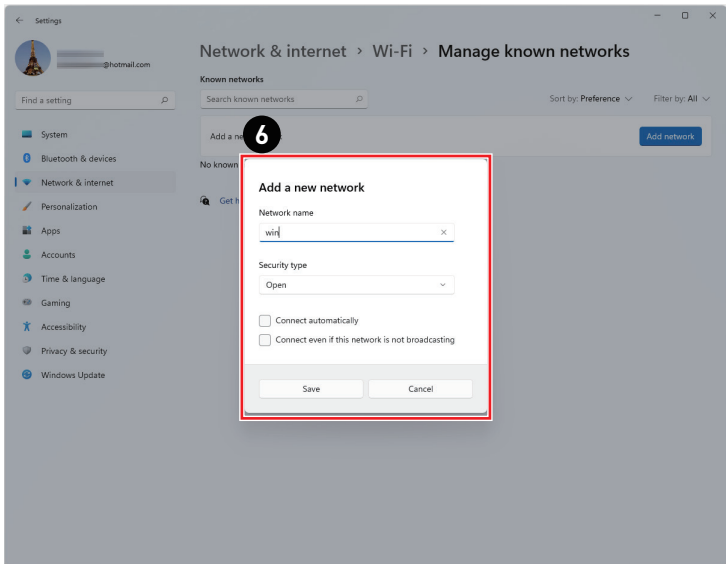
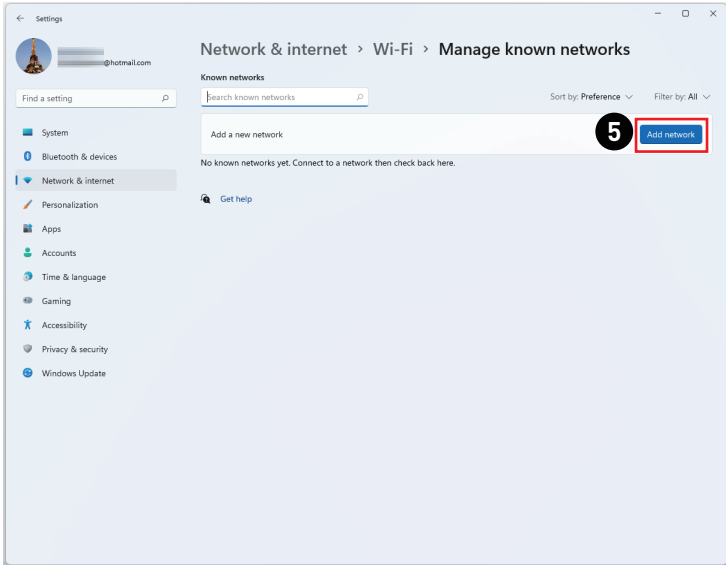

## Ethernet

1. Right-click [Start] and select [Network Connections] from the list.
2. Select [Ethernet].
3. The [IP assignment] and [DNS server assignment] are automatically set as [Automatic (DHCP)].
4. For a Static IP connection, click [Edit] of [IP assignment].
5. Select [Manual].
6. Switch on the [IPv4] or [IPv6].
7. Type the information from your Internet Service Provider and click [Save] to establish a Static IP connection.

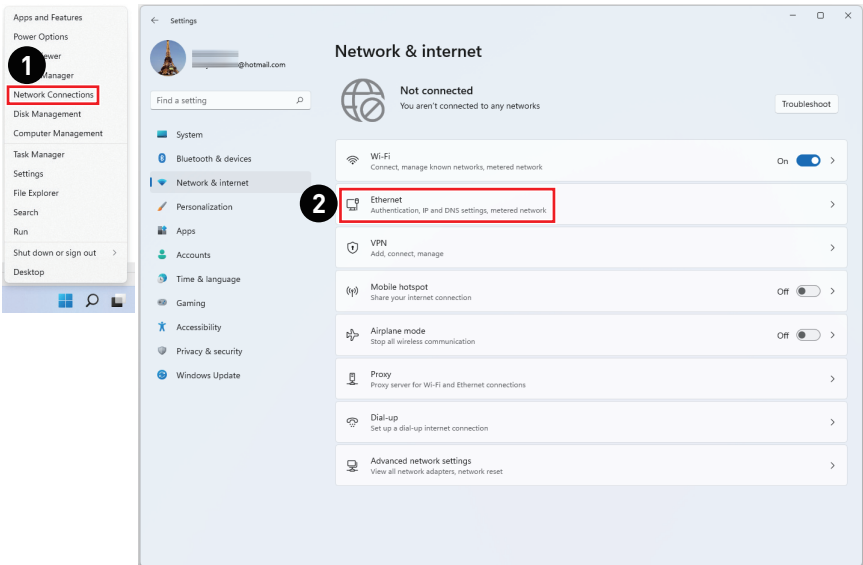

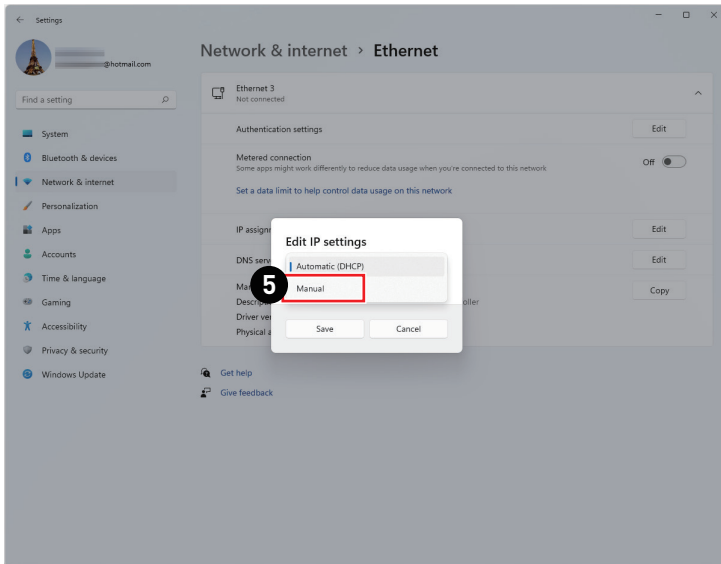
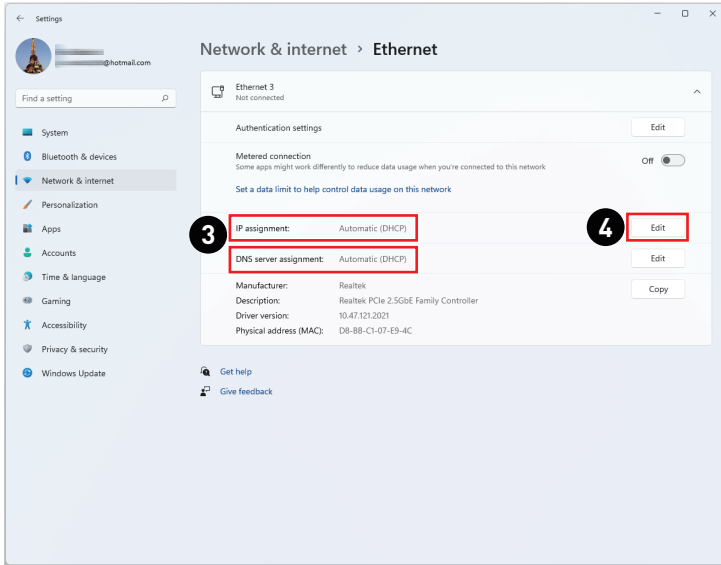

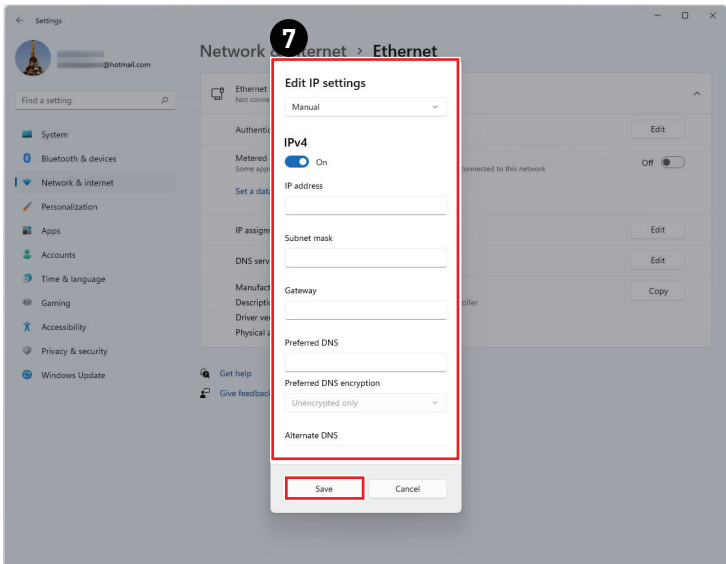
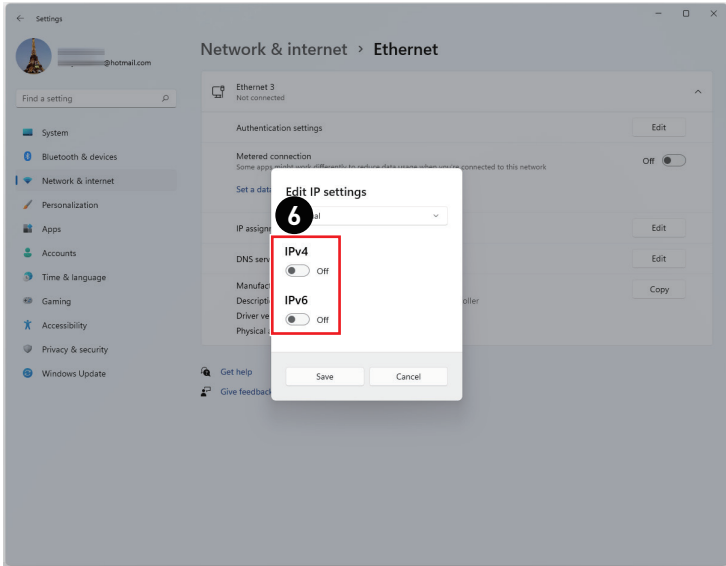

# Dial-up

1. Right-click [Start] and select [Network Connections] from the list.
2. Select [Dial-up].
3. Select [Set up a new connection].
4. Choose [Connect to the Internet] and click [Next].
5. Select [Broadband (PPPoE)] to connect using DSL or cable that requires a user name and password.
6. Type the information from your Internet Service Provider (ISP) and click [Connect] to establish your LAN connection.

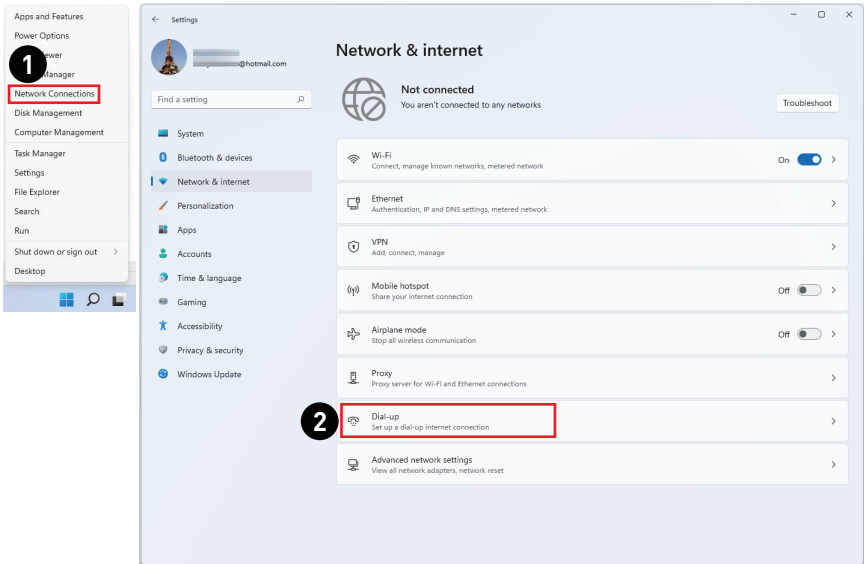

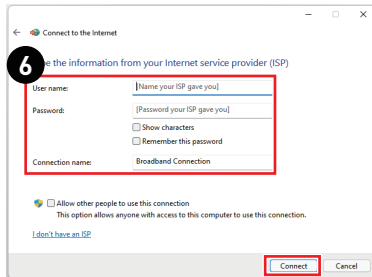
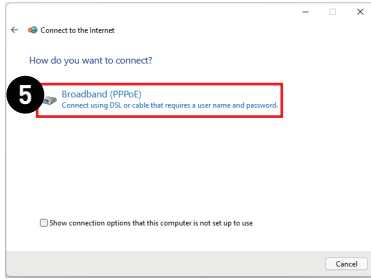
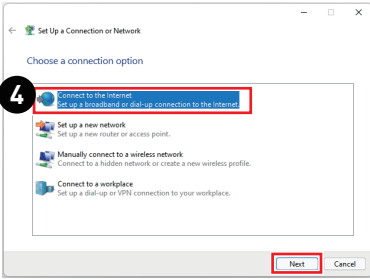
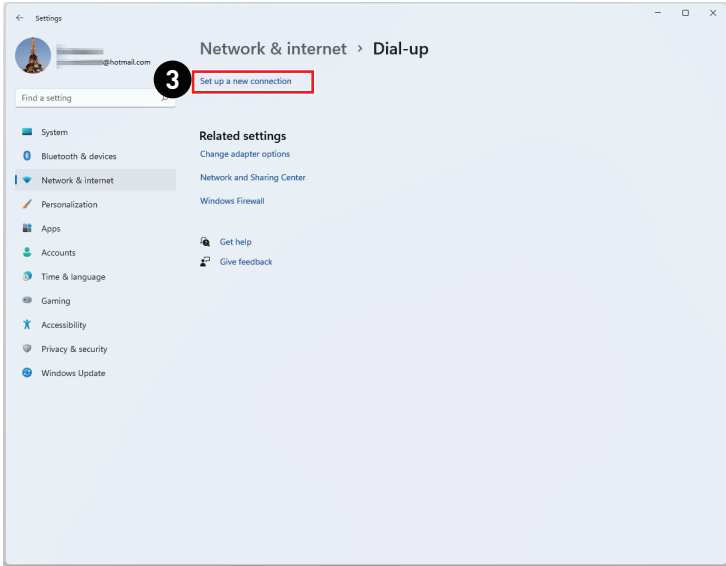



# System Recovery

The purposes for using the System Recovery Function may include:

- Restore the system back to the initial status of original manufacturer's default settings.
- When some errors have occurred to the operating system in use.
- When the operating system is affected by virus and is not able to work normally.
- When you want to install the OS with other built-in languages.

Before using the System Recovery Function, please back up the important data saved on your system drive to other storage devices.

If the following solution fails to recover your system, please contact the authorized local distributor or service center for further assistance.

## Reset this PC

1. Right-click [Start] and select [Settings] from the list.
2. Select [Recovery] under [System].
3. Click [Reset PC] to start the system recovery.
4. The [Choose an option] screen pops up. Choose between [Keep my files] and [Remove everything] and follow the on-screen instructions to complete your system recovery.

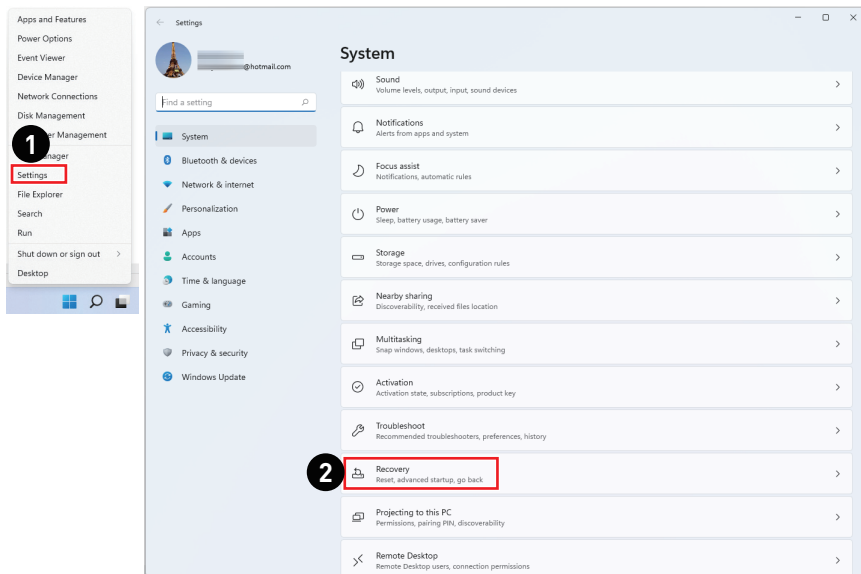

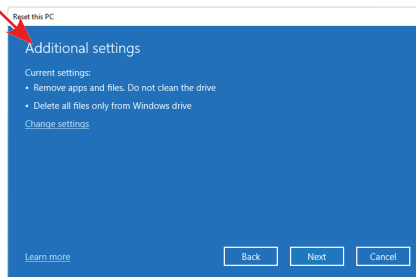
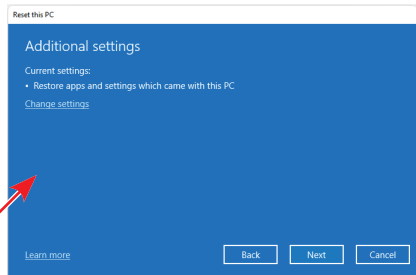
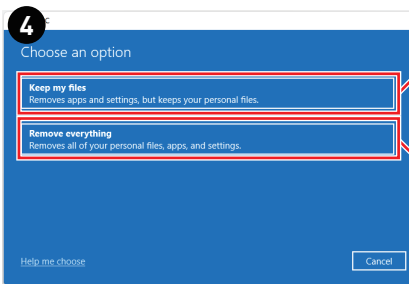
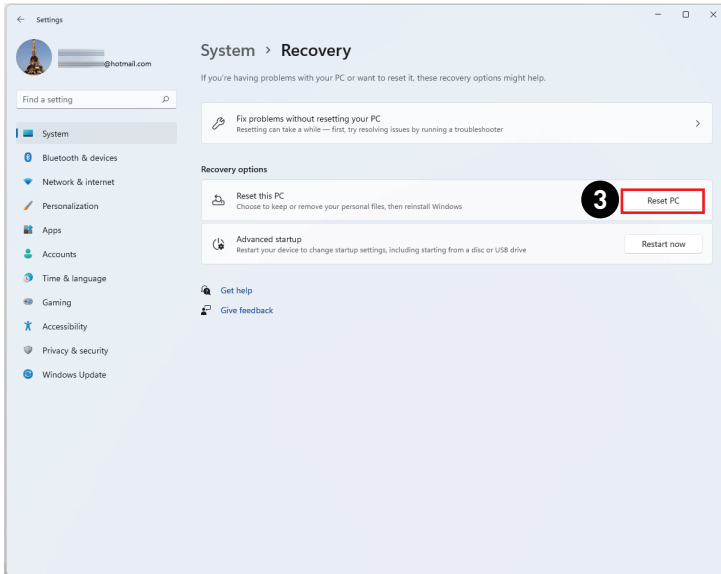

# F3 Hotkey Recovery (Optional)

## Precautions for Using the System Recovery Function

1. If your hard drive and system encountered non-recoverable problems, please use the F3 Hotkey recovery from the Hard Drive first to perform the System Recover Function.
2. Before using the System Recovery Function, please back up the important data saved on your system drive to other storage devices.

## Recovering the system with the F3 Hotkey

Follow the instructions below to continue:

1. Restart the PC.
2. Press the F3 hotkey on the keyboard promptly when the MSI greeting appears on the display.
3. On the [Choose an option] screen, select [Troubleshoot].
4. On the [Troubleshoot] screen, select [Restore MSI factory settings] to reset the system to the default settings.
5. On the [RECOVERY SYSTEM] screen, select [System Partition Recovery].
6. Follow the on-screen instructions to continue and complete the Recovery Function.

# Troubleshooting

## **My system does not start.**

- Check if the system is connected to an electrical outlet and it is turned on.
- Check if the power cord and all cables are connected firmly.

## **When I turn on my computer, the message “Operating System not found” appears or Windows does not start.**

- Check if there is a non-bootable CD/ DVD inside the optical disk drive. If so, remove the CD/ DVD then restart the computer.
- Check Boot Device Priority settings in the BIOS Setup.

## **The system can not be shut down.**

It is best to shut down your computer using the Shut Down icon in the operating system. Using other methods, including those listed below, may result in data failure. If the Shut Down procedure does not work, choose one of the following steps:

- Press Ctrl+Alt+Del keys, then choose Shut Down.
- Press and hold the power button till the system is off.
- Unplug the power cable from the system.

## **My microphone does not work.**

- For built-in microphone, please go to Start > Control Panel > Sounds and Audio Devices > Audio to check if it is muted.
- If you are using an external microphone, check that the microphone is plugged into the Microphone jack.

## **The Internet connection has problems.**

- If you are having a problem connecting to your Internet Service Provider (ISP), check if the ISP is experiencing technical problems.
- Check the Network settings and connection and make sure the system is properly configured to Internet access.
- The wireless LAN data transfer speed is affected by distance and obstructions between devices and access points. To maximize the data transfer speed, choose the access point closest to your system.

## **System speakers do not work.**

- Check the master volume setting in the Audio Mixer.
- If you are using an application that has its own volume control, check if the volume is muted.
- If you have connected an audio cable to the Headphone jack, disconnect it.
- If the system has OSD function, please adjust the volume of OSD.

**System monitor does not display anything.**

- Check if the system is connected to an electrical outlet and it is turned on.
- The system may be in Standby mode. Press any key to activate the Display.

# Safety Instructions

- Read the safety instructions carefully and thoroughly.
- All cautions and warnings on the device or User Guide should be noted.
- Refer servicing to qualified personnel only.

## Power

- Make sure that the power voltage is within its safety range and has been adjusted properly to the value of 100~240V before connecting the device to the power outlet.
- If the power cord comes with a 3-pin plug, do not disable the protective earth pin from the plug. The device must be connected to an earthed mains socket-outlet.
- Please confirm the power distribution system in the installation site shall provide the circuit breaker rated 120/240V, 20A (maximum).
- Always unplug the power cord before installing any add-on card or module to the device.
- Always disconnect the power cord or switch the wall socket off if the device would be left unused for a certain time to achieve zero energy consumption.
- Place the power cord in a way that people are unlikely to step on it. Do not place anything on the power cord.
- If this device comes with an adapter, use only the MSI provided AC adapter approved for use with this device.

## Battery

Please take special precautions if this device comes with a battery.

- Danger of explosion if battery is incorrectly replaced. Replace only with the same or equivalent type recommended by the manufacturer.
- Avoid disposal of a battery into fire or a hot oven, or mechanically crushing or cutting of a battery, which can result in an explosion.
- Avoid leaving a battery in an extremely high temperature or extremely low air pressure environment that can result in an explosion or the leakage of flammable liquid or gas.
- Do not ingest battery. If the coin/button cell battery is swallowed, it can cause severe internal burns and can lead to death. Keep new and used batteries away from children.

### European Union:



Batteries, battery packs, and accumulators should not be disposed of as unsorted household waste. Please use the public collection system to return, recycle, or treat them in compliance with the local regulations.

### BSMI:



廢電池請回收

For better environmental protection, waste batteries should be collected separately for recycling or special disposal.

## California, USA:



The button cell battery may contain perchlorate material and requires special handling when recycled or disposed of in California. For further information please visit: <https://dtsc.ca.gov/perchlorate/>

## Environment

- To reduce the possibility of heat-related injuries or of overheating the device, do not place the device on a soft, unsteady surface or obstruct its air ventilators.
- Use this device only on a hard, flat and steady surface.
- To prevent the device from tipping over, secure the device to a desk, wall or fixed object with an anti-tip fastener that helps to properly support the device and keep it safe in place.
- To prevent fire or shock hazard, keep this device away from humidity and high temperature.
- Do not leave the device in an unconditioned environment with a storage temperature above 60°C or below 0°C, which may damage the device.
- The maximum operating temperature is around 35°C.
- When cleaning the device, be sure to remove the power plug. Use a piece of soft cloth rather than industrial chemical to clean the device. Never pour any liquid into the opening; that could damage the device or cause electric shock.
- Always keep strong magnetic or electrical objects away from the device.
- If any of the following situations arises, get the device checked by service personnel:
  - The power cord or plug is damaged.
  - Liquid has penetrated into the device.
  - The device has been exposed to moisture.
  - The device does not work well or you can not get it working according to the User Guide.
  - The device has dropped and damaged.
  - The device has obvious sign of breakage.

# TÜV Rheinland Certification

## TÜV Rheinland Low Blue Light Certification

Blue light has been shown to cause eye fatigue and discomfort. MSI now offers monitors with TÜV Rheinland Low Blue Light certification to ensure users' eye comfort and well-being. Please follow the instructions below to reduce the symptoms from extended exposure to the screen and blue light.



Low Blue Light  
(Software  
Solution)

[www.tuv.com](http://www.tuv.com)

- Place the screen 20 – 28 inches (50 – 70 cm) away from your eyes and a little below eye level.
- Consciously blinking the eyes every now and then will help to reduce eye strain after extended screen time.
- Take breaks for 20 minutes every 2 hours.
- Look away from the screen and gaze at a distant object for at least 20 seconds during breaks.
- Make stretches to relieve body fatigue or pain during breaks.
- Turn on the optional Low Blue Light function.

## TÜV Rheinland Flicker Free Certification

- TÜV Rheinland has tested this product to ascertain whether the display produces visible and invisible flicker for the human eye and therefore strains the eyes of users.
- TÜV Rheinland has defined a catalogue of tests, which sets out minimum standards at various frequency ranges. The test catalogue is based on internationally applicable standards or standards common within the industry and exceeds these requirements.
- The product has been tested in the laboratory according to these criteria.
- The keyword "Flicker Free" confirms that the device has no visible and invisible flicker defined in this standard within the range of 0 - 3000 Hz under various brightness settings.
- The display will not support Flicker Free when Anti Motion Blur/MPRT is enabled. (The availability of Anti Motion Blur/MPRT varies by products.)



Flicker Free

[www.tuv.com](http://www.tuv.com)



# Regulatory Notices

## CE Conformity

Products bearing the CE marking comply with one or more of the following EU Directives as may be applicable:



- RED 2014/53/EU
- Low Voltage Directive 2014/35/EU
- EMC Directive 2014/30/EU
- RoHS Directive 2011/65/EU
- ErP Directive 2009/125/EC

Compliance with these directives is assessed using applicable European Harmonized Standards.

The point of contact for regulatory matters is MSI-Europe: Eindhoven 5706 5692 ER Son.

## Products with Radio Functionality (EMF)

This product incorporates a radio transmitting and receiving device. For computers in normal use, a separation distance of 20 cm ensures that radio frequency exposure levels comply with EU requirements. Products designed to be operated at closer proximities, such as tablet computers, comply with applicable EU requirements in typical operating positions. Products can be operated without maintaining a separation distance unless otherwise indicated in instructions specific to the product.

## Restrictions for Products with Radio Functionality (select products only)



**CAUTION:** IEEE 802.11x wireless LAN with 5.15~5.35 GHz frequency band is restricted for indoor use only in all European Union member states, EFTA (Iceland, Norway, Liechtenstein), and most other European countries (e.g., Switzerland, Turkey, Republic of Serbia). Using this WLAN application outdoors might lead to interference issues with existing radio services.



### Radio frequency bands and maximum power levels

- Features: Wi-Fi 7, BT
- Frequency Range:
  - 2.4 GHz: 2400~2485MHz
  - 5 GHz: 5150~5350MHz, 5470~5725MHz, 5725~5850MHz
  - 6 GHz: 5955~6415MHz
- Max Power Level:
  - 2.4 GHz: 20dBm
  - 5 GHz: 23dBm
  - 6 GHz: 23dBm

## FCC-B Radio Frequency Interference Statement

This equipment has been tested and found to comply with the limits for a Class B digital device, pursuant to Part 15 of the FCC Rules. These limits are designed to provide reasonable protection against harmful interference in a residential installation. This equipment generates, uses and can radiate radio frequency energy and, if not installed and used in accordance with the instruction manual, may cause harmful interference to radio communications. However, there is no guarantee that interference will not occur in a particular installation. If this equipment does cause harmful interference to radio or television reception, which can be determined by turning the equipment off and on, the user is encouraged to try to correct the interference by one or more of the measures listed below:



- Reorient or relocate the receiving antenna.
- Increase the separation between the equipment and receiver.
- Connect the equipment into an outlet on a circuit different from that to which the receiver is connected.
- Consult the dealer or an experienced radio/television technician for help.

### Notice 1

The changes or modifications not expressly approved by the party responsible for compliance could void the user's authority to operate the equipment.

### Notice 2

Shielded interface cables and AC power cord, if any, must be used in order to comply with the emission limits.

This device complies with Part 15 of the FCC Rules. Operation is subject to the following two conditions:

- this device may not cause harmful interference, and
- this device must accept any interference received, including interference that may cause undesired operation.

### MSI Computer Corp.

901 Canada Court, City of Industry, CA 91748, USA

(626) 913-0828

[www.msi.com](http://www.msi.com)

## WEEE Statement

Under the European Union ("EU") Directive on Waste Electrical and Electronic Equipment, Directive 2012/19/EU, products of "electrical and electronic equipment" cannot be discarded as municipal waste anymore and manufacturers of covered electronic equipment will be obligated to take back such products at the end of their useful life.



## **Chemical Substances Information**

In compliance with chemical substances regulations, such as the EU REACH Regulation (Regulation EC No. 1907/2006 of the European Parliament and the Council), MSI provides the information of chemical substances in products at: <https://csr.msi.com/global/index>

## **RoHS Statement**

### **Japan JIS C 0950 Material Declaration**

A Japanese regulatory requirement, defined by specification JIS C 0950, mandates that manufacturers provide material declarations for certain categories of electronic products offered for sale after July 1, 2006.

<https://csr.msi.com/global/Japan-JIS-C-0950-Material-Declarations>

### **India RoHS**

This product complies with the "India E-waste (Management and Handling) Rule 2016" and prohibits use of lead, mercury, hexavalent chromium, polybrominated biphenyls or polybrominated diphenyl ethers in concentrations exceeding 0.1 weight % and 0.01 weight % for cadmium, except for the exemptions set in Schedule 2 of the Rule.

### **Turkey EEE Regulation**

Conforms to the EEE Regulations of the Republic Of Turkey

### **Ukraine Restriction of Hazardous Substances**

The equipment complies with requirements of the Technical Regulation, approved by the Resolution of Cabinet of Ministry of Ukraine as of 10 March 2017, № 139, in terms of restrictions for the use of certain dangerous substances in electrical and electronic equipment.

### **Vietnam RoHS**

As from December 1, 2012, all products manufactured by MSI comply with Circular 30/2011/TT-BCT temporarily regulating the permitted limits for a number of hazardous substances in electronic and electric products.

## Green Product Features

- Reduced energy consumption during use and stand-by
- Limited use of substances harmful to the environment and health
- Easily dismantled and recycled
- Reduced use of natural resources by encouraging recycling
- Extended product lifetime through easy upgrades
- Reduced solid waste production through take-back policy

## Environmental Policy

- The product has been designed to enable proper reuse of parts and recycling and should not be thrown away at its end of life.
- Users should contact the local authorized point of collection for recycling and disposing of their end-of-life products.
- Visit the MSI website and locate a nearby distributor for further recycling information.
- Users may also reach us at [gpcontdev@msi.com](mailto:gpcontdev@msi.com) for information regarding proper disposal, take-back, recycling, and disassembly of MSI products.



## Warning!

Overuse of screens is likely to affect eyesight.

## Recommendations:

1. Take a 10-minute break for every 30 minutes of screen time.
2. Children under 2 years of age should have no screen time. For children aged 2 years and over, screen time should be limited to less than one hour per day.

## Upgrade and Warranty

Please note that certain components preinstalled in the product may be upgradable or replaceable by user's request. For any further information about the product users purchased, please contact the local dealer. Do not attempt to upgrade or replace any component of the product if you are not an authorized dealer or service center, since it may cause the warranty void. It is strongly recommended that you contact the authorized dealer or service center for any upgrade or replace service.

## Acquisition of Replaceable Parts

Please be noticed that the acquisition of replaceable parts (or compatible ones) of the product users purchased in certain countries or territories may be fulfilled by the manufacturer within 5 years at most since the product has been discontinued, depending on the official regulations declared at the time. Please contact the manufacturer via <https://www.msi.com/support/> for the detailed information about the acquisition of spare parts.

## Copyright and Trademarks Notice



Copyright © Micro-Star Int'l Co., Ltd. All rights reserved. The MSI logo used is a registered trademark of Micro-Star Int'l Co., Ltd. All other marks and names mentioned may be trademarks of their respective owners. No warranty as to accuracy or completeness is expressed or implied. MSI reserves the right to make changes to this document without prior notice.



The terms HDMI™, HDMI™ High-Definition Multimedia Interface, HDMI™ Trade dress and the HDMI™ Logos are trademarks or registered trademarks of HDMI™ Licensing Administrator, Inc.

## Technical Support

If a problem arises with your system and no solution can be obtained from the user's manual, please contact your place of purchase or local distributor. Alternatively, please try the following help resources for further guidance. Visit the MSI website for technical guide, BIOS updates, driver updates and other information via <https://www.msi.com/support/>