

OPERATING INSTRUCTIONS

Read Me First

Personal Computer

Model No. **FZ-G2** series

Contents

Read Me First

Safety Precautions	2
Regulatory Information	8

Getting Started

Before Turning on the Computer	15
First-time Operation.....	16
Detaching the tablet from the keyboard base	23
Attaching the tablet to the keyboard base	25

Appendix

Software License	27
Trademarks	27

■ Terms and illustrations in these instructions

In these instructions, the names and terms are referred as follows.

- The illustration above shows only the tablet without the keyboard base mounted.
- This manual uses the illustrations of the Removable-SSD model for explanation.
- “Windows 10 Pro” as “Windows” or “Windows 10”
- “Windows 11 Pro” as “Windows” or “Windows 11”
- This manual explains operation procedures using the touchpad or mouse as typical examples.

In addition, you can touch the display screen to operate the computer.

When using the touch operation, please replace the terms as described below, and read the instructions.

Operation terms to be replaced:

- Click → Touch

Windows 10 indicates Windows 10 Operating System.

 -  (Settings): Click  (Start) and then click  (Settings).

Windows 11 indicates Windows 11 Operating System.

 - [Settings]: Click  (Start) and then click [Settings].

→ : Page in these Operating Instructions.

 : Reference to the on-screen manuals.

Please read these instructions carefully before using this product, and save this manual for future use.
Update the on-screen manuals.

Safety Precautions

To reduce the risk of injury, loss of life, electric shock, fire, malfunction, and damage to equipment or property, always observe the following safety precautions.

Explanation of symbol word panels

The following symbol word panels are used to classify and describe the level of hazard, injury, and property damage caused when the denotation is disregarded and improper use is performed.

DANGER

Denotes a potential hazard that will result in serious injury or death.

WARNING

Denotes a potential hazard that could result in serious injury or death.



CAUTION

Denotes a hazard that could result in minor injury.

NOTICE

Denotes a hazard that could result in property damage.

The following symbols are used to classify and describe the type of instructions to be observed.

	This symbol is used to alert users to a specific operating procedure that must not be performed.
	This symbol is used to alert users to a specific operating procedure that must be followed in order to operate the unit safely.



DANGER

Precautions on the Battery Pack

Electrolyte leakage, generation of heat, ignition or rupture of the Battery Pack may result.



- **Do Not Throw the Battery Pack into a Fire or Expose It to Excessive Heat**
- **Do Not Deform, Disassemble, or Modify the Battery Pack**
- **Do Not Short the Positive (+) and Negative (-) Contacts**
 - ⇒ Do not place the battery pack together with articles such as necklaces or hairpins when carrying or storing.
- **Do Not Apply Shocks to the Product by Dropping It, Applying Strong Pressure to It, etc.**
 - ⇒ If this product is subjected to a strong impact, remove the battery pack from the computer immediately.
- **Do Not Charge the Battery Using Methods Other Than Those Specified**
- **Do Not Use the Battery Pack with Any Other Product**
 - The battery pack is rechargeable and was intended for the specified product.
- **Do Not Use This Product with a Battery Pack Other Than the One Specified**
 - ⇒ Use only the specified battery pack with your product.



- **Avoid Extreme Heat (Near the Fire, in Direct Sunlight, for Example)**
- **When the Battery Pack Has Deteriorated or If Abnormal Swelling Occur, Replace It with a New One**
 - ⇒ Do not continue to use a damaged battery pack.



DANGER

Precautions on the Battery Pack

Electrolyte leakage, generation of heat, ignition or rupture of the Battery Pack may result.



- **If a Malfunction or Trouble Occurs, Immediately Stop Use**
 - ⇒ If the battery pack appears to be damaged or deformed, or if it emits smoke, abnormal odor, excessive heat, or other abnormality, remove it from the computer immediately.



DANGER

Precautions on the Built-in Bridge Battery (for disposal)

<Only for model with Built-in Bridge Battery>

When disposing the battery, generation of heat, ignition or rupture of the Built-in Bridge Battery may result.



Handling This Computer

- **Do Not Disassemble the Computer Except When Disposing of It**

Handling the Built-in Bridge Battery

- **Do Not Short the Positive (+) and Negative (-) Contacts**
- **Do Not Throw the Battery into a Fire or Expose It to Excessive Heat**
- **Do Not Apply Shocks to the Built-in Bridge Battery by Dropping It, Applying Strong Pressure to It, etc.**
- **Do Not Charge**
- **Do Not Use**
- **Do Not Deform, Disassemble, or Modify the Built-in Bridge Battery**



- **Avoid Extreme Heat (Near the Fire, in Direct Sunlight, for Example)**



WARNING

<Only for model with Built-in Bridge Battery>

Generation of heat, ignition or rupture of the Built-in Bridge Battery may result.



- **Do Not Throw This Product Into a Fire or Expose It to Excessive Heat**
- **Do Not Deform, Disassemble, or Modify This Product**
- **Do Not Apply Shocks to the Product by Dropping It, Applying Strong Pressure to It, etc.**
- **Do Not Charge the Battery Using Methods Other Than Those Specified**



- **Avoid Extreme Heat (Near the Fire, In Direct Sunlight, for Example)**
- **When the Built-in Bridge Battery Has Deteriorated or If Abnormal Swelling Occur, Contact Your Technical Support Office to Replace the Battery**

Fire or electric shock may result.



- **Do Not Do Anything That May Damage the AC Cord, the AC Plug, or the AC Adaptor**
 - Do not damage or modify the cord, place it near hot tools, bend, twist, or pull it forcefully, place heavy objects on it, or bundle it tightly.
 - ⇒ Do not continue to use a damaged AC cord, AC plug and AC adaptor.
 - Contact your technical support office for repair.
- **Do Not Connect the AC Adaptor to a Power Source Other Than a Standard Household AC Outlet**
 - ⇒ Connecting to a DC/AC converter (inverter) may damage the AC adaptor. On an airplane, only connect the AC adaptor/charger to an AC outlet specifically approved for such use.

Safety Precautions

WARNING

Fire or electric shock may result.



- **Do Not Pull or Insert the AC Plug If Your Hands Are Wet**
- **Do Not Disassemble This Product**
 - No user serviceable parts inside this unit. Refer servicing to qualified technician.
- **Do Not Touch This Product In a Thunderstorm If Connected with the AC Cable or Any Other Cables**



- **If a Malfunction or Trouble Occurs, Immediately Stop Use If the Following Malfunction Occurs, Immediately Unplug the AC Plug and the Battery Pack**
 - This product is damaged
 - Foreign object inside this product
 - Smoke emitted
 - Unusual smell emitted
 - Unusually hot

⇒ After the above procedure, contact your technical support office for repair.
- **Clean Dust and Other Debris of the AC Plug Regularly**
 - If dust or other debris accumulates on the plug, humidity, etc. may cause a defect in the insulation.
- **Insert the AC Plug Completely**

⇒ Do not use a damaged plug or loose AC outlet.
- **Close the Connector Cover Tightly When Using This Product Where Is a Lot of Water, Moisture, Steam, Dust, Oily Vapors, etc.**

⇒ If foreign matter has found its way inside, immediately turn the power off and unplug the AC cord, and then remove the battery pack. Then contact your technical support office.
- **Turn the Power off Beforehand when Entering Locations, Such as a Gas Station Where Inflammable Gases Are Generated**
 - Such gases may be ignited.

Burns or low-temperature burns may result.



- **Do Not Use This Product in Close Contact With Your Body For a Long Period of Time**

⇒ Do not use this product with its heat-emitting parts in close contact with your body for a long period of time.

 - Low-temperature burns may result.
- **Do Not Expose Yourself or Other Persons to the Hot Wind from the Ventilation Hole (Exhaust) For a Long Period of Time**
 - Depending on the direction of the computer or the way you hold the computer, your hands and body will be more exposed to the hot wind.
 - Covering the ventilation hole (exhaust) with your hand or other object can cause heat to build up inside, possibly resulting in burns.
- **Do Not Touch The Surface of The AC Adaptor Continuously While Using/Charging**
 - Burns may result.
- **Do Not Place the Product in a Bag or Case While It is Turned On**
 - Doing so may cause the product to overheat and result in burns.

Detrimental health effects on your body may result.



- **Do Not Turn the Volume Up Too Loud When Using Headphones**
 - Listening at high volumes that overstimulate the ear for long periods of time may result in loss of hearing.

<Only for model with wireless WAN>
- **Do Not Leave a nanoSIM Card within Reach of Infants**

⇒ In case of swallowing, consult a doctor immediately.



WARNING

Radio waves transmitted from this product may affect the surrounding area.



■ **Do Not Use This Product near Automatic Control Devices, Such As Automatic Doors And Fire Alarms**

- Automatic control devices may malfunction, resulting in accidents.



■ **Turn the Power Off on an Airplane^{*1}**

- ⇒ For use on a plane, follow the airline's instructions.
- The safety of navigation may be compromised.

■ **Turn the Power Off in Hospitals or at Locations Where Medical Equipment is Present^{*1}**

- ⇒ Do not bring this product into operating rooms, intensive care units, CCU, etc.^{*2}
- Medical electrical equipment may be affected, and malfunction may occur, resulting in accidents.

■ **Turn the Power Off in Crowded Locations, Such As a Crowded Train, Where There May Be a Person with a Cardiac Pacemaker**

- The operation of a pacemaker may be affected.

■ **Keep This Product at Least 15 cm Away from the Position of an Implantable Pacemaker**

- The operation of a pacemaker may be affected.

^{*1} If there is no choice but to use this product in such an environment, turn the wireless capability off. However, bear in mind that use of a computer may be prohibited during takeoff and landing of an aircraft, etc. even if the wireless capability is turned off.

^{*2} CCU is an abbreviated term of Coronary Care Unit.



CAUTION

Fire or electric shock may result.



■ **Do Not Move This Product While the AC Plug Is Connected**

- ⇒ If the AC cord is damaged, unplug the AC plug immediately.

■ **Do Not Connect a Telephone Line, or a Network Cable Other Than the One Specified, Into the LAN Port**

- ⇒ Do not connect to a network such as the ones listed below.
- Networks other than 1000BASE-T, 100BASE-TX or 10BASE-T
- Phone lines (IP phone (Internet Protocol Telephone), Telephone lines, internal phone lines (on-premise switches), digital public phones, etc.)

■ **Do Not Subject the AC Adaptor To Any Strong Impact**

- ⇒ Do not continue to use the AC adaptor after a strong impact such as being dropped.
- ⇒ Contact your technical support office for repair.

■ **Do Not Leave This Product in High Temperature Environment for a Long Period of Time**

- Leaving this product where it will be exposed to extremely high temperatures such as near fire or in direct sunlight may deform the cabinet and/or cause trouble in the internal parts.

■ **Do Not Block the Ventilation Hole (Exhaust/Intake)**

- ⇒ Do not use this product wrapped in cloth or on top of bedding or a blanket.

Safety Precautions



CAUTION

Fire or electric shock may result.



- **Hold the Plug When Unplugging the AC Plug**
- **Use Only the Specified AC Adaptor With This Product**
 - ⇒ Do not use an AC adaptor other than the one supplied (supplied with the unit or one sold separately as an accessory).

This product may fall over or drop, resulting in an injury.



- **Do Not Place This Product on Unstable Surfaces**



- **Avoid Stacking**
- **When Carrying the Computer, Attach the Tablet To the Keyboard Base Tightly Until Orange-colored Signs Under the Detach Lock And Release Lever Are Concealed.**

Detrimental health effects on your body may result.



- **Take a Break Of 10-15 Minutes Every Hour**
 - Using this product for long periods of time may have detrimental health effects on the eyes or hands.

Burns, low-temperature burns, or frostbite may result.



- **Do Not Expose the Skin To This Product When Using the Product In A Hot Or Cold Environment**
 - ⇒ When it is necessary to expose the skin to this product such as to scan a fingerprint, perform the operation in the shortest time possible.

NOTICE

- Do not place the computer near a television or radio receiver.
- Keep the computer away from magnets. Data stored on the flash memory may be lost.
- This computer is not intended for the display of images for use in medical diagnosis.
- This computer is not intended for a use with connection of medical equipment for the purpose of medical diagnosis.
- Panasonic shall not be liable for loss of data or other incidental or consequential damages resulting from the use of this product.
- Do not touch the terminals on the battery pack. The battery pack may no longer function properly if the contacts are dirty or damaged.
- Do not expose the battery pack to water, or allow it to become wet.
- If the battery pack will not be used for a long period of time (a month or more), charge or discharge (use) the battery pack until the remaining battery level becomes 30% to 40% and store it in a cool, dry place.
- This computer prevents overcharging of the battery by recharging only when the remaining power is less than approx. 95% of capacity.
- The battery pack is not charged when the computer is first purchased. Be sure to charge it before using it for the first time. When the AC adaptor is connected to the computer, charging begins automatically.
- Should the battery leak and the fluid get into your eyes, do not rub your eyes. Immediately flush your eyes with clear water and see a doctor for medical treatment as soon as possible.

NOTE

- The battery pack may become warm during recharging or normal use. This is completely normal.
- Recharging will not commence if internal temperature of the battery pack is outside of the allowable temperature range (0 °C to 50 °C). (→  *Operating Instructions - Reference Manual* “Basic Operation” “Battery Power”) Once the allowable range requirement is satisfied, charging begins automatically. Note that the recharging time varies based on the usage conditions. (Recharging takes longer than usual when the temperature is 10 °C or below.)
- If the temperature is low, the operating time is shortened. Only use the computer within the allowable temperature range.
- The battery pack is a consumable item. If the amount of time the computer can be run by using a particular battery pack becomes dramatically shorter and repeated recharging does not restore its performance, the battery pack should be replaced with a new one.
- When transporting a spare battery inside a package, briefcase, etc., it is recommended that it be placed in a plastic bag so that its contacts are protected.
- Always power off the computer when it is not in use. Leaving the computer on when the AC adaptor is not connected will exhaust the remaining battery capacity.
- <Only for model with Built-in Bridge Battery>
To minimize deterioration of the built-in bridge battery, connect the computer to the AC adaptor and recharge it for approximately 2 hours about once every year.

The product is not intended for use as, or as part of nuclear equipment/systems, air traffic control equipment/systems, aircraft equipment/systems (as defined in ^{*3}), medical devices or accessories (as defined in ^{*4}), medical treatment diagnosis image display, life-support system, or other equipment/devices/systems that are involved with ensuring human life or safety. Our products are not intended to be utilised as an integral component of the systems used in such environments and, as such, the use of our products in such environments is not recommended. Panasonic can not be held responsible in any way for any damage or loss resulting from the use of this unit in these types of equipment, devices or systems, etc.

^{*3} Aircraft equipment/systems include Electric Flight Bag (EFB) systems are defined by FAA AC120-76D or EASA Commission Regulation (EU) No 965/2012.

^{*4} As defined by the Regulation (EU) 2017/745 Medical Device Regulation.

Panasonic cannot guarantee any specifications, technologies, reliability, safety (e.g. flammability/ smoke/toxicity/radio frequency emission, etc.) requirement related to aviation standards that exceed the specifications of our COTS products.

As with any portable computer device precautions should be taken to avoid any damage. The following usage and handling procedures are recommended.

Before putting the computer away, be sure to wipe off any moisture.

Regulatory Information

Information to the User

<Only for model with wireless LAN/Bluetooth/wireless WAN>

This product and your Health

This product, like other radio devices, emits radio frequency electromagnetic energy. The level of energy emitted by this product however is far much less than the electromagnetic energy emitted by wireless devices like for example mobile phones.

Because this product operates within the guidelines found in radio frequency safety standards and recommendations, we believe this product is safe for use by consumers. These standards and recommendations reflect the consensus of the scientific community and result from deliberations of panels and committees of scientists who continually review and interpret the extensive research literature.

In some situations or environments, the use of this product may be restricted by the proprietor of the building or responsible representatives of the organization. These situations may for example include:

- Using this product on board of airplanes, or
- In any other environment where the risk of interference to other devices or services is perceived or identified as harmful.

If you are uncertain of the policy that applies on the use of wireless devices in a specific organization or environment (e.g. airports), you are encouraged to ask for authorization to use this product prior to turning on the product.

Regulatory Information

We are not responsible for any radio or television interference caused by unauthorized modification of this product. The correction of interference caused by such unauthorized modification will be the responsibility of the user. We and its authorized resellers or distributors are not liable for damage or violation of government regulations that may arise from failing to comply with these guidelines.

26-E-1

Laser Devices

<Only for model with Barcode Reader>



This equipment is using lasers that comply with IEC60825-1:2014, EN 60825-1:2014 and JIS C6802:2014 regulations.

The laser is a "Class 2" laser which is indicated on the label for this product. Class 2 laser readers use a low power, visible light diode. As with any very bright light source, such as the sun, the user should avoid staring directly into the light beam. Momentary exposure to a Class 2 laser is not known to be harmful. Caution-Use of controls or adjustments or performance of procedures other than those specified herein may result in hazardous radiation exposure.

Labeling/Marking

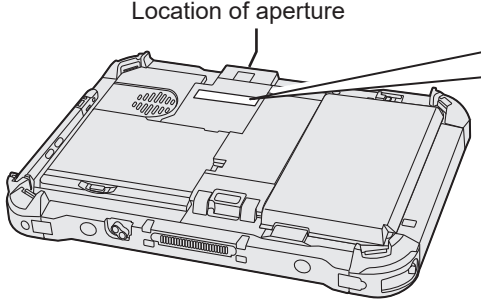
Location of aperture



	LASER 2 LASER 2 LEZER 2 レーザークラス2	
650nm, 1mW MAX, 16.8ms IEC60825-1:2014 EN60825-1:2014 JIS C6802:2014		
激光辐射 勿直视光束 2类激光产品	650 nm, 16.8ms 1 mW MAX GB7247.1-2012	Complies with 21 CFR 1040.10 and 1040.11 except for conformance with IEC 60825-1:Ed. 3, as described in Laser Notice No. 56, dated May 8, 2019, 130KS

Beam Divergence
- Vertical angle: 30 degree
- Horizontal angle: 36 degree

650 nm, 1 mW MAX, 16.8 ms

13-E-1

LED Light

<For model with rear camera>
<For model with Barcode Reader>

CAUTION

- The light from the LED is strong and can injure human eyes.
Do not look directly at the LEDs with naked eyes.



57-E-1

USB Type-C Adaptors and Cables

Use USB Type-C adaptors and cables comply with IEC 62680-1-2 (USB Power Delivery Specification).

Lithium Battery

Lithium Battery!

This computer contains a lithium battery to enable the date, time, and other data to be stored. The battery should only be exchanged by authorized service personnel.

Warning!

A risk of explosion from incorrect installation or misapplication may possibly occur.

15-E-1

Battery Pack

CAUTION:

Risk of Explosion if Battery is replaced by an Incorrect Type. Dispose of Used Batteries According to the Instructions.

58-E-1

Handling of lithium ion battery pack



Do not charge, use, or leave the battery in extremely high temperature or extremely low air pressure like high altitude where ordinary not entered, as this may result in explosion or leakage of flammable liquids.

Battery pack model number	FZ-VZSU1TU series	FZ-VZSU1UU series	FZ-VZSU1VU series
Recommended charging condition	13.05 V / 3052 mA (Constant voltage/current)	12.6 V / 3150 mA (Constant voltage/current)	
Charging Limit Voltage	13.05 V: 0 - 45 °C (Charging start temperature: 2 °C and over) 12.6 V: 45 - 60 °C	12.6 V: 0 - 45 °C (Charging start temperature: 2 °C and over) 12.15 V: 45 - 60 °C	
Notice	<ul style="list-style-type: none">● Dispose of used battery pack according to local ordinances and/or regulations.● Do not expose this computer to temperatures greater than 60°C.		

Regulatory Information

Energy Star



Read Me First

<p><Only for model with the above logo on the computer></p>	<p>As an ENERGY STAR® Partner, Panasonic Corporation has determined that this product meets ENERGY STAR® guidelines for energy efficiency. By enabling available power management settings, Panasonic computers enter a low-power sleep mode after a period of inactivity, saving the user energy.</p> <p>Outline of the International ENERGY STAR® Office Equipment Program The international ENERGY STAR® Office Equipment Program is an international program that promotes energy saving through the use of computers and other office equipment. The program backs the development and dissemination of products with functions that effectively reduce energy consumption. It is an open system in which business proprietors can participate voluntarily. The targeted products are office equipment such as computers, displays, printers, facsimiles, and copiers. Their standards and logos are uniform among participating nations.</p>
<p><Only for model without the above logo on the computer></p>	<p>This model is not applied to the ENERGY STAR® Office Equipment Program.</p>

22-E-2

Regulations for Wireless LAN / Bluetooth

<Only for model with wireless LAN/Bluetooth>

Country / Region	802.11a	802.11b/g Bluetooth
Austria, Belgium, Croatia, Cyprus, Czech Republic, Denmark, Estonia, Finland, France, Germany, Greece, Hungary, Iceland, Ireland, Latvia, Lithuania, Luxembourg, Macedonia, Malta, Netherlands, Poland, Portugal, Slovakia, Slovenia, Spain, Sweden, Switzerland, United Kingdom	Restricted to indoor use.	
Italy	Restricted to indoor use. General authorization required if used outside.	General authorization required if used outside of own premises.
Norway	Restricted to indoor use.	Prohibited within a 20 km radius from the centre of Ny-Ålesund.

- The latest version of “ERC RECOMMENDATION 70-03” by European Radiocommunications Committee and the regulation in Turkey.
- Use only the antenna specified by Panasonic.
- Confirm the latest information to the radio regulation authorities.

40-E-1

Interface Cable

Use of an interface cable longer than 3 m is not recommended.

11-E-1

For Used in Motor Vehicle

Warning: Check the following Commission Recommendation to determine proper installation and usage of this product while operating within a motor vehicle.

“Commission Recommendation on safe and efficient in-vehicle information and communication systems: A European statement of principles on human machine interface.”

Commission Recommendation is available from Official Journal of the European Communities.

35-E-1

Disposal of Old Equipment and Batteries Only for European Union and countries with recycling systems



These symbols on the products, packaging, and/or accompanying documents mean that used electrical and electronic products and batteries must not be mixed with general household waste. For proper treatment, recovery and recycling of old products and batteries, please take them to applicable collection points, in accordance with your national legislation. By disposing of them correctly, you will help to save valuable resources and prevent any potential negative effects on human health and the environment.

For more information about collection and recycling, please contact your local municipality. Penalties may be applicable for incorrect disposal of this waste, in accordance with national legislation.

Note for the battery symbol (bottom symbol)



This symbol might be used in combination with a chemical symbol. In this case it complies with the requirement set by the Directive for the chemical involved.

36-E-1

Regulatory Information

For Europe

For CE marking, refer to the followings:

Declaration of Conformity (DoC)

“Hereby, Panasonic declares that this computer is in compliance with the essential requirements and other relevant provisions of the Directive 2014/53/EU.”

Hint:

If you want to get a copy of the original DoC of our above mentioned products, please contact our web address: <https://www.ptc.panasonic.eu/>

Authorised Representative:

Panasonic Testing Centre

Panasonic Marketing Europe GmbH

Winsbergring 15, 22525 Hamburg, Germany

18-E-1

Maximum radio - frequency power transmitted in the frequency bands

Type of wireless	Frequency band	Maximum transmit power
WLAN	2412 - 2472 MHz	20 dBm
	5150 - 5250 MHz (W52)	23 dBm
	5250 - 5350 MHz (W53)	23 dBm
	5470 - 5725 MHz (W56)	23 dBm
Bluetooth	2402 - 2480 MHz	20 dBm
HF-RFID (Contactless Smart Card Reader)	13.56 MHz	42 dBuA/m at 10 m

Information about the Energy Efficiency of the AC Adaptor

Please visit our website, www.panasonic.com, and enter the model number on the AC adaptor (11 or 12 characters, including dash “-”, excluding space) in the search box.

<Only for model with external antenna>

When using Port Replicator or Car Mounter on which an external antenna can be installed:

- External antenna for wireless LAN must be professionally installed.
- The gain of external antenna for wireless LAN must not exceed 5 dBi.
- The user must maintain minimum of 20 cm spacing between the external antenna and all people (excluding extremities of hands, wrist and feet) during wireless modes of operation.

41-E-1

<Only for model with wireless WAN>

When utilizing the wireless functionality, it requires a minimum 5 mm spacing from the body (excluding extremities such as hands, wrist and feet) around the whole sides except bottom of the LCD display.

60-E-1



AC cord with BS 1363 plug

<For model that has a AC cord with BS 1363 plug>

For your safety, please read the following text carefully.

This appliance is supplied with a molded three pin mains plug for your safety and convenience. A 3 ampere fuse is fitted in this plug.

Should the fuse need to be replaced please ensure that the replacement fuse has a rating of 3 ampere and that it is approved by ASTA or BSI to BS1362.

Check for the ASTA mark  or the BSI mark  on the body of the fuse.

If the plug contains a removable fuse cover you must ensure that it is refitted when the fuse is replaced.

If you lose the fuse cover the plug must not be used until a replacement cover is obtained. A replacement fuse cover can be purchased from your local dealer.

If the fitted molded plug is unsuitable for the socket outlet in your home then the fuse should be removed and the plug cut off and disposed of safely.

There is a danger of severe electrical shock if the cut off plug is inserted into any 13-ampere socket.

How to replace the fuse

The location of the fuse differs according to the type of AC mains plug (figures A and B).

Confirm the AC mains plug fitted and follow the instructions below. Illustrations may differ from actual AC mains plug.

Open the fuse cover with a screwdriver and replace the fuse and close or attach the fuse cover.

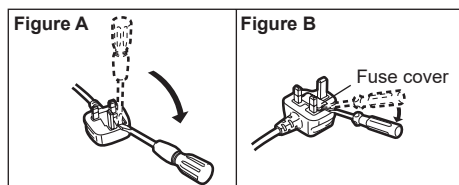

8-E-1

For Australia

For Used in Motor Vehicle

Warning: Notebook Computer may be installed in a motor vehicle and visible to the driver only if used to support vehicle related functions such as vehicle information, system control, rear or side observation and navigation. If the Notebook Computer is to be used for work or entertainment purposes, such as television reception, video play or other work programs, it must be installed in a position where it will NOT:

- (a) be visible, directly or indirectly, to the operator of the motor vehicle; or
- (b) cause distraction to drivers of other motor vehicles.

Check with individual state laws to determine lawful use of this product while operating within a motor vehicle. If the visual display unit is, or is part of, a driver's aid, above rule is not applied. "Driver's aid" includes closed-circuit television security cameras, dispatch systems, navigational or intelligent highway and vehicle system equipment, rear view screens, ticket-issuing machines and vehicle monitoring devices.

35-A-1

For Turkey

Accordance with the WEEE Regulation.

Disposal of Old Equipment and Batteries Only for European Union and countries with recycling systems



These symbols on the products, packaging, and/or accompanying documents mean that used electrical and electronic products and batteries must not be mixed with general household waste. For proper treatment, recovery and recycling of old products and batteries, please take them to applicable collection points in accordance with your national legislation.



By disposing of them correctly, you will help to save valuable resources and prevent any potential negative effects on human health and the environment. For more information about collection and recycling, please contact your local municipality.

Penalties may be applicable for incorrect disposal of this waste, in accordance with national legislation.

66-E_Tr-1

Regulatory Information

For India

Declaration of Conformity with the requirements of the E-Waste (Management) Rules

The Product is in conformity with the requirements of the reduction of hazardous substances of the E-Waste Rules.

The content of hazardous substance with the exemption of the applications listed in SCHEDULE II of the E-waste Rules:

1. Lead (Pb) - not over 0.1% by weight;
2. Cadmium (Cd) - not over 0.01% by weight;
3. Mercury (Hg) - not over 0.1% by weight;
4. Hexavalent chromium (Cr6+) - not over 0.1% by weight;
5. Polybrominated biphenyls (PBBs) - not over 0.1% by weight;
6. Polybrominated diphenyl ethers (PBDEs) - not over 0.1% by weight.



For the purpose of recycling to facilitate effective utilization of resources, please return this product to a nearby authorized collection center, registered dismantler or recycler, or Panasonic service center when disposing of this product.

Please see the Panasonic website for further information on collection centers, etc. , or call the toll-free number below.

Website:

<https://www.panasonic.com/in/corporate/sustainability/panasonic-india-i-recycle-program.html>

Service helpline: 1800 103 1333 or 1800 108 1333

Do's & Don'ts: - E-Waste (Management) Amendment Rules 2018

S.No.	Do's	Don'ts
1	All electrical and electronic products are required to be handed over only to the Authorized recycler.	The product should not be opened by the User himself/herself, but only by authorized service personnel.
2	The product should be handed over only to authorized recycler for disposal.	The product is not meant for re-sale any unauthorized agencies/scrap dealer/kabariwalahs.
3	Keep the product in isolated area, after it becomes non-functional/un-repairable so as to prevent its accidental breakage.	The product is not meant for mixing into household waste stream.
4	For more information about collection and recycling, please contact your local municipality.	Do not keep any replaced spare part(s) from the product in exposed area.
5	Always Dispose products that have reached end-of life at Panasonic India authorized service center.	Do not donate old electronic items to anybody.
6	Wherever possible or as instructed, separate the packaging material according to responsible waste disposal options and sorting for recycling.	Do not give e-waste to informal and unorganized sectors like Local Scrap Dealer/Rag Pickers.
7	Create environment awareness PAN India Level.	Do not dispose your product in garbage bins along with municipal waste that ultimately reaches landfill.

68-M-3

Before Turning on the Computer

Refer to the following URL for how to attach options to the Expansion bays. Confirm the part numbers of the optional items before connection.

<https://askpc.panasonic.co.jp/manual/option/w/>



Expansion Bays

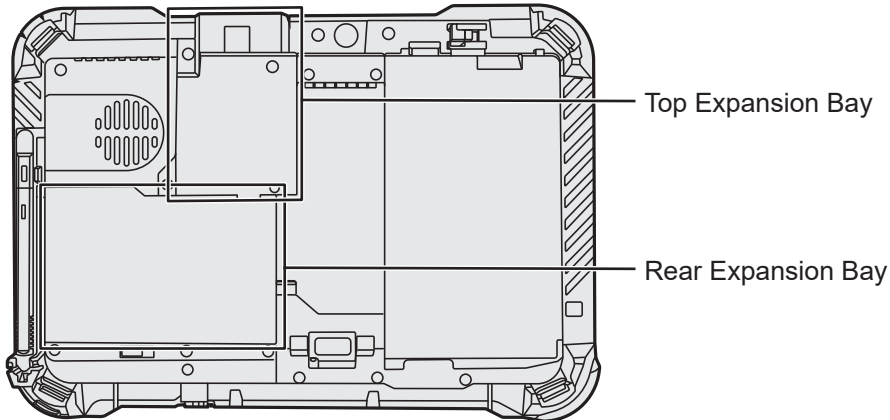

IMPORTANT

- If the above options are not attached, be sure to attach a dummy pack or cover before using.

First-time Operation

■ Preparation

① Check and identify the supplied accessories.

If you do not find the described accessories, contact your support office.

• **AC Adaptor** 1

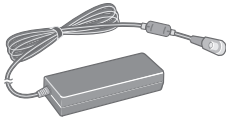

Model No: CF-AA5713A

• **AC Cord** 1

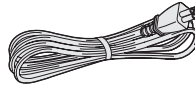

• **Battery Pack^{*1}** . . . 1

Model No: FZ-VZSU1TU/
FZ-VZSU1UU/
FZ-VZSU1VU

• **Soft Cloth** 1



• **Tether** 1



• **Digitizer pen** 1

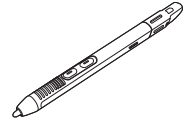

• **OPERATING INSTRUCTIONS - Read Me First (This book)** 1

Depending on the model, the following items are supplied.

• **Keyboard Base** 1

The keyboard base is attached to the tablet at the time of packing.

• **Hand Strap** 1

^{*1} Stored in the tablet at the time of packing.

■ Latest Information on Windows

When Windows is updated, the screen display or operation procedures may be changed. For the latest information on Windows, see the following web page.

(Windows 10) <https://pc-dl.panasonic.co.jp/itn/addendum/>

(Windows 11) <https://pc-dl.panasonic.co.jp/itn/win11>

■ To Windows 11 preinstalled model users

The Operating Instructions of this computer use Windows 10 in the descriptions. Since the screen display, operation procedures, etc. differ, see the following web page, and replace the descriptions with those for Windows 11.

<https://pc-dl.panasonic.co.jp/itn/win11/>

■ To Windows 10 downgrade model users

This system is preinstalled with Windows 10 Pro software and also comes with a license for Windows 11 Pro software. For details, see the following web page.

<https://pc-dl.panasonic.co.jp/itn/win11/>

1 Use the tether to attach the pen (included) to the computer

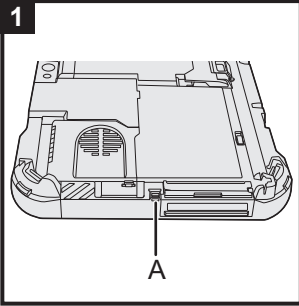

Use the tether to attach the pen to the computer so you will not lose it. Perform the following steps to attach the tether to the pen (① and ②) and the computer (③ and ④).

① Pass one of the loops through the hole.

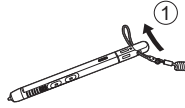

② Pass one of the loops through another loop.

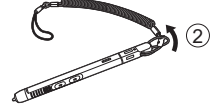

③ Thread the second loop on the tether through the hole (A) as illustrated.

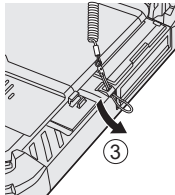

④ Pass the pen and tether through the second loop.

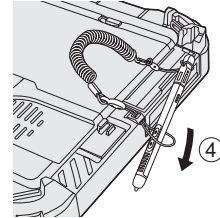

IMPORTANT

- Do not pull the tether with excessive force. The stylus may hit the computer, person's body or other objects when released.

First-time Operation

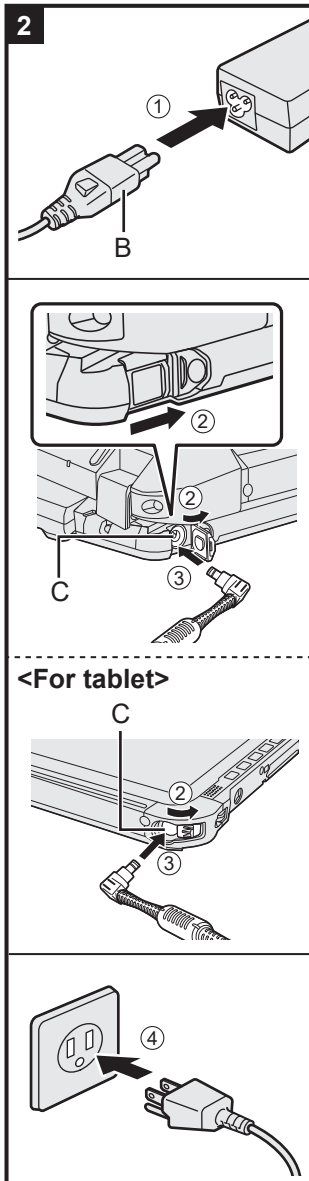

2 Connect your computer to a power outlet

- ① Connect the power cord and AC adaptor.
Hold the plug (B) of the power cord, and securely insert it straight to the end.
- ② <Only for model with keyboard base> Slide the cover to the arrow direction and then open the cover.
<For tablet> Slide the cover.
- ③ Connect the AC adaptor to the DC-IN jack (C) of the computer.
- ④ Connect your computer to a power outlet.
The shape of AC Plug and AC Outlet depend on the country.
The battery charging starts automatically.

IMPORTANT

- Do not disconnect the AC adaptor until the first-time operation procedure is completed.
- When using the computer for the first time, do not connect any peripheral device (including wired LAN cable) except the battery pack and AC adaptor.
- **Handling the AC adaptor**
Problems such as sudden voltage drops may arise during periods of thunder and lightning. Since this could adversely affect your computer, an uninterruptible power source (UPS) is highly recommended unless running from the battery pack alone.
- When the DC plug is not connected to the computer, disconnect the AC cord from your electrical outlet. Power is consumed simply by having the AC adaptor plugged into an electrical outlet.

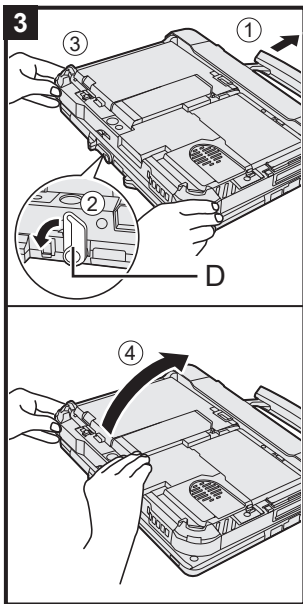

3 Open the display

<Only for model with keyboard base>



- ① Pull out the handle.
 - If you do not pull out the handle before opening the display, the computer may fall over due to the weight of the display.
- ② Rotate the latch (D) to the arrow direction.
- ③ Hold the dents with both hands, and lift the display slightly.
- ④ Hold the side of the computer with either of your hands and then lift up the display to open.

IMPORTANT

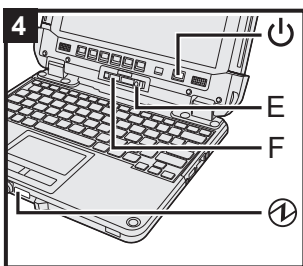
- Do not open the display wider than necessary (150° or more), and do not apply excessive pressure to the LCD. Do not open or close the computer holding the edge of the LCD segment.



4 Turn on the computer

Press and hold the power switch  until the power indicator  lights.

IMPORTANT

- Do not press the power switch repeatedly.
- Do not perform the following operation until the First-time Operation is completed.
 - <Only for model with keyboard base> Touching the release lever (E) and detach lock (F)
 - <Only for model with keyboard base> Detaching the tablet from keyboard base
 - Disconnecting the AC adaptor
 - Pressing the power switch
 - <Only for model with keyboard base> Closing the display
 - Any changes from the default setting of the Setup Utility
- Once you turn off the computer, wait for ten seconds or more before you turn on the computer again.
- When the CPU temperature is high, the computer may not start up to prevent overheating of the CPU. Wait until the computer cools down, and then turn the power on again. If the computer does not power on even after cooling down, contact Panasonic Technical Support (→  *Operating Instructions - Reference Manual*).

<For tablet>

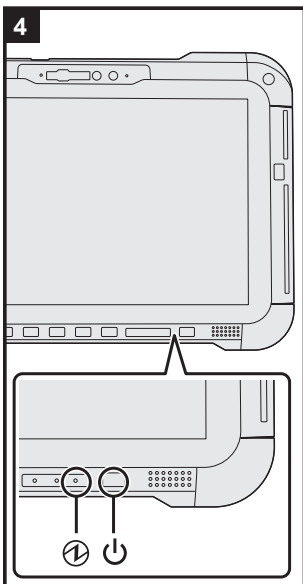

5 Setup Windows

Select language and click [Yes].

Follow the on-screen instructions.

- The computer restarts several times. Do not touch the touchscreen, external keyboard or external mouse, and wait until the drive indicator  has turned off.
- After the computer is turned on, the screen remains black or unchanged for a while, but this is not a malfunction. Wait for a moment until the Windows setup screen appears.
- During setup of Windows, use the touchpad and clicking to move the pointer and to click an item.
- Setup of Windows will take approximately 5 minutes. Go to the next step, confirming each message on the display.
- You can set the Wireless Network after the setup of Windows is complete.

If “Let’s connect you to a network” is displayed, you can select [I don’t have internet].

Windows 10 If “There’s more to discover when you connect to the internet” is displayed, you can select [Continue with limited setup].

Windows 11 If “Connect now to quickly get started on your device” is displayed, you can select [Continue with limited setup].

- We recommend that you set the password after the setup of Windows is complete.

IMPORTANT

- You can change the user name, image and security setting after setup of Windows.
- Use standard characters as a computer name: numbers 0 through 9, uppercase and lowercase letters from A to Z, and the hyphen (-) character. Do not use the following words and characters for user name: CON, PRN, AUX, CLOCK\$, NUL, COM1 to COM9, LPT1 to LPT9, LPT, &, space.

If the error message “The computer name is not valid” appears, check if characters other than the above are not entered. If the error message still remains on the display, set the key entry mode to English (“ENG”) and enter characters.

6 Restart the computer

Windows 10

- ① Click  (Start).
- ② Click  (Power) - [Restart].

Windows 11

- ① Click  (Start).
- ② Click  (Power) - [Restart].

- A portion of the Panasonic PC Settings Utility functions will be enabled after the computer restarts.

NOTE

- When the “Emergency notification setting” screen appears, read the on-screen messages carefully. Follow the on-screen instructions. You can set the “Emergency notification setting” after the setup of Windows is complete.

7 Update the on-screen manual

- ① Connect to the internet. Sign in to Windows as an administrator.

For further information, refer to  *Connect to a network*.

- ② Update the on-screen manual.

Windows 10 Click  (Start) - [Panasonic PC Manual Selector].

Windows 11 Click  (Start) - [All apps] - [Panasonic PC Manual Selector].

Follow the on-screen instructions.

8 Create a recovery disc



A recovery disc allows you to install OS and restore its factory default condition, in case, the recovery partition of the flash memory is damaged.

Refer to →  *Operating Instructions - Reference Manual* “Important Operation/Settings” “Create a Recovery Disc” about creating the disc.

First-time Operation

NOTE

- To set the password, proceed as follows.

① **Windows 10** Click  (Start) -  (Settings) - [Accounts] - [Sign-in options].

Windows 11 Click  (Start) - [Settings] - [Accounts] - [Sign-in options].

② Click [Password] - [Add].

To display the password input screen every time the computer is resumed from the modern standby or hibernation, perform the following setting.

Windows 10

① Click  (Start) -  (Settings) - [Accounts] - [Sign-in options].

② Select [Every Time] under “Require sign-in”.

Windows 11



① Click  (Start) - [Settings] - [Accounts] - [Sign-in options].

② Select [Every Time] in “If you’ve been away, when should Windows require you to sign in again?”.

- Set the key entry mode to English (“ENG”) and enter characters.

The keyboard layout can be added or changed in the following steps.

Windows 10

① Click  (Start) -  (Settings) - [Time & Language] - [Language].

② Click a language and click [Options].

③ Click [Add a keyboard] and choose a keyboard from the list.

Windows 11

① Click  (Start) - [Settings] - [Time & language] - [Language & region].

② Click ... - [Language options] in the language.

③ Click [Add a keyboard] in “Installed keyboards” and choose a keyboard from the list.

- Remember your password. If you forget the password, you cannot use Windows. Creating a password reset disk beforehand is recommended.

- **PC Information Viewer**

This computer periodically records the management information of the flash memory, etc. The maximum data volume for each record is 1024 bytes.

This information is only used for estimating the cause in the case when the flash memory goes down by any possibility. They are never sent to outside via network nor used for any other purpose except for the purpose described the above.

To disable the function, add the check mark for [Disable the automatic save function for management information history] in [Hard Disk Status] of PC Information Viewer, and click [OK]. Then follow the on-screen instructions.

(→  *Operating Instructions - Reference Manual* “Troubleshooting” “Troubleshooting” “Checking the Computer’s Usage Status”)

Detaching the tablet from the keyboard base

<Only for model with Keyboard Base (FZ-VEKG21 series)>

When detaching the tablet from the keyboard base while it is turned on, note the following points.

IMPORTANT

- Before detaching the tablet, confirm the following things.
 - Save the necessary data.
 - Close files you have opened from removable disks and network drives.
 - Remove peripheral devices connecting to the tablet.
- Do not detach the tablet in the conditions below.
 - When playing/recording audio files or displaying motion video such as MPEG files.
 - When using communication software or network functions.

NOTE

- Do not detach the tablet in the rain.

- ① Release the detach lock (A).

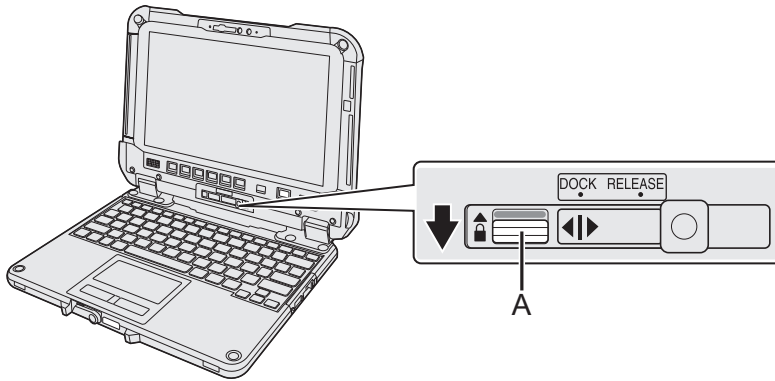

- ② Slide the release lever (B) to the right so that the vertical line in the center of mark (C) is aligned with the position of RELEASE mark (D).

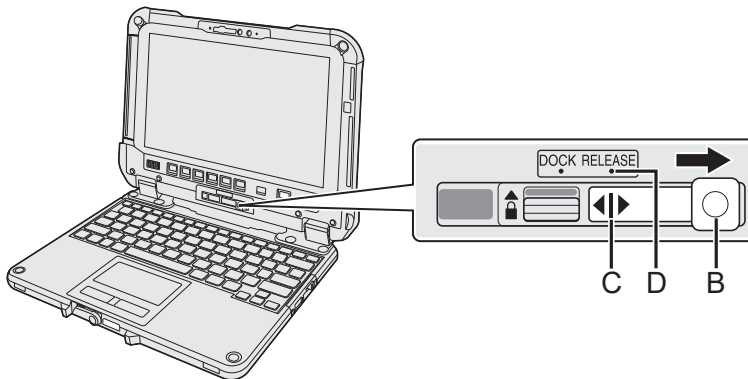

Detaching the tablet from the keyboard base

③ Detach the tablet from the keyboard base.

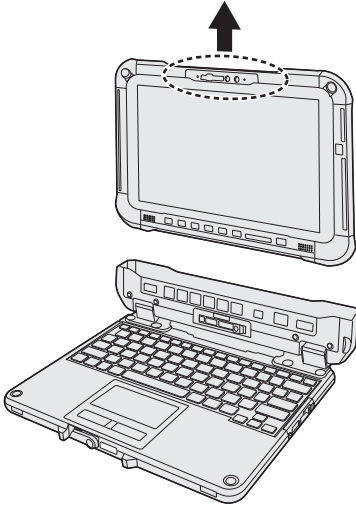

IMPORTANT

- When detaching the tablet from the keyboard base, hold the position at the locations dashed line circled in the illustration.
 - Attach/detach the tablet on a flat location.
 - While holding the keyboard base with hand, attach/detach the tablet.
-

Attaching the tablet to the keyboard base

NOTE

- Do not attach the tablet in the rain.
- Clean the Tablet terminals (E) with a dry cloth. (Attached dust may cause a contact failure.)

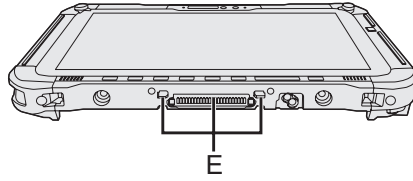

- ① Insert the tablet to the keyboard base.

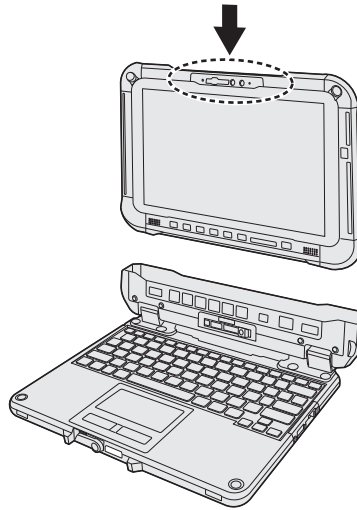

IMPORTANT

- When inserting the tablet, place the keyboard base on a hard stable surface.
- ② While pushing down the location circled with dashed lines, slide the release lever (B) to the left so that the vertical line in the center of mark (C) is aligned with the position of DOCK mark (F).

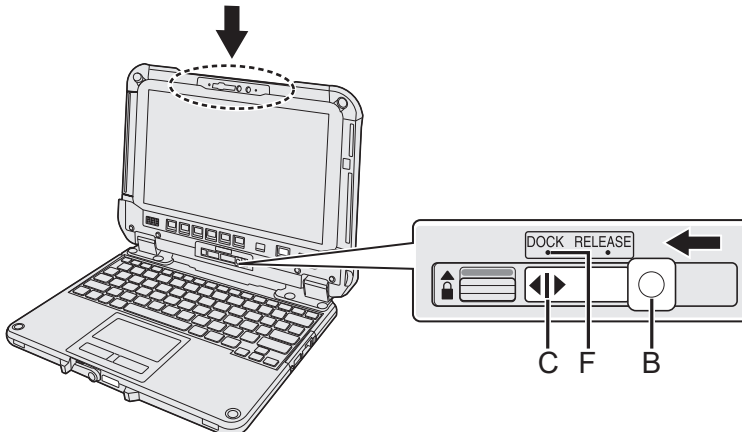

Attaching the tablet to the keyboard base

- ③ Raise the detach lock (A) above to the locked position.

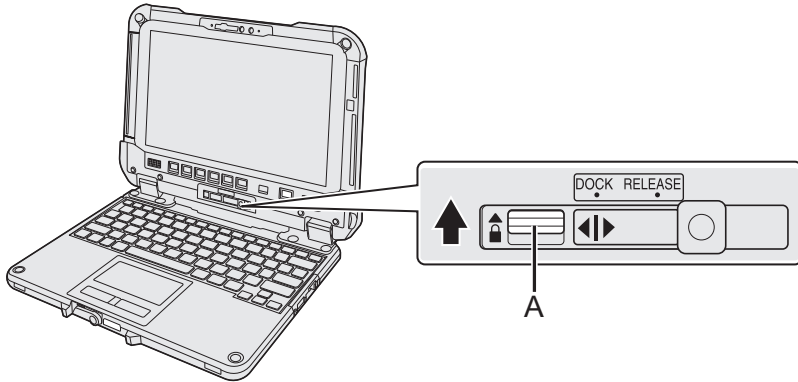

IMPORTANT

- Confirm that the orange-colored signs near the detach lock and the release lever can not be seen.

Software License

This product incorporates the following software:

- (1) the software developed independently by or for Panasonic Corporation,
- (2) the software owned by third party and licensed to Panasonic Corporation,
- (3) the software licensed under the GNU General Public License Version 2.0 (GPL V2.0),
- (4) the software licensed under the GNU LESSER General Public License, Version 2.1 (LGPL V2.1), and/or
- (5) open source software other than the software licensed under the V2.0 and/or LGPL V2.1.

The software categorized as (3) - (5) are distributed in the hope that it will be useful, but WITHOUT ANY WARRANTY, without even the implied warranty of MERCHANTABILITY or FITNESS FOR A PARTICULAR PURPOSE. Please refer to the detailed terms and conditions thereof shown in the  *Operating Instructions - Reference Manual* "Appendix" "Software License".

At least three (3) years from delivery of this product, Panasonic will give to any third party who contacts us at the contact information provided below, for a charge no more than our cost of physically performing source code distribution, a complete machine-readable copy of the corresponding source code covered under GPL V2.0, LGPL V2.1 or the other licenses with the obligation to do so, as well as the respective copyright notice thereof.

Contact Information: oss-cd-request@gg.jp.panasonic.com

The source code and the copyright notice are also available for free in our website below.

<https://panasonic.net/cns/oss/>

Trademarks

- Microsoft, the Microsoft logo, Windows, the Windows logo, Outlook and OneDrive are registered trademarks or trademarks of Microsoft Corporation of the United States and/or other countries.
- The Bluetooth[®] word mark and logos are registered trademarks owned by Bluetooth SIG, Inc. and any use of such marks by Panasonic Corporation is under license. Other trademarks and trade names are those of their respective owners.
- USB Type-C[®] and USB-C[®] are registered trademarks of USB Implementers Forum.
- Names of products, brands, etc., appearing in this manual are trademarks or registered trademarks of their respective own companies. However, the [™] or [®] marks may not be used in all cases in this manual.

Panasonic Corporation
Osaka, Japan

Panasonic System Solutions Asia Pacific
202 Bedok South Ave 1 Blk B, #01-13 Singapore 469332
<https://business.panasonic.sg/computer-product/>

Panasonic Australia Pty. Limited
ACN 001 592 187 ABN 83 001 592 187
1 Innovation Road, Macquarie Park, NSW 2113

Panasonic India Pvt. Ltd
12th Floor, Ambience Tower,
Ambience Island, NH 8,
Gurgaon - 122002, Haryana, India

Importer's name & address pursuant to the EU legislation
Panasonic System Communications Company Europe,
Panasonic Marketing Europe GmbH
Hagenauer Straße 43
65203 Wiesbaden
Germany

55-E-1

Web Site : <https://panasonic.net/cns/pc/>

