



# AirMedia<sup>®</sup> Series 3 Wireless Presentation and Wireless Video Conferencing

Product Manual

Crestron Electronics, Inc.

## Original Instructions

The U.S. English version of this document is the original instructions.

All other languages are a translation of the original instructions.

**Regulatory Models:** M202018001, M202011001

Crestron product development software is licensed to Crestron dealers and Crestron Service Providers (CSPs) under a limited nonexclusive, nontransferable Software Development Tools License Agreement. Crestron product operating system software is licensed to Crestron dealers, CSPs, and end-users under a separate End-User License Agreement. Both of these Agreements can be found on the Crestron website at [www.crestron.com/legal/software\\_license\\_agreement](http://www.crestron.com/legal/software_license_agreement).

The product warranty can be found at [www.crestron.com/warranty](http://www.crestron.com/warranty).

The specific patents that cover Crestron products are listed at [www.crestron.com/legal/patents](http://www.crestron.com/legal/patents).

Certain Crestron products contain open source software. For specific information, visit [www.crestron.com/opensource](http://www.crestron.com/opensource).

Crestron, the Crestron logo, AirMedia, .AV Framework, Crestron Connected, Crestron Fusion, Crestron Studio, Crestron Toolbox, and XiO Cloud are either trademarks or registered trademarks of Crestron Electronics, Inc. in the United States and/or other countries. Apple, App Store, AirPlay, iPad, iPhone, Mac, macOS, and Safari are either trademarks or registered trademarks of Apple, Inc. in the United States and/or other countries. Appspace is either a trademark or a registered trademark of Appspace Inc. in the United States and/or other countries. Bluetooth is either a trademark or registered trademark of Bluetooth SIG, Inc. in the United States and/or other countries. Android, Chrome, Chrome OS, Google Calendar, Google Play, and YouTube are either trademarks or registered trademarks of Google, Inc. in the United States and/or other countries. iOS is either a trademark or registered trademark of Cisco Systems, Inc. in the United States and/or other countries. Jabra is a trademark of GN Audio A/S in the United States and/or other countries. HDMI is either a trademark or registered trademark of HDMI Licensing LLC in the United States and/or other countries. Intertek is either a trademark or registered trademark of Intertek Group in the United States and/or other countries. Active Directory, Azure, Microsoft, Microsoft 365, Microsoft Edge, Microsoft Exchange Server, and Windows are either trademarks or registered trademarks of Microsoft Corporation in the United States and/or other countries. Firefox is either a trademark or registered trademark of the Mozilla Foundation in the United States and/or other countries. USB-C is either a trademark or registered trademark of USB Implementers. Miracast, Wi-Fi, and Wi-Fi Direct are either trademarks or registered trademarks of Wi-Fi Alliance in the United States and/or other countries. Other trademarks, registered trademarks, and trade names may be used in this document to refer to either the entities claiming the marks and names or their products. Crestron disclaims any proprietary interest in the marks and names of others. Crestron is not responsible for errors in typography or photography.

©2024 Crestron Electronics, Inc.

# Contents

<b>Overview</b> .....	<b>1</b>
Features .....	6
AM-3000-WF(-I) Features .....	7
AM-3100-WF(-I) Features .....	10
AM-3200 Features .....	13
AM-3200-WF(-I) Features .....	16
AM-3200-GV Features .....	19
AM-TX3-100(-I) Features .....	22
UC-SB-P50-AM-WF(-I) KIT Features .....	24
<b>Specifications</b> .....	<b>27</b>
AM-3000-WF(-I) Specifications .....	28
Specifications .....	28
Dimension Drawings .....	32
AM-3100-WF(-I) Specifications .....	33
Specifications .....	33
Dimension Drawings .....	38
AM-3200 Specifications .....	39
Specifications .....	39
Dimension Drawings .....	44
AM-3200-WF(-I) Specifications .....	45
Specifications .....	45
Dimension Drawings .....	51
AM-3200-GV Specifications .....	52
Specifications .....	52
Dimension Drawings .....	56
AM-TX3-100(-I) Specifications .....	57
Specifications .....	57
Dimension Drawings .....	59
UC-SB-P50-AM-WF(-I) KIT Specifications .....	60
<b>Installation</b> .....	<b>61</b>
AM-3000-WF(-I) and AM-3100-WF(-I) .....	62
In the Box .....	62
Install the Receiver .....	62
Connect the Receiver .....	65
Observe the LEDs .....	66
AM-3200, AM-3200-WF(-I), and AM-3200-GV .....	67
In the Box .....	67
Install the Receiver .....	67
Connect the Receiver .....	70

Observe the LEDs .....	72
AM-TX3-100(-I) .....	73
In the Box .....	73
Install the AM-TX3-100(-I) .....	73
Observe the LEDs .....	74
UC-SB-P50-AM-WF(-I) KIT .....	76
<b>Configuration .....</b>	<b>77</b>
Web Configuration Interface .....	77
Connect to the Receiver .....	77
Action Menu .....	80
Status .....	87
Settings .....	96
Security .....	144
802.1x Configuration .....	150
Enterprise Deployment Options .....	153
XiO Cloud® Service .....	153
Crestron Deployment Tool for PowerShell® Software .....	154
Modern Authentication for EWS .....	154
Create the Application .....	155
Obtain Authentication IDs .....	158
Configure Additional Settings .....	158
Perform a Factory Restore .....	165
<b>Operation .....</b>	<b>166</b>
Front of Room Experience .....	167
Welcome Screen .....	167
User Presentation .....	168
Present with AirMedia .....	168
Establish a Computer Connection .....	169
Share Content .....	170
Touch Screen Operation .....	182
Add a Touch Screen .....	182
Screen Controls .....	183
Room Scheduling .....	185
Present a Source .....	188
AirMedia Canvas .....	190
AirMedia Connect Devices .....	194
Wireless Best Practices .....	195
AM-TX3-100(-I) Operational Instructions .....	196
<b>Resources .....</b>	<b>197</b>
Crestron Support and Training .....	197
Programmer and Developer Resources .....	197
Product Certificates .....	197



Trademarks .....198

# Overview

AirMedia® Series 3 devices enable secure wireless collaboration in the modern digital workspace. Install the devices in conference rooms, huddle rooms, lounges, lobbies, or almost any space to establish a productive meeting environment. This product manual discusses the requirements, configuration instructions, and operating instructions for AirMedia Series 3 devices.

AirMedia Series 3 receivers are available in the following models:

- [AM-3000-WF](#): AirMedia Receiver 3000 with Wi-Fi® Network Connectivity
- [AM-3000-WF-I](#): AirMedia Receiver 3000 with Wi-Fi® Network Connectivity, International
- [AM-3100-WF](#): AirMedia Receiver 3100 with Wi-Fi® Network Connectivity
- [AM-3100-WF-I](#): AirMedia Receiver 3100 with Wi-Fi® Network Connectivity, International
- [AM-3200](#): AirMedia Receiver 3200
- [AM-3200-WF](#): AirMedia Receiver 3200 with Wi-Fi® Network Connectivity
- [AM-3200-WF-I](#): AirMedia Receiver 3200 with Wi-Fi® Network Connectivity, International
- [AM-3200-GV](#): AirMedia Receiver 3200, Government Version

AirMedia Series 3 Connect devices are available in the following models:

- [AM-TX3-100](#): AirMedia Series 3 Connect Adaptor
- [AM-TX3-100-I](#): AirMedia Series 3 Connect Adaptor, International

AirMedia Series 3 devices are available in the following kits:

- [AM3-111 KIT](#): AirMedia Series 3 Kit with AM-3100-WF Receiver and AM-TX3-100 Adaptor
- [AM3-111-I KIT](#): AirMedia Series 3 Kit with AM-3100-WF Receiver and AM-TX3-100 Adaptor, International
- [AM3-212 KIT](#): AirMedia Series 3 Kit with AM-3200-WF Receiver, two AM-TX3-100 Adaptors, and Cradle
- [AM3-212-I KIT](#): AirMedia Series 3 Kit with AM-3200-WF Receiver, two AM-TX3-100 Adaptors, and Cradle, International
- [UC-SB-P50-AM-WF KIT](#): AirMedia Series 3 Conferencing System with AM-3200-WF and Jabra® PanaCast 50 Video Bar
- [UC-SB-P50-AM-WF-I KIT](#): AirMedia Series 3 Conferencing System with AM-3200-WF-I and Jabra® PanaCast 50 Video Bar, International

For more information on receiver features and capabilities, refer to [Feature Comparison on page 2](#).

For security and deployment information, refer to [AirMedia Presentation Gateway Security Reference Guide](#) (Doc 7693).

## Feature Comparison

FEATURE	AM-3000-WF	AM-3100-WF	AM-3200	AM-3200-WF
AirMedia Series 3 technology <sup>1</sup>	✓	✓	✓	✓
AirMedia Output Resolution <sup>2</sup>	1080p60	1080p60	1080p60	1080p60
AirMedia Device Support				
Windows® OS (all versions)	✓	✓	✓	✓
Mac® devices	✓	✓	✓	✓
iPad® devices	✓	✓	✓	✓
iPhone® devices	✓	✓	✓	✓
iOS® devices	✓	✓	✓	✓
Android™ devices	✓	✓	✓	✓
AirMedia Screen Mirroring Support				
Windows® OS (all versions)	✓	✓	✓	✓
Mac devices	✓	✓	✓	✓
iPad devices	✓	✓	✓	✓
iPhone devices	✓	✓	✓	✓
iOS devices	✓	✓	✓	✓
Android devices	✓	✓	✓	✓
AirMedia Video + Audio Playback				
PC-Windows (all versions)	✓	✓	✓	✓
Chrome OS™ operating system <sup>3</sup>	✓	✓	✓	✓
Mac devices	✓	✓	✓	✓
iPad devices	✓	✓	✓	✓
iPhone devices	✓	✓	✓	✓
iOS devices	✓	✓	✓	✓
Android devices	✗	✗	✗	✗
AirMedia Playback Features				

FEATURE	AM-3000-WF	AM-3100-WF	AM-3200	AM-3200-WF
DRM Content Support (Netflix, etc.)	x	x	x	x
Device Internet Connection Required for AirPlay® Video Push	✓	✓	✓	✓
Security				
AES-128/TLS security <sup>4</sup>	✓	✓	✓	✓
802.1X	✓	✓	✓	✓
Active Directory® Authentication	✓	✓	✓	✓
Crestron® Control				
.AV Framework™ Platform	✓	✓	✓	✓
XiO Cloud® Service	✓	✓	✓	✓
Crestron Studio® Software	N/A	N/A	N/A	N/A
SIMPL Windows	✓	✓	✓	✓
SIMPL#	Future release	Future release	Future release	Future release
Virtual Control (VC-4)	✓	✓	✓	✓
Video Inputs				
HDMI® Input	x	x	1	1
HDMI Resolution	x	x	1080p60	1080p60
HDMI HDCP	x	x	HDCP 1.4	HDCP 1.4
Video Outputs				
HDMI Output	1	1	1	1
HDMI Resolution <sup>5</sup>	4K60	4K60	4K60	4K60

FEATURE	AM-3000-WF	AM-3100-WF	AM-3200	AM-3200-WF
HDMI HDCP	HDCP 2.2	HDCP 2.2	HDCP 2.2	HDCP 2.2
Touch Screen Support	External	External	External	External
PoE Occupancy Sensor ( <a href="#">CEN-ODT-C-POE</a> )	✓	✓	✓	✓
Other Interfaces				
COM/IR Support	✗	✗	✓	✓
CEC	✓	✓	✓	✓
Power Over Ethernet	✓	✓	✓	✓
Direct Connect Scheduling Integration <sup>6</sup>				
Microsoft Exchange Server <sup>®</sup> or Microsoft 365 <sup>®</sup> Software	✓	✓	✓	✓
Google Calendar <sup>™</sup> Service	✓	✓	✓	✓
General Features				
AirMedia Canvas	✓	✓	✓	✓
Airmedia Canvas Control	✓	✓	✓	✓
Control System Interface	✓	✓	✓	✓
Wireless Conferencing	✗	✓	✓	✓
Appspace <sup>®</sup> Application	✓	✓	✓	✓
Wireless Access Point Mode	✓	✓	✗	✓
Moderator Mode	Future release	Future release	Future release	Future release
AirMedia Connect Adaptor	✓	✓	✗	✓

FEATURE	AM-3000-WF	AM-3100-WF	AM-3200	AM-3200-WF
YouTube® software Pushmode Support	✓	✓	✓	✓
Mounting	Freestanding Surface	Freestanding Surface	Freestanding Surface Rack	Freestanding Surface Rack
Dimensions	Height: 1.21 in. (31 mm) Width: 5 in. (127 mm) Depth: 5 in. (127 mm)	Height: 1.21 in. (31 mm) Width: 5 in. (127 mm) Depth: 5 in. (127 mm)	Height: 1.26 in. (33 mm) Width: 7.40 in. (188 mm) Depth: 6.93 in. (177 mm)	Height: 1.26 in. (33 mm) Width: 7.40 in. (188 mm) Depth: 6.93 in. (177 mm)

Notes:

1. To compare iterations of AirMedia technology, refer to the [AirMedia Presentation Gateway Security Reference Guide](#) (Doc 7693).
2. All video inputs are scaled to the HDMI output resolution.
3. The AirMedia Extension for Google Chrome OS relies on web technologies for screen sharing that are built into the web browser. Performance variations with motion video (quality and frame rate) will be observed based upon the encoding capabilities of the Chrome OS device and the nature of the content being displayed (ex. High motion video).
4. TLS 1.3 is not currently supported.
5. All video inputs are scaled to the HDMI output resolution.
6. Connection via Crestron Fusion® software may allow additional providers.

# Features

Refer to the following sections for more information on the features provided by Series 3 AirMedia devices and bundles.

- [AM-3000-WF\(-I\) Features on page 7](#)
- [AM-3100-WF\(-I\) Features on page 10](#)
- [AM-3200 Features on page 13](#)
- [AM-3200-WF\(-I\) Features on page 16](#)
- [AM-3200-GV Features on page 19](#)
- [AM-TX3-100\(-I\) Features on page 22](#)
- [UC-SB-P50-AM-WF\(-I\) KIT Features on page 24](#)

## AM-3000-WF(-I) Features

The AirMedia® Receiver 3000-WF(-I) enables secure wireless collaboration in the modern digital workspace. Easy to deploy and manage, install the Receiver in conference rooms, huddle rooms, lounges, lobbies, or almost any space to establish a productive meeting environment.



- Complete room solution enables secure wireless AirMedia® presentation from laptops, smartphones, tablet devices, and AirMedia Connect Adapters
- Enables smart automation via intelligent display control, personal device control, occupancy detection, and integration into a broader connected ecosystem
- Enterprise-grade security and content encryption protects privacy and ensures compliance with IT policies
- XiO Cloud® service support for remote provisioning and management
- Integrates with Appspace® digital signage software platform for content display
- Supports content sharing of up to four simultaneous sources for multi-user collaboration with AirMedia Canvas.

### Connect and Present

The AirMedia Series 3 Receiver can be installed beneath, beside, or behind a display to implement a smart room with wireless collaboration. The receiver features AirMedia wireless presentation capability, and an HDMI® output that connects to a display (up to 4K), and various USB interfaces for wireless conferencing. Connect your laptop, smart phone, tablet, AirMedia Connect Adaptor, or other source type to instantly present the source image on the display.

### AirMedia Wireless Presentation

With AirMedia technology, users can wirelessly present content from laptops, smartphones, and tablet devices via built in Wi-Fi® network capabilities or via an external Wi-Fi wireless network. Present content from desktop or laptop computers using downloadable client software, the AirMedia extension for Google Chrome™, or Miracast® screen mirroring technology (Windows 10 and Windows 11 computers only). Present content from Android™ and iOS® mobile devices with the AirMedia app.

For more information about AirMedia, visit [www.crestron.com/airmedia](http://www.crestron.com/airmedia).<sup>1</sup>



### Multi-Source Presentation

Present up to four sources simultaneously with the AirMedia Canvas feature. To maximize screen coverage, AirMedia Canvas automatically configures the best possible layout based on the number of active presenters, the type of sources, and their aspect ratios. Use the AirMedia app or a connected touch screen (sold separately) to manage sources and their position on the display.

### Enhanced Onscreen Experience

When no source is connected, the AM-3000-WF displays a customizable welcome screen on the room display with simple instructions for connecting and presenting. Integration with Microsoft Exchange Server® (for Outlook® and Microsoft 365® software users), Google Calendar™, or Crestron Fusion® room scheduling software allows the space's availability and meeting details to appear onscreen. As the meeting progresses, notifications appear periodically to indicate both the time left in the meeting and the next scheduled event. Pop-up messages sent from Crestron Fusion may also appear in the event of an emergency or to deliver an important announcement.

### Add-on Control Options

Add a Power over Ethernet occupancy sensor ([CEN-ODT-C-POE](#)) to control display or digital signage on/off based on room occupancy or vacancy.

### Digital Signage Functionality

Integrate the Appspace digital signage application or other web-based signage providers with the AM-3000-WF. The AM-3000-WF can display digital signage content when no presentation is being made or when the room is not occupied.

### Crestron Fusion Room Monitoring

Presentation spaces can be managed and centrally monitored through the Crestron Fusion enterprise management service. By adding an optional occupancy sensor (CEN-ODT-C-POE), the AM-3000-WF can report and log when people are in the space, turn the display on and off accordingly, and make unused spaces available for new bookings. Crestron Fusion software supports room scheduling, and can integrate with a variety of third-party calendaring applications. Instant alerts notify the help desk to rapidly resolve any problems and maximize uptime and workflow.

For more information about Crestron Fusion, visit [www.crestron.com/fusion](http://www.crestron.com/fusion).

### XiO Cloud® Provisioning and Management Service

The AM-3000-WF is compatible with the XiO Cloud service, which enables installers and IT managers to easily deploy and manage thousands of devices. The XiO Cloud service allows for system alerts and network management and provisioning.

For more information, visit [www.crestron.com/xiocloud](http://www.crestron.com/xiocloud).

### Enterprise-Grade Security

The AirMedia Presentation System is an enterprise-grade solution that can be deployed across hundreds of spaces and set up easily using a web browser, or XiO Cloud software. Employing standard network security protocols such as 802.1x network access control, Active Directory® authentication, and AES content encryption, the AM-3000-WF protects privacy and ensures compliance with your organization's IT policies.

### Hybrid Wireless Connectivity with the AirMedia Connect Adaptor

As an alternative to software based AirMedia wireless presentation, the AM-3000-WF is compatible with [AirMedia Series 3 Connect Adaptors](#). Simply plug the adaptor into a personal device's USB-C® port to connect to the AM-3000-WF. The adaptor communicates wirelessly with the system using built-in Wi-Fi network capabilities to display content up to a 4K30 resolution. Use the LED-backlit capacitive touch buttons to start, stop, or pause the presentation at any time. Connect up to eight adaptors to a single receiver to maximize the space's collaboration abilities.

Note:

1. AirMedia wireless presentation requires a wired network connection between the AirMedia receiver and an external Wi-Fi wireless access point (not included). Laptops may alternately connect to AirMedia using a wired Ethernet connection. Full-motion video performance is dependent upon the performance of the network and the sending device. Computer client software and mobile device apps are available for download at [www.crestron.com/airmedia](http://www.crestron.com/airmedia).

## AM-3100-WF(-I) Features

The AirMedia® Receiver 3100-WF(-I) enables secure wireless collaboration in the modern digital workspace. Easy to deploy and manage, install the Receiver in conference rooms, huddle rooms, lounges, lobbies, or almost any space to establish a productive meeting environment.



- Complete room solution enables secure wireless AirMedia® presentation from laptops, smartphones, tablet devices, and AirMedia Connect Adapters
- Enables smart automation via intelligent display control, personal device control, occupancy detection, and integration into a broader connected ecosystem
- Enterprise-grade security and content encryption protects privacy and ensures compliance with IT policies
- XiO Cloud® service support for remote provisioning and management
- Integrates with Appspace® digital signage software platform for content display
- Supports content sharing of up to four simultaneous sources for multi-user collaboration with AirMedia Canvas.
- Wireless conferencing and presentation allows for collaboration with in-room and remote participants

### Connect and Present

The AirMedia Series 3 Receiver can be installed beneath, beside, or behind a display to implement a smart room with wireless collaboration. The receiver features AirMedia wireless presentation capability an HDMI® output that connects to a display (up to 4K). Connect your laptop, smart phone, tablet, AirMedia Connect Adaptor, or other source type to instantly present the source image on the display.

### AirMedia Wireless Presentation

With AirMedia technology, users can wirelessly present content from laptops, smartphones, and tablet devices via built in Wi-Fi® network capabilities or via an external Wi-Fi wireless network. Present content from desktop or laptop computers using downloadable client software the AirMedia extension for Google Chrome™. Present content from Android™ and iOS® mobile devices with the AirMedia app.

For more information about AirMedia, visit [www.crestron.com/airmedia](http://www.crestron.com/airmedia).<sup>1</sup>

### Multi-Source Presentation

Present up to four sources simultaneously with the AirMedia Canvas feature. To maximize screen coverage, AirMedia Canvas automatically configures the best possible layout based on the number of active presenters, the type of sources, and their aspect ratios. Use the AirMedia app or a connected touch screen (sold separately) to manage sources and their position on the display.

### Wireless Conferencing

Wireless conferencing provides a premium collaboration experience by enabling video calling from almost any device.<sup>2</sup> The AirMedia application provides wireless access to a host of connected conferencing peripherals, such as soundbars, cameras, or speakerphones. When using the AirMedia application, peripherals are immediately available on the user's laptop for use in Microsoft Teams® or Zoom™ software.

### Enhanced Onscreen Experience

When no source is connected, the AM-3100-WF displays a customizable welcome screen on the room display with simple instructions for connecting and presenting. Integration with Microsoft Exchange Server® (for Outlook® and Microsoft 365® software users), Google Calendar™, or Crestron Fusion® room scheduling software allows the space's availability and meeting details to appear onscreen. As the meeting progresses, notifications appear periodically to indicate both the time left in the meeting and the next scheduled event. Pop-up messages sent from Crestron Fusion may also appear in the event of an emergency or to deliver an important announcement.

### Add-on Control Options

Add a Power over Ethernet occupancy sensor ([CEN-ODT-C-POE](#)) to control display or digital signage on/off based on room occupancy or vacancy.

### XiO Cloud® Provisioning and Management Service

The AM-3100-WF is compatible with the XiO Cloud service, which enables installers and IT managers to easily deploy and manage thousands of devices. The XiO Cloud service allows for system alerts and network management and provisioning.

For more information, visit [www.crestron.com/xiocloud](http://www.crestron.com/xiocloud).

### Digital Signage Functionality

Integrate the Appspace digital signage application or other web-based signage providers with the AM-3100-WF. The AM-3100-WF can display digital signage content when no presentation is being made or when the room is not occupied.

### Crestron Fusion Room Monitoring

Presentation spaces can be managed and centrally monitored through the Crestron Fusion enterprise management service. By adding an optional occupancy sensor (CEN-ODT-C-POE), the AM-3100-WF can report and log when people are in the space, turn the display on and off accordingly, and make unused spaces available for new bookings. Crestron Fusion software supports room scheduling, and can integrate with a variety of third-party calendaring applications. Instant alerts notify the help desk to rapidly resolve any problems and maximize uptime and workflow.

For more information about Crestron Fusion, visit [www.crestron.com/fusion](http://www.crestron.com/fusion).

## Enterprise-Grade Security

The AirMedia Presentation System is an enterprise-grade solution that can be deployed across hundreds of spaces and set up easily using a web browser, or XiO Cloud software. Employing standard network security protocols such as 802.1x network access control, Active Directory® authentication, and AES content encryption, the AM-3100-WF protects privacy and ensures compliance with your organization's IT policies.

## Hybrid Wireless Connectivity with the AirMedia Connect Adaptor

As an alternative to software based AirMedia wireless presentation, the AM-3100-WF(-I) is compatible with [AirMedia Series 3 Connect Adaptors](#). Simply plug the adaptor into a personal device's USB-C® port to connect to the AM-3100-WF(-I). The adaptor communicates wirelessly with the system using built-in Wi-Fi network capabilities to display content up to a 4K30 resolution. Use the LED-backlit capacitive touch buttons to start, stop, or pause the presentation at any time. Connect up to eight adaptors to a single receiver to maximize the space's collaboration abilities.

1. AirMedia wireless presentation requires a wired network connection between the AirMedia receiver and an external Wi-Fi wireless access point (not included). Laptops may alternately connect to AirMedia using a wired Ethernet connection. Full-motion video performance is dependent upon the performance of the network and the sending device. Computer client software and mobile device apps are available for download at [www.crestron.com/airmedia](http://www.crestron.com/airmedia).
2. Crestron supports most mainstream devices and applications. For a list of supported conferencing peripherals, refer to [OLH 1001764](#).

# AM-3200 Features

The AirMedia® Receiver 3200 enables secure wireless collaboration in the modern digital workspace. Easy to deploy and manage, install the Receiver in conference rooms, huddle rooms, lounges, lobbies, or almost any space to establish a productive meeting environment.



- Complete room solution enables secure presentation from laptops, smartphones, and tablet devices using either a wired HDMI® connection or a wireless AirMedia® connection
- Integration friendly features such as HDMI® input, dual LAN, balanced audio output, and display control via RS-232 and IR
- Enables smart automation via intelligent display control, personal device control, occupancy detection, and integration into a broader connected ecosystem
- Enterprise-grade security and content encryption protects privacy and ensures compliance with IT policies
- XiO Cloud® service support for remote provisioning and management
- Integrates with Appspace® digital signage software platform for content display
- Supports content sharing of up to four simultaneous sources for multi-user collaboration with AirMedia Canvas.
- Wireless conferencing and presentation allows for collaboration with in-room and remote participants

## Connect and Present

The AirMedia Series 3 Receiver can be installed beneath, beside, or behind a wall-mount display and enables a smart room with wireless collaboration. The receiver features AirMedia wireless presentation capability, an HDMI® output that connects to a display (up to 4K), an HDMI input, and various USB interfaces for wireless conferencing. Connect your laptop, smart phone, tablet, or other source type to instantly present the source image on the display.

## AirMedia Wireless Presentation

With AirMedia technology, users can wirelessly present content from laptops, smartphones, and tablet devices via built in Wi-Fi® network capabilities or via an external Wi-Fi® wireless network. Present content from desktop or laptop computers using downloadable client software, or the AirMedia extension for the Google Chrome™ web browser. Present content from Android™ and iOS® mobile devices with the AirMedia app.

For more information about AirMedia, visit [www.crestron.com/airmedia](http://www.crestron.com/airmedia).<sup>1</sup>

## HDMI Connectivity

In addition to AirMedia, the AM-3200 includes an HDMI input for direct connection of a local source, such as a Mini PC, or a portable laptop computer via an optional wall plate or cable. The HDMI input supports HD 1080p/60 signals.<sup>2</sup>

## Multi-Source Presentation

Present up to four sources simultaneously with the AirMedia Canvas feature. To maximize screen coverage, AirMedia Canvas automatically configures the best possible layout based on the number of active presenters, the type of sources, and their aspect ratios.<sup>3</sup> Use the AirMedia app or a connected touch screen (sold separately) to manage sources and their position on the display.

## Wireless Conferencing

Wireless conferencing provides a premium collaboration experience by enabling video calling from almost any device.<sup>4</sup> The AirMedia application provides wireless access to a host of connected conferencing peripherals, such as soundbars, cameras, or speakerphones. When using the AirMedia application, peripherals are immediately available on the user's laptop for use in Microsoft Teams® or Zoom™ software.

## Enhanced Onscreen Experience

When no source is connected, the AM-3200 displays a customizable welcome screen on the room display with simple instructions for connecting and presenting. Integration with Microsoft Exchange Server® (for Outlook® and Microsoft 365® software users), Google Calendar™, or Crestron Fusion® room scheduling software allows the space's availability and meeting details to appear onscreen. As the meeting progresses, notifications appear periodically to indicate both the time left in the meeting and the next scheduled event. Pop-up messages sent from Crestron Fusion may also appear in the event of an emergency or to deliver an important announcement.

## Add-on Control Options

Add a Power over Ethernet occupancy sensor ([CEN-ODT-C-POE](#)) to control display or digital signage on/off based on room occupancy or vacancy.

## XiO Cloud® Provisioning and Management Service

The AM-3200 is compatible with the XiO Cloud service, which enables installers and IT managers to easily deploy and manage thousands of devices. The XiO Cloud service allows for system alerts and network management and provisioning.

For more information, visit [www.crestron.com/xiocloud](http://www.crestron.com/xiocloud).

## Crestron Fusion Room Monitoring

Presentation spaces can be managed and centrally monitored through the Crestron Fusion enterprise management service. By adding an optional occupancy sensor (CEN-ODT-C-POE), the AM-3200 can report and log when people are in the space, turn the display on and off accordingly, and make unused spaces available for new bookings. Crestron Fusion software supports room scheduling, and can integrate with a variety of third-party calendaring applications. Instant alerts notify the help desk to rapidly resolve any problems and maximize uptime and workflow.

For more information about Crestron Fusion, visit [www.crestron.com/fusion](http://www.crestron.com/fusion).

### Digital Signage Functionality

Integrate the Appspace digital signage application or other web-based signage providers with the AM-3200. The AM-3200 can display digital signage content when no presentation is being made or when the room is not occupied.

### Enterprise-Grade Security

The AirMedia Presentation System is an enterprise-grade solution that can be deployed across hundreds of spaces and set up easily using a web browser, or XiO Cloud software. Employing standard network security protocols such as 802.1x network access control, Active Directory® authentication, and AES content encryption, the AM-3200 protects privacy and ensures compliance with your organization's IT policies.

#### Notes:

1. AirMedia wireless presentation requires a wired network connection between the AirMedia receiver and an external Wi-Fi wireless access point (not included). Laptops may alternately connect to AirMedia using a wired Ethernet connection. Full-motion video performance is dependent upon the performance of the network and the sending device. Computer client software and mobile device apps are available for download at [www.crestron.com/airmedia](http://www.crestron.com/airmedia).
2. Using an appropriate adapter or interface cable, the HDMI input can support DVI and Dual-Mode DisplayPort sources, and the HDMI output can provide a DVI signal. CBL-HD-DVI interface cables are available separately.
3. When the AirMedia Canvas feature is enabled, the 4:2:0 color space is used for high definition sources connected to the HDMI input port. When the AirMedia Canvas feature is disabled, the 4:4:4 color space is used. If the 4:4:4 color space is required by sources connected to the HDMI input port, the AirMedia Canvas feature should be disabled.
4. Crestron supports most mainstream devices and applications. For a list of supported conferencing peripherals, refer to [OLH 1001764](#).



## AM-3200-WF(-I) Features

The AirMedia® Receiver 3200 (AM-3200-WF) enables secure wireless collaboration in the modern digital workspace. Easy to deploy and manage, install the Receiver in conference rooms, huddle rooms, lounges, lobbies, or almost any space to establish a productive meeting environment.



- Complete room solution enables secure presentation from laptops, smartphones, tablet devices, and AirMedia Connect Adapters using either a wired HDMI® connection or a wireless AirMedia® connection
- Integration friendly features such as HDMI® input, dual LAN, balanced audio output, and display control via RS-232 and IR
- Enables smart automation via intelligent display control, personal device control, occupancy detection, and integration into a broader connected ecosystem
- Enterprise-grade security and content encryption protects privacy and ensures compliance with IT policies
- XiO Cloud® service support for remote provisioning and management
- Integrates with Appspace® digital signage software platform for content display
- Supports content sharing of up to four simultaneous sources for multi-user collaboration with AirMedia Canvas.
- Wireless conferencing and presentation allows for collaboration with in-room and remote participants

### Connect and Present

The AirMedia Series 3 Receiver can be installed beneath, beside, or behind a display to implement a smart room with wireless collaboration. The receiver features AirMedia wireless presentation capability and an HDMI® output that connects to a display (up to 4K). Connect your laptop, smart phone, tablet, AirMedia Connect Adaptor, or other source type to instantly present the source image on the display.

### AirMedia Wireless Presentation

With AirMedia technology, users can wirelessly present content from laptops, smartphones, and tablet devices via built in Wi-Fi® network capabilities or via an external Wi-Fi wireless network. Present content from desktop or laptop computers using downloadable client software, the AirMedia extension for Google Chrome™, or Miracast® screen mirroring technology (Windows 10

and Windows 11 computers only). Present content from Android™ and iOS® mobile devices with the AirMedia app.

For more information about AirMedia, visit [www.crestron.com/airmedia](http://www.crestron.com/airmedia).<sup>1</sup>

### HDMI Connectivity

In addition to AirMedia, the AM-3200-WF includes an HDMI input for direct connection of a local source, such as a Mini PC, or a portable laptop computer via an optional wall plate or cable. The HDMI input supports HD 1080p/60 signals.<sup>2</sup>

### Multi-Source Presentation

Present up to four sources simultaneously with the AirMedia Canvas feature. To maximize screen coverage, AirMedia Canvas automatically configures the best possible layout based on the number of active presenters, the type of sources, and their aspect ratios.<sup>3</sup> Use the AirMedia app or a connected touch screen (sold separately) to manage sources and their position on the display.

### Wireless Conferencing

Wireless conferencing provides a premium collaboration experience by enabling video calling from almost any device.<sup>4</sup> The AirMedia application provides wireless access to a host of connected conferencing peripherals, such as soundbars, cameras, or speakerphones. When using the AirMedia application, peripherals are immediately available on the user's laptop for use in Microsoft Teams® or Zoom™ software.

### Enhanced Onscreen Experience

When no source is connected, the AM-3200-WF displays a customizable welcome screen on the room display with simple instructions for connecting and presenting. Integration with Microsoft Exchange Server® (for Outlook® and Microsoft 365® software users), Google Calendar™, or Crestron Fusion® room scheduling software allows the space's availability and meeting details to appear onscreen. As the meeting progresses, notifications appear periodically to indicate both the time left in the meeting and the next scheduled event. Pop-up messages sent from Crestron Fusion may also appear in the event of an emergency or to deliver an important announcement.

### Add-on Control Options

Add a Power over Ethernet occupancy sensor ([CEN-ODT-C-POE](#)) to control display or digital signage on/off based on room occupancy or vacancy.

### XiO Cloud® Provisioning and Management Service

The AM-3200-WF is compatible with the XiO Cloud service, which enables installers and IT managers to easily deploy and manage thousands of devices. The XiO Cloud service allows for system alerts and network management and provisioning.

For more information, visit [www.crestron.com/xiocloud](http://www.crestron.com/xiocloud).

### Digital Signage Functionality

Integrate the Appspace digital signage application or other web-based signage providers with the AM-3200-WF. The AM-3200-WF can display digital signage content when no presentation is being made or when the room is not occupied.

## Crestron Fusion Room Monitoring

Presentation spaces can be managed and centrally monitored through the Crestron Fusion enterprise management service. By adding an optional occupancy sensor (CEN-ODT-C-POE), the AM-3200-WF can report and log when people are in the space, turn the display on and off accordingly, and make unused spaces available for new bookings. Crestron Fusion software supports room scheduling, and can integrate with a variety of third-party calendaring applications. Instant alerts notify the help desk to rapidly resolve any problems and maximize uptime and workflow.

For more information about Crestron Fusion, visit [www.crestron.com/fusion](http://www.crestron.com/fusion).

## Enterprise-Grade Security

The AirMedia Presentation System is an enterprise-grade solution that can be deployed across hundreds of spaces and set up easily using a web browser, or XiO Cloud software. Employing standard network security protocols such as 802.1x network access control, Active Directory® authentication, and AES content encryption, the AM-3200-WF protects privacy and ensures compliance with your organization's IT policies.

## Hybrid Wireless Connectivity with the AirMedia Connect Adaptor

As an alternative to software based AirMedia wireless presentation, the AM-3200-WF(-I) is compatible with [AirMedia Series 3 Connect Adaptors](#). Simply plug the adaptor into a personal device's USB-C® port to connect to the AM-3200-WF(-I). The adaptor communicates wirelessly with the system using built-in Wi-Fi network capabilities to display content up to a 4K30 resolution. Use the LED-backlit capacitive touch buttons to start, stop, or pause the presentation at any time. Connect up to eight adaptors to a single receiver to maximize the space's collaboration abilities.

Notes:

1. AirMedia wireless presentation requires a wired network connection between the AirMedia receiver and an external Wi-Fi wireless access point (not included). Laptops may alternately connect to AirMedia using a wired Ethernet connection. Full-motion video performance is dependent upon the performance of the network and the sending device. Computer client software and mobile device apps are available for download at [www.crestron.com/airmedia](http://www.crestron.com/airmedia).
2. Using an appropriate adapter or interface cable, the HDMI input can support DVI and Dual-Mode DisplayPort sources, and the HDMI output can provide a DVI signal. CBL-HD-DVI interface cables are available separately.
3. When the AirMedia Canvas feature is enabled, the 4:2:0 color space is used for high definition sources connected to the HDMI input port. When the AirMedia Canvas feature is disabled, the 4:4:4 color space is used. If the 4:4:4 color space is required by sources connected to the HDMI input port, the AirMedia Canvas feature should be disabled.
4. Crestron supports most mainstream devices and applications. For a list of supported conferencing peripherals, refer to [OLH 1001764](#).

## AM-3200-GV Features

The AirMedia® Receiver 3200, Government Version (AM-3200-GV) enables secure wireless collaboration in the modern digital workspace. Easy to deploy and manage, install the Receiver in conference rooms, huddle rooms, lounges, lobbies, or almost any space to establish a productive meeting environment. The AM-3200-GV is a fully featured TAA-compliant AM-3200 that is suitable for government deployments.



- Fully featured TAA-compliant AM-3200 suitable for government deployments
- Complete room solution enables secure presentation from laptops, smartphones, and tablet devices using either a wired HDMI® connection or a wireless AirMedia® connection
- Integration friendly features such as HDMI® input, dual LAN, balanced audio output, and display control via RS-232 and IR
- Enables smart automation via intelligent display control, occupancy detection, and integration into a broader connected ecosystem
- Enterprise-grade security and content encryption protects privacy and ensures compliance with IT policies
- XiO Cloud® service support for remote provisioning and management
- Built-in digital signage functionality with support for Appspace® software and other web-based signage providers
- Supports content sharing of four simultaneous sources for multi-user collaboration with AirMedia Canvas
- Wireless conferencing and presentation allows for collaboration with in-room and remote participants

### Connect and Present

The AirMedia Series 3 Receiver can be installed beneath, beside, or behind a wall-mount display and enables a smart room with wireless collaboration. The receiver features AirMedia wireless presentation capability, an HDMI® output that connects to a display (up to 4K), an HDMI input, and various USB interfaces for wireless conferencing. Connect your laptop, smart phone, tablet, or other source type to instantly present the source image on the display.

### AirMedia Wireless Presentation

With AirMedia technology, users can wirelessly present content from laptops, smartphones, and tablet devices via an external Wi-Fi wireless network. Present content from desktop or laptop

computers using downloadable client software or the AirMedia extension for Google Chrome™. Present content from Android™ and iOS® mobile devices with the AirMedia app.

For more information about AirMedia, visit [www.crestron.com/airmedia](http://www.crestron.com/airmedia).<sup>1</sup>

### HDMI Connectivity

In addition to AirMedia, the AM-3200-GV includes an HDMI input for direct connection of a local source, such as a Mini PC, or a portable laptop computer via an optional wall plate or cable. The HDMI input supports HD 1080p/60 signals.<sup>2</sup>

### Multi-Source Presentation

Present up to four sources simultaneously with the AirMedia Canvas feature. To maximize screen coverage, AirMedia Canvas automatically configures the best possible layout based on the number of active presenters, the type of sources, and their aspect ratios.<sup>3</sup> Use the AirMedia app or a connected touch screen (sold separately) to manage sources and their position on the display.

### Wireless Conferencing

Wireless conferencing provides a premium collaboration experience by enabling video calling from almost any device.<sup>4</sup> The AirMedia application provides wireless access to a host of connected conferencing peripherals, such as soundbars, cameras, or speakerphones. When using the AirMedia application, peripherals are immediately available on the user's laptop for use in Microsoft Teams® or Zoom™ software.

### Enhanced Onscreen Experience

When no source is connected, the AM-3200-GV displays a customizable welcome screen on the room display with simple instructions for connecting and presenting. Integration with Microsoft Exchange Server® (for Outlook® and Microsoft 365® software users), Google Calendar™, or Crestron Fusion® room scheduling software allows the space's availability and meeting details to appear onscreen. As the meeting progresses, notifications appear periodically to indicate both the time left in the meeting and the next scheduled event. Pop-up messages sent from Crestron Fusion may also appear in the event of an emergency or to deliver an important announcement.

### Add-on Control Options

Add a Power over Ethernet occupancy sensor ([CEN-ODT-C-POE](#)) to control display or digital signage on/off based on room occupancy or vacancy.

### XiO Cloud® Provisioning and Management Service

The AM-3200-GV is compatible with the XiO Cloud service, which enables installers and IT managers to easily deploy and manage thousands of devices. The XiO Cloud service allows for system alerts and network management and provisioning.

For more information, visit [www.crestron.com/xiocloud](http://www.crestron.com/xiocloud).

### Crestron Fusion Room Monitoring

Presentation spaces can be managed and centrally monitored through the Crestron Fusion enterprise management service. By adding an optional occupancy sensor (CEN-ODT-C-POE), the AM-3200-GV can report and log when people are in the space, turn the display on and off accordingly, and make unused spaces available for new bookings. Crestron Fusion software supports room scheduling, and can integrate with a variety of third-party calendaring

applications. Instant alerts notify the help desk to rapidly resolve any problems and maximize uptime and workflow.

For more information about Crestron Fusion, visit [www.crestron.com/fusion](http://www.crestron.com/fusion).

### Digital Signage Functionality

Integrate the Appspace digital signage application or other web-based signage providers with the AM-3200-GV. The AM-3200-GV can display digital signage content when no presentation is being made or when the room is not occupied.

### Enterprise-Grade Security

The AirMedia Presentation System is an enterprise-grade solution that can be deployed across hundreds of spaces and set up easily using a web browser, or XiO Cloud software. Employing standard network security protocols such as 802.1x network access control, Active Directory® authentication, and AES content encryption, the AM-3200-GV protects privacy and ensures compliance with your organization's IT policies.

#### Notes:

1. AirMedia wireless presentation requires a wired network connection between the AM-3200-GV and an external Wi-Fi wireless access point (not included). Laptops may alternately connect to AirMedia using a wired Ethernet connection. Full-motion video performance is dependent upon the performance of the network and the sending device. Computer client software and mobile device apps are available for download here.
2. TLS 1.3 is currently not supported.
3. Using an appropriate adapter or interface cable, the HDMI output can provide a DVI signal. CBL-HD-DVI interface cables are available separately.
4. With or without reduced blanking.

## AM-TX3-100(-I) Features

The AirMedia Connect Adaptor ([AM-TX3-100](#)) enables wireless presentation and conferencing<sup>1</sup> when paired with a Wi-Fi® network capable AirMedia Series 3 Receiver. Deploy the AM-TX3-100 alongside an AirMedia Series 3 Receiver in conference rooms, huddle rooms, lounges, lobbies, or almost any space to establish a productive meeting environment.



- Connects to a personal device using an integrated USB-C® connector
- Shares content up to 4K30 resolution within seconds of connecting to a personal device
- Provides access to Wireless Conferencing peripherals connected to a paired AM-3100-WF or AM-3200-WF AirMedia Series 3 Receiver<sup>1</sup>
- Wirelessly pairs with a Wi-Fi® network capable AirMedia Series 3 Receiver
- Pair up to eight AirMedia Connect devices with a single Wi-Fi® network capable AirMedia Series 3 Receiver
- Includes backlit capacitive touch buttons for convenient content sharing control
- No software or driver installation required

### A System Solution

The AM-TX3-100 works alongside a Wi-Fi network and Wireless Conferencing capable AirMedia Series 3 Receiver for a complete system solution. Built-in Wi-Fi network connectivity creates a point-to-point network between the adaptor and the receiver for seamless connectivity without interruption. Easily pair up to eight adaptors to a single receiver. Store up to four AirMedia® Series 3 Connect Adaptors in the [AM-TX3-100-CRADLE](#) (sold separately).

### Simple Connectivity

Using the integrated USB-C® cable, connect the AM-TX3-100 to a personal device for seamless wireless presentation on an in-room display. Because USB-C offers native video communication, no software installation is required on the personal device.

### Seamless Wireless Conferencing<sup>1</sup>

When the AM-TX3-100 is connected to a personal device via USB-C or USB-A, that device can access peripherals<sup>22</sup> connected to a paired Wireless Conferencing-capable AirMedia Receiver ([AM-3100-WF](#) or [AM-3200-WF](#))/([AM-3100-WF-I](#) or [AM-3200-WF-I](#)). These peripherals can then be used on the personal device with Microsoft Teams® or Zoom™ software.

## Enterprise-Grade Security

The AirMedia platform is an enterprise-grade solution that can be deployed across hundreds of spaces, and set up easily using just a web browser, Crestron Fusion® software, or the XiO Cloud® service. It employs standard network security protocols, including 802.1x network access control, Active Directory® authentication, and AES content encryption to protect privacy and ensure compliance with your organization's IT policies.

### Notes:

1. Wireless Conferencing functionality through the AirMedia Connect Adaptor requires a WiFi® network and Wireless Conferencing compatible AirMedia Series 3 Receiver.
2. Crestron supports most mainstream devices and applications. For a list of supported conferencing peripherals, refer to [OLH 1001764](#).



## UC-SB-P50-AM-WF(-I) KIT Features

The AirMedia® Series 3 Conferencing System (UC-SB-P50-AM-WF KIT) enables secure wired and wireless collaboration in the modern digital workspace. The system contains an AirMedia Series 3 Receiver (AM-3200-WF) and a Jabra® PanaCast 50 intelligent video bar (UC-SB-P50). Easy to deploy and manage, install the UC-SB-P50-AM-WF KIT in conference rooms, huddle rooms, lounges, lobbies, or almost any space to establish a productive meeting environment.



- Complete room solution enables secure presentation from laptops, smartphones, tablet devices, and AirMedia Connect Adaptors using either a wired HDMI® connection or a wireless AirMedia® connection
- Includes an AirMedia Series 3 Receiver (AM-3200-WF) and a Jabra® PanaCast 50 intelligent video bar (UC-SB-P50)
- Integration friendly features such as HDMI® input, dual LAN, balanced audio output, and display control via RS-232 and IR
- Enables smart automation via intelligent display control, personal device control, occupancy detection, and integration into a broader connected ecosystem
- Enterprise-grade security and content encryption protects privacy and ensures compliance with IT policies
- XiO Cloud® service support for remote provisioning and management
- Integrates with Appspace® digital signage software platform for content display
- Supports content sharing of up to four simultaneous sources for multi-user collaboration with AirMedia Canvas.

### Connect and Present

The AirMedia Series 3 Receiver can be installed beneath, beside, or behind a display to implement a smart room with wireless collaboration. The receiver features AirMedia wireless presentation capability and an HDMI® output that connects to a display (up to 4K). Connect your laptop, smart phone, tablet, AirMedia Connect Adaptor, or other source type to instantly present the source image on the display.

### AirMedia Wireless Presentation

With AirMedia technology, users can wirelessly present content from laptops, smartphones, and tablet devices via an external Wi-Fi wireless network. Present content from desktop or laptop

computers using downloadable client software, the AirMedia extension for Google Chrome™, or Miracast® screen mirroring technology (Windows 10 and Windows 11 computers only). Present content from Android™ and iOS® mobile devices with the AirMedia app.

For more information about AirMedia, visit [www.crestron.com/airmedia](http://www.crestron.com/airmedia).<sup>1</sup>

### HDMI Connectivity

In addition to AirMedia, the UC-SB-P50-AM-WF KIT includes an HDMI input for direct connection of a local source, such as a Mini PC, or a portable laptop computer via an optional wall plate or cable. The HDMI input supports HD 1080p/60 signals.<sup>2</sup>

### Multi-Source Presentation

Present up to four sources simultaneously with the AirMedia Canvas feature. To maximize screen coverage, AirMedia Canvas automatically configures the best possible layout based on the number of active presenters, the type of sources, and their aspect ratios.<sup>3</sup> Use the AirMedia app or a connected touch screen (sold separately) to manage sources and their position on the display.

### Wireless Conferencing

Wireless conferencing provides a premium collaboration experience by enabling video calling from almost any device.<sup>4</sup> The AirMedia application provides wireless access to a host of connected conferencing peripherals, such as soundbars, cameras, or speakerphones. When using the AirMedia application, peripherals are immediately available on the user's laptop for use in Microsoft Teams® or Zoom™ software.

### High-Definition Video Conferencing with Impressive Audio

High-quality speakers and microphones deliver exceptional full-duplex performance from the Jabra PanaCast 50 intelligent video bar (UC-SB-P50). Three built-in conferencing cameras capture the room in panoramic 4K resolution with a seamless 180° horizontal field of view.

Visit [jabra.com/panacast50](http://jabra.com/panacast50) for more information on the Jabra PanaCast 50 video bar.

### Enhanced Onscreen Experience

When no source is connected, the UC-SB-P50-AM-WF KIT displays a customizable welcome screen on the room display with simple instructions for connecting and presenting. Integration with Microsoft Exchange Server® (for Outlook® and Microsoft 365® software users), Google Calendar™, or Crestron Fusion® room scheduling software allows the space's availability and meeting details to appear onscreen. As the meeting progresses, notifications appear periodically to indicate both the time left in the meeting and the next scheduled event. Pop-up messages sent from Crestron Fusion may also appear in the event of an emergency or to deliver an important announcement.

### Add-on Control Options

Add a Power over Ethernet occupancy sensor ([CEN-ODT-C-POE](#)) to control display or digital signage on/off based on room occupancy or vacancy.

### XiO Cloud® Provisioning and Management Service

The UC-SB-P50-AM-WF KIT is compatible with the XiO Cloud service, which enables installers and IT managers to easily deploy and manage thousands of devices. The XiO Cloud service allows for system alerts and network management and provisioning.

For more information, visit [www.crestron.com/xiocloud](http://www.crestron.com/xiocloud).

### Digital Signage Functionality

Integrate the Appspace digital signage application or other web-based signage providers with the UC-SB-P50-AM-WF KIT. The UC-SB-P50-AM-WF KIT can display digital signage content when no presentation is being made or when the room is not occupied.

### Crestron Fusion Room Monitoring

Presentation spaces can be managed and centrally monitored through the Crestron Fusion enterprise management service. By adding an optional occupancy sensor (CEN-ODT-C-POE), the UC-SB-P50-AM-WF KIT can report and log when people are in the space, turn the display on and off accordingly, and make unused spaces available for new bookings. Crestron Fusion software supports room scheduling, and can integrate with a variety of third-party calendaring applications. Instant alerts notify the help desk to rapidly resolve any problems and maximize uptime and workflow.

For more information about Crestron Fusion, visit [www.crestron.com/fusion](http://www.crestron.com/fusion).

### Enterprise-Grade Security

The AirMedia Presentation System is an enterprise-grade solution that can be deployed across hundreds of spaces and set up easily using a web browser, or XiO Cloud software. Employing standard network security protocols such as 802.1x network access control, Active Directory® authentication, and AES content encryption, the UC-SB-P50-AM-WF KIT protects privacy and ensures compliance with your organization's IT policies.

### Hybrid Wireless Connectivity with the AirMedia Connect Adaptor

As an alternative to software based AirMedia wireless presentation, the UC-SB-P50-AM-WF KIT is compatible with [AirMedia Series 3 Connect Adaptors](#). Simply plug the adaptor into a personal device's USB-C® port to connect to the UC-SB-P50-AM-WF KIT. The adaptor communicates wirelessly with the system using built-in Wi-Fi network capabilities to display content up to a 4K30 resolution. Use the LED-backlit capacitive touch buttons to start, stop, or pause the presentation at any time. Connect up to eight adaptors to a single receiver to maximize the space's collaboration abilities.

# Specifications

Refer to the following sections for more information on the specifications for various Series 3 AirMedia devices and bundles.

- [AM-3000-WF\(-I\) Specifications on page 28](#)
- [AM-3100-WF\(-I\) Specifications on page 33](#)
- [AM-3200 Specifications on page 39](#)
- [AM-3200-WF\(-I\) Specifications on page 45](#)
- [AM-3200-GV Specifications on page 52](#)
- [AM-TX3-100\(-I\) Specifications on page 57](#)
- [UC-SB-P50-AM-WF\(-I\) KIT Specifications on page 60](#)

# AM-3000-WF(-I) Specifications

Product specifications for the AM-3000-WF(-I) are provided below.

## Specifications

### Communications

---

<b>Ethernet</b>	100/1000 Mbps, auto-switching, autonegotiating, autodiscovery, full/half duplex, TCP/IP, UDP/IP, DHCP, SSL, TLS <sup>2</sup> , SSH, SFTP (SSH File Transfer Protocol), IEEE 802.1x, Active Directory authentication, HTTPS web browser setup and XiO Cloud service, 802.3af compliant
<b>AirMedia</b>	Via Ethernet: IPv4, mDNS, TLS, AES <sup>1</sup> ; Via wireless access point: IEEE 802.11/b/g/n/ac/ax, 2.4 GHz or 5 GHz
<b>USB Device</b>	USB 3.0 for computer console (installer setup and firmware update)
<b>HDMI Output</b>	HDCP 2.2, EDID, CEC; Supports management of HDCP and EDID

### AirMedia Software<sup>1</sup>

---

<b>OS Support</b>	Apple® iOS®, Android™, Windows 10, Windows 11, macOS®, Chrome OS™
<b>Video Frame Rate</b>	Up to 30 fps, audio supported
<b>Output Resolutions</b>	640x480@60Hz, 800x600@60Hz, 1024x768@60Hz, 1280x720@50Hz (720p50), 1280x720@60Hz (720p60), 1280x800@60Hz, 1366x768@60Hz, 1440x900@60Hz, 1600x900@60Hz, 1600x1200@60Hz, 1680x1050@60Hz, 1920x1080@50Hz (1080p50), 1920x1080@60Hz (1080p60)
<b>Bitrate Peak</b>	0.25 to 8.5 Mbps, variable depending on content complexity
<b>Bitrate Average</b>	1.4 Mbps typical

**NOTE:** All video inputs will be scaled to the selected HDMI output resolution.

#### NOTES:

- The bitrate for Apple native mirroring may deviate from above depending on the OS version and content.
- The AirMedia Extension for the Google Chrome browser relies on web technologies for screen sharing that are built-in to the web browser. Performance variations with motion video (quality and frame rate) may occur based upon the encoding capabilities of the Chrome OS device and the nature of the content being displayed (i.e., high-motion video).

<b>Audio Format</b>	Stereo
---------------------	--------

### Video

---

<b>Input Signal Types</b>	AirMedia; Simultaneous display of up to four sources with AirMedia Canvas
<b>Maximum Input Resolutions</b>	AirMedia presentation: 1920x1080@30Hz (1080p30); AirMedia Connect Adapter: 3840x2160@30Hz (4K30)
	<b>NOTE:</b> All video inputs will be scaled to the selected HDMI output resolution.
<b>Output Signal Types</b>	HDMI (DVI compatible <sup>3</sup> )
<b>HDMI Output Resolutions</b>	1280x720@50Hz (720p50), 1280x720@60Hz (720p60), 1280x800@60Hz, <sup>4</sup> 1366x768@60Hz, <sup>4</sup> 1440x900@60Hz, <sup>4</sup> 1600x900@60Hz, <sup>4</sup> 1600x1200@60Hz, 1680x1050@60Hz, <sup>4</sup> 1920x1080@50Hz (1080p50), 1920x1080@60Hz (1080p60), 3840x2160@30Hz (2160p30), 3840x2160@50Hz (2160p50), 3840x2160@60Hz (2160p60)
	<b>NOTE:</b> All video inputs will be scaled to the selected HDMI output resolution.
<b>Background &amp; Logo File Support</b>	JPEG, PNG

## Audio

<b>Input Signal Types</b>	AirMedia
<b>Output Signal Type</b>	HDMI
<b>Input/Output Format</b>	2 channel LPCM

**NOTE:** Audio input signals are passed to the output without any processing. Volume control capability requires a display device with discrete volume, up, down, and mute commands available via CEC, IP, IR, or RS-232.

## Connectors

<b>microSD</b>	For caching digital signage content
<b>HDMI OUTPUT</b>	(1) HDMI Type A connector; HDMI digital video/audio output (DVI compatible <sup>3</sup> )
<b>USB</b>	(2) USB Type A connectors;  (1) USB Type B connector; USB 3.0 device port for computer console
<b>LAN PoE+</b>	(1) 8-pin RJ-45 connector; 100Base-TX/1000Base-T Ethernet port and PoE+ Class 4
<b>24VDC 1.25A</b>	(1) 2.1 x 5.5 mm DC power connector; 24VDC power input; <a href="#">PW-2412WU</a> power pack sold separately

## Controls and Indicators

<b>PWR</b>	(1) White LED, indicates operating power supplied via the local power pack or PoE+
<b>RESET</b>	(1) Recessed push button for hardware reset
<b>SETUP</b>	(1) Recessed push button for onscreen IP address display and for pairing the device to an AM-TX3-100; (1) White LED, indicates pairing status
<b>ONLINE</b>	(1) White LED, indicates control system connection
<b>HDMI OUT</b>	(1) White LED, indicates HDMI signal presence at the HDMI output
<b>microSD</b>	(1) microSD slot
<b>LAN PoE+</b>	(2) LEDs, green LED indicates Ethernet link status, amber LED indicates Ethernet activity

### Power

---

<b>Power over Ethernet</b>	IEEE 802.3af Class 4 Powered Device
<b>Power Pack (sold separately)</b>	Input: 100-240VAC, 50/60 Hz; Output: 1.25A @ 24VDC; Model: <a href="#">PW-2412WU</a>
<b>Power Consumption</b>	13.5 W (typical)

### Environmental

---

<b>Temperature</b>	32° to 104°F (-0° to 40° C)
<b>Humidity</b>	10% to 90% RH (non-condensing)
<b>Heat Dissipation</b>	46.0 BTU/hr

### Construction

---

<b>Chassis</b>	Plastic, black finish, with (4) integrated mounting holes, vented sides
<b>Mounting</b>	Freestanding, surface mount

### Dimensions

---

<b>Height</b>	1.21 in. (31 mm)
<b>Width</b>	5 in. (127 mm)
<b>Depth</b>	5 in. (127 mm)

### Weight

---

11.64 oz (330 g)

### Compliance

---

**Regulatory Model: M202018001**  
Intertek® Listed for US & Canada, CE, IC, FCC Part 15 Class B digital device

Notes:

1. AirMedia wireless presentation requires a wired network connection between the AirMedia receiver and an external Wi-Fi wireless access point (not included). Laptops may alternately connect to AirMedia using a wired Ethernet connection. Full-motion video performance is dependent upon the performance of the network and the sending device. Computer client software and mobile device apps are available for download at [www.crestron.com/airmedia](http://www.crestron.com/airmedia).
2. TLS 1.3 is currently not supported.
3. Using an appropriate adapter or interface cable, the HDMI output can provide a DVI signal. CBL-HD-DVI interface cables are available separately.
4. With or without reduced blanking.



# Dimension Drawings

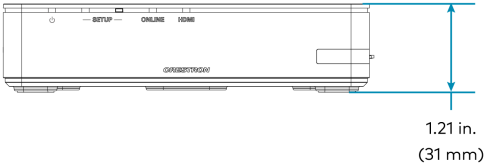
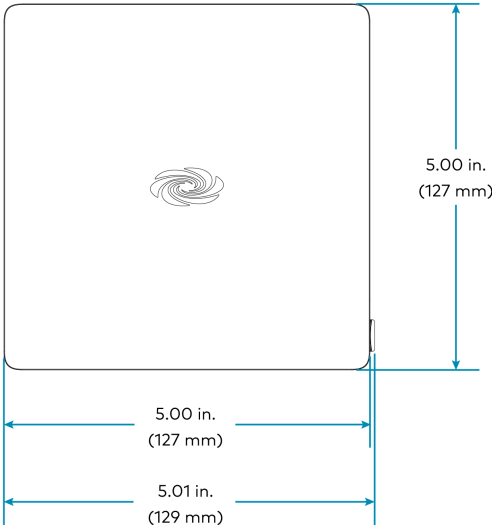
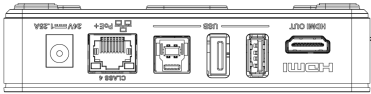

# AM-3100-WF(-I) Specifications

Product specifications for the AM-3100-WF(-I) are provided below.

## Specifications

### Communications

---

<b>Ethernet</b>	100/1000 Mbps, auto-switching, autonegotiating, autodiscovery, full/half duplex, TCP/IP, UDP/IP, DHCP, SSL, TLS <sup>3</sup> , SSH, SFTP (SSH File Transfer Protocol), IEEE 802.1x, Active Directory authentication, HTTPS web browser setup and XiO Cloud service, 802.3af compliant
<b>Wi-Fi</b>	Dual-band 802.11a/b/g/n/ac/ax (2.4 GHz & 5 GHz); Up to 70 ft (23 m) range at 80 Mbps, subject to site-specific conditions
<b>Bluetooth® Communications</b>	Bluetooth version 5.0
<b>AirMedia</b>	Via Ethernet: IPv4, mDNS, TLS, AES <sup>1</sup> ; Via wireless access point: IEEE 802.11/b/g/n/ac/ax, 2.4 GHz or 5 GHz
<b>USB Host</b>	USB 2.0 for connecting a USB conferencing peripheral; USB 3.0 for connecting a USB conferencing peripheral
<b>USB Device</b>	USB 3.0 for computer console (installer setup and firmware update)
<b>HDMI Output</b>	HDCP 2.2, EDID, CEC; Supports management of HDCP and EDID

### AirMedia Software<sup>1</sup>

---

<b>OS Support</b>	Apple® iOS®, Android™, Windows 10, Windows 11, macOS®, Chrome OS™
<b>Video Frame Rate</b>	Up to 30 fps, audio supported
<b>Output Resolutions</b>	640x480@60Hz, 800x600@60Hz, 1024x768@60Hz, 1280x720@50Hz (720p50), 1280x720@60Hz (720p60), 1280x800@60Hz, 1366x768@60Hz, 1440x900@60Hz, 1600x900@60Hz, 1600x1200@60Hz, 1680x1050@60Hz, 1920x1080@50Hz (1080p50), 1920x1080@60Hz (1080p60)
	<b>NOTE:</b> All video inputs will be scaled to the selected HDMI output resolution.
<b>Bitrate Peak</b>	0.25 to 8.5 Mbps, variable depending on content complexity

**Bitrate Average** 1.4 Mbps typical

**NOTES:**

- The bitrate for Apple native mirroring may deviate from above depending on the OS version and content.
- The AirMedia Extension for the Google Chrome browser relies on web technologies for screen sharing that are built-in to the web browser. Performance variations with motion video (quality and frame rate) may occur based upon the encoding capabilities of the Chrome OS device and the nature of the content being displayed (i.e., high-motion video).

**Audio Format** Stereo

### Wireless Conferencing

---

**OS Support (AirMedia Application)** Windows 10, Windows 11

**OS Support (AirMedia Connect Adaptor)** Windows 10, Windows 11, macOS 11 or later

**Supported Conferencing Services** Microsoft Teams software;  
Zoom software

**Supported Conferencing Peripherals** For a list of supported conferencing peripherals, refer to [OLH 1001764](#).

### Video

---

**Input Signal Types** AirMedia;  
Simultaneous display of up to four sources with AirMedia Canvas

**Maximum Input Resolutions** AirMedia presentation: 1920x1080@30Hz (1080p30);  
AirMedia Connect Adapter: 3840x2160@30Hz (4K30)

**NOTE:** All video inputs will be scaled to the selected HDMI output resolution.

**Output Signal Types** HDMI (DVI compatible<sup>4</sup>)

**HDMI Output Resolutions** 1280x720@50Hz (720p50), 1280x720@60Hz (720p60), 1280x800@60Hz,<sup>5</sup> 1366x768@60Hz,<sup>5</sup> 1440x900@60Hz,<sup>5</sup> 1600x900@60Hz,<sup>5</sup> 1600x1200@60Hz, 1680x1050@60Hz,<sup>5</sup> 1920x1080@50Hz (1080p50), 1920x1080@60Hz (1080p60), 3840x2160@30Hz (2160p30), 3840x2160@50Hz (2160p50), 3840x2160@60Hz (2160p60)

**NOTE:** All video inputs will be scaled to the selected HDMI output resolution.

**Background & Logo File Support** JPEG, PNG

### Audio

---

<b>Input Signal Types</b>	AirMedia
<b>Output Signal Type</b>	HDMI
<b>Input/Output Format</b>	2 channel LPCM

**NOTE:** Audio input signals are passed to the output without any processing. Volume control capability requires a display device with discrete volume, up, down, and mute commands available via CEC, IP, IR, or RS-232.

## Connectors

---

<b>microSD</b>	For caching digital signage content
<b>HDMI OUTPUT</b>	(1) HDMI Type A connector; HDMI digital video/audio output (DVI compatible <sup>4</sup> )
<b>USB</b>	(2) USB Type A connectors; USB 2.0 host port for USB conferencing peripheral; USB 3.0 host port for USB conferencing peripheral; (1) USB Type B connector; USB 3.0 device port for computer console
<b>LAN PoE+</b>	(1) 8-pin RJ-45 connector; 100Base-TX/1000Base-T Ethernet port and PoE+ Class 4
<b>24VDC 1.25A</b>	(1) 2.1 x 5.5 mm DC power connector; 24VDC power input; <a href="#">PW-2412WU</a> power pack sold separately

## Controls and Indicators

---

<b>PWR</b>	(1) White LED, indicates operating power supplied via the local power pack or PoE+
<b>RESET</b>	(1) Recessed push button for hardware reset
<b>SETUP</b>	(1) Recessed push button for onscreen IP address display and for pairing the device to an AM-TX3-100; (1) White LED, indicates pairing status
<b>ONLINE</b>	(1) White LED, indicates control system connection
<b>HDMI OUT</b>	(1) White LED, indicates HDMI signal presence at the HDMI output
<b>microSD</b>	(1) microSD slot
<b>LAN PoE+</b>	(2) LEDs, green LED indicates Ethernet link status, amber LED indicates Ethernet activity

## Power

---

<b>Power over Ethernet</b>	IEEE 802.3af Class 4 Powered Device
<b>Power Pack (sold separately)</b>	Input: 100-240VAC, 50/60 Hz; Output: 1.25A @ 24VDC; Model: <a href="#">PW-2412WU</a>
<b>Power Consumption</b>	13.5 W (typical)

**NOTE:** When wireless conferencing is used, the receiver must be powered by either Power over Ethernet+ (PoE+) or a power pack (sold separately).

### Environmental

---

Temperature	32° to 104°F (-0° to 40° C)
Humidity	10% to 90% RH (non-condensing)
Heat Dissipation	46.0 BTU/hr

### Construction

---

Chassis	Plastic, black finish, with (4) integrated mounting holes, vented sides
Mounting	Freestanding, surface mount

### Dimensions

---

Height	1.21 in. (31 mm)
Width	5 in. (127 mm)
Depth	5 in. (127 mm)

### Weight

---

11.64 oz (330 g)

## Compliance

---

### **Regulatory Model: M202018001**

Intertek® Listed for US & Canada, CE, IC, FCC Part 15 Class B digital device

#### Notes:

1. AirMedia wireless presentation requires a wired network connection between the AirMedia receiver and an external Wi-Fi wireless access point (not included). Laptops may alternately connect to AirMedia using a wired Ethernet connection. Full-motion video performance is dependent upon the performance of the network and the sending device. Computer client software and mobile device apps are available for download at [www.crestron.com/airmedia](http://www.crestron.com/airmedia).
2. Crestron supports most mainstream devices and applications. For a list of supported conferencing peripherals, refer to [OLH 1001764](#).
3. TLS 1.3 is currently not supported.
4. Using an appropriate adapter or interface cable, the HDMI output can provide a DVI signal. CBL-HD-DVI interface cables are available separately.
5. With or without reduced blanking.

# Dimension Drawings

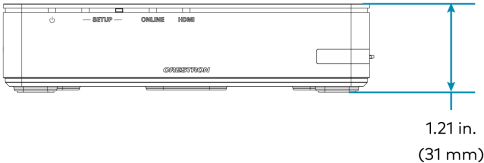
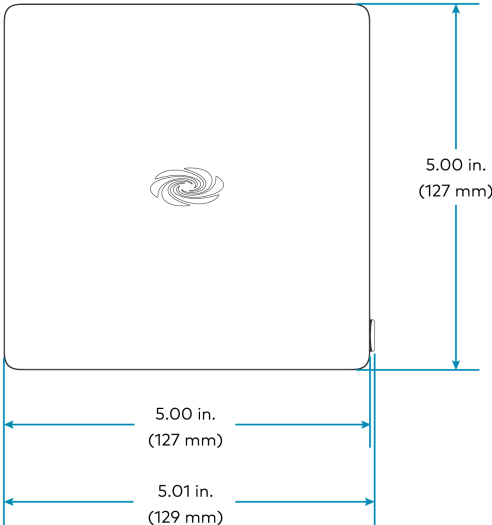
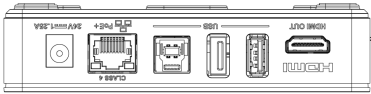

# AM-3200 Specifications

Product specifications for the AM-3200 are provided below.

## Specifications

### Communications

---

<b>Ethernet</b>	100/1000 Mbps, auto-switching, autonegotiating, autodiscovery, full/half duplex, TCP/IP, UDP/IP, DHCP, SSL, TLS <sup>5</sup> , SSH, SFTP (SSH File Transfer Protocol), IEEE 802.1x, Active Directory authentication, HTTPS web browser setup and XiO Cloud service, 802.3af compliant
<b>AirMedia</b>	Via Ethernet: IPv4, mDNS, TLS, AES <sup>1</sup>
<b>USB Host</b>	USB 2.0 for connecting a USB conferencing peripheral; USB 3.0 for connecting a USB conferencing peripheral
<b>USB Device</b>	USB 3.0 for computer console (installer setup and firmware update)
<b>RS-232</b>	2-way display device control up to 115.2k baud with hardware and software handshaking
<b>IR/Serial</b>	1-way display device control via infrared up to 1.1 MHz or serial TTL/RS-232 (0-5V) up to 19.2k baud
<b>HDMI Input</b>	HDCP 1.4, EDID; Supports management of HDCP and EDID
<b>HDMI Output</b>	HDCP 2.2, EDID, CEC; Supports management of HDCP and EDID

### AirMedia Software<sup>1</sup>

---

<b>OS Support</b>	Apple® iOS®, Android™, Windows 10, Windows 11, macOS®, Chrome OS™
<b>Video Frame Rate</b>	Up to 30 fps, audio supported
<b>Output Resolutions</b>	640x480@60Hz, 800x600@60Hz, 1024x768@60Hz, 1280x720@50Hz (720p50), 1280x720@60Hz (720p60), 1280x800@60Hz, 1366x768@60Hz, 1440x900@60Hz, 1600x900@60Hz, 1600x1200@60Hz, 1680x1050@60Hz, 1920x1080@50Hz (1080p50), 1920x1080@60Hz (1080p60)
	<b>NOTE:</b> All video inputs will be scaled to the selected HDMI output resolution.
<b>Bitrate Peak</b>	0.25 to 8.5 Mbps, variable depending on content complexity



**Bitrate Average** 1.4 Mbps typical

**NOTES:**

- The bitrate for Apple native mirroring may deviate from above depending on the OS version and content.
- The AirMedia Extension for the Google Chrome browser relies on web technologies for screen sharing that are built-in to the web browser. Performance variations with motion video (quality and frame rate) may occur based upon the encoding capabilities of the Chrome OS device and the nature of the content being displayed (i.e., high-motion video).

**Audio Format** Stereo

### Wireless Conferencing

---

**OS Support (AirMedia Application)** Windows 10, Windows 11

**OS Support (AirMedia Connect Adaptor)** Windows 10, Windows 11, macOS 11 or later

**Supported Conferencing Services** Microsoft Teams software;  
Zoom software

**Supported Conferencing Peripherals** For a list of supported conferencing peripherals, refer to [OLH 1001764](#).

### Video

---

**Input Signal Types** AirMedia, HDMI (DVI & Dual-Mode DisplayPort™ compatible<sup>2</sup>);  
Simultaneous display of up to four sources with AirMedia Canvas

**Maximum Input Resolutions** HDMI Input: 1920x1080@60Hz (HD 1080p60);  
AirMedia presentation: 1920x1080@30Hz (1080p30)

**NOTES:**

- Other input resolutions are supported at pixel clock rates up to 148 MHz; interlaced video is not supported.
- All video inputs will be scaled to the selected HDMI output resolution.

**Output Signal Types** HDMI (DVI compatible<sup>2</sup>)

**HDMI Output Resolutions** 1280x720@50Hz (720p50), 1280x720@60Hz (720p60), 1280x800@60Hz,<sup>6</sup>  
1366x768@60Hz,<sup>6</sup> 1440x900@60Hz,<sup>6</sup> 1600x900@60Hz,<sup>6</sup> 1600x1200@60Hz,  
1680x1050@60Hz,<sup>6</sup> 1920x1080@50Hz (1080p50), 1920x1080@60Hz  
(1080p60), 3840x2160@30Hz (2160p30), 3840x2160@50Hz (2160p50),  
3840x2160@60Hz (2160p60)

**NOTE:** All video inputs will be scaled to the selected HDMI output resolution.

**Background & Logo File Support** JPEG, PNG

## Audio

---

**Input Signal Types** AirMedia, HDMI (Dual-Mode DisplayPort™ compatible<sup>2</sup>)  
**Output Signal Type** HDMI  
**Input/Output Format** 2 channel LPCM

**NOTE:** Audio input signals are passed to the output without any processing. Volume control capability requires a display device with discrete volume, up, down, and mute commands available via CEC, IP, IR, or RS-232.

## Connectors

---

**IR** (1) 2-pin 3.5 mm detachable terminal block;  
IR/Serial output port for display device control;  
IR output up to 1.1 MHz;  
1-way serial TTL/RS-232 (0-5V) up to 19200 baud

**COM** (1) 5-pin 3.5 mm detachable terminal block;  
Bidirectional RS-232 port for display device control;  
Up to 115.2k baud, hardware and software handshaking support

**AUDIO OUT** (1) 5-pin 3.5 mm detachable terminal block;  
Balanced/unbalanced stereo line-level audio output;  
Maximum Output Level: 4 Vrms balanced, 2 Vrms unbalanced;  
Output Impedance: 200 ohms balanced, 100 ohms unbalanced

**microSD** For caching digital signage content

**HDMI INPUT** (1) HDMI Type A connector;  
HDMI digital video/audio input;  
(DVI & Dual-Mode DisplayPort compatible<sup>2</sup>)

**HDMI OUTPUT** (1) HDMI Type A connector;  
HDMI digital video/audio output  
(DVI compatible<sup>2</sup>)

**USB** (2) USB Type A connectors;  
USB 2.0 host port for USB conferencing peripheral;  
USB 3.0 host port for USB conferencing peripheral;  
(1) USB Type B connector;  
USB 3.0 device port for computer console

**LAN PoE+** (1) 8-pin RJ-45 connector;  
100Base-TX/1000Base-T Ethernet port and PoE+ Class 4

**LAN AUX** (1) 8-pin RJ-45 connector;  
100Base-TX/1000Base-T Ethernet port;  
Connects to a secondary, guest-only network

**24VDC 1.25A** (1) 2.1 x 5.5 mm DC power connector;  
24VDC power input;  
[PW-2412WU](#) power pack sold separately

## Controls and Indicators

---

<b>PWR</b>	(1) Green LED, indicates operating power supplied via the local power pack or PoE+
<b>RESET</b>	(1) Recessed push button for hardware reset
<b>SETUP</b>	(1) Green LED and (1) recessed push button for onscreen IP address display
<b>ONLINE</b>	(1) Green LED, indicates control system connection
<b>HDMI IN/OUT</b>	(2) Green LEDs, indicate HDMI signal presence at the HDMI input/output
<b>microSD</b>	(1) microSD slot
<b>LAN PoE+</b>	(2) LEDs, green LED indicates Ethernet link status, amber LED indicates Ethernet activity
<b>LAN AUX</b>	(2) LEDs, green LED indicates Ethernet link status, amber LED indicates Ethernet activity

## Power

---

<b>Power over Ethernet</b>	IEEE 802.3af Class 4 Powered Device
<b>Power Pack (sold separately)</b>	Input: 100-240VAC, 50/60 Hz; Output: 1.25A @ 24VDC; Model: <a href="#">PW-2412WU</a>
<b>Power Consumption</b>	14 W (typical)

**NOTE:** When wireless conferencing is used, the receiver must be powered by either Power over Ethernet+ (PoE+) or a power pack (sold separately).

## Environmental

---

<b>Temperature</b>	32° to 104°F (-0° to 40° C)
<b>Humidity</b>	10% to 90% RH (non-condensing)
<b>Heat Dissipation</b>	47.8 BTU/hr

## Construction

---

<b>Chassis</b>	Metal, black finish, with (2) integral mounting flanges, vented sides
<b>Mounting</b>	Freestanding, surface mount, or attach to a single rack rail

## Dimensions

---

<b>Height</b>	1.26 in. (33 mm)
<b>Width</b>	7.40 in. (188 mm)
<b>Depth</b>	6.54 in. (166 mm)

## Weight

---

1.9 lb (0.86 kg)

## Compliance

---

**Regulatory Model: M202018001**

Intertek® Listed for US & Canada, CE, IC, FCC Part 15 Class B digital device

## Notes:

1. AirMedia wireless presentation requires a wired network connection between the AirMedia receiver and an external Wi-Fi wireless access point (not included). Laptops may alternately connect to AirMedia using a wired Ethernet connection. Full-motion video performance is dependent upon the performance of the network and the sending device. Computer client software and mobile device apps are available for download at [www.crestron.com/airmedia](http://www.crestron.com/airmedia).
2. Using an appropriate adapter or interface cable, the HDMI input can support DVI and Dual-Mode DisplayPort sources, and the HDMI output can provide a DVI signal. CBL-HD-DVI interface cables are available separately.
3. When the AirMedia Canvas feature is enabled, the 4:2:0 color space is used for high definition sources connected to the HDMI input port. When the AirMedia Canvas feature is disabled, the 4:4:4 color space is used. If the 4:4:4 color space is required by sources connected to the HDMI input port, the AirMedia Canvas feature should be disabled.
4. Crestron supports most mainstream devices and applications. For a list of supported conferencing peripherals, refer to [OLH 1001764](#).
5. TLS 1.3 is currently not supported.
6. With or without reduced blanking.

# Dimension Drawings

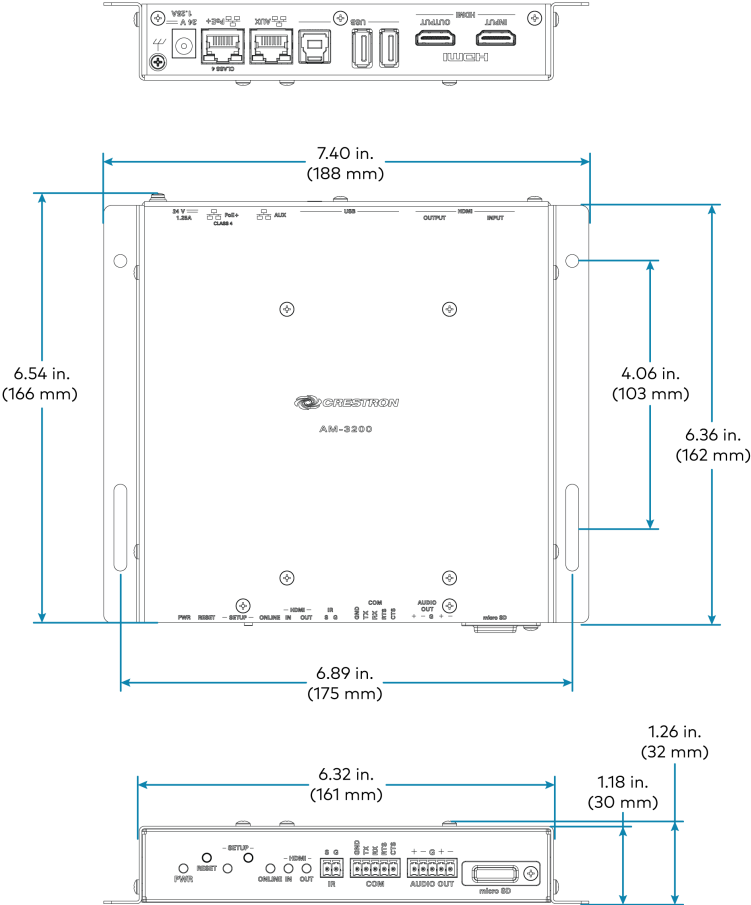

# AM-3200-WF(-I) Specifications

Product specifications for the AM-3200-WF(-I) are provided below.

## Specifications

### Communications

---

<b>Ethernet</b>	100/1000 Mbps, auto-switching, autonegotiating, autodiscovery, full/half duplex, TCP/IP, UDP/IP, DHCP, SSL, TLS <sup>5</sup> , SSH, SFTP (SSH File Transfer Protocol), IEEE 802.1x, Active Directory authentication, HTTPS web browser setup and XiO Cloud service, 802.3af compliant
<b>Wi-Fi</b>	Dual-band 802.11a/b/g/n/ac/ax (2.4 GHz & 5 GHz); Up to 70 ft (23 m) range at 80 Mbps, subject to site-specific conditions
<b>Bluetooth® Communications</b>	Bluetooth version 5.0
<b>AirMedia</b>	Via Ethernet: IPv4, mDNS, TLS, AES <sup>1</sup> ; Via wireless access point: IEEE 802.11/b/g/n/ac/ax, 2.4 GHz or 5 GHz
<b>USB Host</b>	USB 2.0 for connecting a USB conferencing peripheral; USB 3.0 for connecting a USB conferencing peripheral
<b>USB Device</b>	USB 3.0 for computer console (installer setup and firmware update)
<b>RS-232</b>	2-way display device control up to 115.2k baud with hardware and software handshaking
<b>IR/Serial</b>	1-way display device control via infrared up to 1.1 MHz or serial TTL/RS-232 (0-5V) up to 19.2k baud
<b>HDMI Input</b>	HDCP 1.4, EDID; Supports management of HDCP and EDID
<b>HDMI Output</b>	HDCP 2.2, EDID, CEC; Supports management of HDCP and EDID

### AirMedia Software<sup>1</sup>

---

<b>OS Support</b>	Apple® iOS®, Android™, Windows 10, Windows 11, macOS®, Chrome OS™
<b>Video Frame Rate</b>	Up to 30 fps, audio supported
<b>Output Resolutions</b>	640x480@60Hz, 800x600@60Hz, 1024x768@60Hz, 1280x720@50Hz (720p50), 1280x720@60Hz (720p60), 1280x800@60Hz, 1366x768@60Hz, 1440x900@60Hz, 1600x900@60Hz, 1600x1200@60Hz, 1680x1050@60Hz, 1920x1080@50Hz (1080p50), 1920x1080@60Hz (1080p60)
	<b>NOTE:</b> All video inputs will be scaled to the selected HDMI output resolution.
<b>Bitrate Peak</b>	0.25 to 8.5 Mbps, variable depending on content complexity

**Bitrate Average** 1.4 Mbps typical

**NOTES:**

- The bitrate for Apple native mirroring may deviate from above depending on the OS version and content.
- The AirMedia Extension for the Google Chrome browser relies on web technologies for screen sharing that are built-in to the web browser. Performance variations with motion video (quality and frame rate) may occur based upon the encoding capabilities of the Chrome OS device and the nature of the content being displayed (i.e., high-motion video).

**Audio Format** Stereo

### Wireless Conferencing

---

**OS Support (AirMedia Application)** Windows 10, Windows 11

**OS Support (AirMedia Connect Adaptor)** Windows 10, Windows 11, macOS 11 or later

**Supported Conferencing Services** Microsoft Teams software;  
Zoom software

**Supported Conferencing Peripherals** For a list of supported conferencing peripherals, refer to [OLH 1001764](#).

### Video

---

**Input Signal Types** AirMedia, HDMI (DVI & Dual-Mode DisplayPort™ compatible<sup>2</sup>);  
Simultaneous display of up to four sources with AirMedia Canvas

**Maximum Input Resolutions** HDMI Input: 1920x1080@60Hz (HD 1080p60);  
AirMedia presentation: 1920x1080@30Hz (1080p30);  
AirMedia Connect Adapter: 3840x2160@30Hz (4K30)

**NOTES:**

- Other input resolutions are supported at pixel clock rates up to 148 MHz; interlaced video is not supported.
- All video inputs will be scaled to the selected HDMI output resolution.

**Output Signal Types** HDMI (DVI compatible<sup>2</sup>)

**HDMI Output Resolutions** 1280x720@50Hz (720p50), 1280x720@60Hz (720p60), 1280x800@60Hz,<sup>6</sup> 1366x768@60Hz,<sup>6</sup> 1440x900@60Hz,<sup>6</sup> 1600x900@60Hz,<sup>6</sup> 1600x1200@60Hz, 1680x1050@60Hz,<sup>6</sup> 1920x1080@50Hz (1080p50), 1920x1080@60Hz (1080p60), 3840x2160@30Hz (2160p30), 3840x2160@50Hz (2160p50), 3840x2160@60Hz (2160p60)

**NOTE:** All video inputs will be scaled to the selected HDMI output resolution.

**Background & Logo File Support** JPEG, PNG

## Audio

---

**Input Signal Types** AirMedia, HDMI (Dual-Mode DisplayPort™ compatible<sup>2</sup>)  
**Output Signal Type** HDMI  
**Input/Output Format** 2 channel LPCM

**NOTE:** Audio input signals are passed to the output without any processing. Volume control capability requires a display device with discrete volume, up, down, and mute commands available via CEC, IP, IR, or RS-232.



## Connectors

---

<b>ANT-A &amp; ANT-B</b>	(2) SMA connectors for external Wi-Fi antennas; Wi-Fi antennas included with 6.56 ft (2 m) cables
<b>IR</b>	(1) 2-pin 3.5 mm detachable terminal block; IR/Serial output port for display device control; IR output up to 1.1 MHz; 1-way serial TTL/RS-232 (0-5V) up to 19200 baud
<b>COM</b>	(1) 5-pin 3.5 mm detachable terminal block; Bidirectional RS-232 port for display device control; Up to 115.2k baud, hardware and software handshaking support
<b>AUDIO OUT</b>	(1) 5-pin 3.5 mm detachable terminal block; Balanced/unbalanced stereo line-level audio output; Maximum Output Level: 4 Vrms balanced, 2 Vrms unbalanced; Output Impedance: 200 ohms balanced, 100 ohms unbalanced
<b>microSD</b>	For caching digital signage content
<b>HDMI INPUT</b>	(1) HDMI Type A connector; HDMI digital video/audio input; (DVI & Dual-Mode DisplayPort compatible <sup>2</sup> )
<b>HDMI OUTPUT</b>	(1) HDMI Type A connector; HDMI digital video/audio output (DVI compatible <sup>2</sup> )
<b>USB</b>	(2) USB Type A connectors; USB 2.0 host port for USB conferencing peripheral; USB 3.0 host port for USB conferencing peripheral; (1) USB Type B connector; USB 3.0 device port for computer console
<b>LAN PoE+</b>	(1) 8-pin RJ-45 connector; 100Base-TX/1000Base-T Ethernet port and PoE+ Class 4
<b>LAN AUX</b>	(1) 8-pin RJ-45 connector; 100Base-TX/1000Base-T Ethernet port; Connects to a secondary, guest-only network
<b>24VDC 1.25A</b>	(1) 2.1 x 5.5 mm DC power connector; 24VDC power input; <a href="#">PW-2412WU</a> power pack sold separately

## Controls and Indicators

---

<b>PWR</b>	(1) Green LED, indicates operating power supplied via the local power pack or PoE+
<b>RESET</b>	(1) Recessed push button for hardware reset
<b>SETUP</b>	(1) Recessed push button for onscreen IP address display and for pairing the device to an AM-TX3-100; (1) Red/White LED, indicates pairing status
<b>ONLINE</b>	(1) Green LED, indicates control system connection
<b>HDMI IN/OUT</b>	(2) Green LEDs, indicate HDMI signal presence at the HDMI input/output
<b>microSD</b>	(1) microSD slot
<b>LAN PoE+</b>	(2) LEDs, green LED indicates Ethernet link status, amber LED indicates Ethernet activity
<b>LAN AUX</b>	(2) LEDs, green LED indicates Ethernet link status, amber LED indicates Ethernet activity

## Power

---

<b>Power over Ethernet</b>	IEEE 802.3af Class 4 Powered Device
<b>Power Pack (sold separately)</b>	Input: 100-240VAC, 50/60 Hz; Output: 1.25A @ 24VDC; Model: <a href="#">PW-2412WU</a>
<b>Power Consumption</b>	14 W (typical)

**NOTE:** When wireless conferencing is used, the receiver must be powered by either Power over Ethernet+ (PoE+) or a power pack (sold separately).

## Environmental

---

<b>Temperature</b>	32° to 104°F (-0° to 40° C)
<b>Humidity</b>	10% to 90% RH (non-condensing)
<b>Heat Dissipation</b>	47.8 BTU/hr

## Construction

---

<b>Chassis</b>	Metal, black finish, with (2) integral mounting flanges, vented sides
<b>Mounting</b>	Freestanding, surface mount, or attach to a single rack rail

## Dimensions

---

Height	1.26 in. (33 mm)
Width	7.40 in. (188 mm)
Depth	6.93 in. (177 mm)

## Weight

---

1.9 lb (0.86 kg)

## Compliance

---

### Regulatory Model: M202018001

Intertek® Listed for US & Canada, CE, IC, FCC Part 15 Class B digital device

#### Notes:

1. AirMedia wireless presentation requires a wired network connection between the AirMedia receiver and an external Wi-Fi wireless access point (not included). Laptops may alternately connect to AirMedia using a wired Ethernet connection. Full-motion video performance is dependent upon the performance of the network and the sending device. Computer client software and mobile device apps are available for download at [www.crestron.com/airmedia](http://www.crestron.com/airmedia).
2. Using an appropriate adapter or interface cable, the HDMI input can support DVI and Dual-Mode DisplayPort sources, and the HDMI output can provide a DVI signal. CBL-HD-DVI interface cables are available separately.
3. When the AirMedia Canvas feature is enabled, the 4:2:0 color space is used for high definition sources connected to the HDMI input port. When the AirMedia Canvas feature is disabled, the 4:4:4 color space is used. If the 4:4:4 color space is required by sources connected to the HDMI input port, the AirMedia Canvas feature should be disabled.
4. Crestron supports most mainstream devices and applications. For a list of supported conferencing peripherals, refer to [OLH 1001764](#).
5. TLS 1.3 is currently not supported.
6. With or without reduced blanking.



# AM-3200-GV Specifications

Product specifications for the AM-3200-GV are provided below.

## Specifications

### Communications

---

<b>Ethernet</b>	100/1000 Mbps, auto-switching, autonegotiating, autodiscovery, full/half duplex, TCP/IP, UDP/IP, DHCP, SSL, TLS <sup>5</sup> , SSH, SFTP (SSH File Transfer Protocol), IEEE 802.1x, Active Directory authentication, HTTPS web browser setup and XiO Cloud service, 802.3af compliant
<b>AirMedia</b>	Via Ethernet: IPv4, mDNS, TLS, AES <sup>1</sup>
<b>USB Host</b>	USB 2.0 for connecting a USB conferencing peripheral; USB 3.0 for connecting a USB conferencing peripheral
<b>USB Device</b>	USB 3.0 for computer console (installer setup and firmware update)
<b>RS-232</b>	2-way display device control up to 115.2k baud with hardware and software handshaking
<b>IR/Serial</b>	1-way display device control via infrared up to 1.1 MHz or serial TTL/RS-232 (0-5V) up to 19.2k baud
<b>HDMI Input</b>	HDCP 1.4, EDID; Supports management of HDCP and EDID
<b>HDMI Output</b>	HDCP 2.2, EDID, CEC; Supports management of HDCP and EDID

### AirMedia Software<sup>1</sup>

---

<b>OS Support</b>	Apple® iOS®, Android™, Windows 10, Windows 11, macOS®, Chrome OS™
<b>Video Frame Rate</b>	Up to 30 fps, audio supported
<b>Output Resolutions</b>	640x480@60Hz, 800x600@60Hz, 1024x768@60Hz, 1280x720@50Hz (720p50), 1280x720@60Hz (720p60), 1280x800@60Hz, 1366x768@60Hz, 1440x900@60Hz, 1600x900@60Hz, 1600x1200@60Hz, 1680x1050@60Hz, 1920x1080@50Hz (1080p50), 1920x1080@60Hz (1080p60)
	<b>NOTE:</b> All video inputs will be scaled to the selected HDMI output resolution.
<b>Bitrate Peak</b>	0.25 to 8.5 Mbps, variable depending on content complexity

**Bitrate Average** 1.4 Mbps typical

**NOTES:**

- The bitrate for Apple native mirroring may deviate from above depending on the OS version and content.
- The AirMedia Extension for the Google Chrome browser relies on web technologies for screen sharing that are built-in to the web browser. Performance variations with motion video (quality and frame rate) may occur based upon the encoding capabilities of the Chrome OS device and the nature of the content being displayed (i.e., high-motion video).

**Audio Format** Stereo

### Wireless Conferencing

---

**OS Support (AirMedia Application)** Windows 10, Windows 11

**Supported Conferencing Services** Microsoft Teams software;  
Zoom software

**Supported Conferencing Peripherals** For a list of supported conferencing peripherals, refer to [OLH 1001764](#).

### Video

---

**Input Signal Types** AirMedia, HDMI (DVI & Dual-Mode DisplayPort™ compatible<sup>2</sup>);  
Simultaneous display of up to four sources with AirMedia Canvas

**Maximum Input Resolutions** HDMI Input: 1920x1080@60Hz (HD 1080p60);  
AirMedia presentation: 1920x1080@30Hz (1080p30)

**NOTES:**

- Other input resolutions are supported at pixel clock rates up to 148 MHz; interlaced video is not supported.
- All video inputs will be scaled to the selected HDMI output resolution.

**Output Signal Types** HDMI (DVI compatible<sup>2</sup>)

**HDMI Output Resolutions** 1280x720@50Hz (720p50), 1280x720@60Hz (720p60), 1280x800@60Hz,<sup>6</sup>  
1366x768@60Hz,<sup>6</sup> 1440x900@60Hz,<sup>6</sup> 1600x900@60Hz,<sup>6</sup> 1600x1200@60Hz,  
1680x1050@60Hz,<sup>6</sup> 1920x1080@50Hz (1080p50), 1920x1080@60Hz  
(1080p60), 3840x2160@30Hz (2160p30), 3840x2160@50Hz (2160p50),  
3840x2160@60Hz (2160p60)

**NOTE:** All video inputs will be scaled to the selected HDMI output resolution.

**Background & Logo File Support** JPEG, PNG

## Audio

---

<b>Input Signal Types</b>	AirMedia, HDMI (Dual-Mode DisplayPort™ compatible <sup>2</sup> )
<b>Output Signal Type</b>	HDMI
<b>Input/Output Format</b>	2 channel LPCM

**NOTE:** Audio input signals are passed to the output without any processing. Volume control capability requires a display device with discrete volume, up, down, and mute commands available via CEC, IP, IR, or RS-232.

## Connectors

---

<b>IR</b>	(1) 2-pin 3.5 mm detachable terminal block; IR/Serial output port for display device control; IR output up to 1.1 MHz; 1-way serial TTL/RS-232 (0-5V) up to 19200 baud
<b>COM</b>	(1) 5-pin 3.5 mm detachable terminal block; Bidirectional RS-232 port for display device control; Up to 115.2k baud, hardware and software handshaking support
<b>AUDIO OUT</b>	(1) 5-pin 3.5 mm detachable terminal block; Balanced/unbalanced stereo line-level audio output; Maximum Output Level: 4 Vrms balanced, 2 Vrms unbalanced; Output Impedance: 200 ohms balanced, 100 ohms unbalanced
<b>microSD</b>	For caching digital signage content
<b>HDMI INPUT</b>	(1) HDMI Type A connector; HDMI digital video/audio input; (DVI & Dual-Mode DisplayPort compatible <sup>2</sup> )
<b>HDMI OUTPUT</b>	(1) HDMI Type A connector; HDMI digital video/audio output (DVI compatible)
<b>USB</b>	(2) USB Type A connectors;  (1) USB Type B connector; USB 3.0 device port for computer console
<b>LAN PoE+</b>	(1) 8-pin RJ-45 connector; 100Base-TX/1000Base-T Ethernet port and PoE+ Class 4
<b>LAN AUX</b>	(1) 8-pin RJ-45 connector; 100Base-TX/1000Base-T Ethernet port; Connects to a secondary, guest-only network
<b>24VDC 1.25A</b>	(1) 2.1 x 5.5 mm DC power connector; 24VDC power input; <a href="#">PW-2412WU</a> power pack sold separately

## Controls and Indicators

---

<b>PWR</b>	(1) Green LED, indicates operating power supplied via the local power pack or PoE+
------------	--

<b>RESET</b>	(1) Recessed push button for hardware reset
<b>SETUP</b>	(1) Green LED and (1) recessed push button for onscreen IP address display
<b>ONLINE</b>	(1) Green LED, indicates control system connection
<b>HDMI IN/OUT</b>	(2) Green LEDs, indicate HDMI signal presence at the HDMI input/output
<b>microSD</b>	(1) microSD slot
<b>LAN PoE+</b>	(2) LEDs, green LED indicates Ethernet link status, amber LED indicates Ethernet activity
<b>LAN AUX</b>	(2) LEDs, green LED indicates Ethernet link status, amber LED indicates Ethernet activity

## Power

<b>Power over Ethernet</b>	IEEE 802.3af Class 4 Powered Device
<b>Power Pack (sold separately)</b>	Input: 100-240VAC, 50/60 Hz; Output: 1.25A @ 24VDC; Model: <a href="#">PW-2412WU</a>
<b>Power Consumption</b>	14 W (typical)

**NOTE:** When wireless conferencing is used, the receiver must be powered by either Power over Ethernet+ (PoE+) or a power pack (sold separately).

## Environmental

<b>Temperature</b>	32° to 104°F (-0° to 40° C)
<b>Humidity</b>	10% to 90% RH (non-condensing)
<b>Heat Dissipation</b>	47.8 BTU/hr

## Construction

<b>Chassis</b>	Metal, black finish, with (2) integral mounting flanges, vented sides
<b>Mounting</b>	Freestanding, surface mount, or attach to a single rack rail

## Dimensions

<b>Height</b>	1.26 in. (33 mm)
<b>Width</b>	7.40 in. (188 mm)
<b>Depth</b>	6.54 in. (166 mm)

## Weight

1.9 lb (0.86 kg)

## Compliance

**Regulatory Model: M202018001**

Intertek® Listed for US & Canada, CE, IC, FCC Part 15 Class B digital device



# Dimension Drawings

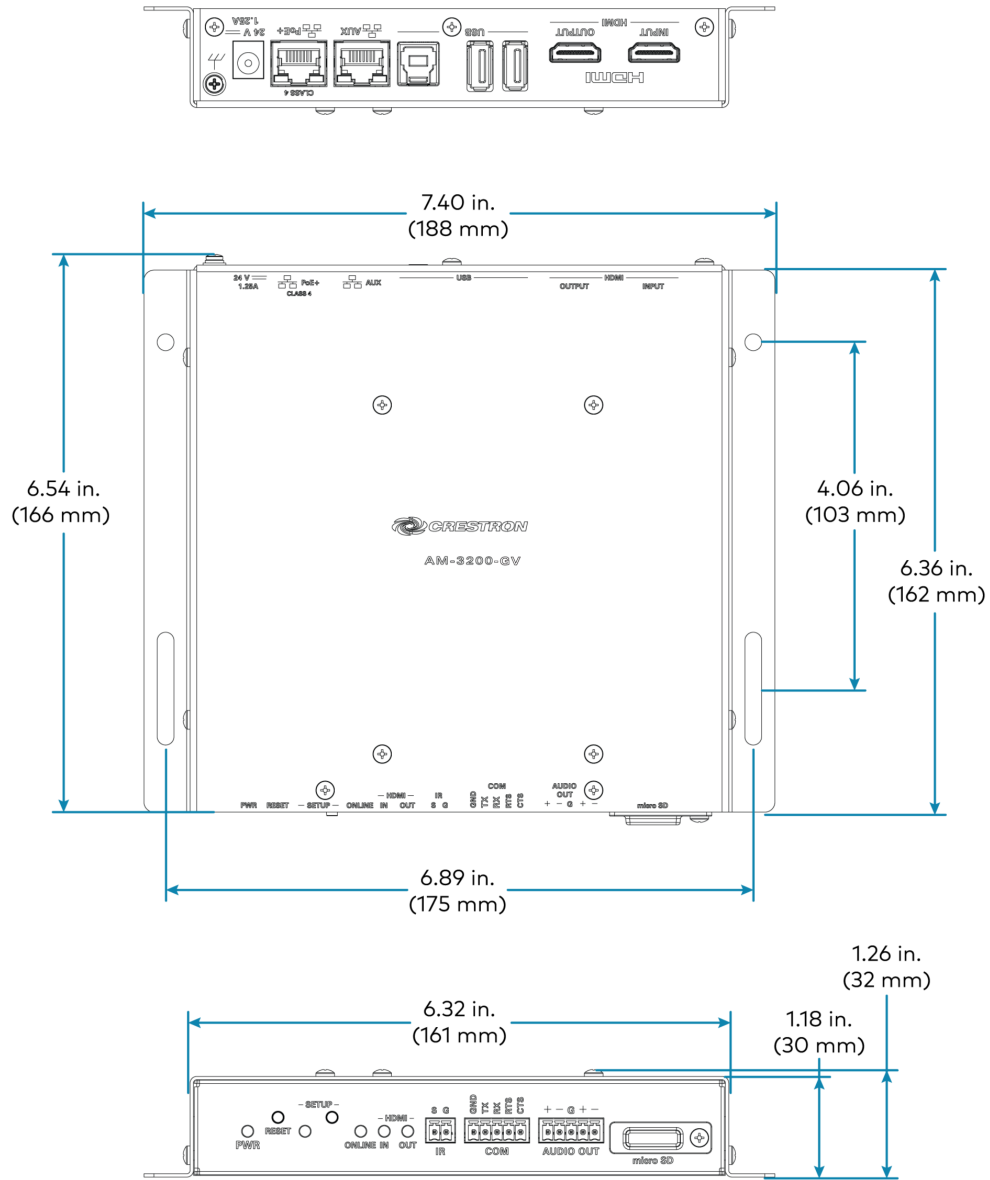

# AM-TX3-100(-I) Specifications

Product specifications for the AM-TX3-100 are provided below.

## Specifications

### Communications

---

Wi-Fi	Dual-band WiFi 6 802.11a/b/g/n/ac/ax (2.4 GHz & 5 GHz); Up to 70 ft (23 m) range at 80 Mbps, subject to site-specific conditions; Refer to <a href="#">Wireless Best Practices</a> for more information.
USB	USB 2.0
OS Support	Windows 10, Windows 11, macOS® 11 or newer

### Video

---

Input Signal Types	DisplayPort™ Alt Mode over USB-C
Output Signal Types	Network stream over Wi-Fi, received by a paired AirMedia Series 3 receiver ( <a href="#">AM-3000-WF</a> , <a href="#">AM-3100-WF</a> , or <a href="#">AM-3200-WF</a> )
Maximum Resolution	3840x2160@30Hz (2160p30); Output resolution is determined by the HDMI® output on a paired AirMedia Series 3 receiver ( <a href="#">AM-3000-WF</a> , <a href="#">AM-3100-WF</a> , or <a href="#">AM-3200-WF</a> )

**NOTE:** All video inputs will be scaled to the selected HDMI output resolution.

### Audio

---

Input Signal Types	DisplayPort Alt Mode over USB-C
Output Signal Type	Network stream over Wi-Fi, received by a paired AirMedia Series 3 receiver ( <a href="#">AM-3000-WF</a> , <a href="#">AM-3100-WF</a> , or <a href="#">AM-3200-WF</a> )
Input/Output Format	2 channel LPCM

### Connectors

---

USB	(1) USB-C connector, male
-----	---------------------------

### Controls and Indicators

---

Status Ring	RGB LED Ring indicates device status
Screenshare	(1) RGB backlit capacitive touch button controls screensharing functions
Peripherals	(1) RGB backlit capacitive touch button controls various peripheral <sup>1</sup> functions

### Power

---

USB	Powered via USB-C connection to personal device
Power Consumption	2.5 W (typical)

## Environmental

---

Temperature	32° to 104°F (0° to 40°C)
Humidity	10% to 90% RH (non-condensing)
Heat Dissipation	8.5 BTU/hr

## Construction

---

Chassis	Plastic, black finish
Mounting	Freestanding, surface mount

## Dimensions

---

Height	2.95 in. (75 mm)
Width	0.66 in. (17 mm)
Depth	7 in. (178 mm) including cable

## Weight

---

3.17 oz (90 g)

## Compliance

---

**Regulatory Model: M202018001**

Intertek® Listed for US & Canada, CE, IC, FCC Part 15 Class B digital device

Note:

1. Wireless Conferencing functionality through the AirMedia Connect Adaptor requires a WiFi® network and Wireless Conferencing compatible AirMedia Series 3 Receiver.

# Dimension Drawings

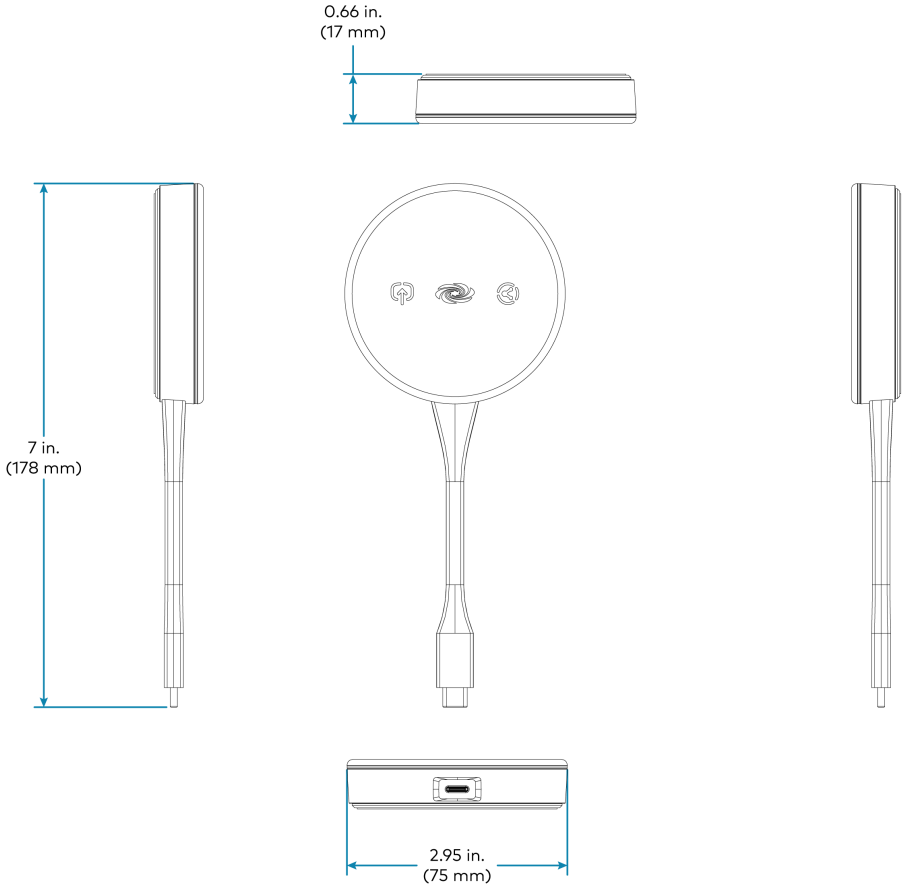

# UC-SB-P50-AM-WF(-I) KIT

## Specifications

Product specifications for the UC-P50-AM-WF(-I) KIT are provided below.

### Components

---

<a href="#">AM-3100-WF</a>	AirMedia® Receiver 3100 with Wi-Fi® Network Connectivity
<a href="#">UC-SB-P50</a>	Jabra PanaCast 50 intelligent video bar

### Jabra® PanaCast 50 Video Bar

---

<b>Speakers</b>	(4) speakers, stereo; 2 in. (50 mm) woofers; 2 x 3/4 in. (50 x 20 mm) tweeters; 80 Hz to 20 kHz frequency response; Automatic speaker detection
<b>Microphone</b>	(8) microphone beamforming array; -37 dBFS microphone sensitivity; 100 Hz to 8 kHz microphone frequency range; Suitable for rooms up to 15 x 15 ft (4.5 x 4.5 m)

**NOTE:** Microphone pickup range may vary in rooms with highly reflective infrastructure (e.g., glass walls, metal furniture, open ceilings, etc.) or above average ambient noise.

<b>Camera Optics</b>	(3) cameras; 13 Megapixels
<b>Camera Field of View</b>	180° horizontal, 54° vertical
<b>Autozoom</b>	Automatic digital zoom dynamically frames people within 11 ft (3.5 m)
<b>Camera Resolution</b>	3840 x 1080 @ 30 fps
<b>Power</b>	From external power pack; Input: 100-240VAC, 50/60 Hz; Output: 5A @ 12V
<b>Enclosure</b>	Black speaker and camera housing, rear air vents, integrated adjustable mounting bracket
<b>Mounting</b>	Wall mount using integrated mounting bracket; Optional table mount or VESA® compliant screen mount (both sold separately)
<b>Dimensions</b>	Height: 3.1 in. (90 mm) Width: 25.6 in. (650 mm) Depth: 4.9 in. (125 mm)
<b>Weight</b>	4.85 lb (2.2 kg)

# Installation

Refer to the following sections for instructions on how to install the various AirMedia Series 3 devices and bundles.

- [AM-3000-WF\(-I\) and AM-3100-WF\(-I\) on page 62](#)
- [AM-3200, AM-3200-WF\(-I\), and AM-3200-GV on page 67](#)
- [AM-TX3-100\(-I\) on page 73](#)
- [UC-SB-P50-AM-WF\(-I\) KIT on page 76](#)

# AM-3000-WF(-I) and AM-3100-WF(-I)

Refer to the following sections to install the AM-3000-WF(-I) and AM-3100-WF(-I).

- [In the Box on page 62](#)
- [Connect the Receiver on page 65](#)
- [Observe the LEDs on page 66](#)

## In the Box

---

### Qty. Description

---

- |   |   |
|---|---|
| 1 | AirMedia Series 3 Receiver<br>AM-3000-WF (6513018), AM-3000-WF-I, (6513019),<br>AM-3100-WF (6511540), or AM-3100-WF-I (6511541) |
|---|---|

### Additional Items

- |   |   |
|---|---|
| 2 | Anchor, Wall, Plastic (2057414)         |
| 2 | Screw, Metal, 1.18 in (30 mm) (2057420) |
- 

## Install the Receiver

The device can be placed or mounted onto a flat surface.

### Place onto a Flat Surface

Place the device onto any flat, level surface. The rubber strips on the bottom of the receiver prevent it from moving easily.

### Mount onto a Flat Surface

Using the included mounting screws and anchors, mount the device onto a flat surface such as a wall or the underside of a table. Use the mounting dimensions on the following page to determine the mounting hole locations.

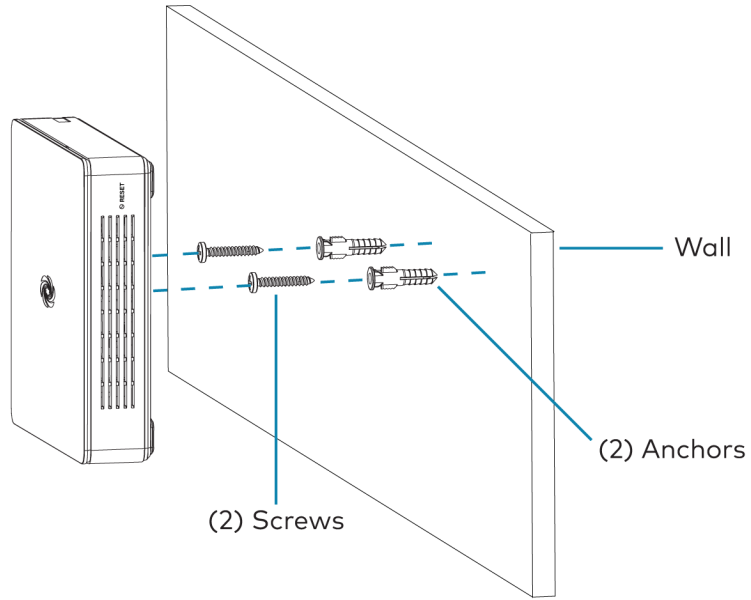



AM-3000-WF, AM-3000-WF-I, AM-3100-WF, and AM-3100-WF-I Mounting

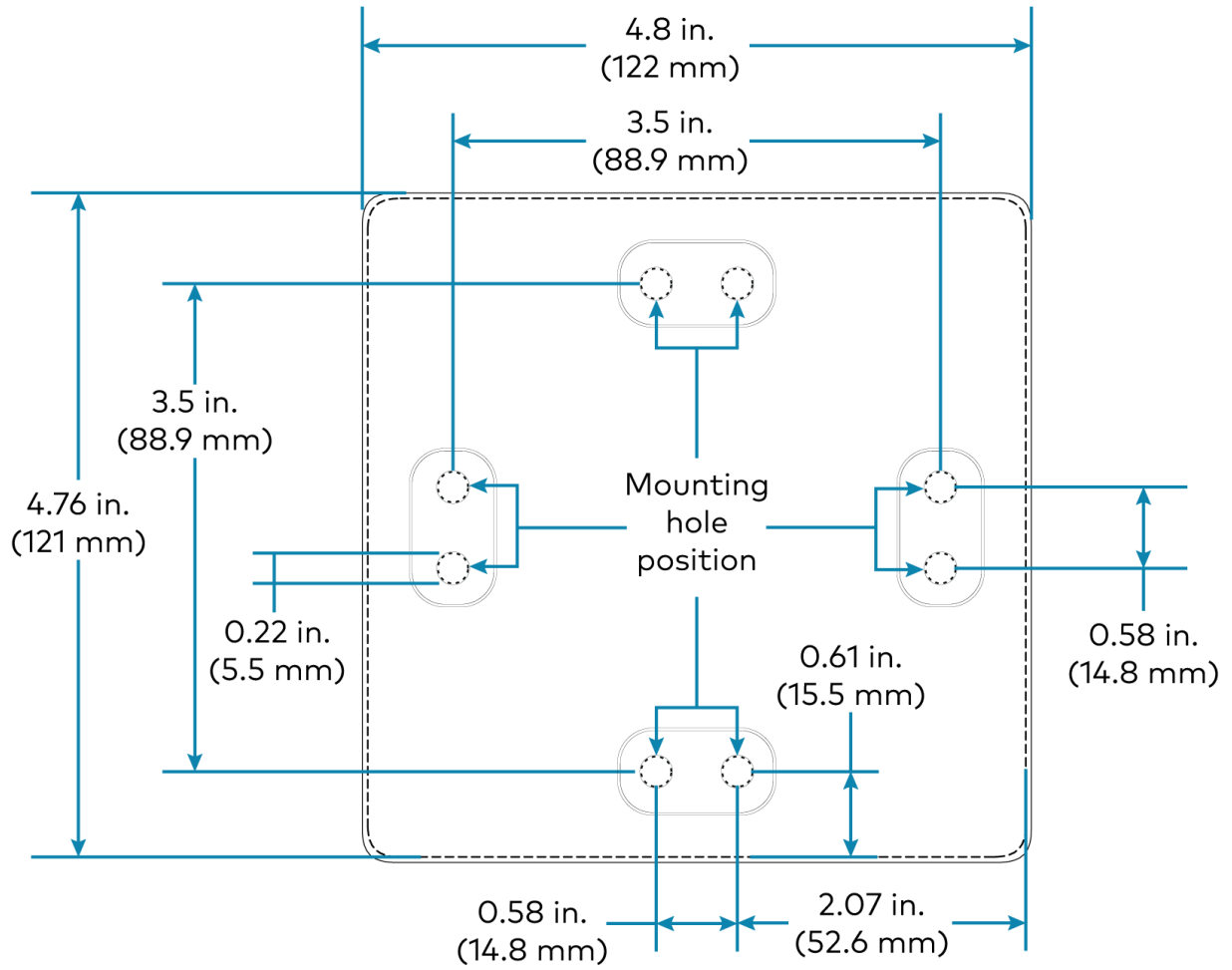

# Connect the Receiver

Make connections to the device as shown in the following diagram.

## NOTES:

- The device receives power from a Power over Ethernet (PoE, IEEE 802.3af) or Power over Ethernet+ (PoE+, IEEE 802.3at) connection. It can also receive power from the [PW-2412WU](#) power pack (sold separately).
- PoE-type networks connected to the LAN PoE+ port are for intrabuilding use only. Do not connect this device to lines that run outside of the building.

## Rear Panel Connections

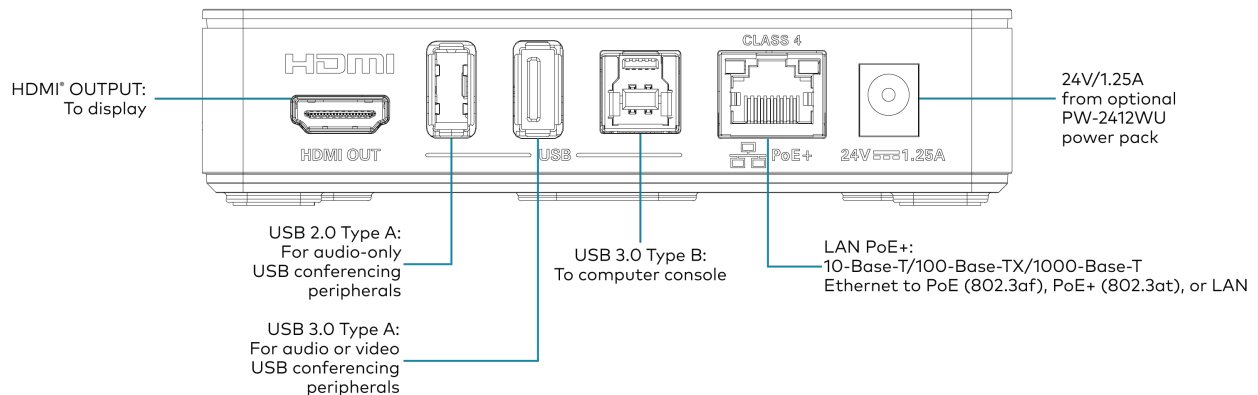

## Wireless Conferencing Peripherals

Connect Wireless Conferencing peripherals to the following USB ports:

- **USB 3.0:** Cameras or all-in-one audio and video devices:
- **USB 2.0:** Microphones, speakers, or DSPs

## NOTES:

- Wireless Conferencing is unavailable on the AM-3000-WF and AM-3000-WF-I. Connected conferencing peripherals will not function
- To use USB conferencing peripherals, the device must be powered by PoE+ or the PW-2412WU power pack. Do not simultaneously provide PoE or PoE+ and local power.

# Observe the LEDs

Refer to the following table and diagram for information about the LED indicators on the device.

LED Indicator	Color	Meaning
Power	White	Power is being applied to the device. The device is operational.
	Amber	Power is being applied to the device. The device is booting.
Setup	White	The setup button was pressed.
Online	White	The device is connected to a Crestron Control System.
HDMI	White	A video signal is being transmitted to the HDMI output.
LAN Indicators (located on rear panel)	Green	An Ethernet link is established.
	Flashing amber	Data activity is occurring on the Ethernet link.

## LED Indicators - Front Panel

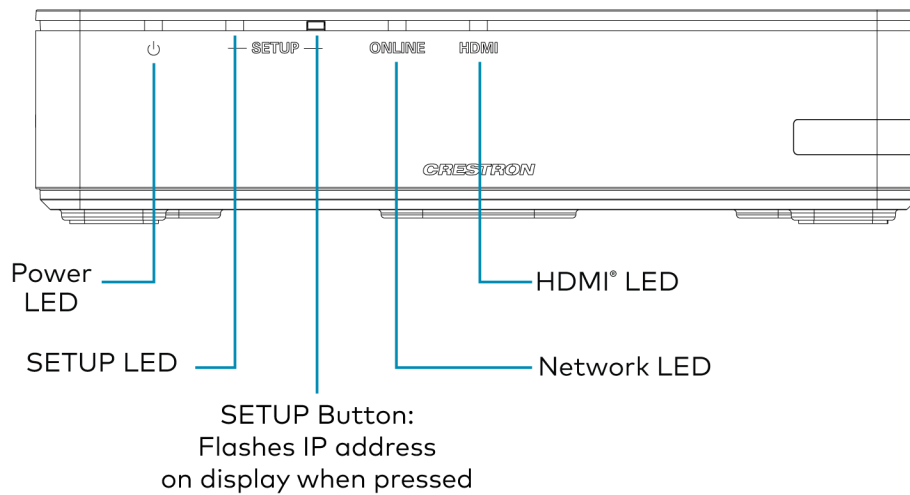

# AM-3200, AM-3200-WF(-I), and AM-3200-GV

Refer to the following sections to install the AM-3200, AM-3200-WF(-I), and AM-3200-GV.

- [In the Box on page 67](#)
- [Connect the Receiver on page 70](#)
- [Observe the LEDs on page 72](#)

## In the Box

---

### Qty. Description

---

- |   |  |
|---|--|
| 1 | AirMedia Series 3 Receiver<br>AM-3200 (6511482), AM-3200-WF, (6511483),<br>AM-3200-WF-I (6511484), or AM-3200-GV (6513188) |
|---|--|

#### Additional Items

- |   |   |
|---|---|
| 4 | Anchor, Wall, Plastic (2057414)         |
| 4 | Screw, Metal, 0.98 in (25 mm) (2057419) |
| 1 | Connector, 2-Pin (2057409)              |
| 2 | Connector, 5-Pin (2057410)              |

#### Additional Item for AM-3200-WF(-I) Only

- |   |   |
|---|---|
| 2 | Antenna with cable, SMA, Female (2057413) |
|---|---|
- 

## Install the Receiver

The device can be mounted onto a rack rail or flat surface.

### Mounting onto a Rack Rail

The device can be mounted onto a front or rear rack rail. To mount the device:

1. Position either the left or right mounting flange so that the holes align with the holes in the rack rail.
2. Secure the device to the rack rail using two rack mount screws (not included).

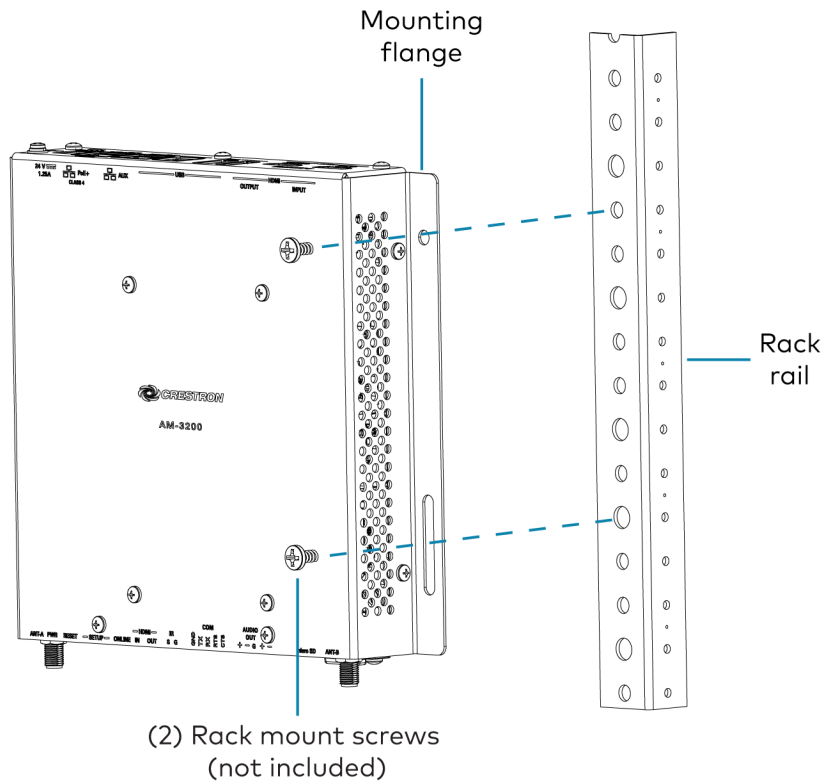

## Mounting onto a Flat Surface

Using the included mounting screws and anchors, mount the device onto a flat surface such as a wall or the underside of a table. Use the mounting dimensions on the following page to determine the mounting hole locations.

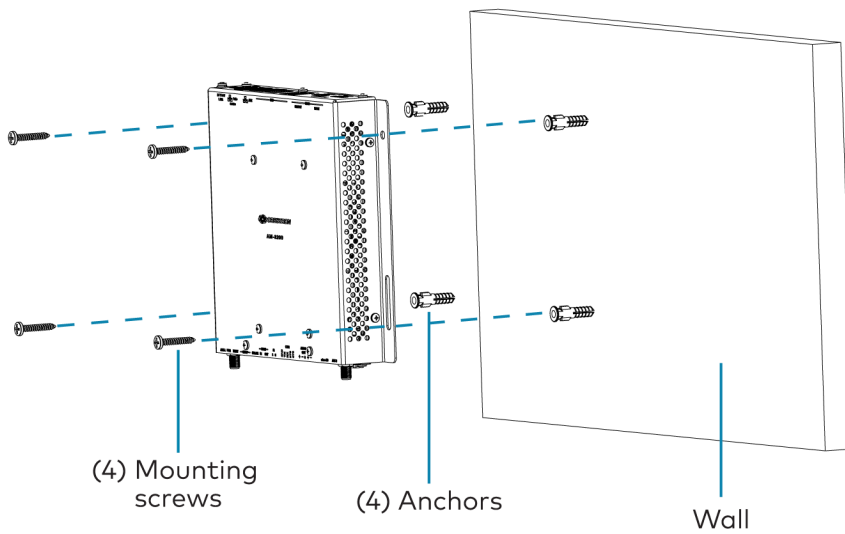

AM-3200, AM-3200-WF, AM-3200-WF-I, and AM-3200-GV Mounting

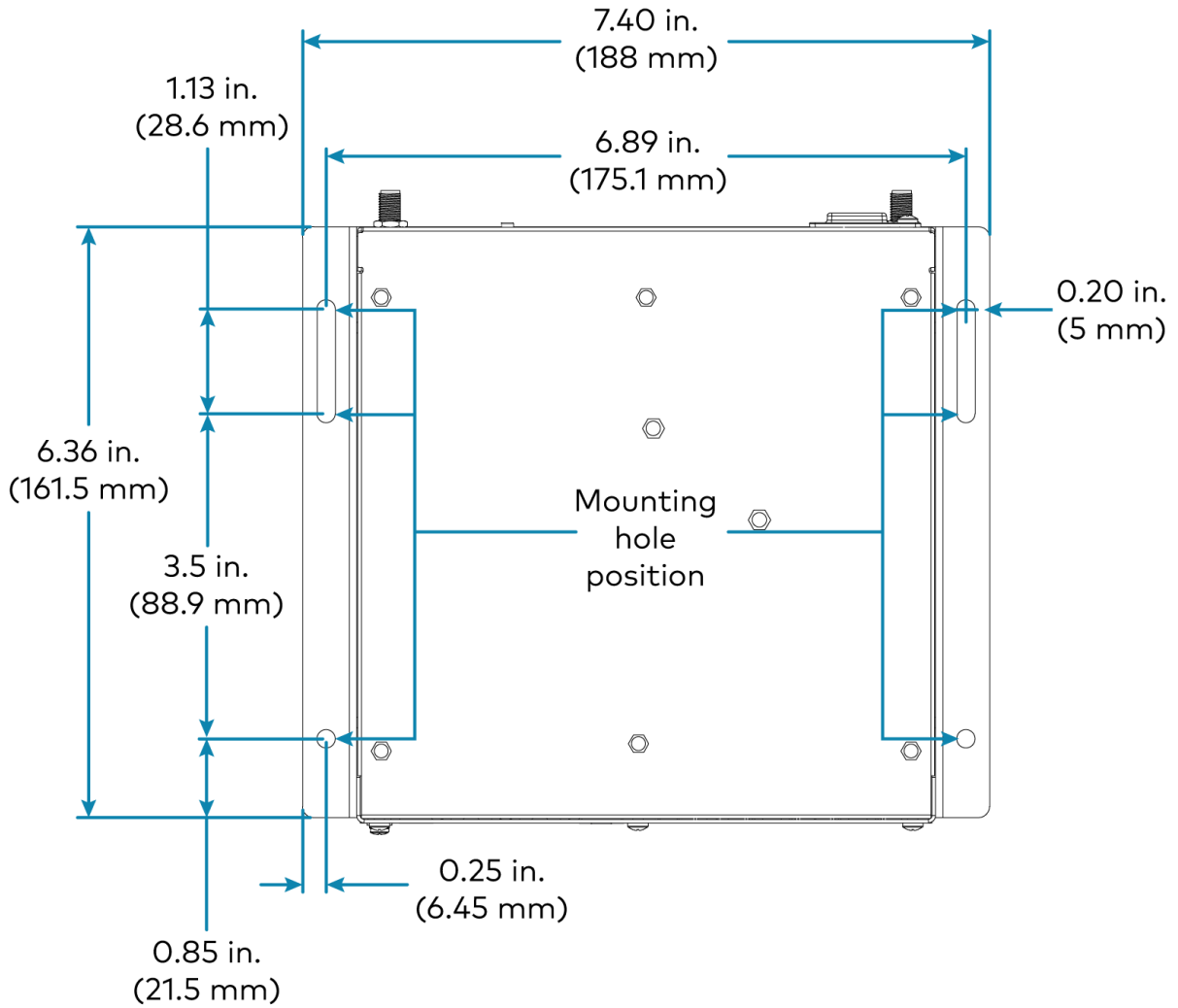

# Connect the Receiver

Make connections to the device as shown in the following diagrams.

## NOTES:

- Only use the LAN AUX port to connect to a secondary, guest-only LAN. Do not use the LAN AUX port to connect to the main LAN.
- The device receives power from a Power over Ethernet (PoE, IEEE 802.3af) or Power over Ethernet+ (PoE+, IEEE 802.3at) connection. It can also receive power from the [PW-2412WU](#) power pack (sold separately).
- PoE-type networks connected to the LAN PoE+ port are for intrabuilding use only. Do not connect this device to lines that run outside of the building.

## Top Panel Connections - AM-3200, AM-3200-WF, AM-3200-WF-I, and AM-3200-GV

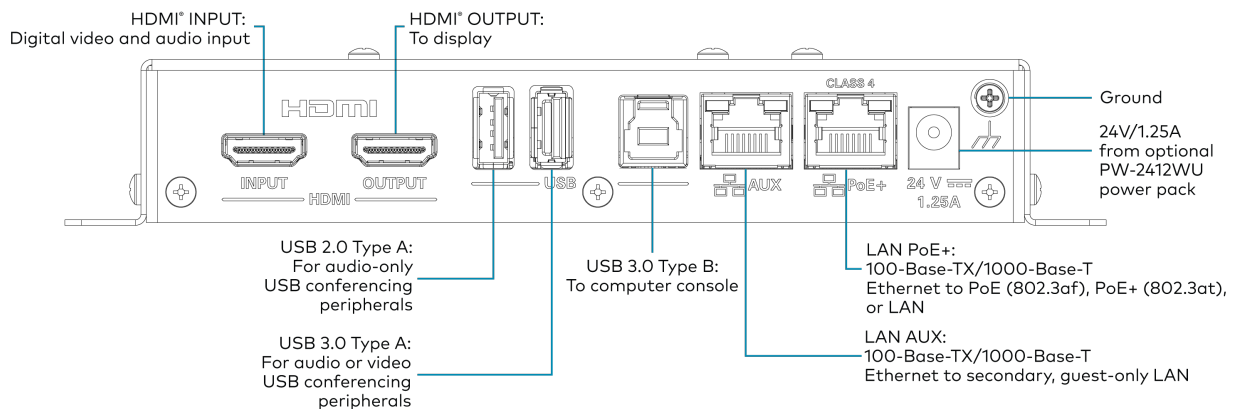

## Bottom Panel Connections - AM-3200 and AM-3200-GV

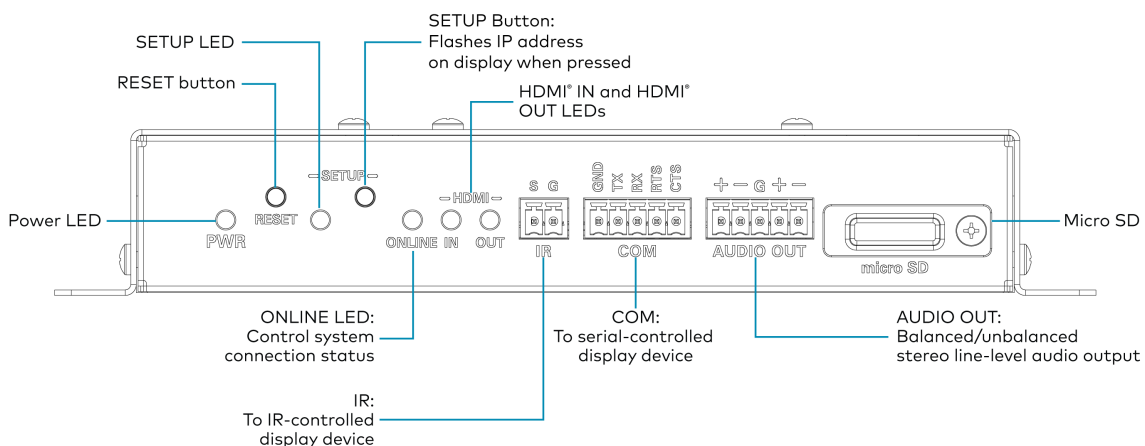

## Bottom Panel Connections - AM-3200-WF, AM-3200-WF-I

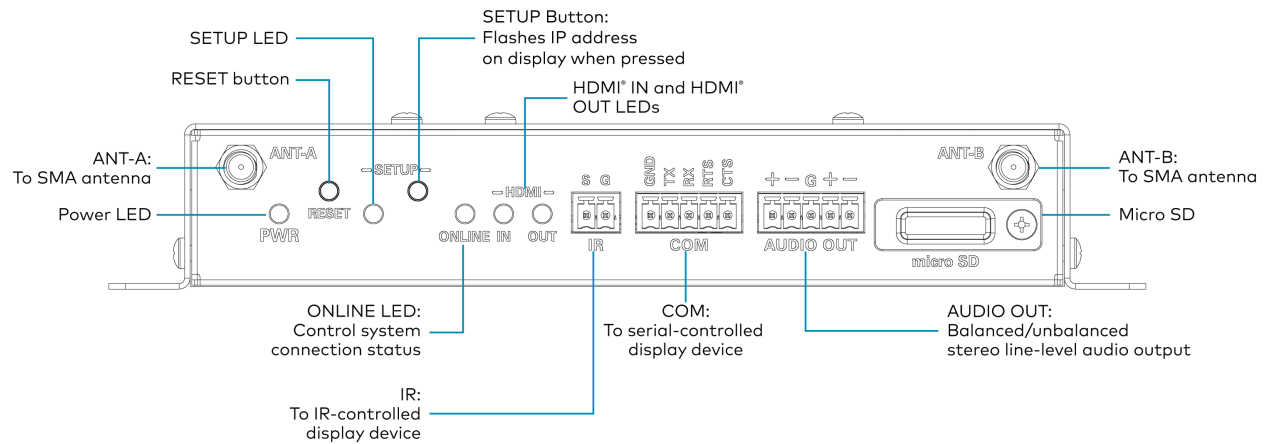

## Wireless Conferencing Peripherals

**NOTE:** Connected conferencing peripherals will not function. To use USB conferencing peripherals, the device must be powered by PoE+ or the PW-2412WU power pack. Do not simultaneously provide PoE or PoE+ and local power.

Connect Wireless Conferencing peripherals to the following USB ports:

- Cameras or all-in-one audio and video devices: USB 3.0
- Microphones, speakers, or DSPs: USB 2.0



## Observe the LEDs

Refer to the following table for information about the LED indicators on the device.

LED Indicator	Color	Meaning
Power	Green	Power is being applied to the device. The device is operational.
	Amber	Power is being applied to the device. The device is booting.
Setup	White	The setup button was pressed.
Online	Green	The device is connected to a Crestron Control System.
HDMI In	Green	A video signal is detected at the HDMI input.
HDMI Out	Green	A video signal is being transmitted to the HDMI output.
LAN PoE+ and LAN AUX	Green	An Ethernet link is established.
	Flashing amber	Data activity is occurring on the Ethernet link.

# AM-TX3-100(-I)

Refer to the sections below to install the AM-TX3-100(-I).

## In the Box

---

### Qty. Description

---

- |   |   |
|---|---|
| 1 | AirMedia Series 3 Connect Adaptor<br>AM-TX3-100 (6511527) or AM-TX3-100-I (6511528) |
|---|---|
- 

## Install the AM-TX3-100(-I)

Use the following procedures to install the AM-TX3-100(-I).

1. Plug the AM-TX3-100 into a personal device's USB-C port.

**NOTE:** The personal device's USB-C port must be DisplayPort Alt mode compatible.

2. Follow the instructions in [Connect Devices on page 141](#) and [Wireless Best Practices on page 195](#).
3. Set the paired AirMedia receiver's System Mode to **Multiple Presentation**. For details, refer to [General Settings on page 99](#).

## Observe the LEDs

Refer to the following table for information about the LED indicators on the device.

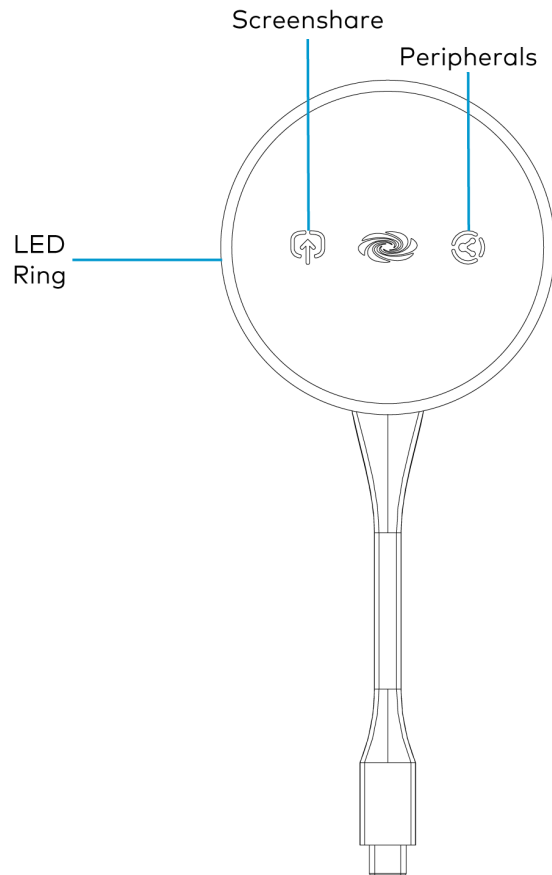

Status	LED Ring	Screenshare Button	Peripherals Button
Startup	White breathing	White breathing	White breathing
Connection	White circling		
Presentation Starting	Green circling		
Presentation Active	Green solid	Green solid	
Presentation Stopped	Green solid	White solid	
Presentation Paused	Green solid	Green blinking	
Presentation Active and Wireless Conferencing Available	Green solid	Green solid	White solid
Presentation and Wireless Conferencing Active	Green solid	Green solid	Green solid

Status	LED Ring	Screenshare Button	Peripherals Button
Presentation Active and Wireless Conferencing Unavailable	Green solid	Green solid	Red solid
Error	Red blinking	Red blinking	Red blinking
Firmware Update in Progress	Incremental amber segments		
Pairing in Progress	Alternating amber and white		
Ready for Pairing	White solid		

# UC-SB-P50-AM-WF(-I) KIT

Use the following procedure to install the UC-SB-P50-AM-WF(-I) KIT.

1. Install the Jabra PanaCast 50 video bar according to its included documentation.
2. Use the included USB-C to USB-A cable to connect the Jabra PanaCast 50 video bar to the AM-3200-WF(-I)'s USB 3.0 port.
3. Follow the installation instructions for the [AM-3200](#), [AM-3200-WF\(-I\)](#), and [AM-3200-GV](#) on page 67.

# Configuration

To configure receiver settings using the web configuration interface, deploy multiple receivers across an enterprise, or enable Modern Authentication for EWS, refer to the following sections:

**NOTE:** The AM-3200-GV reports as and follows the same device definitions as the AM-3200. AM-3200-GV units can be identified by the product label and a serial number that includes the letters **GST**.

- [Web Configuration Interface on page 77](#)
- [Enterprise Deployment Options on page 153](#)
- [Modern Authentication for EWS on page 154](#)

## Web Configuration Interface

Configure the AirMedia receiver using the included web configuration interface.

To connect to the receiver and configure its settings, refer to the following sections:

- [Connect to the Receiver on page 77](#)
- [Action Menu on page 80](#)
- [Status on page 87](#)
- [Settings on page 96](#)
- [Security on page 144](#)
- [802.1x Configuration on page 150](#)

## Connect to the Receiver

To connect to the receiver's web configuration interface, a computer must be connected to the same network as the AirMedia receiver. The web configuration interface is accessible from a web browser. This interface is also accessible using the XiO Cloud® service.

## Supported Web Browsers

When connecting to the receiver's web configuration interface, use one of the supported web browsers listed below.

### Web Configuration Interface Supported Web Browsers

OPERATING SYSTEM	SUPPORTED WEB BROWSERS
Windows® operating system	Chrome™ web browser, version 31 and later Firefox® web browser, version 31 and later Microsoft Edge® web browser, version 86 and later

OPERATING SYSTEM	SUPPORTED WEB BROWSERS
macOS® operating system	Chrome web browser, version 31 and later Firefox web browser, version 31 and later Safari® web browser, version 6 and later

## Sign in to the Receiver

To connect to the receiver using the web configuration interface:

1. On a computer, open a web browser and navigate to the IP address or host name that is shown on the display device. The welcome screen is displayed.

### Welcome Screen

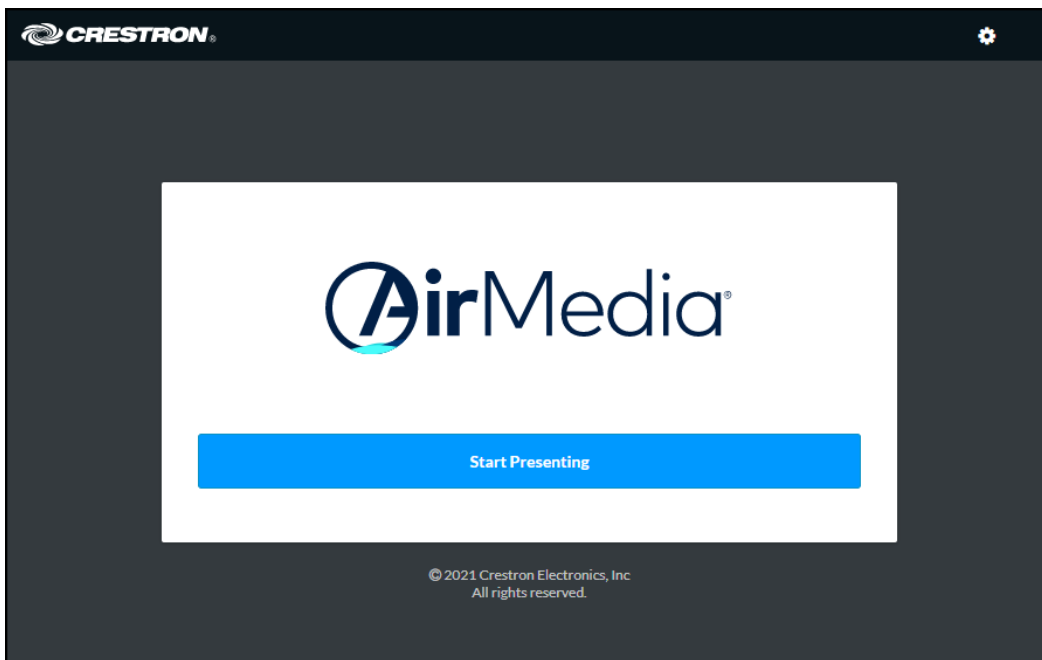

2. Select the settings button  in the title bar to log in.

**NOTE:** Prior to displaying the prompt for login credentials, the web browser may display a security warning message about the security certificate. It is safe to ignore this warning as long as the user verifies that the browser's address bar indicates the receiver IP address or host name as shown on the display device.

3. If this is a new sign-on, enter the new username and password in their respective fields and select **Create User** to continue. Otherwise, enter the username and password that were previously configured, and select **Sign In** to continue. The receiver's web configuration interface is displayed.

#### Login Screen

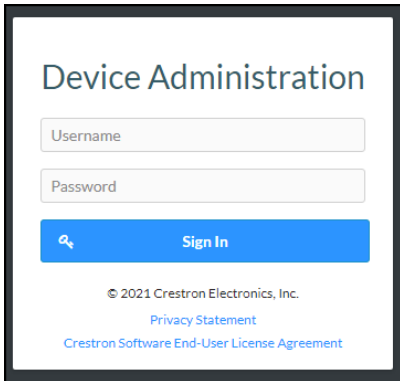

The screenshot shows the 'Device Administration' login screen. It features a white background with a dark border. At the top, the title 'Device Administration' is displayed in a dark blue font. Below the title are two input fields: 'Username' and 'Password'. A blue button with a white key icon and the text 'Sign In' is positioned below the password field. At the bottom, there is a copyright notice: '© 2021 Crestron Electronics, Inc.', followed by two links: 'Privacy Statement' and 'Crestron Software End-User License Agreement'.

#### Enter New User Name and Password

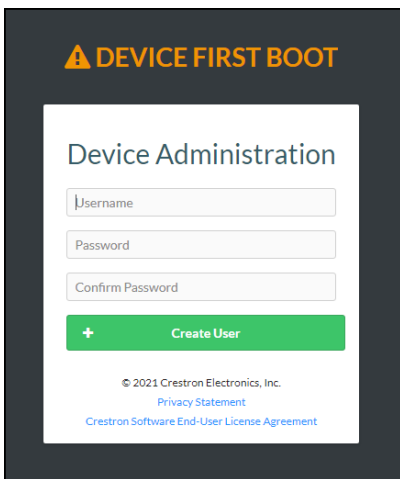

The screenshot shows the 'Device Administration' screen for creating a new user. It features a dark grey background with a white central panel. At the top of the panel, there is a warning icon (a triangle with an exclamation mark) and the text 'DEVICE FIRST BOOT' in orange. Below this, the title 'Device Administration' is displayed in a dark blue font. The panel contains three input fields: 'Username', 'Password', and 'Confirm Password'. A green button with a white plus icon and the text 'Create User' is positioned below the 'Confirm Password' field. At the bottom of the panel, there is a copyright notice: '© 2021 Crestron Electronics, Inc.', followed by two links: 'Privacy Statement' and 'Crestron Software End-User License Agreement'.

## Log Out from the Receiver

Select **Sign Out** to log out of the receiver's web configuration interface and return to the welcome screen. If **Sign Out** is not selected, the user will be logged out automatically after 20 minutes of inactivity.



## Action Menu

The web configuration interface provides an **Action** drop-down menu. The **Action** menu may be accessed at any time.

### Action Menu

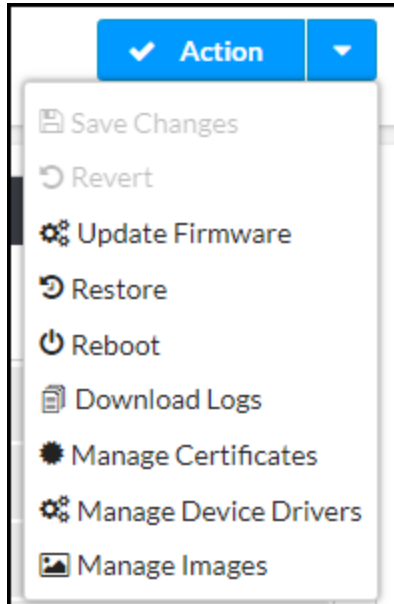

The **Action** menu provides the following selections.

### Save Changes

Once any changes have been made to the receiver configuration, the **Action** button becomes a **Save Changes** button. Select **Save Changes** to save changes to the configuration settings.

If a reboot is required after changes have been saved, select **Yes** to reboot the device or **No** to cancel the reboot.

### Revert

Select **Revert** to revert the receiver to the last saved configuration settings.

### Update Firmware

To upgrade the device firmware manually with a downloaded PUF (package update file), select **Update Firmware**. The **Firmware Upgrade** dialog box opens.

**NOTE:** Visit [crestron.com/firmware](http://crestron.com/firmware) to download the latest firmware PUF.

## Firmware Upgrade Dialog Box

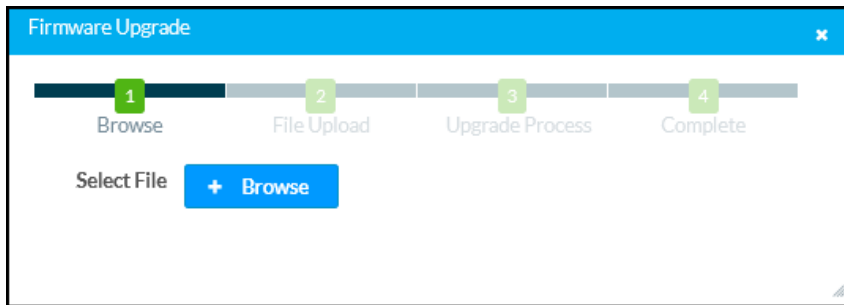

To upload a firmware PUF through the web configuration interface:

1. Select **Browse**, and then navigate to the firmware PUF on the host computer.
2. Select the firmware PUF, and then select **Open**.
3. Select **Load** to load the PUF to the receiver. The upload progress is shown in the dialog box.
4. Once the device has completed the firmware upgrade, select **OK**.

Select the **x** button to close the **Firmware Upgrade** dialog box. Selecting the **x** button before the PUF is uploaded to the device cancels the upgrade. Once the PUF upload process begins, the dialog box cannot be closed, and the upload process cannot be canceled.

## Restore

Select **Restore** to restore the device configuration settings to their default values. Select **Yes** to restore the settings or **No** to cancel the restore.

**NOTE:** If the device is restored to factory settings, the default user name and password used to configure the device will be restored as well. Any custom user names or passwords will no longer function.

## Reboot

Select **Reboot** to reboot the device. Select **Yes** to reboot the device or **No** to cancel the reboot.

## Download Logs

Select **Download Logs** to download the device message logs for diagnostic purposes. The message files download as a compressed .tgz file. Once the compressed file is downloaded, extract the message log files to view them.

## Manage EDIDs (AM-3200(-WF)(-I) Models Only)

Select **Manage EDIDs** to manage Extended Display Identification Data (EDID) profiles that are installed on the receiver. The **Manage EDIDs** window opens.

### Default EDIDs

Select **Default EDIDs** to view EDIDs preinstalled on the receiver.

#### Manage EDIDs - Default EDIDs Tab

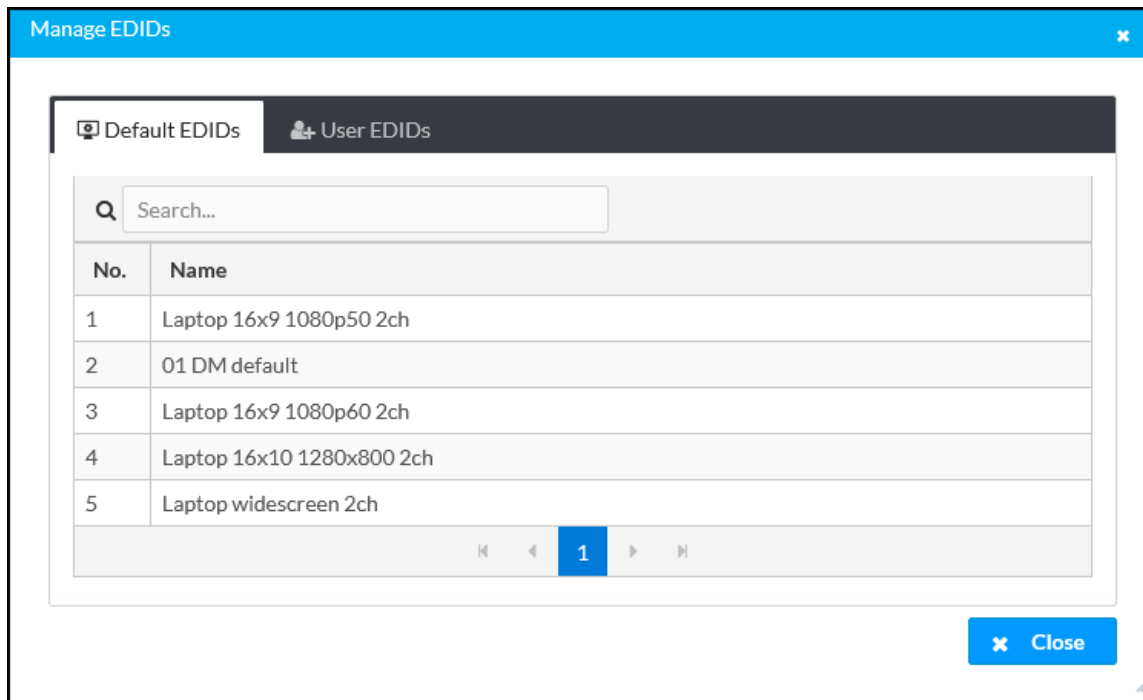

Enter text in the **Search...** field to find and display EDIDs that match the search term(s).

EDIDs are listed in table format. If the EDIDs span multiple pages, use the navigation arrows on the bottom of the page to move forward or backward through the pages, or select a page number to navigate to that page.

Select **Close** to close the **Manage EDIDs** window.

### User EDIDs

Select **User EDIDs** to manage EDIDs installed by users.

## Manage EDIDs - User EDIDs Tab

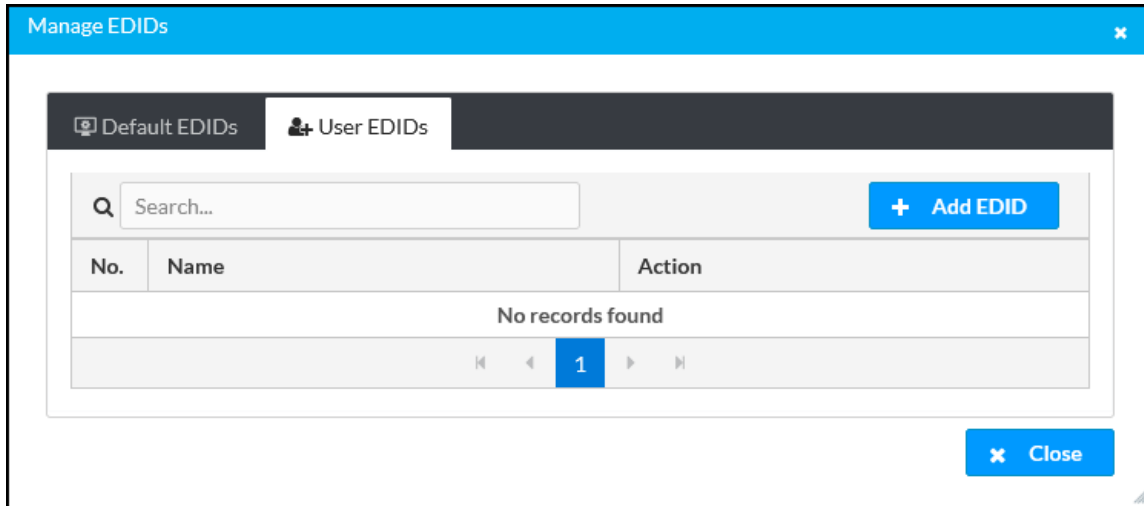

Enter text in the **Search...** field to find and display EDIDs that match the search term(s).

EDIDs are listed in table format. If the EDIDs span multiple pages, use the navigation arrows on the bottom of the page to move forward or backward through the pages, or select a page number to navigate to that page.

To upload an EDID file:

1. Select **Add EDID**.
2. Select **Browse**.
3. Navigate to the EDID file on the host computer.
4. Select the EDID file, and then select **Open**.
5. Select **Load** to load the EDID file to the receiver. The upload progress is shown in the dialog box.
6. Once the receiver has completed the upload, select **OK**.

Select the trashcan button  in the **Action** column to delete the EDID. Select **Yes** to delete the EDID or **No** to cancel.

Select **Close** to close the **Manage EDIDs** window.

## Manage Certificates

Select **Manage Certificates** to manage any certificates that are installed on the receiver. For more information on certificate management, refer to [802.1x Configuration on page 150](#).

## Manage Device Drivers

Select **Manage Device Drivers** to manage any drivers that are installed on the receiver. The **Manage Device Drivers** window appears. Support for CEC, Crestron Connected® control, IP, serial, and infrared profiles are built-in.

### Default Drivers

Select **Default Drivers** to view information for the drivers preinstalled on the receiver.

#### Manage Device Drivers - Default Drivers Tab

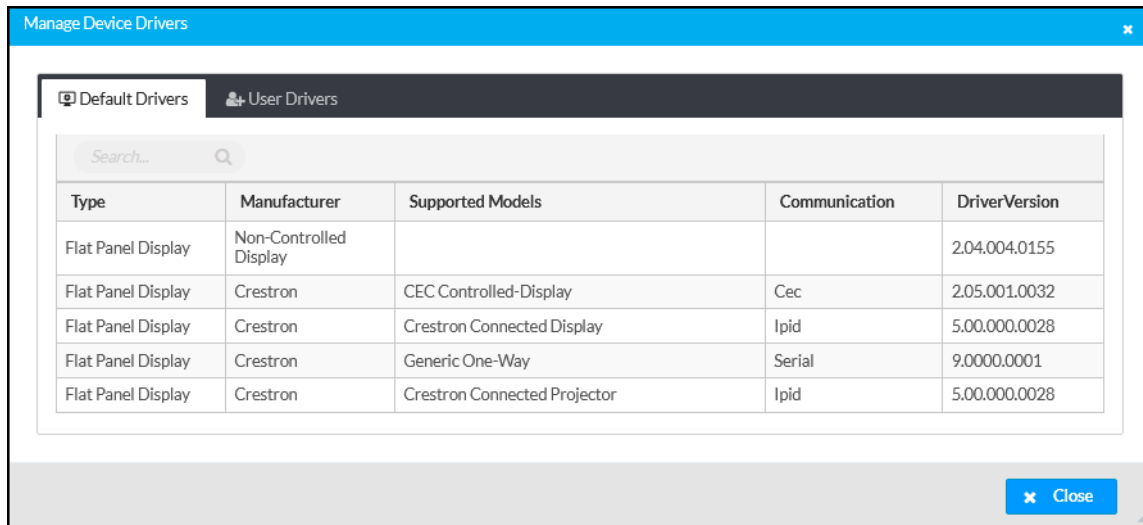

Type	Manufacturer	Supported Models	Communication	DriverVersion
Flat Panel Display	Non-Controlled Display			2.04.004.0155
Flat Panel Display	Crestron	CEC Controlled-Display	Cec	2.05.001.0032
Flat Panel Display	Crestron	Crestron Connected Display	Ipid	5.00.000.0028
Flat Panel Display	Crestron	Generic One-Way	Serial	9.0000.0001
Flat Panel Display	Crestron	Crestron Connected Projector	Ipid	5.00.000.0028

Enter text in the **Search...** field to find and display drivers that match the search term(s).

Drivers are listed in table format. The following information is displayed for each driver:

- **Type:** The supported display type (flat panel display, projector, etc.)
- **Manufacturer:** The driver manufacturer
- **Supported Models:** The display model name
- **Communication:** The driver communication type (Serial/RS-232, IR, IP, CEC)
- **DriverVersion:** The version of the installed driver

Select **Close** to close the **Manage Device Drivers** window.

### User Drivers

Select **User Drivers** to manage drivers installed by users.

## Manage Device Drivers - User Drivers Tab

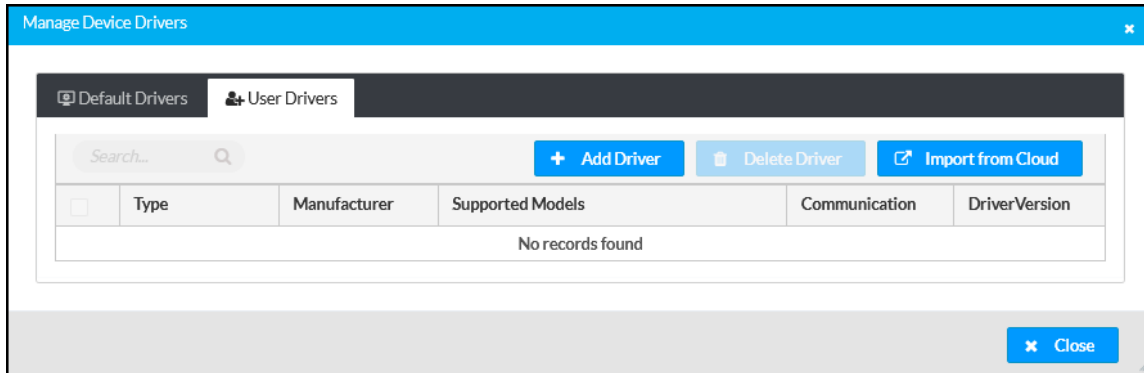

Drivers are listed in table format. The following information is displayed for each driver:

- **Type:** The supported display type (flat panel display, projector, etc.)
- **Manufacturer:** The driver manufacturer
- **Supported Models:** The display model name
- **Communication:** The driver communication type (Serial/RS-232, IR, IP, CEC)
- **DriverVersion:** The version of the installed driver

Select **Close** to close the **Manage Device Drivers** window.

### Add Driver

To upload a driver:

1. Select **Add Driver**.
2. Select **Browse**.
3. Navigate to the driver file on the host computer.
4. Select the driver file, and then select **Open**.
5. Select **Load** to load the driver file to the receiver. The upload progress is shown in the dialog box.
6. Once the receiver has completed the upload, select **OK**.

### Delete Driver

To delete a driver from the receiver:

1. Locate the driver that you wish to delete in the driver table, and then select the corresponding checkbox.
2. Select **Delete Driver**.
3. Select **Yes** to delete the driver.

### Import from Cloud

Crestron maintains a cloud-based driver database. To load drivers to the receiver from the cloud:

1. Select **Import from Cloud**.
2. Enter text in the **Search...** field to find and display drivers that match the search term(s).

3. Locate the driver that you wish to upload to the receiver, and then select the corresponding radio button .
4. Select **Add** to add the driver to the receiver.

## Manage Images

Select **Manage Images** to add or remove images used as custom logo graphics or custom backgrounds.

**NOTE:** For more details on using custom logo graphics and custom backgrounds, refer to [Connected Devices on page 122](#).

### Manage Images

Manage Images

Images Loaded 0 of 20  
Storage Capacity 0 of 100 MB

+ Add    ✕ Remove

<input type="checkbox"/>	Index	File Name	Status	Preview
	1	<Empty>		
	2	<Empty>		
	3	<Empty>		
	4	<Empty>		
	5	<Empty>		

✕ Close

To add an image to the receiver:

#### NOTES:

- Up to 20 images can be loaded. The receiver's storage capacity is 100 MB.
- Custom background images should be jpg files with resolutions no higher than 4096 x 2304 pixels. Images with resolutions higher than 4096 x 2304 pixels may exceed the receiver's storage limit when rendered and will inhibit performance.

1. Select **Add**.
2. Select **Browse**, and then navigate to the image file on the host computer.
3. Select the image file, and then select **Open**.
4. Select **Load** to load the image to the receiver.
5. Once the receiver has completed the image upload, select **OK**.

Select the **x** button to close the **File Upload** dialog box at any time during the upgrade process. Selecting the **x** button before the image file is uploaded to the receiver cancels the upload.

Once the image file is uploaded, the file's name, status, and preview will appear in the **Manage Images** table.

To remove an image from the receiver, select the checkbox in the corresponding table row, and then select **Remove**.

## Status

Select **Status** to display selections for viewing the status of receiver, network, and control system settings. Select a section name to expand the menu. If the menu is expanded, select the section name again to collapse the section.

### Status Screen

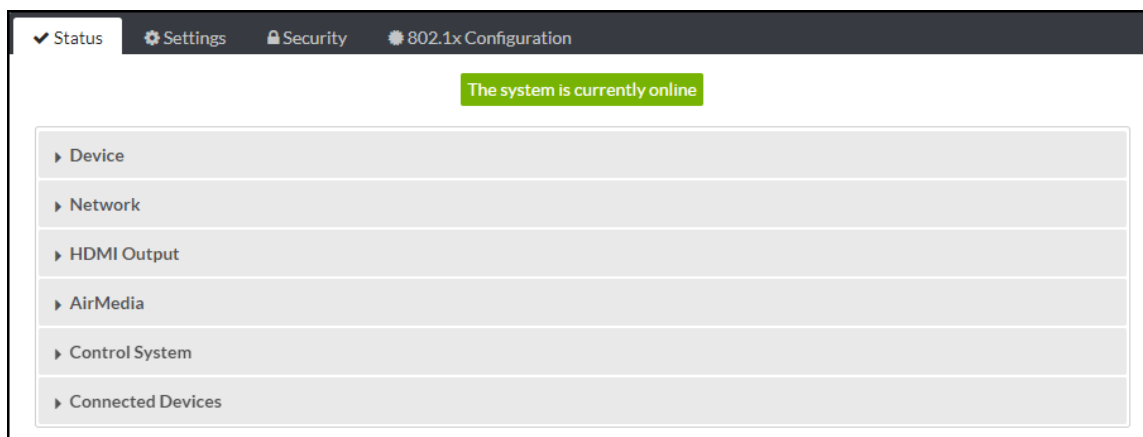



## Device

Select **Device** to view general receiver information.

### Status – Device

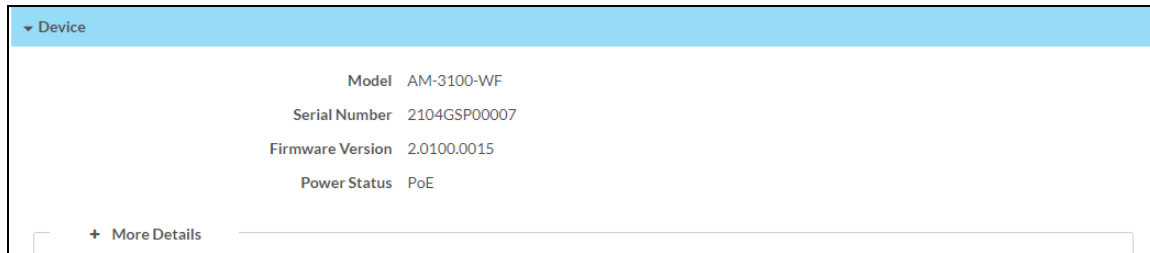

The following **Device** information is displayed:

- **Model:** The receiver model name.
- **Serial Number:** The receiver serial number.
- **Firmware Version:** The firmware version loaded onto the receiver.
- **Power Status:** Displays how the device is currently being powered (DC, PoE, or PoE+).

Select **+ More Details** at the bottom of the tab to display an expanded section that shows additional information. Select **- More Details** to collapse the section.

## Network

Select **Network** to view the status of the network settings for the receiver.

### Status – Network

The screenshot displays the Network status page with a light blue header. The main content area is white and contains the following information:

- Network** (header)
- Hostname: AM-3200-WF-000000000000
- Domain: hsd1.nj.comcast.net
- DNS Servers: 75.75.75.75(DHCP),75.75.76.76(DHCP)
- Adapter 1** (expanded):
  - DHCP: Yes
  - IP Address: 10.0.0.238
  - Subnet Mask: 255.255.255.0
  - Default Gateway: 10.0.0.1
  - Link Active: True
  - MAC Address: 00.10.7f.ed.7a.6c
- Adapter 2** (collapsed)
- Wireless Access Point** (expanded):
  - DHCP Enabled: Yes
  - SSID: (blank)
  - IP Address: 0.0.0.0
  - Subnet Mask: 0.0.0.0
  - Default Gateway: 0.0.0.0
  - Link Active: False
  - MAC Address: 00.10.7f.ed.7a.6e

The following **Network** information is displayed:

- **Host Name:** The receiver hostname
- **Domain:** The receiver domain name
- **DNS Servers:** The DNS (domain name server) addresses used to resolve the receiver domain to an IP address

Select the + (plus) icon next to **Adapter 1** and/or **Adapter 2** to view the following DHCP server settings:

- **DHCP:** Reports whether the IP address is dynamic (Yes) or static (No)
- **IP Address:** The receiver IP address
- **Subnet Mask:** The receiver subnet mask
- **Default Gateway:** The gateway router address
- **Link Active:** Reports the status of the Ethernet connection. A true message indicates that the Ethernet connection is active, while a false message indicates that the Ethernet connection is inactive.
- **MAC Address:** The unique device MAC (media access control) address

Select the + (plus) icon next to **Wireless Access Point** to view the following wireless access point settings:

**NOTE:** Values are shown for the following settings only if a wireless access point is used.

- **DHCP Enabled:** Reports whether the IP address is dynamic (Yes) or static (No)
- **SSID:** The wireless access point network name
- **IP Address:** The wireless access point IP address
- **Subnet Mask:** The wireless access point subnet mask
- **Default Gateway:** The gateway router address
- **Link Active:** Reports the status of the Ethernet connection. A true message indicates that the Ethernet connection is active, while a false message indicates that the Ethernet connection is inactive.

## HDMI Input (AM-3200(-WF)(-I) Models Only)

Select **HDMI Input** to view the status of a device connected to the HDMI input.

### Status – HDMI Input

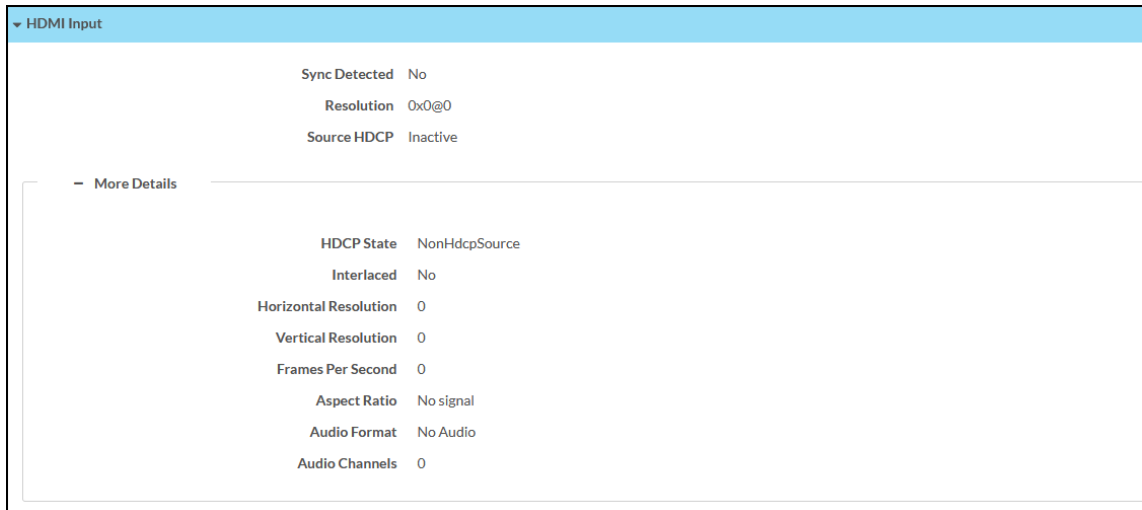

The screenshot shows a web interface for the HDMI Input status. It features a blue header with a dropdown arrow and the text 'HDMI Input'. Below the header, there are three rows of status information: 'Sync Detected' with the value 'No', 'Resolution' with the value '0x0@0', and 'Source HDCP' with the value 'Inactive'. A section titled '- More Details' is expanded, showing a list of parameters: 'HDCP State' (NonHdcpSource), 'Interlaced' (No), 'Horizontal Resolution' (0), 'Vertical Resolution' (0), 'Frames Per Second' (0), 'Aspect Ratio' (No signal), 'Audio Format' (No Audio), and 'Audio Channels' (0).

Sync Detected	No
Resolution	0x0@0
Source HDCP	Inactive
- More Details	
HDCP State	NonHdcpSource
Interlaced	No
Horizontal Resolution	0
Vertical Resolution	0
Frames Per Second	0
Aspect Ratio	No signal
Audio Format	No Audio
Audio Channels	0

The following HDMI Input information is displayed:

- **Sync Detected:** Indicates whether a sync is present between the source connected to the HDMI input and the receiver
- **Resolution:** The resolution of the source connected to the HDMI input
- **Source HDCP:** Indicates whether HDCP is active or inactive

Select **+ More Details** at the bottom of the tab to display an expanded section that shows additional information. Select **- More Details** to collapse the section.

## HDMI Output

Select **HDMI Output** to view the status of a display device connected to the HDMI output.

### Status – HDMI Output

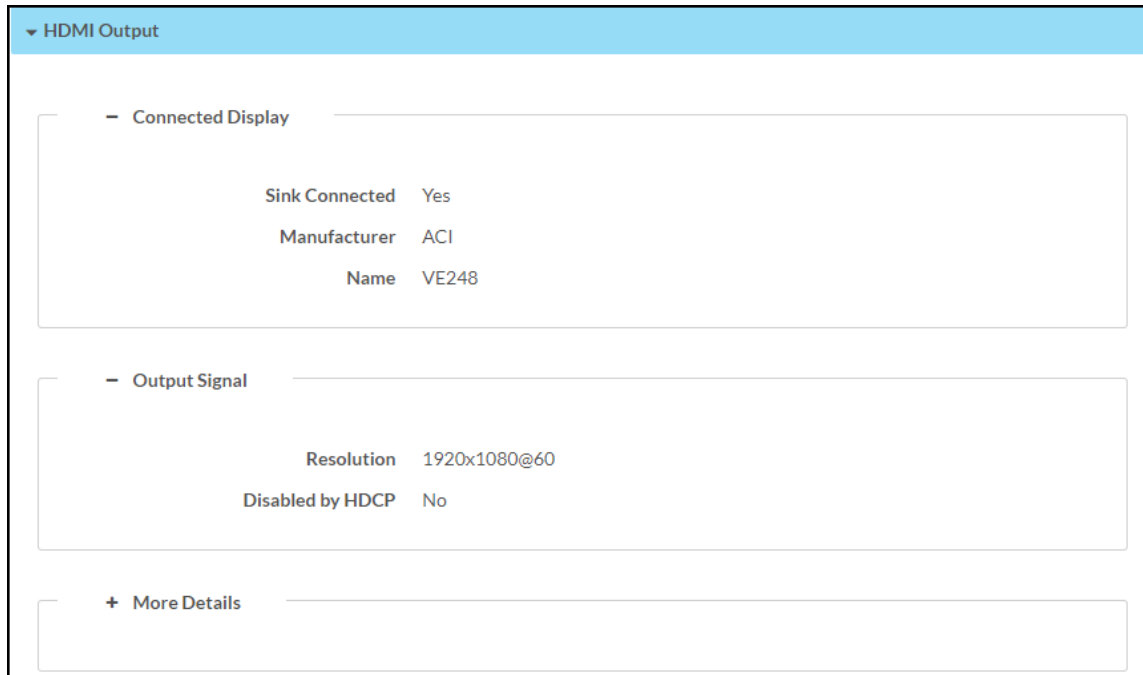

Select the + (plus) icon next to **Connected Display** to view the following display settings:

- **Sink Connected:** Reports whether or not a display is connected
- **Manufacturer:** The manufacturer name of the display device
- **Name:** The name of the display device

Select the + (plus) icon next to **Output Signal** to view the following output signal settings:

- **Resolution:** The resolution and frame rate of the display device
- **Disabled by HDCP:** Reports whether or not the display signal is disabled by HDCP

Select + **More Details** at the bottom of the tab to display an expanded section that shows additional information. Select - **More Details** to collapse the section.

## AirMedia

Select **AirMedia** to view the status of the AirMedia connection.

### Status – AirMedia Connection

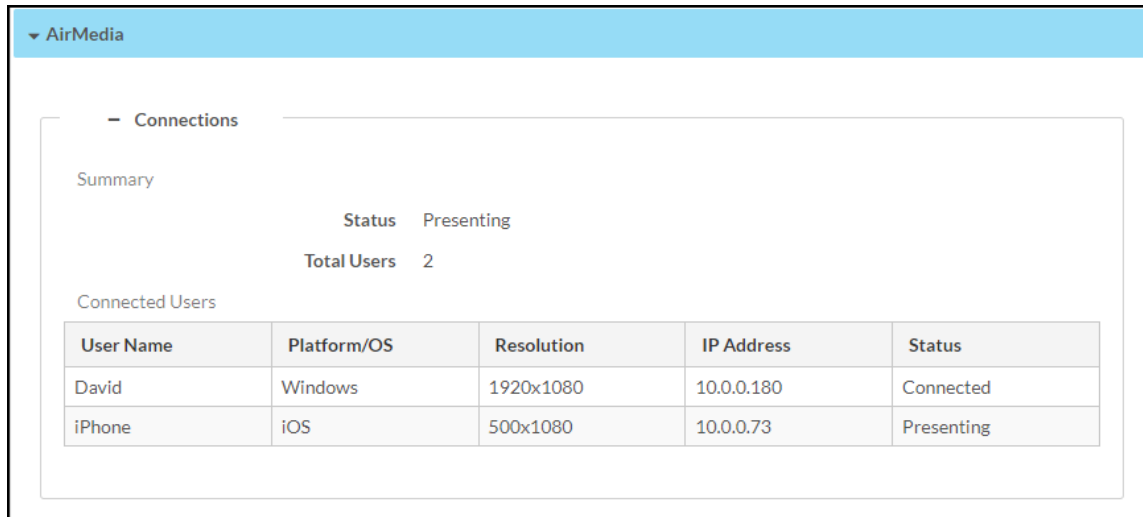

Summary

Status Presenting

Total Users 2

Connected Users

User Name	Platform/OS	Resolution	IP Address	Status
David	Windows	1920x1080	10.0.0.180	Connected
iPhone	iOS	500x1080	10.0.0.73	Presenting

Select the + (plus) icon next to **Connections** to view the connection settings for devices using AirMedia:

- **Summary:** Reports the status of the device and the total amount of users connected to the receiver
  - **Status:** Reports **Idle** when no users are connected, **Active** when a user is connected but not presenting, and **Presenting** when a user is presenting
  - **Total Users:** The total amount of users with an active connection to the receiver. The receiver supports a maximum of ten simultaneous connections and up to two simultaneous presenters.
- **Connected Users:** Reports the details of all users with an active connection to the device
  - **User Name:** The user name of a connected user
  - **Platform/OS:** The operating system of a connected device
  - **Resolution:** The resolution of a connected device
  - **IP Address:** The IP address of a connected device
  - **Status:** Reports **Idle** when no users are connected, **Active** when the user is connected but not presenting, and **Presenting** when the user is presenting

## Control System

Select **Control System** to view the status of the receiver's control system connection.

### Status – Control System

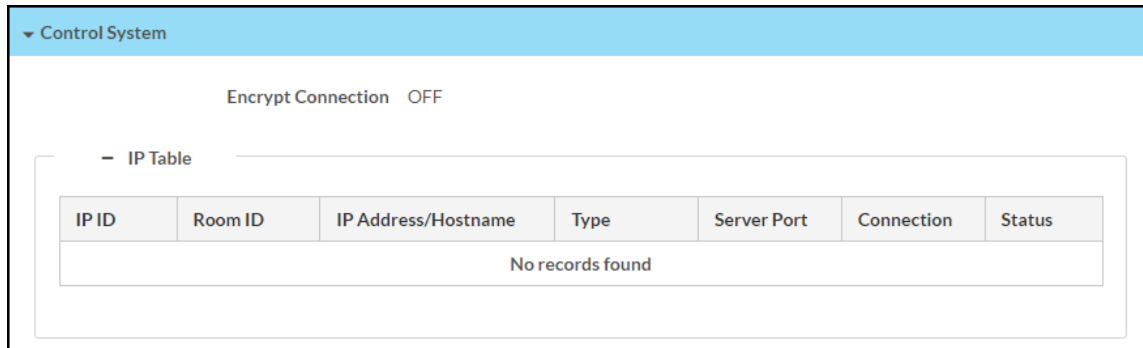

The following **Control System** information is displayed:

- **Encrypt Connection:** Indicates whether the connection between the control system and the receiver is encrypted
- **IP Table:** Displays the IP table information for the control system connection:
  - **IP ID:** The IP ID used to connect the receiver to a control system
  - **Room ID:** The control system room ID that the receiver is associated with (for connections to the Crestron Virtual Control server-based control system)
  - **IP Address/Hostname:** The control system IP address or hostname
  - **Type:** The control system type
  - **Server Port:** The control system server port
  - **Connection:** The control system connection type
  - **Status:** The control system connection status

## Connected Devices

Select **Connected Devices** to view the status of any connected devices such as a display, occupancy sensor, or touch panel.

Select the + (plus) icon next to **Connected Display** to view the following display settings:

### Status – Connected Devices (Connected Display)



- **Detected Manufacturer:** The manufacturer of the connected display
- **Detected Name:** The name given to the connected display

Select the + (plus) icon next to **Network Occupancy Sensor** to view the following occupancy sensor settings:

### Status – Connected Devices (Network Occupancy Sensor)



- **Connection Status:** The occupancy sensor connection status
- **Occupancy Status:** The occupancy status (either **Occupied** or **Vacant**) of the space monitored by an occupancy sensor

Select the + (plus) icon next to **Touch Panel** to view the following touch panel settings:

### Status – Connected Devices (Touch Panel)

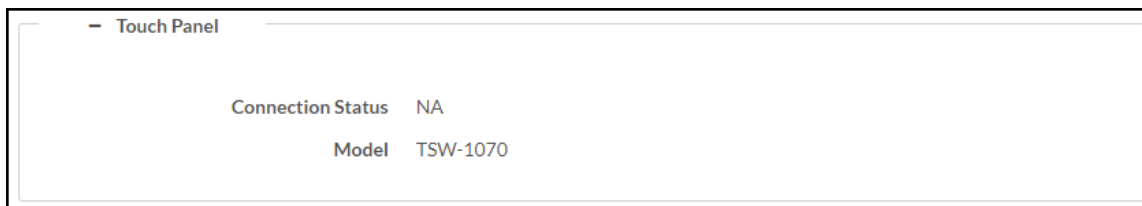

- **Connection Status:** The touch panel connection status
- **Model:** The model name of the touch panel



Select the + (plus) icon next to **Conferencing Peripherals** to view the following settings:

### Status – Conferencing Peripherals

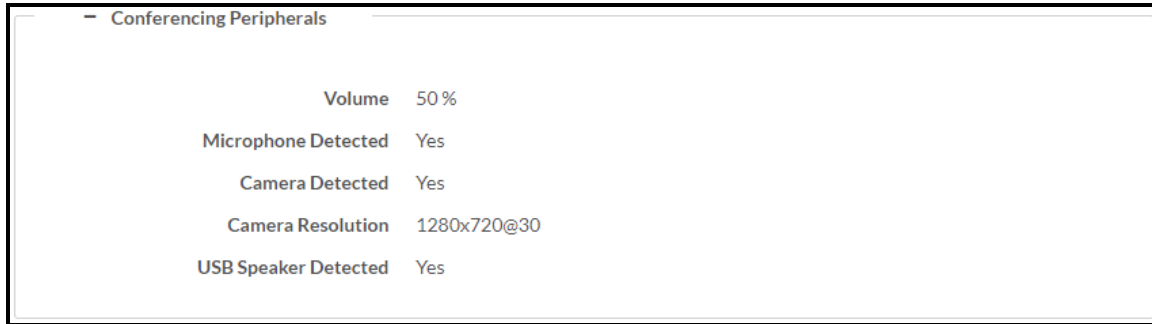

- **Volume:** The maximum allowed volume of connected USB speakers.
- **Microphone Detected:** Indicates whether or not a microphone is connected
- **Camera Detected:** Indicates whether or not a camera is connected
- **Camera Resolution:** The resolution of a connected camera
- **USB Speaker Detected:** Indicates whether or not a USB speaker is connected

## Settings

Select **Settings** to configure various device settings. Once any changes have been made to the receiver configuration, the **Action** button becomes a **Save Changes** button. Select **Save Changes** to save changes to the configuration settings. If a reboot is required after changes have been saved, select **Yes** to reboot the device or **No** to cancel the reboot.

Select a section name to expand the menu. If the menu is expanded, select the section name again to collapse the section.

### Settings Screen

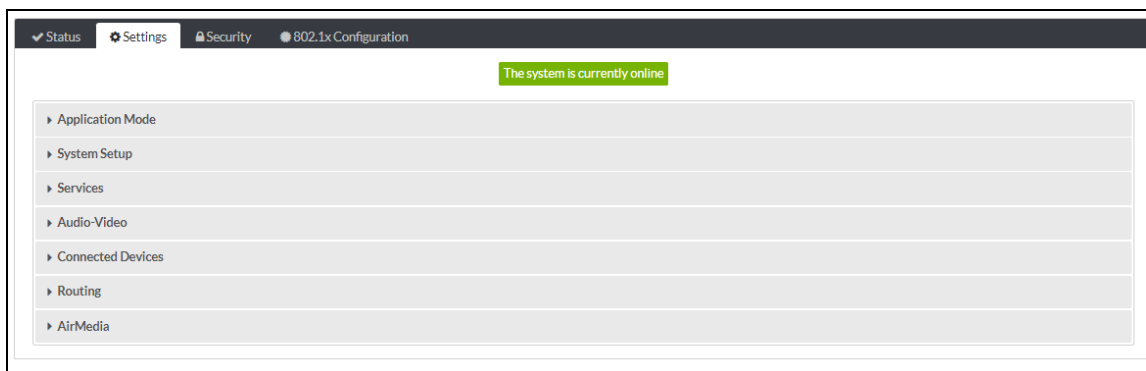

## Application Mode

Select **Application Mode** to configure digital signage functionality. The AirMedia receiver can display content from Appspace or a URL.

## Settings Screen – Application Mode

Application Mode

Application Mode: AirMedia Experience ⓘ

Signage Provider: None

### NOTES:

- For best practices when configuring the AirMedia receiver for use with Appspace, visit [docs.appspace.com](https://docs.appspace.com).
- For optimal performance, do not exceed the following resolutions:
  - Cards and images: 3840x2160
  - Videos and Streaming IPTV sources: 1920x1080
- **Application Mode:** Use the drop-down list to select a mode. These modes are detailed in the sections below.
  - **AirMedia Experience**
  - **Signage Only**

**NOTE:** The drop-down list also contains **AirMedia Experience (Legacy)**, but it is not selectable. This mode is no longer supported and can no longer be configured as an application mode.

## AirMedia Experience

This is the standard AirMedia experience.

### AirMedia Experience Screen

Application Mode

Application Mode: AirMedia Experience ⓘ

Signage Provider: Appspace

Content Caching:

Signage Mode:  Signage as a Background  
 Signage in Standby  
 Both Background and Standby

- **Signage Provider:** Select one of the following digital signage options.
  - **Appspace:** Use Appspace.
  - **General Web:** Use a specified URL.
  - **None:** Do not use digital signage.
- **Content Caching (Appspace only):** Only available if a MicroSD card is inserted. Turn on the toggle to allow Appspace to use the MicroSD for content caching. Note the following MicroSD requirements.
  - **Format:** ExFAT (formatted prior to insertion in AirMedia receiver)
  - **Minimum size:** 8GB
  - **Maximum size:** 128GB
  - **Partitions:** The card must have a partition of at least 4GB. The AirMedia receiver will utilize the largest available partition.
  - **Hot Plugging:** Hot plugging the MicroSD card is not supported. Reboot the receiver when a card is inserted or removed.
- **Signage Mode:** Select one of the following options.
  - **Signage as a Background:** Display signage content on the Front of Room display when there is no active presentation. The connection instruction tiles will be shown if enabled, but other front of room elements are not shown to avoid overlap with signage content. Background and logo images are not displayed.
  - **Signage in Standby:** Display signage content in full screen when the room is not occupied. The standard Welcome Screen is displayed when the room is occupied and there is no active presentation.
  - **Both Background and Standby:** Enables both options above.
- **Signage URL (General Web only):** Enter the location of the hosted digital signage content.

## Signage Only

In this mode, the device will function as a digital signage player. AirMedia functionality is disabled. In this mode, **Power Setting** is forced to **Signage Only**.

### Signage Only Screen



- **Signage Provider:** Select one of the following digital signage options.
  - **Appspace:** Use Appspace.
  - **General Web:** Use a specified URL.

- **Content Caching (Appspace only):** Only available if a MicroSD card is inserted. Turn on the toggle to allow Appspace to use the MicroSD for content caching. Note the following MicroSD requirements.
  - Format: ExFAT
  - Minimum size: 8GB
  - Maximum size: 128GB
  - Partitions: The card must have a partition of at least 4GB. The AirMedia receiver will utilize the largest available partition.
  - Hot Plugging: Hot plugging the MicroSD card is not supported. Reboot the receiver when a card is inserted or removed.

## System Setup

Select **System Setup** to modify general, network, power, cloud, update, date/time, and control system settings.

### General Settings

Select **General Settings** to configure general device settings.

#### System Setup – General Settings

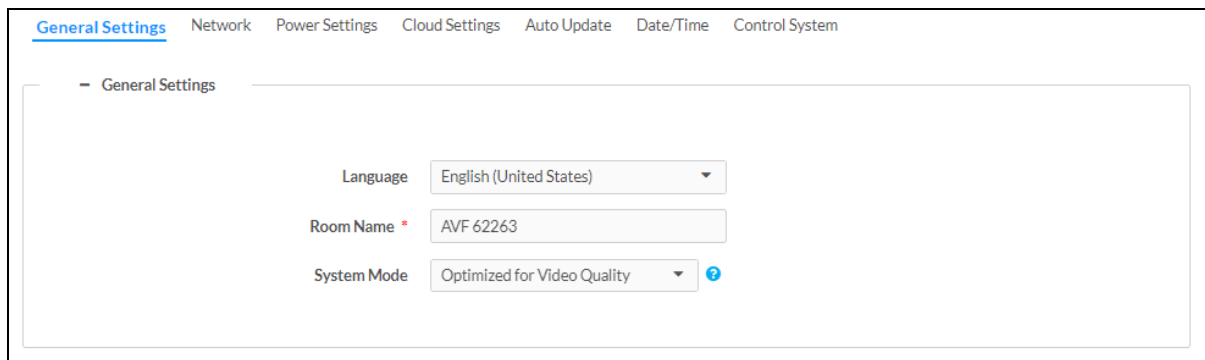

The screenshot shows the 'General Settings' page in a web interface. At the top, there is a navigation bar with the following tabs: 'General Settings' (which is highlighted with a blue underline), 'Network', 'Power Settings', 'Cloud Settings', 'Auto Update', 'Date/Time', and 'Control System'. Below the navigation bar, the page title is '- General Settings'. The main content area contains three settings:

- Language:** A dropdown menu currently set to 'English (United States)'.
- Room Name:** A text input field containing 'AVF 62263'. There is a small red asterisk to the left of the field.
- System Mode:** A dropdown menu currently set to 'Optimized for Video Quality'. There is a blue question mark icon to the right of the dropdown.

- **Language:** Select the language that will be displayed on the receiver from the drop-down list
- **Room Name:** Enter the room name for the space that the receiver is installed in

- **System Mode:** Select a system mode from the options below to automatically configure some AirMedia settings. For details, refer to [General Settings on page 131](#).

**NOTE:** Other than **Routing Mode**, these options are forced by the **System Mode** and cannot be adjusted without using **System Mode: Custom**.

- **Optimized for Video Quality:** This mode offers the best quality video, including support for 4K30 presentations when using Connect Adaptors. The following options are set:
  - **AirMedia:** Enabled
  - **AirMedia Canvas:** Enabled
  - **Canvas Session Control:** Enabled
  - **Max Presentation Limit:** 1
  - **Routing Mode** (AM-3000-WF(-I) and AM-3100-WF(I) only): AirMedia Auto-Route only
  - **Routing Mode** (AM-3200-WF(-I) only): Automatic Input Routing
- **Optimized for Multiple Presentations:** This mode enables multiple users to present simultaneously. The following options are set:
  - **AirMedia:** Enabled
  - **AirMedia Canvas:** Enabled
  - **Canvas Session Control:** Enabled
  - **Routing Mode** (AM-3000-WF(-I) and AM-3100-WF(I) only): AirMedia Auto-Route only
  - **Routing Mode** (AM-3200-WF(-I) only): Automatic Input Routing
- **Custom:** This mode allows full configuration of all settings.

## Network

Select **Network** to configure the receiver's network settings.

## System Setup – Network

The screenshot displays the 'Network' configuration page within the 'System Setup' interface. The page is organized into several sections:

- General Settings:** Hostname (AM-3200-7D60-B-5050), Domain (hsd1.nj.comcast.net), SSH (enabled), Primary Static DNS, and Secondary Static DNS.
- Network Adapter 1 - Main:** DHCP (enabled), IP Address (10.0.0.238), Subnet Mask (255.255.255.0), and Default Gateway (10.0.0.1).
- Network Adapter 2 - AUX:** DHCP (enabled), IP Address (192.168.0.101), Subnet Mask (255.255.255.0), and Default Gateway (192.168.0.1).
- Wireless Access Point:** Wireless Access Point Mode (disabled), Name/SSID (AM-3100-WF-ed7a6c), Security Key, and Security (WPA2).
- Auto Launch AirMedia Landing Page:** Disabled.
- WIFI Mode:** 5GHz Only.
- 2.4GHz Channel:** 0.
- 5GHz Channel:** 0 (Auto).
- 2.4GHz Signal Strength:** 100%.
- 5GHz Signal Strength:** 100%.
- Network Proxy Settings:** Proxy (disabled).
- HTTP Settings:** HTTP Proxy (disabled), HTTP Proxy Address, HTTP Proxy Port (0), Username, and Password.
- HTTPS Settings:** HTTPS Proxy (disabled), HTTPS Proxy Address, HTTPS Proxy Port (0), Username, and Password.

- **Host Name:** Enter the receiver host name (22 characters or less).
- **Domain:** Enter the fully qualified domain name on the network (optional). This field is prefilled when the **DHCP** toggle is turned on.

**NOTE:** A host name and domain name can act as an alternative to IP addressing for connecting client computers to the device.

- **SSH:** Turn on the toggle to enable Secure Shell protocol (SSH).
- **Primary Static DNS:** Enter the primary DNS address.
- **Secondary Static DNS:** Enter the secondary DNS address.
- **Network Adapter 1 - Main** and **Network Adapter 2 - AUX**

**NOTE:** **Network Adapter 2 - AUX** settings are unavailable on AM-3100-WF(-I) models.

- **DHCP:** Turn on the toggle to use DHCP for the Ethernet connection. When enabled, the IP address, subnet mask, and default gateway settings are automatically filled. If the toggle is off, these settings must be entered manually.
- **IP Address:** Enter the receiver IP address on the network. This field is prefilled when the DHCP toggle is on.
- **Subnet Mask:** Enter the device subnet mask address on the network. This field is prefilled when the DHCP toggle is on.
- **Default Gateway:** Enter the gateway router address on the network. This field is prefilled when the DHCP toggle is on.

- **Wireless Access Point:** The device can be used as a Wireless Access Point (WAP) so that users can present wirelessly without using a corporate Wi-Fi network.

**NOTE:** Wireless Access Point functionality is not available on the AM-3200. It is only available on Wi-Fi network capable AirMedia receivers.

- **Wireless Access Point Mode:** Turn on the toggle to enable the receiver to operate as a Wireless Access Point
- **Name/SSID:** Enter a name for the wireless network.
- **Security Key:** Enter a security key to connect to the wireless network.

**NOTE:** The wireless network name and security should each be 22 characters or fewer for optimal presentation on a display device and/or a connected touch screen.

- **Security:** Select an encryption key type to be used by the wireless network.

**NOTE:** When WPA2 is selected, WPA2-PSK is used by default for security key encryption.

- **Auto Launch AirMedia Landing Page:** Turn on the toggle to automatically launch a web browser and redirect the user to the AirMedia landing page upon connection to the wireless access point.
- **WiFi Mode:** Select **2.4GHz Only** or **5GHz Only** from the drop-down list to use either a 2.4GHz or 5GHz frequency band.
- **2.4GHz Channel:** Select the channel number. If **5GHz Only** is selected in the **WiFi Mode** field, then this field will not be editable.
- **5GHz Channel:** Select the channel number. If **2.4GHz Only** is selected in the **WiFi Mode** field, then this field will not be editable.

**NOTE:** Set either channel to **0 (Auto)** to enable automatic channel selection.

- **2.4GHz Signal Strength:** Select the signal strength for the 2.4GHz frequency band. If **5GHz Only** is selected in the **WiFi Mode** drop-down list, then the signal strength for the 2.4GHz band will automatically be set to 0.
  - **5GHz Signal Strength:** Select the signal strength for the 2.4GHz frequency band. If **2.4GHz Only** is selected in the **WiFi Mode** drop-down list, then the signal strength for the 5GHz band will automatically be set to 0.
- **Network Proxy Settings**
    - **Proxy:** Turn on the toggle to configure the device for use with a proxy server.



- **HTTP Settings**
  - **HTTP Proxy:** Turn on the toggle to allow the device to use an HTTP proxy server.
  - **HTTP Proxy Address:** Enter the IP address or the FQDN of the HTTP proxy server.
  - **HTTP Proxy Port:** Enter the port number of the HTTP proxy server.
  - **Username:** Enter the username required for the HTTP proxy server.
  - **Password:** Enter the password required for the HTTP proxy server.
- **HTTPS Settings**
  - **HTTPS Proxy:** Turn on the toggle to allow the device to use an HTTPS proxy server.
  - **HTTPS Proxy Address:** Enter the IP address or the FQDN of the HTTPS proxy server.
  - **HTTPS Proxy Port:** Enter the port number of the HTTPS proxy server.
  - **Username:** Enter the username required for the HTTPS proxy server.
  - **Password:** Enter the password required for the HTTPS proxy server.

## Power Settings

Select **Power Settings** to configure the receiver's power settings.

### System Setup - Power Settings

System Setup

General Settings Network **Power Settings** Cloud Settings Auto Update Date/Time Control System

Power Settings

Power Mode Business Hours + Occupancy ... ⓘ

Enabled	Day	On Time	Off Time
<input checked="" type="checkbox"/>	Sunday	00:00	23:59
<input checked="" type="checkbox"/>	Monday	00:00	23:59
<input checked="" type="checkbox"/>	Tuesday	00:00	23:59
<input checked="" type="checkbox"/>	Wednesday	00:00	23:59
<input checked="" type="checkbox"/>	Thursday	00:00	23:59
<input checked="" type="checkbox"/>	Friday	00:00	23:59
<input checked="" type="checkbox"/>	Saturday	00:00	23:59

The **Power Mode** setting allows the receiver to go to sleep based on business hours and/or room occupancy.

Select a **Power Mode** option from the drop-down list:

**NOTE: Business Hours + Occupancy Based** is the default setting.

- Select **Business Hours + Occupancy Based** to wake the receiver during business hours and whenever the room is occupied. This applies the following behavior:
  - The display device is on and the receiver is awake during business hours. Define business hours using the table:
    - **Enabled:** Turn the toggle on to include the day in the business hours schedule.
    - **On Time:** Enter the time of day (in 24-hour format) when business hours begin.
    - **Off time:** Enter the time of day (in 24-hour format) when business hours end.
  - The touch screen is always on.
  - Crestron Fusion power events are ignored.
  - If room occupancy or vacancy is detected outside of business hours, the receiver wakes up or goes to sleep accordingly.
  - Virtual button power events are allowed.
  - If an HDMI sync is detected outside of business hours, the receiver wakes up.
- Select **Occupancy Based** to wake the receiver whenever the room is occupied. This applies the following behavior:
  - The connected occupancy sensor determines when the room is occupied or vacant.
  - If room vacancy is detected, the receiver goes to sleep.
  - If room occupancy is detected, the receiver wakes up.
  - If the display device is configured as a controlled display device, it powers on when the room is occupied and powers off when the room is vacant.
  - The touch screen is on when the room is occupied and off when the room is vacant.
  - Crestron Fusion power events are permitted.
  - If an HDMI sync is detected, the receiver wakes up.
  - An AirMedia connection does not wake the receiver.

**NOTE:** When the **On Time** and **Off Time** settings are set to **00:00** and **23:59** respectively, the display device is on and the receiver is awake all day.

- Select **Signage Only** to show digital signage content during business hours. This applies the following behavior:

- All user presentation capabilities are disabled.
- The display device and the receiver will always present digital signage during business hours and turn off outside of business hours. Define business hours using the table:
  - **Enabled:** Turn the toggle on to include the day in the business hours schedule.
  - **On Time:** Enter the time of day (in 24-hour format) when business hours begin.
  - **Off time:** Enter the time of day (in 24-hour format) when business hours end.

**NOTE:** When the **On Time** and **Off Time** settings are set to **00:00** and **23:59** respectively, the display device is on and the receiver is awake all day.

- The connected occupancy sensor determines when the room is occupied or vacant.
- If room occupancy is detected outside of business hours, the receiver and display device power on. Digital signage is displayed.
- If room vacancy is detected outside of business hours, the receiver and display device power off.
- The touch screen is always off.
- Crestron Fusion power events are permitted.

**NOTE:** To use the **Signage Only** power mode, use the **Signage Only** application mode.

- Select **Business Hours + Occupancy Based for Signage** to show digital signage content during business hours and whenever the room is occupied. This applies the following behavior:
  - The display device and the receiver will turn on during business hours and turn off outside of business hours. Define business hours using the table:
    - **Enabled:** Turn the toggle on to include the day in the business hours schedule.
    - **On Time:** Enter the time of day (in 24-hour format) when business hours begin.
    - **Off time:** Enter the time of day (in 24-hour format) when business hours end.

**NOTE:** When the **On Time** and **Off Time** settings are set to **00:00** and **23:59** respectively, the display device is on and the receiver is awake all day.

- The connected occupancy sensor determines when the room is occupied or vacant.
- If room vacancy is detected during business hours, the receiver goes to sleep. Digital signage is displayed.
- If room occupancy is detected during business hours, the receiver wakes up.
- If room vacancy is detected outside of business hours, the receiver and display device power off.
- If room occupancy is detected outside of business hours, the receiver and display device power on.
- The touch screen is on when the room is occupied and off when the room is vacant.
- Crestron Fusion power events are permitted.
- If an HDMI sync is detected, the receiver wakes up.
- An AirMedia connection does not wake the receiver.

**NOTE:** The **Business Hours + Occupancy Based With Signage** setting must be selected if Appspace is to be used.

## Cloud Settings

Select **Cloud Settings** to configure the device's connection to the XiO Cloud® service. By default, the **Cloud Configuration Service Connection** toggle is turned on. For more information on using the XiO Cloud service with an AirMedia receiver, refer to [Enterprise Deployment Options on page 153](#).

### System Setup - Cloud Settings

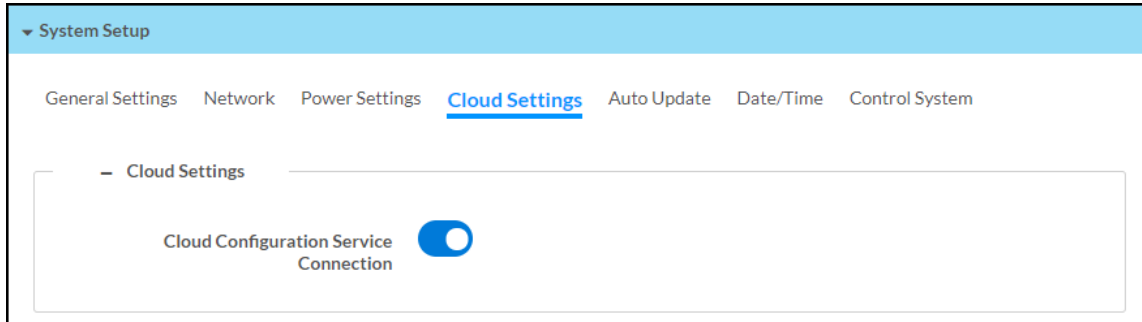

## Auto Update

Select **Auto Update** to configure the auto update feature. The auto update feature allows the device to automatically scan for firmware updates and install the updates as needed.

### System Setup – Auto Update

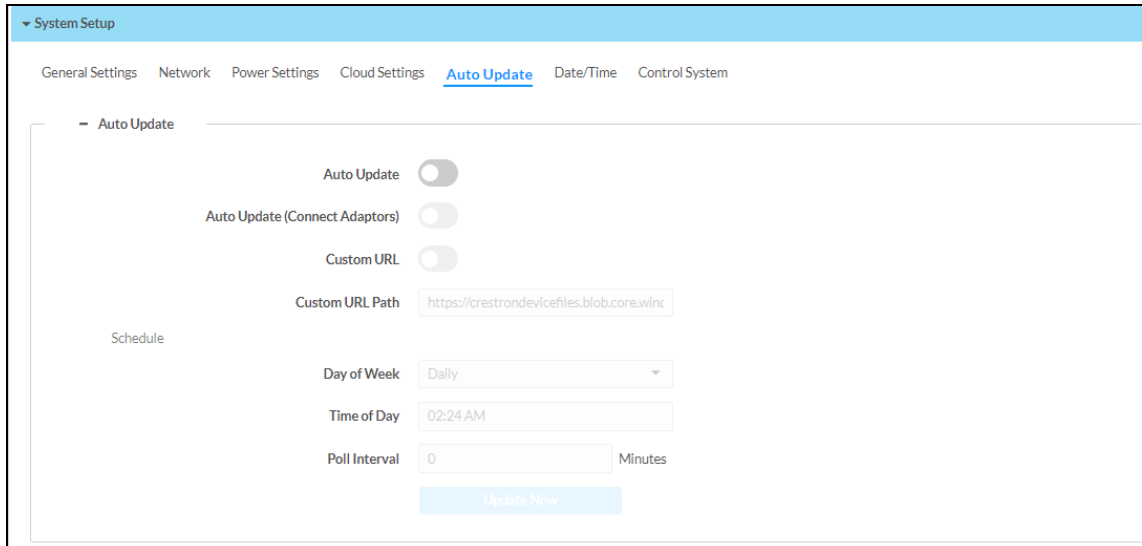

- **Auto Update:** Turn the toggle on to allow automatic updates.
- **Auto Update (Connect Adaptors):** Turn the toggle on to allow automatic updates of Connect Adaptors. With this feature enabled, if a firmware update is available and the adaptor is connected, a notification is shown on the room display. Follow the instructions in the notification to initiate the firmware update.
- **Custom URL:** Turn the toggle on to use a custom update server URL. If turned off, the server URL will default to the standard Crestron update server.

- **Custom URL Path:** If **Custom URL** is turned on, enter the custom URL path for the update server.
- **Schedule:** Set the schedule for when the device checks for updates.
  - **Day of Week:** Select the day of the week when the device will check for updates. Select **Daily** to have the device check for updates every day.
  - **Time of Day:** Enter a time of day (in 24-hour format) when the device will check updates on the scheduled day.
  - **Poll Interval:** Enter the polling interval (in minutes) for when the device will poll the server for updates.
  - Select **Update Now** to check the update server for new firmware and to update the device immediately if new firmware is available.

## Date/Time

Select **Date/Time** to configure the settings for the receiver's internal clock.

### System Setup – Configure Date/Time

The screenshot shows the 'Date/Time' configuration page within the 'System Setup' menu. The page has a light blue header with the title 'System Setup' and a navigation bar with links for 'General Settings', 'Network', 'Power Settings', 'Cloud Settings', 'Auto Update', 'Date/Time' (which is underlined and highlighted), and 'Control System'. Below the navigation bar, there is a sub-header '- Date/Time'. Under this sub-header, there is a 'Synchronization' section with a 'Time Synchronization' toggle switch that is turned on. Below the toggle is a blue button with a refresh icon and the text 'Synchronize Now'. Below the synchronization section is an 'NTP Time Servers' section containing a table with columns for 'Address', 'Port', 'Authentication Method', 'Authentication Key', and 'Key ID'. The table has one row with the following values: 'pool.ntp.org', '123', 'None', '.....', and '0'. Below the table are two buttons: '+ Add' and '- Remove'. Below the NTP Time Servers section is a 'Configuration' section with several fields: 'Time Zone' (dropdown menu showing '(UTC - 05: 00) Eastern Time (US & ...)', 'Date Format' (dropdown menu showing 'MDY'), 'Time Format' (dropdown menu showing '12'), 'Date' (text input field showing '07/28/2021'), and 'Time' (text input field showing '09:06').

- **Synchronization:** The receiver's internal clock can be synchronized with a time server.
  - **Time Synchronization:** Turn on the toggle to use time synchronization via SNTP (Simple Network Time Protocol).
  - **Synchronize Now:** With **Time Synchronization** turned on, select **Synchronize Now** to synchronize the receiver with the SNTP server(s) entered in the **NTP Time Servers** table.

- **NTP Time Servers:** With **Time Synchronization** turned on, use the provided table to enter information regarding the SNTP server(s) used to synchronize the date and time for the receiver.
  - Select **Add** to add a new SNTP server entry into the table.
  - Enter the following information for each entry:
    - Enter the SNTP server address into the **Address** text field.
    - Enter the SNTP server port into the **Port** text field.
    - Use the **Authentication Method** drop-down menu to select the authentication method used to access the SNTP server (if one exists).
    - If an authentication method is selected, enter the key used to authenticate against the SNTP server into the **Authentication Key** text field.
    - If an authentication method is selected, enter the ID for the key used to authenticate against the SNTP server into the **Key ID** text field.
  - To remove an entry, fill the checkbox to the left of the table entry, and then select **Remove**.
- **Configuration:** The receiver's internal clock can be configured manually.
  - **Time Zone:** Select a time zone for the receiver using the drop-down menu.
  - **Date Format:** Select the format that the date will appear on the display device using the drop-down menu (**MDY, DMY, or YMD**).
  - **Time Format:** Select the format that the time will appear on the display device (12 hour or 24 hour).
  - **Date:** Select the date for the receiver using the pop-up calendar that is displayed.



## Control System

Select **Control System** to connect and configure a control system with the receiver. The receiver can be controlled by a Crestron control system or by a virtual control system's SIMPL or SIMPL# program.

### System Setup – Control System

The screenshot shows the 'Control System' configuration page. At the top, there is a navigation bar with tabs for 'General Settings', 'Network', 'Power Settings', 'Cloud Settings', 'Auto Update', 'Date/Time', and 'Control System'. The 'Control System' tab is selected. Below the navigation bar, there is a section titled 'Control System' with a minus sign. Inside this section, there is a toggle for 'Encrypt Connection' which is turned on. Below the toggle are two input fields: 'Control System Username' with the value 'username1' and 'Control System Password' with masked characters. Below these fields is an 'IP Table' section. The table has columns for 'IP ID', 'IP Address/Hostname', and 'Room ID'. The table is currently empty, with the text 'No records found' in the center. At the bottom of the table, there are two buttons: '+ Add' and 'x Remove'.

- **Encrypt Connection:** Turn the toggle on to use SSL encryption for communication with the control system. SSL can be used with or without a CA certificate. When **Encrypt Connection** is toggled on, the username and password for the control system is required.
- **Control System Username:** The username for the control system.
- **Control System Password:** The password for the control system.
- **IP Table:** Select **Add** to add an IP table connection between the device and the control system.
  - **IP ID:** Enter an IP ID for connecting the device to the control system.

#### NOTES:

- The control system will search the related ID while entering the IP ID.
  - The IP ID must match the IP ID defined in the control system's SIMPL Windows or SIMPL# program.
- **IP Address/Hostname:** Enter the control system IP address or hostname.
  - **Room ID:** Enter a room ID to associate with the device (for connections with the Crestron Virtual Control server-based control system).

## Services

Select **Services** to configure the device's connection with Crestron Fusion® software and/or other calendaring applications.

At the top left corner of the **Services** window, select the + (plus) icon next to **Fusion** to configure the following Crestron Fusion connection settings.

### Settings Tab - Services (Fusion)

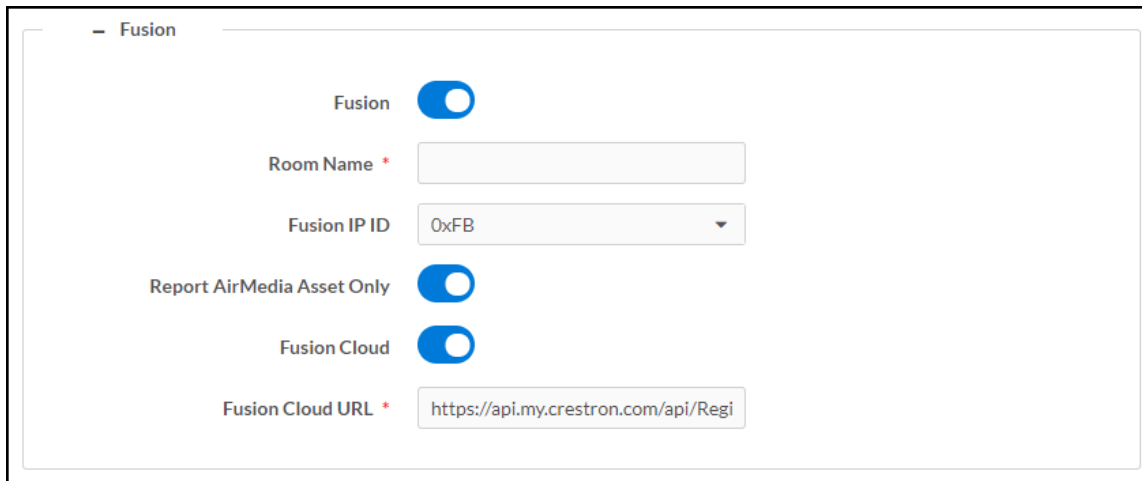

The screenshot shows the 'Fusion' settings window. At the top left, there is a minus sign and the text '- Fusion'. Below this, the settings are as follows:

- Fusion**: A blue toggle switch is turned on.
- Room Name \***: An empty text input field.
- Fusion IP ID**: A dropdown menu with '0xFB' selected.
- Report AirMedia Asset Only**: A blue toggle switch is turned on.
- Fusion Cloud**: A blue toggle switch is turned on.
- Fusion Cloud URL \***: A text input field containing 'https://api.my.crestron.com/api/Regi'.

- **Fusion**: Turn the toggle on to use Crestron Fusion with the device.
- **Room Name**: Enter the room name to be used by the Crestron Fusion server.
- **Fusion IP ID**: Select the IP ID number to be used by the Crestron Fusion server.
- **Report AirMedia Asset Only**: Turn the toggle on to allow only AirMedia related settings to appear in Crestron Fusion. Turn the toggle off to allow all device settings to appear in Crestron Fusion.
- **Fusion Cloud**: Turn the toggle on and enter the Fusion Cloud URL manually in the **Fusion Cloud URL** field. When **Fusion Cloud** is toggled off, the Crestron Fusion server will use auto-discovery and the **Fusion Cloud URL** field will not appear.

**NOTE:** Upon completion, the device will be brought into Crestron Fusion software as a processor. For more details on using the device with Crestron Fusion, refer to the Crestron Fusion help file.

Select the + (plus) icon next to **Calendar** to display the following calendaring application settings.

### Settings Tab - Services (Calendar)

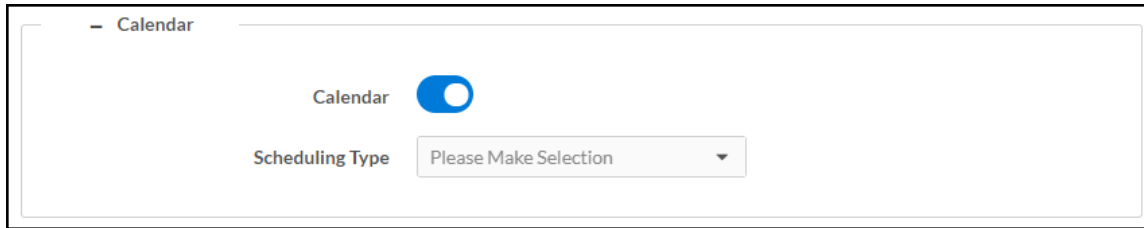

- **Calendar:** Turn the toggle on to use a calendaring application with the AirMedia device.
- **Scheduling Type:** Select a calendaring service from the drop-down menu.

### Crestron Fusion Service

To use the device with Crestron Fusion scheduling software:

1. Configure a Crestron Fusion connection as described in [Services on page 113](#).
2. Turn on the **Calendar** toggle.
3. Select **Fusion** from the **Scheduling Type** drop-down menu.
4. Select **Save Changes**. In the **System Initialization** dialog box, select **Yes** to continue. System initialization will occur.

#### System Initialization

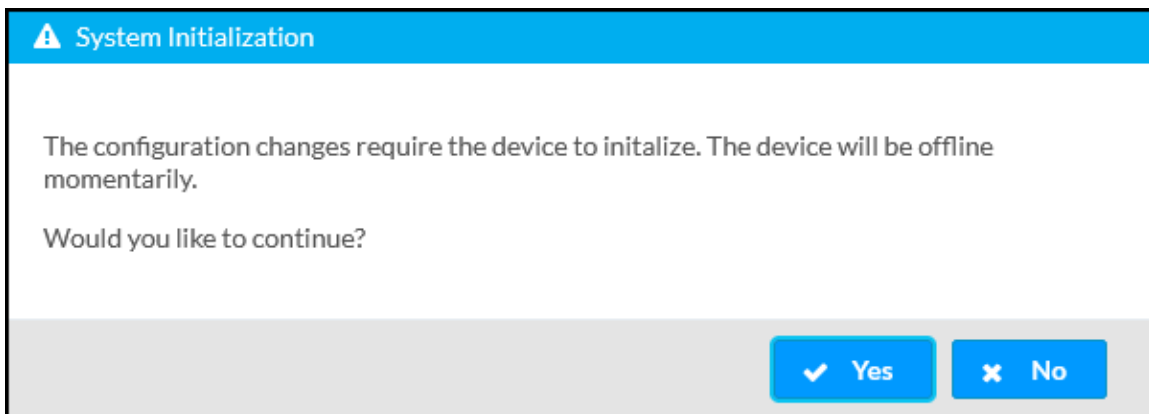

### Google Calendar Service

To use the device with the Google Calendar service:

1. Turn on the **Calendar** toggle as described in [Services on page 113](#).
2. Select **Google** from the **Scheduling Type** drop-down list to use the Google Calendar™ application for calendar functions.

## Calendar Settings – Google Calendar

Calendar

Scheduling Type

Calendar Account/ID

Registration Status **Not Registered**

[Register Now](#)

3. In the **Calendar Account/ID** field, enter the email address attached to the desired Google calendar.
4. Select **Save Changes**. In the **System Initialization** dialog box, select **Yes** to continue. System initialization will occur.

### System Initialization

**System Initialization**

The configuration changes require the device to initialize. The device will be offline momentarily.

Would you like to continue?

[Yes](#) [No](#)

5. Select **Register Now**. The **Registration Status**, **Registration URL**, and **Registration Code** fields will appear.

Calendar

Scheduling Type

Calendar Account/ID

Registration Status **Waiting for Authorization**

[Registering](#)

Registration URL

Registration Code GCQR-TCGB

6. Copy the code in the **Registration Code** field.

7. In the **Registration URL** field, select **Sign in with Google**. The **Connect a device** screen appears.

#### Connect a device Screen

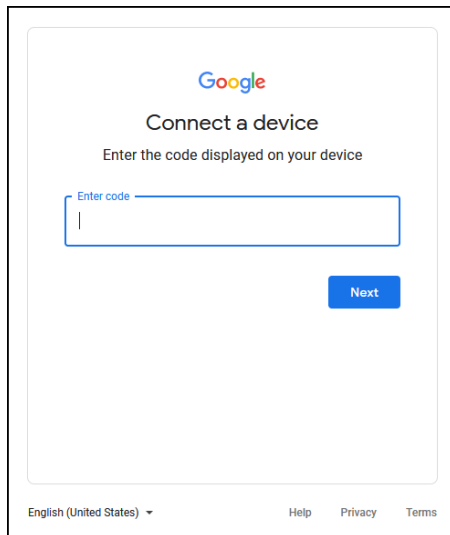

8. Enter the registration code in the **Enter Code** field and select **Next**. The **Choose an account** screen appears.
9. Select an account and sign in with the login credentials.
10. Select **Allow** to complete the process. A success message will be displayed, and the Google Calendar status will be updated.

To disconnect the calendar from the device, select **Unregister** and follow the instructions for activating a new configuration.

#### Calendar Settings – Google Calendar

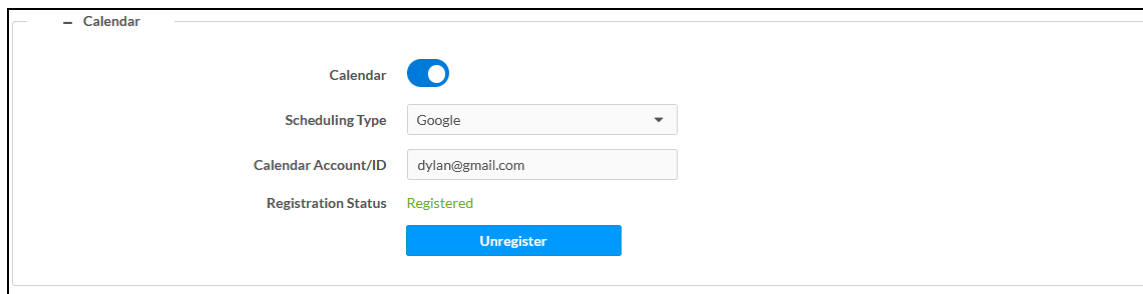

## Microsoft Exchange Server and Microsoft 365 Software, Modern Authentication

To use the device with Microsoft Exchange Server and Microsoft 365 Software (Modern Authentication enabled):

1. Turn on the **Calendar** toggle as described in [Services on page 113](#).
2. Select **Exchange/O365** from the **Scheduling Type** drop-down menu.
3. Turn on the **Enable Modern Authentication** toggle.
4. Enter a Client ID in the **Client ID (Application ID)** field.
5. Enter an O365/Microsoft 365 Tenant ID in the **O365 Tenant ID** field.
6. (Optional) Enter the Calendar email address in the **Calendar Email Address** field. The calendar email address is required for accounts using impersonation.

### Services – Calendar

<b>Calendar</b>	<input checked="" type="checkbox"/>
<b>Scheduling Type</b>	Exchange/O365
<b>Enable Modern Authentication</b>	<input checked="" type="checkbox"/>
<b>Client ID (Application ID)</b>	3aaf74-a815-4975-86d3-b722094438e1
<b>O365 Tenant ID</b>	3b5de0-7210-4ff7-843d-be0bed794735
<b>Calendar Email Address</b>	testuser1@gstestdomain.com

7. Select **Save Changes**. In the **System Initialization** dialog box, select **Yes** to continue. System initialization will occur.

8. Select **Register Now**. A code and a Microsoft icon will appear.

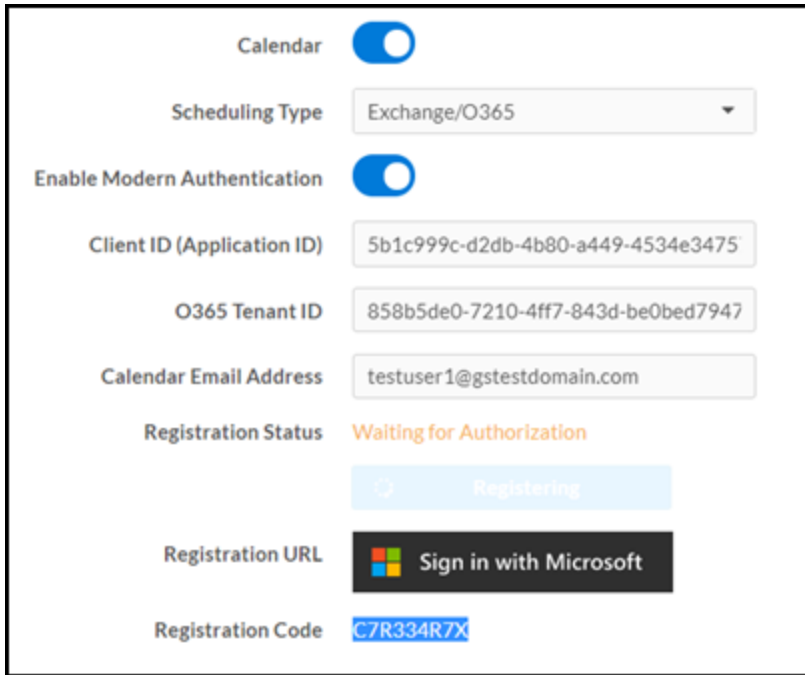

The screenshot shows a configuration page for a calendar application. It includes several settings:

- Calendar**: A toggle switch that is turned on.
- Scheduling Type**: A dropdown menu set to "Exchange/O365".
- Enable Modern Authentication**: A toggle switch that is turned on.
- Client ID (Application ID)**: A text field containing "5b1c999c-d2db-4b80-a449-4534e3475".
- O365 Tenant ID**: A text field containing "858b5de0-7210-4ff7-843d-be0bed7947".
- Calendar Email Address**: A text field containing "testuser1@gstestdomain.com".
- Registration Status**: A label "Waiting for Authorization" in orange text.
- Registration URL**: A button labeled "Registering" with a circular arrow icon.
- Registration URL**: A button labeled "Sign in with Microsoft" with the Microsoft logo.
- Registration Code**: A text field containing "C7R334R7X" with a blue highlight.

9. Copy the code in the **Registration Code** field.
10. Select **Sign in with Microsoft** in the **Registration URL** field. An **Enter code** screen will appear.

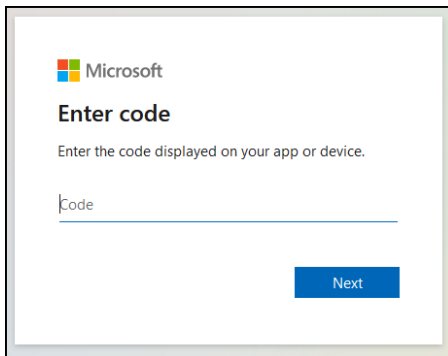

The screenshot shows the "Enter code" screen from Microsoft. It features the Microsoft logo at the top left, followed by the text "Enter code" and "Enter the code displayed on your app or device." Below this is a text input field with a blue underline and a cursor. At the bottom right, there is a blue button labeled "Next".

11. Enter the registration code and select **Next**.
12. Enter the account credentials to sign in.

13. On first use, a permissions required window will be displayed. Select **Accept**.

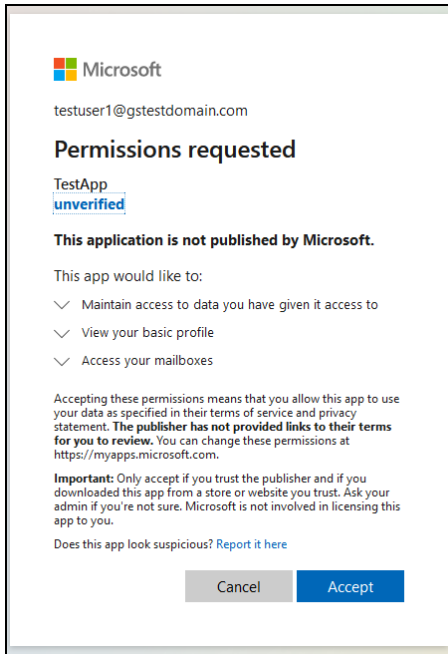

14. Sign in to the Microsoft 365 service. Once signed in, a confirmation message will appear, and the Registration Status will be updated.

To disconnect the calendar from the device, select **Unregister** and follow the instructions for activating a new configuration.

## Microsoft Exchange Server and Microsoft 365 Software, Modern Authentication Disabled

To use the device with Microsoft Exchange Server and Microsoft 365 Software (Modern Authentication disabled):

1. Turn on the **Calendar** toggle as described in [Services on page 113](#).
2. Select **Exchange/O365** from the **Scheduling Type** drop-down menu.
3. Turn the **Enable Modern Authentication** toggle off.
4. (Optional) Enter the calendar email address in the **Calendar Email Address** field. The calendar email address is required for accounts using impersonation.
5. Enter the account username in the **Username** field.
6. Enter the account password in the **Password** field.
7. Enter the domain name used by the Exchange server in the **Domain** field.



8. Enter the URL of the Exchange server in the **Exchange Web Services URL** field.

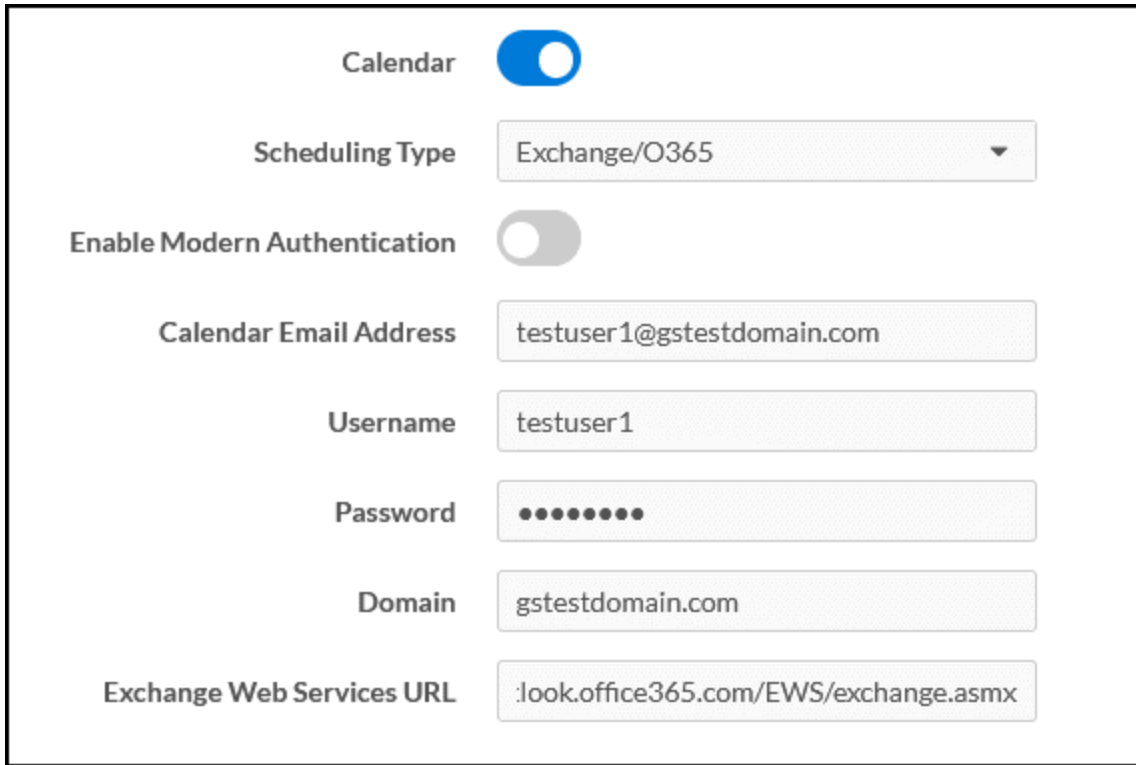

The screenshot shows a configuration interface for Exchange Web Services. It includes a toggle for 'Calendar' (turned on), a dropdown for 'Scheduling Type' (set to 'Exchange/O365'), a toggle for 'Enable Modern Authentication' (turned off), and text input fields for 'Calendar Email Address' (testuser1@gstestdomain.com), 'Username' (testuser1), 'Password' (masked with dots), 'Domain' (gstestdomain.com), and 'Exchange Web Services URL' (:look.office365.com/EWS/exchange.asmx).

9. Select **Save Changes**. In the **System Initialization** dialog box, select **Yes** to continue. System initialization will occur.

To disconnect the calendar from the device, select **Unregister** and follow the instructions for activating a new configuration.

## Audio-Video

Select **Audio-Video** to configure settings for the HDMI input port (AM-3200(-WF)(-I) models only) and HDMI output port and to display information about the display device and output signal.

Select the **+** (plus) icon next to **Inputs** to display the following HDMI input settings.

### Settings Tab - Audio-Video (Inputs)

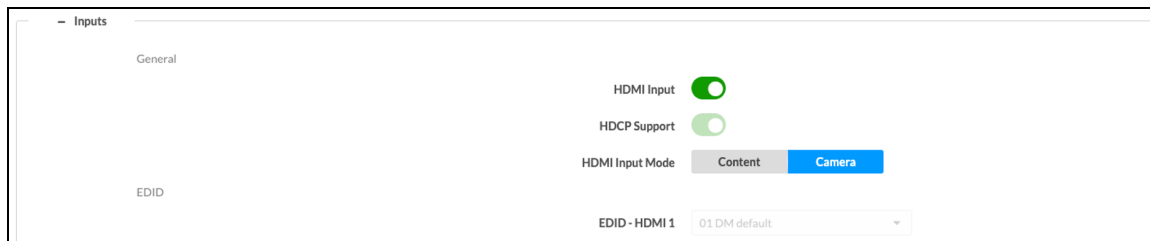

The screenshot shows the 'Inputs' settings tab. It includes a 'General' section with 'HDMI Input' (turned on), 'HDCP Support' (turned on), and 'HDMI Input Mode' (set to 'Camera'). There is also an 'EDID' section with 'EDID - HDMI 1' (set to '01 DM default').

- **General**
  - **HDMI Input:** Turn the toggle on to enable the HDMI input port.
  - **HDCP Support:** Turn the toggle on to allow source signals that require HDCP compliance to pass through to the display device.
  - **HDMI Input Mode:** Select the mode for the HDMI input port.
    - Select **Content** to share content from a personal device through the HDMI input.
    - Select **Camera** to use a connected HDMI camera for Wireless Conferencing.
- **EDID**
  - **EDID-HDMI 1:** Select an EDID profile loaded to the receiver to use for the HDMI input.

**NOTE:** To manage EDID profiles installed on the receiver, refer to [Manage EDIDs \(AM-3200\(-WF\)\(-I\) Models Only\)](#) on page 82.

Select the + (plus) icon next to **Outputs** to display the following HDMI output settings.

#### Settings Tab - Audio-Video (Outputs)

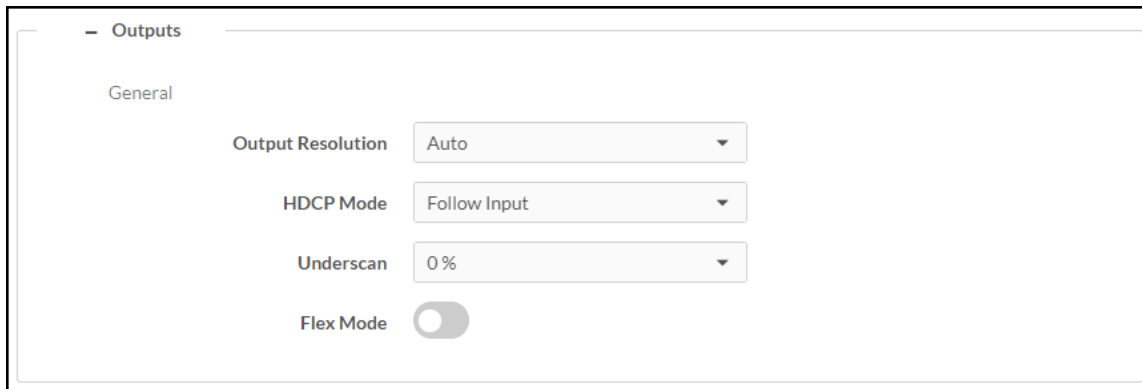

- **Output Resolution:** Select the output resolution from the drop-down list.
- **HDCP Mode:** Select the HDCP mode from the drop-down list.
  - When **HDCP Mode** is set to **Auto**, the receiver always attempts to use HDCP if support is detected on the display device.
  - When **HDCP Mode** is set to **Follow Input**, the receiver attempts to use HDCP if support is detected on the HDMI input.
  - When **HDCP Mode** is set to **Force Highest**, the receiver attempts to use the latest version of HDCP regardless of whether or not support is detected on the display device.
  - When **HDCP Mode** is set to **Never Authenticate**, the receiver never attempts to use HDCP with downstream devices, regardless of support.

- **Underscan:** Select the amount of underscan to apply to the output signal from the drop-down list. Adjust this setting to improve the readability of text that may be cropped due to overscan or underscan conditions on the display device.
- **Flex Mode:** Turn the toggle on when using the receiver with a Crestron Flex conference system. Flex Mode disables the HDMI output from the AirMedia device unless a source is active.

**NOTE:** When using the device in Flex Mode, Crestron recommends setting **HDCP Mode** to **Never**. A connected touch screen must be set to communicate to the device at the IP ID FD. In **System Setup > Power Settings**, **Standby Mode** must be set to **Always On** as described in [Power Settings on page 104](#).

## Connected Devices

Select **Connected Devices** to configure settings for any connected devices such as displays, touch screens, keypads, occupancy sensors, and Wireless Conferencing peripherals.



### Settings Screen - Connected Devices



Select the + (plus) icon next to **Connected Devices** to display the following device settings.

### Settings Screen – Connected Devices (Connected Devices)

Connected Devices				
Name	Type	Model	Status	Actions
PoE Occupancy Sensor	Poe	CEN-ODT-C-POE	NA	
Panel	Touch Panel	TS-1070	Online	
Display	Video Display	CEC Controlled-Display	NA	
ZUM-AVBRIDGE-AVB	Zum Bridge	ZUM-AVBRIDGE	Online	

A list of connected devices is along with each device's **Name**, **Type**, **Model**, and **Status** . Select the edit button  to modify the connected device's settings. Select the test driver button  to send commands to a display device to test the driver's functionality.

## Occupancy Sensor

AirMedia Series 3 receivers can utilize a [CEN-ODT-C-POE](#) occupancy sensor to enable simple room automation without custom programming. Perform the procedure below to configure the occupancy sensor.

1. Install the CEN-ODT-C-POE. For more information, refer to the CEN-ODT-C-POE [Quick Start Guide](#).
2. Using the AirMedia receiver's web configuration interface, select the edit button  next to the occupancy sensor to select an IP ID for the occupancy sensor.
3. Using the CEN-ODT-C-POE web configuration interface, enter the AirMedia receiver's IP address or hostname as the control system connection, along with the selected IP ID. **Room ID** should remain blank. For more information, refer to the [CEN-ODT-C-POE Supplemental Guide](#).

The occupancy sensor can now be used with the AirMedia Series 3 receiver.

## AirMedia Wireless Keypad

AirMedia Series 3 receivers can use a [ZUMMESH-KP10AMBATT](#) AirMedia Wireless Keypad (sold separately) paired to a [ZUMMESH-AVBRIDGE](#) Wireless Control Integration Module (sold separately) for system control. Perform the procedure below to configure the keypad.

1. Follow the installation instructions for the [ZUMMESH-KPT10AMBATT](#) and [ZUMMESH-AVBRIDGE](#).
2. Connect the ZUMMESH-AVBRIDGE to the receiver via USB.
3. In **Connected Devices**, select the ZUMMESH-AVBRIDGE's edit button .
4. Select **Start Acquire** to initiate discovery mode on the ZUMMESH-AVBRIDGE.

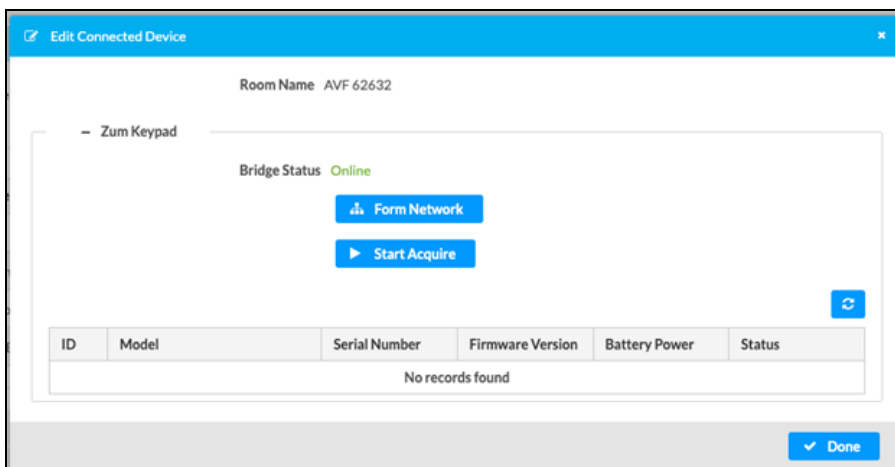

5. On the ZUMMESH-KPT10AMBATT, initiate discovery mode by tapping the **ON** button three times and then pressing and holding it.

Once paired, the keypad will appear on the ZUMMESH-AVBRIDGE's **Edit Connected Device** page and will control the connected display.

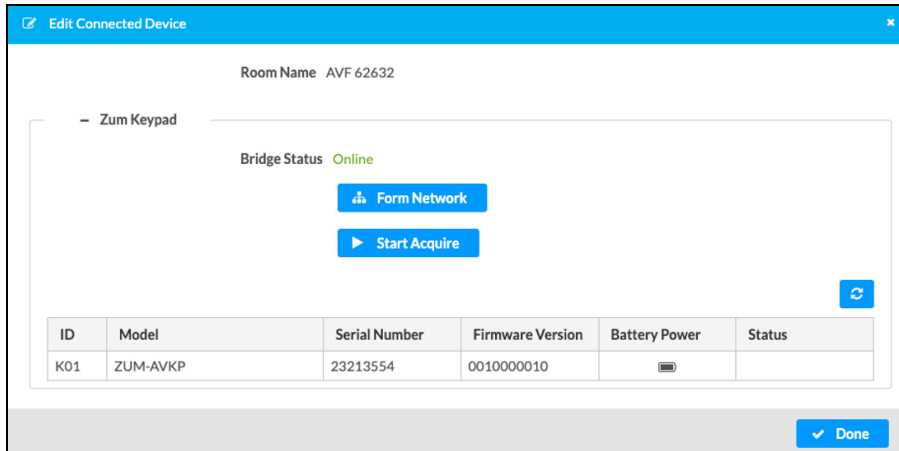

## Front of the Room Display

Select the + (plus) icon next to **Front of the Room Display** to display settings for the front of the room experience splash screen.

### Settings Screen – Connected Devices (Front of the Room Display)

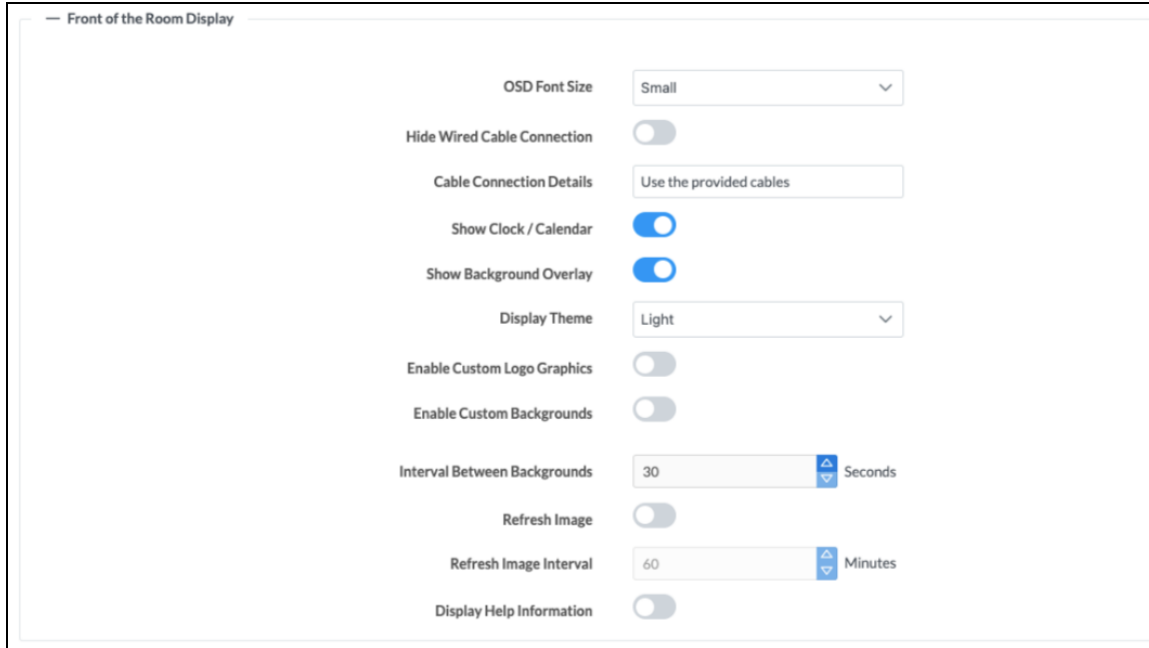

- **OSD Font Size:** Select the font size of the connection bar text on the AirMedia Welcome Screen (**Small**, **Medium**, or **Large**).
- **Hide Wired Cable Connection:** (AM-3200(-WF)(-I) models only) Turn the toggle on to hide wired connection details on the display device.
- **Cable Connection Details:** (AM-3200(-WF)(-I) models only) Enter custom instructions for presenting content using the receiver's wired connection. The instructions will appear on the display device and should be used to guide users.
- **Show Clock / Calendar:** Turn the toggle on to show the clock and calendared events in the center of the display device.
- **Show Background Overlay:** Turn the toggle on to place a monochrome filter over background images.
- **Display Theme:** Select a display theme from the drop-down menu to use a light or dark color scheme on the display device.

- **Enable Custom Logo Graphics:** Turn the toggle on to display a custom logo on the display device. An **Add Logo** option will appear when the change is saved. When the toggle is off, the Crestron logo is displayed.

**NOTES:**

- The optimal image size for a logo is 600 x 100 pixels. Custom graphics that are smaller or larger than 600 x 100 pixels are scaled to fit on the Front of Room display.
  - To manage images stored on the receiver, refer to [Manage Images on page 86](#). Up to 20 images can be stored locally on the receiver at a maximum of 100 MB.
  - **Logo and Custom Background Management:** Select **Add Logo** to use a custom image. Choose an image located on a server or upload a custom image.
  - **Source:** Select **URL** to use an image located on a server. Enter the URL of the image location in the **Graphic URL** field. Select **File** to upload an image file.
- **Enable Custom Backgrounds:** Turn the toggle on to display a custom background slideshow when the system is not in use. An **Add Logo** option will appear once the change is saved.

**NOTES:**

- Up to 20 images can be stored locally on the receiver at a maximum of 100 MB. To manage images stored on the receiver, refer to [Manage Images on page 86](#).
  - Custom background images should be jpg files with resolutions no higher than 4096 x 2160 pixels. Images with resolutions higher than 4096 x 2160 pixels may exceed the receiver's storage limit when rendered and will inhibit performance.
  - The interface has been designed to use most of the screen area for informational purposes. This feature is intended for use with corporate colors, branding, and aesthetics unique to the particular organization and should not be used to add custom instructions for room users.
- **Logo and Custom Background Management:** Select **Add Logo** to upload a custom image. Choose an image located on a server or upload a custom image.
  - **Source:** Select **URL** to use an image located on a server. Enter the URL of the image location in the **Graphic URL** field. Select **File** to upload an image file. The image is then added to a list of files in the File drop-down menu. Select the image file from the drop-down menu.
- **Interval Between Backgrounds:** Enter a span of time (in seconds) that each background image is displayed.
  - **Refresh Image:** Turn the toggle on to allow the system to periodically download the remotely stored logo and background images from the URLs specified for the custom logo or background.

- **Refresh Image Interval:** Enter the amount of time between downloads (in minutes). The minimum amount of time available is one minute, and the maximum amount of time is 65,535 minutes (about 45 days).
- **Display Help Information:** Turn the toggle on to allow the system to display custom help information. Enter the **Help Information Text** to be displayed.

## Touch Panel Settings

Select the + (plus) icon next to **Touch Panel Settings** to display settings for connected touch screens.

### Settings Screen – Connected Devices (Touch Panel Settings)

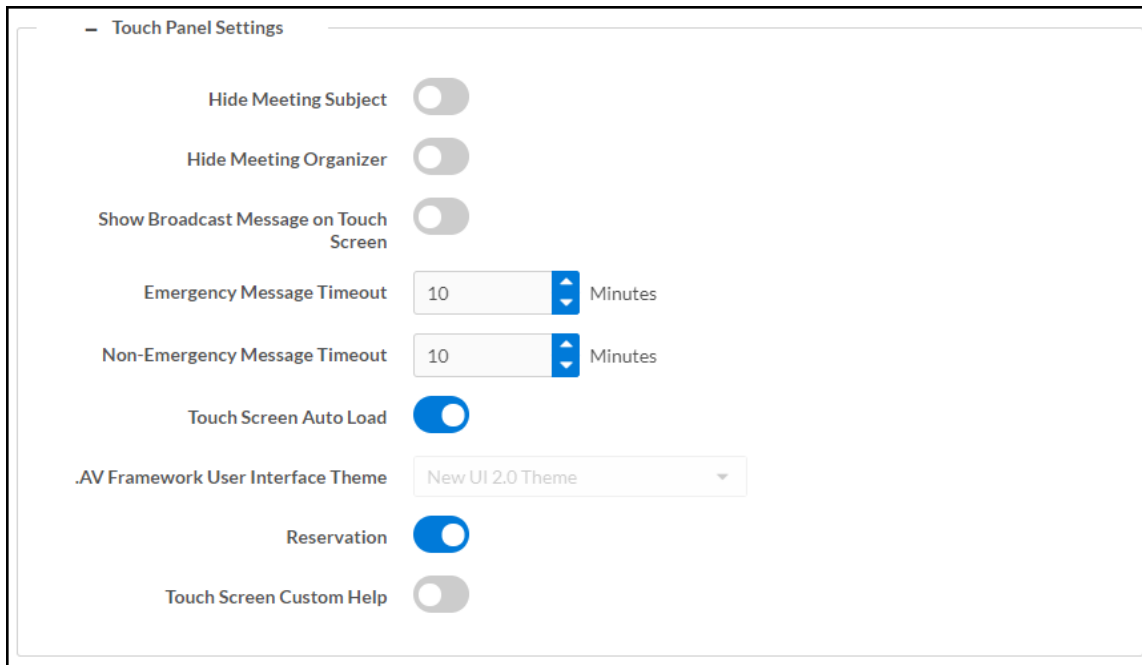

- **Hide Meeting Subject:** Turn the toggle on to hide the meeting's subject on the touch screen.
- **Hide Meeting Organizer:** Turn the toggle on to hide the meeting's organizer on the touch screen.
- **Show Broadcast Message on Touch Screen:** Turn the toggle on to show broadcast messages on the touch screen (broadcast messages are automatically shown on the display device).
- **Emergency Message Timeout:** Enter the number of minutes an emergency broadcast message is displayed on the touch screen.

**NOTE:** Emergency broadcasts are sent from Crestron Fusion which is to be supported in a future firmware release. For more information on emergency broadcasts, refer to the [Crestron Fusion® Software SSI Model Reference Guide](#) (Doc. 7898).



- **Non-Emergency Message Timeout:** Enter the number of minutes a non-emergency broadcast message is displayed on the touch screen.
- **Touch Screen Auto Load:** Turn the toggle on to allow project files to be pushed to the touch screen from the cloud automatically.
- **.AV Framework User Interface Theme:** For future use.
- **Reservation:** Turn the toggle on to allow calendar reservations from the touch screen.
- **Touch Screen Custom Help:** Turn the toggle on to display a custom help screen when the information button is tapped on the touch screen. A **Custom Help URL** field appears. Enter the image's URL in the **Custom Help URL** field and save the changes.

## Display Notifications

Select the + (plus) icon next to **Display Notifications** to reveal settings for how notifications are displayed when an AirMedia device is in use.

### Settings screen – Connected Devices (Display Notifications)

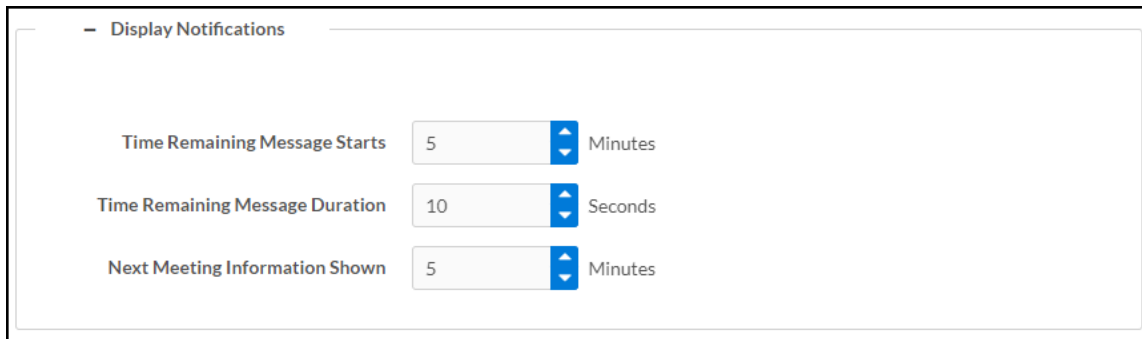

- **Time Remaining Message Starts:** Enter the amount of time that must pass (in minutes) before the meeting's time remaining message is displayed.
- **Time Remaining Message Duration:** Enter the amount of time (in seconds) that the time remaining message is displayed.
- **Next Meeting Information Shown:** Enter the amount of time (in minutes) before the next meeting's information is displayed.

## Conferencing Peripherals

Select the + (plus) icon next to **Conferencing Peripherals** to display settings and information for connected Wireless Conferencing peripherals.

### Settings – Conferencing Peripherals

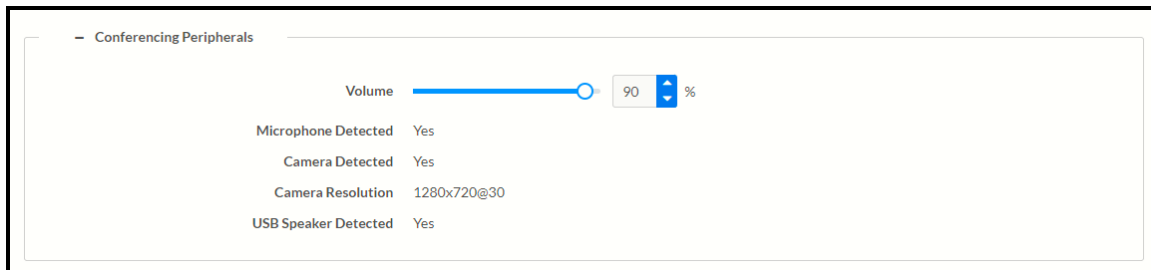

- **Volume:** Controls the maximum allowed volume of connected USB speakers

**NOTE:** The volume slider will only appear when a supported peripheral device is connected.

- **Microphone Detected:** Indicates whether or not a microphone is connected
- **Camera Detected:** Indicates whether or not a camera is connected
- **Camera Resolution:** The resolution of a connected camera
- **USB Speaker Detected:** Indicates whether or not a USB speaker is connected

## Routing

Select **Routing** to configure the order in which devices are routed to the display device upon connection.

### Settings Screen – Routing

Routing

– Input Routing

Routing Mode Automatic Input Routing

– Audio/Video Routes

Channel	Type	Display Name	Rank
	AirMedia	Wireless	1
	HDMI	HDMI	2

Select the + (plus) icons next to **Input Routing** and **Audio Video Routes** to display the **Routing Mode** setting and a list of the routed sources. By default, routing is automatic, meaning the last connected source will be routed to the display device.

Select one of the following routing modes from the drop-down list:

- **Automatic Input Routing:** Automatically route the last connected source to the display device.
- **Priority Routing:** Dictate the order in which sources are routed using the table in the **Audio/Video Routes** section.
  - To change the routing order of a device, select a number from the corresponding drop-down list under the **Rank** column. Devices with a lower number rank will take priority over others.
  - To change the name of the source that appears on the touch screen, type a name into the text field under the **Display Name** column in the corresponding row of the device.
- **AirMedia Auto-Route Only:** Automatically route a connected AirMedia source to the display device. Any other sources (HDMI, for example) must be manually routed from the touch screen.

- **AirMedia Dock Upon Connect:** Automatically dock a source once it connects to the AirMedia receiver. When docked, the source does not present but remains connected to the display.

**NOTE:** The **AirMedia Dock Upon Connect** routing mode is available only for Windows or Android sources.

## AirMedia

Select **AirMedia** to configure the device's AirMedia functionality.

AirMedia can support up to 30 simultaneously connected AirMedia application users (Windows or Android operating systems) and a maximum of two native mirroring users (Airplay or Miracast® mirroring). Up to four sources can present to the display simultaneously using the AirMedia Canvas feature. For details on the AirMedia canvas feature, refer to [AirMedia Canvas Functionality on page 134](#).

**NOTE:** For additional details on deploying AirMedia, refer to the [AirMedia Presentation Gateway Deployment Guide](#) (Doc 7693).

### AirMedia Screen - General Settings (Shown in Optimize for Multiple Presentations Mode)

The screenshot shows the 'General Settings' screen for AirMedia. The settings are organized into sections:

- AirMedia:**
  - AirMedia:  (On)
  - AirMedia Certificate:  (Off)
  - Force Secure Landing Page (HTTPS):  (Off)
  - AirMedia Discovery:  (On)
  - Bluetooth Discovery:  (On)
- AirMedia Canvas:**
  - AirMedia Canvas:  (On)
  - Canvas Session Control:  (On)
- Source Types:**
  - All:  (Selected)
  - Network Only:  (Unselected)
- Max Presentation Limit:** 4
- AirMedia Client Settings:**
  - Timeout: 45

## General Settings

Select the **General Settings** tab to configure settings for AirMedia, the AirMedia Canvas, and Miracast.

**NOTE:** Options forced by the selected **System Mode** are locked. Hover over ⓘ for details.

- **AirMedia:** Turn the toggle on to enable AirMedia wireless presentation on the AirMedia receiver.
- **AirMedia Certificate:** Turn the toggle on to use a third party certificate to encrypt connections between the sender applications for Windows and Android and the receiver. Load a certificate onto the device as described in [802.1x Configuration on page 150](#).
- **Force Secure Landing Page (HTTPS):** Turn the toggle on to force connecting devices to a secure landing page (HTTPS). When enabled, the web server uses either the certificate loaded in the certificate store (when available) or a self-signed certificate. The AirMedia connection URL will contain HTTPS.
- **AirMedia Discovery:** Turn the toggle on to allow the receiver to be automatically discovered by the AirMedia application on users' personal devices on the local network. When the toggle is turned off, users who wish to use present via AirMedia will be required to manually enter the receiver's IP address or host name.
- **Bluetooth Discovery:** Turn the toggle on to enable Bluetooth discovery for use with AirPlay Screen Mirroring on Apple devices. When the toggle is off, users who wish to present via AirPlay Screen Mirroring must use the AirMedia network discovery or the AirMedia application.

**NOTE:** Bluetooth Discovery is supported on devices running the following:

- iOS version 16 or later
- iPadOS version 16 or later
- macOS version 13 Ventura or later

- **AirMedia Canvas:** AirMedia Canvas allows multiple sources to present simultaneously on the display. Refer to [AirMedia Canvas Functionality on page 134](#) for more information.
  - **AirMedia Canvas:** Turn the toggle on to enable AirMedia Canvas functionality.
  - **Canvas Session Control:** Turn the toggle on to control the AirMedia Canvas with a paired touch panel using the .AV Framework 2.0 Interface, a computer running the AirMedia client, or an iOS device running the AirMedia app.

**NOTES:** If **AirMedia Canvas** is disabled, **Canvas Session Control** can remain enabled. In this scenario, session controls are available for all connected users, but only one source can present at a time.

- **Source Types:** Select one of the radio buttons to select which sources can share space on the display. Select **All** to allow all source types (HDMI, AirMedia, Miracast, and AirPlay) to share space on the display. Select **Network Only** to allow only wireless sources (AirMedia, Miracast, and AirPlay) to share space on the display. HDMI sources will present in full screen if selected.
- **Max Presentation Limit:** Select the maximum amount of sources that can present simultaneously.

- **AirMedia Client Settings**

- **Timeout:** Select an amount of time (in minutes) before an inactive, connected user is automatically disconnected from the receiver. An inactive user is not actively presenting but still connected to the receiver.

## AirMedia Canvas Functionality

AirMedia Canvas allows multiple sources to present simultaneously on the display. AirMedia Canvas automatically configures the best possible layout to maximize screen coverage based on the number of active sources, the type of sources, their orientation, and their aspect ratios.

The following sources can share space on a display simultaneously:

- AirMedia (Windows, Android, Mac, iOS, AirPlay/Miracast)

**NOTE:** The AirMedia extension for Chrome OS is not supported and will only be allowed to present full screen.

- HDMI

**NOTE:** When the AirMedia Canvas feature is enabled, the 4:2:0 color space is used for high definition sources connected to the HDMI input port. When the AirMedia Canvas feature is disabled, the 4:4:4 color space is used. If the 4:4:4 color space is required by sources connected to the HDMI input port, the AirMedia Canvas should be disabled.

When enabled, AirMedia Canvas works as follows:

- If one source is active, the source presents in full screen.
- If multiple sources are active, the sources present in a way that maximizes screen coverage depending on their aspect ratios.
- When multiple sources are active, and all but one of the sources is disconnected, the single source returns to full screen.
- If the maximum amount of sources is reached and another source is selected, then the first active source is docked (AirMedia user) or disconnected (hard wired inputs, AirPlay connection, or Miracast connection). When docked, the source stops presenting but remains connected to the display.
- When all sources are disconnected, the display shows the front of the room experience splash screen.

When AirMedia Canvas is disabled, the display shows one source at a time.

For details on using a touch screen to control AirMedia Canvas, refer to [AirMedia Canvas on page 190](#). For details on using a computer or iOS device to control AirMedia canvas, refer to [Share Content on page 170](#).

## Network Adapter

Select the **Network Adapter** tab to determine the Ethernet ports assigned for use by AirMedia.

### AirMedia Screen - Network Adapter

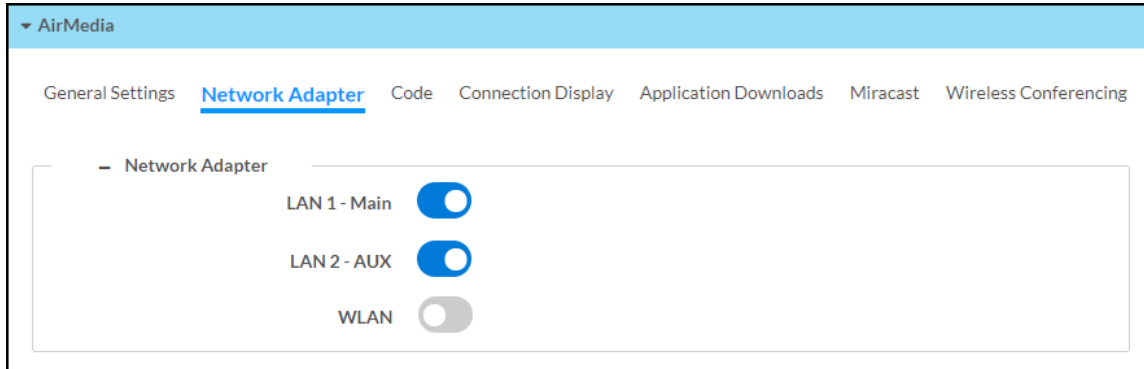

- **LAN 1 - Main:** Turn the toggle on to allow AirMedia connections from the local area network.
- **LAN 2 - AUX:** (AM-3200(-WF)(-I) models only) Turn the toggle on to allow AirMedia connections from a secondary, guest-only local area network. For more information on the second LAN connection, refer to [Dual LAN Functionality \(AM-3200\(-WF\)\(-I\) models only\) on page 135](#).
- **WLAN:** Allow AirMedia connections from the receiver's self hosted Wi-Fi access point (Wi-Fi network enabled models only).

### Dual LAN Functionality (AM-3200(-WF)(-I) models only)

AirMedia Series 3 receivers provide dual LAN connectivity for isolated internal and guest networks. Users may present via AirMedia or connect to the receiver's web configuration interface when connected to either network.

The secondary LAN port is intended solely for use with a guest network. The secondary LAN port has limited functionality and does not support the following devices and services:

- XiO Cloud service
- Crestron Fusion software
- Scheduling services (such as Google Calendar or Microsoft 365 software)
- Occupancy sensors
- Touch screen control
- ChromeOS presentation
- Power over Ethernet

Make LAN connections to the receiver as described in the [AM-3200, AM-3200-WF, and AM-3200-WF-I Quick Start guide](#) (Doc. 8986).

## Code

Select the **Code** tab to configure the access code that must be entered to present content on the AirMedia receiver.



## AirMedia Screen - Code

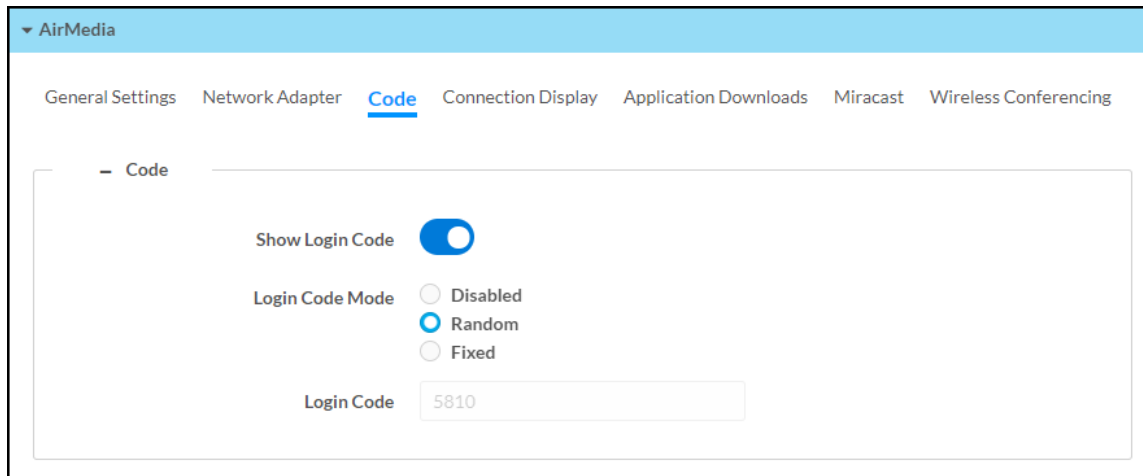

- **Show Login Code:** Turn the toggle on to show the access code on the display device.
- **Login Code Mode:** Select a radio button to specify how the access code is used.
  - **Disabled:** Allows any user with the device's IP address or host name to open a client connection without entering an access code.
  - **Random:** Randomly generates an access code. A new code is generated when the last connected presenter disconnects from the device. The access code is shown on the display device when AirMedia is selected.
  - **Fixed:** Uses a user-specified, four-digit access code. Enter a custom code in the **Login Code** field when **Fixed** is selected.

## Connection Display

Select the **Connection Display** tab to configure how AirMedia connection details are shown on a connected display device.

**NOTE:** For more details on how AirMedia connection details are shown on a display device, refer to [Front of Room Experience on page 167](#).

## AirMedia Screen - Connection Display

— Connection Display

Show AirMedia Connection Info Overlay

Show Apple Screen Mirroring Info

Show Miracast Info

Show Connect Adaptor Info

Primary (LAN) Connection Info

Show Connection Info

Connection URL Mode  IP Address  
 Host  
 Host and Domain  
 Custom

Custom URL \*

Wireless (WLAN) Connection Info

Show Connection Info

Info Mode

Connection Info Mode  IP Address  
 Host  
 Host and Domain  
 Custom

Custom URL \*

- **Show AirMedia Connection Info Overlay:** Turn the toggle on to show connection information on the display device when a user is presenting.
- **Show Airplay Info:** Turn the toggle on to show Airplay connection information on the display.
- **Show Miracast Info:** Turn the toggle on to show Miracast connection information on the display.
- **Show Connect Adaptor Info:** Turn the toggle on to show Connect Adaptor information on the display.
- **LAN Connection Information**
  - **Show Connection Info:** Turn the toggle on to display connection information on the display device.
  - **Connection URL Mode:** Select one of the radio buttons to decide what connection information is shown on the display device.
    - **IP Address:** Show the IP address used to connect to the receiver.
    - **Host:** Show the host name used to connect to the receiver.
    - **Host and Domain:** Show the host name and domain name used to connect to the receiver.
    - **Custom:** Show a custom URL used to connect to the receiver. Enter the custom URL in the **Custom URL** field.

- **Wireless (WLAN) Connection Info:** The receiver can be configured to show Wi-Fi connection information on the display device.
  - **Show Connection Info:** Turn the toggle on to show Wi-Fi connection information on the display device.
  - **WiFi Info Mode:** Select what Wi-Fi network information to show from the drop-down menu.
    - Select **Internal WiFi Access Point** to show the internal access point's connection information on the display device.
    - Select **Specify WiFi Internal Info** to define and show SSID and connection key information on the display device. Turn on the respective toggles to show SSID and connection key information, and enter the SSID and connection key information into the respective fields.
  - **Connection Info Mode:** Select one of the radio buttons to decide what connection information is shown on the display device.
    - **IP Address:** Show the IP address used to connect to the receiver.
    - **Host:** Show the host name used to connect to the receiver.
    - **Host and Domain:** Show the host name and domain name used to connect to the receiver.
    - **Custom:** Show a custom URL used to connect to the receiver. Enter the custom URL in the **Custom URL** field.

## Application Downloads

Select **Application Downloads** to configure how AirMedia client applications are presented to the user for download. Client applications are required to present from a user's computer as described in [Present with AirMedia on page 168](#).

### AirMedia Screen - Application Downloads

The screenshot shows the 'Application Downloads' configuration interface. It features two main sections: 'Windows Download' and 'MacOS Download'. Each section includes three radio button options: 'Off', 'Cloud', and 'Remote Server'. The 'Cloud' option is selected for both. Below each section is a 'Server URL' text input field and a blue 'Update Now' button. At the bottom, there is an 'Application Options' section with a toggle switch for 'Automatically Connect to this Receiver', which is currently turned on.

Select a radio button for the **Windows Download** and **MacOS Download** settings to decide how AirMedia client applications are presented to users according to their computer's operating system:

- **Off:** Provide the version of the AirMedia application included with the receiver's firmware.
- **Cloud:** Provide the latest version of the AirMedia application stored in the Cloud. The receiver checks for an update once a day at 2:00 am (local time).
- **Remote Server:** Provide a version of the AirMedia application that is hosted on a remote server. When selected, enter the URL of the remote server in the **Server URL** field.
- **Update Now:** Update the AirMedia application according to the **Windows Download** or **MacOS Download** setting.

**NOTE:** If the setting is changed from **Cloud** or **Remote Server** to **Off**, the receiver will provide the application version that is included with the device's firmware (even if it is an older version than what is available in the cloud or the remote server).

- **Automatically Connect to this Receiver:** When enabled, the AirMedia receiver's IP address is appended to the application download for automatic connection. When disabled, the standard guest AirMedia application is downloaded. Enabling automatic connection makes it easy for users to present to the specific receiver quickly. Certain organizations may elect to download the guest application so that users can launch it again later to connect to different receivers.

## Miracast

Miracast technology allows users to wirelessly share content from a Microsoft® Windows® 10 device to the receiver. Miracast technology is built into the Microsoft Windows 10 operating system, so no additional software installation is required.

**NOTE:** Refer to the [AirMedia Presentation Gateway Security Reference Guide](#) (Doc 7693) for best practices for configuring the system for Miracast.

A Miracast connection consists of two phases: the discovery phase and the connection phase. During the discovery phase, the Windows 10 device uses Wi-Fi based discovery to find compatible receivers. Once the receiver is discovered by the Windows 10 device, it is presented in a list on the device. The user can then select the receiver for connection to the Windows 10 device.

During the connection phase, the Windows 10 device will first attempt to connect to the receiver through the existing network infrastructure. If the connection over infrastructure fails, the Windows 10 device will connect to the receiver.

### AirMedia Screen - Miracast

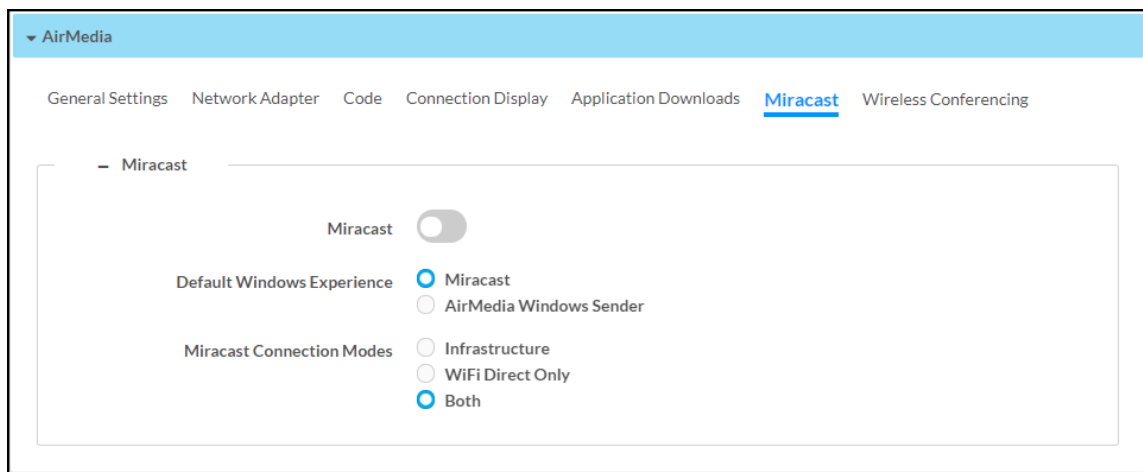

- **Miracast:** Turn the toggle on to enable Miracast on the receiver.
- **Default Windows Experience:** Select one of the radio buttons (**Miracast** or **AirMedia Windows Sender**) to select the default connection experience for Windows 10 users when they connect to the receiver via a web browser.
  - Select **Miracast** to display instructions for connecting to the receiver via Miracast.
  - Select **AirMedia Windows Sender** to prompt the user to download the AirMedia sender application.

- **Miracast Connection Modes:** Select one of the radio buttons (**Infrastructure**, **WiFi Direct Only**, or **Both**) to configure how a Miracast capable device connects to the receiver.
  - Select **Infrastructure** to connect via the local area network. When selected, Wi-Fi is used for discovery only.
  - Select **WiFi Direct Only** to connect via a Wi-Fi point-to-point connection (Wi-Fi Direct® connection). When selected, Wi-Fi is used for discovery and for streaming.
  - Select **Both** to connect via a local area network or Wi-Fi point-to-point connection (Wi-Fi Direct® connection). When selected, a Wi-Fi point-to-point connection only occurs if the local area connection fails.

**NOTE:** When **WiFi Direct Only** or **Both** is selected, **Login Code Mode** must be set to **Random** or **Fixed** as described in [Code on page 135](#).

## Connect Devices

AirMedia Connect devices can be connected to personal devices to instantly share content with a paired Wi-Fi network capable AirMedia receiver. Select **Connect Devices** to configure settings and pair Connect devices. Up to eight Connect devices can be paired to a single receiver. Information about operating the Connect devices can be found in [AirMedia Connect Devices on page 194](#).

### AirMedia Screen - Connect Devices

ⓘ	Nickname	Model Number	Status	State	Serial Number	MAC Address	Firmware Version	Signal	Delete
ⓘ	AirMedia TX3-00107ff9103b	AM-TX3-100	Online / Presenting & Conferencing	▶	2115GSP00081	00:10:7f:f9:10:3b	1.0.0.130	📶	🗑️

- **Local Pairing:** Turn the toggle on to enable pairing without the web configuration. To initiate the pairing process locally, press and hold the **SETUP** button on the AirMedia receiver for five seconds.
- **Pairing Status:** Indicates the current status of a pairing attempt.
- **Pair Devices:** Initiate the pairing process.

- **Connect Behavior:** Using the drop-down menu, select the automatic behavior of Connect devices.
  - **Auto-Present:** Automatically present.
  - **Auto-Present and Auto-Conference:** Automatically present and initiate Wireless Conferencing.

#### NOTES:

- After clicking **Pair Devices**, the pairing process must also be initiated on the Connect device:
  - **AM-TX3-100(-I):** Press and hold the **Screenshare** button for five seconds. The LED ring will turn white. When pairing begins, the LED will alternate between red and white.
- If the Connect device is already paired to another AirMedia receiver, it must be restored before pairing again. For more information, refer to [Restoring the Device on page 196](#).

Paired Connect devices appear in the table:

- **Nick Name:** Friendly name for the Connect device
- **Model Number:** Model of the Connect device
- **Status:** Indicates if the Connect device is currently online or offline or a firmware update is in process.
- **State:** The icon indicates if the Connect device is ready to share. A green check mark indicates the device is online and operational. A red X indicates the device is offline.
- **Serial Number:** Displays the serial number of the Connect device
- **MAC Address:** MAC Address of the Connect device
- **Firmware Version:** Firmware version of the Connect device
- **Signal:** Signal strength between the Connect device and receiver
- **Actions:** Select **Delete** to unpair the Connect device. This also resets the Connect device to factory default.

To update firmware on a paired Connect device, use [Auto Update on page 108](#) or follow the procedure below.

**NOTE:** Updating firmware of an AirMedia Connect device requires it to be online with a strong wireless connection, and not currently presenting.

1. In the table, select the checkbox next to the Connect device.
2. Click the blue **Upload Firmware** button.

3. Select **Browse**, and then navigate to the firmware file on the host computer.

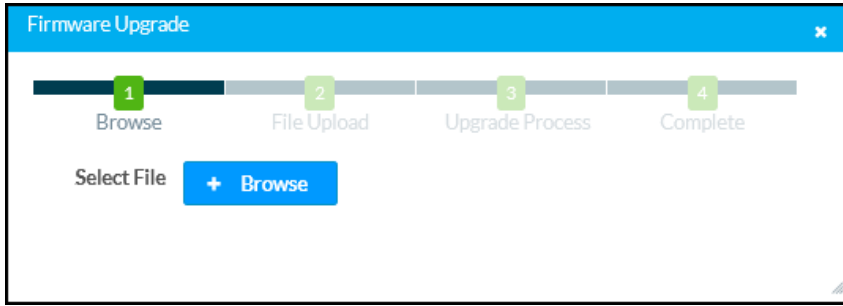

4. Select the firmware file, and then select **Open**.
5. Select **Load** to load the file to the receiver. The upload progress is shown in the dialog box and in the Connect device status menu.
6. Once the file upload has completed, select **OK**.

Select the **Cancel** button to close the **Firmware Upgrade** dialog box. Selecting the **Cancel** button before the file is uploaded to the device cancels the update.

## Wireless Conferencing

Select **Wireless Conferencing** to configure settings for the Wireless Conferencing feature. Wireless Conferencing allows the receiver to use connected conferencing peripherals, such as soundbars, cameras, or speakerphones when the user makes a call from a meeting room application.

For a list of peripherals supported with Wireless Conferencing, refer to [Online Help 1001764](#).

### AirMedia Screen - Wireless Conferencing

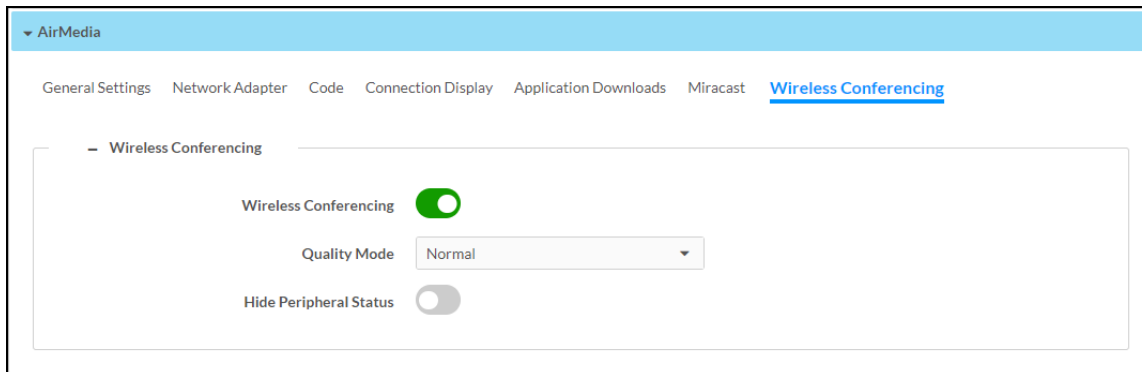

- **Wireless Conferencing:** Turn the toggle on to enable Wireless Conferencing on the receiver. PoE+ or a local power supply is required to enable Wireless Conferencing.
- **Quality Mode:** Select the video quality of a connected camera from the drop-down menu.
  - Select **Normal** to display the standard video quality of the camera.
  - Select **Low** to display a lowered level of video quality. **Low** should only be selected if there are network bandwidth concerns that arise when **Normal** is selected.
- **Hide Peripheral Status:** Turn the toggle on to hide the peripheral status from the display when Wireless Conferencing is in use.



For more information on Wireless Conferencing, refer to the [AirMedia Presentation Gateway Security Reference Guide](#) (Doc 7693).

## Security

Select **Security** to configure device security and authentication settings.

### Security – Authentication Management

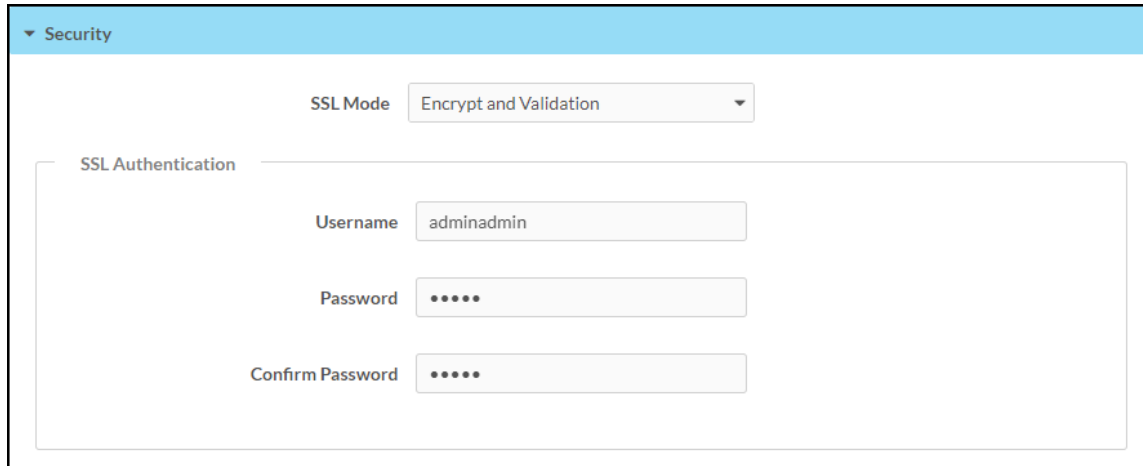

The screenshot shows the 'Security' configuration page. At the top, there is a 'Security' header with a dropdown arrow. Below it, the 'SSL Mode' is set to 'Encrypt and Validation'. Underneath, there is a section titled 'SSL Authentication' which contains three input fields: 'Username' with the value 'adminadmin', 'Password' with masked characters, and 'Confirm Password' with masked characters.

- **SSL Mode:** Select an SSL (Secure Sockets Layer) mode to use for establishing a secure connection between the receiver and the control system:
  - **Encrypt and Validation:** The receiver will require a username and password to validate an encrypted SSL connection. Enter a username and password in the respective fields.
  - **Encrypt:** The receiver will use an encrypted SSL connection.
  - **OFF:** The receiver will not use an SSL connection

## Authentication

By default, authentication is required to access the web configuration interface or to connect to an AirMedia Series 3 receiver through Crestron Toolbox™ software. When a user attempts to sign into the device for the first time, the web configuration interface prompts the user to enter a new administrator username and password as described in [Connect to the Receiver on page 77](#). This username and password will be saved and must be entered when reconnecting to the receiver in the future.

**CAUTION:** Do not lose the administrator username and password, as the receiver settings must be restored to factory defaults to reset the username and password. To restore the device to factory defaults, refer to [Restore on page 81](#).

Use the following **Authentication Management** settings to add, delete, and edit users and groups.

### Current User

Select **Current User** to view and edit information for the current receiver user.

## Authentication Management - Current User

The screenshot shows a web interface with a dark header containing three tabs: 'Current User', 'Users', and 'Groups'. The 'Current User' tab is active. Below the header, the following settings are displayed:

- Name: adminadmin
- Access Level: Administrator
- Active Directory User: No
- Groups: Administrators

At the bottom of the settings area, there is a blue button labeled 'Change Current User Password'.

The following settings are displayed for the current user:

- **Name:** The chosen username
- **Access Level:** The access level granted to the user (**Administrator**, **Connect**, **Operator**, **Programmer**, or **User**)
- **Active Directory User:** Reports whether the current user is (**Yes**) or is not (**No**) authenticated through Active Directory® software

**NOTE:** A user must be added to an Active Directory group before the user may be selected as an active directory user. For more information, refer to [Groups on page 147](#).

- **Groups:** Any groups of which the current user is a member

Select **Change Current User Password** to change the password for the current user. The **Change Password** dialog box is displayed.

### Change Password Dialog Box

The dialog box has a blue title bar with the text 'Change Password' and a close button (X). It contains three text input fields:

- Current Password:** The first field is empty. Below it is a red error message: 'Current Password cannot be empty'.
- Password:** The second field is empty. Below it is a red error message: 'Password cannot be less than 8 characters'.
- Confirm Password:** The third field is empty.

At the bottom of the dialog box, there are two buttons: a light blue 'OK' button with a checkmark icon and a blue 'Cancel' button with an X icon.

Enter the existing password in the **Current Password** field. Then, enter a new password in the **Password** field, and reenter the password in the **Confirm Password** field.

Select **OK** to save the new password, or select **Cancel** to cancel the change.

## Users

Select **Users** to view and edit information for the receiver users.

### Authentication Management - Users

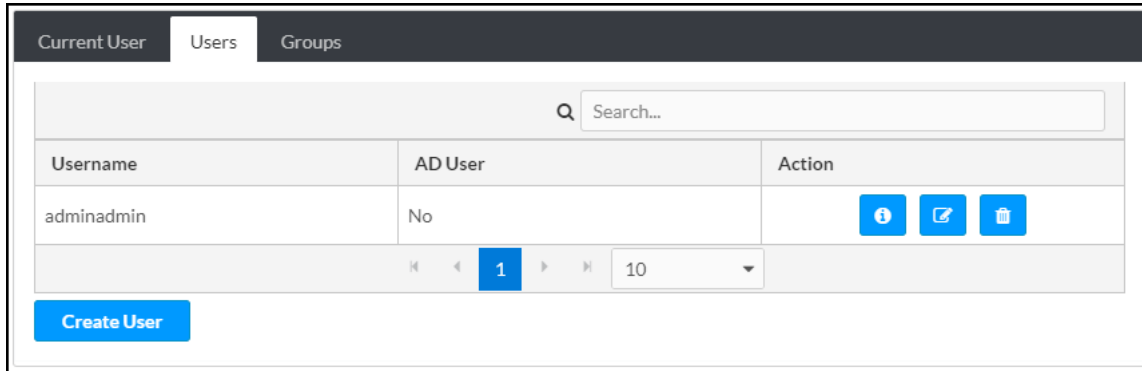

Enter text into the **Search...** field to find and display users that match the search term(s).



Receiver users are listed in table format. The following information is displayed for each user:

- **Username:** The chosen username
- **AD User:** Reports whether the user is (**Yes**) or is not (**No**) authenticated through Active Directory

**NOTE:** A user must be added to an Active Directory group before the user may be selected as an Active Directory user. For more information, refer to [Groups on page 147](#).

If the receiver users span multiple pages, use the navigation arrows on the bottom of the page to move forward or backward through the pages, or select a page number to navigate to that page.

An **Action** column is also provided for each user that allows various actions to be performed. The following selections may be selected from the **Action** column:

- Select the information button  to view a user's username, Active Directory status, and group membership.
- Select the edit button  to edit a user's password and group membership.
- Select the trashcan button  to delete a user.

### Create User

Select **Create User** to create a new user. The **Create User** dialog box is displayed.

## Create User Dialog Box

The screenshot shows a 'Create User' dialog box with the following elements:

- Name:** An empty text input field with a red error message below it: "Username cannot be empty".
- Active Directory User:** A toggle switch that is currently turned off.
- Password:** An empty text input field with a red error message below it: "Password cannot be less than 8 characters".
- Confirm Password:** An empty text input field with a red error message below it: "Group Must be selected".
- Groups:** A dropdown menu with "Choose" selected. A red error message below it says: "Group Must be selected".
- Buttons:** "OK" and "Cancel" buttons at the bottom right.

- **Name:** The chosen username
- **Active Directory User:** Turn on the toggle to use authentication via Active Directory for the selected user.
- **Password:** Enter a new password for the selected user.
- **Confirm Password:** Reenter the password provided in the **Password** field.
- **Groups:** Add the user to one or more groups. For more information, refer to [Groups on page 147](#).

**NOTE:** A user must be added to an Active Directory group to be selected as an Active Directory user.

Select **OK** to save any changes and to return to the **Authentication Management > Users** page. Select **Cancel** to cancel any changes.

## Groups

Select **Groups** to view and edit settings for receiver groups. Receiver groups are used to group users by access level and Active Directory authentication settings.

## Authentication Management - Groups

Group Name	AD Group	Access Level	Action
Administrators	No	Administrator	
Connects	No	Connect	
Operators	No	Operator	
Programmers	No	Programmer	
Users	No	User	

Enter text into the **Search...** field to find and display groups that match the search term(s).

Groups are listed in table format. The following information is displayed for each group:

- **Group Name:** The chosen username
- **AD Group:** Reports whether the group is (**Yes**) or is not (**No**) authenticated through Active Directory
- **Access Level:** The access level granted to the user (**Administrator**, **Connect**, **Operator**, **Programmer**, or **User**)

If the receiver groups span multiple pages, use the navigation arrows on the bottom of the page to move forward or backward through the pages, or select a page number to navigate to that page.

An **Action** column is also provided for each group that allows various actions to be performed. The following selections may be selected from the **Action** column:

- Select the information button to view a group's name, access level, and Active Directory status.
- Select the trashcan button to delete a user.

### Create Group

Select **Create Group** at the bottom of the page to create a new receiver group. The **Create Group** dialog box is displayed.

## Create Group Dialog Box

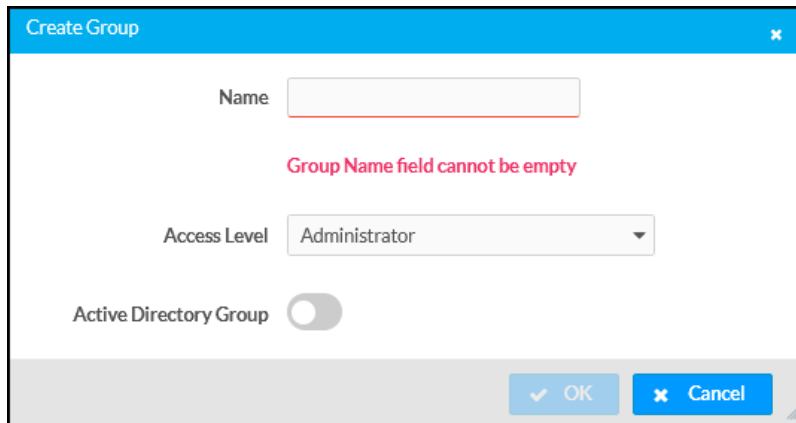

The screenshot shows a 'Create Group' dialog box with the following elements:

- Name:** An empty text input field with a red error message below it: "Group Name field cannot be empty".
- Access Level:** A dropdown menu currently set to "Administrator".
- Active Directory Group:** A toggle switch that is currently turned off.
- Buttons:** "OK" and "Cancel" buttons at the bottom right.

The following **Create Group** settings may be viewed or configured:

- **Name:** Enter a group name
- **Access Level:** Select an access level for the group and its users from the drop-down menu
- **Active Directory Group:** Turn on the toggle to use authentication via Active directory for the group

Select **OK** to save any changes and to return to the **Authentication Management > Groups** page. Select **Cancel** to cancel any changes.

# 802.1x Configuration

Select **802.1x Configuration** to display selections for configuring IEEE 802.1x network authentication for receiver security.

## 802.1x Configuration Tab Selections

The screenshot displays the '802.1x Configuration' tab. At the top, there is a toggle for 'IEEE 802.1x Authentication' which is turned on. Below this is a dropdown menu for 'Authentication Method' currently set to 'EAP-TLS Certificate'. Underneath are three input fields for 'Domain', 'Username', and 'Password'. Further down is another toggle for 'Enable Authentication Server Validation' which is turned off. At the bottom, there is a section for 'Select Trusted Certificate Authority(s)' with a search bar and a list of CA options, each with a checkbox. The list includes: AAA Certificate Services, AC RAIZ FNMT-RCM, ACCVRAIZ1, Actalis Authentication Root CA, AffirmTrust Commercial, AffirmTrust Networking, AffirmTrust Premium ECC, AffirmTrust Premium, Amazon Root CA 1, Amazon Root CA 2, and Amazon Root CA 3.

- **IEEE 802.1x Authentication:** Turn on the toggle to use 802.1x authentication for the receiver.
- **Authentication Method:** Select an 802.1x authentication method (**EAP-TLS Certificate** or **EAP MSCHAP V2- password**) from the drop-down menu.
- **Domain:** If **EAP MSCHAP V2- password** is selected for **Authentication Method**, enter a domain name for authentication.
- **Username:** If **EAP MSCHAP V2- password** is selected for **Authentication Method**, enter a username for authentication.
- **Password:** If **EAP MSCHAP V2- password** is selected for **Authentication Method**, enter a password for authentication.
- **Enable Authentication Server Validation:** Turn on the toggle to use server validation for elevated security.
- **Select Trusted Certificate Authorities:** Select trusted CAs (Certificate Authorities) from the provided CAs to be used for server validation:
  - Select the corresponding check box for each CA that you wish to make a trusted CA.
  - Enter a search term into the text field to search for and display CAs that match the search term.
  - Select the check box in the search field to select all CAs as trusted CAs.

Select **Manage Certificates** from the **Action** menu to add or remove CAs from the list. The **Manage Certificates** dialog box is displayed with the **Root** tab selected.

#### Manage Certificates Dialog Box - Root Tab

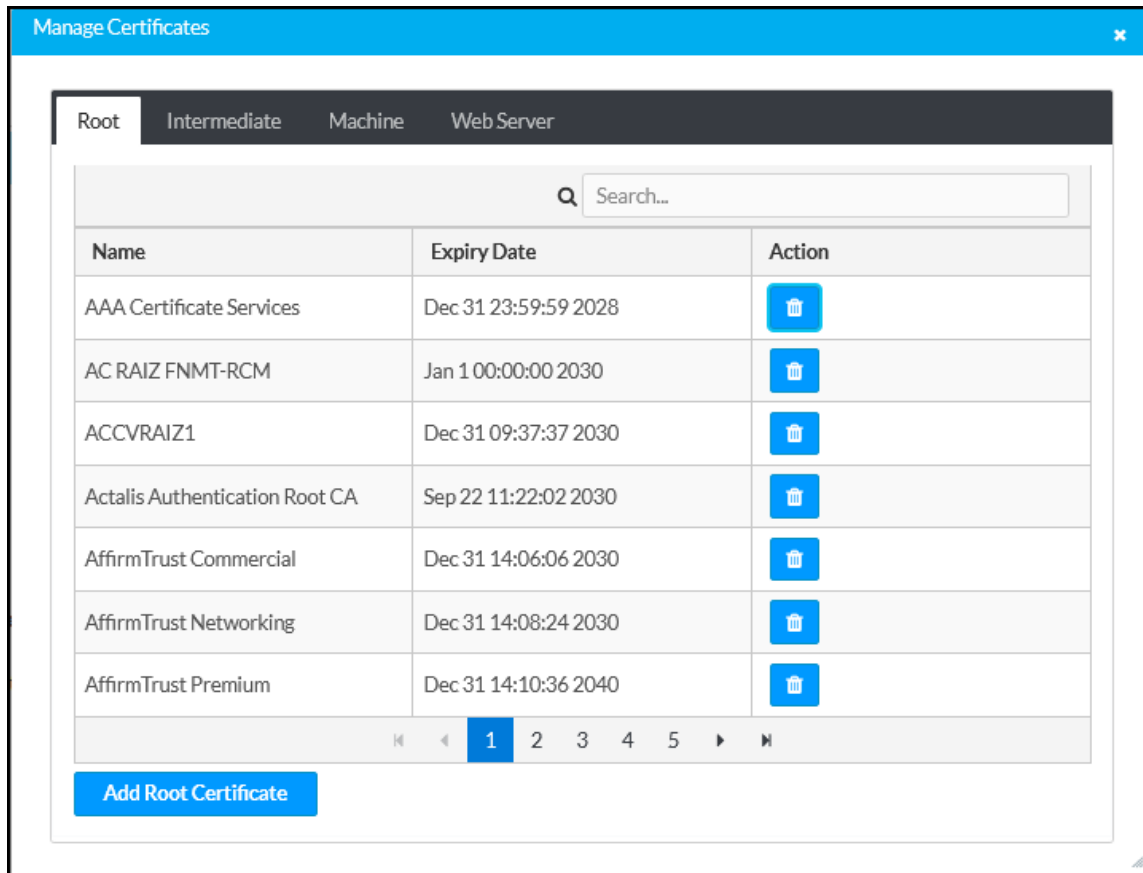

Select **Root**, **Intermediate**, **Machine**, or **Web Server** to switch between the different types of CAs. The same settings are provided for each type of CA.

Enter a search term into the **Search...** text field to search for and display CAs that match the search term.

The following information is provided for each type of CA:

- **Name:** The CA name
- **Expiry Date:** The date and time that the CA is set to expire

If the CAs span multiple pages, use the navigation arrows on the bottom of the page to move forward or backward through the pages, or select a page number to navigate to that page.

Select the trashcan button in the **Action** column for a CA to delete it. Select **Yes** to delete the certificate or **No** to cancel.

Select **Add [Type] Certificate** to add a CA of one of the four available types (**Root**, **Intermediate**, **Machine**, or **Web Server**) to the list of CAs. The **Add Certificate** pop-up dialog box is displayed.



## Add Certificate Dialog Box – Browse

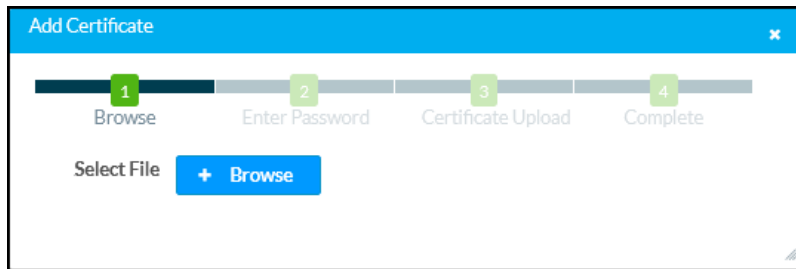

To add a new certificate:

1. Select **Browse**.
2. Navigate to the CA file on the host computer.
3. Select the CA file, and then select **Open**.
4. If required, enter the password used to encrypt the file.
5. Select **Load** to load the CA file to the receiver. The upload progress is shown in the dialog box.
6. Once the receiver has completed the upload, select **OK**.

Select the **x** button to close the **Add Certificate** dialog box at any time during the upload process. Selecting the **x** button before the CA file is uploaded to the touch screen cancels the upload.

Select the **x** button to close the **Manage Certificates** dialog box and to return to the **802.1x Authentication** page.

# Enterprise Deployment Options

Crestron has two options for deploying multiple AirMedia receivers across an enterprise. These tools can assist in deploying any number of receivers that an organization may need to deploy.

## XiO Cloud® Service

The [XiO Cloud® service](#) allows supported devices across an enterprise to be managed and configured from one central and secure location in the cloud. Supported Crestron® devices are configured to connect to the service out of the box.

Use of the service requires a registered XiO Cloud account. To register for an XiO Cloud account, refer to [www.crestron.com/Support/Tools/Licensing-Registration/XiO-Cloud-Registration-Room-Licenses](http://www.crestron.com/Support/Tools/Licensing-Registration/XiO-Cloud-Registration-Room-Licenses).

**NOTE:** The device may be disconnected from the XiO Cloud service by navigating to the **Cloud Services** tab in Crestron Toolbox™ software (**Functions > Device Info > Cloud Services**). For details, refer to the Crestron Toolbox help file.

To connect the device to the XiO Cloud service:

1. Record the MAC address and serial number that are labeled on the shipping box or the device. The MAC address and serial number are required to add the device to the XiO Cloud service.

**NOTE:** If the device has multiple MAC addresses, use the MAC address that is providing the primary connection back to the network. For most devices, the Ethernet MAC address should be used. However, if your device is connecting to the network over a different protocol (such as Wi-Fi® communications), use the MAC address for that protocol instead.

2. Log in to your XiO Cloud account at [portal.crestron.io](https://portal.crestron.io).
3. Claim the device to the XiO Cloud service as described in the [XiO Cloud User Guide](#).

Select the device from the cloud interface to view its status and settings. The device may now also be managed and assigned to a group or room. For more information, refer to the [XiO Cloud User Guide](#).

**NOTE:** For XiO Cloud accounts with room-based licenses, the device must be added to a licensed room before its status and settings can be viewed.

## Crestron Deployment Tool for PowerShell® Software

Crestron has developed a tool for customers without the ability to use CPS to assist in deploying multiple devices without the need to configure each device individually. With this tool, an administrator has the ability to input all of the settings to be configured on multiple receivers, and then use PowerShell® task-based command-line shell and scripting language to configure the devices across a local network.

## Modern Authentication for EWS

This appendix provides the procedures required to configure Modern Authentication (OAuth 2) support for AirMedia series 3 receivers in the Microsoft® EWS (Exchange Web Services) service.

The Modern Authentication authorization model is provided by the Azure® Active Directory® service to integrate managed API applications with the same authentication model used by the Microsoft 365 software REST APIs. Once Modern Authentication is configured in EWS, the AirMedia receiver uses this access method to provide heightened user authentication.

Use the following procedures to define a new application in Azure Active Directory. Once the application is defined, multiple Crestron devices can leverage calendar integration with Microsoft 365 and Modern Authentication without additional setup in the Microsoft EWS service.

# Create the Application

1. Sign into the Azure portal with a user ID with sufficient permissions to create an app.
2. Select **Azure Active Directory** from the navigation menu.

## Azure Active Directory Selection

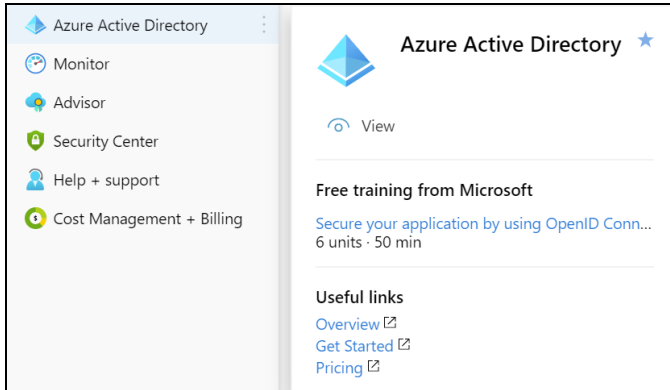

3. Select **App registrations** from the Azure widget menu.

### App registrations Selection

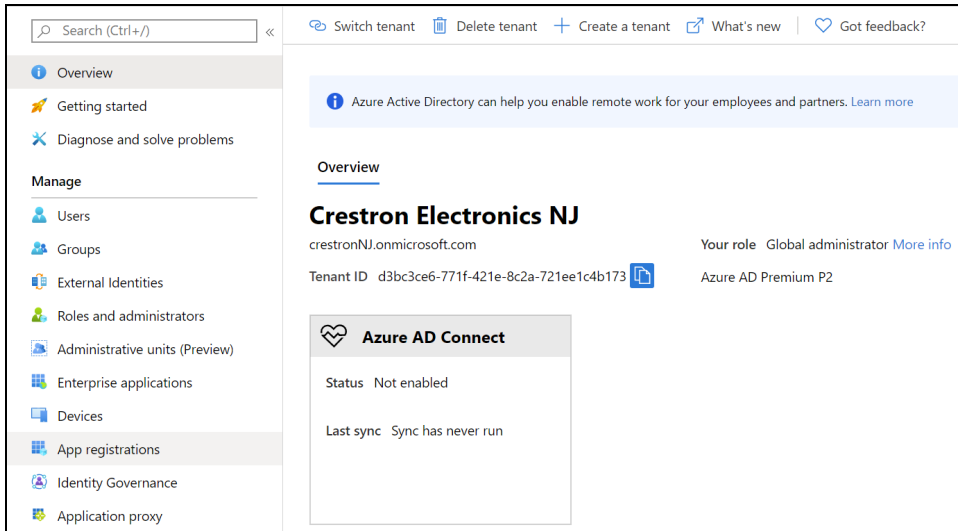

4. Select **+ New registration**.

### App registrations - New registration Screen

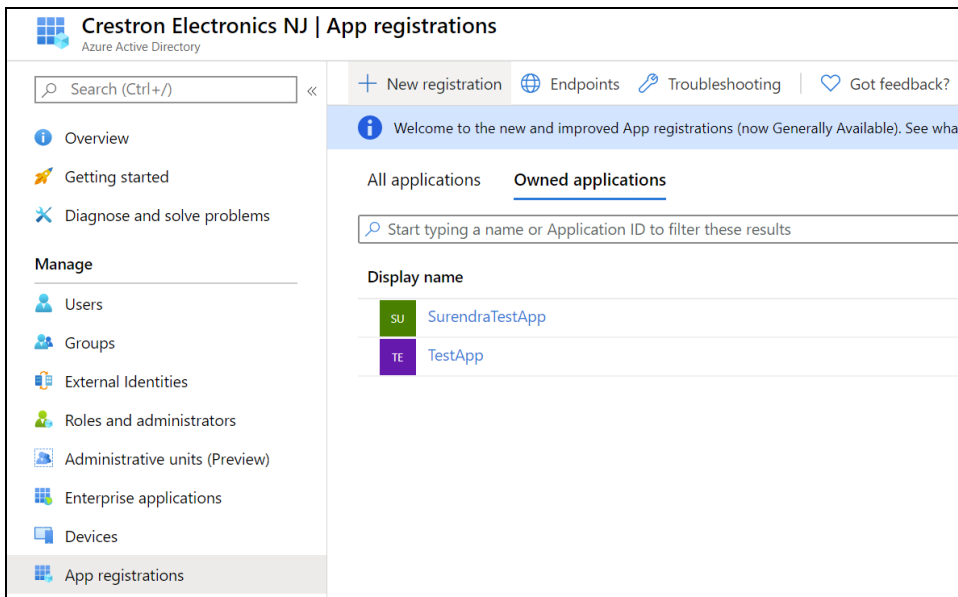

A dialog box for creating the app is displayed.

### Register an application Dialog Box

Home > Crestron Electronics NJ | App registrations > Register an application

#### Register an application

**\* Name**  
The user-facing display name for this application (this can be changed later).

Crestron Scheduling Device ✓

**Supported account types**  
Who can use this application or access this API?

Accounts in this organizational directory only (Crestron Electronics NJ only - Single tenant)  
 Accounts in any organizational directory (Any Azure AD directory - Multitenant)  
 Accounts in any organizational directory (Any Azure AD directory - Multitenant) and personal Microsoft accounts (e.g. Skype, Xbox)

[Help me choose...](#)

**Redirect URI (optional)**  
We'll return the authentication response to this URI after successfully authenticating the user. Providing this now is optional and it can be changed later, but a value is required for most authentication scenarios.

Web ▼ e.g. https://myapp.com/auth

5. Enter the following information:

- **Name:** Enter a user-facing name of the application (in the Azure environment). This can be any string 120 characters or less. It is possible to have more than one application registered with the same display name.
- **Supported account types:** Select the supported account type. Only the **Accounts in this organizational directory only** option is supported by the AirMedia receiver at this time.

**NOTE:** The **Redirect URI (optional)** settings are not configured for this application.

6. Select **Register**.

# Obtain Authentication IDs

Once the app is registered, the application and directory IDs must be obtained to connect the receiver to the Azure AD app.

1. Select **App registrations** from the Azure widget menu.
2. Select the application created for the receiver. An application dialog box is displayed.
3. Select **Overview** from the navigation menu. Information about the Azure app is provided.

## Application Overview Screen

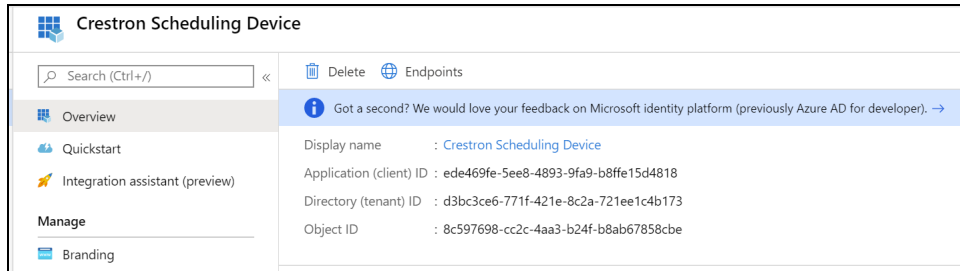

4. Copy the following fields from the **Overview** pane to an accessible location. Use the **Copy to Clipboard** button that appears when hovering over each field to ensure accuracy.
  - **Application (client) ID:** The unique identification string for the Azure app.
  - **Directory (tenant) ID:** The unique identification string for the Azure directory.

# Configure Additional Settings

The following additional settings can be configured for the Azure app. These settings define the user consent experience, authentication details, and API access scopes available to the application.

## Branding

Select **Branding** under the **Manage** section of the application navigation menu to configure branding settings for the app.

### Application Branding Screen

Home > Crestron Electronics NJ | App registrations > Crestron Scheduling Device | Branding

### Crestron Scheduling Device | Branding

Search (Ctrl+/) Save Discard

- Overview
- Quickstart
- Integration assistant (preview)
- Manage**
  - Branding**
  - Authentication
  - Certificates & secrets
  - Token configuration
  - API permissions
  - Expose an API
  - Owners
  - Roles and administrators (Previ...
  - Manifest
- Support + Troubleshooting
  - Troubleshooting
  - New support request

Name \*

Logo 

Upload new logo  

Home page URL

Terms of service URL

Privacy statement URL

Publisher domain  [Update domain](#)

The application's consent screen will show 'Unverified'.  
[Learn more about publisher domain](#)

**Publisher verification (preview)**

Associate a verified Microsoft Partner Center (MPN) account with your application. A verified badge will appear in various places, including the application consent screen. [Learn more](#)

MPN ID

**Add MPN ID to verify publisher**

**i** The application publisher domain is set to crestronNJ.onmicrosoft.com, but onmicrosoft.com publisher domains are not allowed. Please use a custom domain in order to proceed. Note: this domain must be a DNS verified domain on the tenant and match the primary contact domain for your MPN account.

Publisher display name

The following branding settings can be configured for the application:

- **Name: Required.** Set the user-friendly name of the application. This is the same name that was defined when registering the application, but it can be changed here.
- **Upload New Logo:** Set a user-facing logo for this application that appears on the consent screen. The image file for the logo must meet the following requirements:
  - Image dimensions of 215 x 215 pixels
  - Central image dimensions of 94 x 94 pixels
  - Uses the file type .bmp, .jpg, or .png
  - File size less than 100 KB
- **Privacy statement URL:** Provides a link to the application privacy statement in the consent screen.
- **Publisher domain:** Sets the process that must be completed to verify ownership of the domain. Most users will probably already have a verified domain. If the domain is not verified, the application will work, but the consent screen will warn the user they are consenting to an unverified application.



# Authentication

Select **Authentication** under the **Manage** section of the application navigation menu to configure authentication settings for the app.

## Application Authentication Screen

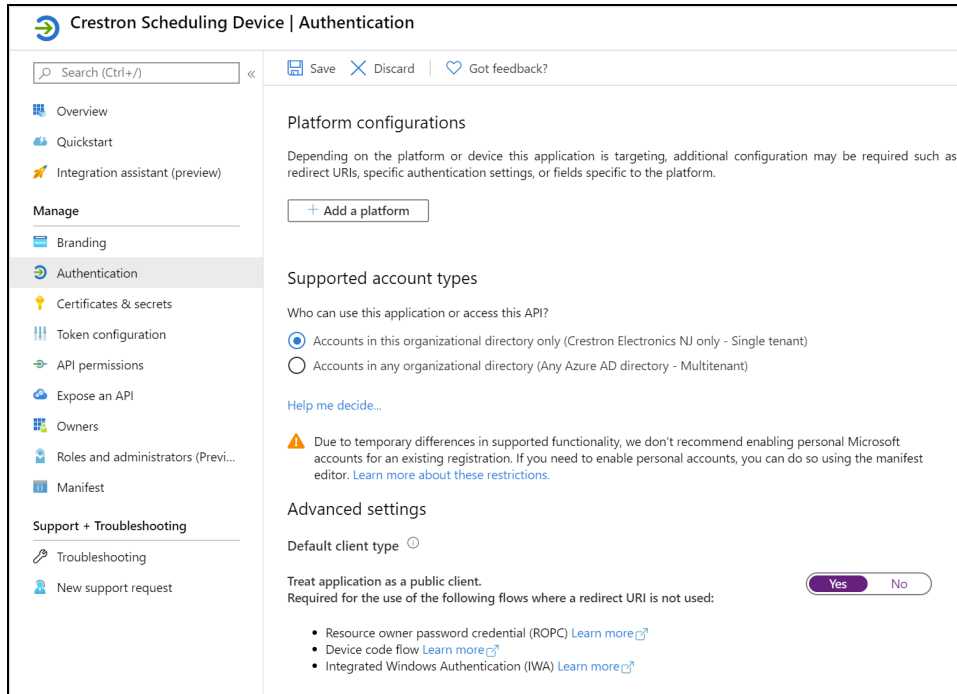

The following authentication settings can be configured for the application:

- **+ Add a Platform:** Select this button to create a platform for app authentication. The **Configure platforms** pane is displayed on the right side of the screen.

## Configure platforms Pane

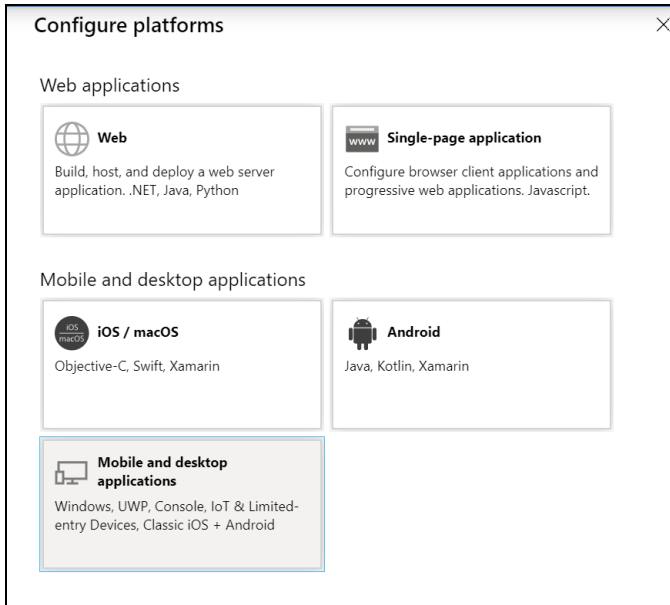

Select **Mobile and desktop applications** to display settings for configuring this platform.

## Configure Desktop + devices Pane

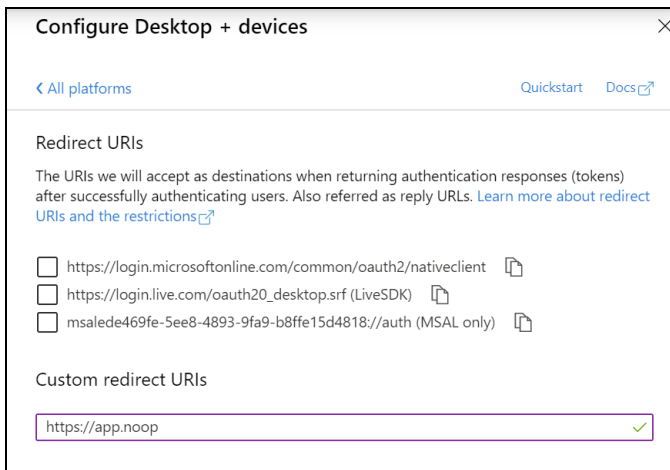

Azure AD requires the use of a redirect URI, but the AirMedia receiver does not. Enter a valid URI address and select **Configure**.

- **Supported account types:** Select an account type for the app. This setting is the same as the one set when registering the app and should not change from **Accounts in this organizational directory only**.
- **Default Client Type:** The **Treat application as a public client** toggle must be set to enabled.

# API Permissions

Select **API Permissions** under the **Manage** section of the application navigation menu to configure API permissions for the app.

## API Permissions Screen

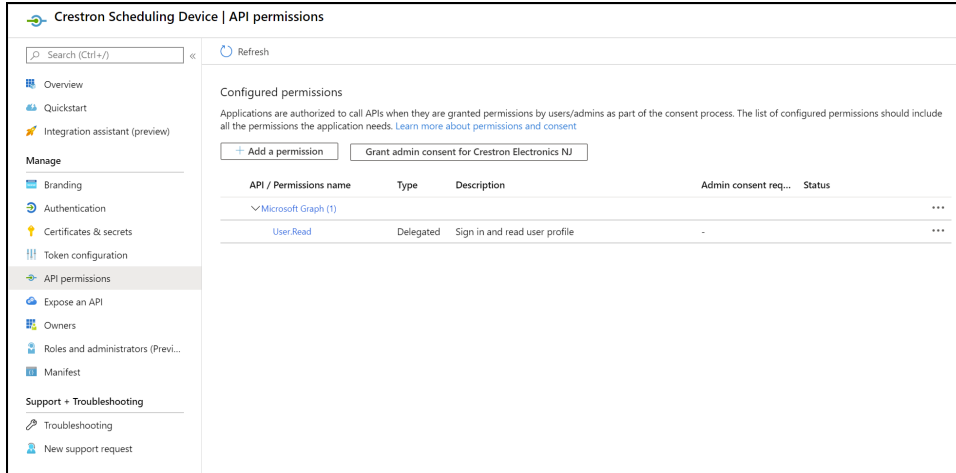

The following API permissions settings can be configured for the application:

Select **+ Add a Permission** to create a new API permission for the app. The **Request API permissions** pane is displayed on the right side of the screen.

## Request API permissions Pane

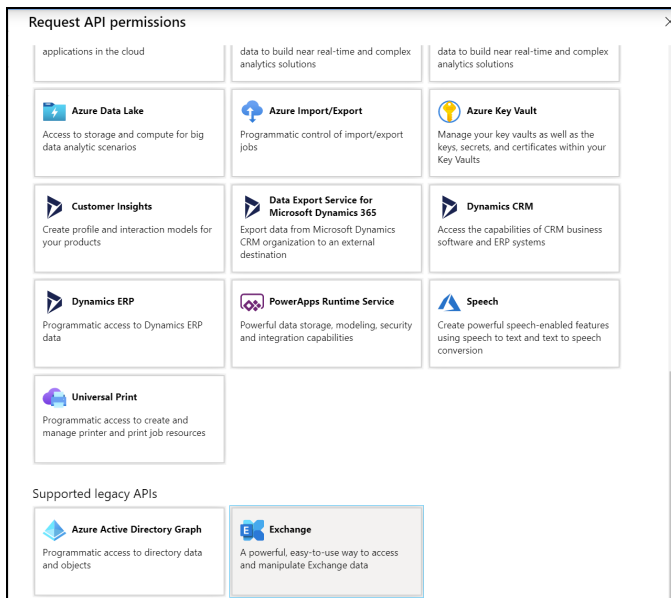

To set the API permissions for EWS:

1. Select **Exchange** to display a list of permissions for EWS.

### Request API permissions Pane - Exchange

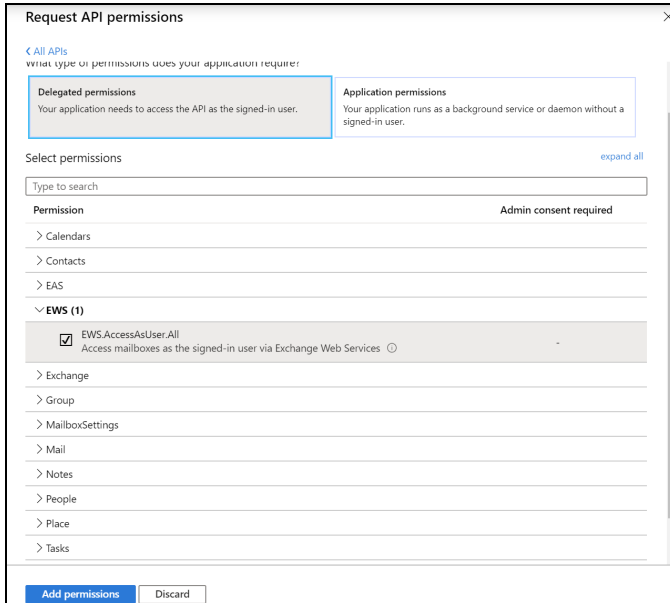

2. Expand the EWS accordion.
3. Fill the checkbox next to **EWS.AccessAsUser.All** to allow the application to make requests to the Exchange Web Services API on behalf of the configured user.

To set the API permissions for the Microsoft® Graph function:

1. Select **Microsoft Graph** to display a list of permissions for Microsoft Graph.

### Request API permissions Pane - Microsoft Graph

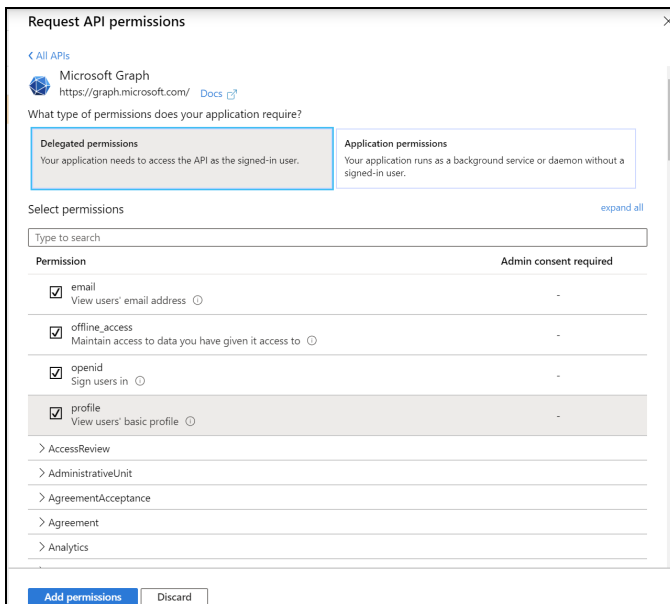

2. Fill the checkboxes next to the following settings to enable the functionality described below:

- **offline\_access:** Allows the application to receive a Refresh Token, which can be exchanged for a new Access Token, when it expires. This is required for long running applications, so user consent is not required each time an access token expires.
- **openid:** Allows the application to receive an ID Token, which provides basic profile information about the authenticated user. This scope is required for the next two scopes, as they are delivered in the ID Token.
- **email:** Provides the email address of the authenticated user. The application uses this to get the calendar address if none is entered during device configuration.
- **profile:** Provides basic profile information about the authenticated user, such as the display name and photo URL.

If the Microsoft Graph **User.Read** scope is added automatically, it can be removed. If there is a warning, it can be ignored.

### API Permissions Screen - User.Read Scope

Permission	Consent type	Description	State	Actions
EWS.AccessAsUser.All	Delegated	Access mailboxes as the signed-in user via Exchange W...	-	...
Microsoft Graph (5)				
email	Delegated	View users' email address	-	...
offline_access	Delegated	Maintain access to data you have given it access to	-	...
openid	Delegated	Sign users in	-	...
profile	Delegated	View users' basic profile	-	...
User.Read	Delegated	Sign in and read user profile	-	...

# Perform a Factory Restore

If an AirMedia Series 3 Receiver must be restored to its factory default settings, perform the following recovery procedure.

**CAUTION:** Performing a factory restore returns all settings to their default values and removes any network configurations, IP table entries, images, and paired devices.

**NOTE:** The following procedure is valid for devices running firmware version 3.04 or later. For instructions on restoring devices running older firmware, refer to [OLH 1000218](#).

1. After the device has fully booted up, press and hold the **RESET** button for ten seconds. A Device Recovery message will appear on the front of room display and the **SETUP** LED will blink rapidly. If the next step is not executed within one minute, the procedure will be canceled.
2. Restore the device by pressing and holding the **SETUP** button for five seconds.

After a few minutes, the device will be restored to its factory default settings.

# Operation

To present content, use one of the following methods:

- AirMedia wireless presentation. Refer to [Present with AirMedia on page 168](#).
- Wireless presentation with an AirMedia Connect Device. Refer to [AirMedia Connect Devices on page 194](#).
- Connect a device to the HDMI INPUT port (AM-3200(-WF)(-I) models only).

For a description of the receiver's front of room experience, refer to [Front of Room Experience on page 167](#).

For instructions on using AirMedia wireless presentation, refer to [Present with AirMedia on page 168](#).

Optionally, a TS- or TSW- 70 series 7 in. or 10 in. touch screen (sold separately) can be used to control the receiver and select which sources are displayed. For instructions on using a touch screen, refer to [Touch Screen Operation on page 182](#).

# Front of Room Experience

The front of room experience consists of two screens: the welcome screen, which is shown when no users are presenting, and the user presentation screen. The information shown on each screen can be modified using the receiver's web configuration interface.

## Welcome Screen

When no users are presenting, the welcome screen is shown on the display device. The welcome screen provides date, time, connection, room availability, and other information as shown in the following image.

Front of Room Experience - Welcome Screen

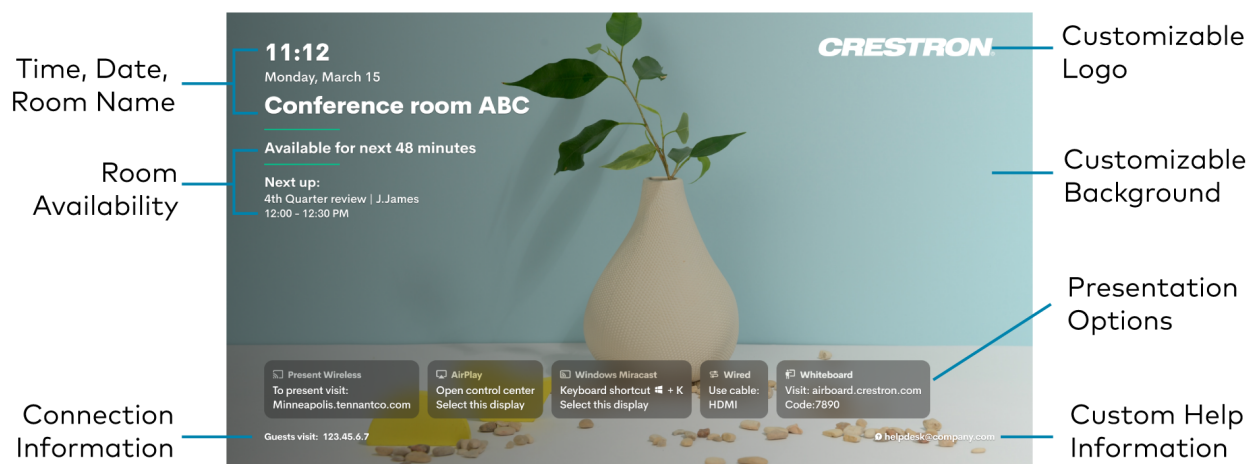

- **Customizable Logo:** Shows the Crestron logo by default. To upload a custom logo, refer to [Connected Devices on page 122](#).
- **Time, Date, Room Name:** Shows the time, date, and conference room name.
  - **Time/Date:** To configure time and date information, refer to [Date/Time on page 110](#).
  - **Room Name:** To show, hide, or customize the room name, refer to [General Settings on page 99](#).
- **Room Availability:** Shows room availability based on the connected calendar. To configure calendar settings, refer to [Services on page 113](#).
- **Customizable Background:** Shows a slideshow of backgrounds by default. To upload a custom background and/or modify the slideshow settings, refer to [Connected Devices on page 122](#).



- **Presentation Options:** Shows all of the available ways of sharing content. When a presentation mode is enabled, the presentation option tile will appear on the front of room display. When a presentation mode is disabled, the presentation option tile will not appear. To modify the font size of the of the text in each tile, refer to [Connected Devices on page 122](#).
- **Connection Information:** Shows additional connection information. To modify what information appears, refer to [Connection Display on page 136](#).
- **Custom Help Information:** Shows custom help information when configured. To set custom help information, refer to [Connected Devices on page 122](#).

## User Presentation

When a user is presenting, the user's presentation and additional connection information is shown on the display device.

### Front of Room Experience Screen - User Presenting

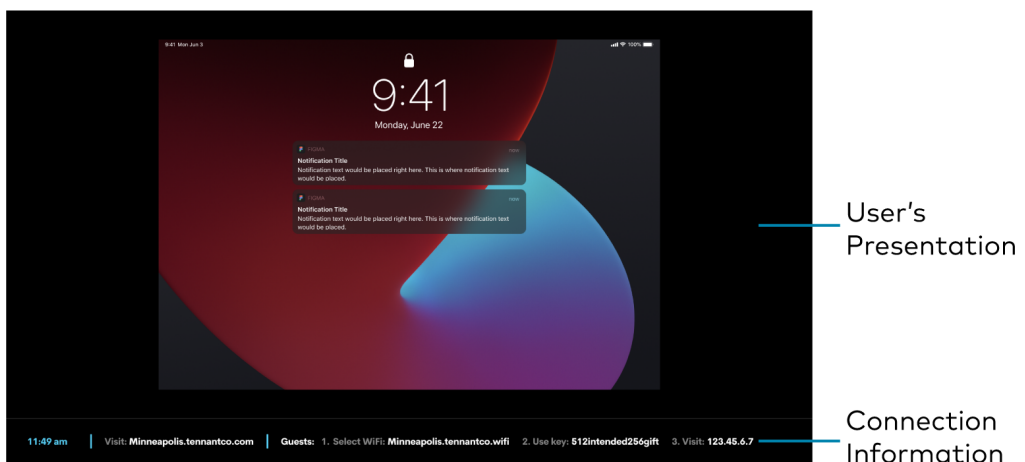

- **User's Presentation:** Shows up to four presentations when AirMedia Canvas is enabled. For more information on Airmedia Canvas, refer to [AirMedia Canvas on page 190](#). For more information on user presentation, refer to [Operation on page 166](#).
- **Connection Information:** Shows the time, receiver connection information, and additional connection information. To configure time and date information, refer to [Date/Time on page 110](#). To modify the connection information shown, refer to [Connection Display on page 136](#).

## Present with AirMedia

The receiver uses a client application to share a Windows or Mac desktop. The computer must be able to access the system over the network.

Crestron offers a standalone application for enterprise deployments. This application features additional connection methods and device management. For details, visit [present.crestron.com](http://present.crestron.com).

Mobile devices can share their content using the Crestron AirMedia app which is available for iOS and Android™ devices. Both apps may be used for full screen sharing on devices running Android 5.0 Lollipop or iOS 8 and above. Download the latest version of these apps from the App Store® app or Google Play™ store.

**NOTE:** For additional details on using AirMedia, refer to the [AirMedia Presentation Gateway Security Reference Guide](#) (Doc 7693).

## Establish a Computer Connection

To establish a connection from a computer to a receiver:

1. Open a web browser on the computer, and navigate to the web address or IP address shown on the display device. The welcome screen is displayed.

Welcome Screen

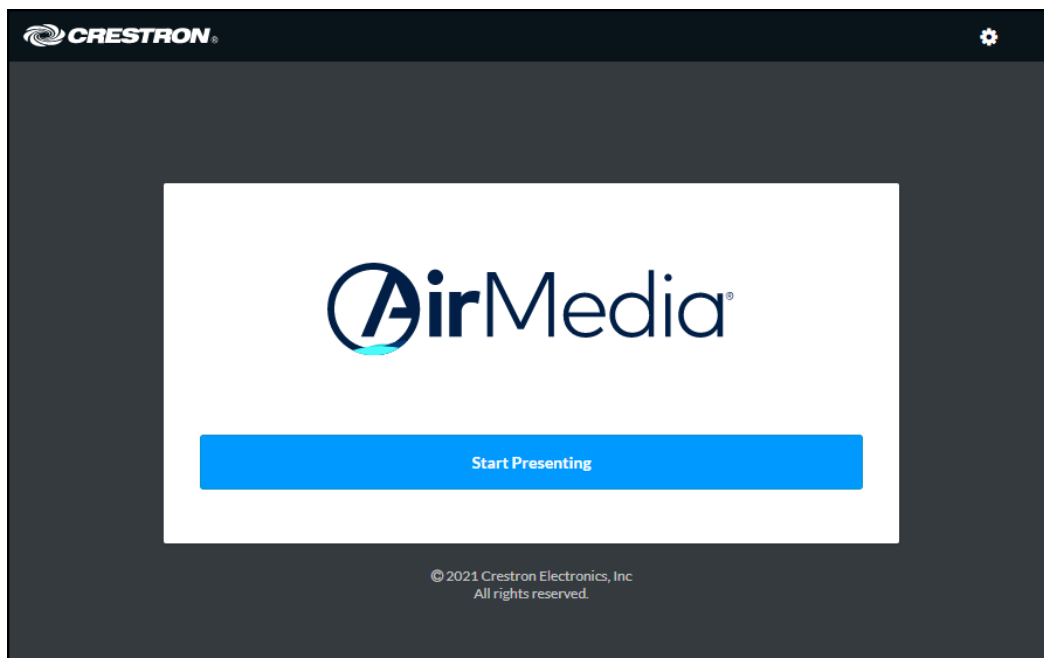

2. Select **Start Presenting**. The AirMedia screen will display.

#### AirMedia Screen

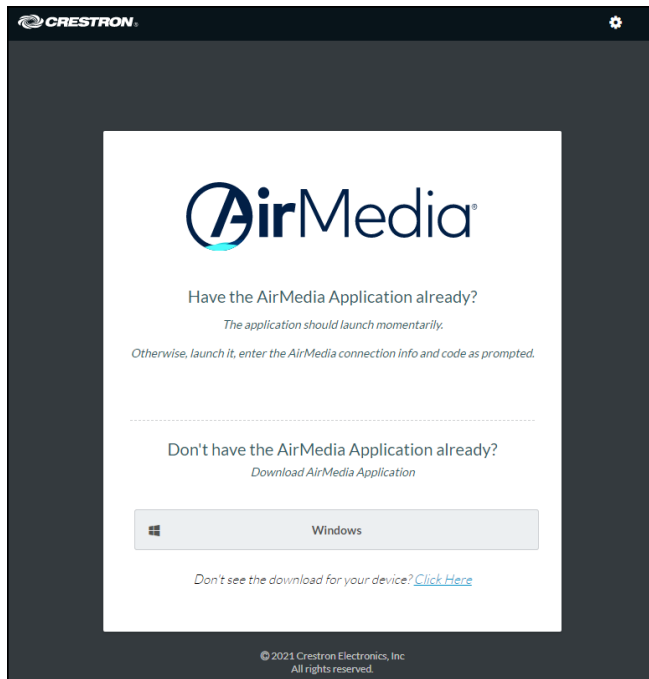

3. Select the button for your computer's operating system to download the client application. The client application requires no installation. The application will be downloaded and run locally.

**NOTE:** When used on a Mac, the AirMedia client application must be run from within the disk image file. Do not drag the application out of the disk image file.

## Share Content

Share content via AirMedia wireless presentation from a Windows computer, a Mac, an iOS device, or an Android device.

## From a Windows Computer

Once the client application is downloaded, content can be shared.

To share content from a Windows computer:

1. Run the client application. The **Connect** screen appears and lists any discovered AirMedia devices.

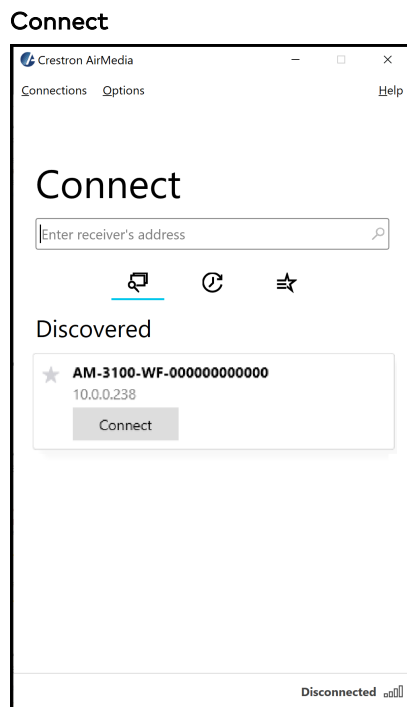

2. Select **Connect** under the desired receiver or enter the device's IP address in the search bar and press enter.

**NOTE:** Select the star button ★ to the left of the desired receiver to add or remove the receiver from the favorite devices list. Select the favorite devices list button ☆ to access the list.

3. If a code is required, enter the code shown on the display device. Otherwise, the contents of the computer screen will be presented on the display connected to the receiver. Once connected, the client application displays the presentation controls.



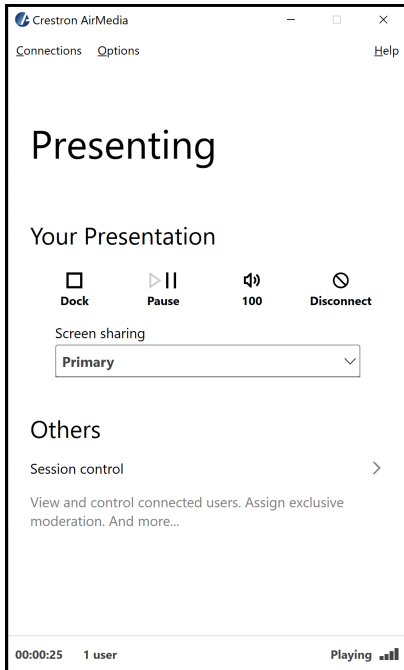

### Presentation Controls

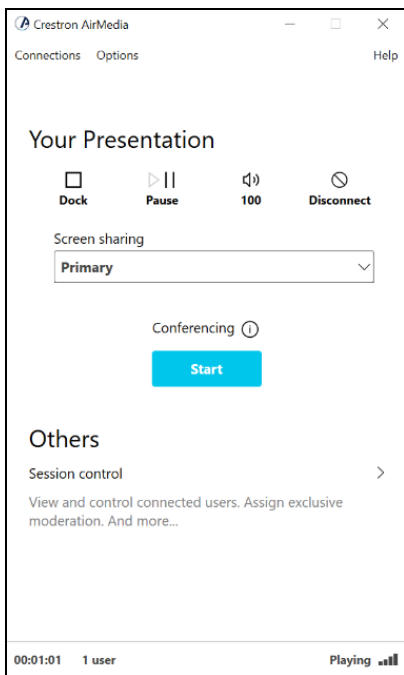

### Presentation Controls with Wireless Conferencing Enabled



4. Direct the presentation with the following controls:

- **Dock** : Dock the presentation. When docked, the computer no longer shares its screen but remains connected to the receiver.
- **Pause** : Start or freeze the computer's screen.
- **[Volume]** : Control the output volume of the display.
- **Disconnect** : End connection between the computer and the receiver.
- **Conferencing**  **Start**: Start a Wireless Conferencing session.
- Use the **Screen sharing** drop-down menu to select the connected screen to present.
- Select **Session control** to open the **Session** menu, which lists each presenter along with corresponding presentation controls. Up to 30 presenters can be connected at a time. Use the back arrow to return to the presentation controls for the computer.

**NOTES:**

- If the computer's presentation is paused and resumed by another presenter, the computer will then receive a permission request before the presentation resumes. To modify this setting, select **Options > Session Delegation**.
- To disable Session control, disable the **Canvas Session Control** setting in the device's web configuration interface. For more information on session control, refer to [Settings on page 96](#).

- Navigate to **Options > Settings** to customize AirMedia settings. Adjust the settings below and select **OK** to save the changes or select **Cancel** to cancel.

#### AirMedia Settings Dialog Box

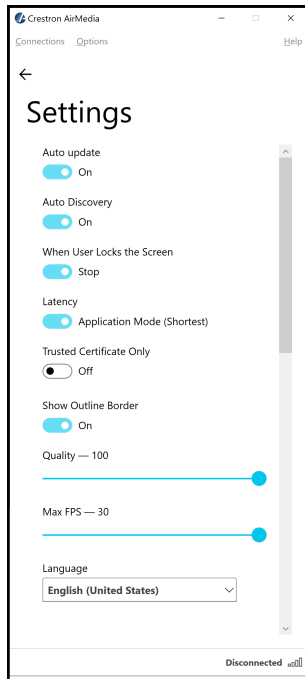

- Crestron recommends turning the **Auto Update** toggle to **On**.
- Crestron recommends turning the **Auto Discovery** toggle to **On**.
- **When User Locks the Screen** sets the operation of the client software when a connected computer is locked. Choose from **Stop** (the client stops sharing content), **Pause** (the client pauses sharing content), and **Nothing** (nothing happens).
- **Latency** selects the amount of latency in transmitting the signal from the computer to the receiver. Select **Application Mode (shortest)** for the least amount of latency (best for slides) or **Video Mode (Pre-Buffer)** for a longer amount of latency (best for buffering shared video).
- **Trusted Certificate Only** validates the server certificate before connection
- **Show Outline Border** selects whether or not an orange border appears on the computer's screen when presenting.
- Set the **Quality** of the projected signal (**0** to **100** percent).
- Set the **Max FPS** (frames per second) refresh rate (**1** to **30**).
- Select the **Language** displayed by the client application.

**NOTE:** The application must be restarted when switching languages.

## From a Mac

Once the client application is downloaded, content can be shared.



To share content from a Mac:

1. Run the client application. The **Connect** screen appears and lists any discovered AirMedia devices.

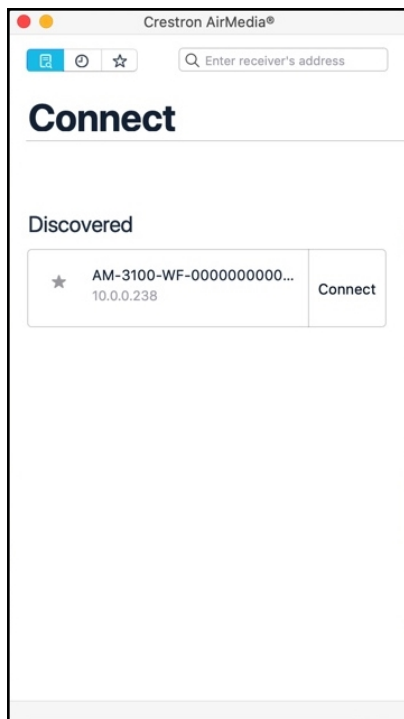
### Enter Code Dialog Box



2. Select **Connect** to the right of the desired receiver or enter the device's IP address in the search bar and press enter. The **Enter Code** screen appears.



**NOTE:** Select the star button  to the left of the desired receiver to add or remove the receiver from the favorite devices list. Select the favorite devices list button  to access the list.

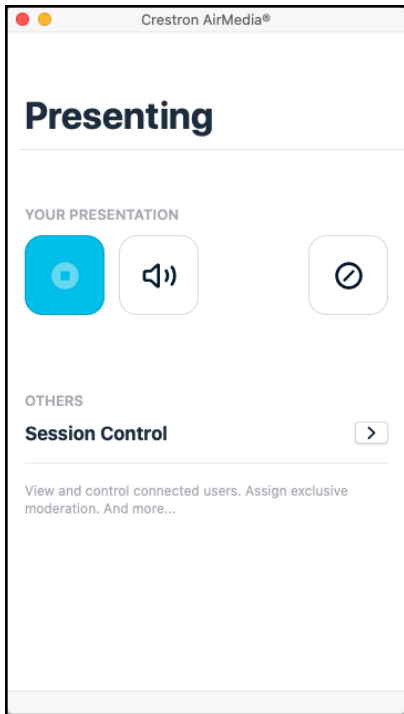

3. If a code is required, enter the code shown on the display device. Follow the onscreen instructions to present. Select **OK** to return to the presentation controls.

#### Presentation Controls



4. Direct the presentation with the following controls:
  - : Dock functionality to be supported in a future release.
  - : Control the output volume of the display.
  - : End the connection between the computer and the receiver.
  - Select **Session control** for additional controls and information about all presenters. The **Session** menu opens and lists each presenter with corresponding presentation controls. Use the back arrow to return to the presentation controls for the computer.

**NOTE:** To disable Session control, disable the **Canvas Session Control** setting in the device's web configuration interface. For more information on Session control, refer to [Settings on page 96](#).

- Select **Options > Settings** in the menu bar to customize AirMedia settings.

## From an iOS Device

Content can be shared from an iOS device using the built-in screen mirroring functionality.

To share content from an iOS device:

1. Open the AirMedia application. The **Connect** screen appears and lists any discovered AirMedia devices.

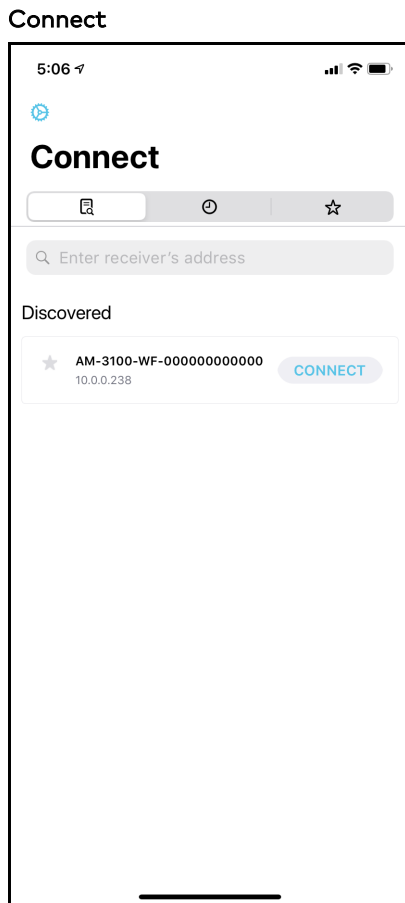

2. Select **Connect** next to the desired receiver or enter the receiver's IP address in the search bar and press **Enter** on the phone's onscreen keyboard.

**NOTE:** Select the star button ★ to the left of the desired receiver to add or remove the receiver from the favorite devices list. Select the favorite devices list button ★ to access the list.



3. If a code is required, enter the code shown on the display device and select **OK**. Screen mirroring instructions appear.

4. Follow the onscreen instructions and select **OK**. Once connected, the application offers presentation controls.

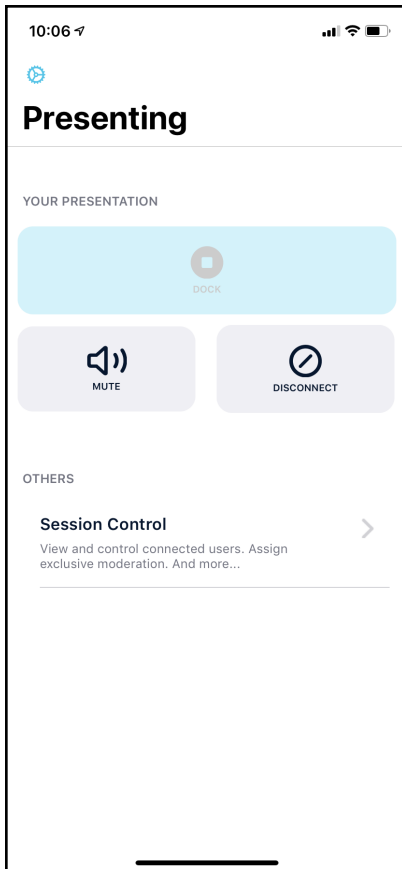
### Presentation Controls



5. Direct the presentation with the following controls:

- **Dock** : Dock functionality to be supported in a future release.
- **Disconnect** : End the connection between the device and the receiver.
- Select **Session control** to open the **Session** menu, which lists each presenter along with corresponding presentation controls. Up to 30 presenters can be connected at a time. Use the back arrow to return to the presentation controls for the device.

**NOTE:** To disable Session control, disable the **Canvas Session Control** setting in the device's web configuration interface. For more information on Session control, refer to [Settings on page 96](#).

- Tap the settings button in the top left corner to customize AirMedia settings.

**NOTE:** If another presenter enters fullscreen mode, presentation from the iOS device will end. The iOS device will remain connected to the receiver. If this occurs, resume the presentation by repeating the screen mirroring instructions described in step 3.

## From an Android Device

Content can be shared from an Android device using the AirMedia application.

To share content from an Android device:

1. Open the AirMedia application. The **Connect** screen appears and lists any discovered AirMedia devices

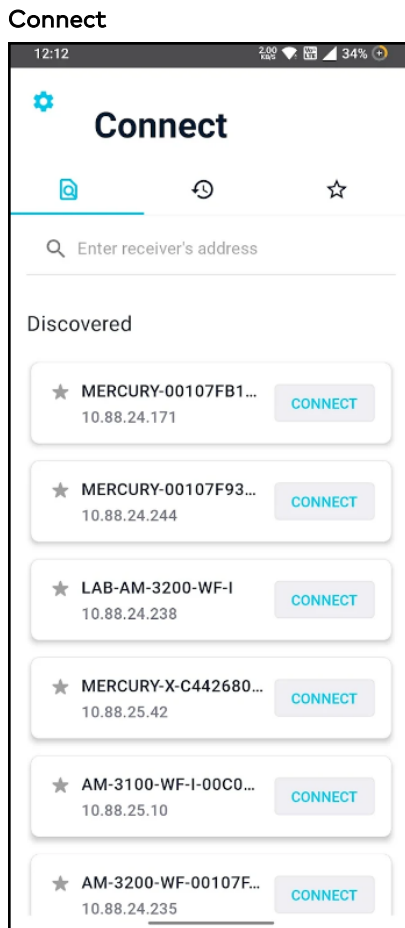

2. Select the desired receiver or enter the receiver's IP address in the search bar and press **Enter** on the phone's onscreen keyboard.

**NOTE:** Select the star button ★ to the left of the desired receiver to add or remove the receiver from the favorite devices list. Select **Favorites** to access the list.

3. If a code is required, enter the code shown on the display device and select **OK**. A presentation confirmation message appears.
4. Select **Start now** to begin presenting.

To end the presentation, make one of the following selections:

- **Dock:** Stop presenting from the Android device but remain connected to the receiver.
- **Disconnect:** Stop presenting from the Android device and disconnect from the receiver.

#### Presentation Screen

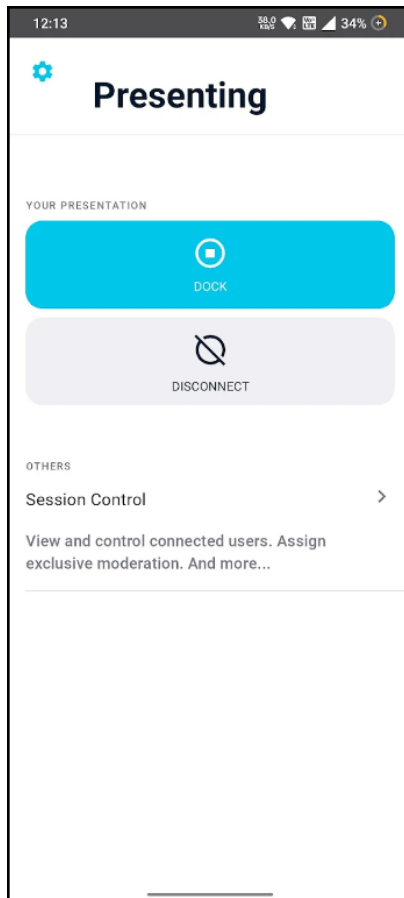

## Using Miracast

Miracast is a mirroring protocol and wireless technology used to project your screen to the receiver without the need to install an application on your Windows computer.

To present using Miracast with an AirMedia receiver:

1. Open the Windows connect menu via the Windows notification center or via the shortcut  (Windows) + K. On touch-capable Windows 10 devices, swipe in from the right edge of the screen.
2. Select the desired receiver from the list.
3. If a code is required, enter the code shown on the display device.

For more details on using Miracast with the AirMedia receiver, refer to the [AirMedia Presentation Gateway Security Reference guide](#) (Doc 7693).

# Touch Screen Operation

A connected touch screen running .AV Framework software can be used to control presentations. Use the touch screen to control volume, switch between sources, and start and stop presentations. The home screen is displayed when the system starts.

## Add a Touch Screen

The receivers support the use of a TS- or TSW- 70 series 7 in. or 10 in. touch screen for system control. Adding a touch screen to the system requires an entry in the touch screen's IP table and loading a touch screen project file to the touch screen.

**NOTE:** The touch screen must be accessible to the receiver over the network.

## IP Table Entry

An IP table entry must be created to direct the touch screen to the IP address or host name of the receiver. For instructions on creating an IP table entry, refer to the touch screen's product manual:

- [TSW-570, TSW-770, and TSW-1070 Product Manual](#) (Doc. 8550)
- [TS-770 and TS-1070 Product Manual](#) (Doc. 8555)

## Load a Touch Screen Project File

If internet connectivity is available on the receiver, the system automatically loads the touch screen project file once the IP table entry is complete. To automatically load the touch screen project file, touch screen auto update must be enabled as described in [Connected Devices on page 122](#).

To download the touch screen project file, refer to the receiver's product page:

- [AM-3100-WF](#)
- [AM-3100-WF-I](#)
- [AM-3200](#)
- [AM-3200-WF](#)
- [AM-3200-WF-I](#)

For details on manually loading a touch screen project file, refer to the touch screen's product manual:

- [TSW-570, TSW-770, and TSW-1070 Product Manual](#) (Doc. 8550)
- [TS-770 and TS-1070 Product Manual](#) (Doc. 8555)

## Screen Controls



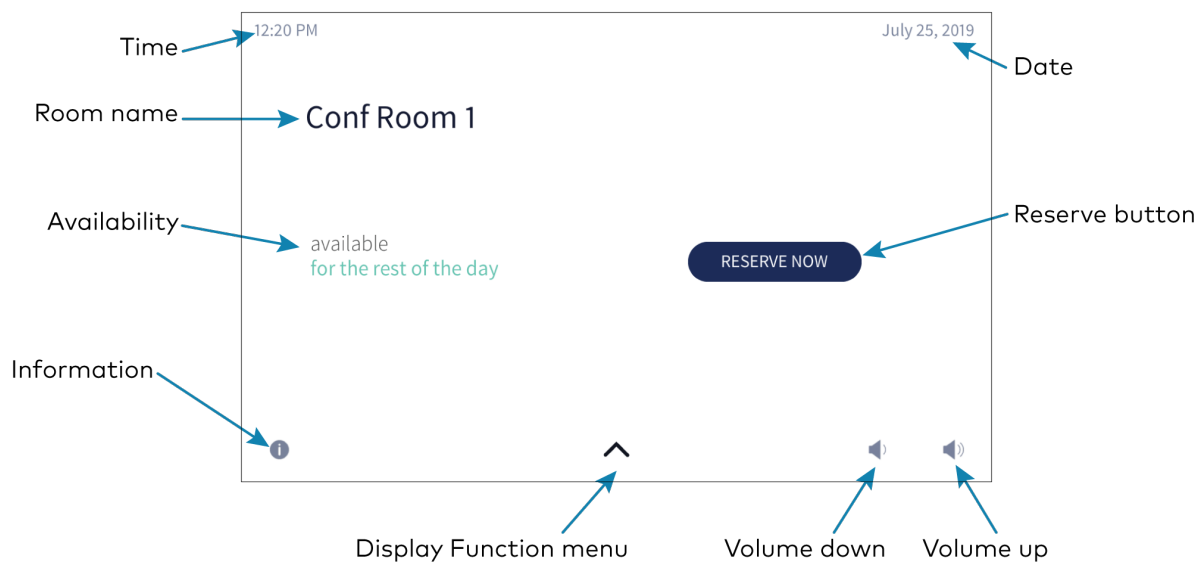

When connected, the touch screen will display the home screen.

### Home Screen



The footer bar provides the same buttons regardless of which screen is selected. Refer to the following tables for more information on footer button functionality.

### Footer Buttons

-  The more button navigates to the selection screen.
-  The info button navigates to the information screen.
-  The volume lower button lowers the device volume incrementally.
-  The volume raise button raises the device volume incrementally.



**NOTE:** Volume controls are only present when the system is connected to a display device that supports volume control.

## Access the System Info Screen

To access the **System Info** screen, tap and hold the information button  on the home screen for 20 seconds.

The **System Info** screen provides the device IP address, the device hostname, the Crestron Fusion server connection status, the Crestron Fusion room name, the device MAC address, the device serial number, and the .AV Framework version number.

### System Info screen

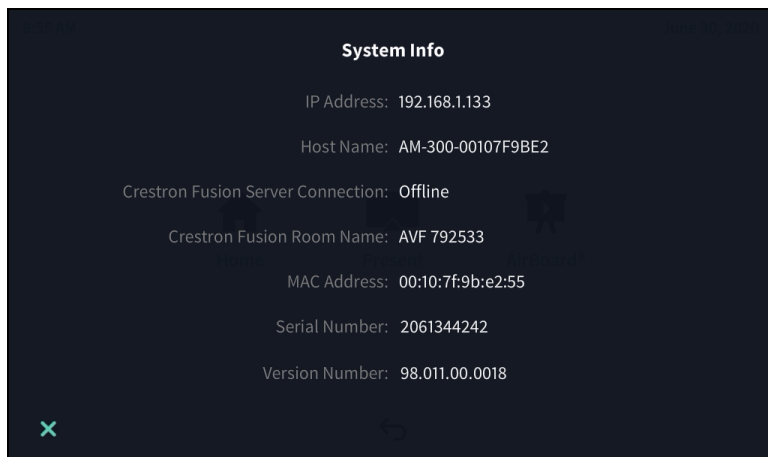



## The Function Menu

Tap the more button  on the home screen to display the function menu.

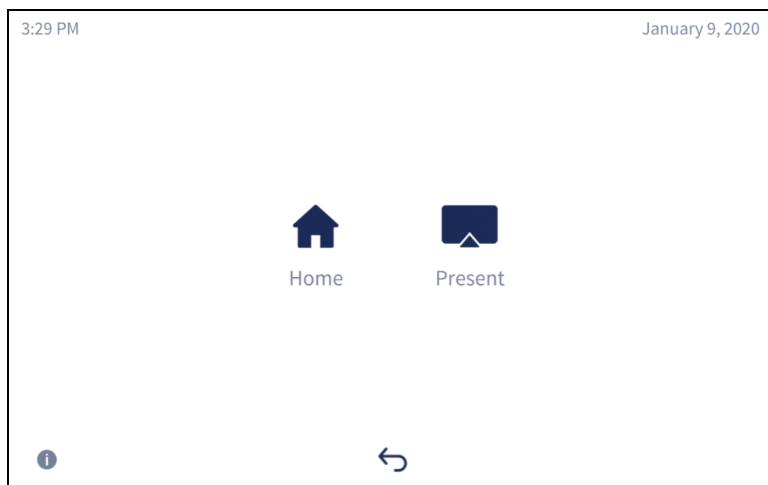
### Function Menu



- Tap **Home**  to display the Home screen.
- Tap **Present**  to view presentation options. For details, refer to [Present a Source on page 188](#).
- Tap the back button  to return to the previous screen

## Room Scheduling

The Home screen is used to reserve the conference room.

Tap **Home**  to display the home screen. The home screen displays the current status of the room.

### Room Available

If the room is available for use, the touch screen provides the following information:

- The time remaining (in minutes) until the next scheduled meeting occurs
- A **RESERVE NOW** button that allows an ad hoc meeting to be scheduled through the touch screen

#### Home Screen – Available Room

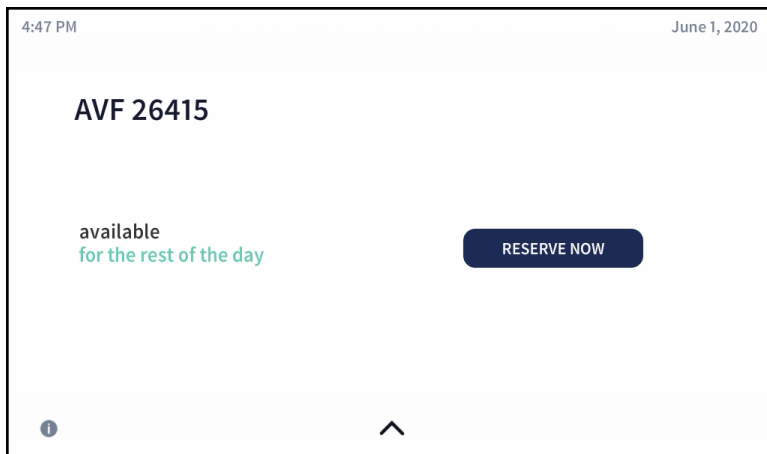

### Room Reserved

If the room is not available, the home screen provides the following information:

- The time remaining (in minutes) until the current meeting ends
- The duration, name, and organizer of the scheduled meeting

You can use the room for the remaining time available or reserve the room for another time.

## Home Screen – Reserved Room

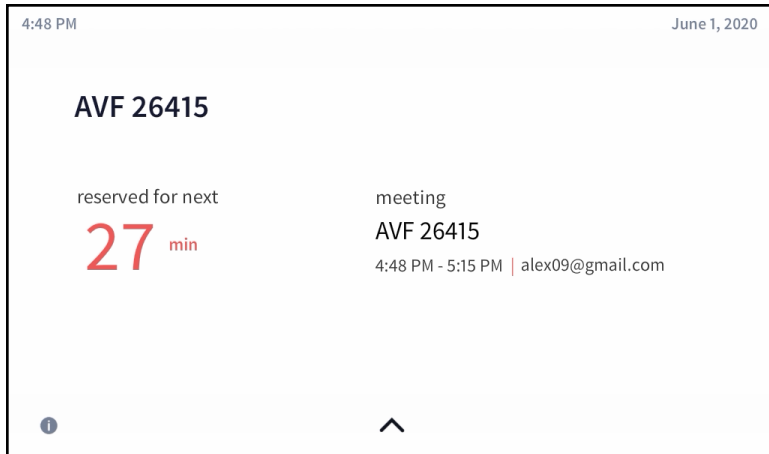

## Reserve the Room

To reserve an ad hoc meeting from the home screen when the room is available:

1. Tap **RESERVE NOW** on the home screen. The **New Meeting** screen is displayed.

**NOTE: RESERVE NOW** meetings may only be scheduled for the current day.

### New Meeting Screen

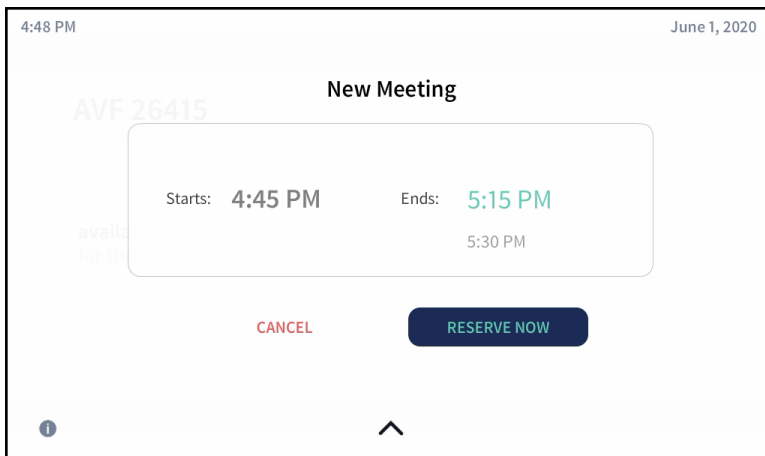

2. Tap one of the available meeting end times to set the duration of the meeting. The room can be reserved for up to three lengths:
  - Until the current half hour interval ends (If the current time is 4:44 pm, the end time for this option is 5:00 pm.) This is the default setting.
  - Until the current half hour interval ends plus 30 minutes (If the current time is 4:44 pm, the end time for this option is 5:30 pm.)
  - Until the current half hour interval ends plus 60 minutes (If the current time is 4:44 pm, the end time for this option is 6:00 pm.)

**NOTE:** These options are available only if a meeting is not already scheduled during these times.

3. Tap **RESERVE NOW** to reserve the meeting.

To discard the reservation, tap **CANCEL**.

## Present a Source

To present a connected source, tap **Present** from the function menu. The **Present a Source** screen appears. The **Present a Source** screen allows content to be routed from a connected device to the main display in the room.

### Present a Source Screen

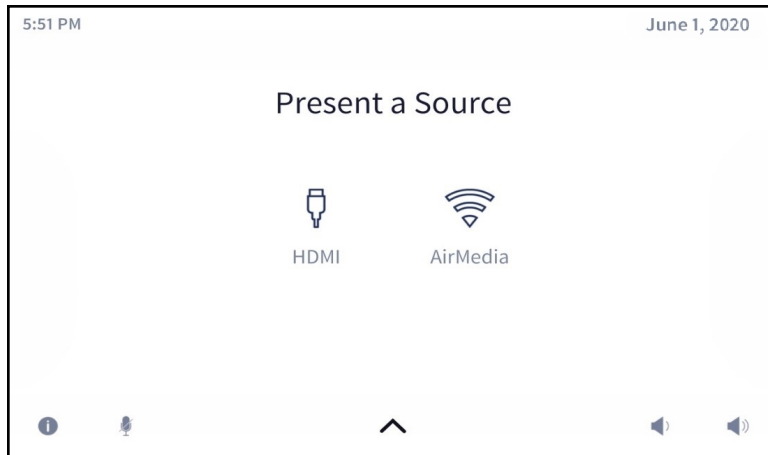

To present content from a source device, select one of the available presentation options. The source is controlled directly through the touch screen.

If a source is active, a **Stop** button is shown. Tap the **Stop** button to stop routing the source to the display.

## Present via HDMI

To display content from a source connected via HDMI, tap **HDMI** . The following screen will appear.

### Present Screen - HDMI Source

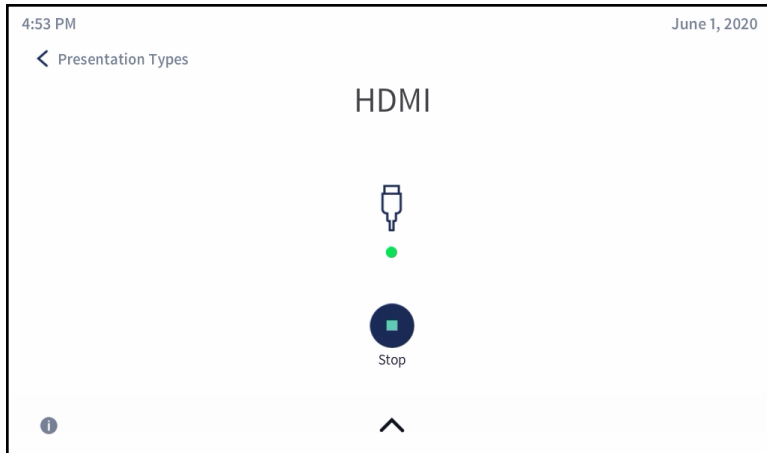

The dot in the center of the screen turns green if the source is connected and turns red if the source is disconnected.

When done presenting, tap **Stop** .

To return to the previous screen, tap **< Presentation Types**. Tapping **< Presentation Types** does not disconnect the source.

## Present via AirMedia

Tap **Wireless** to display content from a device connected through AirMedia. The **AirMedia®** screen is displayed with instructions to present with AirMedia.

### AirMedia® Screen

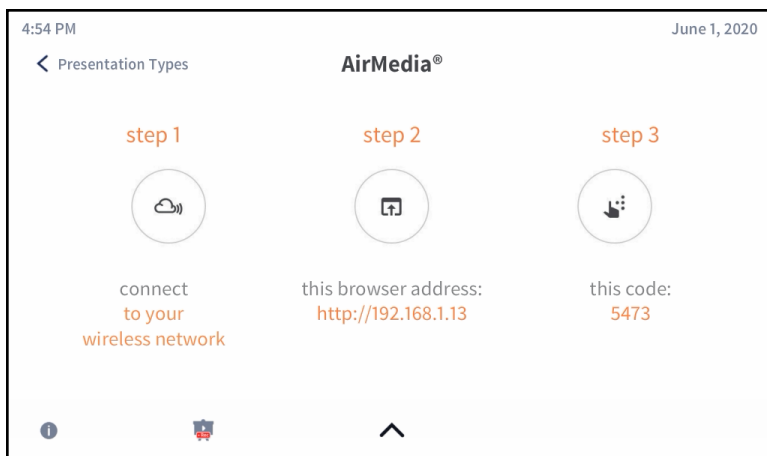

Refer to [Control Multiple Sources on page 190](#) for instructions on controlling an AirMedia presentation from the touch screen.

Refer to [Present with AirMedia on page 168](#) for instructions on connecting to AirMedia and sharing content.

## AirMedia Canvas

When configured, the receiver can show multiple sources on the display device simultaneously. The touch screen is used to manage the sources shown on the display device.

**NOTE:** For details on configuring the receiver to use the AirMedia Canvas feature, refer to [Settings on page 96](#).



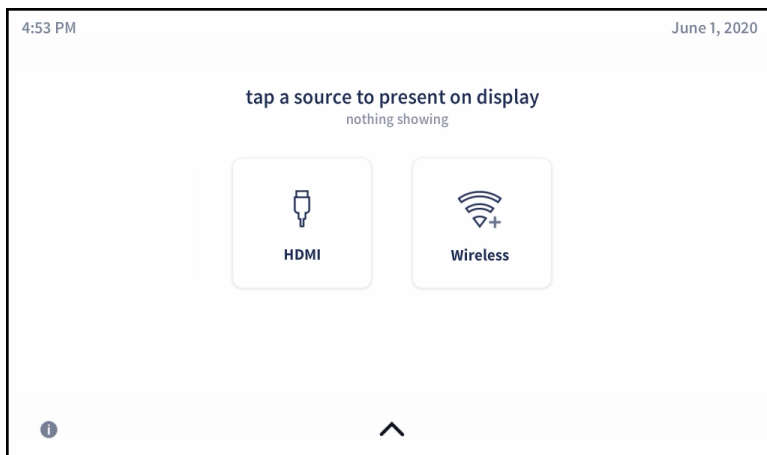

When AirMedia Canvas and Canvas Session Controls are enabled, the Present a Source screen appears as shown below.

### Present a Source Screen



## Control Multiple Sources

To control multiple sources using Canvas Session Controls:

1. Connect all sources to the receiver.
2. Tap the first source for presentation. The content will appear on the display device with presentation controls.
  - Select the volume button  to mute or unmute the source's volume.
  - Select **Stop**  to dock the presentation. When docked, the source stops presenting but remains connected to the display. Select the play button  to resume presenting. When resuming a presentation, a permission request is sent to the source device. The request must be accepted before the presentation resumes.
  - Select the disconnect button  to disconnect the source from the receiver.

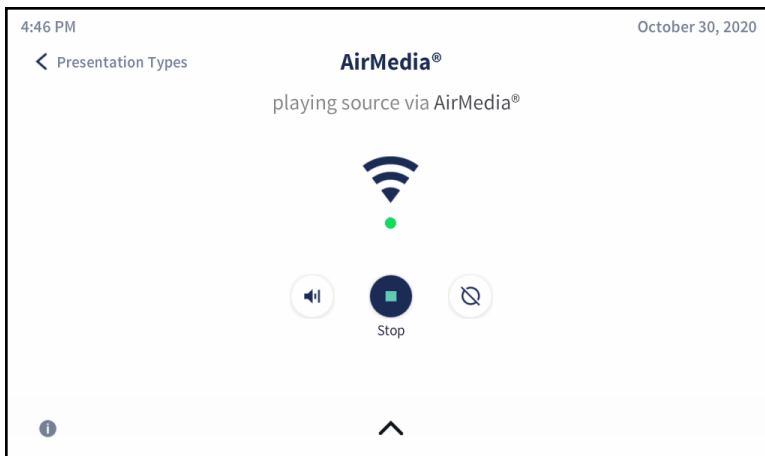

3. Tap < **Presentation Types**. The touch screen will show the connected source with the presentation controls detailed in the previous step.

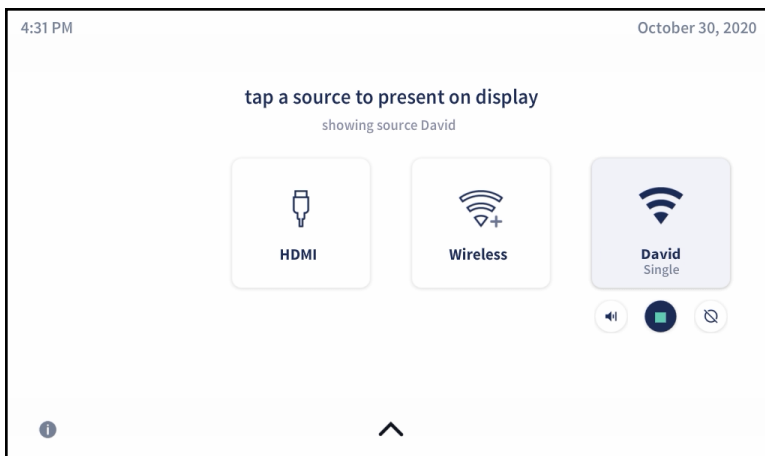



4. Tap the second source for presentation. The display device will show the two sources side by side.

**NOTE:** The dock control feature will be implemented for Apple® devices in a future release. Select the disconnect button  to end the presentation and disconnect the source device.

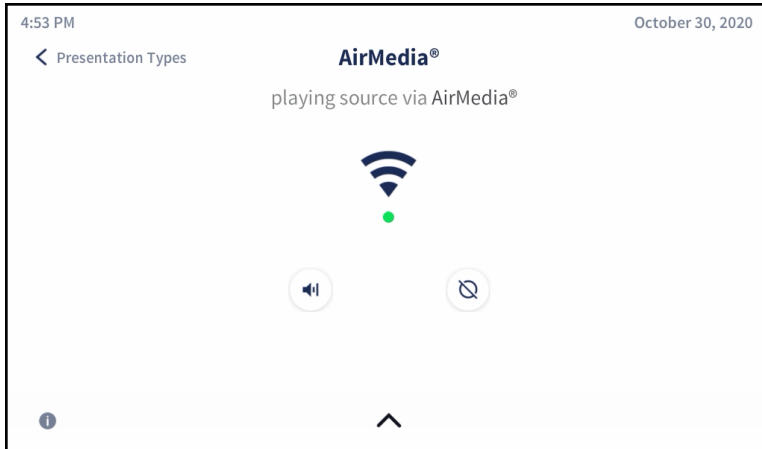

5. Tap < **Presentation Types**. The touch screen will show the two connected sources side by side.

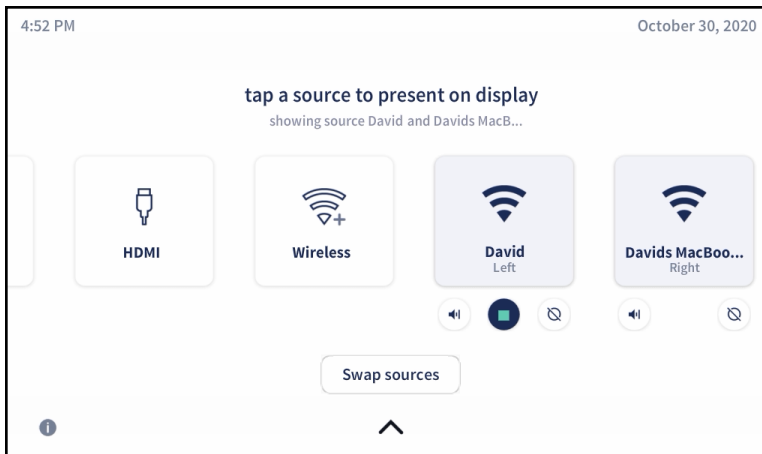

6. (Optional) Tap more sources to present as needed. The touch screen will show all connected sources side by side, and the presentations will be arranged on the display device.

**NOTE:** If the maximum amount of presenters is reached and another source is selected, then the first source will be docked (AirMedia user) or disconnected (hard wired inputs, AirPlay connection, or Miracast connection) and the latest source will take its place on the display. When docked, the source stops presenting but remains connected to the display. To adjust the maximum amount of sources that can present simultaneously, refer to [General Settings on page 131](#)

## Switch to Single Source

When two sources are shown on the display device, tap **Stop**  to remove the source's presentation from the display device. The remaining source will be presented in full screen.

## Swap Sources

When two sources are shown on the display device, tap **Swap Sources** to switch the positions of two sources.

When more than two sources are shown on the display device, the **Swap Sources** button is unavailable.

# AirMedia Connect Devices

AirMedia Connect devices can be connected to personal devices to instantly share content with a paired Wi-Fi network capable AirMedia receiver. Up to eight Connect devices can be paired to a single receiver.

For information about pairing and configuring Connect devices, refer to [Connect Devices on page 141](#).

This section contains the following information:

- [Wireless Best Practices on page 195](#)
- [AM-TX3-100\(-I\) Operational Instructions on page 196](#)

# Wireless Best Practices

AirMedia Connect devices communicate with compatible AirMedia Series 3 Receivers using a point to point (Wi-Fi Direct) connection. Wireless performance depends upon a variety of conditions in the environment.

Consider the following guidelines and best practices to ensure a consistent and reliable experience.

## Physical Factors

- **Maximum Distance:** The maximum range from the Connect device to the receiver varies based on environmental conditions, but Crestron recommends that the Connect device operate within 80 ft (24m) of the receiver.
- **Wireless Interference:** Ensure that there are no obstructions between the Connect device and receiver that could create wireless interference. Line of sight visibility from Connect device to receiver is ideal.
- **External Antennas (AM-3200-WF(-I) only):** With the receiver powered off, connect the included external antennas. If the receiver is mounted behind a display, position the antennas near the bottom or sides of the display.

## Network Settings

The following settings can be adjusted in the AirMedia receiver web configuration. For details, refer to [Network on page 100](#).

- **Wi-Fi Frequency:** AirMedia receivers can be set to **2.4GHz Only** or **5GHz Only** (default). The 5GHz generally enables higher throughput, but 2.4GHz enables wider distance.
- **Wi-Fi Channel:** By default, the AirMedia receiver automatically selects a Wi-Fi channel. To improve reliability, use a Wi-Fi analyzer to determine the least crowded channel. Select the channel with the least traffic.
- **Wi-Fi Access Point Signal Strength:** Set the signal strength to 100% for best results. In building layouts with multiple AirMedia systems and other Wi-Fi devices in close proximity, balance the signal strength as needed.

# AM-TX3-100(-I) Operational Instructions

Before content can be shared with the AM-TX3-100, it must be paired with a Wi-Fi network capable AirMedia receiver as described in the [Connect Devices on page 141](#) section of this product manual.

## Share Content

To share content through the AM-TX3-100, plug the AM-TX3-100 into the USB-C port of a compatible personal device.

**NOTE:** The personal device's USB-C port must be DisplayPort Alt mode compatible.

To pause or resume sharing content, quickly press the **Screenshare** button twice.

To stop sharing content, press the **Screenshare** button.

### Screenshare Button

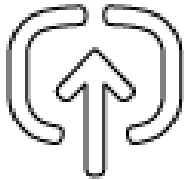

## Restoring the Device

To restore the AM-TX3-100(-I) to factory default, perform the following procedure:

1. Press and hold the **Screenshare** button.
2. After two seconds, simultaneously press and hold the **Peripherals** button.
3. Continue to hold both buttons until the ring LED turns amber. This takes approximately eight seconds.

The AM-TX3-100(-I) will reboot. All configuration, included pairing, will be reset to default.

# Resources

The following resources are provided for AirMedia® Series 3 devices.

**NOTE:** You may need to provide your Crestron.com web account credentials when prompted to access some of the following resources.

## Crestron Support and Training

- [Crestron True Blue Support](#)
- [Crestron Resource Library](#)
- [Crestron Online Help \(OLH\)](#)
- [Crestron Training Institute \(CTI\) Portal](#)

## Programmer and Developer Resources

- [help.crestron.com](http://help.crestron.com): Provides help files for Crestron programming tools such as SIMPL, SIMPL#, and Crestron Toolbox™ software
- [developer.crestron.com](http://developer.crestron.com): Provides developer documentation for Crestron APIs, SDKs, and other development tools

## Product Certificates

To search for product certificates, refer to [support.crestron.com/app/certificates](http://support.crestron.com/app/certificates).

# Trademarks

## Original Instructions

The U.S. English version of this document is the original instructions.  
All other languages are a translation of the original instructions.

**Regulatory Models:** M202018001, M202011001

Crestron product development software is licensed to Crestron dealers and Crestron Service Providers (CSPs) under a limited nonexclusive, nontransferable Software Development Tools License Agreement. Crestron product operating system software is licensed to Crestron dealers, CSPs, and end-users under a separate End-User License Agreement. Both of these Agreements can be found on the Crestron website at [www.crestron.com/legal/software\\_license\\_agreement](http://www.crestron.com/legal/software_license_agreement).

The product warranty can be found at [www.crestron.com/warranty](http://www.crestron.com/warranty).

The specific patents that cover Crestron products are listed at [www.crestron.com/legal/patents](http://www.crestron.com/legal/patents).

Certain Crestron products contain open source software. For specific information, visit [www.crestron.com/opensource](http://www.crestron.com/opensource).

Crestron, the Crestron logo, AirMedia, .AV Framework, Crestron Connected, Crestron Fusion, Crestron Studio, Crestron Toolbox, and XiO Cloud are either trademarks or registered trademarks of Crestron Electronics, Inc. in the United States and/or other countries. Apple, App Store, AirPlay, iPad, iPhone, Mac, macOS, and Safari are either trademarks or registered trademarks of Apple, Inc. in the United States and/or other countries. Appspace is either a trademark or a registered trademark of Appspace Inc. in the United States and/or other countries. Bluetooth is either a trademark or registered trademark of Bluetooth SIG, Inc. in the United States and/or other countries. Android, Chrome, Chrome OS, Google Calendar, Google Play, and YouTube are either trademarks or registered trademarks of Google, Inc. in the United States and/or other countries. iOS is either a trademark or registered trademark of Cisco Systems, Inc. in the United States and/or other countries. Jabra is a trademark of GN Audio A/S in the United States and/or other countries. HDMI is either a trademark or registered trademark of HDMI Licensing LLC in the United States and/or other countries. Intertek is either a trademark or registered trademark of Intertek Group in the United States and/or other countries. Active Directory, Azure, Microsoft, Microsoft 365, Microsoft Edge, Microsoft Exchange Server, and Windows are either trademarks or registered trademarks of Microsoft Corporation in the United States and/or other countries. Firefox is either a trademark or registered trademark of the Mozilla Foundation in the United States and/or other countries. USB-C is either a trademark or registered trademark of USB Implementers. Miracast, Wi-Fi, and Wi-Fi Direct are either trademarks or registered trademarks of Wi-Fi Alliance in the United States and/or other countries. Other trademarks, registered trademarks, and trade names may be used in this document to refer to either the entities claiming the marks and names or their products. Crestron disclaims any proprietary interest in the marks and names of others. Crestron is not responsible for errors in typography or photography.

©2024 Crestron Electronics, Inc.

This page is intentionally left blank.



