

MD120UI Tracking Camera

User Manual



How to Clean and Disinfect

Warning**Risk of personal injury**

Do not use cleaning agents containing phenol, as phenol may cause skin burns if not rinsed thoroughly and does not contain sufficient cleaning or disinfectant properties.

Caution

1. The camera is designed for easy cleaning and disinfection.
2. Before cleaning the camera, disconnect it from the power source.
3. Cleaning procedures should only be carried out by personnel familiar with camera operation.
4. Do not spray cleaning fluid, especially water, into any internal electrical equipment or parts of the camera to avoid possible short circuits, corrosion, malfunction and electrical shock hazards to users or service personnel.
5. Corrosive cleaning agents may cause discoloration or damage the camera. Before using any cleaning agent, test it in an inconspicuous area.

When

Clean the camera before and after use.

Steps

1. Disconnect the camera from a power source.
2. Cleaning personnel must wear cleaning gloves.
3. Before using cleaning alcohol, make sure it has not expired.
4. Use a cleaning cloth dampened with cleaning alcohol (75%).
5. Wipe any surface that may come into contact with the camera.
6. After wiping the camera, avoid contact with bare hands.

Frequency

No regular cleaning is required. Clean before and after use.

Symbols on this Product

The symbols on this product, including the accessories, represent the following.

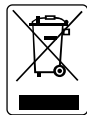

The WEEE symbol.

This symbol indicates that this product must not be disposed of with your other household waste. Instead, you need to dispose of the waste equipment by handing it over to a designated collection point for the recycling of waste electrical and electronic equipment. For more information about where to drop off your waste equipment for recycling, please contact your household waste disposal service or the shop where you purchased the product.



The CE compliance logo.

This logo indicates that the product conforms to the relevant guidelines/standards for the European Union harmonization legislation.



The FCC compliance logo.

This logo indicates that the product conforms to Federal Communications Commission compliance standards.



The UKCA (UK Conformity Assessed) symbol.

This symbol indicates that a product placed on the Great Britain market meets the UKCA Marking requirements.



The RCM compliance logo.

This logo indicates that the product conforms with Australian RCM guidelines.



This logo is intended to alert the users to the presence of un-insulated "dangerous voltage" within the product's enclosure that may be of sufficient magnitude to constitute a risk of electric shock to persons.



This logo is intended to alert the users to the presence of important operating and maintenance (servicing) instructions in the literature accompanying the appliance.



The China RoHS symbol.

The figure of this symbol represents the number of years during which no hazardous substances would leak or mutate under normal conditions of use.



The alternating current symbol.

This symbol indicates that the power input/output for the product is alternating current.



The direct current symbol.

This symbol indicates that the power input/output for the product is direct current.

Federal Communications Commission

NOTE: This equipment has been tested and found to comply with the limits for a Class A digital device, pursuant to part 15 of the FCC Rules. These limits are designed to provide reasonable protection against harmful interference when the equipment is operated in a commercial environment. This equipment generates, uses, and can radiate radiofrequency energy and, if not installed and used in accordance with the instruction manual, may cause harmful interference to radio communications. Operation of this equipment in a residential area is likely to cause harmful interference in which case the user will be required to correct the interference at his own expense.

FCC Caution: Any changes or modifications not expressly approved by the party responsible for compliance could void the user's authority to operate this equipment.

This device complies with part 15 of the FCC Rules.

Operation is subject to the following two conditions:

- (1) This device may not cause harmful interference, and
- (2) this device must accept any interference received, including interference that may cause undesired operation.

This Class A digital apparatus complies with Canadian ICES-003. Cet appareil numérique de la classe A est conforme à la norme NMB-003 du Canada.

Warning

This is a class A product. In a domestic environment this product may cause radio interference in which case the user may be required to take adequate measures.

Remote Control Battery Safety Information

- Store batteries in a cool and dry place.
- Do not throw away used batteries in the trash. Properly dispose of used batteries through specially approved disposal methods.
- Remove the batteries if they are not in use for long periods of time. Battery leakage and corrosion can damage the remote control. Dispose of batteries safely and through approved disposal methods.
- Do not use old batteries with new batteries.
- Do not mix and use different types of batteries: alkaline, standard (carbon-zinc) or rechargeable (nickel-cadmium).
- Do not dispose of batteries in a fire.
- Do not attempt to short-circuit the battery terminals.

DISCLAIMER

No warranty or representation, either expressed or implied, is made with respect to the contents of this documentation, its quality, performance, merchantability, or fitness for a particular purpose. Information presented in this documentation has been carefully checked for reliability; however, no responsibility is assumed for inaccuracies. The information contained in this documentation is subject to change without notice.

In no event will AVer Information Inc. be liable for direct, indirect, special, incidental, or consequential damages arising out of the use or inability to use this product or documentation, even if advised of the possibility of such damages.

TRADEMARKS

“AVer” is a trademark owned by AVer Information Inc. Other trademarks used herein for description purpose only belong to each of their companies.

COPYRIGHT

©2023 AVer Information Inc. All rights reserved. | June 7, 2023

All rights of this object belong to AVer Information Inc. Reproduced or transmitted in any form or by any means without the prior written permission of AVer Information Inc. is prohibited. All information or specifications are subject to change without prior notice.

More Help

For FAQs, technical support, software and user manual download, please visit:

Headquarters

Download Center: <https://www.aver.com/download-center>

Technical Support: <https://www.aver.com/technical-support>

USA Branch Office

Download Center: <https://www.averusa.com/pro-av/support>

Technical Support: <https://averusa.force.com/support/s/contactsupport>

Europe Branch Office

Download Center: <https://www.avereurope.com/download-center>

Technical Support: <https://www.avereurope.com/technical-support>

Contact Information

Headquarters

AVer Information Inc.

<https://www.aver.com>

8F, No.157, Da-An Rd., Tucheng Dist., New Taipei City 23673, Taiwan

Tel: +886 (2) 2269 8535

USA Branch Office

AVer Information Inc., Americas

<https://www.averusa.com>

668 Mission Ct., Fremont, CA 94539, USA

Tel: +1 (408) 263 3828

Toll-free: +1 (877) 528 7824

Technical support: support.usa@aver.com

Europe Branch Office

AVer Information Europe B.V.

<https://www.avereurope.com>

Westblaak 134, 3012 KM, Rotterdam, The Netherlands

Tel: +31 (0) 10 7600 550

Technical support: eu.rma@aver.com

Japan Branch Office

アバー・インフォメーション株式会社

<https://jp.aver.com>

〒160-0023 日本東京都新宿区西新宿 3-2-26 立花新宿ビル 7 階

Tel: +81 (0) 3 5989 0290

テクニカル・サポート: <https://jp.aver.com/technical-support>

Vietnam Branch Office

Công ty TNHH AVer Information (Việt Nam)

Tầng 5, 596 Nguyễn Đình Chiểu, P.3, Quận 3,

Thành phố Hồ Chí Minh 700000, Việt Nam

Tel: +84 (0)28 22 539 211

Contents

How to Clean and Disinfect	2
Overview.....	1
Package Contents.....	1
Optional Accessories	1
Dimensions	2
Ceiling Mount	3
Wall Mount	4
Pan and Tilt Angle.....	4
Installation.....	5
Cable Fixing Plate	5
Ceiling Mount	6
Connections	7
Privacy Indicator.....	7
LED Indicator	7
Device Connection	8
Remote Control.....	11
Shortcuts	12
Set up the Camera	13
OSD Menu	13
IP Address Setup	13
OSD Menu Tree	15
Web Interface.....	18
Access the Web Interface of the Camera.....	18
Live View.....	20
AI Setting	22
Camera Settings	24
Video & Audio.....	26

Network	27
System	29
AVerCamera Setting Tool	31
Specification	32
Troubleshooting.....	35
Appendix	36
VISCA RS-232 Command Table	36
VISCA over IP Settings	44
CGI Command	45

Overview

The MD120UI Tracking Camera is a medical grade camera designed for patient monitoring. It features infrared night vision and UV-resistant casing.

Package Contents

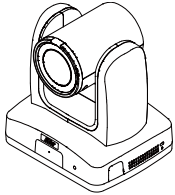

Camera

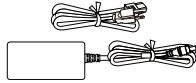

Power Adapter & Power Cord

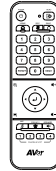

Remote Control



USB 3.0 Type-B to Type-A Cable (1.5m)

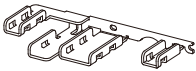

Cable Fixing Plate

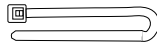

Cable Tie (x4)

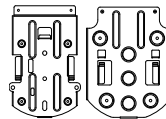

Ceiling Mount Bracket (x2)

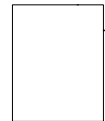

Drill Template



M2 x 4mm Screw (x3)



M3 x 6mm Screw (x3)



1/4\"-20 L=6.5mm Screw (x2)

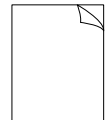

Quick Start Guide

Optional Accessories

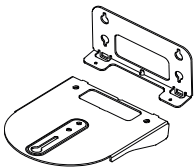

Wall Mount Bracket

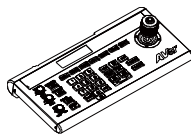

Camera Controller (CL01)

Dimensions

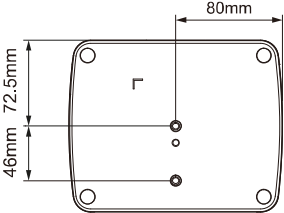
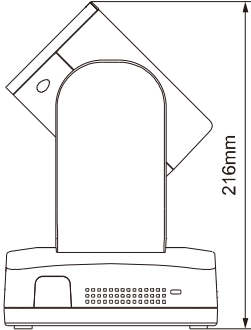
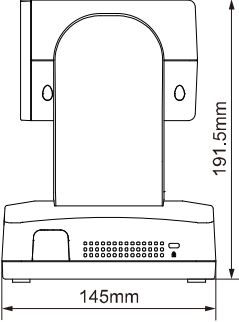
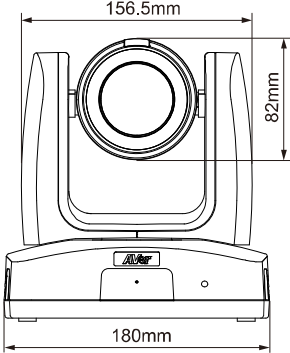

Ceiling Mount

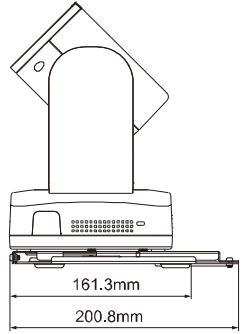
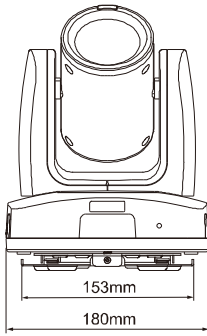
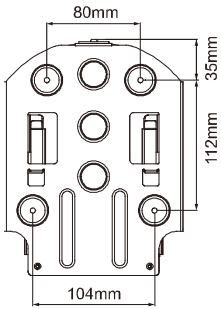
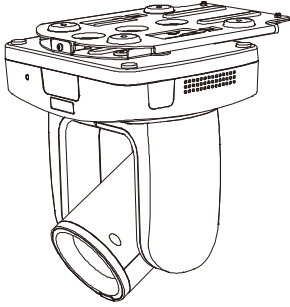

Wall Mount

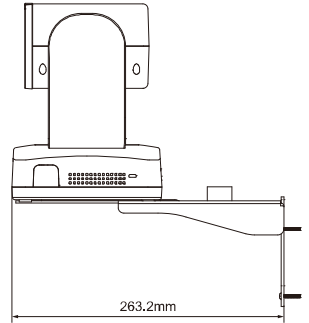
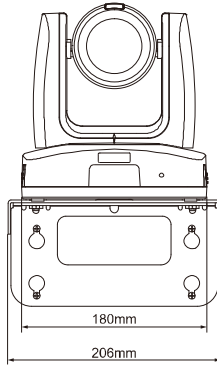
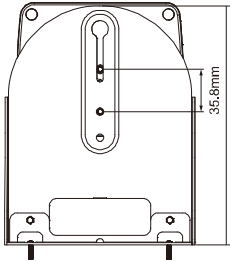
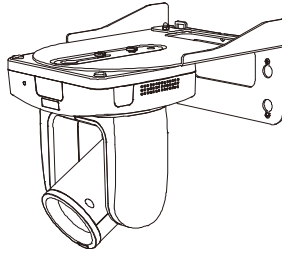
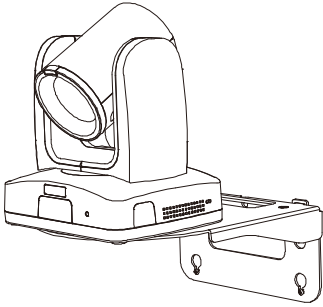

Pan and Tilt Angle

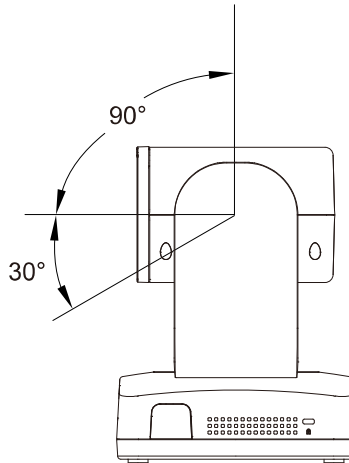
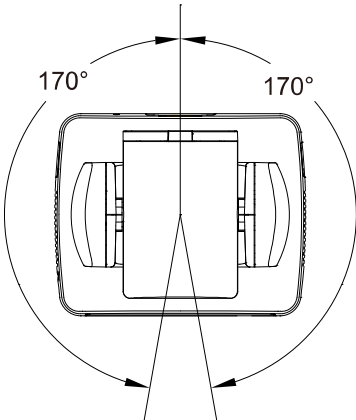

Installation

Cable Fixing Plate

1. Secure the cable fixing plate using the included M2 x 4mm screws.

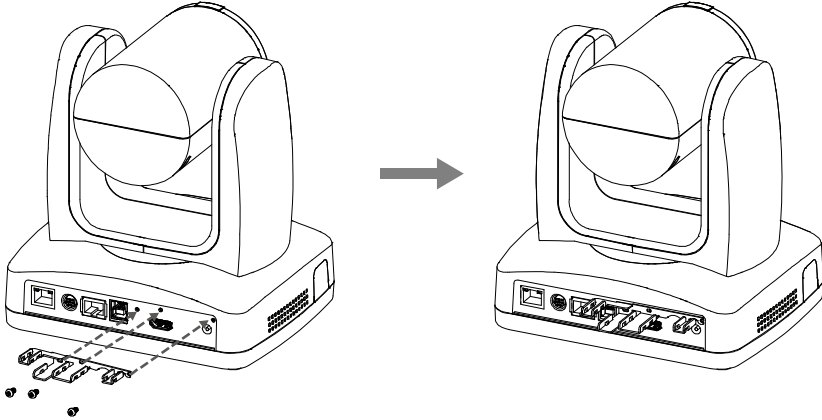

2. Connect the cables.

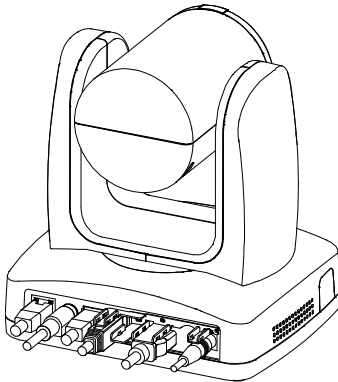

3. Fix the cables to the cable fixing plate with cable ties through the slots.

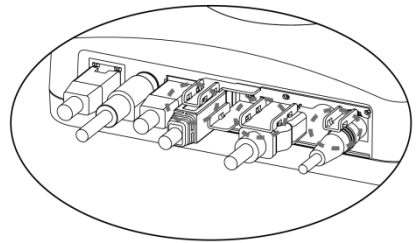

Ceiling Mount

1. Secure the bracket to the ceiling.
Screw: 4 screws, M4 x 10mm (not Included)

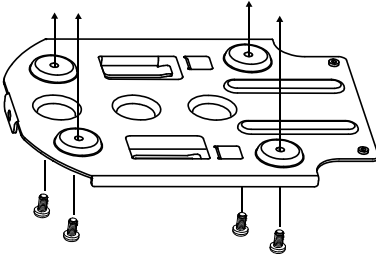

2. Secure the bracket to the camera.
Screw: 2 screws, 1/4"-20 L=6.5mm (included)

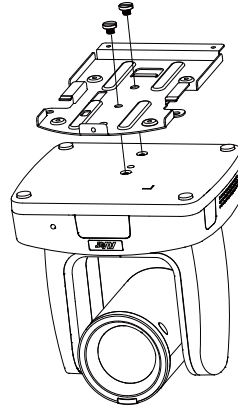

3. Slide the bracket with the camera into the bracket secured to the ceiling. And connect the cables.

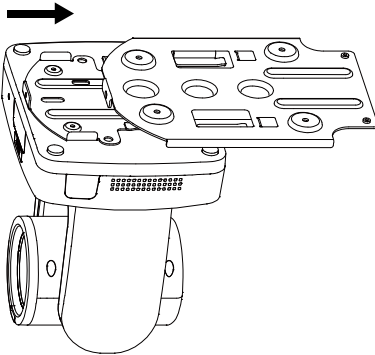

4. Fix the brackets with screws.
Screw: 3 screws, M3 x 6mm (included)

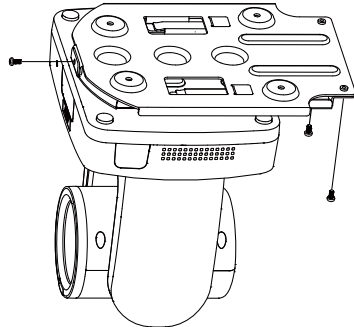

Connections

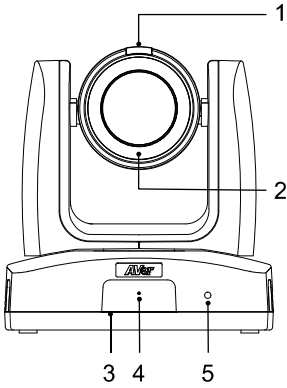

Front

- 1. Privacy Indicator
- 2. Infrared Night Vision LED*
- 3. IR Sensor
- 4. Microphone
- 5. LED Indicator

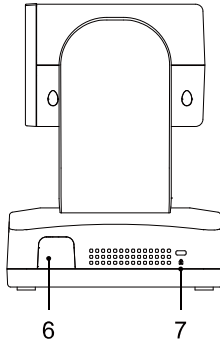

Side

- 6. IR Sensor
- 7. Kensington Lock

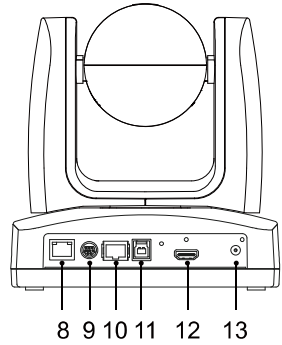

Back

- 8. PoE+ Port**
- 9. RS-232 Port
- 10. RS-422 Port
- 11. USB 3.1 Type-B Port
- 12. HDMI Port
- 13. DC Power Jack

*To avoid infrared radiation hazards, keep a distance of over 1 meter between IR LED and human eyes when using Night Mode.

**The PoE+ port is to be connected only to PoE networks without routing to the outside plant.

Privacy Indicator

Color	Status
Solid green	Monitoring patient
No light	Privacy Mode / power off

LED Indicator

Color	Status
Solid blue	Normal
Flashing blue	Tracking is turned on
Solid orange	Standby
Flashing orange	Starting up
Solid purple	OSD menu is turned on
Flashing purple	Updating firmware

Device Connection

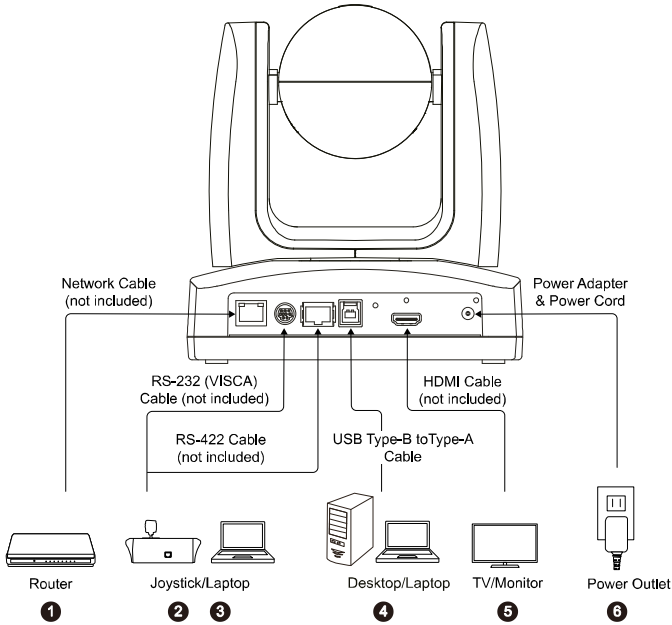

- LAN:** Connect the camera to an IP route (Note).
- RS-232:** Connect the camera to a Joystick or laptop to control the camera. You can optionally purchase the RS-232 Adapter. The PIN definition is shown as below (Note).

● Pin Definition

	Function	Mini DIN9 PIN #	I/O Type	Signal	Description
	VISCA IN	1	Output	DTR	Data Terminal Ready
		2	Input	DSR	Data Set Ready
		3	Output	TXD	Transmit Data
		6	Input	RXD	Receiver Data
	VISCA OUT	7	Output	DTR	Data Terminal Ready
		4	Input	DSR	Data Set Ready
		8	Output	TXD	Transmit Data
		9	Input	RXD	Receiver Data
		5	Input	I/O	Detect DIN8/DIN9
---	Shield	---	GND	Ground	

3. **RS-422:** Connect the camera to a Joystick or laptop to control the camera. Use a CAT5e splitter for multi-camera connection.

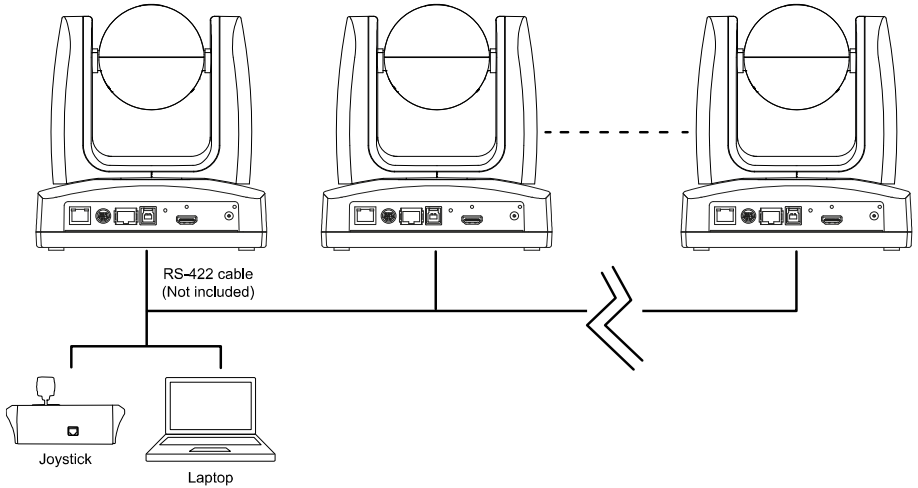

● **Pin Definition**

No.	Pin	No.	Pin
1	TX+	5	TX-
2	TX-	6	RX-
3	RX+	7	RX+
4	TX+	8	RX-

● **CAT5e Splitter Pin Assignment**

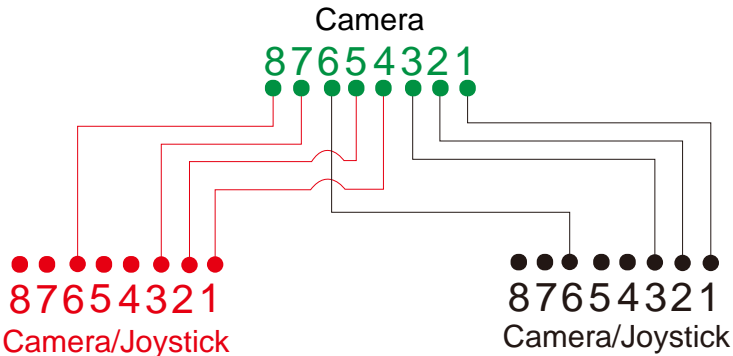

4. **USB Type-B:** Connect the camera to a desktop or laptop for video transmission when using third-party video conferencing software such as Skype or Teams (Note).
5. **HDMI:** Connect the camera to a TV or a monitor to display video output. The camera and the connected TV or monitor must have grounding design. (Note).
6. **Power:** The camera and the connected TV or monitor must have grounding design. Use the supplied power adapter and power cord to connect the camera to a power outlet and make sure the power cord of the TV or monitor supports the grounding plug.

Note:

Accessory equipment connected to the analog and digital interfaces must be in compliance with the respective nationally harmonized IEC standards (i.e. IEC 60950 for data processing equipment, IEC 60065 for video equipment, IEC 61010-1 for laboratory equipment, and IEC 60601-1 for medical equipment.) Furthermore all configurations shall comply with the requirements of the system in standard IEC 60601-1. Everybody who connects additional equipment to the signal input part or signal output part configures a medical system, and is therefore, responsible that the system complies with the requirements of the system in standard IEC 60601-1. The unit is for exclusive interconnection with IEC 60601-1 certified equipment in the patient environment and IEC 60XXX certified equipment outside of the patient environment. If in doubt, consult the technical services department or your local representative.

Remote Control

The remote control requires two AAA batteries. Make sure batteries are installed properly before use.

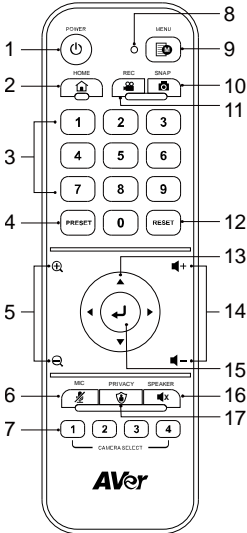







Model: LY033

Name	Function
1. Power	Short press to turn on/off Standby Mode.
2. Home	Move the camera to the Home position.
3. Number Pad	<ul style="list-style-type: none"> ● Press buttons 0~9 to move the camera to the pre-configure preset positions. ● Use the buttons to set up preset positions 0~9.
4. Preset	<p>Use the Preset, Number and Direction Buttons to set up preset positions:</p> <ol style="list-style-type: none"> 1. Use the Direction Buttons to navigate a position. Optionally use the “Zoom +” or “Zoom -” buttons to zoom in/out the image. 2. Press and hold Preset, then press the Number Buttons (0~9) to save this preset position.
5. Zoom +/-	Press to zoom in or zoom out the images.
6. MIC	Press to mute the microphone. Press again to unmute.
7. Camera Select	Select a camera to operate. Specify a number in the OSD menu: System > Camera Selector .
8. Remote Control LED	When pressing the buttons on the remote control, the LED will light red.
9. Menu	Press and hold for 3 seconds to open the OSD menu. Edit this setting in the OSD menu: System > Trigger OSD .
10.Snap	N/A
11.Rec	N/A
12.Reset	Use the Reset and Number Buttons to cancel a pre-configured preset position. Press and hold Reset, then press the Number Buttons (0~9).
13.Direction	Use the Direction Buttons to navigate the live view.

14. Volume +/-	N/A
15. Enter	When camera is on: Press Enter to adjust focus once. When accessing the OSD menu: Press Enter to confirm the selection or make a selection.
16. Speaker	N/A
17. Privacy	Press to enter the Privacy mode. The camera will move to the Privacy position and microphone will be off.

Shortcuts

Press	To
Menu  for 3 seconds	Open the OSD menu.
Menu 	Close the OSD menu.
Home 	Close the OSD menu and return the camera to the Home position.
Menu  then Zoom 	Switch between Day mode and Night mode.
Menu  then Zoom 	Switch between Day mode and Auto mode.
5 five times (55555)	Turn on DHCP.
6 six times (666666)	Reset the camera to factory default settings.
8 eight times (88888888)	Set the camera's static IP address to 192.168.1.168.

Set up the Camera

Configure camera settings through the OSD menu or the web interface.

OSD Menu

To access the OSD menu, connect the camera to a monitor or TV using an HDMI cable, and then use the supplied remote control to operate the OSD menu.

Press and hold **Menu**  for 3 seconds to open the OSD menu. Use directional buttons **▲▼◀▶** to select and press Enter **↵** to confirm settings.

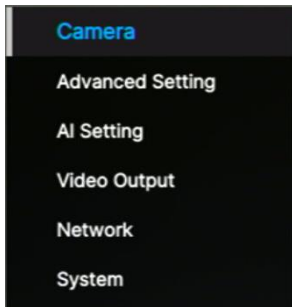

IP Address Setup

Static IP



1. Press and hold **Menu**  for 3 seconds on the remote control to open the OSD menu.
2. Go to **Network > Static IP**.

[Note] Turn the **DHCP** off before setting up static IP (**Network > DHCP > OFF**).

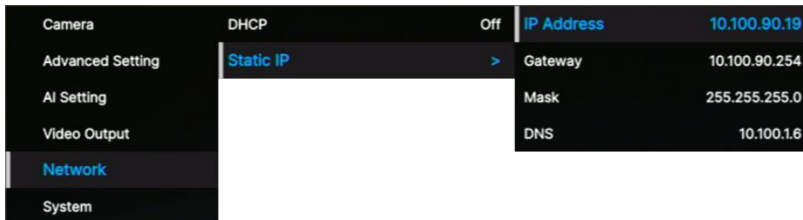
3. Select the **IP Address**, **Gateway**, **Netmask**, and **DNS** to configure. Press Enter **↵** and use the number buttons to enter the value.



DHCP

1. Press and hold **Menu**  for 3 seconds on the remote control to open the OSD menu.
2. Select **Network > DHCP > On**.
3. Press Enter  to confirm setting.

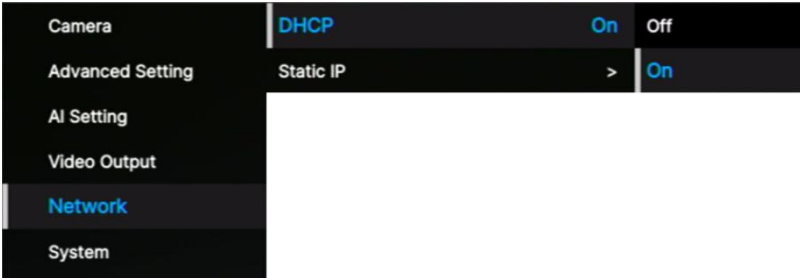

4. After turning the **DHCP** on, you can go to **System > Information** to view the IP address.

Camera	Trigger OSD	Press Menu 3 sec	Model Name	MD120UI
Advanced Setting	Camera Selector	All	Serial Number	5100435000010
AI Setting	Status OSD	Off	Version	1.10502.0
Video Output	Language	English	IP Address	0.0.0.0
Network	Information	>	MAC	00:18:1A:0C:BA:4E
System	Factory Default	>	Lens	C004
	System Reboot	>	Mcu	A001

OSD Menu Tree

1st level	2nd level	3rd level	4th level
Camera	Exposure Mode	Full Auto	Exposure Value
			Gain Limit Level
			Slow Shutter
			BLC
			WDR
		Shutter Priority	Exposure Value
			Shutter Speed
			Gain Limit Level
		Iris Priority	Exposure Value
			Iris Level
			Gain Limit Level
			Slow Shutter
		Manual	Iris Level
			Shutter Speed
			Gain Level
	Bright mode	Bright value	
	White Balance	Auto	
		ATW	
		Indoor	
		Outdoor	
		One push trigger	
		Manual	R gain
	B gain		
	Pan Tilt Zoom	Preset Speed	5, 25, 50, 100, 150, 200
		Preset Accuracy	Off / On
		Pan Speed	1~24
		Tilt Speed	1~24
		Zoom Speed	Low / High
P/T Spd. Relative Z Ratio		Off / On	
Pan L/R Dir. Switch		Off / On	

	Noise filter	Off / Low / Middle / High	
	Saturation	0 1 2 3 4 5 6 7 8 9 10	
	Contrast	0 1 2 3 4	
	Sharpness	0 1 2 3	
	Mirror	OFF / ON	
	Flip	OFF / ON	
Advanced Setting	Audio	Audio Volume	0~10
	Control	Type	RS232 / RS422
		Protocol	VISCA
		Camera Address	1 2 3 4 5 6 7
		Baud Rate	4800 / 9600 / 38400
	IR Cut Filter	Auto / Day / Night	
IR Cut Sensitivity	Low / Middle / High		
AI Setting	Facial Tracking	Eyes Tracking	On/Off
		Tracking Preset	Save
		Tracking Site	Full Face / Eyes
		Tracking Range	Close / Medium / Wide
		Timeout to Preset	3/5/7/10 sec
	AI Audio Detection	Audio Detection	On/Off
Video Output	Theme Mode	HDMI / UVC	
	Frequency	60	
		59.94	
		50	
	Resolution	2160p60	
		2160p59	
		2160p50	
		2160p30	
		2160p29	
		2160p25	
		1080p60	
		1080p59	
	1080p50		

		1080p30	
		1080p29	
		1080p25	
		1080i60	
		1080i59	
		1080i50	
		720p60	
		720p59	
		720p50	
Network	DHCP	OFF	
		ON	
	Static IP	IP Address	192.168.1.168
		Gateway	192.168.1.254
		Mask	255.255.255.0
DNS	8.8.8.8		
System	Trigger OSD	Click Menu to open, Press Menu 3 sec	
	Camera Selector	1,2,3,4,All channel, Disable Remote	
	Status OSD	OFF	
		ON	
	Language	English / 中文 / 日本語	
	Information	Model Name	MD120UI
		Serial number	xxxxxxxxxxxxx
		Firmware Version	0.0.0000.00
		IP	192.168.1.168
		MAC	00:18:1a:04:9e:81
		Lens	xxxx
Mcu	xxxx		
Factory Default	Off / On		
System Reboot	Off / On		

Web Interface

Connect the camera from a remote site through the internet.

Access the Web Interface of the Camera

To access the Web interface of the camera, you have to find the IP address of the camera using AVer IPCam Utility or AVer PTZ Management software.

Access via AVer IPCam Utility

To find the IP address of your cameras using the IPCam Utility installer, follow the steps below.

1. Download the IPCam Utility from <https://www.aver.com/download-center> and run the IPCam Utility.
2. Click **Search**, and all available devices will be listed on the screen.
3. Select a camera from the list, the camera info will be displayed in the Settings field.

[Note] The default network of the camera is Static IP (192.168.1.168) and default ID/Password are **admin/admin**. If you want to configure the network to DHCP, input the ID/Password in the **Login** field, select the “camera model” on the list, select “DHCP” and then click the **Apply** button.

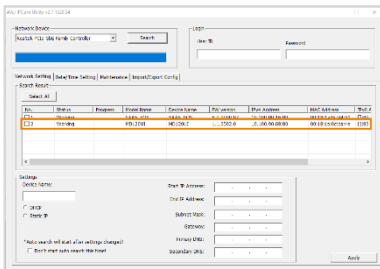

4. To access the Web interface, double-click on the IP address in the IPV4 Address column. For the first-time user, you will be prompted with a Login window to change the ID and password.

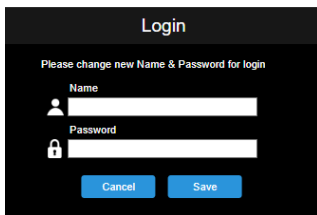

5. Login with the new ID/Password, the Web interface of the camera will be displayed (Chrome browser). Please refer to the [<Live View>](#) chapter for more details.

[Note] If IPCam utility cannot find the camera, please check following:

1. Please make sure the Ethernet connection of camera is well connected.
2. The camera and PC (IPCam Utility) are in the same LAN segment.

Access via AVer PTZ Management

To find the IP address of your cameras using the AVer PTZ Management, follow the steps below.

1. Download the AVer PTZ Management software from <https://www.aver.com/download-center>
2. Download the Windows program and install it.
3. After setting up the user ID and password, log in to the software (default User Name/Password: admin/admin).

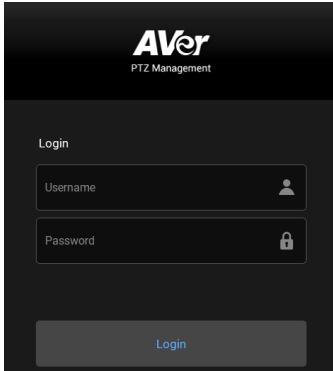

4. On the Main page of PTZ Management, click **Setup > Add** and then click **Auto Search**. The cameras connected on the same LAN with the computer will be displayed.

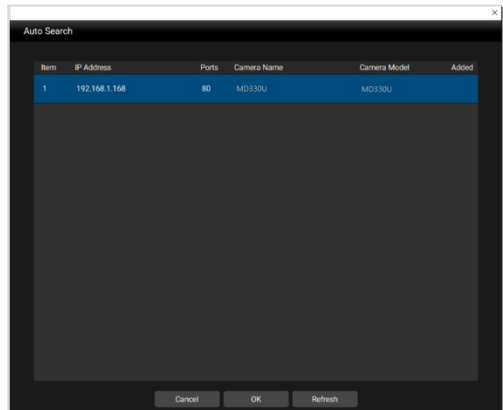
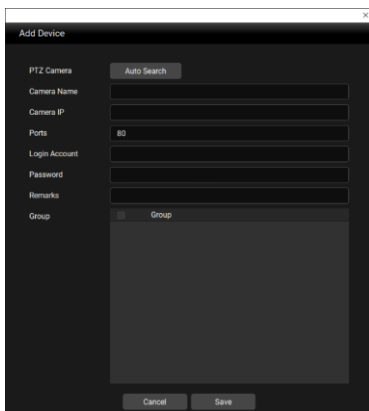

5. Click on the camera and input the camera ID and Password to add the camera to the device list (default ID/Password are **admin/admin**). Click the **Go to Web** button to access the Web interface of the camera.

Live View

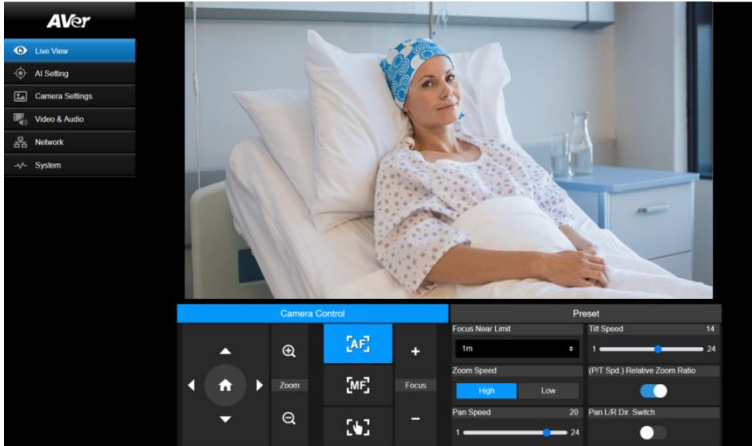

Camera Control

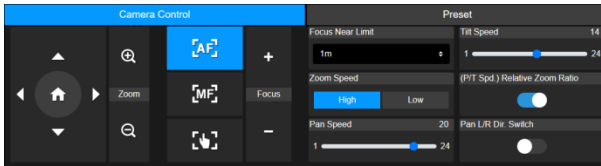

Item	Description
Pan and Tilt Controls 	Position the camera. <ul style="list-style-type: none"> ● Drag the slider to adjust Pan Speed and Tilt Speed. ● Turn on Pan L/R Dir. Switch to invert panning direction. ● Turn on P/T Spd. Relative Z Ratio to automatically adjust pan and tilt speeds based on the zoom ratio. You can also turn it on in the OSD menu: Camera > Pan Tilt Zoom > P/T Spd. Relative Z Ratio.
Home Position	Move the camera to the Home position.
Zoom	Zoom in or zoom out the live view and select Zoom Speed.
Focus +- 	<ul style="list-style-type: none"> ● Auto Focus: Click to automatically focus. ● Manual Focus: Click to manually focus. Adjust the focus with +- buttons. ● One Push Focus: Click to automatically focus once. ● Focus Near Limit: Set up the nearest focus limit.

Preset



Item	Description
Save Preset	<ol style="list-style-type: none">1. Position the camera using pan, tilt and zoom controls.2. Enter a preset number (0~255) in the Save Preset field and click Save.
Load Preset	<ol style="list-style-type: none">1. Enter a preset number (0~255) in the Load Preset field and click Load.2. Or click a preset number (0~19) in the Quick Call section.
Preset Accuracy	Turn on to improve the accuracy of moving to presets.
Video Freeze while Preset	Turn on to display only the live view from presets. The live view from the moving path will not be displayed.
Preset Speed	Adjust the camera speed when moving to presets.

AI Setting



Eyes Tracking

Manually adjusting pan, tilt and zoom controls during Eyes Tracking will turn off the function.

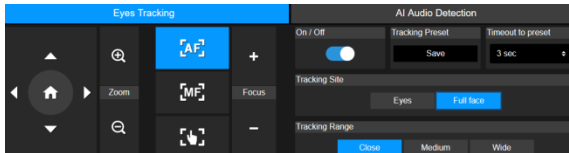

1. Position the camera using pan, tilt and zoom controls and then click **Save** to save a **Tracking Preset**. The default is the Home position.
2. From the **Timeout to preset** drop-down list, select an interval before the camera returns to the tracking preset when no one is in view. The default is 3 seconds.
3. Click the **On/Off** toggle to turn on Eyes Tracking when a face is in view.
 - One person: The camera will automatically track and zoom in on the face.
 - Multiple people: The camera will mark faces in squares. Select a face to automatically track and zoom in on by clicking a square.
4. Choose the **Tracking Site** and **Tracking Range**.

(Beta) AI Audio Detection

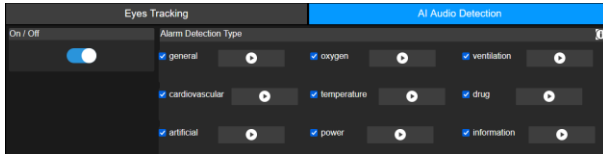

1. Turn on to detect selected alarms.
2. Click the play button to preview alarm sounds.

Camera Settings



Exposure

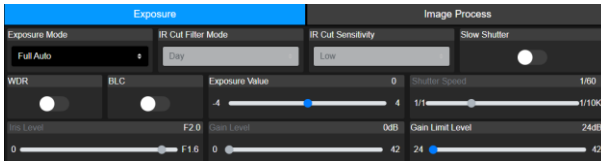

Item	Description
Exposure Mode	Select an exposure mode.
WDR	Turn WDR or BLC on or off.
BLC	
Exposure Value	Adjust exposure, shutter, iris and gain.
Shutter Speed	
Iris Level	
Gain Level	
Gain Limit Level	
IR Cut Filter Mode	Select Day mode, Night mode to switch infrared night vision on or off., Or select Auto mode and adjust IR Cut Sensitivity .
Slow Shutter	Turn Slow Shutter on or off.

Image Process

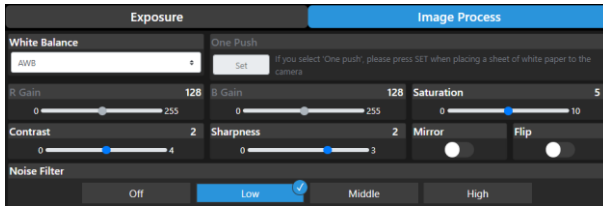

Item	Description
White Balance	<ul style="list-style-type: none">● Select a white balance mode. When Manual is selected, you can also adjust the R Gain and B Gain.● When One Push is selected, place a piece of white paper in front of the camera lens and click Set to calibrate white balance.
Saturation	
Contrast	Adjust saturation, contrast and sharpness.
Sharpness	
Mirror	
Flip	Turn Mirror or Flip on or off.
Noise Filter	Select a noise filtering level.

Video & Audio

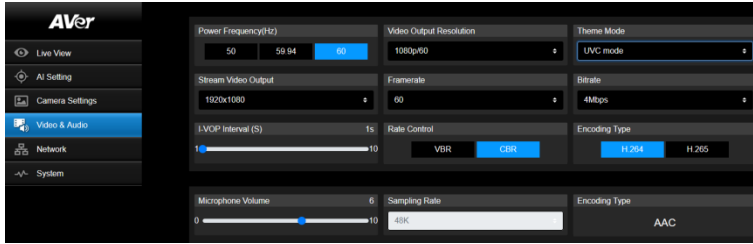

Video Setting

Item	Description
Power Frequency (Hz)	Select 50Hz , 59.94Hz or 60Hz based on your country or region.
Video Out Resolution	Select a video output. resolution RTSP: Max. 4K/60fps HDMI: Max. 4K 60Hz
Theme Mode	Select a video overlay to prioritize UVC or HDMI output.
Stream Video Output	Select a streaming output resolution for the live view.
Framerate	Select a framerate
Bitrate	Select a bitrate.
I-VOP Interval (S)	<ul style="list-style-type: none"> ● Drag the slider to choose how often I-VOPs appear in a video stream. ● Shorter I-VOP intervals result in higher video quality but also larger file sizes.
Rate Control	Select VBR or CBR .
Encoding Type	Select H.264 or H.265 .

Audio Setting

Item	Description
Microphone Volume	Drag the slider to adjust the microphone volume.
Sampling Rate	48K
Encoding Type	AAC

Network

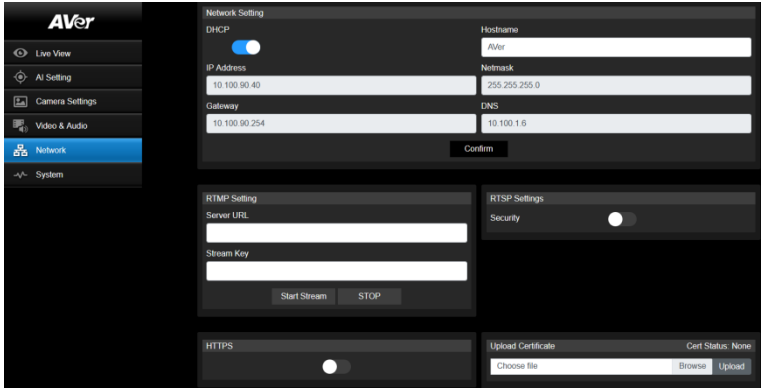

Item	Description
Hostname	The default hostname is AVer. Change the hostname to be displayed on devices such as an IP router.
DHCP	Set the network to DHCP or Static IP. <ul style="list-style-type: none"> ● DHCP: Turn on DHCP and click Confirm to save the setting. The camera will be assigned IP settings automatically. ● Static IP: Turn off DHCP, enter IP Address, Netmask, Gateway and DNS, and click Confirm to save the settings.
RTMP Setting	Stream live video to a video platform such as YouTube. <ol style="list-style-type: none"> 1. Enter the Server URL and Stream Key of your video platform. Please refer to the instruction of your platform to obtain the server URL and stream key. 2. Click Start Stream to start streaming, Stop to stop streaming.
RTSP Settings	Protect your video stream on media players such as VLC, PotPlayer and QuickTime by ensuring that only authorized users can access it. <ul style="list-style-type: none"> ● When Security is turned off: <ol style="list-style-type: none"> 1. Enter your camera's RTSP URL into the media player. 2. RTSP URL: rtsp://[camera IP address]/live_st1 Example: rtsp://192.168.1.100/live_st1 ● When Security is turned on: <ol style="list-style-type: none"> 1. Enter your camera's RTSP URL and username/password into the media player. 2. RTSP URL: rtsp://[username:password]@[camera IP address]/live_st1

Example: rtsp://1:1@192.168.1.100/live_st1

3. username/password: camera's username/password (web interface login)

HTTPS

Enable HTTPS to establish a secure connection between your browser and your camera. To enable HTTPS access on your camera:

1. Obtain a SSL certificate for encryption and decryption in base-64 encoded format and use a private key in PKCS#8 format (unencrypted).
 2. Package the required certificate content into PEM format. The SSL certificate uploaded to the camera must be in PEM format.
 3. Click **Browse** to select the certificate file, and then click **Upload**.
 4. Turn on HTTPS.
-

System

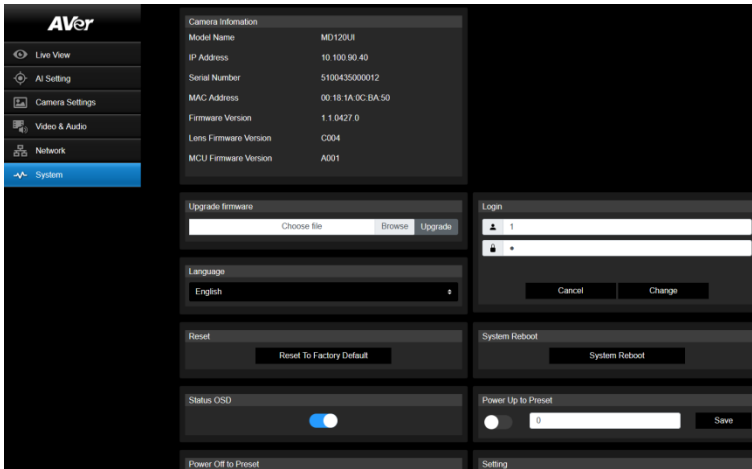

Item	Description
Camera Information	Display camera information.
Upgrade Firmware	<p>Follow these steps to upgrade the firmware:</p> <ol style="list-style-type: none"> 1. Download the latest firmware from the AVer Download Center (https://www.aver.com/download-center/). 2. On the Web page, go to System > Upgrade firmware. 3. Click Browse to select the firmware. 4. Click Upgrade to start upgrading the firmware. 5. Refresh the browser after the upgrade process is complete. <p>[Note] Keep your camera connected to a power source during firmware upgrade. Network connection will be lost during the process and camera will reboot automatically after upgrading.</p>
Login	The default username/password is admin/admin . To change the username/password, enter the new username/password and click Change .
Language	Change the web interface language.
Reset	Reset the camera to factory default settings.
System Reboot	Restart your camera.
Status OSD	Enable to display preset status on the HDMI output during functions such as saving, loading and canceling presets.

Power Up to Preset	<p>When enabled, the camera will move to the defined position after powering on.</p> <ul style="list-style-type: none">● Click the toggle to turn on > enter a preset number > click Save.● Make sure the preset number has been defined before enabling this function.
Power Off to Preset	<p>When enabled, the camera will move to the defined position before powering off.</p> <ul style="list-style-type: none">● Click the toggle to turn on > enter a preset number > click Save.● Make sure the preset number has been defined before enabling this function.
Setting	Export or import your camera settings
Help Us Improve	Opt-in or opt-out of providing anonymous usage data.

AVerCamera Setting Tool

AVerCamera Setting Tool is an application software that supports the operation of AVer PTZ cameras when you stream to a third-party software. It enables users to configure image, audio and video settings without a remote control, as well as connect the camera via USB.

- Download AVerCamera Setting Tool from the AVer website:
(<https://www.aver.com/Downloads/search?q=AVer%20Camera%20Setting%20Tool>).
- For details on settings, see <AVerCamera Setting Tool> in the user manual for CaptureShare.

Specification

Camera	
Image Sensor	1/2.8" CMOS
Effective Picture Elements	8 Megapixels
Output Resolutions	Resolution: 4K/1080p/720p Frame Rate: 60/59.94/50/30/29.97/25
Minimum Illumination	0.5 lux (50 IRE, F1.6, Max. AGC, 1/30)
S/N Ratio	≥ 50dB
Gain	Auto, Manual
TV Lines	1000 (center/wide)
Shutter Speed	1/1 to 1/10,000 sec
Exposure Control	Auto, Manual, Priority AE (Shutter, IRIS), BLC, WDR
White Balance	Auto, Manual
Optical Zoom	20X
Digital Zoom	1X
Total Zoom	20X
Viewing Angles	DFOV : 69.2° (Wide) to 4.1° (Tele) HFOV : 62.3° (Wide) to 3.6° (Tele) VFOV : 37.3° (Wide) to 2.1° (Tele)
Focal Length	f = 4.5 mm (Wide) to 90 mm (Tele)
Aperture (Iris)	F = 1.8 (Wide) to 4.7 (Tele)
Minimum Working Distance	Wide: 0.1 m, Tele: 1.2 m
Pan / Tilt Angles	Pan: ±170°, Tilt: +90° / -30°
Pan / Tilt Speed (Manual)	Pan: 0.1° to 100°/sec, Tilt: 0.1° to 100°/sec
Preset Speed	Pan: 200°/sec, Tilt: 200°/sec
Preset Position	10 (IR), 256 (RS-232, RS-422, IP)
Camera Control - Interfaces	RS-232 / RS-422 / Ethernet
Camera Control - Protocols	VISCA (RS-232/RS-422/IP), CGI (IP)
Image Processing	Mirror / Flip / Freeze / WDR / BLC
Power Frequencies	50 Hz, 60 Hz
AI Functions	
Modes	Eyes Tracking
Privacy	
Protection Mode	Privacy Mode



General	
Power Requirement	12V
Power Consumption	24W
PoE	PoE+ (IEEE802.3at)
Dimension (W x H x D)	180(W) x 145(D) x 183.5(H) mm
Net Weight	1.7±0.1 kg
Application	Indoor
Tally Lamp	Yes
Security	Kensington Slot
IR Remote Control	Yes
Operating Conditions	Temperature : 0 °C to +40 °C Humidity : 20% to 80%
Storage Conditions	Temperature : -20 °C to +60 °C Humidity : 20% to 95%
Audio	
Channels	2ch Stereo
Codecs	AAC-LC (48K)
Interface	
Video Outputs	HDMI, IP, USB
Audio Outputs	HDMI, IP, USB
Audio Inputs	N/A
IP Streaming	
Resolution	4K 60fps
Network Video Compress Formats	H.264, H.265, MJPEG
Maximum Frame Rate	4K 60fps
Bit-Rate Control Modes	VBR, CBR
Range of Bit-Rate	512Kbps ~ 64Mbps
Network interfaces	10 / 100 / 1000 Base-T
Multi-Stream Capability	2 (RTSP/Web page), MAX: 4K 60fps
Network Protocols	IPv6,IPv4, TCP, UDP, ARP, IMCP, IGMP, HTTP, DHCP RTP/RTCP, RTSP, RTMP,VISCA over IP

USB	
Connector	USB3.0 (Type-B)
Video Formats	MJPEG
Maximum Video	2160p
USB Video Class (UVC)	UVC1.1
USB Audio Class (UAC)	UAC 1.0
Web UI	
Live Video Preview	Yes
Camera PTZ Control	Pan, Tilt, Zoom, Focus, Preset Control
Camera / Image	Exposure, White Balance, Image Process
Network Configuration	DHCP, IP Address, Gateway, Subnet Mask, DNS
Software Tools	
IP Search and Configuration Tool	Support Windows® 7 or later
PTZ Management	Support Windows® 7 or later
PTZ Control Panel	Supports iOS & iPadOS® 11 or later
Camera Setting Tool	Supports Windows® 7 or later, macOS® 10.14 or later

Specifications are subject to change without prior notice.

Troubleshooting

The image is distorted or blurry.

- On the web interface, go to **Live View > Camera Control** and click  **Auto Focus**.
- On the remote control, press and hold **Menu**  for 3 seconds > **Factory Default > On** to return all settings to factory default.

How to open the on-screen display (OSD) menu?

1. Make sure the HDMI cable is connected to your camera and display.
2. On the remote control, press and hold **Menu**  for 3 seconds to open the OSD menu.
3. A solid purple light on the LED indicator will indicate that the OSD menu is turned on.

Appendix

VISCA RS-232 Command Table

Command Set	Command	Command Packet	Comments
Command Set	Command	Command Packet	Comments
IF_Clear	Broadcast	88 01 00 01 FF	I/F Clear (Clear Visca connection & command buffer queue)
CommandCancel	--	8x 2p FF	p: Socket No. (=1or2)
CAM_Power	On	8x 01 04 00 02 FF	Power OFF to Standby mode
	Off	8x 01 04 00 03 FF	Power ON supported in Standby mode only
CAM_Zoom	Stop	8x 01 04 07 00 FF	Zoom Control
	Tele(Standard)	8x 01 04 07 02 FF	
	Wide(Standard)	8x 01 04 07 03 FF	
	Tele(Variable)	8x 01 04 07 2p FF	p=0 (Low) to 7 (High)
	Wide(Variable)	8x 01 04 07 3p FF	
	Direct	8x 01 04 47 0p 0q 0r 0s FF	pqrs: Zoom Position. MD120UI: 0x00F0 (x1) ~ 0x5378 (x20)
CAM_Focus	Stop	8x 01 04 08 00 FF	Focus Control Each 'Far/Near' needs a 'stop'
	Far (Standard)	8x 01 04 08 02 FF	
	Near (Standard)	8x 01 04 08 03 FF	
	Far (Variable)	8x 01 04 08 2p FF	p=0 (Low) to 7 (High)
	Near (Variable)	8x 01 04 08 3p FF	
	Auto Focus	8x 01 04 38 02 FF	AF ON/OFF
	Manual Focus	8x 01 04 38 03 FF	
	Auto/Manual	8x 01 04 38 10 FF	
	One Push	8x 01 04 18 01 FF	
	Direct	8x 01 04 48 0p 0q 0r 0s FF	pqrs: Focus Position, MD120UI: 0x0000(wide) ~ 0x4000(tele)
	Near Limit	8x 01 04 28 0p 0q 0r 0s FF	pqrs: Focus Near Limit Position 0001: 0.01m 0002: 1m 0003: 1.5m 0004: 2m 0005: 3m 0006: 6m 0007: 10m
CAM_AFMode	Normal AF	8x 01 04 57 00 FF	Continuous AF ON

Command Set	Command	Command Packet	Comments
	Zoom Trigger AF	8x 01 04 57 02 FF	Continuous AF OFF, only trigger AF after PTZ done
CAM_WB	Auto	8x 01 04 35 00 FF	Normal Auto
	ATW	8x 01 04 35 04 FF	
	Indoor	8x 01 04 35 01 FF	
	Outdoor	8x 01 04 35 02 FF	
	One Push WB	8x 01 04 35 03 FF	One Push WB mode
	Manual	8x 01 04 35 05 FF	Manual Control mode
	One Push Trigger	8x 01 04 10 05 FF	One Push WB Trigger
CAM_RGain	Reset	8x 01 04 03 00 FF	Manual Control of R Gain
	Up	8x 01 04 03 02 FF	
	Down	8x 01 04 03 03 FF	
	Direct	8x 01 04 43 00 00 0p 0q FF	pq: R Gain
CAM_BGain	Reset	8x 01 04 04 00 FF	Manual Control of B Gain
	Up	8x 01 04 04 02 FF	
	Down	8x 01 04 04 03 FF	
	Direct	8x 01 04 44 00 00 0p 0q FF	pq: B Gain
CAM_AE	Full Auto	8x 01 04 39 00 FF	Automatic Exposure mode
	Manual	8x 01 04 39 03 FF	Manual Control mode
	Shutter Priority	8x 01 04 39 0A FF	Shutter Priority Automatic Exposure mode
	Iris Priority	8x 01 04 39 0B FF	Iris Priority Automatic Exposure mode
CAM_SlowShutter	Auto	8x 01 04 5A 02 FF	Auto Slow Shutter ON/OFF
	Manual	8x 01 04 5A 03 FF	
CAM_Shutter	Reset	8x 01 04 0A 00 FF	Shutter Setting
	Up	8x 01 04 0A 02 FF	
	Down	8x 01 04 0A 03 FF	
	Direct	8x 01 04 4A 00 00 0p 0q FF	pq: Shutter Position
CAM_Iris	Reset	8x 01 04 0B 00 FF	Iris Setting
	Up	8x 01 04 0B 02 FF	
	Down	8x 01 04 0B 03 FF	
	Direct	8x 01 04 4B 00 00 0p 0q FF	pq: Iris Position

Command Set	Command	Command Packet	Comments
CAM_Gain	Reset	8x 01 04 0C 00 FF	Gain Setting
	Up	8x 01 04 0C 02 FF	
	Down	8x 01 04 0C 03 FF	
	Direct	8x 01 04 4C 00 00 0p 0q FF	pq: Gain Position
	AE Gain Limit	8x 01 04 2C 0p FF	p: Gain Position (8 to E: 24db~42db)
CAM_Bright	Up	8x 01 04 0D 02 FF	--
	Down	8x 01 04 0D 03 FF	
	Direct	8x 01 04 4D 00 00 0p 0q FF	pq: Bright Position
CAM_ExpComp	Reset	8x 01 04 0E 00 FF	Exposure Comp Amount Setting
	Up	8x 01 04 0E 02 FF	
	Down	8x 01 04 0E 03 FF	
	Direct	8x 01 04 4E 00 00 0p 0q FF	pq: ExpComp Position
CAM_Backlight	On	8x 01 04 33 02 FF	Back Light Compensation ON/OFF
	Off	8x 01 04 33 03 FF	
CAM_LR_Reverse	On	8x 01 04 61 02 FF	Mirror Image ON/OFF
	Off	8x 01 04 61 03 FF	
CAM_Flip	On	8x 01 04 66 02 FF	Flip ON/OFF
	Off	8x 01 04 66 03 FF	
CAM_Preset	Reset	8x 01 04 3F 00 pp FF	Preset Cancel. pp: Preset Number 0x00~0xFF
	Set	8x 01 04 3F 01 pp FF	Preset Save.
	Recall	8x 01 04 3F 02 pp FF	Preset Load.
CAM_Menu	On	8x 01 06 06 02 FF	Menu Display ON/OFF
	Off	8x 01 06 06 03 FF	
	On/Off	8x 01 06 06 10 FF	
CAM_MenuEnter	--	8x 01 7E 01 02 00 01 FF	Enter Submenu
CAM_NR	--	8x 01 04 53 0p FF	p: Image NR Setting (0:OFF, Level1 to 3)
CAM_WDR	On	8x 01 04 3D 02 FF	Wdr ON/OFF
	Off	8x 01 04 3D 03 FF	
CAM_ICR	On	8x 01 04 01 02 FF	Infrared Mode ON (Night)
	Off	8x 01 04 01 03 FF	Infrared Mode OFF (Day)

Command Set	Command	Command Packet	Comments
CAM_AutoICR	On	8x 01 04 51 02 FF	Auto Infrared mode ON/OFF
	Off	8x 01 04 51 03 FF	
	Threshold	8x 01 04 21 00 00 0p 0q FF	pp: ICR OFF(Day)->ON(Night) threshold level 00: Low; 01: Middle; 02: High
CAM_IDWrite	--	8x 01 04 22 0p 0q 0r 0s FF	pqrs: Camera ID (=0000 to FFFF)
Video Format Change	--	8x 01 7E 01 1E 0p 0q FF	pp
			0x02: 1920x1080P/60
			0x03: 1920x1080P/59.94
			0x04: 1920x1080P/30
			0x05: 1920x1080P/29.97
			0x08: 1920x1080I/60
			0x0A: 1920x1080I/59.94
			0x0B: 1280x720P/60
			0x0C: 1280x720P/59.94
			0x0D: 1920x1080P/50
			0x18: 1920x1080P/25
			0x22: 1920x1080I/50
			0x26: 1280x720P/50
			0x30: 3840x2160P/60
			0x31: 3840x2160P/59.94
			0x32: 3840x2160P/50
			0x33: 3840x2160P/30
0x34: 3840x2160P/29.97			
0x35: 3840x2160P/25			
IR_Receive	On	8x 01 06 08 02 FF	Infrared remote commander reception ON
Pan-tilt Drive	Up	8x 01 06 01 VV WW 03 01 FF	VV: Pan speed setting 0x01 (low speed) to 0x18 (high speed) WW: Tilt speed setting 0x01 (low speed) to 0x18 (high speed) YYYY: Pan Position 7FFF(170°) to 8000(-170°) (Normalized, CENTER 0000) ZZZZ: Tilt Position 7FFF(90°) to 8000(-30°)
	Down	8x 01 06 01 VV WW 03 02 FF	
	Left	8x 01 06 01 VV WW 01 03 FF	
	Right	8x 01 06 01 VV WW 02 03 FF	
	UpLeft	8x 01 06 01 VV WW 01 01 FF	

Command Set	Command	Command Packet	Comments
	UpRight	8x 01 06 01 VV WW 02 01 FF	(Image Flip: OFF) (Normalized, CENTER 0000)
	DownLeft	8x 01 06 01 VV WW 01 02 FF	
	DownRight	8x 01 06 01 VV WW 02 02 FF	
	Stop	8x 01 06 01 VV WW 03 03 FF	
	AbsolutePosition	8x 01 06 02 VV WW 0Y 0Y 0Y 0Y 0Z 0Z 0Z 0Z FF	
	RelativePosition	8x 01 06 03 VV WW 0Y 0Y 0Y 0Y 0Z 0Z 0Z 0Z FF	
	Home	8x 01 06 04 FF	
	Reset	8x 01 06 05 FF	
Freeze	Freeze On	8x 01 04 62 02 FF	Freeze On Immediately
	Freeze Off	8x 01 04 62 03 FF	Freeze Off Immediately
	Preset Freeze On	8x 01 04 62 22 FF	Freeze On When Running Preset
	Preset Freeze Off	8x 01 04 62 23 FF	Freeze Off When Running Preset
RTMP	On	8x 01 04 A2 02 FF	RTMP ON/OFF
	Off	8x 01 04 A2 03 FF	
Reboot	On	8x 01 04 A4 FF	System reboot
P/T Spd. Relative Zoom Ratio	On	8x 01 04 A6 02 FF	P/T Speed Relative Zoom Ratio ON/OFF
	Off	8x 01 04 A6 03 FF	
Factory Reset	System Factory Reset	8x 01 04 3F 03 00 FF	
Preset Speed	Set Preset Speed	8x 01 06 20 0p FF	p=1 (Low) to 6 (High)

Inquiry Command	Command Packet	Inquiry Packet	Comments
Inquiry Command	Command Packet	Inquiry Packet	Comments
CAM_PowerInq	8x 09 04 00 FF	y0 50 02 FF	On
		y0 50 02 FF	Off
CAM_ZoomPosInq	8x 09 04 47 FF	y0 50 0p 0q 0r 0s FF	pqrs: Zoom Position
CAM_FocusModelInq	8x 09 04 38 FF	y0 50 02 FF	Auto Focus
		y0 50 03 FF	Manual Focus
CAM_FocusPosInq	8x 09 04 48 FF	y0 50 0p 0q 0r 0s FF	pqrs: Focus Position
CAM_FocusNearLimitInq	8x 09 04 28 FF	y0 50 0p 0q 0r 0s FF	pqrs: Focus Near Limit Position
CAM_AFModelInq	8x 09 04 57 FF	y0 50 00 FF	Continuous AF ON
		y0 50 02 FF	Continuous AF OFF, only trigger AF after PTZ done
CAM_WBModelInq	8x 09 04 35 FF	y0 55 00 FF	Auto
		y0 55 04 FF	ATW
		y0 55 01 FF	Indoor
		y0 55 02 FF	Outdoor
		y0 55 03 FF	One Push WB
		y0 55 05 FF	Manual
CAM_RGainInq	8x 09 04 43 FF	y0 50 00 00 0p 0q FF	pq: R Gain
CAM_BGainInq	8x 09 04 44 FF	y0 50 00 00 0p 0q FF	pq: B Gain
CAM_AEModelInq	8x 09 04 39 FF	y0 50 00 FF	Full Auto
		y0 50 03 FF	Manual
		y0 50 0A FF	Shutter Priority
		y0 50 0B FF	Iris Priority
		y0 50 0D FF	Bright
CAM_SlowShutterModelInq	8x 09 04 5A FF	y0 50 02 FF	Auto
		y0 50 03 FF	Manual
CAM_ShutterPosInq	8x 09 04 4A FF	y0 50 00 00 0p 0q FF	pq: Shutter Position
CAM_IrisPosInq	8x 09 04 4B FF	y0 50 00 00 0p 0q FF	pq: Iris Position
CAM_GainPosInq	8x 09 04 4C FF	y0 50 00 00 0p 0q FF	pq: Gain Position
CAM_GainLimitInq	8x 09 04 2C FF	y0 50 0q FF	p: Gain Limit
CAM_BrightPosInq	8x 09 04 4D FF	y0 50 00 00 0p 0q FF	pq: Bright Position

Inquiry Command	Command Packet	Inquiry Packet	Comments
CAM_ExpCompPosInq	8x 09 04 4E FF	y0 50 00 00 0p 0q FF	pq: ExpComp Position
CAM_BacklightModeInq	8x 09 04 33 FF	y0 50 02 FF	On
		y0 50 03 FF	Off
CAM_LR_Reverse_Inq	8x 09 04 61 FF	y0 50 02 FF	On
		y0 50 03 FF	Off
CAM_Flip_Inq	8x 09 04 66 FF	y0 50 02 FF	On
		y0 50 03 FF	Off
CAM_NRInq	8x 09 04 53 FF	y0 50 0p FF	p: NR Level
CAM_WDRInq	8x 09 04 3D FF	y0 50 02 FF	On
		y0 50 03 FF	Off
CAM_ICRModelInq	8x 09 04 01 FF	y0 50 02 FF	On (Night)
		y0 50 03 FF	Off (Day)
CAM_AutoICRModelInq	8x 09 04 51 FF	y0 50 02 FF	On
		y0 50 03 FF	Off
CAM_AutoICRThresholdInq	8x 09 04 21 FF	y0 50 00 00 0p 0q FF	pq: ICR OFF(Day)->ON(Night) threshold level 00: Low; 01: Middle; 02: High
CAM_IDInq	8x 09 04 22 FF	y0 50 0p 0q 0r 0s FF	pqrs: Camera ID
CAM_VersionInq	8x 09 00 02 FF	y0 50 ab cd mn pq rs tu vw FF	abcd: Vendor Code, AVer: 2574 mnpq: Model Code, MD120UI: 0565 rstu: Firmware version (ex: 4025 for 1.1.4025.0) vw: Socket Number (=02)
CAM_MenuModelInq	8x 09 06 06 FF	y0 50 02 FF	On
		y0 50 03 FF	Off
Video Format Inq	8x 09 06 23 FF	y0 50 02 FF	1920x1080P/60
		y0 50 03 FF	1920x1080P/59.94
		y0 50 04 FF	1920x1080P/30
		y0 50 05 FF	1920x1080P/29.97
		y0 50 08 FF	1920x1080I/60
		y0 50 0A FF	1920x1080I/59.94
		y0 50 0B FF	1280x720P/60
		y0 50 0C FF	1280x720P/59.94
		y0 50 0D FF	1920x1080P/50

Inquiry Command	Command Packet	Inquiry Packet	Comments
		y0 50 18 FF	1920x1080P/25
		y0 50 22 FF	1920x1080I/50
		y0 50 26 FF	1280x720P/50
		y0 50 30 FF	3840x2160P/60
		y0 50 31 FF	3840x2160P/59.94
		y0 50 32 FF	3840x2160P/50
		y0 50 33 FF	3840x2160P/30
		y0 50 34 FF	3840x2160P/29.97
		y0 50 35 FF	3840x2160P/25
IR_Receive	8x 09 06 08 FF	y0 50 02 FF	On
		y0 50 03 FF	Off
Pan-tiltPosInq	8x 09 06 12 FF	y0 50 0Y 0Y 0Y 0Y 0Z 0Z 0Z 0Z FF	YYYY: Pan Position 7FFF(170°) to 8000 (-170°) (Normalized, CENTER 0000) ZZZZ: Tilt Position 7FFF(90°) to 8000(-30°) (Image Flip: OFF) (Normalized, CENTER 0000)
CAM_Preset_Inq	8x 09 04 3F FF	y0 50 pp FF	Return the last preset number which has been operated pp:01-FF
Pan-tiltMaxSpeedInq	8x 09 06 11 FF	y0 50 ww zz FF	ww = Pan Max Speed zz = Tilt Max Speed
Freeze_Mode_Inq	8x 09 04 62 01 FF	y0 50 02 FF	On
		y0 50 03 FF	Off
Preset_Freeze_Inq	8x 09 04 62 02 FF	y0 50 02 FF	On
		y0 50 03 FF	Off
RTMP_Inq	8x 09 04 A2 FF	y0 50 02 FF	On
		y0 50 03 FF	Off
Preset_Speed_Inq	8x 09 06 20 FF	y0 50 0p FF	p=1 (Low) to 6 (High)
Firmware version	8x 09 36 69 04 FF	y0 50 0p 0q 0r 0s 0t 0u 0v 0w FF	fw_ver: p.q.rstu.vw

VISCA over IP Settings

PORT

Internet protocol	IPv4
Transport protocol	UDP
Port address	52381

FORMAT

	byte 0	byte 1	byte 2	byte 3	byte 4	byte 5	byte 6	byte 7	byte 8 ~~~ byte 23	
func	Payload type		Payload Length		Sequence number				Payload (1 to 16 bytes)	
data	Value1	Value2	1~16(0x0001~0x0010)		0x00000000 ~ 0xFFFFFFFF				VISCA Packet (see page VISCA)	

Payload type

Name	Value1	Value2	Description
VISCA command	0x01	0x00	Stores the VISCA command.
VISCA inquiry	0x01	0x10	Stores the VISCA inquiry.
VISCA reply	0x01	0x11	Stores the reply for the VISCA command and VISCA inquiry, or VISCA device setting command
VISCA device setting command	0x01	0x20	Stores the VISCA device setting command.
Control command	0x02	0x00	Stores the control command
Control reply	0x02	0x01	Stores the reply for the control command.

CGI Command

CGI List for Video Transmission					
CGI item name	URL	Command	Parameter Name	Parameter value	Description
Get JPEG	/snapshot				1280x720 jpg
Get 4K JPEG	/cgi-bin?OnePush=n				Step 1: request 4k snapshot
	/snapshot?res=4k				Step 2: get 3840x2160 jpg
Get RTSP stream	rtsp://ip/live_st1				

CGI List for Audio					
CGI item name	URL	Command	Parameter Name	Parameter value	Description
Audio In Volume	/cgi-bin?Set=	ado_vol,3,N		0 ~10	0 ~ 10 volume

CGI List for Camera Control					
CGI item name	URL	Command	Parameter Name	Parameter value	Description
up start	/cgi-bin?SetPtfz=	1,0,1			
up end	/cgi-bin?SetPtfz=	1,0,2			
down start	/cgi-bin?SetPtfz=	1,1,1			
down end	/cgi-bin?SetPtfz=	1,1,2			
left start	/cgi-bin?SetPtfz=	0,1,1			
left end	/cgi-bin?SetPtfz=	0,1,2			
right start	/cgi-bin?SetPtfz=	0,0,1			
right end	/cgi-bin?SetPtfz=	0,0,2			
zoom_in start	/cgi-bin?SetPtfz=	2,0,1			
zoom_in end	/cgi-bin?SetPtfz=	2,0,2			
zoom_out start	/cgi-bin?SetPtfz=	2,1,1			
zoom_out end	/cgi-bin?SetPtfz=	2,1,2			
set preset:	/cgi-bin?ActPreset=	1,N			N : position
load preset:	/cgi-bin?ActPreset=	0,N			N : position

CGI List for Various Settings					
CGI item name	URL	Command	Parameter Name	Parameter value	Description
exposure value	/cgi-bin?Set=	img_expo_expo,3,N	value	1 ~ 9	N : value
saturation	/cgi-bin?Set=	img_saturation,3,N	value	0 ~ 10	N : value
contrast	/cgi-bin?Set=	img_contrast,3,N	value	0 ~ 4	N : value

Tracking on:	/cgi-bin?Set=	trk_tracking_on,3,1			
Tracking off:	/cgi-bin?Set=	trk_tracking_on,3,0			
Reboot	GET(Basic Authentication)	/cgi-bin?OnePush=!			
Factory Reset	GET(Basic Authentication)	/cgi-bin?OnePush=d			
RTMP Start streaming	/cgi-bin?Set=	vdo_rtmp_enable,3,1			
RTMP Stop streaming	/cgi-bin?Set=	vdo_rtmp_enable,3,0			
Status get (Model name & mac & FW_VER)	/cgi-bin?GetString=	sys_name&net_mac&sys_fw_version			http://10.100.105.110/cgi-bin?GetString=sys_name&net_mac&sys_fw_version
Serial No. get	/cgi-bin?GetSerialNumber				http://10.100.105.110/cgi-bin?GetSerialNumber
oneclick	/cgi-bin?Set=	ptz_oneclick_x,3,N1&ptz_oneclick_y,3,N2&ptz_oneclick_spd,3,N3		ptz_one_click_spd 1~24	N1, N2 = X, Y coordinates (1080P, 0,0 at top left) N3=moving speed
IR Cut Filter	/cgi-bin?Set=	img_ircut_filter,3,N		0 ~ 2	0 = Day, 1 = Night, 2 = Auto
IR Cut Filter Sensitivity	/cgi-bin?Set=	img_ircut_sensitivity,3,N		0 ~ 2	0 = Low, 1 = Middle, 2 = High

CGI List for AI Settings					
CGI item name	URL	Command	Parameter Name	Parameter value	Description
Eyes Tracking On/Off	/cgi-bin?Set=	trk_tracking_on,3,N	value	0 / 1	0: OFF; 1: ON
Tracking Preset	/cgi-bin?ActPreset=1,255				Save current pos. for eye tracking preset point.
Timeout to preset	/cgi-bin?Set=	trk_lost_time,3, N	value	3 / 5 / 7 / 10	timeout in seconds
Tracking Site	/cgi-bin?Set=	trk_mode,3,N	value	0 / 1	0: Full face; 1: Eyes
Tracking Range	/cgi-bin?Set=	trk_sensitivity,3,N	value	0 ~ 2	0: Close; 1: Medium; 2: Wide
Eyes Tracking On/Off Get	/cgi-bin?Get=trk_tracking_on				
	- Reply	On trk_tracking_on=1			

		Off trk_tracking_on=0			
Audio Detection On/Off	/cgi-bin?Set=	ado_det_alarm,3,N	value	0 / 1	0: OFF; 1: ON
Alarm Detection Type	/cgi-bin?Set=	ado_alm_general,3,N	value	0 / 1	general type. 0: OFF; 1: ON
		ado_alm_oxygen,3,N	value	0 / 1	oxygen type. 0: OFF; 1: ON
		ado_alm_ventilation,3,N	value	0 / 1	ventilation type. 0: OFF; 1: ON
		ado_alm_cardiovascular,3,N	value	0 / 1	cardiovascular type. 0: OFF; 1: ON
		ado_alm_temperature,3,N	value	0 / 1	temperature type. 0: OFF; 1: ON
		ado_alm_drug,3,N	value	0 / 1	drug type. 0: OFF; 1: ON
		ado_alm_artificial,3,N	value	0 / 1	artificial type. 0: OFF; 1: ON
		ado_alm_power,3,N	value	0 / 1	power type. 0: OFF; 1: ON
		ado_alm_information,3,N	value	0 / 1	information type. 0: OFF; 1: ON

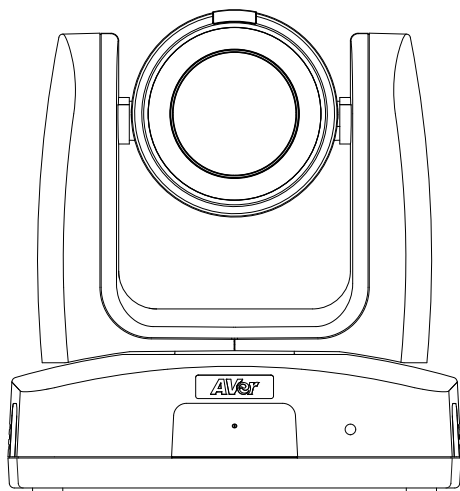

MD120UI 攝影機

使用手冊



如何清潔和消毒

警告
人身傷害危險 請勿使用含有苯酚的清潔劑，苯酚可能會在沖洗不完全的情況下導致患者皮膚灼傷，而且苯酚不含足夠的清潔或消毒成分。

注意事項

1. 攝影機設計方便清潔和消毒。
2. 清潔攝影機前，請先切斷電源。
3. 清潔程序應只由熟悉攝影機操作的人員執行。
4. 請勿將清潔液體，尤其是水，噴灑到攝影機的任何內部電氣設備或零件中，避免可能出現短路、腐蝕、故障和對用戶或服務人員的觸電危險。
5. 腐蝕性清潔劑可能會導致攝影機褪色或損壞。使用任何清潔劑前，請在不顯眼的位置進行測試。

時間 使用前和使用後須清潔設備。

步驟

1. 切斷攝影機電源。
2. 清潔人員須戴上清潔手套。
3. 使用清潔酒精前，請確保酒精尚未過期。
4. 使用沾有清潔酒精 (75%) 的清潔布。
5. 使用沾有酒精的棉布擦拭可能與攝影機接觸的所有表面。
6. 擦拭攝影機後，避免裸手接觸。

頻率 無須定期清潔，僅須在使用前和使用後清潔。

產品標示符號說明

此產品 (含配件) 上標示的符號，其表示如下：

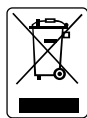

WEEE 符號

此符號表示不得將本產品與其他家用垃圾一同丟棄。請將廢棄的設備交由指定之廢電機電子設備回收站處理。關於處理廢棄設備之詳細資訊，請洽當地的家庭垃圾處理服務處或您購買產品的商家。



CE 合規標誌

此標誌表示該產品符合歐盟統一立法的相關指南/標準。



FCC 合規標誌

此標誌表示該產品符合美國聯邦通信委員會的合規標準。



UKCA (UK Conformity Assessed) 符號

此符號表示銷售到英國市場的產品符合 UKCA 標誌要求。



RCM 合規標誌

此標誌表示該產品符合澳洲 RCM 指南。



此標誌旨在提醒用戶注意產品外殼內存在未絕緣的“危險電壓”，該電壓可能足以對人員構成電擊風險。



此標誌旨在提醒用戶注意設備隨附的手冊中存在重要的操作和維護（維修）說明。



中國 RoHS 標誌

此符號的數字表示在正常使用條件下，沒有有害物質洩漏或變異的年數。



交流電符號

此符號表示本產品的電源輸入/輸出為交流電。



直流符號

此符號表示本產品的電源輸入/輸出為直流電。

警告

為避免電磁干擾，本產品不應安裝或使用於住宅環境。

限用物質含有情況標示資訊參考下列網址：<https://tw.aver.com/page/RoHS>

RTC 電池警語

若電池更換不正確，將有爆炸危險。因此，只可以使用製造商推薦的同一種或者同等型號的電池進行替換。請按照製造商的指示處理舊電池。

遙控器電池安全資訊

- 請將電池存放在涼爽與乾燥的位置。
- 不要將電量用盡的電池棄置在家庭廢棄物中。請將電池棄置在特定回收處，或送回原購買的商店。
- 如果長時間不使用電池，請將其取出。電池漏液與腐蝕可能會損壞遙控器，請以安全方式棄置電池。
- 不可混用新舊電池。
- 不可混用不同類型的電池：鹼性、標準（碳鋅）或可充電（鎳鎘）電池。
- 不可將電池棄置於火源中。
- 請勿嘗試讓電池端子短路。

警告

- 為避免觸電風險，該設備只能連接到帶有保護接地的電源。
- 未經製造商授權，請勿改裝此設備。
- 本產品僅限室內使用，且接線不可連接到戶外。

免責聲明

對於產品品質、效能、適銷性或特定用途之適用性，本文件內容皆不代表任何明示或暗示保固或陳述。本文資訊經過仔細詳查，內容可靠無誤；雖然如此，若有任何錯誤，恕不負責。本文所含資訊如有變更，恕不另行通知。

若因使用或不當使用本產品或本文，導致任何直接、間接、特殊、意外或後續損害，即使本公司已事先告知此類損害之可能性，亦不負任何賠償責任。

商標

AVer 為圓展科技股份有限公司之商標。因本內容之描述出現的商標分屬個別公司所有且均受智慧財產權相關法令保護。本文內所有提及之產品或企業名稱僅供識別與說明用途，且為各自擁有者之商標或註冊商標。

著作權

©2023 圓展科技 版權所有 | 2023 年 7 月 6 日

本內容相關權利係圓展科技股份有限公司所有，任何人未得事先書面同意不得就本內容為一部或全部之重製、改作、或任何型式之散布行為。圓展科技股份有限公司保留變更產品規格及內容的權利無須另為通知。

支援服務

軟體和使用者手冊下載，請到下面網址：

<https://www.aver.com/download-center>

常見問題、技術支援，請到下面網址：

<https://www.aver.com/technical-support>

連絡資訊

圓展科技股份有限公司

<https://www.aver.com>

新北市 23673 土城區大安路 157 號 8 樓

電話：(02)2269-8535

目錄

如何清潔和消毒	2
產品概觀	1
包裝內容物	1
選購配件	1
尺寸	2
吊頂式安裝支架	3
壁掛安裝支架	4
水平/垂直轉動角度	4
安裝	5
電線固定板	5
吊頂式安裝	6
連接	7
隱私指示燈	7
LED 指示燈	7
裝置連接	8
遙控器	11
快速鍵	12
攝影機設定	13
OSD 選單	13
IP 位址設定	13
OSD 選單階層	15
網路設定	18
進入攝影機網頁介面	18
直播 (Live View)	20
AI 設定 (AI Setting)	22
攝影機設定 (Camera Settings)	24
視訊與音訊 (Video & Audio)	26

網路 (Network).....	27
系統 (System).....	29
AVerCamera Setting Tool.....	31
規格	32
故障排除	35
附錄	36
VISCA RS-232 指令表.....	36
VISCA over IP 設定.....	44
CGI 指令.....	45

產品概觀

MD120UI 追蹤攝影機是一款專為病患監護設計的醫療級攝影機，具備紅外線夜視功能以及抗紫外線機殼。

包裝內容物

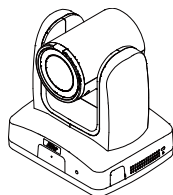

攝影機

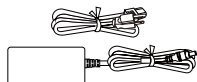

電源變壓器及電源線



遙控器



USB 3.0 Type-C 轉
Type-A 連接線 (1.5m)

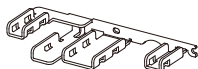

電線固定板

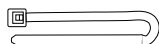

電線束線帶 (x4)

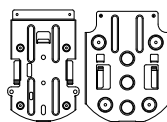

吊頂式安裝
支架 (x2)



壁掛鑽孔紙



M2 x 4mm
螺絲 (x3)



M3 x 6mm
螺絲 (x3)



1/4" -20 L=6.5mm
螺絲 (x2)



快速安裝指南

選購配件

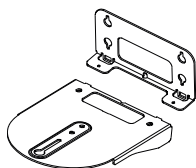

壁掛安裝支架

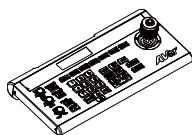

攝影機控制器
(CL01)

尺寸

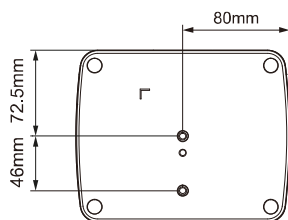
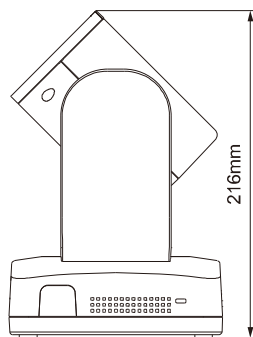
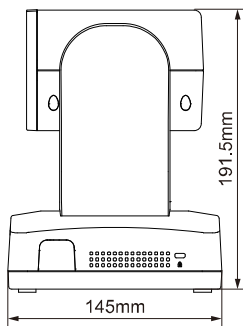
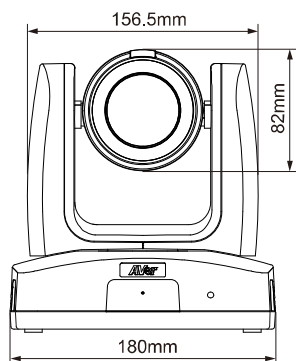

吊頂式安裝支架

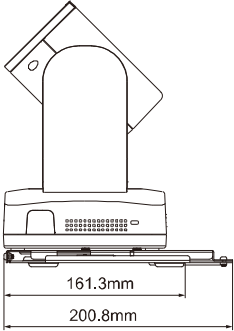
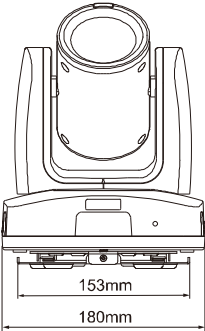
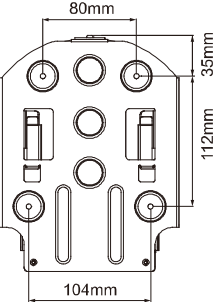
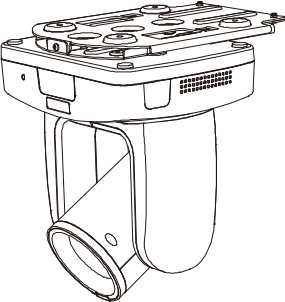

壁掛安裝支架

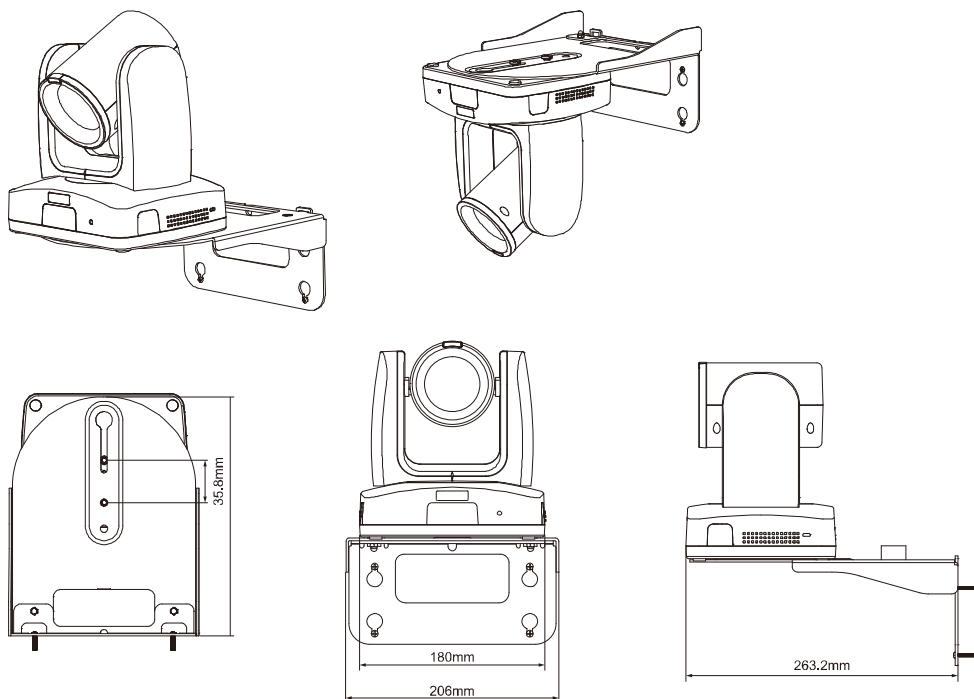

水平/垂直轉動角度

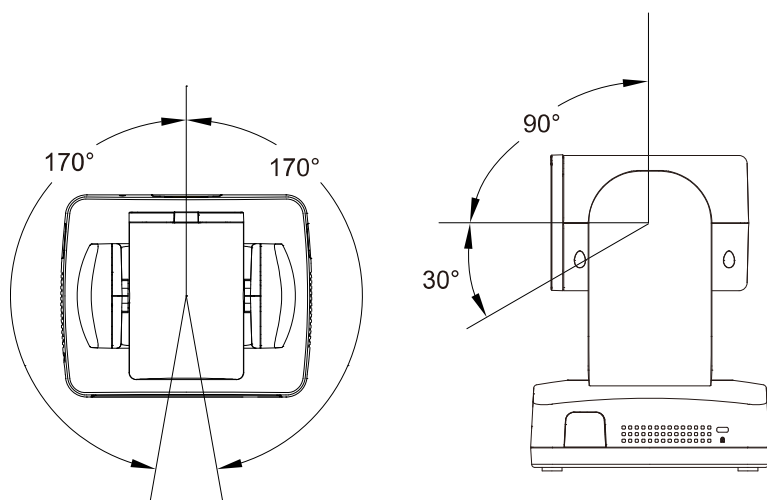

安裝

電線固定板

1. 使用隨附的 M2 x 4mm 螺絲將電線固定板鎖附在攝影機上。

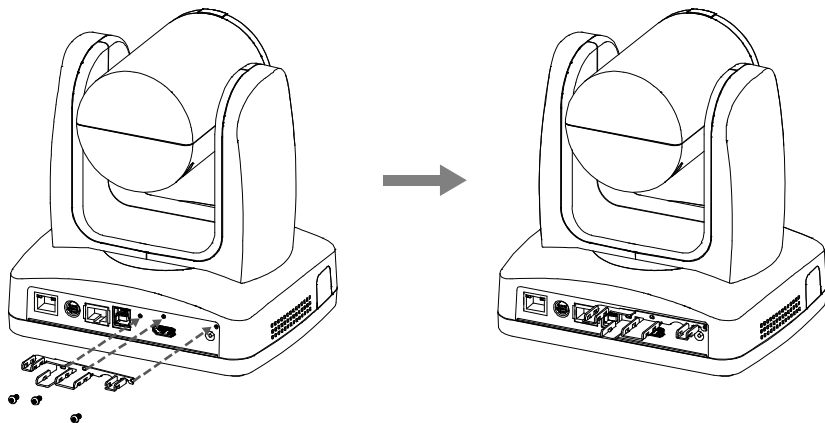

2. 將連接線接上。

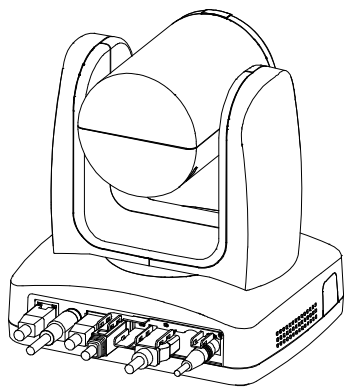

3. 將隨附的束線帶穿過矩形孔，使連接線固定在電線固定板上。

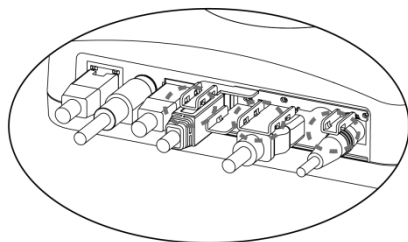

吊頂式安裝

1. 將支架安裝於天花板。

螺絲：4 顆 M4 x 10mm (未含)

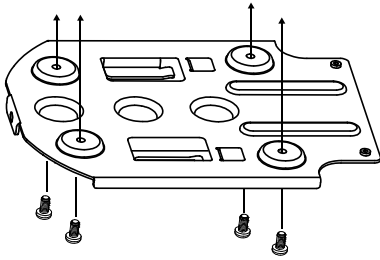

2. 將支架安裝於攝影機上。

螺絲：2 顆吊頂式支架螺絲 1/4"-20 L=6.5mm (隨附)

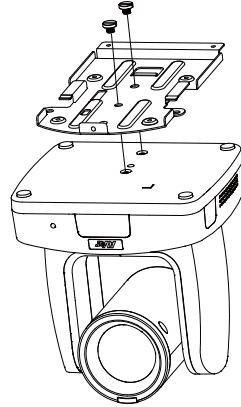

2. 將裝上支架的攝影機嵌入天花板的支架，再接上連接線。

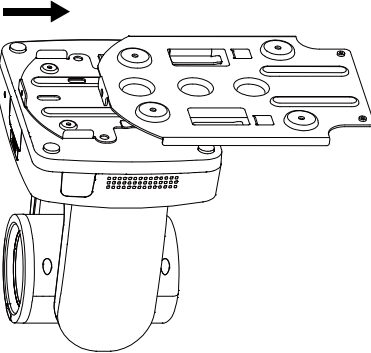

3. 使用螺絲固定兩片支架。

螺絲：3 顆 M3 x 6mm (隨附)

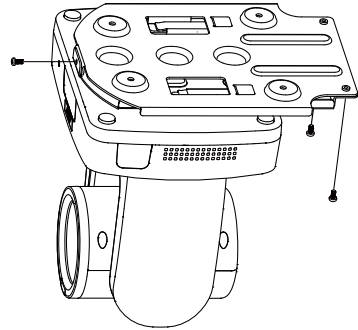

連接

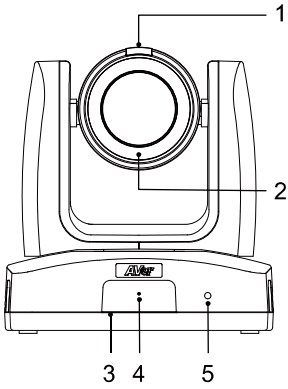

前面

1. 隱私指示燈
2. 紅外線夜視 LED*
3. IR 感測器
4. 麥克風
5. LED 指示燈

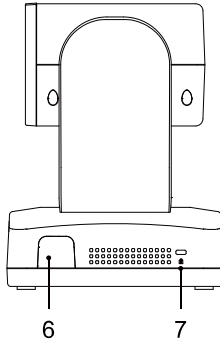

側面

6. IR 感測器
7. Kensington 防盜孔

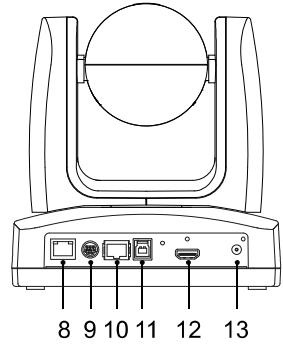

背面

8. PoE+ 連接埠**
9. RS-232 連接埠
10. RS-422 連接埠
11. USB 3.1 Type-B 連接埠
12. HDMI 連接埠
13. DC 電源插孔

*使用夜間模式時，請勿盯著紅外線 LED，可能對眼睛有害。雙眼應與紅外線 LED 保持 1 公尺以上的距離。

**PoE+ 連接埠僅可連接至 PoE 網路，不可路由至外部設備。

隱私指示燈

顏色	狀態
恆亮綠燈	監護病患中
熄燈	隱私模式 / 關機

LED 指示燈

顏色	狀態
恆亮藍燈	正常
閃爍藍燈	已開啟追蹤功能
恆亮橘燈	待機
閃爍橘燈	開機中
恆亮紫燈	已開啟 OSD 選單
閃爍紫燈	韌體更新中

裝置連接

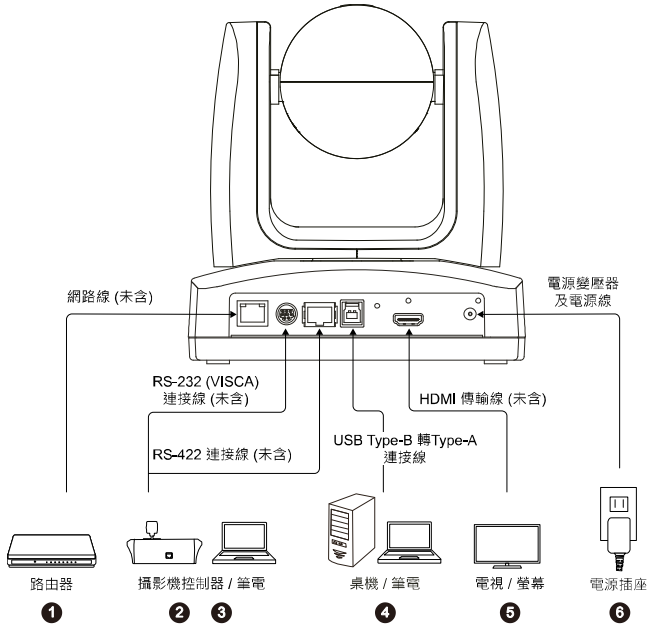

1. **LAN:** 將 IP 路由器連接至攝影機的 LAN 埠。(註)
2. **RS-232:** 欲控制攝影機時，將攝影機控制器或電腦連接至攝影機。(註)

● 接腳定義

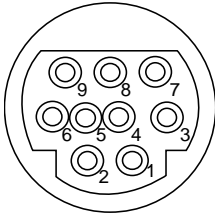

功能	Mini DIN9 腳位 #	I/O 類型	訊號	說明
VISCA 輸入	1	輸出	DTR	數據終端就緒
	2	輸入	DSR	數據集就緒
	3	輸出	TXD	傳輸數據
	6	輸入	RXD	接收數據
VISCA 輸出	7	輸出	DTR	數據終端就緒
	4	輸入	DSR	數據集就緒
	8	輸出	TXD	傳輸數據
	9	輸入	RXD	接收數據
	5	輸入	I/O	偵測 DIN8/DIN9
---	屏蔽	---	GND	接地

3. **RS-422:** 欲控制攝影機時，將攝影機控制器或電腦連接至攝影機。使用 Cat5e 分配器連接多台攝影機。

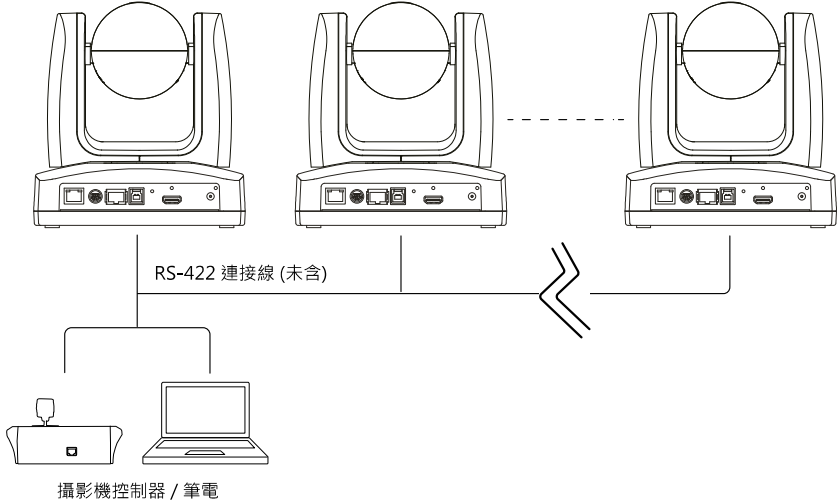

● **接腳定義**

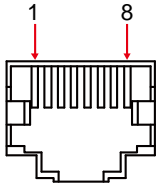

編號	接腳	編號	接腳
1	TX+	5	TX-
2	TX-	6	RX-
3	RX+	7	RX+
4	TX+	8	RX-

● **CAT5e 分配器接腳接點**

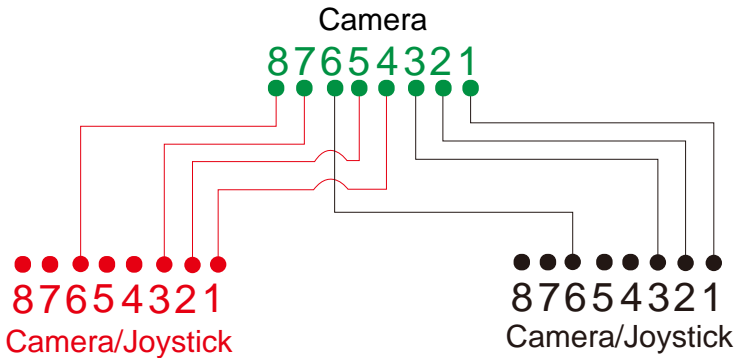

4. **USB Type-B:** 欲使用 Skype 或 Teams 等第三方視訊軟體進行視訊會議時，將攝影機連接至桌機或筆電以傳輸視訊。(註)
5. **HDMI:** 欲顯示攝影機視訊輸出畫面時，將攝影機連接到電視或螢幕。攝影機及所連接的電視或螢幕均需具備接地設計。(註)
6. **電源:** 攝影機及所連接的電視或螢幕均需具備接地設計。使用隨附的電源變壓器及電源線將攝影機連接至電源插座，並確認電視或螢幕的電源線具有接地插頭。

[註]

連接類比和數位介面的配件設備必須符合各國的統一 IEC 標準 (資料處理設備為 IEC 60950，視訊設備為 IEC 60065，實驗室設備為 IEC 61010-1，醫療設備為 IEC 60601-1)。此外，所有組態應該符合 IEC 60601-1-1 系統標準。任何人將其他設備連接到訊號輸入零件或輸出零件就是在設定醫療系統，因此必須負責保證系統符合 IEC 60601-1-1 系統標準的需求。本裝置專供患者環境中的 IEC 60601-1 合格設備及患者環境外之 IEC 60XXX 合格設備的互相連線使用。如有疑慮，請洽詢技術服務部門或當地代表。

遙控器

遙控器需安裝兩顆 AAA 電池，使用前先確認電池已妥善安裝。

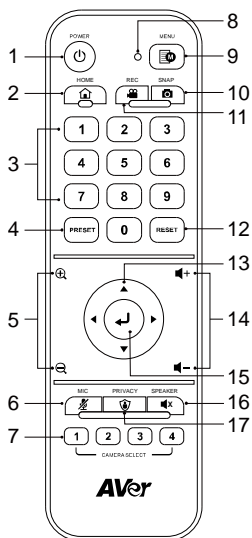

型號：LY033

名稱	功能
1. 電源	開啟/關閉待機模式。
2. 初始位置 (Home)	將攝影機畫面移至初始位置 (Home)。
3. 數字鍵	<ul style="list-style-type: none"> ● 移動畫面至預設位置 0~9。 ● 設定預設位置 0~9。
4. 預設位置 (Preset)	使用預設位置、數字鍵及方向鍵來設定預設位置。 <ol style="list-style-type: none"> 1. 使用方向鍵將畫面移置所需位置。可使用縮放按鍵將畫面進行縮放。 2. 按下預設位置按鍵不要放開，接著按下數字鍵 (0~9) 以儲存此預設位置。
5. 縮放 +/-	按下可將畫面縮放。
6. 麥克風 (MIC)	按下可將麥克風靜音。再次按下可解除靜音。
7. 攝影機選擇	選擇欲操作的攝影機。欲設定攝影機號碼，請進入 OSD 選單： System > Camera Selector 。
8. 遙控器 LED	按下遙控器上的按鍵時，LED 會閃爍紅燈。
9. 選單 (Menu)	長按 3 秒以進入 OSD 選單。欲更改此設定，請進入 OSD 選單： System > Trigger OSD 。
10. 截圖 (Snap)	無
11. 錄影 (Rec)	無
12. 重置 (Reset)	可使用重置和數字鍵來取消已設定的預設位置。按下重置按鍵不要放開，接著按下數字鍵 (0~9)。
13. 方向鍵	使用方向鍵瀏覽攝影機畫面。
14. 音量 +/-	無

15. 輸入 (Enter)	攝影機開機時：按此鍵可自動對焦一次。 進入 OSD 選單時：按此鍵可確認設定或進行選擇。
16. 揚聲器 (Speaker)	無
17. 隱私 (Privacy)	按下可進入隱私模式。攝影機鏡頭將移動至隱私位置 (鏡頭朝下)。麥克風也將關閉。

快速鍵



按下	可
選單 (Menu)  3 秒	開啟 OSD 選單。
選單 (Menu) 	關閉 OSD 選單。
初始位置(Home) 	關閉 OSD 選單並將攝影機畫面移至初始位置 (Home)。
選單 (Menu)  · 再按縮放 	切換 Day / Night 模式。
選單 (Menu)  · 再按縮放 	切換 Day / Auto 模式。
5 五次 (55555)	開啟 DHCP。
6 六次 (666666)	將攝影機的所有設定恢復為出廠預設值。
8 八次 (88888888)	將攝影機的固定 IP 位址設為 192.168.1.168。

攝影機設定

使用 OSD 選單或網頁介面進行攝影機設定。

OSD 選單

欲操作 OSD 選單，使用 HDMI 連接線將攝影機連接到螢幕或電視，接著，您即可使用隨附的遙控器進行 OSD 選單操作。

長按遙控器上的**選單 (Menu)** 按鍵  3 秒以開啟 OSD 選單，並使用 ▲、▼、◀、▶ 按鍵選擇設定頁面及設定選項，按下  可確認所選設定。

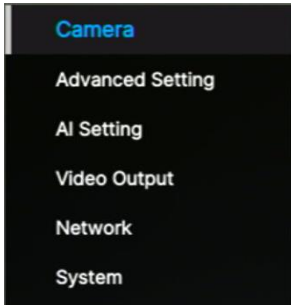

IP 位址設定

固定 IP



1. 長按遙控器上的**選單 (Menu)** 按鍵  3 秒以開啟 OSD 選單。
2. 進入 **Network > Static IP** 設定頁面。

【註】 進行固定 IP 設定前，請先將 DHCP 設定關閉 (**Network > DHCP > OFF**)。

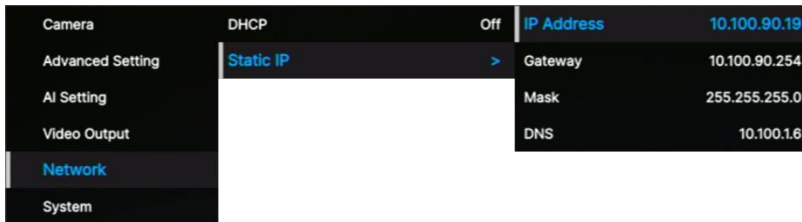
3. 選擇要設定的 **IP Address**、**Gateway**、**Netmask** 和 **DNS 伺服器**。按下 ，並使用數字鍵輸入資料。



DHCP

1. 長按遙控器上的選單 (Menu) 按鍵  3 秒以開啟 OSD 選單。
2. 選擇 **Network > DHCP > On**。
3. 按下  以確認設定。

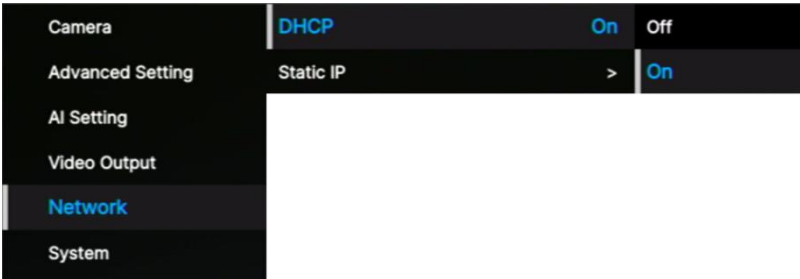

4. 啟用 **DHCP** 後，您可進入 **System > Information** 查看 IP 位址。

Camera	Trigger OSD	Press Menu 3 sec	Model Name	MD120UI
Advanced Setting	Camera Selector	All	Serial Number	5100435000010
AI Setting	Status OSD	Off	Version	1.10502.0
Video Output	Language	English	IP Address	0.0.0.0
Network	Information	>	MAC	00:18:1A:0C:BA:4E
System	Factory Default	>	Lens	C004
	System Reboot	>	Mcu	A001

OSD 選單階層

第一層	第二層	第三層	第四層
Camera	Exposure Mode	Full Auto	Exposure Value
			Gain Limit Level
			Slow Shutter
			BLC
			WDR
		Shutter Priority	Exposure Value
			Shutter Speed
			Gain Limit Level
		Iris Priority	Exposure Value
			Iris Level
			Gain Limit Level
			Slow Shutter
		Manual	Iris Level
			Shutter Speed
			Gain Level
		Bright mode	Bright value
	White Balance	Auto	
		ATW	
		Indoor	
		Outdoor	
		One push trigger	
		Manual	R gain
		B gain	
	Pan Tilt Zoom	Preset Speed	5, 25, 50, 100, 150, 200
		Preset Accuracy	Off / On
		Pan Speed	1~24
		Tilt Speed	1~24
		Zoom Speed	Low / High
		P/T Spd. Relative Z Ratio	Off / On
		Pan L/R Dir. Switch	Off / On

	Noise filter	Off / Low / Middle / High	
	Saturation	0 1 2 3 4 5 6 7 8 9 10	
	Contrast	0 1 2 3 4	
	Sharpness	0 1 2 3	
	Mirror	OFF / ON	
	Flip	OFF / ON	
Advanced Setting	Audio	Audio Volume	0~10
	Control	Type	RS232 / RS422
		Protocol	VISCA
		Camera Address	1 2 3 4 5 6 7
		Baud Rate	4800 / 9600 / 38400
	IR Cut Filter	Auto / Day / Night	
IR Cut Sensitivity	Low / Middle / High		
AI Setting	Facial Tracking	Eyes Tracking	On/Off
		Tracking Preset	Save
		Tracking Site	Full Face / Eyes
		Tracking Range	Close / Medium / Wide
		Timeout to Preset	3/5/7/10 sec
	AI Audio Detection	Audio Detection	On/Off
Video Output	Theme Mode	HDMI / UVC	
	Frequency	60	
		59.94	
		50	
	Resolution	2160p60	
		2160p59	
		2160p50	
		2160p30	
		2160p29	
		2160p25	
		1080p60	
		1080p59	
	1080p50		

		1080p30	
		1080p29	
		1080p25	
		1080i60	
		1080i59	
		1080i50	
		720p60	
		720p59	
		720p50	
		Network	DHCP
ON			
Static IP	IP Address		192.168.1.168
	Gateway		192.168.1.254
	Mask		255.255.255.0
DNS	8.8.8.8		
System	Trigger OSD	Click Menu to open, Press Menu 3 sec	
	Camera Selector	1,2,3,4,All channel, Disable Remote	
	Status OSD	OFF	
		ON	
	Language	English / 中文 / 日本語	
	Information	Model Name	MD120UI
		Serial number	xxxxxxxxxxxxx
		Firmware Version	0.0.0000.00
		IP	192.168.1.168
		MAC	00:18:1a:04:9e:81
		Lens	xxxx
		Mcu	xxxx
	Factory Default	Off / On	
System Reboot	Off / On		

網路設定

透過網路將攝影機連上遠端站台。

進入攝影機網頁介面

欲進入攝影機網頁介面，您可使用 **AVer IPCam Utility** 或 **AVer PTZ Management** 軟體，找出攝影機 IP 位址。

透過 **AVer IPCam Utility** 進入攝影機網頁介面

請依照以下步驟使用 **IPCam Utility** 搜尋攝影機 IP 位址。

1. 至圖展官網下載並開啟 **IPCam Utility** <https://www.aver.com/download-center>。
2. 點擊 **Search** 按鍵，連接在相同網段上的圖展裝置將全部顯示。
3. 點擊列表上的攝影機以選取該攝影機，該攝影機的資訊將顯示在 **Settings** 區域。

[註] 攝影機預設網路設定為固定IP (192.168.1.168)，預設帳號/密碼為 **admin/admin**。若您想將網路設定改為 DHCP，在 **Login** 區域輸入攝影機帳號/密碼，在列表上選擇欲設定的攝影機，接著，在 **Settings** 區域選擇 **DHCP**，然後按下 **Apply** 按鍵。

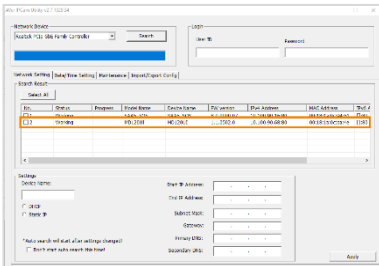

4. 欲進入攝影機網頁介面，在 **IPv4** 欄位雙擊該攝影機的 IP 位址。首次登入的用戶，請在登入彈跳視窗裡輸入一組新的帳號/密碼。

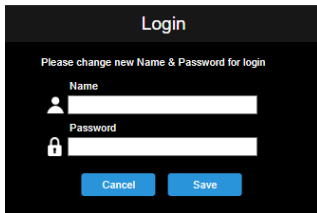

5. 再次輸入新的帳號/密碼後，攝影機網頁介面將顯示在 **Chrome** 瀏覽器上。詳情請參閱 [<直播 \(Live View\)>](#) 章節。

[註] **IPCam Utility** 搜尋不到攝影機時，請按下列步驟檢查：

1. 請確認攝影機已妥善連接到乙太網路。
2. 攝影機與電腦 (**IPCam Utility**) 均連結在同一個區域網路中。

透過 AVer PTZ Management 進入攝影機網頁介面

請依照以下步驟使用 AVer PTZ Management 搜尋攝影機 IP 位址。

1. 至圖展官網下載 AVer PTZ Management 軟體 <https://www.aver.com/download-center>
2. 下載 Windows 版本並安裝。
3. 設定完使用者帳號及密碼後，登入軟體（預設帳號/密碼為 **admin/admin**）。

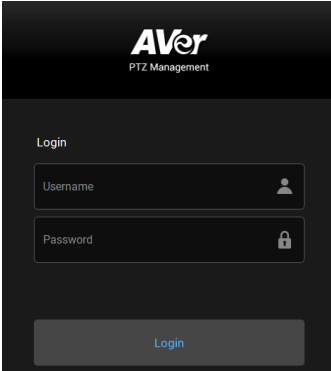

4. 在 PTZ Management 主頁面上，點擊 **Setup > Add**，接著點擊 **Auto Search**。與電腦連接在相同區域網路的攝影機將被顯示。

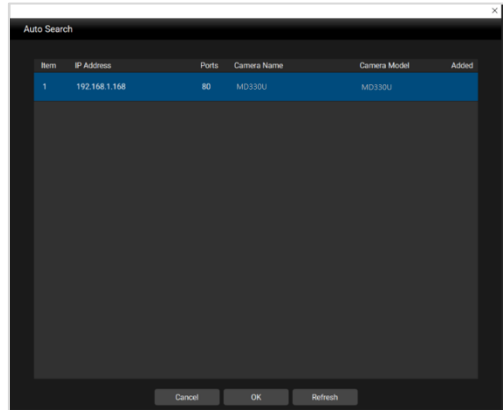
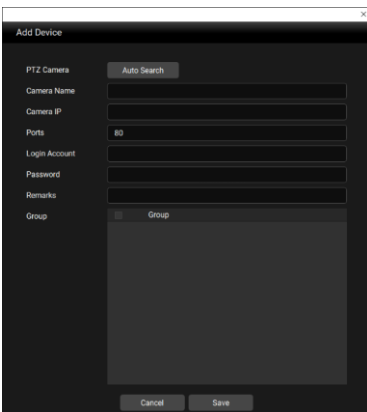

5. 點擊攝影機並輸入帳號及密碼，以將攝影機新增到裝置清單列表中（預設帳號/密碼為 **admin/admin**）。點擊 **Go to Web** 按鍵可進入攝影機網頁介面。

直播 (Live View)

控制攝影機並設定預設位置。

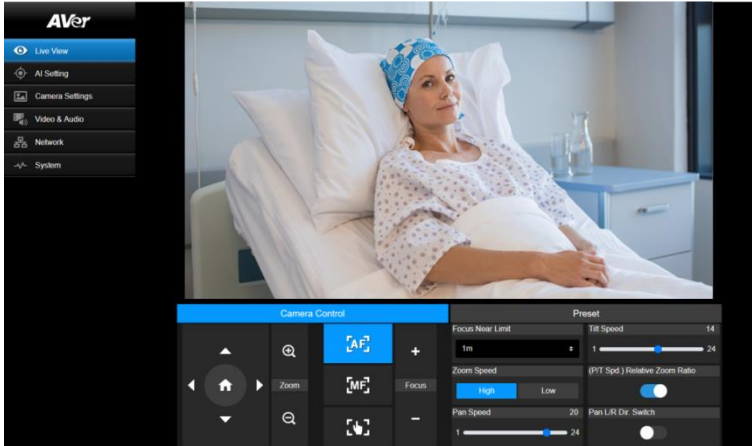

攝影機控制 (Camera Control)

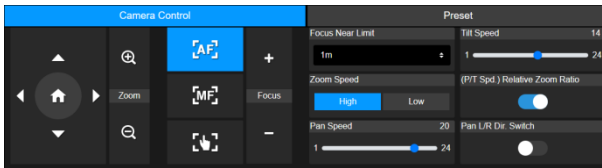

項目	說明
水平垂直控制	移動攝影機位置。 <ul style="list-style-type: none">● 拖移 Pan Speed 和 Tilt Speed 滑桿可調整水平垂直移動速度。● 開啟 Pan L/R Dir. Switch 可翻轉水平控制方向。● 開啟 P/T Spd. Relative Z Ratio 可自動根據變焦倍率調整水平垂直移動速度。 也可透過 OSD 選單進行設定 Camera > Pan Tilt Zoom > P/T Spd. Relative Z Ratio。
初始位置 (Home)	將攝影機畫面移至初始位置 (Home)。
Zoom	縮放攝影機畫面和選擇 Zoom Speed 。
Focus +-	<ul style="list-style-type: none">● 自動對焦：按下可持續自動對焦。● 手動對焦：按下可使用 +- 按鈕手動對焦。● 一鍵觸發對焦：按下可自動對焦一次。● Focus Near Limit: 設定最近對焦距離。

預設位置 (Preset)



項目	說明
Save Preset	<ol style="list-style-type: none">1. 使用水平垂直縮放控制將攝影機移到想要的位置。2. 在 Save Preset 欄位輸入想要的預設位置編號 (0~255) · 並點擊 Save 。
Load Preset	<ol style="list-style-type: none">1. 在 Load Preset 欄位輸入想要移到的預設位置編號 (0~255) · 並點擊 Load 。2. 或點擊 Quick Call 區域中的預設位置編號(0~19) 。
Preset Accuracy	開啟可提升攝影機移動到預設位置的準確度。
Video Freeze while Preset	開啟時，攝影機不會顯示移動至預設位置過程的畫面，僅顯示預設位置的畫面。
Preset Speed	調整移動至預設位置的速度。

AI 設定 (AI Setting)



雙眼追蹤 (Eyes Tracking)

追蹤時，若手動調整水平垂直縮放控制，雙眼追蹤會關閉。

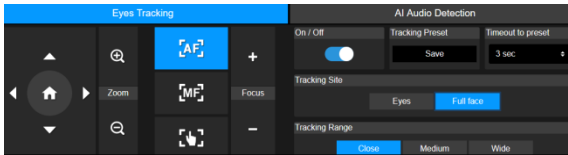

1. 使用水平垂直縮放控制將攝影機移到想要的位置，然後點擊 **Save** 以儲存追蹤預設位置。無設定時，預設為初始位置 (Home)。
2. 從 **Timeout to preset** 的下拉選單中，選擇攝影機在無人入鏡時，回到追蹤預設位置的間隔時間。無設定時，預設為 3 秒。
3. 畫面中出現人臉時，開啟 **On/Off** 開關以啟用臉部追蹤。
 - 一人：攝影機會自動追蹤及特寫臉部。
 - 多人：攝影機會框出偵測到的臉部，點擊方框來選擇要自動追蹤及特寫的臉部。
4. 調整 **Tracking Site** 和 **Tracking Range**。

(Beta) AI 聲音偵測

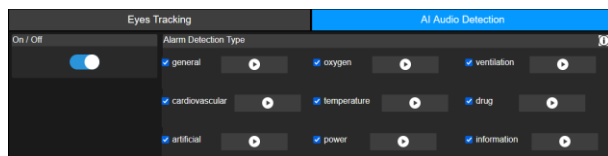

1. 開啟時，攝影機會偵測勾選的警報聲。
2. 點擊播放按鈕來預覽警報聲。

攝影機設定 (Camera Settings)



曝光 (Exposure)

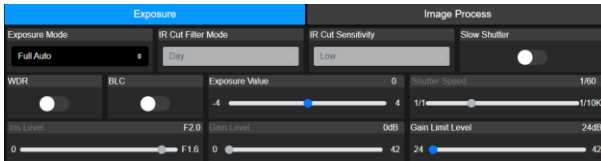

項目	說明
Exposure Mode	選擇曝光模式。
WDR	開啟或關閉寬動態範圍或背光補償。
BLC	
Exposure Value	
Shutter Speed	
Iris Level	調整曝光、快門、光圈、增益值。
Gain Level	
Gain Limit Level	
IR Cut Filter Mode	選擇 Day 、 Night 模式以切換紅外線夜視功能，或選擇 Auto 模式並設定 IR Cut Sensitivity 。
Slow Shutter	開啟或關閉慢速快門。

影像處理 (Image Process)

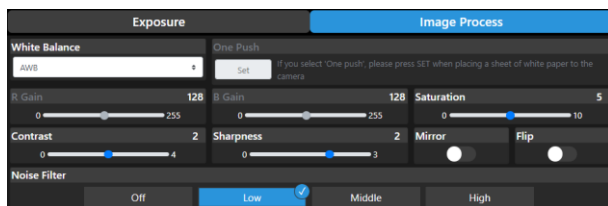

項目	說明
White Balance	<ul style="list-style-type: none">● 選擇白平衡模式。若選擇 Manual，可進一步設定 R Gain 及 B Gain。● 若選擇 One Push，請在攝影鏡頭前放置一張白紙，並點擊 Set 以進行白平衡調校。
Saturation	
Contrast	調整飽和度、對比度、銳利度。
Sharpness	
Mirror	
Flip	開啟或關閉水平翻轉或垂直翻轉。
Noise Filter	選擇雜訊抑制程度。

視訊與音訊 (Video & Audio)



視訊設定

項目	說明
Power Frequency (Hz)	請依您所處的國家或區域選擇 50Hz 、 59.94Hz 或 60Hz 。
Video Out Resolution	選擇視訊輸出的解析度。 RTSP: 最高 4K/60fps HDMI: 最高 4K 60Hz
Theme Mode	選擇影像風格，以 UVC 或 HDMI 為優先。
Stream Video Output	選擇即時影像串流的解析度。
Framerate	選擇即時影像串流的幀率。
Bitrate	選擇位元率。
I-VOP Interval (S)	<ul style="list-style-type: none">● 拖移滑杆來選擇 I-VOP 間隔在影像串流中出現的頻率。● 低頻率的 I-VOP 間隔的影像解析度會較高，但檔案也較大。
Rate Control	選擇 VBR 或 CBR 。
Encoding Type	選擇 H.264 或 H.265 。

音訊設定

項目	說明
Microphone Volume	拖移滑杆來調整麥克風音量。
Sampling Rate	48K
Encoding Type	AAC

網路 (Network)

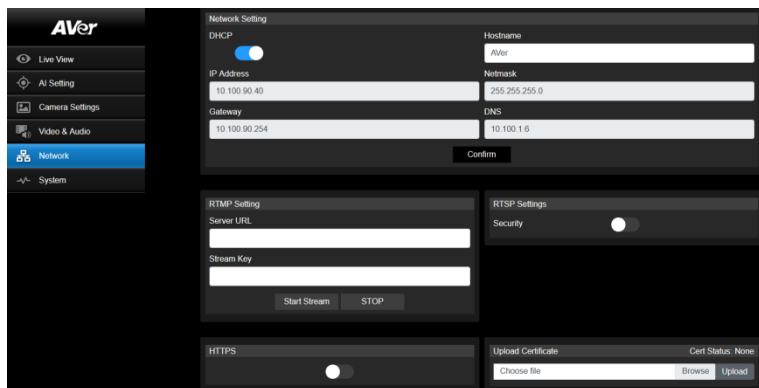

項目	說明
Hostname	預設主機名稱為 AVer。您可以更改主機名稱，此名稱會顯示在其他如 IP 路由器等裝置上。
DHCP	可將網路設定為 DHCP 或固定 IP。 <ul style="list-style-type: none">● DHCP：啟用 DHCP 時，攝影機將自動分配 IP 位址，點擊 Confirm 以儲存。● 固定 IP：停用 DHCP 時，手動輸入 IP Address、Netmask、Gateway 及 DNS 伺服器，點擊 Confirm 以儲存。
RTMP Setting	將攝影機串流傳送到 YouTube 等影音串流平台。 <ol style="list-style-type: none">1. 輸入影音串流平台的 Server URL 和 Stream Key。請參考您使用的平台的設定說明，以取得伺服器 URL 及串流密碼。2. 點擊 Start Stream 來開始直播，點擊 STOP 以停止直播。
RTSP Settings	保護您在媒體播放器，例如 VLC、PotPlayer 和 Quick Time 上的影音串流，以確保只有已授權的用戶可以存取。 <ul style="list-style-type: none">● 關閉 Security：<ol style="list-style-type: none">1. 在媒體播放器上輸入攝影機的 RTSP URL。2. RTSP URL: rtsp://[camera IP address]/live_st1 範例: rtsp://192.168.1.100/live_st1● 開啟 Security：<ol style="list-style-type: none">1. 在媒體播放器上輸入攝影機的 RTSP URL 以及帳戶密碼。2. RTSP URL: rtsp://[username:password]@[camera IP address]/live_st1 範例: rtsp://1:1@192.168.1.100/live_st1

3. 帳戶/密碼: 攝影機的帳戶/密碼 (網頁登入)

HTTPS

開啟 HTTPS 以在瀏覽器和攝影機之間建立安全連線。

1. 以 base-64 編碼格式獲取一個 SSL 憑證以進行加密及解密，且必須使用 PKCS#8 格式的私鑰 (未加密)。
 2. 包裝所需憑證內容轉換為 PEM 格式。上傳到攝影機的 SSL 憑證必須是 PEM 格式。
 3. 點擊 **Browse** 以選擇認證檔案，然後點擊 **Upload**。
 4. 開啟 HTTPS。
-

系統 (System)

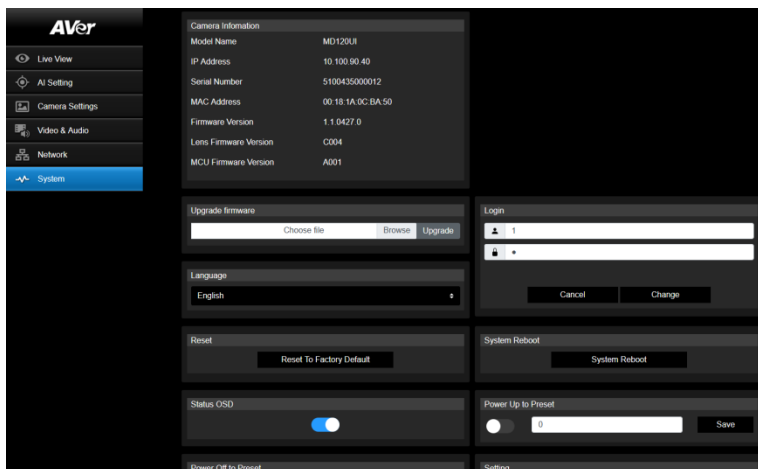

項目	說明
Camera Information	顯示攝影機資訊。
Upgrade Firmware	依照以下步驟更新韌體： <ol style="list-style-type: none">1. 從圓展官網下載最新韌體檔案 https://www.aver.com/download-center/2. 在攝影機網頁介面上，進入 System > Upgrade Firmware。3. 點擊 Browse 選取韌體檔案。4. 點擊 Upgrade 開始更新韌體。5. 韌體更新完成後，請重新整理瀏覽器。 <p>[註] 更新韌體時，請讓攝影機保持連接電源。更新期間，網路連線將會中斷，且更新後攝影機將自動重新啟動。</p>
Login	預設的攝影機帳號及密碼為 admin/admin 。如須變更，請輸入新帳號密碼，然後點擊 Change 。
Language	選擇網頁介面的顯示語言。
Reset	將攝影機的所有設定恢復為出廠預設值。
System Reboot	重新啟動攝影機。
Status OSD	開啟時，預設位置的狀態將顯示在 HDMI 輸出畫面上，包含儲存預設位置、載入預設位置、取消預設位置等功能。
Power Up to Preset	開啟時，攝影機開機後會自動移動到開機預設位置。 <ul style="list-style-type: none">● 開啟開關 > 輸入預設位置編號 > 點擊 Save。● 開啟前，請確認已設定此預設位置編號。

Power Off to Preset

開啟時，攝影機關機前會自動移動到關機預設位置。

- 開啟開關 > 輸入預設位置編號 > 點擊 **Save**。
- 開啟前，請確認已設定此預設位置編號。

Setting

匯出或匯入攝影機設定。

Help Us Improve

開啟以同意傳送匿名使用資訊。

AVerCamera Setting Tool

AVerCamera Setting Tool 是一款協助您操控 AVer PTZ 攝影機的軟體。使用第三方軟體輸出視訊畫面時，您無需遙控器即可調整影像、音訊和視訊設定。AVerCamera Setting Tool 也支援 USB 連接攝影機。

- 請到 AVer 官網下載 AVerCamera Setting Tool：
<https://www.aver.com/Downloads/search?q=AVer%20Camera%20Setting%20Tool>。
- 如需設定的詳細資訊，請參閱 CaptureShare 軟體使用手冊中的 <AVerCamera Setting Tool> 章節。

規格

攝影機	
影像感測器	1/2.8" CMOS
有效畫素	800 萬畫素
輸出解析度	解析度：4K/1080p/720p 影格速率：60/59.94/50/30/29.97/25
最小照度	0.5 lux (50 IRE, F1.6, Max. AGC, 1/30)
信噪比	≥ 50dB
增益	自動、手動
電視掃描線	1000 (center/wide)
快門速度	1/1 到 1/10,000 秒
曝光控制	自動, 手動, AE 先決 (快門、光圈), BLC, WDR
白平衡	自動、手動
光學變焦	20X
數位變焦	1X
總變焦	20X
視野角度	DFOV : 69.2° (廣角) 到 4.1° (望遠) HFOV : 62.3° (廣角) 到 3.6° (望遠) VFOV : 37.3° (廣角) 到 2.1° (望遠)
焦距	f = 4.5 mm (廣角) 到 90 mm (望遠)
光圈 (Iris)	F = 1.8 (廣角) to 4.7 (望遠)
最小工作距離	廣角端：0.1 m, 望遠端：1.2 m
水平/垂直移動角度	水平：±170°, 垂直：+90° / -30°
水平/垂直移動速度 (手動)	水平：0.1° 到 100°/秒, 垂直：0.1° 到 100°/秒
預設速度	水平：200°/秒, 垂直：200°/秒
預設位置	10 (IR), 256 (RS-232, RS-422, IP)
攝影機控制 – 介面	RS-232 / RS-422 / 乙太網路
攝影機控制 – 協議	VISCA (RS-232/RS-422/IP), CGI (IP)
影像處理	鏡像 / 翻轉 / 定格 / WDR / BLC
電源頻率	50 Hz, 60 Hz
AI 功能	
模式	雙眼追蹤
隱私	
保護模式	隱私模式

一般規格	
電源需求	12V
耗電量	24W
PoE	PoE+ (IEEE802.3at)
尺寸 (W x H x D)	180(W) x 145(D) x 183.5(H) mm
淨重	1.7±0.1 公斤
應用場景	室內
提示燈	有
安全鎖	Kensington 防盜孔
紅外線遙控器	有
作業環境條件	溫度：0 °C 到 +40 °C 濕度：20% 到 80%
儲存及運輸環境條件	溫度：-20 °C 到 +60 °C 濕度：20% 到 95%
音訊	
聲道	2 聲道
編碼	AAC-LC (48K)
介面	
視訊輸出	HDMI, IP, USB
音訊輸出	HDMI, IP, USB
音訊輸入	無
IP 串流	
解析度	4K 60fps
網路視訊壓縮格式	H.264, H.265, MJPEG
最大張數	4K 60fps
位元速率控制模式	VBR, CBR
位元速率範圍	512Kbps ~ 64Mbps
網路介面	10 / 100 / 1000 Base-T
多串流支援	2 (RTSP/Webpage), 最大：4K 60fps
網路協議	IPv6, IPv4, TCP, UDP, ARP, ICMP, IGMP, HTTP, DHCP RTP/RTCP, RTSP, RTMP, VISCA over IP

USB	
接頭	USB3.0 (Type-B)
視訊格式	MJPEG
最高視訊	2160p
USB 視訊類別 (UVC)	UVC1.1
USB 音訊類別 (UAC)	UAC 1.0
網路介面	
即時視訊預覽	有
攝影機水平 / 垂直 / 變焦控制	水平, 垂直, 變焦, 對焦, 預設位置控制
攝影機/影像	曝光, 白平衡, 影像處理
網路設定	DHCP, IP Address, Gateway, Subnet Mask, DNS
軟體工具	
IP 搜尋及設定工具	支援 Windows® 7 或以上版本
PTZ Management	支援 Windows® 7 或以上版本
PTZ Control Panel	支援 iOS & iPadOS® 11 或以上版本
Camera Setting Tool	支援 Windows® 7 或以上版本、macOS® 10.14 或以上版本

規格如有變更，恕不另行通知。

故障排除

影像扭曲或模糊。

- 前往在網路介面上的 **Live View > Camera Control**，然後點擊  自動對焦。
- 長按遙控器上的**選單 (Menu)** 按鍵  3 秒以開啟 **OSD 選單 > System > Factory Default > On**，將所有設定恢復為出廠預設值。

如何開啟 **OSD 選單**？

1. 確保 **HDMI** 連接線已連上您的攝影機和螢幕。
2. 長按遙控器上的**選單 (Menu)** 按鍵  3 秒以開啟 **OSD 選單**。
3. **LED 指示燈**上恆亮紫燈表示 **OSD 選單**已開啟。

VISCA RS-232 指令表

Command Set	Command	Command Packet	Comments
Command Set	Command	Command Packet	Comments
IF_Clear	Broadcast	88 01 00 01 FF	I/F Clear (Clear Visca connection & command buffer queue)
CommandCancel	--	8x 2p FF	p: Socket No. (=1or2)
CAM_Power	On	8x 01 04 00 02 FF	Power OFF to Standby mode
	Off	8x 01 04 00 03 FF	Power ON supported in Standby mode only
CAM_Zoom	Stop	8x 01 04 07 00 FF	Zoom Control
	Tele(Standard)	8x 01 04 07 02 FF	
	Wide(Standard)	8x 01 04 07 03 FF	
	Tele(Variable)	8x 01 04 07 2p FF	p=0 (Low) to 7 (High)
	Wide(Variable)	8x 01 04 07 3p FF	
	Direct	8x 01 04 47 0p 0q 0r 0s FF	pqrs: Zoom Position. MD120UI: 0x00F0 (x1) ~ 0x5378 (x20)
CAM_Focus	Stop	8x 01 04 08 00 FF	Focus Control Each 'Far/Near' needs a 'stop'
	Far (Standard)	8x 01 04 08 02 FF	
	Near (Standard)	8x 01 04 08 03 FF	
	Far (Variable)	8x 01 04 08 2p FF	p=0 (Low) to 7 (High)
	Near (Variable)	8x 01 04 08 3p FF	
	Auto Focus	8x 01 04 38 02 FF	AF ON/OFF
	Manual Focus	8x 01 04 38 03 FF	
	Auto/Manual	8x 01 04 38 10 FF	
	One Push	8x 01 04 18 01 FF	
	Direct	8x 01 04 48 0p 0q 0r 0s FF	pqrs: Focus Position, MD120UI: 0x0000(wide) ~ 0x4000(tele)
	Near Limit	8x 01 04 28 0p 0q 0r 0s FF	pqrs: Focus Near Limit Position 0001: 0.01m 0002: 1m 0003: 1.5m 0004: 2m 0005: 3m 0006: 6m 0007: 10m

Command Set	Command	Command Packet	Comments
CAM_AFMode	Normal AF	8x 01 04 57 00 FF	Continuous AF ON
	Zoom Trigger AF	8x 01 04 57 02 FF	Continuous AF OFF, only trigger AF after PTZ done
CAM_WB	Auto	8x 01 04 35 00 FF	Normal Auto
	ATW	8x 01 04 35 04 FF	
	Indoor	8x 01 04 35 01 FF	
	Outdoor	8x 01 04 35 02 FF	
	One Push WB	8x 01 04 35 03 FF	One Push WB mode
	Manual	8x 01 04 35 05 FF	Manual Control mode
	One Push Trigger	8x 01 04 10 05 FF	One Push WB Trigger
CAM_RGain	Reset	8x 01 04 03 00 FF	Manual Control of R Gain
	Up	8x 01 04 03 02 FF	
	Down	8x 01 04 03 03 FF	
	Direct	8x 01 04 43 00 00 0p 0q FF	pq: R Gain
CAM_BGain	Reset	8x 01 04 04 00 FF	Manual Control of B Gain
	Up	8x 01 04 04 02 FF	
	Down	8x 01 04 04 03 FF	
	Direct	8x 01 04 44 00 00 0p 0q FF	pq: B Gain
CAM_AE	Full Auto	8x 01 04 39 00 FF	Automatic Exposure mode
	Manual	8x 01 04 39 03 FF	Manual Control mode
	Shutter Priority	8x 01 04 39 0A FF	Shutter Priority Automatic Exposure mode
	Iris Priority	8x 01 04 39 0B FF	Iris Priority Automatic Exposure mode
CAM_SlowShutter	Auto	8x 01 04 5A 02 FF	Auto Slow Shutter ON/OFF
	Manual	8x 01 04 5A 03 FF	
CAM_Shutter	Reset	8x 01 04 0A 00 FF	Shutter Setting
	Up	8x 01 04 0A 02 FF	
	Down	8x 01 04 0A 03 FF	
	Direct	8x 01 04 4A 00 00 0p 0q FF	pq: Shutter Position
CAM_Iris	Reset	8x 01 04 0B 00 FF	Iris Setting
	Up	8x 01 04 0B 02 FF	
	Down	8x 01 04 0B 03 FF	

Command Set	Command	Command Packet	Comments
	Direct	8x 01 04 4B 00 00 0p 0q FF	pq: Iris Position
CAM_Gain	Reset	8x 01 04 0C 00 FF	Gain Setting
	Up	8x 01 04 0C 02 FF	
	Down	8x 01 04 0C 03 FF	
	Direct	8x 01 04 4C 00 00 0p 0q FF	pq: Gain Position
	AE Gain Limit	8x 01 04 2C 0p FF	p: Gain Position (8 to E: 24db~42db)
CAM_Bright	Up	8x 01 04 0D 02 FF	--
	Down	8x 01 04 0D 03 FF	
	Direct	8x 01 04 4D 00 00 0p 0q FF	pq: Bright Position
CAM_ExpComp	Reset	8x 01 04 0E 00 FF	Exposure Comp Amount Setting
	Up	8x 01 04 0E 02 FF	
	Down	8x 01 04 0E 03 FF	
	Direct	8x 01 04 4E 00 00 0p 0q FF	pq: ExpComp Position
CAM_Backlight	On	8x 01 04 33 02 FF	Back Light Compensation ON/OFF
	Off	8x 01 04 33 03 FF	
CAM_LR_Reverse	On	8x 01 04 61 02 FF	Mirror Image ON/OFF
	Off	8x 01 04 61 03 FF	
CAM_Flip	On	8x 01 04 66 02 FF	Flip ON/OFF
	Off	8x 01 04 66 03 FF	
CAM_Preset	Reset	8x 01 04 3F 00 pp FF	Preset Cancel. pp: Preset Number 0x00~0xFF
	Set	8x 01 04 3F 01 pp FF	Preset Save.
	Recall	8x 01 04 3F 02 pp FF	Preset Load.
CAM_Menu	On	8x 01 06 06 02 FF	Menu Display ON/OFF
	Off	8x 01 06 06 03 FF	
	On/Off	8x 01 06 06 10 FF	
CAM_MenuEnter	--	8x 01 7E 01 02 00 01 FF	Enter Submenu
CAM_NR	--	8x 01 04 53 0p FF	p: Image NR Setting (0:OFF, Level1 to 3)
CAM_WDR	On	8x 01 04 3D 02 FF	Wdr ON/OFF
	Off	8x 01 04 3D 03 FF	
CAM_ICR	On	8x 01 04 01 02 FF	Infrared Mode ON (Night)

Command Set	Command	Command Packet	Comments
	Off	8x 01 04 01 03 FF	Infrared Mode OFF (Day)
CAM_AutoICR	On	8x 01 04 51 02 FF	Auto Infrared mode ON/OFF
	Off	8x 01 04 51 03 FF	
	Threshold	8x 01 04 21 00 00 0p 0q FF	pq: ICR OFF(Day)->ON(Night) threshold level 00: Low; 01: Middle; 02: High
CAM_IDWrite	--	8x 01 04 22 0p 0q 0r 0s FF	pqrs: Camera ID (=0000 to FFFF)
Video Format Change	--	8x 01 7E 01 1E 0p 0q FF	pq
			0x02: 1920x1080P/60
			0x03: 1920x1080P/59.94
			0x04: 1920x1080P/30
			0x05: 1920x1080P/29.97
			0x08: 1920x1080I/60
			0x0A: 1920x1080I/59.94
			0x0B: 1280x720P/60
			0x0C: 1280x720P/59.94
			0x0D: 1920x1080P/50
			0x18: 1920x1080P/25
			0x22: 1920x1080I/50
			0x26: 1280x720P/50
			0x30: 3840x2160P/60
			0x31: 3840x2160P/59.94
			0x32: 3840x2160P/50
			0x33: 3840x2160P/30
0x34: 3840x2160P/29.97			
0x35: 3840x2160P/25			
IR_Receive	On	8x 01 06 08 02 FF	Infrared remote commander reception ON
Pan-tilt Drive	Up	8x 01 06 01 VV WW 03 01 FF	VV: Pan speed setting 0x01 (low speed) to 0x18 (high speed)
	Down	8x 01 06 01 VV WW 03 02 FF	
	Left	8x 01 06 01 VV WW 01 03 FF	WW: Tilt speed setting 0x01 (low speed) to 0x18 (high speed)
	Right	8x 01 06 01 VV WW 02 03 FF	YYYY: Pan Position 7FFF(170°) to 8000(-170°)

Command Set	Command	Command Packet	Comments
	UpLeft	8x 01 06 01 VV WW 01 01 FF	(Normalized, CENTER 0000) ZZZZ: Tilt Position 7FFF(90°) to 8000(-30°) (Image Flip: OFF) (Normalized, CENTER 0000)
	UpRight	8x 01 06 01 VV WW 02 01 FF	
	DownLeft	8x 01 06 01 VV WW 01 02 FF	
	DownRight	8x 01 06 01 VV WW 02 02 FF	
	Stop	8x 01 06 01 VV WW 03 03 FF	
	AbsolutePosition	8x 01 06 02 VV WW 0Y 0Y 0Y 0Y 0Z 0Z 0Z 0Z FF	
	RelativePosition	8x 01 06 03 VV WW 0Y 0Y 0Y 0Y 0Z 0Z 0Z 0Z FF	
	Home	8x 01 06 04 FF	
	Reset	8x 01 06 05 FF	
Freeze	Freeze On	8x 01 04 62 02 FF	Freeze On Immediately
	Freeze Off	8x 01 04 62 03 FF	Freeze Off Immediately
	Preset Freeze On	8x 01 04 62 22 FF	Freeze On When Running Preset
	Preset Freeze Off	8x 01 04 62 23 FF	Freeze Off When Running Preset
RTMP	On	8x 01 04 A2 02 FF	RTMP ON/OFF
	Off	8x 01 04 A2 03 FF	
Reboot	On	8x 01 04 A4 FF	System reboot
P/T Spd. Relative Zoom Ratio	On	8x 01 04 A6 02 FF	P/T Speed Relative Zoom Ratio ON/OFF
	Off	8x 01 04 A6 03 FF	
Factory Reset	System Factory Reset	8x 01 04 3F 03 00 FF	
Preset Speed	Set Preset Speed	8x 01 06 20 0p FF	p=1 (Low) to 6 (High)

Inquiry Command	Command Packet	Inquiry Packet	Comments
Inquiry Command	Command Packet	Inquiry Packet	Comments
CAM_PowerInq	8x 09 04 00 FF	y0 50 02 FF	On
		y0 50 02 FF	Off
CAM_ZoomPosInq	8x 09 04 47 FF	y0 50 0p 0q 0r 0s FF	pqrs: Zoom Position
CAM_FocusModelInq	8x 09 04 38 FF	y0 50 02 FF	Auto Focus
		y0 50 03 FF	Manual Focus
CAM_FocusPosInq	8x 09 04 48 FF	y0 50 0p 0q 0r 0s FF	pqrs: Focus Position
CAM_FocusNearLimitInq	8x 09 04 28 FF	y0 50 0p 0q 0r 0s FF	pqrs: Focus Near Limit Position
CAM_AFModelInq	8x 09 04 57 FF	y0 50 00 FF	Continuous AF ON
		y0 50 02 FF	Continuous AF OFF, only trigger AF after PTZ done
CAM_WBModelInq	8x 09 04 35 FF	y0 55 00 FF	Auto
		y0 55 04 FF	ATW
		y0 55 01 FF	Indoor
		y0 55 02 FF	Outdoor
		y0 55 03 FF	One Push WB
		y0 55 05 FF	Manual
CAM_RGainInq	8x 09 04 43 FF	y0 50 00 00 0p 0q FF	pq: R Gain
CAM_BGainInq	8x 09 04 44 FF	y0 50 00 00 0p 0q FF	pq: B Gain
CAM_AEModelInq	8x 09 04 39 FF	y0 50 00 FF	Full Auto
		y0 50 03 FF	Manual
		y0 50 0A FF	Shutter Priority
		y0 50 0B FF	Iris Priority
		y0 50 0D FF	Bright
CAM_SlowShutterModelInq	8x 09 04 5A FF	y0 50 02 FF	Auto
		y0 50 03 FF	Manual
CAM_ShutterPosInq	8x 09 04 4A FF	y0 50 00 00 0p 0q FF	pq: Shutter Position
CAM_IrisPosInq	8x 09 04 4B FF	y0 50 00 00 0p 0q FF	pq: Iris Position
CAM_GainPosInq	8x 09 04 4C FF	y0 50 00 00 0p 0q FF	pq: Gain Position
CAM_GainLimitInq	8x 09 04 2C FF	y0 50 0q FF	p: Gain Limit
CAM_BrightPosInq	8x 09 04 4D FF	y0 50 00 00 0p 0q FF	pq: Bright Position

Inquiry Command	Command Packet	Inquiry Packet	Comments
CAM_ExpCompPosInq	8x 09 04 4E FF	y0 50 00 00 0p 0q FF	pq: ExpComp Position
CAM_BacklightModeInq	8x 09 04 33 FF	y0 50 02 FF	On
		y0 50 03 FF	Off
CAM_LR_Reverse_Inq	8x 09 04 61 FF	y0 50 02 FF	On
		y0 50 03 FF	Off
CAM_Flip_Inq	8x 09 04 66 FF	y0 50 02 FF	On
		y0 50 03 FF	Off
CAM_NRInq	8x 09 04 53 FF	y0 50 0p FF	p: NR Level
CAM_WDRInq	8x 09 04 3D FF	y0 50 02 FF	On
		y0 50 03 FF	Off
CAM_ICRModelInq	8x 09 04 01 FF	y0 50 02 FF	On (Night)
		y0 50 03 FF	Off (Day)
CAM_AutoICRModelInq	8x 09 04 51 FF	y0 50 02 FF	On
		y0 50 03 FF	Off
CAM_AutoICRThresholdInq	8x 09 04 21 FF	y0 50 00 00 0p 0q FF	pq: ICR OFF(Day)->ON(Night) threshold level 00: Low; 01: Middle; 02: High
CAM_IDInq	8x 09 04 22 FF	y0 50 0p 0q 0r 0s FF	pqrs: Camera ID
CAM_VersionInq	8x 09 00 02 FF	y0 50 ab cd mn pq rs tu vw FF	abcd: Vendor Code, AVer: 2574 mnpq: Model Code, MD120UI: 0565 rstu: Firmware version (ex: 4025 for 1.1.4025.0) vw: Socket Number (=02)
CAM_MenuModelInq	8x 09 06 06 FF	y0 50 02 FF	On
		y0 50 03 FF	Off
Video Format Inq	8x 09 06 23 FF	y0 50 02 FF	1920x1080P/60
		y0 50 03 FF	1920x1080P/59.94
		y0 50 04 FF	1920x1080P/30
		y0 50 05 FF	1920x1080P/29.97
		y0 50 08 FF	1920x1080I/60
		y0 50 0A FF	1920x1080I/59.94
		y0 50 0B FF	1280x720P/60
		y0 50 0C FF	1280x720P/59.94
		y0 50 0D FF	1920x1080P/50

Inquiry Command	Command Packet	Inquiry Packet	Comments
		y0 50 18 FF	1920x1080P/25
		y0 50 22 FF	1920x1080I/50
		y0 50 26 FF	1280x720P/50
		y0 50 30 FF	3840x2160P/60
		y0 50 31 FF	3840x2160P/59.94
		y0 50 32 FF	3840x2160P/50
		y0 50 33 FF	3840x2160P/30
		y0 50 34 FF	3840x2160P/29.97
		y0 50 35 FF	3840x2160P/25
IR_Receive	8x 09 06 08 FF	y0 50 02 FF	On
		y0 50 03 FF	Off
Pan-tiltPosInq	8x 09 06 12 FF	y0 50 0Y 0Y 0Y 0Y 0Z 0Z 0Z 0Z FF	YYYY: Pan Position 7FFF(170°) to 8000 (-170°) (Normalized, CENTER 0000) ZZZZ: Tilt Position 7FFF(90°) to 8000(-30°) (Image Flip: OFF) (Normalized, CENTER 0000)
CAM_Preset_Inq	8x 09 04 3F FF	y0 50 pp FF	Return the last preset number which has been operated pp:01-FF
Pan-tiltMaxSpeedInq	8x 09 06 11 FF	y0 50 ww zz FF	ww = Pan Max Speed zz = Tilt Max Speed
Freeze_Mode_Inq	8x 09 04 62 01 FF	y0 50 02 FF	On
		y0 50 03 FF	Off
Preset_Freeze_Inq	8x 09 04 62 02 FF	y0 50 02 FF	On
		y0 50 03 FF	Off
RTMP_Inq	8x 09 04 A2 FF	y0 50 02 FF	On
		y0 50 03 FF	Off
Preset_Speed_Inq	8x 09 06 20 FF	y0 50 0p FF	p=1 (Low) to 6 (High)
Firmware version	8x 09 36 69 04 FF	y0 50 0p 0q 0r 0s 0t 0u 0v 0w FF	fw_ver: p.q.rstu.vw

VISCA over IP 設定

PORT

Internet protocol	IPv4
Transport protocol	UDP
Port address	52381

FORMAT

	byte 0	byte 1	byte 2	byte 3	byte 4	byte 5	byte 6	byte 7	byte 8 ~~~ byte 23
func	Payload type		Payload Length		Sequence number				Payload (1 to 16 bytes)
data	Value1	Value2	1~16(0x0001~0x0010)		0x00000000 ~ 0xFFFFFFFF				VISCA Packet (see page VISCA)

Payload type

Name	Value1	Value2	Description
VISCA command	0x01	0x00	Stores the VISCA command.
VISCA inquiry	0x01	0x10	Stores the VISCA inquiry.
VISCA reply	0x01	0x11	Stores the reply for the VISCA command and VISCA inquiry, or VISCA device setting command
VISCA device setting command	0x01	0x20	Stores the VISCA device setting command.
Control command	0x02	0x00	Stores the control command
Control reply	0x02	0x01	Stores the reply for the control command.

CGI 指令

CGI List for Video Transmission					
CGI item name	URL	Command	Parameter Name	Parameter value	Description
Get JPEG	/snapshot				1280x720 jpg
Get 4K JPEG	/cgi-bin?OnePush=n				Step 1: request 4k snapshot
	/snapshot?res=4k				Step 2: get 3840x2160 jpg
Get RTSP stream	rtsp://ip/live_st1				

CGI List for Audio					
CGI item name	URL	Command	Parameter Name	Parameter value	Description
Audio In Volume	/cgi-bin?Set=	ado_vol,3,N		0 ~10	0 ~ 10 volume

CGI List for Camera Control					
CGI item name	URL	Command	Parameter Name	Parameter value	Description
up start	/cgi-bin?SetPtfz=	1,0,1			
up end	/cgi-bin?SetPtfz=	1,0,2			
down start	/cgi-bin?SetPtfz=	1,1,1			
down end	/cgi-bin?SetPtfz=	1,1,2			
left start	/cgi-bin?SetPtfz=	0,1,1			
left end	/cgi-bin?SetPtfz=	0,1,2			
right start	/cgi-bin?SetPtfz=	0,0,1			
right end	/cgi-bin?SetPtfz=	0,0,2			
zoom_in start	/cgi-bin?SetPtfz=	2,0,1			
zoom_in end	/cgi-bin?SetPtfz=	2,0,2			
zoom_out start	/cgi-bin?SetPtfz=	2,1,1			
zoom_out end	/cgi-bin?SetPtfz=	2,1,2			
set preset:	/cgi-bin?ActPreset=	1,N			N : position
load preset:	/cgi-bin?ActPreset=	0,N			N : position

CGI List for Various Settings					
CGI item name	URL	Command	Parameter Name	Parameter value	Description
exposure value	/cgi-bin?Set=	img_expo_expo,3,N	value	1 ~ 9	N : value
saturation	/cgi-bin?Set=	img_saturation,3,N	value	0 ~ 10	N : value
contrast	/cgi-bin?Set=	img_contrast,3,N	value	0 ~ 4	N : value

Tracking on:	/cgi-bin?Set=	trk_tracking_on,3,1			
Tracking off:	/cgi-bin?Set=	trk_tracking_on,3,0			
Reboot	GET(Basic Authentication)	/cgi-bin?OnePush=!			
Factory Reset	GET(Basic Authentication)	/cgi-bin?OnePush=d			
RTMP Start streaming	/cgi-bin?Set=	vdo_rtmp_enable,3,1			
RTMP Stop streaming	/cgi-bin?Set=	vdo_rtmp_enable,3,0			
Status get (Model name & mac & FW_VER)	/cgi-bin?GetString=	sys_name&net_mac&sys_fw_version			http://10.100.105.110/cgi-bin?GetString=sys_name&net_mac&sys_fw_version
Serial No. get	/cgi-bin?GetSerialNumber				http://10.100.105.110/cgi-bin?GetSerialNumber
oneclick	/cgi-bin?Set=	ptz_oneclick_x,3,N1&ptz_oneclick_y,3,N2&ptz_oneclick_spd,3,N3		ptz_one_click_spd 1~24	N1, N2 = X, Y coordinates (1080P, 0,0 at top left) N3=moving speed
IR Cut Filter	/cgi-bin?Set=	img_ircut_filter,3,N		0 ~ 2	0 = Day, 1 = Night, 2 = Auto
IR Cut Filter Sensitivity	/cgi-bin?Set=	img_ircut_sensitivity,3,N		0 ~ 2	0 = Low, 1 = Middle, 2 = High

CGI List for AI Settings					
CGI item name	URL	Command	Parameter Name	Parameter value	Description
Eyes Tracking On/Off	/cgi-bin?Set=	trk_tracking_on,3,N	value	0 / 1	0: OFF; 1: ON
Tracking Preset	/cgi-bin?ActPreset=1,255				Save current pos. for eye tracking preset point.
Timeout to preset	/cgi-bin?Set=	trk_lost_time,3, N	value	3 / 5 / 7 / 10	timeout in seconds
Tracking Site	/cgi-bin?Set=	trk_mode,3,N	value	0 / 1	0: Full face; 1: Eyes
Tracking Range	/cgi-bin?Set=	trk_sensitivity,3,N	value	0 ~ 2	0: Close; 1: Medium; 2: Wide
Eyes Tracking On/Off Get	/cgi-bin?Get=trk_tracking_on				
	- Reply	On trk_tracking_on=1			

		Off trk_tracking_on=0			
Audio Detection On/Off	/cgi-bin?Set=	ado_det_alarm,3,N	value	0 / 1	0: OFF; 1: ON
Alarm Detection Type	/cgi-bin?Set=	ado_alm_general,3,N	value	0 / 1	general type. 0: OFF; 1: ON
		ado_alm_oxygen,3,N	value	0 / 1	oxygen type. 0: OFF; 1: ON
		ado_alm_ventilation,3,N	value	0 / 1	ventilation type. 0: OFF; 1: ON
		ado_alm_cardiovascular,3,N	value	0 / 1	cardiovascular type. 0: OFF; 1: ON
		ado_alm_temperature,3,N	value	0 / 1	temperature type. 0: OFF; 1: ON
		ado_alm_drug,3,N	value	0 / 1	drug type. 0: OFF; 1: ON
		ado_alm_artificial,3,N	value	0 / 1	artificial type. 0: OFF; 1: ON
		ado_alm_power,3,N	value	0 / 1	power type. 0: OFF; 1: ON
		ado_alm_information,3,N	value	0 / 1	information type. 0: OFF; 1: ON

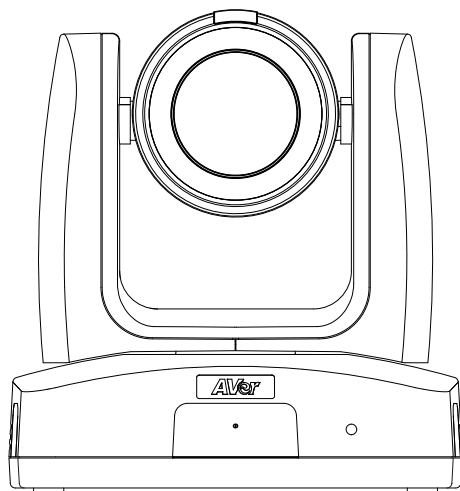

MD120UI 追尾カメラ

ユーザーマニュアル



清掃と消毒の方法

警告 個人のけがの危険性があります	フェノールを含む清掃剤は、十分にすすがない場合に皮膚のやけどを引き起こす可能性があるため使用しないでください。また、清掃または消毒の性質が不十分な場合もあります。
注意事項	<ol style="list-style-type: none">1. カメラは、簡単に清掃と消毒ができるように設計されています。2. カメラを清掃する前に、電源を切断してください。3. 清掃作業は、カメラ操作に精通した人員のみが行うようにしてください。4. 内部の電気機器やカメラの部品に、清掃液、特に水を吹き付けしないでください。これにより、短絡、腐食、故障、ユーザーやサービス担当者に電気ショックの危険が生じる可能性があります。5. 腐食性のある清掃剤は、カメラの変色や損傷を引き起こす可能性があります。清掃剤を使用する前に、目立たない箇所テストしてください。
いつ	使用前と使用後にカメラを清掃してください。
手順	<ol style="list-style-type: none">1. カメラを電源から切断してください。2. 清掃作業員は、清掃用手袋を着用する必要があります。3. 清掃アルコールを使用する前に、期限切れでないことを確認してください。4. 清掃アルコール(75%)で湿らせた清掃布を使用して、カメラに接触する可能性のあるすべての表面を拭いてください。5. カメラを拭いた後は、素手で触らないでください。
頻度	定期的な清掃は必要ありません。使用前と使用後に清掃してください。

製品印字の記号

付属品を含む本製品の記号は、以下内容を表示しています。

	<p>WEEE シンボル</p> <p>この記号は、この製品を他の家庭ごみと一緒に廃棄してはならないことを示しています。代わりに、廃電気電子機器のリサイクルのために指定された収集場所に廃棄物を引き渡して処分する必要があります。廃棄物をリサイクルする場所の詳細については、廃棄処理サービスまたは製品を購入したショップにお問い合わせください。</p>
	<p>CE コンプライアンスロゴ</p> <p>このロゴは、製品が欧州連合の調和法に関連するガイドライン/基準に準拠していることを示しています。</p>
	<p>FCC コンプライアンスロゴ</p> <p>このロゴは、製品が連邦通信委員会のコンプライアンス基準に準拠していることを示しています。</p>
	<p>UKCA (UK Conformity Assessed)</p> <p>この記号は、英国市場に出回っている製品が UKCA マーキングの要件を満たしていることを示しています。</p>
	<p>RCM コンプライアンスロゴ</p> <p>このロゴは、製品がオーストラリアの RCM ガイドラインに準拠していることを示しています。</p>
	<p>このロゴは、製品の筐体内に感電の危険をもたらすのに十分な大きさの絶縁されていない「危険な電圧」が存在することをユーザーに警告することを目的としています。</p>
	<p>このロゴは、アプライアンスに付属の資料に重要な操作および保守(サービス)手順が存在することをユーザーに警告することを目的としています。</p>
	<p>中国 RoHS</p> <p>この記号の数字は、通常の使用条件下で危険物質が漏れたり変異したりしない年数を表しています。</p>
	<p>交流記号</p> <p>この記号は、製品の電源入出力が交流であることを示しています。</p>
	<p>直流記号</p> <p>この記号は、製品の電源入出力が直流であることを示しています。</p>

VCCI-A

この装置は、クラス A 機器です。この装置を住宅環境で使用すると電波妨害を引き起こすことがあります。この場合には使用者が適切な対策を講ずるよう要求されることがあります。

リモコンの電池に関する安全上の注意

- 電池は湿気のない涼しい場所に保管してください。
- 使用済みの電池をゴミ箱に捨てないでください。使用済みの電池は、各自治体の指定する処分方法に従って適切に処分してください。
- 長時間にわたって電池を使用していない場合は取り外してください。漏電と腐食により、リモコンが破損する恐れがあります。
- 古い電池と新しい電池を一緒に使用しないでください。
- 異なる種類の電池を一緒に使用しないでください。(アルカリ、マンガン (炭素亜鉛)、またはニッケルカドミウム)。
- 電池を火で燃やして処分しないでください。
- 電池の端子をショートさせないでください。

免責事項

このドキュメントの内容、その品質、パフォーマンス、商品性、または特定の目的への適合性に関して、明示または黙示を問わず、いかなる保証または表明も行われません。本紙に記載されている情報は、信頼性について注意深くチェックされています。ただし、不正確な点については責任を負いません。このドキュメントに含まれる情報は、予告なしに変更される場合があります。

AVer Information Inc.は、この製品またはドキュメントの使用または使用不能に起因する直接的、間接的、特別、偶発的、または結果的な損害について、そのような損害の可能性について知らされていたとしても、いかなる場合も責任を負いません。

商標

「AVer」は、AVer Information Inc.が所有する商標です。ここで説明目的で使用されているその他の商標は、それぞれの会社にもみ帰属します。

著作権

©2023 AVer Information Inc. 無断複写・転載を禁じます。| 2023年6月7日

このオブジェクトのすべての権利は AVer Information Inc.に帰属します。

本紙の内容は AVer Information Inc.の書面による事前の許可なしに、いかなる形式または手段によっても複製または送信することは禁じられています。すべての情報または仕様は、事前の通知なしに変更される場合があります。

製品サポート

FAQ、テクニカルサポート、ソフトウェア、およびユーザーマニュアルのダウンロードについては、次の Web サイトをご覧ください。

ダウンロードセンター: <https://jp.aver.com/download-center>

ヘルプセンター: <https://jp.aver.com/technical-support>

お問い合わせ先

アバー・インフォメーション株式会社

HP: <https://jp.aver.com>

〒160-0023 東京都新宿区西新宿 3-2-26 立花新宿ビル 7 階

TEL: 03 5989 0290

テクニカル・サポート: <https://jp.aver.com/technical-support>

目次

清掃と消毒の方法	2
製品概要	1
パッケージ同梱物.....	1
オプション販売品.....	1
本体寸法.....	2
天井取付マウント.....	3
壁設置用マウント.....	4
パン・チルト動作範囲.....	4
インストール.....	5
クイックガイド.....	5
天井取付マウント.....	6
接続.....	7
プライバシーインジケータ.....	7
LED インジケータ.....	7
デバイスの接続.....	8
操作リモコン.....	11
ショートカット.....	12
カメラの設定	13
OSD メニュー.....	13
IP アドレス設定.....	13
OSD のメニューツリー.....	15
Web 設定.....	18
カメラの Web 管理画面にアクセスする.....	18
ライブビュー.....	20
AI 設定.....	22
カメラ設定.....	24
ビデオ/オーディオ.....	26

ネットワーク.....	27
システム	29
AVerCamera Setting Tool.....	31
仕様.....	32
トラブルシューティング	35
追加資料	36
VISCA RS-232 制御コマンドテーブル.....	36
VISCA over IP 設定.....	44
CGI コマンドリスト	45

製品概要

MD120UI 追尾カメラは、患者の監視用に設計された医療グレードのカメラです。赤外線ナイトビジョンと耐紫外線ケースを備えています。

パッケージ同梱物

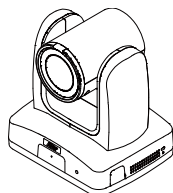

カメラ

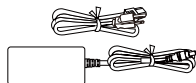

電源アダプタ
電源コード*

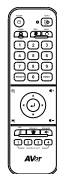

リモコン



USB 3.0 ケーブル
Type-B/Type-A (1.5m)

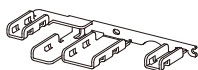

ケーブル
固定プレート



ケーブル固定タイ (x4)

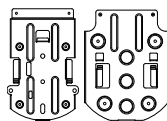

天井取付
マウントブラケット (x2)

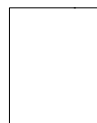

穴あけテンプレート



M2 x 4mm
ネジ (x3)



M3 x 6mm
ネジ (x3)



1/4"-20 L=6.5mm
ネジ (x2)



クイックガイド

オプション販売品

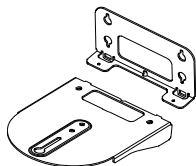

壁設置用
マウントブラケット

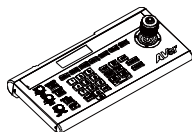

カメラコントローラー
(CL01)

本体寸法

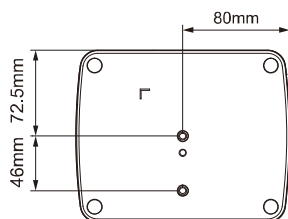
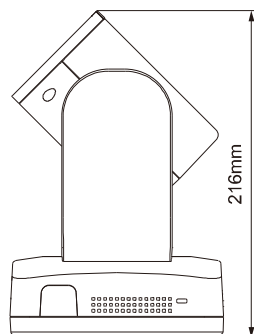
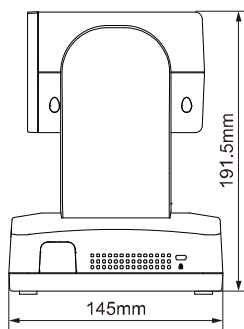
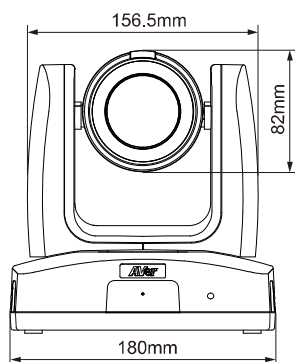

天井取付マウント

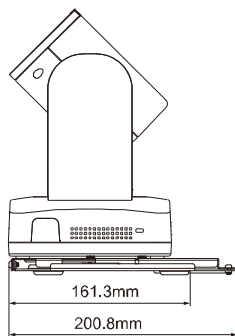
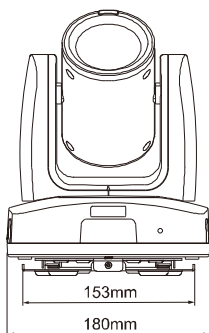
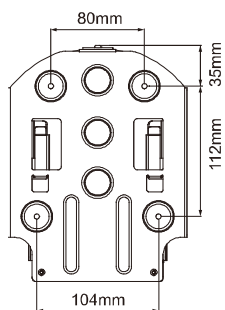
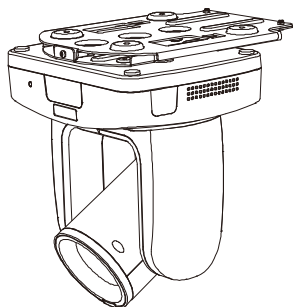

壁設置用マウント

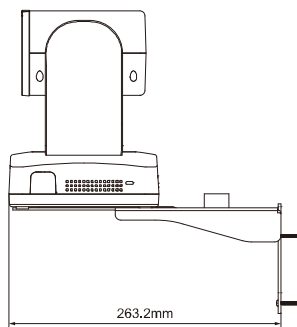
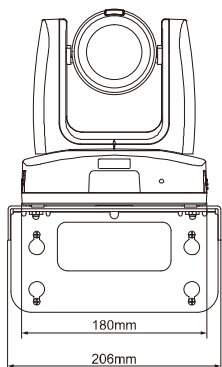
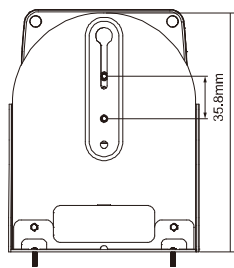
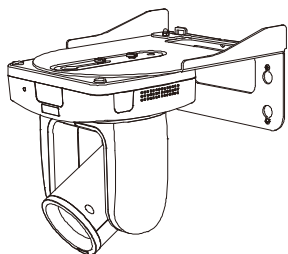
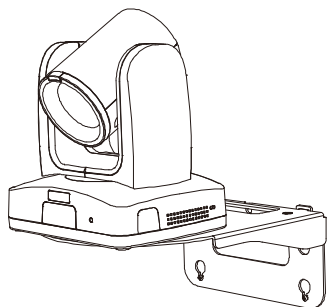

パン・チルト動作範囲

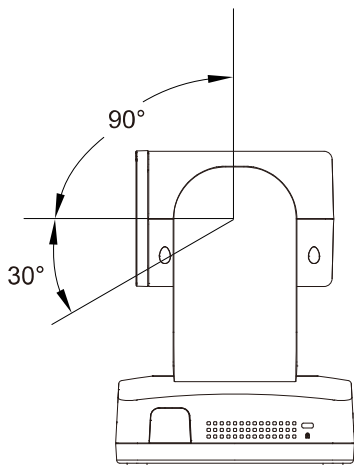
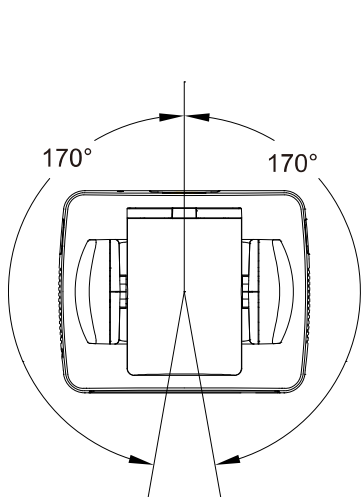

インストール

クイックガイド

1. 製品同梱の M2 ネジ(4mm)を使用し、ケーブル固定プレートをカメラに固定します。

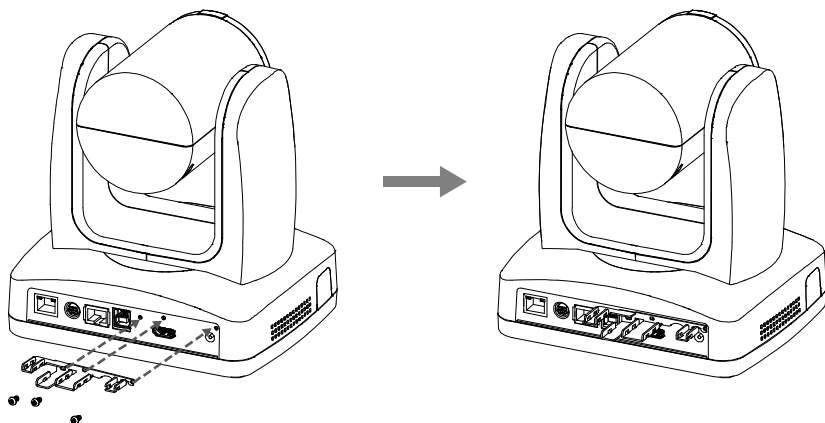

2. 各ケーブルを接続します。

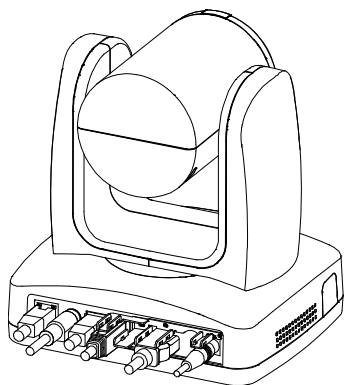

3. スロットを通して、ケーブルタイでケーブルをケーブル固定プレートに固定してください。

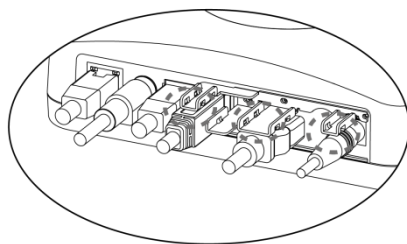

天井取付マウント

1. マウントブラケットを天井へ固定します。

ネジ: M4 x 10mm 4 本 (別売り)

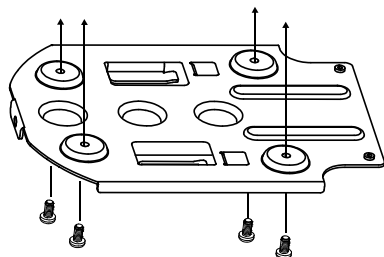

2. マウントブラケットをカメラへ取り付けます。

ネジ: 1/4"-20 L=6.5mm 2 本 (同梱)

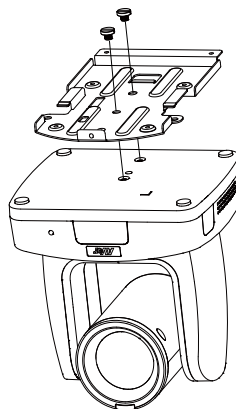

3. カメラを取り付けたブラケットを、天井に固定されているブラケットにスライドさせます。そしてケーブルを接続します。

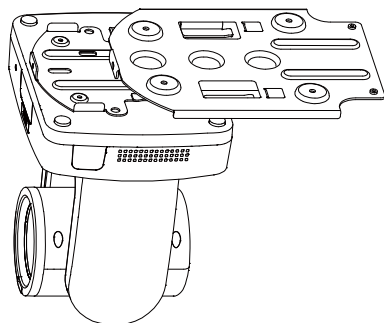

4. ブラケットをネジで固定してください。

ネジ: M3 x 6mm 3 本 (同梱)

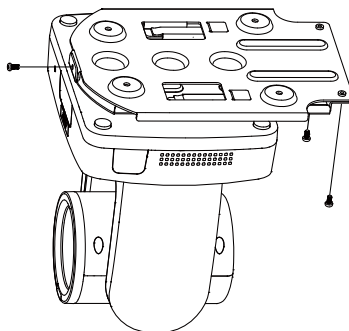

接続

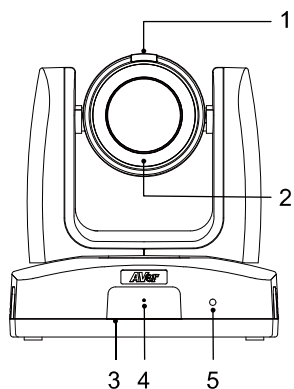

前面

1. プライバシーインジケータ
2. 赤外線ナイトビジョン LED*
3. リモコン赤外線受光部
4. マイク
5. LED インジケータ

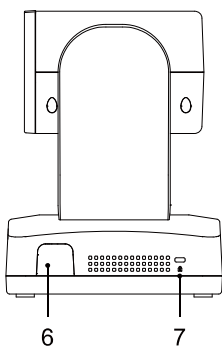

側面

6. リモコン赤外線受光部
7. Kensington ロック

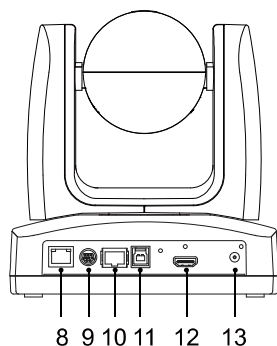

背面

8. PoE+端子*
9. RS-232 端子
10. RS-422 端子
11. USB 端子(USB3.1 Type-B)
12. HDMI 端子
13. DC 電源差込口

* 赤外線照射による被害を避けるため、夜モードを使用する場合は IR LED と眼の間に 1メートル以上の距離を持たせてください。

プライバシーインジケータ

色	状態
緑点灯	患者の監視中
消灯	プライバシーモード/電源オフ

LED インジケータ

色	状態
青点灯	通常
青点滅	追尾オン
オレンジ点灯	待機状態
オレンジ点滅	起動中
紫点灯	OSD メニュー起動中
紫点滅	ファームウェア更新中

デバイスの接続

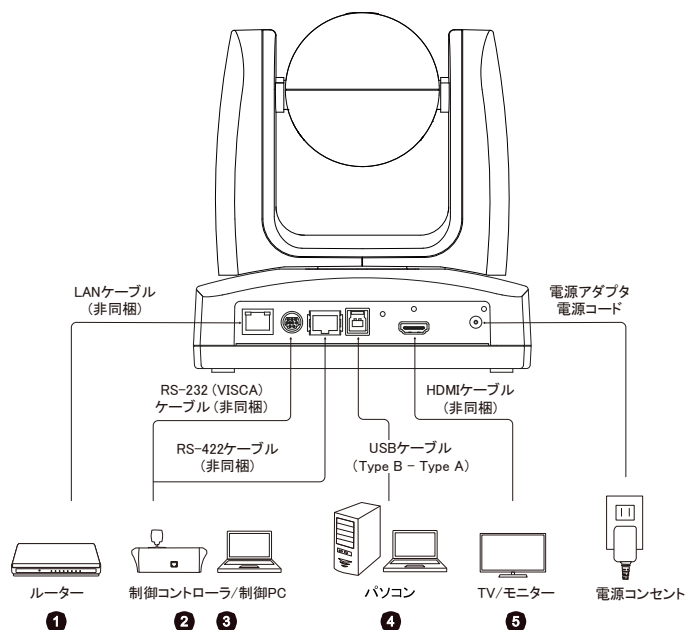

- LAN:** LAN 端子を使用し、カメラを IP ネットワークに接続できます。(注)
- RS-232:** カメラをジョイスティックまたはラップトップに接続して、カメラを制御します。オプションで RS-232 アダプターを購入できます。PIN の定義は下記の通りです。(注)

● ピン端子

	機能	Mini DIN9 ピン番号	入力/出力	信号	説明
	VISCA 入力	1	出力	DTR	データ端末準備完了
		2	入力	DSR	データセット準備完了
		3	出力	TXD	データ送信
		6	入力	RXD	データ受信
	VISCA 出力	7	出力	DTR	データ端末準備完了
		4	入力	DSR	データセット準備完了
		8	出力	TXD	データ送信
		9	入力	RXD	データ受信
		5	入力	I/O	DIN8/DIN9 の検出
	---	シールド	---	GND	アース

3. RS-422:カメラを操作するジョイスティックまたはノートパソコンへ、カメラを接続します。複数台のカメラを接続する場合は、CAT5e スプリッターケーブルを使用してください。

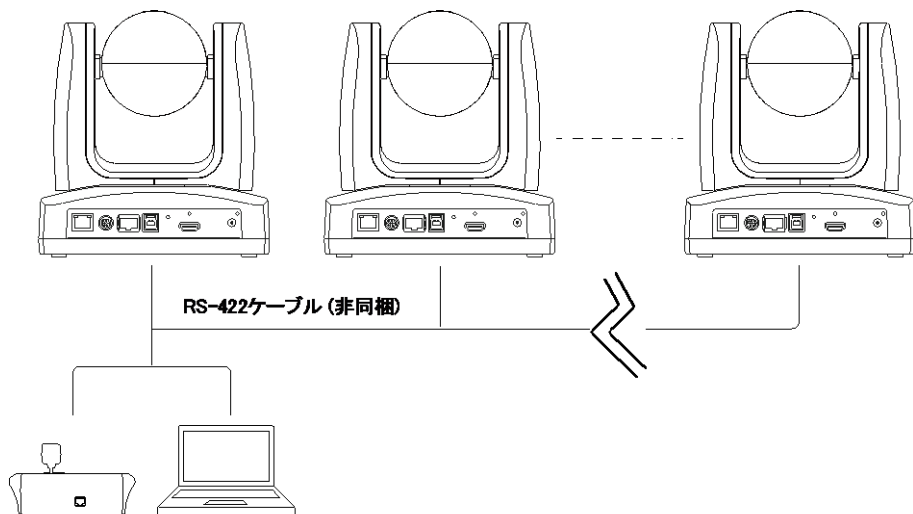

制御コントローラ/制御PC

● ピン端子

	番号	ピン	番号	ピン
	1	TX+	5	TX-
	2	TX-	6	RX-
	3	RX+	7	RX+
	4	TX+	8	RX-

● CAT5e スプリッターケーブルのピン配置

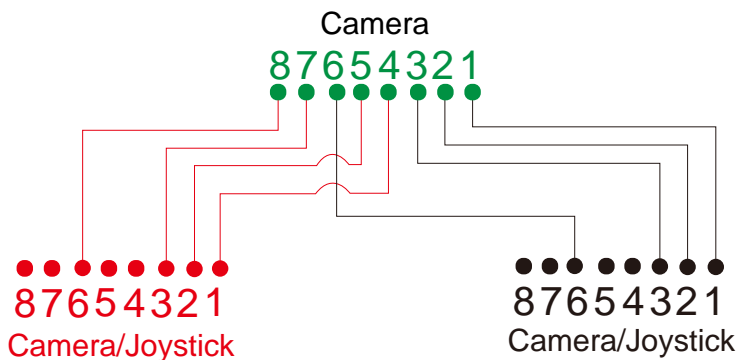

4. **USB Type-B:** Skype や Teams などのサードパーティのビデオ会議ソフトウェアを使用する場合、カメラをパソコンに接続しカメラ映像をビデオ出力できます。(注)
5. **HDMI:** カメラをテレビまたはモニターに接続して、ビデオ出力を表示します。カメラと接続されているテレビやモニターはアース接地する設計が必要です。(注)
6. **電源:** 付属の電源アダプターと電源コードを使用してカメラを電源コンセントに接続し、テレビまたはモニターの電源コードがアース プラグをサポートしているか、確認してください。

[注]

アナログおよびデジタルインターフェースに接続された機器は、使用する国で医療機器用として認定された IEC 規格(データ処理機器の場合は IEC 60950、ビデオ機器の場合は IEC 60065、実験機器の場合は IEC 61010-1、医療機器の場合は IEC 60601-1)に準拠する必要があります。)また、機器構成の全ては、IEC60601-1 のシステム要件に準拠する必要があります。追加の機器を信号入力部分または信号出力部分に接続するすべての機器が医療システムを構成するため、IEC60601-1 のシステムの要件に準拠する責任があります。本製品は、IEC60601-1 認定機器および IEC60XXX 認定機器との排他的相互接続用です。規格に準拠されているか疑わしい場合は、技術サービス部門または最寄りの代理店にご相談ください。

操作リモコン

リモコンには単4電池2本が必要です。使用前に、電池が正しく取り付けられていることを確認してください。

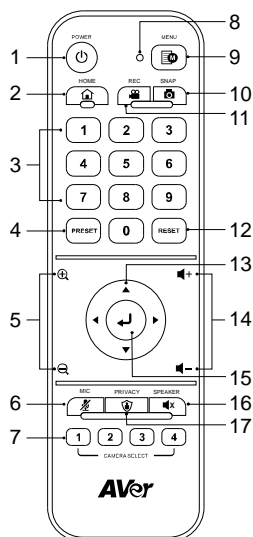







Model: LY033

タン名称	呼び出される機能
1. Power	アイドルモードのオン/オフが切り替え。
2. Home	カメラをホームポジションに移動。
3. Number Pad	<ul style="list-style-type: none"> ● ボタン0~9を押して、設定されたプリセット位置に移動します。 ● ボタン0~9を使用して、プリセット位置0~9を設定します。
4. Preset	<p>プリセット、数字、方向ボタンを使用して、プリセット位置を設定します。</p> <ol style="list-style-type: none"> 1. 方向ボタンを使用して、位置をナビゲートします。必要に応じて、「ズーム+」または「ズーム-」ボタンを使用して、画像をズームイン/ズームアウトします。 2. プリセットを押してから数字ボタン(0~9)を押して、このプリセット位置を保存します。
5. Zoom +/-	カメラ映像のズームイン・ズームアウト。
6. MIC	マイクのミュート・ミュート解除 切替。
7. Camera Select	カメラを選択して操作してください。OSDメニューで番号を指定してください: システム > カメラ選択 。
8. Remote Control LED	リモコンのボタンを押すと、LED が赤く点灯します。
9. Menu	3秒間長押し続けて OSDメニューを開きます。OSDメニューでこの設定を編集してください: システム > トリガーOSD 。
10. Snap	N/A
11. Rec	N/A
12. Reset	リセットボタンと数字ボタンを使用して、事前に設定されたプリセット位置をキャンセルしてください。リセットボタンを長押しし、その後に数字ボタン(0~9)を押してください。
13. Direction	ライブビューをナビゲートするために、方向ボタンを使用してください。

	14. Volume +/-	N/A
	15. Enter	カメラがオンの場合:フォーカスを1回調整するには、Enter ボタンを押してください。 OSD メニューにアクセスする場合:選択を確認するか、選択を行うには、Enter ボタンを押してください。
	16. Speaker	N/A
	17. Privacy	プライバシーモード切替。 カメラがプライバシー位置に移動し、マイクがオフになります。

ショートカット

操作	動作内容
Menu  を3秒間押す	OSD メニューを開きます。
Menu  を押す	OSD メニューを閉じる。
Home  を押す	OSD メニューを閉じ、カメラはホーム ポジションに戻ります。
Menu  と Zoom  押し	昼モードと夜モードを切り替えてください。
Menu  と Zoom  押し	昼モードと自動モードを切り替えてください。
5 を五回 (55555)	DHCP をオンにします。
6 を六回 (666666)	カメラを工場出荷設定へリセットします。
8 を八回 (88888888)	カメラの固定 IP アドレスを 192.168.1.168 へ設定します。

カメラの設定

OSD メニューまたはカメラの Web インターフェイスを使用して、カメラ設定を構成できます。

OSD メニュー

OSD メニューを使用するには、HDMI ケーブルを使用してカメラをモニタに接続し、付属リモコンを使用して OSD メニューの操作を行います。

OSD メニューを開くには、**Menu** (M) を 3 秒間長押し続けてください。方向ボタン ▲▼◀▶ を使用して選択し、設定を確認するには **Enter** ↵ を押してください。

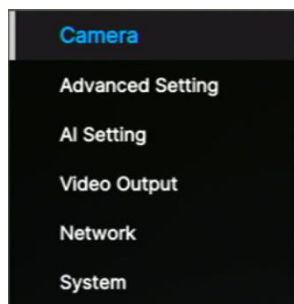



IP アドレス設定

固定 IP

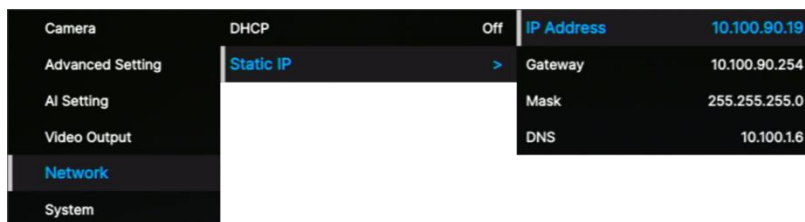
1. リモコンで **Menu** (M) を 3 秒間長押しすると、OSD メニューが表示されます。
2. **ネットワーク** > **スタティック IP** に移動してください。
[注] スタティック IP を設定する前に、DHCP をオフにしてください(**ネットワーク** > **DHCP** > **オフ**)。
3. **IP アドレス**、**ゲートウェイ**、**マスク**、および **DNS** を設定するために選択してください。Enter ↵ を押し、値を入力するために数字ボタンを使用してください。



DHCP

1. リモコンで **Menu**  を3秒間長押しすると、OSDメニューが表示されます。
2. **ネットワーク > DHCP > オン** を選択してください。
3. 設定を確認するために **Enter**  ボタンを押してください。



4. DHCP をオンにした後、**システム > 情報**に移動して IP アドレスを確認できます。

Camera	Trigger OSD	Press Menu 3 sec	Model Name	MD120UI
Advanced Setting	Camera Selector	All	Serial Number	5100435000010
AI Setting	Status OSD	Off	Version	1.1.0502.0
Video Output	Language	English	IP Address	0.0.0.0
Network	Information	>	MAC	00:18:1A:0C:BA:4E
System	Factory Default	>	Lens	C004
	System Reboot	>	Mcu	A001

OSD のメニューツリー

第 1 レベル	第 2 レベル	第 3 レベル	第 4 レベル
カメラ	曝光モード	全自動	露出度
			ゲイン限界値
			スローシャッター
			BLC
			WDR
		シャッター優先	露出度
			シャッター速度
			ゲイン限界値
		絞り優先	露出度
			絞り値
			ゲイン限界値
			スローシャッター
		手動	絞り値
			シャッター速度
			ゲイン値
		輝度モード	輝度値
	ホワイトバランス	自動	
		ATW	
		室内	
		室外	
		ワンプッシュトリガー	
		手動	R ゲイン
		B ゲイン	
	パンチルトズーム	プリセット速度	5/25/50/100/150/200
		プリセット精度	オフ/オン
		パン速度	1~24
		チルト速度	1~24
		ズーム速度	低/高
速度相対ズーム比		オフ/オン	
パン方向スイッチ		オフ/オン	

	ノイズフィルター	オフ/低/中/高	
	彩度	0 1 2 3 4 5 6 7 8 9 10	
	コントラスト	0 1 2 3 4	
	シャープネス	0 1 2 3	
	ミラー	オフ/オン	
	フリップ	オフ/オン	
詳細設定	音声	音量	0~10
	制御	形式	RS232/RS422
		プロトコル	VISCA
		カメラアドレス	1 2 3 4 5 6 7
		ボーレート	4800 / 9600 / 38400
	IR カットフィルタ	自動/昼/夜	
IR カットフィルタ感度	低/中/高		
AI 設定	顔追尾	目追尾	オン/オフ
		追尾プリセット	保存
		追尾モード	顔全体/両目
		追尾範囲	近/中/遠
		追尾タイムアウト時間	3/5/7/10 秒
	AI 音声検出	音声検出	オン/オフ
ビデオ出力	イメージのテーマ	HDMI/UVG	
	周波数	60	
		59.94	
		50	
	解像度	2160p60	
		2160p59	
		2160p50	
		2160p30	
		2160p29	
		2160p25	
		1080p60	
		1080p59	
		1080p50	

		1080p30	
		1080p29	
		1080p25	
		1080i60	
		1080i59	
		1080i50	
		720p60	
		720p59	
		720p50	
		ネットワーク	DHCP
オン			
固定 IP	IP アドレス		192.168.1.168
	ゲートウェイ		192.168.1.254
	マスク		255.255.255.0
	DNS		8.8.8.8
システム	トリガー OSD		Menu を押して開き、 Menu を 3 秒長押し
	カメラ選択	1、2、3、4、全てのチャンネル、 無効にする	
	状態 OSD	オフ	
		オン	
	言語	English/中文/日本語	
	システム情報	モデル名	MD120UI
		シリアル番号	xxxxxxxxxxxx
		ファームウェアバージョン	0.0.0000.00
		IP	192.168.1.168
		MAC	00:18:1a:04:9e:81
カメラユニット		xxxx	
MCU		xxxx	
工場出荷設定	オフ/オン		
システム再起動	オフ/オン		

Web 設定

カメラの Web 管理画面にアクセスする

カメラの Web インターフェイスにアクセスするには、AVer IPCam Utility または AVer PTZ Management ソフトウェアを使用してカメラの IP アドレスを確認します。

AVer IPCam Utility を使用する場合

IPCamユーティリティインストーラを使用してカメラのIPアドレスを見つけるには、以下の手順に従います。

1. <https://www.aver.com/download-center>からIPCamUtilityをダウンロード、インストールします。
2. **Search** をクリックすると、ネットワーク上の使用可能なカメラデバイスがリスト表示されます。
3. 表示リスト内の設定するカメラを選択し、カメラ情報 **Settings** のフィールドに表示します。

[注] カメラのデフォルトネットワークは固定IP(192.168.1.168)に設定されています。デフォルトID/パスワードは**admin/admin**です。DHCPに設定する場合は、**Login** フィールドにID /パスワードを入力し、表示リスト内の設定を行うカメラを選択し、**DHCP** を選択して、**Apply** ボタンをクリックします。

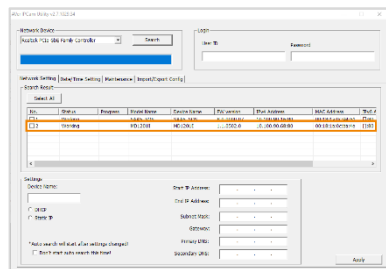

4. Web管理画面にアクセスするには、**IPv4 Address** 列のIPアドレスをダブルクリックします。初回ログイン時、IDとパスワードを変更するためのウィンドウが表示されます。

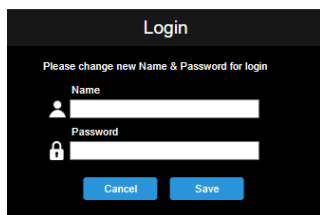

5. 新しいID/パスワードでログインすると、カメラのWeb管理画面が表示されます。詳細については、<[ライブビュー](#)>の章を参照してください。

[注] IPCamユーティリティがカメラを見つけられない場合は、以下を確認してください。

1. カメラのイーサネット接続が適切に接続されていることを確認してください。
2. カメラとPC (IPCamUtility) は、同じLANセグメント上で接続されている必要があります。

AVer PTZ Management を使用する場合

AVer PTZ Managementを使用してカメラのIPアドレスを見つけるには、以下の手順に従います。

1. AVer PTZ Management をダウンロード・インストールします。 <https://www.aver.com/download-center>
2. ユーザーIDとパスワードを設定した後、ソフトウェアにログインします(デフォルトのユーザー名/パスワード: **admin / admin**)。

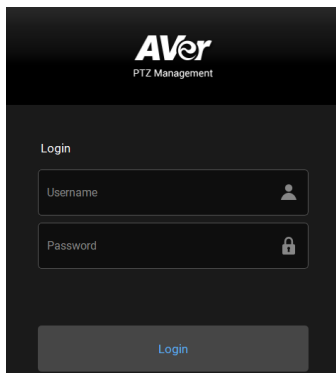

3. **Setup > Add** をクリックし、**Auto Search** をクリックします。パソコンと同一 LAN に接続されているカメラがリスト表示されます。

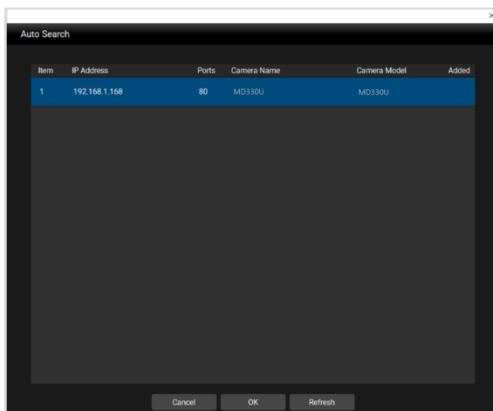
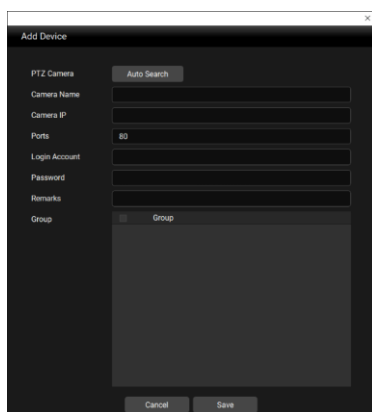

4. カメラをクリックし、カメラ ID とパスワードを入力して、カメラをデバイスリストに追加します(デフォルトの ID/パスワードは **admin/ admin** です)。**Go to Web** ボタンをクリックして、カメラの Web 管理画面にアクセスします

ライブビュー

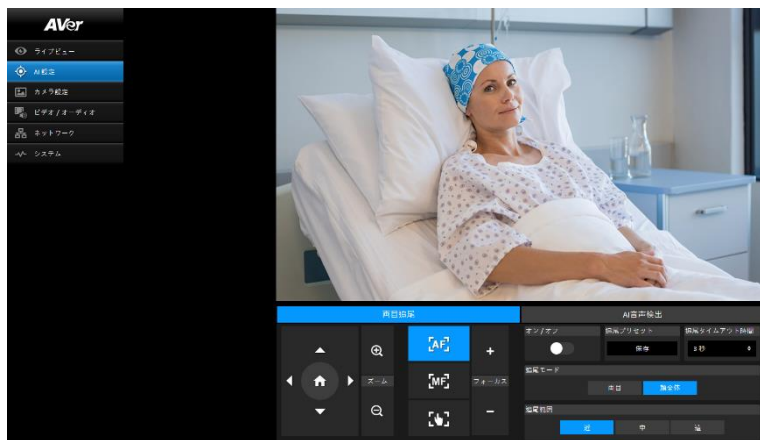

カメラ制御

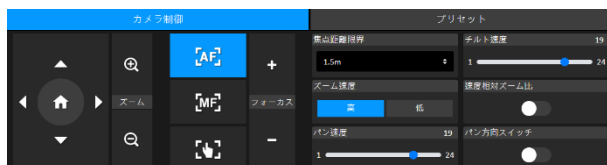

項目	説明
パンチルト制御	カメラの位置を合わせます。 <ul style="list-style-type: none"> ● スライダーを操作してパン速度とチルト速度を調整します。 ● パン方向を逆にする場合は、パン方向スイッチをオンにします。 ● ズーム比に合わせて自動的にパンとチルトの速度を調整する場合は、速度対ズーム比をオンにします。 次の OSD メニューでオンにすることもできます：カメラ > パンチルトズーム > 速度対ズーム比。
ホーム位置	カメラをホーム位置へ移動させます。
ズーム	ライブビューをズームインまたはズームアウトし、 ズーム速度 を選択します。
フォーカス	<ul style="list-style-type: none"> ● 自動フォーカス: クリックすると自動的に焦点を合わせます。 ● 手動フォーカス: クリックすると手動で焦点を合わせられます。 +- ボタンで焦点を調整します。 ● ワンプッシュフォーカス: 1回クリックするだけで自動的に焦点を合わせます。 ● 焦点距離限界: 最も近い焦点限界を設定します。

プリセット



項目	説明
プリセット保存	<ol style="list-style-type: none">パン、チルト、ズーム制御を使用して、カメラの位置を合わせます。プリセット保存欄でプリセット番号(0~255)を入力し、保存をクリックします。
プリセット位置を呼び出す	<ol style="list-style-type: none">プリセット位置を呼び出す欄でプリセット番号(0~255)を入力し、呼び出すをクリックします。または、クイックコール欄でプリセット番号(0~19)をクリックします。
プリセット精度	オンにすると、プリセットへ移行する精度が改善されます。
プリセット画像スイッチフリーズ	オンにすると、プリセットのライブビューのみが表示されます。移動中のライブビューは表示されません。
プリセット速度	プリセットへ移行する際のカメラ速度を調整します。

AI 設定

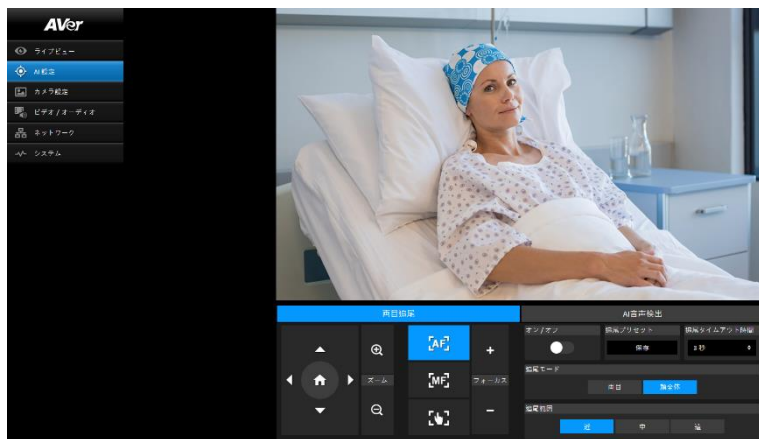

目追尾

追尾の最中にパン、チルト、ズームを手動で調整すると、追尾の機能がオフになります。



1. パン、チルト、ズーム制御を使用して、カメラの位置を合わせます。続いて、**保存**をクリックして**追尾プリセット**を保存します。初期値はホーム位置です。
2. **追尾タイムアウト時間**のドロップダウンリストから、視野に誰もいない状況でカメラが追尾プリセットへ戻るまでの間隔を選択します。初期値は3秒です。
3. **オン/オフ**をクリックすると、顔が映されている場合に目追尾をオンにできます。
 - 一人だけの場合:カメラは自動的に顔を追尾してズームします。
 - 複数の人が存在する場合:カメラはそれぞれの顔を四角で囲みます。顔を選択して四角をクリックすると、カメラは自動的に追尾してズームします。
4. **追尾モード**と**追尾範囲**を選択します。

(ベータ)AI 音声検出

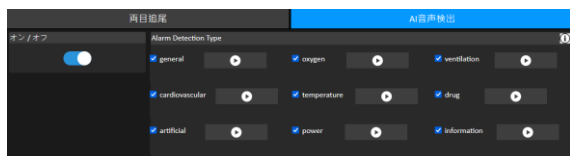

1. オンにすると、選択したアラームを検出します。
2. 再生ボタンをクリックするとアラーム音を確認できます。

カメラ設定

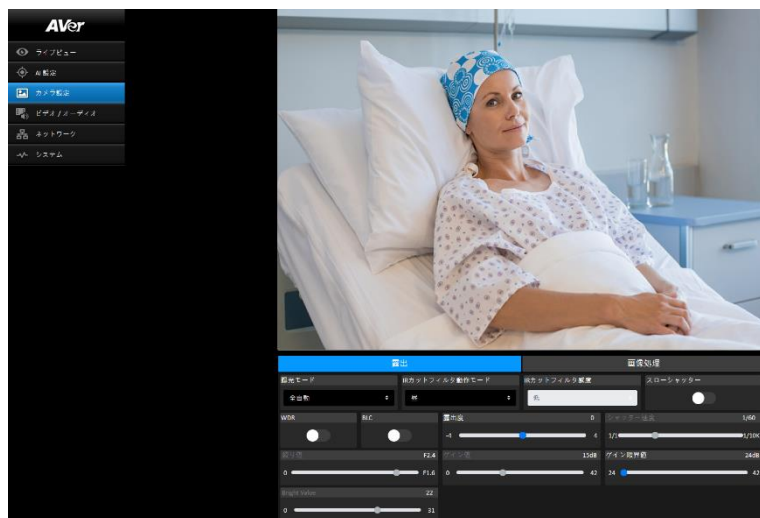

露出

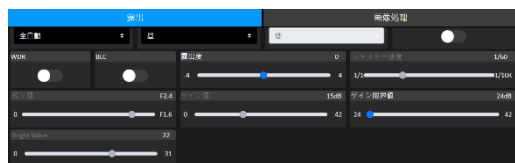

項目	説明
露光モード	露光モードを選択します。
WDR	WDR または BLC をオン/オフします。
BLC	
露出度	
シャッター速度	
絞り値	露出、シャッター、絞り、ゲインを調整します。
ゲイン値	
ゲイン限界値	
IR カットフィルタモード	昼モードまたは夜モードを選択して赤外線ナイトビジョンをオンまたはオフにします。または、自動モードを選択して、IR カットフィルタ感度を調整します。

画像処理

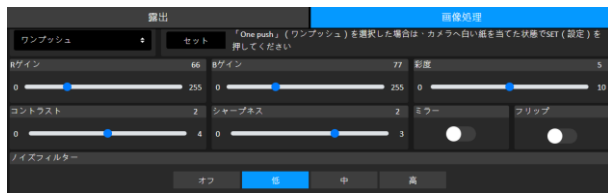

項目	説明
ホワイトバランス	<ul style="list-style-type: none"> ● ホワイトバランスモードを選択します。手動を選択すると、RゲインとBゲインを調整できます。 ● ワンプッシュを選択した場合、カメラのレンズ前に白色の紙を置き、セットをクリックしてホワイトバランスを校正します。
彩度	
コントラスト	彩度、コントラスト、シャープネスを調整します。
シャープネス	
ミラー	
フリップ	ミラー または フリップ をオン/オフします。
ノイズフィルター	ノイズフィルターのレベルを選択します。

ビデオ/オーディオ



ビデオ設定

項目	説明
電源周波数(Hz)	お住いの国や地域に基づき、 50Hz 、 59.94Hz 、 60Hz を選択します。
ビデオ出力解像度	ビデオ出力解像度を選択します。 RTSP: 最大 4K/60fps HDMI: 最大 4K 60Hz
イメージのテーマ	ビデオオーバーレイを選択して、UVC または HDMI 出力を優先させます。
ストリーム映像出力解像度	ライブビューのストリーム映像出力解像度を選択します。
フレームレート	フレームレートを選択します。
ビットレート	ビットレートを選択します。
I-VOP インターバル (S)	<ul style="list-style-type: none">● スライダーを操作して、ストリーム映像にI-VOP が出現する頻度を選択します。● I-VOP インターバルが短い場合は映像の画質が向上しますが、フレームサイズが大きくなります。
ビットレート制御	VBR または CBR を選択します。
エンコード形式	H.264 または H.265 を選択します。

音声設定

項目	説明
マイクロフォン音量	スライダーを操作してマイクロフォンの音量を調整します。
サンプリングレート	48K
エンコード形式	AAC

ネットワーク



項目	説明
ホスト名	ホスト名の初期値は AVer です。IP ルーターなどのデバイスに表示されるホスト名を変更できます。
DHCP	ネットワークを DHCP または固定 IP へ設定します。 <ul style="list-style-type: none">● DHCP: DHCP をオンにして確認をクリックし、設定を保存します。カメラに IP 設定が自動的に割り当てられます。● 固定 IP: DHCP をオフにし、IP アドレス、ネットマスク、ゲートウェイ、DNS を入力し、確認をクリックして設定を保存します。
RTMP 設定	YouTube などのビデオプラットフォームへライブビデオをストリーミングします。 <ol style="list-style-type: none">1. ビデオプラットフォームのサーバーURLとストリームキーを入力します。サーバーURLとストリームキーの取得方法については、プラットフォームの説明を参照してください。2. ストリーム開始をクリックしてストリーミングを開始し、中止をクリックしてストリーミングを中止します。

RTSP 設定	<p>VLC、PotPlayer、QuickTime などのメディアプレーヤーで認証ユーザーのみがアクセスできるようにし、ビデオストリームを保護します。</p> <ul style="list-style-type: none"> ● セキュリティをオフにした場合: <ol style="list-style-type: none"> 1. カメラの RTSP URL をメディアプレーヤーへ入力します。 2. RTSP URL : rtsp://[camera IP address]/live_st1 例: rtsp://192.168.1.100/live_st1 ● セキュリティをオンにした場合: <ol style="list-style-type: none"> 1. カメラの RTSP URL とユーザー名/パスワードをメディアプレーヤーへ入力します。 2. RTSP URL : rtsp://[username:password]@[camera IP address]/live_st1 例: rtsp://1:1@192.168.1.100/live_st1 3. ユーザー名/パスワード:カメラのユーザー名/パスワード(ウェブインターフェースのログイン情報)
HTTPS	<p>HTTPS を有効にすると、ブラウザとカメラの間で安全な接続を確立できます。カメラで HTTPS アクセスを有効にする場合:</p> <ol style="list-style-type: none"> 1. base-64 エンコード形式で暗号化と復号化を行うための SSL 認証を取得し、PKCS#8 形式(未暗号化)で秘密鍵を使用します。 2. 必要な認証コンテンツを PEM 形式へパッケージ化します。カメラへアップロードする SSL 認証は PEM 形式でなければなりません。 3. 開くをクリックして認証ファイルを選択し、アップロードをクリックします。 4. HTTPS をオンにし。

システム

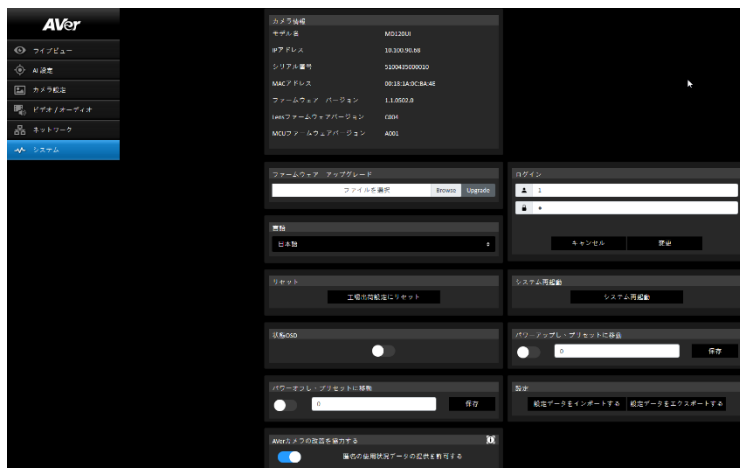

項目	説明
カメラ情報	カメラ情報を表示します。
ファームウェアアップグレード	以下の手順に従い、ファームウェアをアップグレードします： <ol style="list-style-type: none"> 1. AVer ダウンロードセンター (https://www.aver.com/download-center/) からファームウェアの最新バージョンをダウンロードします。 2. ウェブページにて、システム > ファームウェアアップグレード へ進みます。 3. 開くをクリックしてファームウェアを選択します。 4. アップグレードをクリックしてファームウェアのアップグレードを開始します。 5. アップグレードが完了したら、ブラウザをリフレッシュします。 <p>[注] ファームウェアアップグレードの最中は、カメラを電源に接続したままにしてください。アップグレード中にネットワーク接続が切断され、アップグレード後にカメラは再起動します。</p>
ログイン	ユーザー名/パスワードの初期値は admin/admin です。ユーザー名/パスワードを変更する場合は、ユーザー名/パスワードを入力して 変更 をクリックします。
言語	ウェブインターフェースの言語を変更します。
リセット	カメラを工場出荷設定へリセットします。
システム再起動	カメラを再起動します。

状態 OSD	有効にすると、プリセットの保存、呼び出し、キャンセルなどの実行中に HDMI 出力のプリセット状態が表示されます。
パワーアップし、プリセットに移動	<p>有効にすると、カメラは電源オンの後に指定された位置へ移動します。</p> <ul style="list-style-type: none"> ● トグルをクリックしてオン > プリセット番号を入力 > 保存をクリックします。 ● この機能を有効にする前に、プリセット番号の内容を指定してください。
パワーオフし、プリセットに移動	<p>有効にすると、カメラは電源オフの前に指定された位置へ移動します。</p> <ul style="list-style-type: none"> ● トグルをクリックしてオン > プリセット番号を入力 > 保存をクリックします。 ● この機能を有効にする前に、プリセット番号の内容を指定してください。
設定	カメラ設定をエクスポートまたはインポートします。
AVer カメラの改善を協力する	匿名での使用データ送信をオン/オフします。

AVerCamera Setting Tool

AVerCamera Setting Tool は AVer PTZ カメラの操作をサポートするアプリケーション ソフトウェアです。これによりリモコン操作ではなくソフトウェア上からビデオ、オーディオの設定や、USB 経由でカメラを出力できます。

- 弊社 Web サイトより AVerCamera Setting Tool をダウンロード・ご利用いただけます。
(<https://www.aver.com/Downloads/search?q=AVer%20Camera%20Setting%20Tool>).
- 設定の詳細については、CaptureShare のユーザーマニュアルのを<AVerCamera Setting Tool>章参照してください。

仕様

カメラ	
画像センサー	1/2.8" CMOS
有効画素数	8メガピクセル
出力解像度	解像度: 4K/1080p/720p フレームレート: 60/59.94/50/30/29.97/25
最小照度	0.5 lux (50 IRE、F1.6、最大 AGC、1/30)
S/N 比	≥ 50dB
ゲイン	自動、手動
TV 走査線	1000(中央/ワイド)
シャッター速度	1/1~1/10,000 秒
露出制御	自動、手動、優先 AE(シャッター、絞り)、BLC、WDR
ホワイトバランス	自動、手動
光学ズーム	20X
デジタルズーム	1X
合計ズーム	20X
視野角	DFOV: 69.2° (近)~4.1° (遠) HFOV: 62.3° (近)~3.6° (遠) VFOV: 37.3° (近)~2.1° (遠)
焦点距離	f = 4.5 mm(近)~90 mm(遠)
口径(絞り)	F = 1.8(近)~4.7(遠)
最小動作距離	近: 0.1 m、遠: 1.2 m
パン/チルト角度	パン: ±170°、チルト: +90° / -30°
パン/チルト速度(手動)	パン: 0.1° ~100° /秒、チルト: 0.1° ~100° /秒
プリセット速度	パン: 200° /秒、チルト: 200° /秒
プリセット位置	10 (IR)、256 (RS-232、RS-422、IP)
カメラ制御 - インターフェース	RS-232/RS-422/イーサネット
カメラ制御 - プロトコル	VISCA (RS-232/RS-422/IP)、CGI (IP)
画像処理	ミラー/フリップ/フリーズ/WDR/BLC
電源周波数	50 Hz、60 Hz
AI 機能	
モード	目追尾
プライバシー	
保護モード	プライバシーモード



一般	
電源電圧	12V
消費電力	24W
PoE	PoE+ (IEEE802.3at)
寸法(W x H x D)	180(W) x 145(D) x 183.5(H) mm
正味重量	1.7±0.1 kg
用途	室内
タリールンプ	あり
セキュリティ	Kensington ロック
赤外線操作リモコン	あり
動作条件	温度:0 ° C~+40 ° C 湿度:20%~80%
保管条件	温度:-20 ° C~+60 ° C 湿度:20%~95%
音声	
チャンネル	ステレオ 2 チャンネル
コーデック	AAC-LC (48K)
インターフェース	
ビデオ出力	HDMI、IP、USB
音声出力	HDMI、IP、USB
音声入力	なし
IP ストリーミング	
解像度	4K 60fps
ネットワーク映像圧縮形式	H.264、H.265、MJPEG
最大フレームレート	4K 60fps
ビットレート制御モード	VBR、CBR
ビットレート範囲	512Kbps~64Mbps
ネットワークインターフェース	10 / 100 / 1000 Base-T
マルチストリーム対応	2 (RTSP/ウェブページ)、最大:4K 60fps
ネットワークプロトコル	IPv6、IPv4、TCP、UDP、ARP、IMCP、IGMP、HTTP、DHCP RTP/RTCP、RTSP、RTMP、IP 経由の VISCA

USB	
コネクタ	USB3.0 (Type-B)
ビデオ形式	MJPEG
最大解像度	2160p
USB ビデオクラス(UVC)	UVC1.1
USB オーディオクラス(UAC)	UAC 1.0
ウェブ UI	
ライブビデオのプレビュー	あり
カメラ PTZ 制御	パン、チルト、ズーム、フォーカス、プリセット制御
カメラ/画像	露出、ホワイトバランス、画像処理
ネットワーク構成	DHCP、IP アドレス、ゲートウェイ、サブネットマスク、DNS
ソフトウェアツール	
IP 検索と構成ツール	Windows® 7 またはそれ以降をサポート
PTZ 管理	Windows® 7 またはそれ以降をサポート
PTZ コントロールパネル	iOS & iPadOS® 11 またはそれ以降をサポート
カメラ設定ツール	Windows® 7 またはそれ以降、macOS® 10.14 またはそれ以降をサポート

仕様は予告なく変更される場合があります。

トラブルシューティング

画像が歪んでいるか、ぼやけている。

- ウェブインターフェースで、ライブビュー > カメラ制御へ進み、 自動フォーカスをクリックします。
- リモコンで Menu  を 3 秒間長押し > 工場出荷設定 > オンを選択し、すべての設定を工場出荷設定へリセットします。

オンスクリーンディスプレイ(OSD)メニューを開く方法とは？

1. カメラとディスプレイ間に HDMI ケーブルを接続してください。
2. リモコンで Menu  を 3 秒間長押しすると、OSD メニューが表示されます。
3. OSD メニューがオンになると、LED インジケータが紫色に点灯します。

追加資料

VISCA RS-232 制御コマンドテーブル

Command Set	Command	Command Packet	Comments
Command Set	Command	Command Packet	Comments
IF_Clear	Broadcast	88 01 00 01 FF	I/F Clear (Clear Visca connection & command buffer queue)
CommandCancel	---	8x 2p FF	p: Socket No. (=1or2)
CAM_Power	On	8x 01 04 00 02 FF	Power OFF to Standby mode
	Off	8x 01 04 00 03 FF	Power ON supported in Standby mode only
CAM_Zoom	Stop	8x 01 04 07 00 FF	Zoom Control
	Tele(Standard)	8x 01 04 07 02 FF	
	Wide(Standard)	8x 01 04 07 03 FF	
	Tele(Variable)	8x 01 04 07 2p FF	p=0 (Low) to 7 (High)
	Wide(Variable)	8x 01 04 07 3p FF	
	Direct	8x 01 04 47 0p 0q 0r 0s FF	pqrs: Zoom Position. MD120UI: 0x00F0 (x1) ~ 0x5378 (x20)
CAM_Focus	Stop	8x 01 04 08 00 FF	Focus Control
	Far (Standard)	8x 01 04 08 02 FF	Each 'Far/Near' needs a 'stop'
	Near (Standard)	8x 01 04 08 03 FF	
	Far (Variable)	8x 01 04 08 2p FF	
	Near (Variable)	8x 01 04 08 3p FF	
	Auto Focus	8x 01 04 38 02 FF	AF ON/OFF
	Manual Focus	8x 01 04 38 03 FF	
	Auto/Manual	8x 01 04 38 10 FF	
	One Push	8x 01 04 18 01 FF	
	Direct	8x 01 04 48 0p 0q 0r 0s FF	pqrs: Focus Position, MD120UI: 0x0000(wide) ~ 0x4000(tele)
	Near Limit	8x 01 04 28 0p 0q 0r 0s FF	pqrs: Focus Near Limit Position 0001: 0.01m 0002: 1m 0003: 1.5m 0004: 2m 0005: 3m 0006: 6m

Command Set	Command	Command Packet	Comments
			0007: 10m
CAM_AFMode	Normal AF	8x 01 04 57 00 FF	Continuous AF ON
	Zoom Trigger AF	8x 01 04 57 02 FF	Continuous AF OFF, only trigger AF after PTZ done
CAM_WB	Auto	8x 01 04 35 00 FF	Normal Auto
	ATW	8x 01 04 35 04 FF	
	Indoor	8x 01 04 35 01 FF	
	Outdoor	8x 01 04 35 02 FF	
	One Push WB	8x 01 04 35 03 FF	One Push WB mode
	Manual	8x 01 04 35 05 FF	Manual Control mode
	One Push Trigger	8x 01 04 10 05 FF	One Push WB Trigger
CAM_RGain	Reset	8x 01 04 03 00 FF	Manual Control of R Gain
	Up	8x 01 04 03 02 FF	
	Down	8x 01 04 03 03 FF	
	Direct	8x 01 04 43 00 00 0p 0q FF	pq: R Gain
CAM_BGain	Reset	8x 01 04 04 00 FF	Manual Control of B Gain
	Up	8x 01 04 04 02 FF	
	Down	8x 01 04 04 03 FF	
	Direct	8x 01 04 44 00 00 0p 0q FF	pq: B Gain
CAM_AE	Full Auto	8x 01 04 39 00 FF	Automatic Exposure mode
	Manual	8x 01 04 39 03 FF	Manual Control mode
	Shutter Priority	8x 01 04 39 0A FF	Shutter Priority Automatic Exposure mode
	Iris Priority	8x 01 04 39 0B FF	Iris Priority Automatic Exposure mode
CAM_SlowShutter	Auto	8x 01 04 5A 02 FF	Auto Slow Shutter ON/OFF
	Manual	8x 01 04 5A 03 FF	
CAM_Shutter	Reset	8x 01 04 0A 00 FF	Shutter Setting
	Up	8x 01 04 0A 02 FF	
	Down	8x 01 04 0A 03 FF	
	Direct	8x 01 04 4A 00 00 0p 0q FF	pq: Shutter Position
CAM_Iris	Reset	8x 01 04 0B 00 FF	Iris Setting

Command Set	Command	Command Packet	Comments
	Up	8x 01 04 0B 02 FF	
	Down	8x 01 04 0B 03 FF	
	Direct	8x 01 04 4B 00 00 0p 0q FF	pq: Iris Position
CAM_Gain	Reset	8x 01 04 0C 00 FF	Gain Setting
	Up	8x 01 04 0C 02 FF	
	Down	8x 01 04 0C 03 FF	
	Direct	8x 01 04 4C 00 00 0p 0q FF	pq: Gain Position
	AE Gain Limit	8x 01 04 2C 0p FF	p: Gain Position (8 to E: 24db~42db)
CAM_Bright	Up	8x 01 04 0D 02 FF	---
	Down	8x 01 04 0D 03 FF	
	Direct	8x 01 04 4D 00 00 0p 0q FF	pq: Bright Position
CAM_ExpComp	Reset	8x 01 04 0E 00 FF	Exposure Comp Amount Setting
	Up	8x 01 04 0E 02 FF	
	Down	8x 01 04 0E 03 FF	
	Direct	8x 01 04 4E 00 00 0p 0q FF	pq: ExpComp Position
CAM_Backlight	On	8x 01 04 33 02 FF	Back Light Compensation ON/OFF
	Off	8x 01 04 33 03 FF	
CAM_LR_Reverse	On	8x 01 04 61 02 FF	Mirror Image ON/OFF
	Off	8x 01 04 61 03 FF	
CAM_Flip	On	8x 01 04 66 02 FF	Flip ON/OFF
	Off	8x 01 04 66 03 FF	
CAM_Preset	Reset	8x 01 04 3F 00 pp FF	Preset Cancel. pp: Preset Number 0x00~0xFF
	Set	8x 01 04 3F 01 pp FF	Preset Save.
	Recall	8x 01 04 3F 02 pp FF	Preset Load.
CAM_Menu	On	8x 01 06 06 02 FF	Menu Display ON/OFF
	Off	8x 01 06 06 03 FF	
	On/Off	8x 01 06 06 10 FF	
CAM_MenuEnter	---	8x 01 7E 01 02 00 01 FF	Enter Submenu
CAM_NR	---	8x 01 04 53 0p FF	p: Image NR Setting (0:OFF, Level1 to 3)

Command Set	Command	Command Packet	Comments
CAM_WDR	On	8x 01 04 3D 02 FF	Wdr ON/OFF
	Off	8x 01 04 3D 03 FF	
CAM_ICR	On	8x 01 04 01 02 FF	Infrared Mode ON (Night)
	Off	8x 01 04 01 03 FF	Infrared Mode OFF (Day)
CAM_AutoICR	On	8x 01 04 51 02 FF	Auto Infrared mode ON/OFF
	Off	8x 01 04 51 03 FF	
	Threshold	8x 01 04 21 00 00 0p 0q FF	
CAM_IDWrite	--	8x 01 04 22 0p 0q 0r 0s FF	pqrs: Camera ID (=0000 to FFFF)
Video Format Change	--	8x 01 7E 01 1E 0p 0q FF	pq
			0x02: 1920x1080P/60
			0x03: 1920x1080P/59.94
			0x04: 1920x1080P/30
			0x05: 1920x1080P/29.97
			0x08: 1920x1080I/60
			0x0A: 1920x1080I/59.94
			0x0B: 1280x720P/60
			0x0C: 1280x720P/59.94
			0x0D: 1920x1080P/50
			0x18: 1920x1080P/25
			0x22: 1920x1080I/50
			0x26: 1280x720P/50
			0x30: 3840x2160P/60
			0x31: 3840x2160P/59.94
			0x32: 3840x2160P/50
0x33: 3840x2160P/30			
0x34: 3840x2160P/29.97			
0x35: 3840x2160P/25			
IR_Receive	On	8x 01 06 08 02 FF	Infrared remote commander reception ON
Pan-tilt Drive	Up	8x 01 06 01 VV WW 03 01 FF	VV: Pan speed setting 0x01 (low speed) to 0x18 (high speed)
	Down	8x 01 06 01 VV WW 03 02	WW: Tilt speed setting 0x01 (low speed) to 0x18

Command Set	Command	Command Packet	Comments
		FF	(high speed)
	Left	8x 01 06 01 VV WW 01 03 FF	YYYY: Pan Position 7FFF(170°) to 8000(-170°)
	Right	8x 01 06 01 VV WW 02 03 FF	(Normalized, CENTER 0000)
	UpLeft	8x 01 06 01 VV WW 01 01 FF	ZZZZ: Tilt Position 7FFF(90°) to 8000(-30°)
	UpRight	8x 01 06 01 VV WW 02 01 FF	(Image Flip: OFF) (Normalized, CENTER 0000)
	DownLeft	8x 01 06 01 VV WW 01 02 FF	
	DownRight	8x 01 06 01 VV WW 02 02 FF	
	Stop	8x 01 06 01 VV WW 03 03 FF	
	AbsolutePosition	8x 01 06 02 VV WW 0Y 0Y 0Y 0Y 0Z 0Z 0Z 0Z FF	
	RelativePosition	8x 01 06 03 VV WW 0Y 0Y 0Y 0Y 0Z 0Z 0Z 0Z FF	
	Home	8x 01 06 04 FF	
	Reset	8x 01 06 05 FF	
Freeze	Freeze On	8x 01 04 62 02 FF	Freeze On Immediately
	Freeze Off	8x 01 04 62 03 FF	Freeze Off Immediately
	Preset Freeze On	8x 01 04 62 22 FF	Freeze On When Running Preset
	Preset Freeze Off	8x 01 04 62 23 FF	Freeze Off When Running Preset
RTMP	On	8x 01 04 A2 02 FF	RTMP ON/OFF
	Off	8x 01 04 A2 03 FF	
Reboot	On	8x 01 04 A4 FF	System reboot
P/T Spd. Relative Zoom Ratio	On	8x 01 04 A6 02 FF	P/T Speed Relative Zoom Ratio ON/OFF
	Off	8x 01 04 A6 03 FF	
Factory Reset	System Factory Reset	8x 01 04 3F 03 00 FF	
Preset Speed	Set Preset Speed	8x 01 06 20 0p FF	p=1 (Low) to 6 (High)

Inquiry Command	Command Packet	Inquiry Packet	Comments
Inquiry Command	Command Packet	Inquiry Packet	Comments
CAM_PowerInq	8x 09 04 00 FF	y0 50 02 FF	On
		y0 50 02 FF	Off
CAM_ZoomPosInq	8x 09 04 47 FF	y0 50 0p 0q 0r 0s FF	pqrs: Zoom Position
CAM_FocusModeInq	8x 09 04 38 FF	y0 50 02 FF	Auto Focus
		y0 50 03 FF	Manual Focus
CAM_FocusPosInq	8x 09 04 48 FF	y0 50 0p 0q 0r 0s FF	pqrs: Focus Position
CAM_FocusNearLimitInq	8x 09 04 28 FF	y0 50 0p 0q 0r 0s FF	pqrs: Focus Near Limit Position
CAM_AFModeInq	8x 09 04 57 FF	y0 50 00 FF	Continuous AF ON
		y0 50 02 FF	Continuous AF OFF, only trigger AF after PTZ done
CAM_WBModeInq	8x 09 04 35 FF	y0 55 00 FF	Auto
		y0 55 04 FF	ATW
		y0 55 01 FF	Indoor
		y0 55 02 FF	Outdoor
		y0 55 03 FF	One Push WB
		y0 55 05 FF	Manual
CAM_RGainInq	8x 09 04 43 FF	y0 50 00 00 0p 0q FF	pq: R Gain
CAM_BGainInq	8x 09 04 44 FF	y0 50 00 00 0p 0q FF	pq: B Gain
CAM_AEModeInq	8x 09 04 39 FF	y0 50 00 FF	Full Auto
		y0 50 03 FF	Manual
		y0 50 0A FF	Shutter Priority
		y0 50 0B FF	Iris Priority
		y0 50 0D FF	Bright
CAM_SlowShutterModeInq	8x 09 04 5A FF	y0 50 02 FF	Auto
		y0 50 03 FF	Manual
CAM_ShutterPosInq	8x 09 04 4A FF	y0 50 00 00 0p 0q FF	pq: Shutter Position
CAM_IrisPosInq	8x 09 04 4B FF	y0 50 00 00 0p 0q FF	pq: Iris Position
CAM_GainPosInq	8x 09 04 4C FF	y0 50 00 00 0p 0q FF	pq: Gain Position
CAM_GainLimitInq	8x 09 04 2C FF	y0 50 0q FF	p: Gain Limit
CAM_BrightPosInq	8x 09 04 4D FF	y0 50 00 00 0p 0q FF	pq: Bright Position

Inquiry Command	Command Packet	Inquiry Packet	Comments
CAM_ExpCompPosInq	8x 09 04 4E FF	y0 50 00 00 0p 0q FF	pq: ExpComp Position
CAM_BacklightModeInq	8x 09 04 33 FF	y0 50 02 FF	On
		y0 50 03 FF	Off
CAM_LR_Reverse_Inq	8x 09 04 61 FF	y0 50 02 FF	On
		y0 50 03 FF	Off
CAM_Flip_Inq	8x 09 04 66 FF	y0 50 02 FF	On
		y0 50 03 FF	Off
CAM_NRInq	8x 09 04 53 FF	y0 50 0p FF	p: NR Level
CAM_WDRInq	8x 09 04 3D FF	y0 50 02 FF	On
		y0 50 03 FF	Off
CAM_ICRModeInq	8x 09 04 01 FF	y0 50 02 FF	On (Night)
		y0 50 03 FF	Off (Day)
CAM_AutoICRModeInq	8x 09 04 51 FF	y0 50 02 FF	On
		y0 50 03 FF	Off
CAM_AutoICRThresho ldInq	8x 09 04 21 FF	y0 50 00 00 0p 0q FF	pq: ICR OFF(Day)->ON(Night) threshold level 00: Low; 01: Middle; 02: High
CAM_IDInq	8x 09 04 22 FF	y0 50 0p 0q 0r 0s FF	pqrs: Camera ID
CAM_VersionInq	8x 09 00 02 FF	y0 50 ab cd mn pq rs tu vw FF	abcd: Vendor Code, AVer: 2574 mnpq: Model Code, MD120U: 0565 rstu: Firmware version (ex: 4025 for 1.1.4025.0) vw: Socket Number (=02)
CAM_MenuModeInq	8x 09 06 06 FF	y0 50 02 FF	On
		y0 50 03 FF	Off
Video Format Inq	8x 09 06 23 FF	y0 50 02 FF	1920x1080P/60
		y0 50 03 FF	1920x1080P/59.94
		y0 50 04 FF	1920x1080P/30
		y0 50 05 FF	1920x1080P/29.97
		y0 50 08 FF	1920x1080I/60
		y0 50 0A FF	1920x1080I/59.94
		y0 50 0B FF	1280x720P/60
		y0 50 0C FF	1280x720P/59.94
		y0 50 0D FF	1920x1080P/50
		y0 50 18 FF	1920x1080P/25

Inquiry Command	Command Packet	Inquiry Packet	Comments
		y0 50 22 FF	1920x1080I/50
		y0 50 26 FF	1280x720P/50
		y0 50 30 FF	3840x2160P/60
		y0 50 31 FF	3840x2160P/59.94
		y0 50 32 FF	3840x2160P/50
		y0 50 33 FF	3840x2160P/30
		y0 50 34 FF	3840x2160P/29.97
		y0 50 35 FF	3840x2160P/25
IR_Receive	8x 09 06 08 FF	y0 50 02 FF	On
		y0 50 03 FF	Off
Pan-tiltPosInq	8x 09 06 12 FF	y0 50 0Y 0Y 0Y 0Y 0Z 0Z 0Z 0Z FF	YYYY: Pan Position 7FFF(170°) to 8000 (-170°) (Normalized, CENTER 0000) ZZZZ: Tilt Position 7FFF(90°) to 8000(-30°) (Image Flip: OFF) (Normalized, CENTER 0000)
CAM_Preset_Inq	8x 09 04 3F FF	y0 50 pp FF	Return the last preset number which has been operated pp:01-FF
Pan-tiltMaxSpeedInq	8x 09 06 11 FF	y0 50 ww zz FF	ww = Pan Max Speed zz = Tilt Max Speed
Freeze_Mode_Inq	8x 09 04 62 01 FF	y0 50 02 FF	On
		y0 50 03 FF	Off
Preset_Freeze_Inq	8x 09 04 62 02 FF	y0 50 02 FF	On
		y0 50 03 FF	Off
RTMP_Inq	8x 09 04 A2 FF	y0 50 02 FF	On
		y0 50 03 FF	Off
Preset_Speed_Inq	8x 09 06 20 FF	y0 50 0p FF	p=1 (Low) to 6 (High)
Firmware version	8x 09 36 69 04 FF	y0 50 0p 0q 0r 0s 0t 0u 0v 0w FF	fw_ver: p.q.rstu.vw

VISCA over IP 設定

PORT

Internet protocol	IPv4
Transport protocol	UDP
Port address	52381

FORMAT

	byte 0	byte 1	byte 2	byte 3	byte 4	byte 5	byte 6	byte 7	byte 8 ~~~ byte 23	
func	Payload type		Payload Length		Sequence number				Payload (1 to 16 bytes)	
data	Value1	Value2	1~16(0x0001~0x0010)		0x00000000 ~ 0xFFFFFFFF				VISCA Packet (see page VISCA)	

Payload type

Name	Value1	Value2	Description
VISCA command	0x01	0x00	Stores the VISCA command.
VISCA inquiry	0x01	0x10	Stores the VISCA inquiry.
VISCA reply	0x01	0x11	Stores the reply for the VISCA command and VISCA inquiry, or VISCA device setting command
VISCA device setting command	0x01	0x20	Stores the VISCA device setting command.
Control command	0x02	0x00	Stores the control command
Control reply	0x02	0x01	Stores the reply for the control command.

CGI コマンドリスト

CGI List for Video Transmission					
CGI item name	URL	Command	Parameter Name	Parameter value	Description
Get JPEG	/snapshot				1280x720 jpg
Get 4K JPEG	/cgi-bin?OnePush=n				Step 1: request 4k snapshot
	/snapshot?res=4k				Step 2: get 3840x2160 jpg
Get RTSP stream	rtsp://ip/live_st1				

CGI List for Audio					
CGI item name	URL	Command	Parameter Name	Parameter value	Description
Audio In Volume	/cgi-bin?Set=	ado_vol,3,N		0 ~10	0 ~ 10 volume

CGI List for Camera Control					
CGI item name	URL	Command	Parameter Name	Parameter value	Description
up start	/cgi-bin?SetPtfz=	1,0,1			
up end	/cgi-bin?SetPtfz=	1,0,2			
down start	/cgi-bin?SetPtfz=	1,1,1			
down end	/cgi-bin?SetPtfz=	1,1,2			
left start	/cgi-bin?SetPtfz=	0,1,1			
left end	/cgi-bin?SetPtfz=	0,1,2			
right start	/cgi-bin?SetPtfz=	0,0,1			
right end	/cgi-bin?SetPtfz=	0,0,2			
zoom_in start	/cgi-bin?SetPtfz=	2,0,1			
zoom_in end	/cgi-bin?SetPtfz=	2,0,2			
zoom_out start	/cgi-bin?SetPtfz=	2,1,1			
zoom_out end	/cgi-bin?SetPtfz=	2,1,2			
set preset:	/cgi-bin?ActPreset=	1,N			N : position
load preset:	/cgi-bin?ActPreset=	0,N			N : position

CGI List for Various Settings					
CGI item name	URL	Command	Parameter Name	Parameter value	Description
exposure value	/cgi-bin?Set=	img_expo_expo,3,N	value	1 ~ 9	N : value
saturation	/cgi-bin?Set=	img_saturation,3,N	value	0 ~ 10	N : value
contrast	/cgi-bin?Set=	img_contrast,3,N	value	0 ~ 4	N : value

Tracking on:	/cgi-bin?Set=	trk_tracking_on,3,1			
Tracking off:	/cgi-bin?Set=	trk_tracking_on,3,0			
Reboot	GET(Basic Authentication)	/cgi-bin?OnePush=!			
Factory Reset	GET(Basic Authentication)	/cgi-bin?OnePush=d			
RTMP Start streaming	/cgi-bin?Set=	vdo_rtmp_enable,3,1			
RTMP Stop streaming	/cgi-bin?Set=	vdo_rtmp_enable,3,0			
Status get (Model name & mac & FW_VER)	/cgi-bin?GetString=	sys_name&net_mac&sys_fw_version		http://10.100.105.110/cgi-bin?GetString=sys_name&net_mac&sys_fw_version	
Serial No. get	/cgi-bin?GetSerialNumber			http://10.100.105.110/cgi-bin?GetSerialNumber	
oneclick	/cgi-bin?Set=	ptz_oneclick_x,3,N1&ptz_oneclick_y,3,N2&ptz_one_click_spd,3,N3		ptz_one_click_spd 1~24	N1, N2 = X, Y coordinates (1080P, 0,0 at top left) N3=moving speed
IR Cut Filter	/cgi-bin?Set=	img_ircut_filter,3,N		0 ~ 2	0 = Day, 1 = Night, 2 = Auto
IR Cut Filter Sensitivity	/cgi-bin?Set=	img_ircut_sensitivity,3,N		0 ~ 2	0 = Low, 1 = Middle, 2 = High

CGI List for AI Settings					
CGI item name	URL	Command	Parameter Name	Parameter value	Description
Eyes Tracking On/Off	/cgi-bin?Set=	trk_tracking_on,3,N	value	0 / 1	0: OFF; 1: ON
Tracking Preset	/cgi-bin?ActPreset=1,255				Save current pos. for eye tracking preset point.
Timeout to preset	/cgi-bin?Set=	trk_lost_time,3, N	value	3 / 5 / 7 / 10	timeout in seconds
Tracking Site	/cgi-bin?Set=	trk_mode,3,N	value	0 / 1	0: Full face; 1: Eyes
Tracking Range	/cgi-bin?Set=	trk_sensitivity,3,N	value	0 ~ 2	0: Close; 1: Medium; 2: Wide
Eyes Tracking On/Off Get	/cgi-bin?Get=trk_tracking_on				
	- Reply	On trk_tracking_on=1 Off trk_tracking_on=0			

Audio Detection On/Off	/cgi-bin?Set=	ado_det_alarm,3,N	value	0 / 1	0: OFF; 1: ON
Alarm Detection Type	/cgi-bin?Set=	ado_alm_general,3,N	value	0 / 1	general type. 0: OFF; 1: ON
		ado_alm_oxygen,3,N	value	0 / 1	oxygen type. 0: OFF; 1: ON
		ado_alm_ventilation,3,N	value	0 / 1	ventilation type. 0: OFF; 1: ON
		ado_alm_cardiovascular,3,N	value	0 / 1	cardiovascular type. 0: OFF; 1: ON
		ado_alm_temperature,3,N	value	0 / 1	temperature type. 0: OFF; 1: ON
		ado_alm_drug,3,N	value	0 / 1	drug type. 0: OFF; 1: ON
		ado_alm_artificial,3,N	value	0 / 1	artificial type. 0: OFF; 1: ON
		ado_alm_power,3,N	value	0 / 1	power type. 0: OFF; 1: ON
		ado_alm_information,3,N	value	0 / 1	information type. 0: OFF; 1: ON

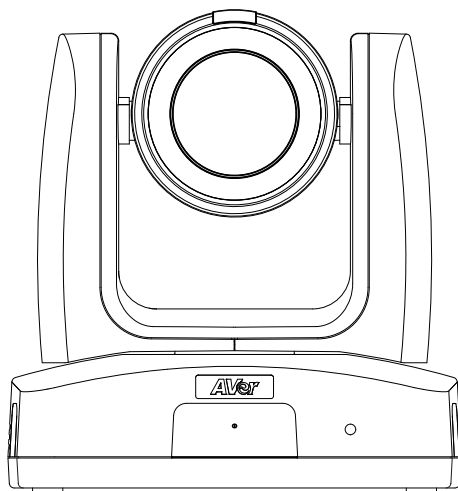

MD120UI Tracking-Kamera

Bedienungsanleitung













Wie man reinigt und desinfiziert

Warnung Verletzungsgefahr	Verwenden Sie keine Reinigungsmittel, die Phenol enthalten, da Phenol bei unzureichendem Spülen Hautverbrennungen verursachen und nicht ausreichend reinigende oder desinfizierende Eigenschaften aufweisen kann.
Achtung	<ol style="list-style-type: none">1. Die Kamera wurde für eine einfache Reinigung und Desinfektion konzipiert.2. Trennen Sie vor der Reinigung die Kamera von der Stromquelle.3. Reinigungsverfahren sollten nur von Personal durchgeführt werden, das mit dem Kamera-Betrieb vertraut ist.4. Sprühen Sie keine Reinigungsflüssigkeit, insbesondere kein Wasser, in interne elektrische Geräte oder Teile der Kamera, um mögliche Kurzschlüsse, Korrosionen, Fehlfunktionen und elektrische Schockgefahren für Benutzer oder Servicepersonal zu vermeiden.5. Korrosive Reinigungsmittel können die Kamera verfärben oder beschädigen. Testen Sie vor der Verwendung eines Reinigungsmittels dieses an einer unauffälligen Stelle.
Wenn	Reinigen Sie die Kamera vor und nach Gebrauch.
Schritte	<ol style="list-style-type: none">1. Trennen Sie die Kamera von der Stromquelle.2. Reinigungspersonal muss Reinigungshandschuhe tragen.3. Stellen Sie sicher, dass das Reinigungsalkohol nicht abgelaufen ist, bevor Sie es verwenden.4. Verwenden Sie ein mit Reinigungsalkohol (75 %) angefeuchtetes Reinigungstuch.5. Wischen Sie alle Oberflächen ab, die mit der Kamera in Kontakt kommen können.6. Vermeiden Sie nach dem Wischen des Geräts den Kontakt mit bloßen Händen.
Häufigkeit	Es ist keine regelmäßige Reinigung erforderlich. Reinigen Sie vor und nach Gebrauch.

Symbole auf dem Produkt

Die Symbole auf diesem Produkt und dem Zubehör haben folgende Bedeutung.

	<p>Das WEEE-Symbol. Dieses Symbol weist darauf, dass dieses Produkt nicht im Hausmüll entsorgt werden darf. Geben Sie das Produkt an einer zugelassenen Sammelstelle für die Entsorgung von elektrischen und elektronischen Geräten ab. Weitere Informationen zur Entsorgung des Gerätes für das Recycling erfragen Sie bitte bei der zuständigen Stelle in Ihrer Gemeinde oder in dem Geschäft, in dem Sie das Gerät erworben haben.</p>
	<p>Das CE-Logo. Dieses Logo weist darauf hin, dass das Produkt die einschlägigen Vorschriften/Normen zur harmonisierten Rechtsprechung in der Europäischen Union erfüllt.</p>
	<p>Das FCC-Logo. Dieses Logo weist darauf hin, dass das Produkt die Compliance-Normen der Federal Communications Commission erfüllt.</p>
	<p>Das UKCA (UK Conformity Assessed) Symbol. Dieses Logo weist darauf hin, dass das ein Produkt, das auf den Märkten des Vereinigten Königreichs in Verkehr gebracht wird, die UKCA Marking-Anforderungen erfüllt.</p>
	<p>Das RCM Konformität-Logo. Dieses Logo weist darauf hin, dass das Produkt die einschlägigen australischen RCM-Vorschriften erfüllt.</p>
	<p>Das Logo informiert die BenutzerInnen auf das Vorhandensein von „gefährlicher Stromspannung“ im Inneren des Produkts und auf die Gefahr eines elektrischen Schlages.</p>
	<p>Dieses Logo ist ein Warnzeichen, das die BenutzerInnen auf die dem Produkte beigefügten Betriebs- und Wartungsanleitungen (Instandhaltung) aufmerksam macht.</p>
	<p>Das China RoHS-Symbol. Dieses Symbol weist auf die Anzahl der Jahre hin, während welchen bei normaler Nutzung keine gefährlichen Substanzen aus dem Produkt austreten oder von diesem ausgehen.</p>
	<p>Das Wechselstromsymbol. Dieses Symbol weist darauf hin, dass das Produkt (die Eingänge/Ausgänge) mit Wechselstrombetrieben wird.</p>
	<p>Das Gleichstromsymbol. Dieses Symbol weist darauf hin, dass das Produkt (die Eingänge/Ausgänge) für die Verwendung mit Gleichstrom ausgelegt ist.</p>

Warnung

Dies ist ein Produkt der Klasse A. In Wohnumgebungen kann dieses Produkt Funkstörungen verursachen. In diesem Fall obliegt es dem Anwender, angemessene Maßnahmen zu ergreifen.

Fernbedienung Sicherheitshinweise für die Batterien

- Lagern Sie die Batterien an einem kühlen und trockenen Platz.
- Werfen Sie gebrauchte Batterien nicht in den Hausmüll. Beseitigen Sie die Batterien an den ausgewiesenen Sammelstellen oder bringen Sie sie gegebenenfalls in den Laden zurück.
- Entfernen Sie die Batterien aus dem Gehäuse, falls Sie die Fernbedienung längere Zeit nicht benutzen. Auslaufende Batterien und Korrosion können die Fernbedienung beschädigen, achten Sie auf sichere Entsorgung.
- Verwenden Sie keine alten und neuen Batterien gleichzeitig.
- Verwenden Sie keine unterschiedlichen Typen gemeinsam: Alkali, Normal (Kohle-Zink) oder wiederaufladbare (Nickel-Cadmium).
- Werfen Sie gebrauchte Batterien nicht ins Feuer.
- Versuche Sie nicht die Batterien kurzzuschließen.

HAFTUNGSAUSSCHLUSS:

Zusicherungen und Gewährleistungen, weder ausdrücklich noch angenommen, hinsichtlich des Inhalts dieser Dokumentation, der Qualität, Leistung, Marktgängigkeit oder Eignung für einen bestimmten Zweck. Die Informationen in dieser Anleitung wurden sorgfältig auf ihre Gültigkeit hin überprüft, allerdings übernehmen wir keine Verantwortung für Ungenauigkeiten. Die Informationen in diesem Dokument können sich, ohne dass darauf hingewiesen wird, ändern.

AVer haftet unter keinem Umständen für Schäden, inklusive Schäden durch Gewinnverlust, oder andere beiläufig entstandene oder kausal bedingte Schäden, die im Zusammenhang mit der Nutzung oder Unmöglichkeit der Nutzung der Software oder der schriftlichen Unterlagen entstehen, selbst wenn über die Möglichkeit solcher Schäden informiert wurde.

WARENZEICHEN

„AVer“ ist ein Warenzeichen von AVer Information Inc. Andere in diesem Dokument genannten Warenzeichen dienen lediglich der Information und sind Eigentum der entsprechenden Unternehmen.

URHEBERRECHT

© 2023 by AVer Information Inc. Alle Rechte vorbehalten. | 6. Juli 2023

Kein Teil dieser Publikation darf in jedweder Form und durch jedwede Mittel ohne schriftliche Genehmigung von AVer Information Inc. reproduziert, übertragen, umgesetzt, in Abrufsystemen gespeichert oder in jegliche Sprachen übersetzt werden.

Mehr Hilfe

Für FAQs, technische Unterstützung, Software und für den Download der Bedienungsanleitung besuchen Sie bitte:

Download Center: <https://www.avereurope.com/download-center>

Technischer Support: <https://www.avereurope.com/technical-support>

Kontaktinformationen

AVer Information Europe B.V.

<https://www.avereurope.com>

Westblaak 134, 3012KM, Rotterdam, The Netherlands

Tel: +31 (0) 10 7600 550

Technischer support: eu.rma@aver.com

Inhaltsverzeichnis

Wie man reinigt und desinfiziert.....	1
Übersicht	1
Lieferumfang	1
Optionales Zubehör	1
Maße.....	2
Deckenmontage	3
Wandmontage	4
Schwenk- und Neigungswinkel	4
Installation.....	5
Kabelbefestigungsplatte	5
Deckenmontage	6
Verbindung.....	7
Aufnahme-LED.....	7
LED Anzeige	7
Geräteanschlüsse	8
Fernbedienung.....	11
Verknüpfungen	12
Kameraeinrichtung	13
Bildschirmmenü	13
IP-Adresse einrichten.....	13
OSD Menüstruktur	15
Webeinrichtung	18
Zugriff auf die Webschnittstelle der Kamera.....	18
Live Ansicht (Live View)	21
KI-Einstellungen (AI Setting)	23
Kameraeinstellungen (Camera Settings)	25
Video und Audio (Video & Audio)	27

Netzwerk (Network).....	28
System (System).....	30
AVerCamera Setting Tool	32
Specification	33
Fehlerbehebung.....	36
Anhang	37
VISCA RS-232 Befehlstabelle.....	37
VISCA Over-IP-Einstellungen	45
CGI-Befehl	46

Übersicht

Die MD120UI Tracking-Kamera ist eine für medizinische Anwendungen klassifizierte Kamera zum Tracking von Patienten. Die Kamera ist mit Infrarot-Nachtsicht ausgestattet und hat ein UV-resistentes Gehäuse.

Lieferumfang

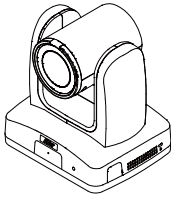

Kamera

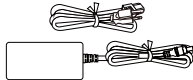

Netzadapter
und Netzkabel

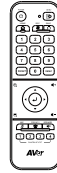

Fernbedienung

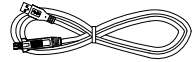

USB 3.0
Typ-B-zu-Typ-A-
Kabel (1,5 m)

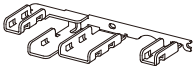

Kabelbefestigung-
splatte

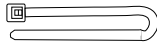

Kabelbinder (x4)

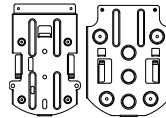

Deckenmontagege-
hörung (x2)

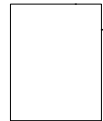

Bohrschablone



M2 x 4mm
Schrauben (x3)



M3 x 6mm
Schrauben (x3)



1/4"-20 L=6.5mm
Schrauben (2x)

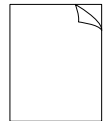

Kurzanleitung

Optionales Zubehör

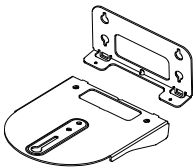

Wandmontage-
halterung

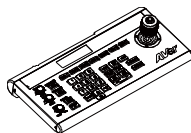

Kamera-Controller
(CL01)

Maße

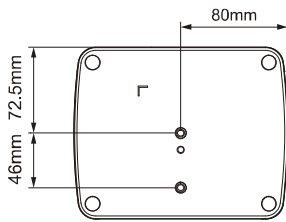
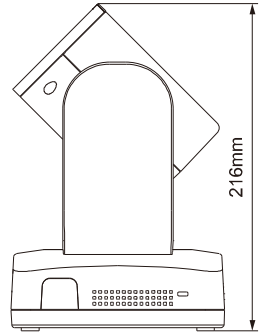
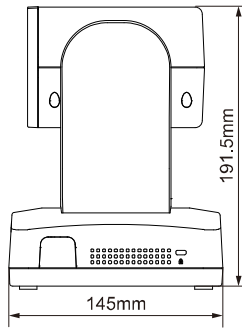
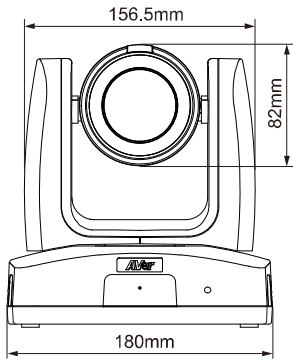

Deckenmontage

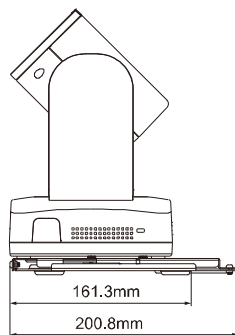
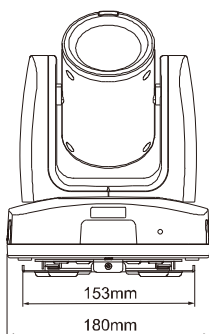
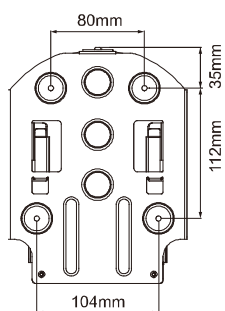
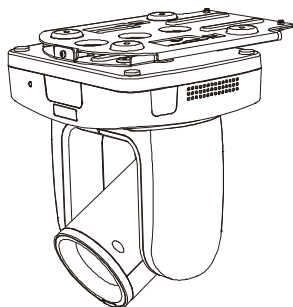

Wandmontage

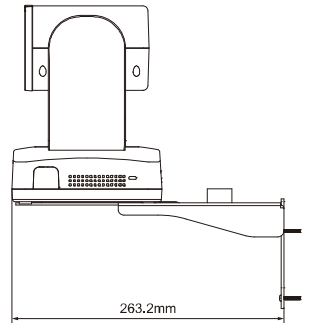
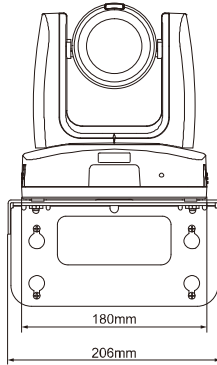
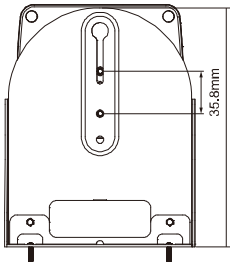
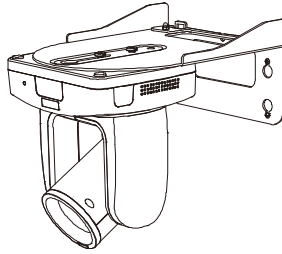
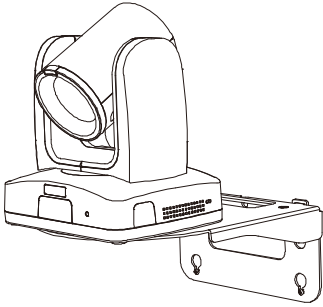

Schwenk- und Neigungswinkel

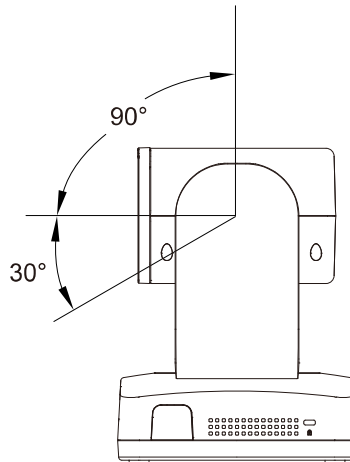
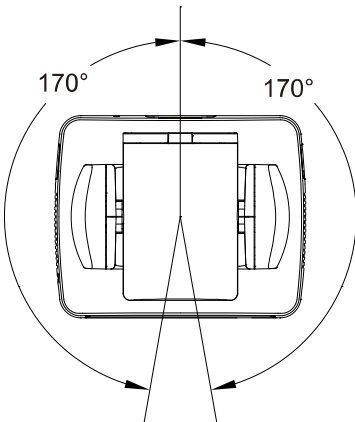

Installation

Kabelbefestigungsplatte

1. Befestigen Sie die Kabelbefestigungsplatte mit den mitgelieferten M2 x 4 mm Schrauben.

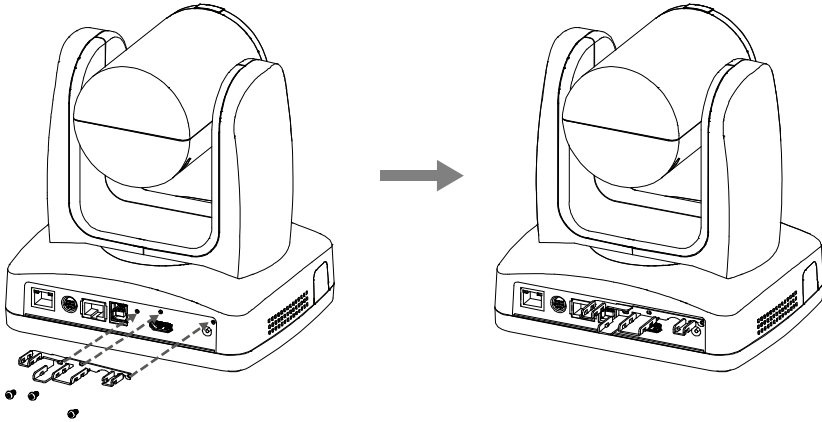

2. Stecken Sie die Kabel ein.

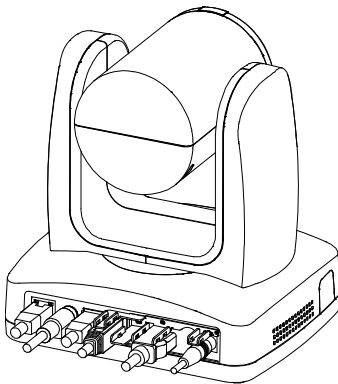

3. Fixieren Sie die Kabel mit Kabelbindern durch die Schlitz an der Kabelbefestigungsplatte.

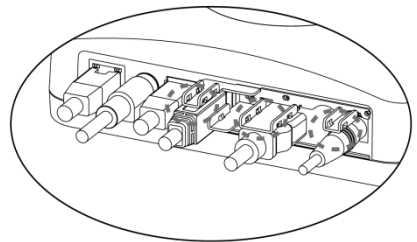

Deckenmontage

1. Befestigen Sie die Montagehalterung an der Decke.

Schrauben: 4 Schrauben, M4 x 10 mm (nicht im Lieferumfang enthalten)

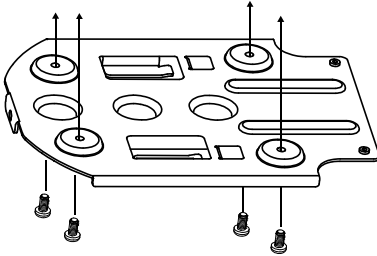

2. Befestigen Sie die Montagehalterung an der Kamera.

Schrauben: 2 Schrauben, 1/4"-20 L=6,5 mm (im Lieferumfang enthalten)

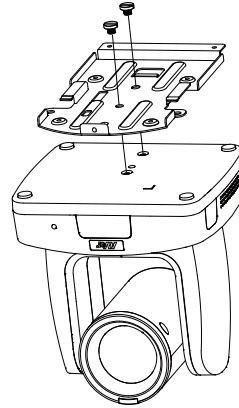

3. Schieben Sie die Kamera mit der Montagehalterung in die an der Decke befestigte Montagehalterung ein. Und stecken Sie die Kabel ein.

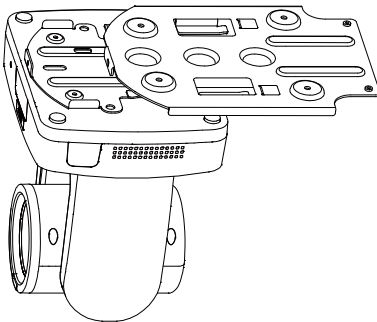

4. Befestigen Sie die Montagehalterungen mit Schrauben.

Schrauben: 3 Schrauben, M3 x 6 mm (im Lieferumfang enthalten)

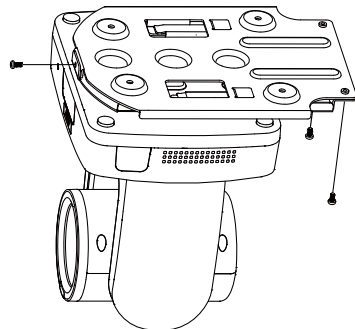

Verbindung

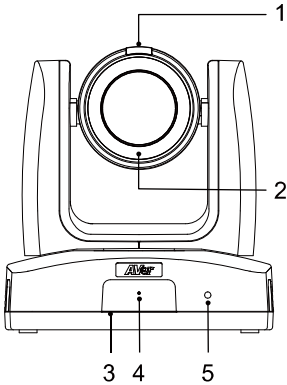

Vorderansicht

- 1. Aufnahme-LED
- 2. Infrarot-Nachtsicht-LED*
- 3. IR-Sensor
- 4. Mikrofon
- 5. LED Anzeige

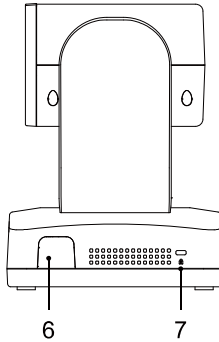

Seitenansicht

- 6. IR-Sensor
- 7. Kensington-Schloss

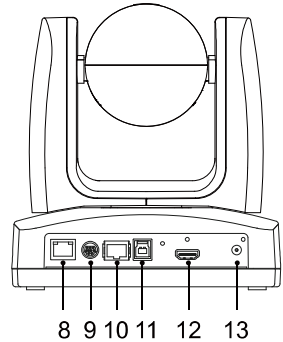

Rückansicht

- 8. PoE+-Anschluss
- 9. RS-232-Anschluss
- 10. RS-422-Anschluss
- 11. USB 3.1
Typ-B-Anschluss
- 12. HDMI-Anschluss
- 13. Gleichstrombuchse

*Achten Sie darauf, im Nachtmodus zwischen der IR-LED und dem menschlichen Auge stets eine Entfernung über 1 Meter zu wahren, um Gefährdungen durch Infrarotstrahlung zu vermeiden.

Aufnahme-LED

Farbe	Status
euchtet grün	Patient ist überwacht
Aus	Privatsphärenmodus/Gerät abgeschaltet

LED Anzeige

Farbe	Status
Statisch Blau	Normal
Blinkt blau	Tracking eingeschaltet
Statisch Orange	Standby
Blinkt Orange	Startvorgang
Statisch Violett	OSD-Menü eingeschaltet.
Blinkt Violett.	Firmware-Update

Geräteanschlüsse

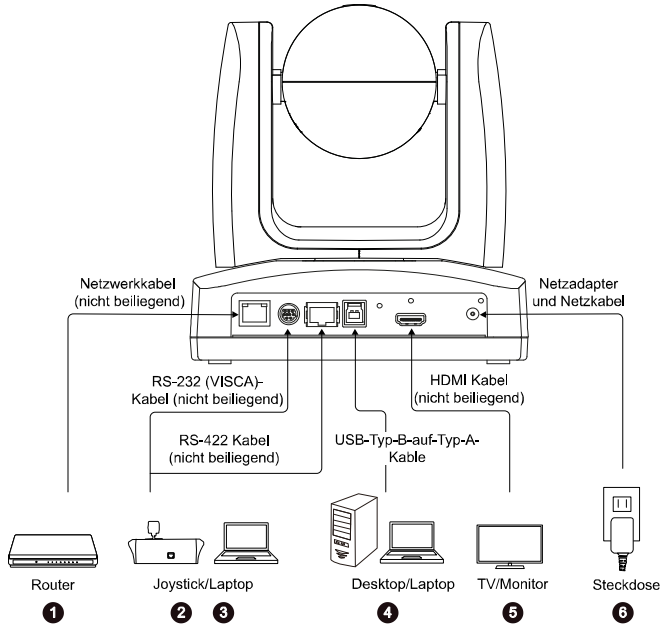

- LAN:** Verbinden Sie die Kamera über den LAN-Anschluss mit einem IP-Router. (Hinweis)
- RS-232:** Für die Steuerung der Kamera verbinden Sie sie mit einem Joystick oder Laptop. Kann ein optionaler RS-232-Adapter erworben werden. Nachfolgend ist die Pinbelegung abgebildet. (Hinweis)

● Pinbelegung

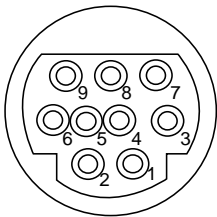

Funktion	Mini-DIN9-PIN	E/A-Typ	Signal	Beschreibung
VISCA IN	1	Ausgang	DTR	Datenterminal bereit
	2	Eingang	DSR	Datenset bereit
	3	Ausgang	TXD	Daten übertragen
	6	Eingang	RXD	Daten erhalten
VISCA OUT	7	Ausgang	DTR	Datenterminal bereit
	4	Eingang	DSR	Datenset bereit
	8	Ausgang	TXD	Daten übertragen
	9	Eingang	RXD	Daten erhalten

	5	Eingang	I/O	DIN8/DIN9-Erkennung
---	Ummantelung	---	GND	Erdung

3. **RS-422:** Zum Anschluss eines Joysticks oder eines Notebooks an die Kamera, um diese zu steuern. Wenn auf diese Weise mehrere Kameras angeschlossen werden sollen, verwenden Sie einen CAT5e-Splitter.

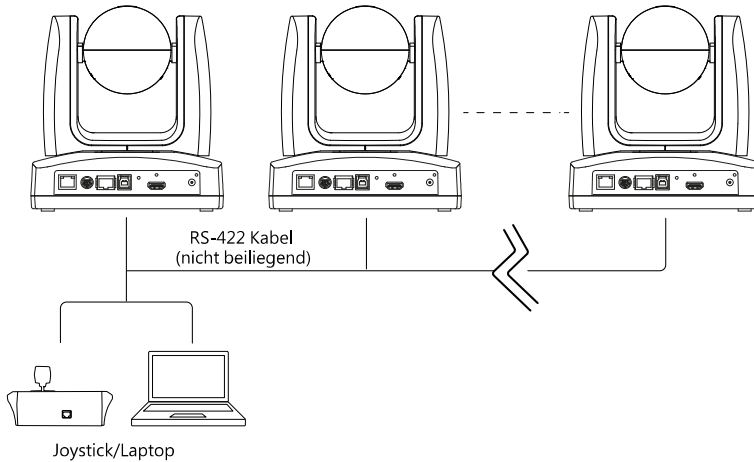

● **Pinbelegung**

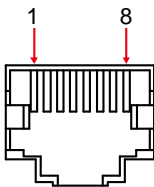

Nr.	Pin	Nr.	Pin
1	TX+	5	TX-
2	TX-	6	RX-
3	RX+	7	RX+
4	TX+	8	RX-

- Pinbelegung CAT5e-Splitter

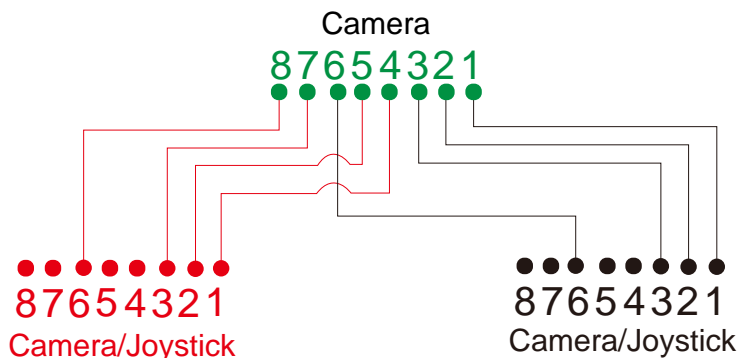

- 4. USB Type-B:** Wenn Sie eine andere Videokonferenz-Software verwenden, wie Skype oder Teams, verbinden Sie die Kamera für die Videoübertragung bitte mit einem Desktop oder Laptop. (Hinweis)
- 5. HDMI:** Für die Videoausgabe verbinden Sie die Kamera mit einem Fernsehgerät oder Monitor. Die Kamera und der angeschlossene Fernseher oder Monitor müssen geerdet sein. (Hinweis)
- 6. Stromanschluss:** Die Kamera und der angeschlossene Fernseher oder Monitor müssen geerdet sein. Verbinden Sie die Kamera mit dem mitgelieferten Adapter und dem Stromkabel mit einer Steckdose. Stellen Sie sicher, dass das Stromkabel von Fernsehgerät oder Monitor für den Erdungsstecker ausgelegt ist.

Hinweis:

Zusatzausrüstungen, die an die analogen und digitalen Schnittstellen des Gerätes angeschlossen werden, müssen nachweisbar ihren entsprechenden harmonisierten IEC-Normen entsprechen (z.B. IEC 60950 für datenverarbeitende Geräte, IEC 60065 für Datenverarbeitungsgeräte, IEC 61010-1 für Laborgeräte und EN 60601 für elektromedizinische Geräte) genügen. Darüber hinaus müssen alle Konfiguration den Systemanforderungen gemäß der Norm IEC 60601-1 entsprechen. Wer zusätzliche Geräte an den Signaleingangs- oder ausgangsteil anschließt, ist Konfigurierer eines medizinischen Systems und ist damit verantwortlich, dass die gültige Version der Systemnorm EN 60601-1-1 eingehalten wird. Dieses Gerät ist ausschließlich für die Verbindung mit nach EC 60601-1 zertifizierten Geräten in Patientenumgebungen und nach IEC 60XXX zertifizierten Geräten außerhalb von Patientenumgebungen zugelassen. Wenden Sie sich im Zweifel an die technische Serviceabteilung oder an den lokalen Vertreter.

Fernbedienung

Die Fernbedienung benötigt zwei Batterien der Größe „AAA“. Vergewissern Sie sich vor der Verwendung, dass die Batterien richtig eingesetzt sind.

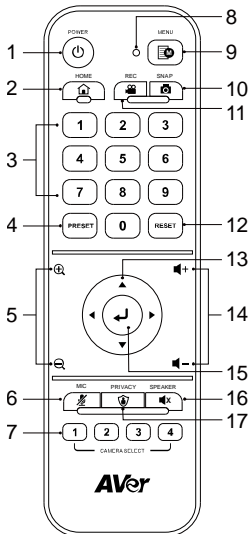







Model: LY033

Name	Funktion
1. Stromversorgung	Kurz antippen, um den Standby-Modus ein-/auszuschalten.
2. Home	Kamera in die Grundstellung bewegen. <ul style="list-style-type: none"> Mit den Tasten 0-9 bewegen Sie die Kamera in voreingestellten Positionen. Voreinstellungen nehmen Sie mit den Tasten 0-9 vor.
3. Zifferntasten	Die Voreinstellungen nehmen Sie mit den Preset-, Ziffern- und Richtungstasten vor. <ol style="list-style-type: none"> Mit den Richtungstasten navigieren Sie zu einer Position. Mit den Tasten „Zoom+“ und „Zoom -“ vergrößern/verkleinern Sie ein Bild. Halten Sie Preset gedrückt und drücken Sie dann die Zifferntasten (0~9), um diese voreingestellte Position zu speichern .
4. Voreinstellung	Drücken, um Bilder zu vergrößern oder zu verkleinern.
5. Zoom +/-	Drücken, um das Mikrofon stummzuschalten. Erneut drücken, um die Stummschaltung aufzuheben.
6. MIK	Kamera auswählen. Nummer im OSD-Menü angeben: System > Camera Selector .
7. Kameraauswahl	Werden Tasten an der Fernbedienung gedrückt, leuchtet die LED rot.
8. LED-Fernbedienung	3 Sekunden gedrückt halten, um das OSD-Menü zu öffnen. Diese Einstellung im OSD-Menü ändern: System > Trigger OSD .
9. Menu	N/A
10.Snap	N/A
11.Rec	N/A
12.Reset	Mit Reset- und den Zifferntesten werden die Voreinstellungen aufgehoben. Halten Sie Reset gedrückt und drücken Sie dann die Zifferntasten (0~9).
13.Richtungstasten	Mit den Richtungstasten navigieren Sie zu einer Position.
14.Volume +/-	N/A

15.Enter	<p>Wenn die Kamera eingeschaltet ist: Drücken Sie die Eingabetaste, um den Fokus einmal anzupassen.</p> <p>Beim Zugriff auf das OSD-Menü: Drücken Sie die Eingabetaste, um die Auswahl zu bestätigen oder eine Auswahl zu treffen.</p>
16.Speaker	N/A
17.Datenschutz	Zugriff auf den Datenschutzmodus. Die Kamera schaltet um in den Datenschutzmodus und das Mikrofon wird stummgeschaltet.

Verknüpfungen

Drücken	Um zu...
Menü  für 3 Sekunden	OSD-Menü öffnen.
Menü 	OSD-Menü schließen
Home 	OSD-Menü schließen und Kamera in die Ausgangsposition zurückführen.
Menü  , dann Vergrößern 	Umschalten zwischen Tag- und Nachtmodus.
Menü  , dann Vergrößern 	Umschalten zwischen Tag- und Auto-Modus.
Fünfmal die 5 (55555)	DHCP aktivieren
Sechsmal die 6 (666666)	Kamera auf die Werkseinstellungen zurücksetzen
Achtmal die 8 (88888888)	192.168.1.168 als statische IP-Adresse für die Kamera festlegen

Kameraeinrichtung

Die Kameraeinstellungen werden über das OSD-Menü oder die Webschnittstelle der Kamera konfiguriert.

Bildschirmmenü

Für den Zugriff auf das OSD-Menü verbinden Sie das Kamera mit dem HDMI-Kabel mit einem Monitor oder Fernsehgerät. Dann können Sie mit der beiliegenden Fernbedienung Einstellungen im OSD-Menü vornehmen.

1. Drücken Sie die Menü-Taste  für 3 Sekunden gedrückt halten an der Fernbedienung, um das OSD-Menü aufzurufen. Mit den Tasten **▲▼◀▶** navigieren Sie durch die Seiten und Optionen. Mit **↵** bestätigen Sie Ihre Einstellungen..

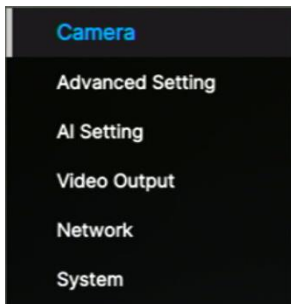



IP-Adresse einrichten

Static IP

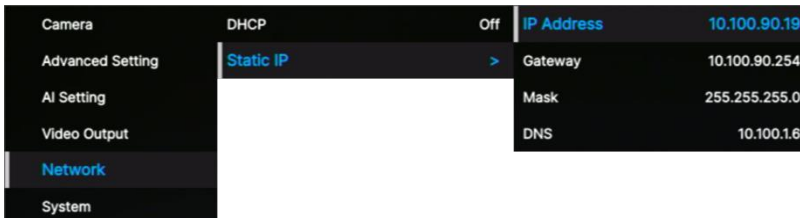
2. Drücken Sie die Menü-Taste  für 3 Sekunden gedrückt halten an der Fernbedienung, um das OSD-Menü aufzurufen.
3. Öffnen Sie **Network > Static IP**.
[Hinweis] Schalten Sie **DHCP** vor Einrichtung der statischen IP aus (**Network > DHCP > OFF**).
4. Für die Konfiguration wählen Sie **IP Address, Gateway, Netmask** und **DNS** . Drücken Sie **↵** und die Zifferntasten, um den Wert einzugeben.



DHCP

1. Drücken Sie die Menü-Taste  für 3 Sekunden gedrückt halten an der Fernbedienung, um das OSD-Menü aufzurufen.
2. Wählen Sie **Network > DHCP > On**.
3. Mit  bestätigen Sie Ihre Einstellungen.

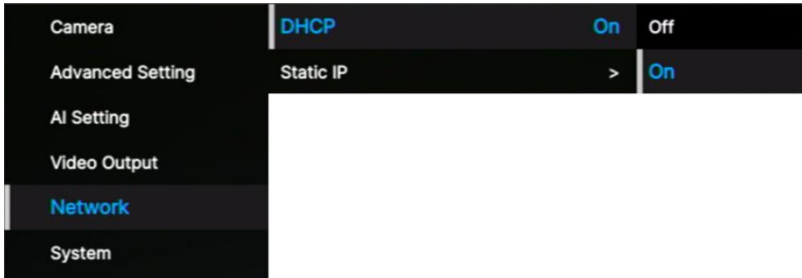

4. Nach der Aktivierung von **DHCP** wird die IP-Adresse unter **System > Information** angezeigt.

Camera	Trigger OSD	Press Menu 3 sec	Model Name	MD120UI
Advanced Setting	Camera Selector	All	Serial Number	5100435000010
AI Setting	Status OSD	Off	Version	1.10502.0
Video Output	Language	English	IP Address	0.0.0.0
Network	Information	>	MAC	00:18:1A:0C:BA:4E
System	Factory Default	>	Lens	C004
	System Reboot	>	Mcu	A001

OSD Menüstruktur

1. Ebene	2. Ebene	3. Ebene	4. Ebene
Camera	Exposure Mode	Full Auto	Exposure Value
			Gain Limit Level
			Slow Shutter
			BLC
			WDR
		Shutter Priority	Exposure Value
			Shutter Speed
			Gain Limit Level
		Iris Priority	Exposure Value
			Iris Level
			Gain Limit Level
			Slow Shutter
		Manual	Iris Level
			Shutter Speed
			Gain Level
	Bright mode	Bright value	
	White Balance	Auto	
		ATW	
		Indoor	
		Outdoor	
		One push trigger	
		Manual	R gain
		B gain	
	Pan Tilt Zoom	Preset Speed	5, 25, 50, 100, 150, 200
		Preset Accuracy	Off / On
		Pan Speed	1~24
		Tilt Speed	1~24
Zoom Speed		Low / High	
P/T Spd. Relative Z Ratio		Off / On	

		Pan L/R Dir. Switch	Off / On
	Noise filter	Off / Low / Middle / High	
	Saturation	0 1 2 3 4 5 6 7 8 9 10	
	Contrast	0 1 2 3 4	
	Sharpness	0 1 2 3	
	Mirror	OFF / ON	
	Flip	OFF / ON	
Advanced Setting	Audio	Audio Volume	0~10
	Control	Type	RS232 / RS422
		Protocol	VISCA
		Camera Address	1 2 3 4 5 6 7
		Baud Rate	4800 / 9600 / 38400
	IR Cut Filter	Auto / Day / Night	
IR Cut Sensitivity	Low / Middle / High		
AI Setting	Facial Tracking	Eyes Tracking	On/Off
		Tracking Preset	Save
		Tracking Site	Full Face / Eyes
		Tracking Range	Close / Medium / Wide
		Timeout to Preset	3/5/7/10 sec
	AI Audio Detection	Audio Detection	On/Off
Video Output	Theme Mode	HDMI / UVC	
	Frequency	60	
		59.94	
		50	
	Resolution	2160p60	
		2160p59	
		2160p50	
		2160p30	
		2160p29	
		2160p25	
1080p60			

		1080p59	
		1080p50	
		1080p30	
		1080p29	
		1080p25	
		1080i60	
		1080i59	
		1080i50	
		720p60	
		720p59	
		720p50	
		Network	DHCP
ON			
Static IP	IP Address		192.168.1.168
	Gateway		192.168.1.254
	Mask		255.255.255.0
	DNS	8.8.8.8	
System	Trigger OSD	Click Menu to open, Press Menu 3 sec	
	Camera Selector	1,2,3,4,All channel, Disable Remote	
	Status OSD	OFF	
		ON	
	Language	English / 中文 / 日本語	
	Information	Model Name	MD120UI
		Serial number	xxxxxxxxxxxxx
		Firmware Version	0.0.0000.00
		IP	192.168.1.168
		MAC	00:18:1a:04:9e:81
Lens		xxxx	
Mcu		xxxx	
Factory Default	Off / On		
System Reboot	Off / On		

Weberichtung

Entfernte Kameraverbindung über das Internet.

Zugriff auf die Webschnittstelle der Kamera

Für den Zugriff auf die Webschnittstelle der Kamera müssen Sie die IP-Adresse der Kamera mithilfe von **AVer IPCam Utility** oder der **AVer PTZ Management**-Software ermitteln.

Zugriff auf die Kamera über AVer IPCam Utility

Für die Ermittlung der IP-Adresse Ihrer Kameras mit dem IPCam Utility installer gehen Sie folgendermaßen vor.

1. Download von IPCam Utility unter <https://www.aver.com/download-center> und Ausführen von IPCam Utility.
2. Klicken Sie auf **Suche**, um alle verfügbaren Geräte auf dem Bildschirm anzuzeigen.
3. Wählen Sie die Kamera aus der Liste aus. Die Kamerainformationen werden im Feld „Einstellungen“ angezeigt.

[Hinweis] Das Standardnetzwerk der Kamera hat die statische IP-Adresse (192.168.1.168). Das Standard-Passwort/die ID lautet **admin/admin**. Wenn Sie das Netzwerk mit DHCP konfigurieren möchten, geben Sie die ID/das Passwort in das Feld **Login** ein. Wählen Sie das „Kameramodell“ aus der Liste aus. Wählen Sie „DHCP“ und klicken Sie auf die Schaltfläche **Apply**.

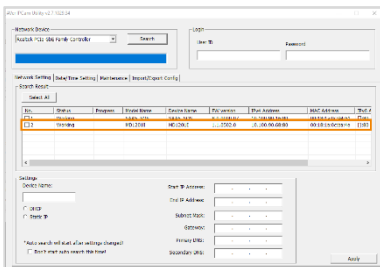

4. Für den Zugriff auf die Weboberfläche doppelklicken Sie auf die P-Adresse in der IPv4-Adressspalte.

Bei der erstmaligen Verwendung werden Sie an einem Login-Fenster zur Änderung von ID und Passwort aufgefordert.

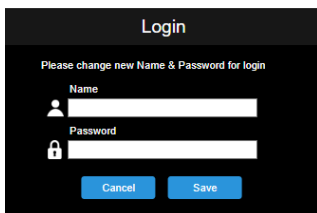

5. Melden Sie sich mit Ihrer neuen ID/dem Passwort an. Die Webschnittstelle der Kamera wird

angezeigt (Chrome-Browser). Weitere Informationen finden Sie im Kapitel <Live-Ansicht>.

[Hinweis] Wenn IPCam Utility die Kamera nicht finden kann, überprüfen Sie bitte folgendes:

1. Stellen Sie sicher, dass die Kamera richtig über den Ethernet-Anschluss verbunden ist.
2. Kamera und PC (IPCam Utility) in demselben LAN-Segment.

Zugriff auf die Kamera über AVer PTZ Management

Für die Ermittlung der IP-Adresse Ihrer Kamera mit dem AVer PTZ Management gehen Sie folgendermaßen vor.

1. Download der AVer PTZ Management Software: <https://www.aver.com/download-center>
2. Laden Sie das Windows-Programm herunter und installieren Sie es.
3. Nach der Einrichtung von Benutzer-ID und Passwort melden Sie sich an der Software an (Standard-Benutzername/Passwort: admin/admin).

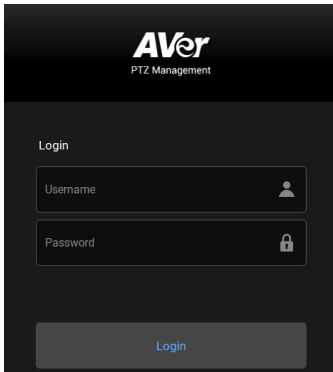

4. Auf der Hauptseite von PTZ Management klicken Sie auf **Setup > Add** und dann auf **Auto Search**. Die Kameras, die im selben LAN mit dem Computer verbunden sind, werden angezeigt.

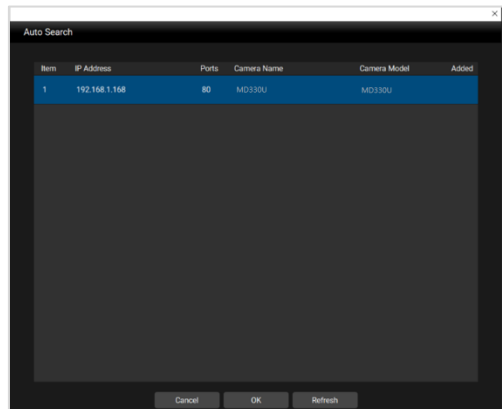
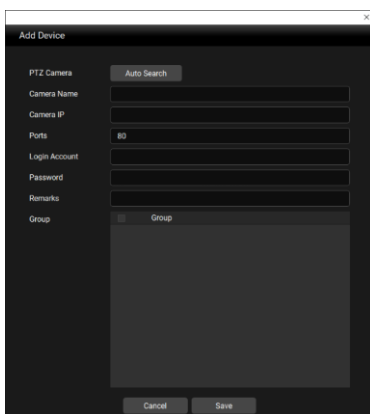



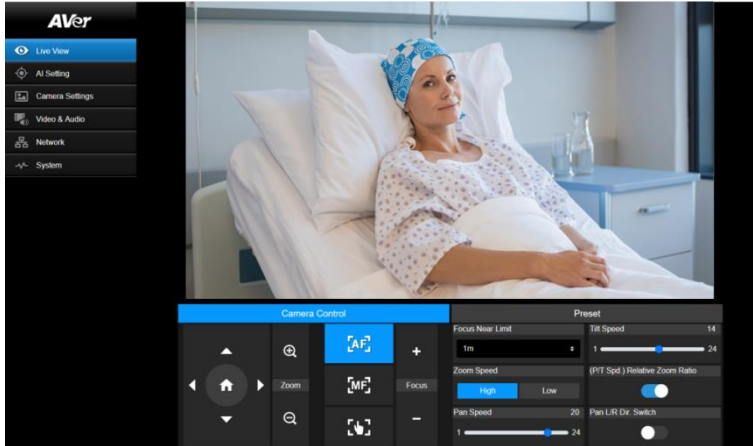

5. Klicken Sie auf die Kamera und geben Sie die Kamera-ID und das Passwort ein, um die Kamera der Geräteliste hinzuzufügen (Standard-ID/Passwort: **admin/admin**). Für den Zugriff auf die Webschnittstelle der Kamera klicken Sie auf **Go to Web**.

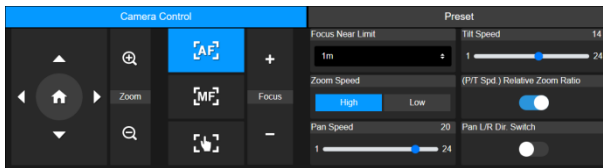

Live Ansicht (Live View)



Kamerasteuerung (Camera Control)



Steuerelement	Beschreibung
Schwenk- und Neigungssteuerelemente 	Kamera positionieren <ul style="list-style-type: none"> ● Stellen Sie mit dem Schieberegler die Schwenk- und Neigungsgeschwindigkeit ein. ● Aktivieren Sie Pan L/R Dir. Switch, um die Schwenkrichtung zu invertieren. ● Aktivieren Sie P/T Spd. Relative Z Ratio, um die Geschwindigkeiten der Schwenkbewegungen auf der Basis des Zoomverhältnisses automatisch festzulegen. Sie können diese Option auch über das OSD-Menü Camera > Pan Tilt Zoom > P/T Spd. Relative Z Ratio festlegen.
Home-Position 	Kamera in die Ausgangsposition zurückfahren
Zoom 	Live View-Ausschnitt vergrößern oder verkleinern und die Zoomgeschwindigkeit auswählen
Focus +- 	<ul style="list-style-type: none"> ● Auto Focus: Klicken, um die automatische Scharfstellung zu aktivieren

-  **Auto Focus:** Klicken, um die manuelle Scharfstellung zu aktivieren. Passen Sie dann die Scharfstellung mit den + --Schaltflächen an.
-  **One Push Focus:** Klicken, um die automatische Scharfstellung einmalig zu aktivieren
- **Focus Near Limit:** Scharfstellung auf maximal nah festlegen

Voreinstellung (Preset)

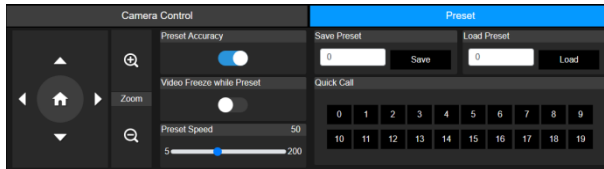

Steuerelement	Beschreibung
Save Preset	<ol style="list-style-type: none"> 1. Stellen Sie die Position der Kamera mittels der Steuerelemente zum Schwenken, Neigen und Zoomen ein. 2. Geben Sie eine Nummer für das Preset (0 – 255) in das Feld Save Preset ein und klicken Sie auf Save.
Load Preset	<ol style="list-style-type: none"> 1. Geben Sie eine Nummer für das Preset (0 – 255) in das Feld Load Preset ein und klicken Sie auf Load. 2. Sie können auch stattdessen im Abschnitt Quick Call auf eine der Nummern für die Presets (0 – 20) klicken.
Preset Accuracy	Aktivieren, um die Genauigkeit bei der Einnahme der Preset-Positionen zu verbessern
Video Freeze while Preset	Aktivieren, um den Live View nur aus den Preset-Positionen anzuzeigen. Der Live View während der Bewegung wird nicht angezeigt.
Preset Speed	Ermöglicht die Anpassung der Kamerageschwindigkeit beim Wechseln der Preset-Position

KI-Einstellungen (AI Setting)



Blick-Tracking (Eyes Tracking)

Wenn während dem Blick-Tracking die Steuerelemente zum Schwenken, neigen und Zoomen manuell eingestellt werden, wird die Funktion deaktiviert.

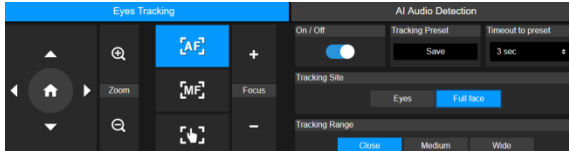

1. Stellen Sie die Position der Kamera mittels der Steuerelemente zum Schwenken, Neigen und Zoomen ein und klicken Sie dann auf **Save**, um die Position unter **Tracking Preset** zu speichern. Standardmäßig vorgegeben ist die Home-Position.
2. Wählen Sie aus der Dropdown-Liste **Timeout to preset** ein Zeitintervall aus, um festzulegen, wann die Kamera in die Preset-Position für das Tracking zurückgeführt wird, wenn vor der Kamera kein Gesicht erkannt wird. Standardmäßig vorgegeben ist ein Intervall von 3 Sekunden.
3. Klicken Sie auf die Option **On/Off**, um das Blick-Tracking zu aktivieren, wenn vor der Kamera ein Gesicht erkannt wird.
 - Eine Person: Die Kamera zoomt automatisch an das Gesicht heran und beginnt mit dem Blick-Tracking.
 - Mehrere Personen: Die Kamera markiert die erkannten Gesichter mit einem viereckigen Rahmen. Wählen Sie ein Gesicht aus, indem Sie auf einen solchen Rahmen klicken, um an dieses Gesicht heranzuzoomen und mit dem Blick-Tracking zu beginnen.

4. Wählen Sie **Tracking Site** und **Tracking Range** aus.

KI-Audioerkennung (AI Audio Detection) (Beta)

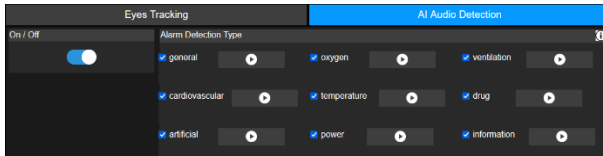

1. Aktivieren, um die ausgewählten Alarme zu erkennen.
2. Klicken Sie auf die Wiedergabe-Schaltfläche, um die Alarmklänge anzuhören.

Kameraeinstellungen (Camera Settings)

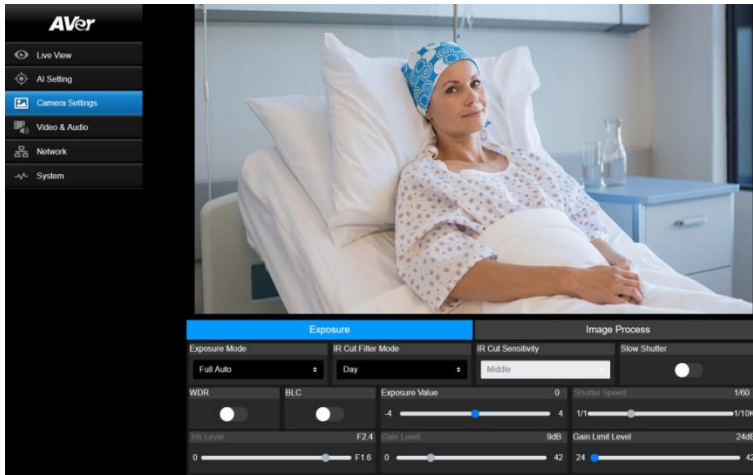

Belichtung (Exposure)

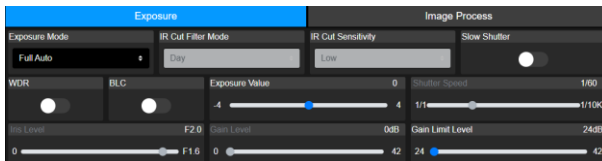

Steuerelement	Beschreibung
Exposure Mode	Auswahl des Belichtungsmodus
WDR	WDR oder BLC aktivieren bzw. deaktivieren
BLC	
Exposure Value	
Shutter Speed	
Iris Level	Belichtung, Verschluss, Blende und Verstärkung einstellen
Gain Level	
Gain Limit Level	
IR Cut Filter Mode	Mit Day den Tages- bzw. mit Night den Nachtmodus auswählen, um die Infrarot-Nachtsicht ein- oder auszuschalten. Sie können auch den Modus Auto wählen und dann den Wert für IR Cut Sensitivity anpassen.

Slow Shutter

Mit **Slow Shutter** lange Belichtungszeit aktivieren bzw. deaktivieren

Bildbearbeitung (Image Process)

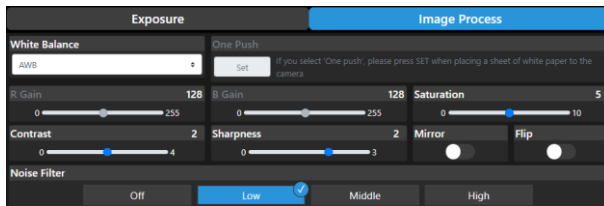

Steuerelement

Beschreibung

White Balance

- Auswahl des Weißabgleichsmodus. Wenn **Manual** ausgewählt ist, können Sie auch unter **R Gain** bzw. **B Gain** die jeweiligen Farbanteile verstärken.
- Wenn **One Push** ausgewählt ist, halten Sie ein weißes Blatt Papier vor die Kamera und klicken Sie auf **Set**, um eine Kalibrierung/Weißabgleich durchzuführen.

Saturation

Contrast

Farbsättigung, Kontrast und Bildschärfe einstellen

Sharpness

Mirror

Mit **Mirror** bzw. **Flip** die Effekte für Spiegelung und vertikales

Flip

Kippen aktivieren oder deaktivieren

Noise Filter

Geräuschfilterpegel auswählen

Video und Audio (Video & Audio)

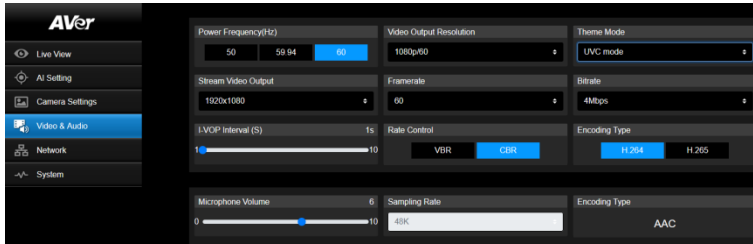

Videoeinstellungen

Steuerelement	Beschreibung
Power Frequency (Hz)	Je nach Land bzw. Region 50Hz , 59.94Hz oder 60Hz auswählen
Video Out Resolution	Bildauflösung für Videoausgang auswählen RTSP: Max. 4K/60 fps HDMI: Max. 4K 60 Hz
Theme Mode	Video-Overlay auswählen, um UVC- oder HDMI-Ausgang den Vorrang zu geben
Stream Video Output	Bildauflösung des Streamingausgangs für Live View auswählen
Framerate	Framerate auswählen
Bitrate	Bitrate auswählen
I-VOP Interval (S)	<ul style="list-style-type: none"> ● Legen Sie über den Schieberegler fest, wie oft in einem Videostream I-VOPs angezeigt werden. ● Ein kürzeres I-VOP-Intervall verbessert die Videoqualität, allerdings werden die Dateien größer.
Rate Control	VBR oder CBR auswählen
Encoding Type	H.264 oder H.265 auswählen

Audioeinstellungen

Steuerelement	Beschreibung
Microphone Volume	Stellen Sie mit dem Schieberegler den Mikrofonpegel ein.
Sampling Rate	48 K
Encoding Type	AAC

Netzwerk (Network)

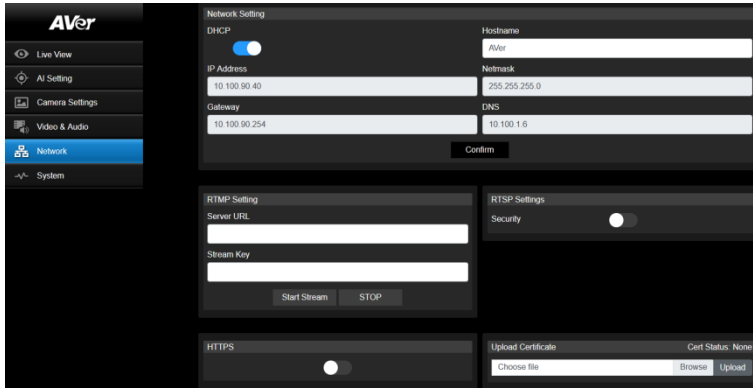

Steuerelement	Beschreibung
Hostname	Der voreingestellte Hostname ist „AVer“. Hier können Sie den Hostnamen, mit dem die Kamera auf anderen Geräten (beispielsweise einem IP-Router) angezeigt wird, ändern.
DHCP	<p>Konfiguriert das Netzwerk über DHCP oder mit einer statischen IP-Adresse.</p> <ul style="list-style-type: none"> ● DHCP: Sie aktivieren DHCP. Klicken Sie auf Confirm, um die Einstellung zu speichern. Die Kamera erhält dann ihre IP-Einstellungen automatisch. ● Static IP: Sie deaktivieren DHCP. Geben Sie dann unter IP Address, Netmask, Gateway und DNS die benötigten Werte ein und klicken Sie auf Confirm, um die Einstellung zu speichern.
RTMP Setting	<p>Streaming von Live-Video auf eine Videoplattform wie YouTube</p> <ol style="list-style-type: none"> 1. Geben Sie unter Server URL und Stream Key die benötigten Werte für Ihre Videoplattform ein. Informationen zum Erhalt des benötigten Server-URLs und des Stream-Keys erhalten Sie in der Anleitung zu ihrer Plattform. 2. Klicken Sie auf Start Stream, um mit dem Streaming zu beginnen, und auf Stop, um das Streaming zu beenden.

RTSP Settings

Wenn Sie Media-Player wie VLC, PotPlayer oder QuickTime verwenden, müssen Sie Ihren Videostream geeignet schützen, indem Sie sicherstellen, dass nur autorisierte Benutzer darauf zugreifen können.

- Wenn **Security** deaktiviert ist:
 1. Geben Sie im Media-Player den RTSP-URL der Kamera ein.
 2. RTSP-URL: `rtsp://[Kamera-IP-Adresse]/live_st1`
Beispiel: `rtsp://192.168.1.100/live_st1`

- Wenn **Security** aktiviert ist:
 1. Geben Sie im Media-Player den RTSP-URL der Kamera und den Benutzernamen mit dem zugehörigen Kennwort ein.
 2. RTSP-URL:
`rtsp://[Benutzername:Kennwort]@[Kamera-IP-Adresse]/live_st1`
Beispiel: `rtsp://1:1@192.168.1.100/live_st1`
 3. Benutzername/Kennwort: Benutzername/Kennwort der Kamera (derselbe Benutzer wie bei der Anmeldung über die Webschnittstelle)

HTTPS

Sie können HTTPS aktivieren, um zwischen dem Browser und der Kamera eine sichere Verbindung herzustellen. Gehen Sie wie folgt vor, um den HTTPS-Zugang auf Ihrer Kamera zu aktivieren:

1. Sie benötigen ein base-64-kodiertes SSL-Zertifikat sowie einen privaten Schlüssel im PKCS#8-Format (unverschlüsselt).
 2. Exportieren Sie den Inhalt des benötigten Zertifikats im PEM-Format. Das SSL-Zertifikat, das an die Kamera hochgeladen wird, muss im PEM-Format vorliegen.
 3. Klicken Sie auf **Browse**, um die Zertifikatdatei auszuwählen und klicken Sie dann auf **Upload**.
 4. Aktivieren Sie HTTPS.
-

System (System)

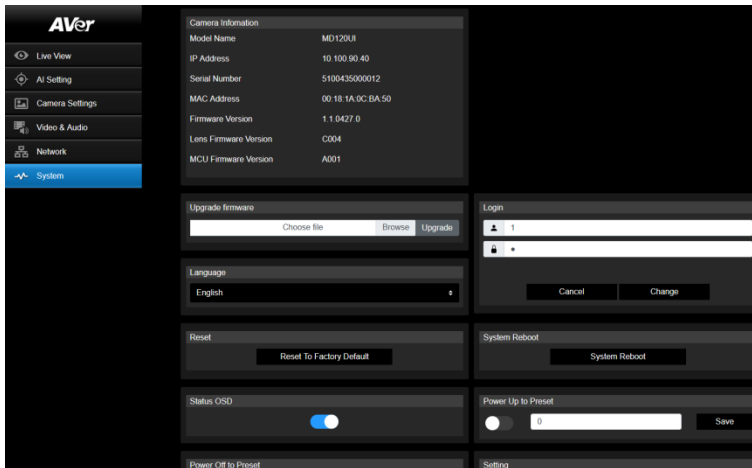

Steuerelement	Beschreibung
Camera Information	Kamerainformationen anzeigen
Upgrade Firmware	<p>Gehen Sie wie folgt vor, um ein Firmwareupgrade durchzuführen:</p> <ol style="list-style-type: none">1. Laden Sie die neueste Firmware aus dem AVer Download Center (https://www.aver.com/download-center/) herunter.2. Gehen Sie auf der Webseite zu System > Upgrade firmware.3. Klicken Sie auf Browse, um die benötigte Firmware auszuwählen.4. Klicken Sie auf Upgrade, um das Firmwareupgrade zu installieren.5. Aktualisieren Sie das Browserfenster, nachdem das Upgrade installiert ist. <p>[Hinweis] Stellen Sie sicher, dass die Kamera während der Installation des Firmwareupgrades an eine Stromquelle angeschlossen ist. Während der Installation wird die Kamera zwischenzeitlich vom Netzwerk getrennt. Sie startet sich nach der Installation des Upgrades automatisch neu.</p>
Login	Der werksseitig vorgegebene Benutzername bzw. das Kennwort lauten admin/admin . Um den Benutzernamen oder das Kennwort zu ändern, geben Sie den neuen Benutzernamen bzw. das Kennwort ein und klicken Sie dann auf Change .

Language	Sprache der Webschnittstelle ändern
Reset	Kamera auf die Werkseinstellungen zurücksetzen
System Reboot	Kamera neustarten
Status OSD	Aktivieren, um bei Befehlen wie Speichern, Laden oder Abbrechen der Preset-Positionierung den Status der Voreinstellungen über den HDMI-Ausgang auszugeben
Power Up to Preset	<p>Aktivieren, um die Kamera nach dem Einschalten in die angegebene Position zu bringen</p> <ul style="list-style-type: none"> ● Klicken Sie auf die Wahlschaltfläche, um die Funktion zu aktivieren, geben Sie die Nummer eines Presets ein und klicken Sie dann auf Save. ● Beachten Sie, dass die eingegebene Preset-Nummer bereits definiert sein muss, bevor Sie diese Funktion aktivieren.
Power Off to Preset	<p>Aktivieren, um die Kamera vor dem Ausschalten in die angegebene Position zu bringen</p> <ul style="list-style-type: none"> ● Klicken Sie auf die Wahlschaltfläche, um die Funktion zu aktivieren, geben Sie die Nummer eines Presets ein und klicken Sie dann auf Save. ● Beachten Sie, dass die eingegebene Preset-Nummer bereits definiert sein muss, bevor Sie diese Funktion aktivieren.
Setting	Kameraeinstellungen exportieren oder importieren
Help Us Improve	Per Opt-in bzw. Opt-out angeben, ob Nutzungsdaten anonym übermittelt werden dürfen

AVerCamera Setting Tool

Das AVerCamera Setting Tool ist eine Software, die den Betrieb der AVer PTZ-Kameras während des Streamens mit der Software von Drittanbietern unterstützt. Sie ermöglicht den AnwenderInnen die Konfiguration von Bild-, Audio- und Videoeinstellungen ohne Fernbedienung sowie die Verbindung der Kamera über USB.

- Download des AVerCamera Setting Tools von der AVer-Website:
(<https://www.aver.com/Downloads/search?q=AVer%20Camera%20Setting%20Tool>).
- Informationen zu den Einstellungen finden Sie Kapitel <AVerCamera Setting Tools> im Handbuch des CaptureShare.

Specification

Kamera	
Bildsensor	1/2.8" CMOS
Effektive Bildelemente	8 Megapixel
Ausgangsaufösungen	Bildauflösung: 4K/1080p/720p Framerate: 60/59,94/50/30/29,97/25
Minimaler Ausleuchtung	0,5 lux (50 IRE, F1.6, Max. AGC, 1/30)
Rauschabstand	≥ 50 dB
Verstärkung	Automatisch, manuell
TV-Zeilen	1000 (Mitte/breit)
Verschlusszeit	1/1 – 1/10.000 Sek.
Belichtungssteuerung	Automatisch, manuell, Priorität AE (Verschluss, Blende), BLC,
Weißabgleich	Automatisch, manuell
Optischer Zoom	20X
Digitaler Zoom	1X
Zoom insgesamt	20X
Sichtwinkel	DFOV: 69,2° (Weitwinkel) – 4,1° (Tele) HFOV: 62,3° (Weitwinkel) – 3,6° (Tele) VFOV: 37,3° (Weitwinkel) – 2,1° (Tele)
Brennweite	F: 4,5 mm (Weitwinkel) – 90 mm (Tele)
Blende	F: 1,8° (Weitwinkel) – 4,7° (Tele)
Minimal Distanz im Betrieb	Weitwinkel: 0,1 m, Tele: 1,2 m
Schwenk- und Neigungswinkel	Schwenken: ±170°, Neigung: +90°/-30°
Schwenk- und Neigungsgeschwindigkeit	Schwenken: 0,1° – 100°/Sek., Neigung: 0,1° auf 100°/Sek.
Positionierungsgeschwindigkeit	Schwenken: 200°/Sek., Neigung: 200°/Sek.
Preset-Position	10 (IR), 256 (RS-232, RS-422, IP)
Kamerasteuerung – Schnittstellen	RS-232/RS-422/Ethernet
Kamerasteuerung – Protokolle	VISCA (RS-232/RS-422/IP), CGI (IP)
Bildbearbeitung	Spiegeln/Kippen/Einfrieren/WDR/BLC
Stromfrequenzen	50 Hz, 60 Hz

KI-Funktionen

Betriebsmodi	Blick-Tracking
--------------	----------------

Privatsphäre



Allgemein	
Stromversorgung	12 V
Stromverbrauch	24 W
PoE	PoE+ (IEEE802.3at)
Abmessungen (B x D x H)	180 x 145 x 183,5 mm
Nettogewicht	1,7 kg ±0,1 kg
Anwendungsbereich	Innenräume
Kamerakontrollampe	Ja
Sicherheit	Kensington-Schlitz
IR-Fernbedienung	Ja
Betriebsbedingungen	Temperatur: 0 °C – +40 °C Luftfeuchtigkeit: 20 % – 80 %
Lagerbedingungen	Temperatur: -20 °C – +60 °C Luftfeuchtigkeit: 20 % – 95 %
Audio	
Kanäle	Zweikanal-Stereo
Codecs	AAC-LC (48K)
Schnittstelle	
Videoausgänge	HDMI, IP, USB
Audioausgänge	HDMI, IP, USB
Audioeingänge	n.v.
IP Streaming	
Auflösung	4K/60fps
Netzwerk-Videokompressionsformate	H.264, H.265, MJPEG
Max. Framerate	4K/60fps
Bitrate Steuermodi	VBR, CBR
Bitratenbereich	512 Kbps – 64 Mbps
Netzwerkschnittstellen	10/100/1000 Base-T
Multi-Stream-fähig	2 (RTSP/Web page), Max. 4K/60fps
Netzwerkprotokolle	IPv6, IPv4, TCP, UDP, ARP, ICMP, IGMP, HTTP, DHCP RTP/RTCP, RTSP, RTMP, VISCA over IP

USB	
Anschluss	USB 3.0 (Typ B)
Videoformate	MJPEG
Max. Video	2160p
USB Video Class (UVC)	UVC1.1
USB Audio Class (UAC)	UAC 1.0
Web-Benutzeroberfläche	
Live Video-Vorschau	Ja
Kamerasteuerung (Positionierung und Zoom)	Schwenken, Neigung, Zoomen, Scharfstellung und Preset-Steuerung
Kamera /Bild	Belichtung, Weißabgleich, Bildbearbeitung
Netzwerkkonfiguration	DHCP, IP-Adresse, Gateway, Subnetzmaske, DNS
Software-Tools	
IP-Such- und -Konfigurierungs-Tool	Unterstützt Windows® 7 oder neuer
Positions- und Zoomverwaltung	Unterstützt Windows® 7 oder neuer
Positions- und Zoomsteuerung	Unterstützt iOS & iPadOS® 11 oder neuer
Kameraeinstellungs-Tool	Unterstützt Windows® 7 oder neuer, macOS® 10.14 oder neuer

Die Spezifikationen können ohne vorherige Ankündigung geändert werden.

Fehlerbehebung

Das Bild ist verzerrt oder unscharf.

- Gehen Sie in der Webschnittstelle zu **Live View > Camera Control** und klicken Sie auf  **Auto Focus**.
- Drücken Sie auf der Fernbedienung 3 Sekunden lang die Taste **Menu** . Wählen Sie dann **Factory Default > On**, um alle Einstellungen auf die Werkseinstellungen zurückzusetzen.

Wie öffne ich das OSD-Menü am Bildschirm?

1. Stellen Sie sicher, dass das HDMI-Kabel die Kamera und den Bildschirm verbindet.
2. Drücken Sie auf der Fernbedienung 3 Sekunden lang die Taste **Menu**  um das On-Screen-Display-Menü zu öffnen.
3. Wenn das OSD-Menü eingeschaltet ist, leuchtet die Status-LED violett.

Anhang

VISCA RS-232 Befehlstabelle

Command Set	Command	Command Packet	Comments
Command Set	Command	Command Packet	Comments
IF_Clear	Broadcast	88 01 00 01 FF	I/F Clear (Clear Visca connection & command buffer queue)
CommandCancel	--	8x 2p FF	p: Socket No. (=1or2)
CAM_Power	On	8x 01 04 00 02 FF	Power OFF to Standby mode Power ON supported in Standby mode only
	Off	8x 01 04 00 03 FF	
CAM_Zoom	Stop	8x 01 04 07 00 FF	Zoom Control
	Tele(Standard)	8x 01 04 07 02 FF	
	Wide(Standard)	8x 01 04 07 03 FF	
	Tele(Variable)	8x 01 04 07 2p FF	p=0 (Low) to 7 (High)
	Wide(Variable)	8x 01 04 07 3p FF	
	Direct	8x 01 04 47 0p 0q 0r 0s FF	pqrs: Zoom Position. MD120UI: 0x00F0 (x1) ~ 0x5378 (x20)
CAM_Focus	Stop	8x 01 04 08 00 FF	Focus Control Each 'Far/Near' needs a 'stop'
	Far (Standard)	8x 01 04 08 02 FF	
	Near (Standard)	8x 01 04 08 03 FF	
	Far (Variable)	8x 01 04 08 2p FF	p=0 (Low) to 7 (High)
	Near (Variable)	8x 01 04 08 3p FF	
	Auto Focus	8x 01 04 38 02 FF	AF ON/OFF
	Manual Focus	8x 01 04 38 03 FF	
	Auto/Manual	8x 01 04 38 10 FF	
	One Push	8x 01 04 18 01 FF	
	Direct	8x 01 04 48 0p 0q 0r 0s FF	pqrs: Focus Position, MD120UI: 0x0000(wide) ~ 0x4000(tele)
	Near Limit	8x 01 04 28 0p 0q 0r 0s FF	pqrs: Focus Near Limit Position 0001: 0.01m 0002: 1m 0003: 1.5m 0004: 2m 0005: 3m 0006: 6m 0007: 10m

Command Set	Command	Command Packet	Comments
CAM_AFMode	Normal AF	8x 01 04 57 00 FF	Continuous AF ON
	Zoom Trigger AF	8x 01 04 57 02 FF	Continuous AF OFF, only trigger AF after PTZ done
CAM_WB	Auto	8x 01 04 35 00 FF	Normal Auto
	ATW	8x 01 04 35 04 FF	
	Indoor	8x 01 04 35 01 FF	
	Outdoor	8x 01 04 35 02 FF	
	One Push WB	8x 01 04 35 03 FF	One Push WB mode
	Manual	8x 01 04 35 05 FF	Manual Control mode
	One Push Trigger	8x 01 04 10 05 FF	One Push WB Trigger
CAM_RGain	Reset	8x 01 04 03 00 FF	Manual Control of R Gain
	Up	8x 01 04 03 02 FF	
	Down	8x 01 04 03 03 FF	
	Direct	8x 01 04 43 00 00 0p 0q FF	pq: R Gain
CAM_BGain	Reset	8x 01 04 04 00 FF	Manual Control of B Gain
	Up	8x 01 04 04 02 FF	
	Down	8x 01 04 04 03 FF	
	Direct	8x 01 04 44 00 00 0p 0q FF	pq: B Gain
CAM_AE	Full Auto	8x 01 04 39 00 FF	Automatic Exposure mode
	Manual	8x 01 04 39 03 FF	Manual Control mode
	Shutter Priority	8x 01 04 39 0A FF	Shutter Priority Automatic Exposure mode
	Iris Priority	8x 01 04 39 0B FF	Iris Priority Automatic Exposure mode
CAM_SlowShutter	Auto	8x 01 04 5A 02 FF	Auto Slow Shutter ON/OFF
	Manual	8x 01 04 5A 03 FF	
CAM_Shutter	Reset	8x 01 04 0A 00 FF	Shutter Setting
	Up	8x 01 04 0A 02 FF	
	Down	8x 01 04 0A 03 FF	
	Direct	8x 01 04 4A 00 00 0p 0q FF	pq: Shutter Position
CAM_Iris	Reset	8x 01 04 0B 00 FF	Iris Setting
	Up	8x 01 04 0B 02 FF	

Command Set	Command	Command Packet	Comments
	Down	8x 01 04 0B 03 FF	
	Direct	8x 01 04 4B 00 00 0p 0q FF	pq: Iris Position
CAM_Gain	Reset	8x 01 04 0C 00 FF	Gain Setting
	Up	8x 01 04 0C 02 FF	
	Down	8x 01 04 0C 03 FF	
	Direct	8x 01 04 4C 00 00 0p 0q FF	pq: Gain Position
	AE Gain Limit	8x 01 04 2C 0p FF	p: Gain Position (8 to E: 24db~42db)
CAM_Bright	Up	8x 01 04 0D 02 FF	--
	Down	8x 01 04 0D 03 FF	
	Direct	8x 01 04 4D 00 00 0p 0q FF	pq: Bright Position
CAM_ExpComp	Reset	8x 01 04 0E 00 FF	Exposure Comp Amount Setting
	Up	8x 01 04 0E 02 FF	
	Down	8x 01 04 0E 03 FF	
	Direct	8x 01 04 4E 00 00 0p 0q FF	pq: ExpComp Position
CAM_Backlight	On	8x 01 04 33 02 FF	Back Light Compensation ON/OFF
	Off	8x 01 04 33 03 FF	
CAM_LR_Reverse	On	8x 01 04 61 02 FF	Mirror Image ON/OFF
	Off	8x 01 04 61 03 FF	
CAM_Flip	On	8x 01 04 66 02 FF	Flip ON/OFF
	Off	8x 01 04 66 03 FF	
CAM_Preset	Reset	8x 01 04 3F 00 pp FF	Preset Cancel. pp: Preset Number 0x00~0xFF
	Set	8x 01 04 3F 01 pp FF	Preset Save.
	Recall	8x 01 04 3F 02 pp FF	Preset Load.
CAM_Menu	On	8x 01 06 06 02 FF	Menu Display ON/OFF
	Off	8x 01 06 06 03 FF	
	On/Off	8x 01 06 06 10 FF	
CAM_MenuEnter	--	8x 01 7E 01 02 00 01 FF	Enter Submenu
CAM_NR	--	8x 01 04 53 0p FF	p: Image NR Setting (0:OFF, Level1 to 3)
CAM_WDR	On	8x 01 04 3D 02 FF	Wdr ON/OFF

Command Set	Command	Command Packet	Comments
	Off	8x 01 04 3D 03 FF	
CAM_ICR	On	8x 01 04 01 02 FF	Infrared Mode ON (Night)
	Off	8x 01 04 01 03 FF	Infrared Mode OFF (Day)
CAM_AutoICR	On	8x 01 04 51 02 FF	Auto Infrared mode ON/OFF
	Off	8x 01 04 51 03 FF	
	Threshold	8x 01 04 21 00 00 0p 0q FF	pq: ICR OFF(Day)->ON(Night) threshold level 00: Low; 01: Middle; 02: High
CAM_IDWrite	--	8x 01 04 22 0p 0q 0r 0s FF	pqrs: Camera ID (=0000 to FFFF)
Video Format Change	--	8x 01 7E 01 1E 0p 0q FF	pq
			0x02: 1920x1080P/60
			0x03: 1920x1080P/59.94
			0x04: 1920x1080P/30
			0x05: 1920x1080P/29.97
			0x08: 1920x1080I/60
			0x0A: 1920x1080I/59.94
			0x0B: 1280x720P/60
			0x0C: 1280x720P/59.94
			0x0D: 1920x1080P/50
			0x18: 1920x1080P/25
			0x22: 1920x1080I/50
			0x26: 1280x720P/50
			0x30: 3840x2160P/60
			0x31: 3840x2160P/59.94
			0x32: 3840x2160P/50
			0x33: 3840x2160P/30
0x34: 3840x2160P/29.97			
0x35: 3840x2160P/25			
IR_Receive	On	8x 01 06 08 02 FF	Infrared remote commander reception ON
Pan-tilt Drive	Up	8x 01 06 01 VV WW 03 01 FF	VV: Pan speed setting 0x01 (low speed) to 0x18 (high speed) WW: Tilt speed setting 0x01 (low speed) to
	Down	8x 01 06 01 VV WW 03 02 FF	

Command Set	Command	Command Packet	Comments
	Left	8x 01 06 01 VV WW 01 03 FF	0x18 (high speed) YYYY: Pan Position 7FFF(170°) to 8000(-170°) (Normalized, CENTER 0000) ZZZZ: Tilt Position 7FFF(90°) to 8000(-30°) (Image Flip: OFF) (Normalized, CENTER 0000)
	Right	8x 01 06 01 VV WW 02 03 FF	
	UpLeft	8x 01 06 01 VV WW 01 01 FF	
	UpRight	8x 01 06 01 VV WW 02 01 FF	
	DownLeft	8x 01 06 01 VV WW 01 02 FF	
	DownRight	8x 01 06 01 VV WW 02 02 FF	
	Stop	8x 01 06 01 VV WW 03 03 FF	
	AbsolutePosition	8x 01 06 02 VV WW 0Y 0Y 0Y 0Y 0Z 0Z 0Z 0Z FF	
	RelativePosition	8x 01 06 03 VV WW 0Y 0Y 0Y 0Y 0Z 0Z 0Z 0Z FF	
	Home	8x 01 06 04 FF	
	Reset	8x 01 06 05 FF	
Freeze	Freeze On	8x 01 04 62 02 FF	Freeze On Immediately
	Freeze Off	8x 01 04 62 03 FF	Freeze Off Immediately
	Preset Freeze On	8x 01 04 62 22 FF	Freeze On When Running Preset
	Preset Freeze Off	8x 01 04 62 23 FF	Freeze Off When Running Preset
RTMP	On	8x 01 04 A2 02 FF	RTMP ON/OFF
	Off	8x 01 04 A2 03 FF	
Reboot	On	8x 01 04 A4 FF	System reboot
P/T Spd. Relative Zoom Ratio	On	8x 01 04 A6 02 FF	P/T Speed Relative Zoom Ratio ON/OFF
	Off	8x 01 04 A6 03 FF	
Factory Reset	System Factory Reset	8x 01 04 3F 03 00 FF	
Preset Speed	Set Preset Speed	8x 01 06 20 0p FF	p=1 (Low) to 6 (High)

Inquiry Command	Command Packet	Inquiry Packet	Comments
Inquiry Command	Command Packet	Inquiry Packet	Comments
CAM_PowerInq	8x 09 04 00 FF	y0 50 02 FF	On
		y0 50 02 FF	Off
CAM_ZoomPosInq	8x 09 04 47 FF	y0 50 0p 0q 0r 0s FF	pqrs: Zoom Position
CAM_FocusModelInq	8x 09 04 38 FF	y0 50 02 FF	Auto Focus
		y0 50 03 FF	Manual Focus
CAM_FocusPosInq	8x 09 04 48 FF	y0 50 0p 0q 0r 0s FF	pqrs: Focus Position
CAM_FocusNearLimitInq	8x 09 04 28 FF	y0 50 0p 0q 0r 0s FF	pqrs: Focus Near Limit Position
CAM_AFModelInq	8x 09 04 57 FF	y0 50 00 FF	Continuous AF ON
		y0 50 02 FF	Continuous AF OFF, only trigger AF after PTZ done
CAM_WBModelInq	8x 09 04 35 FF	y0 55 00 FF	Auto
		y0 55 04 FF	ATW
		y0 55 01 FF	Indoor
		y0 55 02 FF	Outdoor
		y0 55 03 FF	One Push WB
		y0 55 05 FF	Manual
CAM_RGainInq	8x 09 04 43 FF	y0 50 00 00 0p 0q FF	pq: R Gain
CAM_BGainInq	8x 09 04 44 FF	y0 50 00 00 0p 0q FF	pq: B Gain
CAM_AEModelInq	8x 09 04 39 FF	y0 50 00 FF	Full Auto
		y0 50 03 FF	Manual
		y0 50 0A FF	Shutter Priority
		y0 50 0B FF	Iris Priority
		y0 50 0D FF	Bright
CAM_SlowShutterModelInq	8x 09 04 5A FF	y0 50 02 FF	Auto
		y0 50 03 FF	Manual
CAM_ShutterPosInq	8x 09 04 4A FF	y0 50 00 00 0p 0q FF	pq: Shutter Position
CAM_IrisPosInq	8x 09 04 4B FF	y0 50 00 00 0p 0q FF	pq: Iris Position
CAM_GainPosInq	8x 09 04 4C FF	y0 50 00 00 0p 0q FF	pq: Gain Position
CAM_GainLimitInq	8x 09 04 2C FF	y0 50 0q FF	p: Gain Limit

Inquiry Command	Command Packet	Inquiry Packet	Comments
CAM_BrightPosInq	8x 09 04 4D FF	y0 50 00 00 0p 0q FF	pq: Bright Position
CAM_ExpCompPosInq	8x 09 04 4E FF	y0 50 00 00 0p 0q FF	pq: ExpComp Position
CAM_BacklightModeInq	8x 09 04 33 FF	y0 50 02 FF	On
		y0 50 03 FF	Off
CAM_LR_Reverse_Inq	8x 09 04 61 FF	y0 50 02 FF	On
		y0 50 03 FF	Off
CAM_Flip_Inq	8x 09 04 66 FF	y0 50 02 FF	On
		y0 50 03 FF	Off
CAM_NRIrq	8x 09 04 53 FF	y0 50 0p FF	p: NR Level
CAM_WDRInq	8x 09 04 3D FF	y0 50 02 FF	On
		y0 50 03 FF	Off
CAM_ICRModelInq	8x 09 04 01 FF	y0 50 02 FF	On (Night)
		y0 50 03 FF	Off (Day)
CAM_AutoICRModelInq	8x 09 04 51 FF	y0 50 02 FF	On
		y0 50 03 FF	Off
CAM_AutoICRThreshholdInq	8x 09 04 21 FF	y0 50 00 00 0p 0q FF	pq: ICR OFF(Day)->ON(Night) threshold level 00: Low; 01: Middle; 02: High
CAM_IDInq	8x 09 04 22 FF	y0 50 0p 0q 0r 0s FF	pqrs: Camera ID
CAM_VersionInq	8x 09 00 02 FF	y0 50 ab cd mn pq rs tu vw FF	abcd: Vendor Code, AVer: 2574 mnpq: Model Code, MD120UI: 0565 rstu: Firmware version (ex: 4025 for 1.1.4025.0) vw: Socket Number (=02)
CAM_MenuModelInq	8x 09 06 06 FF	y0 50 02 FF	On
		y0 50 03 FF	Off
Video Format Inq	8x 09 06 23 FF	y0 50 02 FF	1920x1080P/60
		y0 50 03 FF	1920x1080P/59.94
		y0 50 04 FF	1920x1080P/30
		y0 50 05 FF	1920x1080P/29.97
		y0 50 08 FF	1920x1080I/60
		y0 50 0A FF	1920x1080I/59.94
		y0 50 0B FF	1280x720P/60

Inquiry Command	Command Packet	Inquiry Packet	Comments
		y0 50 0C FF	1280x720P/59.94
		y0 50 0D FF	1920x1080P/50
		y0 50 18 FF	1920x1080P/25
		y0 50 22 FF	1920x1080I/50
		y0 50 26 FF	1280x720P/50
		y0 50 30 FF	3840x2160P/60
		y0 50 31 FF	3840x2160P/59.94
		y0 50 32 FF	3840x2160P/50
		y0 50 33 FF	3840x2160P/30
		y0 50 34 FF	3840x2160P/29.97
		y0 50 35 FF	3840x2160P/25
IR_Receive	8x 09 06 08 FF	y0 50 02 FF	On
		y0 50 03 FF	Off
Pan-tiltPosInq	8x 09 06 12 FF	y0 50 0Y 0Y 0Y 0Y 0Z 0Z 0Z 0Z FF	YYYY: Pan Position 7FFF(170°) to 8000 (-170°) (Normalized, CENTER 0000) ZZZZ: Tilt Position 7FFF(90°) to 8000(-30°) (Image Flip: OFF) (Normalized, CENTER 0000)
CAM_Preset_Inq	8x 09 04 3F FF	y0 50 pp FF	Return the last preset number which has been operated pp:01-FF
Pan-tiltMaxSpeedInq	8x 09 06 11 FF	y0 50 ww zz FF	ww = Pan Max Speed zz = Tilt Max Speed
Freeze_Mode_Inq	8x 09 04 62 01 FF	y0 50 02 FF	On
		y0 50 03 FF	Off
Preset_Freeze_Inq	8x 09 04 62 02 FF	y0 50 02 FF	On
		y0 50 03 FF	Off
RTMP_Inq	8x 09 04 A2 FF	y0 50 02 FF	On
		y0 50 03 FF	Off
Preset_Speed_Inq	8x 09 06 20 FF	y0 50 0p FF	p=1 (Low) to 6 (High)
Firmware version	8x 09 36 69 04 FF	y0 50 0p 0q 0r 0s 0t 0u 0v 0w FF	fw_ver: p.q.rstu.vw

VISCA Over-IP-Einstellungen

PORT

Internet protocol	IPv4
Transport protocol	UDP
Port address	52381

FORMAT

	byte 0	byte 1	byte 2	byte 3	byte 4	byte 5	byte 6	byte 7	byte 8 ~~~ byte 23
func	Payload type		Payload Length		Sequence number			Payload (1 to 16 bytes)	
data	Value1	Value2	1~16(0x0001~0x0010)		0x00000000 ~ 0xFFFFFFFF			VISCA Packet (see page VISCA)	

Payload type

Name	Value1	Value2	Description
VISCA command	0x01	0x00	Stores the VISCA command.
VISCA inquiry	0x01	0x10	Stores the VISCA inquiry.
VISCA reply	0x01	0x11	Stores the reply for the VISCA command and VISCA inquiry, or VISCA device setting command
VISCA device setting command	0x01	0x20	Stores the VISCA device setting command.
Control command	0x02	0x00	Stores the control command
Control reply	0x02	0x01	Stores the reply for the control command.

CGI-Befehl

CGI List for Video Transmission					
CGI item name	URL	Command	Parameter Name	Parameter value	Description
Get JPEG	/snapshot				1280x720 jpg
Get 4K JPEG	/cgi-bin?OnePush=n				Step 1: request 4k snapshot
	/snapshot?res=4k				Step 2: get 3840x2160 jpg
Get RTSP stream	rtsp://ip/live_st1				

CGI List for Audio					
CGI item name	URL	Command	Parameter Name	Parameter value	Description
Audio In Volume	/cgi-bin?Set=	ado_vol,3,N		0 ~10	0 ~ 10 volume

CGI List for Camera Control					
CGI item name	URL	Command	Parameter Name	Parameter value	Description
up start	/cgi-bin?SetPtf=	1,0,1			
up end	/cgi-bin?SetPtf=	1,0,2			
down start	/cgi-bin?SetPtf=	1,1,1			
down end	/cgi-bin?SetPtf=	1,1,2			
left start	/cgi-bin?SetPtf=	0,1,1			
left end	/cgi-bin?SetPtf=	0,1,2			
right start	/cgi-bin?SetPtf=	0,0,1			
right end	/cgi-bin?SetPtf=	0,0,2			
zoom_in start	/cgi-bin?SetPtf=	2,0,1			
zoom_in end	/cgi-bin?SetPtf=	2,0,2			
zoom_out start	/cgi-bin?SetPtf=	2,1,1			
zoom_out end	/cgi-bin?SetPtf=	2,1,2			
set preset:	/cgi-bin?ActPreset=	1,N			N : position
load preset:	/cgi-bin?ActPreset=	0,N			N : position

CGI List for Various Settings					
CGI item name	URL	Command	Parameter Name	Parameter value	Description
exposure value	/cgi-bin?Set=	img_expo_expo,3,N	value	1 ~ 9	N : value
saturation	/cgi-bin?Set=	img_saturation,3,N	value	0 ~ 10	N : value

contrast	/cgi-bin?Set=	img_contrast,3,N	value	0 ~ 4	N : value
Tracking on:	/cgi-bin?Set=	trk_tracking_on,3,1			
Tracking off:	/cgi-bin?Set=	trk_tracking_on,3,0			
Reboot	GET(Basic Authentication)	/cgi-bin?OnePush=!			
Factory Reset	GET(Basic Authentication)	/cgi-bin?OnePush=d			
RTMP Start streaming	/cgi-bin?Set=	vdo_rtmp_enable,3,1			
RTMP Stop streaming	/cgi-bin?Set=	vdo_rtmp_enable,3,0			
Status get (Model name & mac & FW_VER)	/cgi-bin?GetString=	sys_name&net_mac&sys_fw_version		http://10.100.105.110/cgi-bin?GetString=sys_name&net_mac&sys_fw_version	
Serial No. get	/cgi-bin?GetSerialNumber			http://10.100.105.110/cgi-bin?GetSerialNumber	
oneclick	/cgi-bin?Set=	ptz_oneclick_x,3,N1&ptz_oneclick_y,3,N2&ptz_oneclick_spd,3,N3		ptz_one_click_spd 1~24	N1, N2 = X, Y coordinates (1080P, 0,0 at top left) N3=moving speed
IR Cut Filter	/cgi-bin?Set=	img_ircut_filter,3,N		0 ~ 2	0 = Day, 1 = Night, 2 = Auto
IR Cut Filter Sensitivity	/cgi-bin?Set=	img_ircut_sensitivity,3,N		0 ~ 2	0 = Low, 1 = Middle, 2 = High

CGI List for AI Settings					
CGI item name	URL	Command	Parameter Name	Parameter value	Description
Eyes Tracking On/Off	/cgi-bin?Set=	trk_tracking_on,3,N	value	0 / 1	0: OFF; 1: ON
Tracking Preset	/cgi-bin?ActPreset=1,255				Save current pos. for eye tracking preset point.
Timeout to preset	/cgi-bin?Set=	trk_lost_time,3, N	value	3 / 5 / 7 / 10	timeout in seconds
Tracking Site	/cgi-bin?Set=	trk_mode,3,N	value	0 / 1	0: Full face; 1: Eyes
Tracking Range	/cgi-bin?Set=	trk_sensitivity,3,N	value	0 ~ 2	0: Close; 1: Medium; 2: Wide
Eyes Tracking On/Off Get	/cgi-bin?Get=trk_tracking_on				

	- Reply	On trk_tracking_on=1 Off trk_tracking_on=0			
Audio Detection On/Off	/cgi-bin?Set=	ado_det_alarm,3,N	value	0 / 1	0: OFF; 1: ON
Alarm Detection Type	/cgi-bin?Set=	ado_alm_general,3,N	value	0 / 1	general type. 0: OFF; 1: ON
		ado_alm_oxygen,3,N	value	0 / 1	oxygen type. 0: OFF; 1: ON
		ado_alm_ventilation,3,N	value	0 / 1	ventilation type. 0: OFF; 1: ON
		ado_alm_cardiovascular, 3,N	value	0 / 1	cardiovascular type. 0: OFF; 1: ON
		ado_alm_temperature,3, N	value	0 / 1	temperature type. 0: OFF; 1: ON
		ado_alm_drug,3,N	value	0 / 1	drug type. 0: OFF; 1: ON
		ado_alm_artificial,3,N	value	0 / 1	artificial type. 0: OFF; 1: ON
		ado_alm_power,3,N	value	0 / 1	power type. 0: OFF; 1: ON
		ado_alm_information,3, N	value	0 / 1	information type. 0: OFF; 1: ON

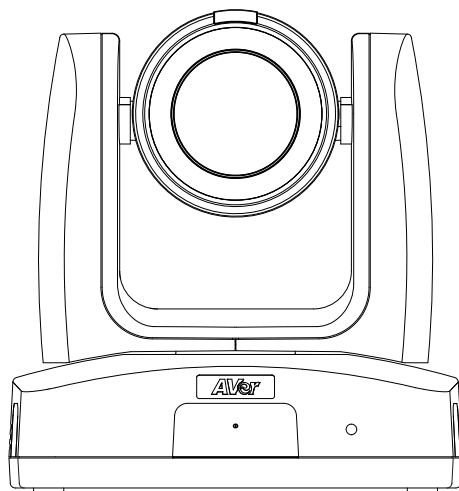

Caméra de suivi MD120UI

Mode d'emploi



Comment nettoyer et désinfecter

Avertissement Risque de blessure personnelle	N'utilisez pas de nettoyeurs contenant du phénol, car le phénol peut causer des brûlures cutanées s'il n'est pas suffisamment rincé et ne contient pas des propriétés de nettoyage ou de désinfection suffisantes.
Attention	<ol style="list-style-type: none">1. La caméra est conçue pour un nettoyage et une désinfection faciles.2. Avant de nettoyer la caméra, débranchez-la de la source d'alimentation.3. Les procédures de nettoyage ne doivent être effectuées que par un personnel familiarisé avec le fonctionnement de la caméra.4. Ne pulvérisez pas de liquide de nettoyage, en particulier de l'eau, dans les équipements électriques internes ou les parties de la caméra pour éviter les risques de court-circuit, de corrosion, de mauvais fonctionnement et de choc électrique pour les utilisateurs ou le personnel de service.5. Les nettoyeurs corrosifs peuvent causer la décoloration ou des dommages à la caméra. Avant d'utiliser un nettoyeur, testez-le dans une zone peu visible.
Quand	Nettoyez la caméra avant et après utilisation.
Étapes	<ol style="list-style-type: none">1. Débranchez la caméra de la source d'alimentation.2. Le personnel de nettoyage doit porter des gants de nettoyage.3. Avant d'utiliser de l'alcool de nettoyage, assurez-vous qu'il n'a pas expiré.4. Utilisez un chiffon de nettoyage imprégné d'alcool de nettoyage (75 %).5. Essuyez toutes les surfaces qui peuvent entrer en contact avec la caméra.6. Après avoir essuyé l'appareil, évitez le contact avec les mains nues.
Fréquence	Aucun nettoyage régulier n'est requis. Nettoyez avant et après utilisation.

Symboles sur le produit

Les symboles marqués sur ce produit, y compris sur les accessoires, représentent ce qui suit.

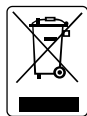

Le symbole des déchets électriques et électroniques (poubelle barrée).
Ce symbole indique que ce produit ne doit pas être mis au rebut avec les déchets ménagers. Il faut au contraire le remettre à un point de ramassage de déchets électriques et électroniques aux fins de recyclage. Pour de plus amples informations sur le lieu de dépôt de vos matériels à mettre au rebut aux fins de recyclage, consultez le service local de ramassage des déchets ou le magasin où vous avez acheté le produit.



Logo de conformité CE.
Ce logo indique que le produit est conforme aux lignes directrices et aux normes pertinentes de la législation d'harmonisation de l'Union européenne.



Logo de conformité FCC.
Ce logo indique que le produit est conforme aux normes de la Commission fédérale des communications des États-Unis.



Symbole UKCA (UK Conformity Assessed).
Ce symbole indique qu'un produit placé sur le marché britannique est conforme aux exigences du Royaume-Uni sur le marquage.



Logo de conformité RCM (Regulatory Compliance Mark).
Ce logo indique que le produit est conforme aux lignes directrices australiennes.



Ce logo a pour objet de prévenir les utilisateurs de la présence à l'intérieur du boîtier de « tension dangereuse » non isolée, suffisamment élevée pour constituer un risque d'électrocution.



Ce logo a pour objet de prévenir les utilisateurs de la présence d'instructions importantes sur l'utilisation et les interventions techniques dans les documents fournis avec l'appareil.



Le symbole de la RoHS chinoise.
Le chiffre de ce symbole représente le nombre d'années pendant lequel aucune substance dangereuse ne fuira ni ne se modifiera dans des conditions normales d'utilisation.



C'est le symbole du courant alternatif.
Il indique que le produit doit être alimenté en courant alternatif.



Symbole du courant continu.
Il indique que le produit doit être alimenté en courant continu.

Avertissement

Ce produit est de classe A. Dans un environnement domestique, ce produit peut provoquer des interférences radio. Dans ce cas, l'utilisateur peut se voir exiger d'adopter des mesures appropriées.

Cet appareil numérique de la classe A est conforme à la norme NMB-003 du Canada.

Information de sécurité sur les piles de la commande à distance

- Rangez les piles en un lieu frais et sec.
- Ne jetez pas les piles avec les ordures ménagères. Déposez-les aux points de collecte spécifiques ou rapportez-les au magasin, le cas échéant.
- Enlevez les piles en cas de non-utilisation prolongée. Une pile qui fuit peut corroder et endommager la commande à distance ; utilisez les batteries en sécurité.
- Ne mélangez pas, à l'usage, des piles neuves et non neuves.
- Ne mélangez pas, à l'usage, des piles de différents types : alcalines, standard (charbon-zinc) ou rechargeables (nickel-cadmium).
- Ne jetez pas les piles dans le feu.

AVIS DE NON-RESPONSABILITÉ

Il n'est offert aucune garantie et il n'est fait aucune déclaration, de manière expresse ni implicite, au sujet du contenu de ces documents, de leur qualité, de leur performance, de leur valeur marchande ni de leur adéquation à un usage en particulier. La fiabilité des informations présentées dans ce document a été soigneusement vérifiée ; cependant, aucune responsabilité n'est assumée concernant d'éventuelles inexactitudes. Les informations contenues dans ces documents sont passibles de modifications sans avis préalable.

En aucun cas AVer ne sera tenu responsable de dommages directs, indirects, accessoires ou immatériels découlant de l'utilisation ou de l'impossibilité d'utiliser ce produit ou cette documentation, même s'il a été prévenu de la possibilité de tels dommages.

MARQUES COMMERCIALES

« AVer » est une marque commerciale propriété d'AVer Information Inc. Les autres marques commerciales mentionnées dans ce document à seule fin descriptive appartiennent à leurs sociétés respectives.

COPYRIGHT

©2023 AVer Information Inc. Tous droits réservés. | 6 juillet 2023

Aucune portion de ce document ne peut être reproduite, transmise, enregistrée ou stockée dans un système de restitution, ni traduite en aucune langue que ce soit, par quelque moyen que ce soit, sans l'autorisation écrite préalable de AVer Information Inc.

Aide Supplémentaire

Pour la FAQ, l'assistance technique et le téléchargement du logiciel et du mode d'emploi, rendez-vous sur le site:

Centre de téléchargement: <https://www.avereurope.com/download-center>

Assistance Technique: <https://www.avereurope.com/technical-support>

Coordonnées de contact

AVer Information Europe B.V.

<https://www.avereurope.com>

Westblaak 134, 3012KM, Rotterdam, The Netherlands

Tel: +31 (0) 10 7600 550

Assistance technique: eu.rma@aver.com

Table des matières

Comment nettoyer et désinfecter	2
Vue d'ensemble	1
Contenu de l'emballage	1
Accessoires Optionnels	1
Dimensions	2
Montage au plafond	3
Montage mural	4
Angle Panoramique et d'Inclinaison	4
Installation	5
Plaque de fixation du câble	5
Montage au plafond	6
Connexion	7
Témoin d'intimité	7
LED Indicator	7
Connexion de l'appareil	8
Télécommande	11
Raccourcis	12
Configuration de la caméra	13
Menu sur écran (OSD)	13
Configuration de l'adresse IP	13
Arbre du menu OSD	15
Configuration Web	18
Accédez à l'interface Web de la caméra	18
Vue en direct (Live View)	20
Paramétrage de l'IA (AI Setting)	22
Paramètres de la camera (Camera Settings)	24
Vidéo et audio (Video & Audio)	26

Réseau (Network)	27
Système (System)	29
AVerCamera Setting Tool	31
Specification	32
Dépannage	35
Annexe.....	36
Tableau de commande VISCA RS-232	36
Paramètres VISCA sur IP	44
Commande CGI	45

Vue d'ensemble

La caméra de suivi MD120UI est une caméra de qualité médicale conçue pour la surveillance des patients. Elle assure la vision nocturne par infrarouges et son boîtier résiste aux UV.

Contenu de l'emballage

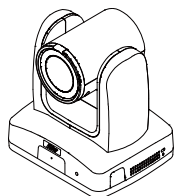

Caméra

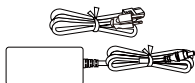

Adaptateur secteur & Cordon d'alimentation



Télécommande



Câble USB 3.0 Type-B vers Type-A (1.5 m)

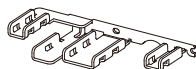

Plaques de fixation des câbles

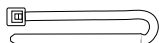

Attaches de câbles (x4)

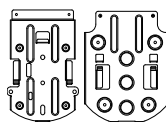

Support de montage au plafond (x2)

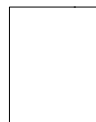

Gabarit de perçage



M2 x 4mm vis (x3)



M3 x 6mm vis (x3)



1/4''-20 L=6.5mm vis (x2)



Guide d'installation rapide

Accessoires Optionnels

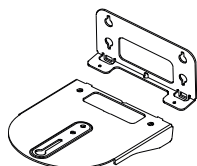

Montage mural

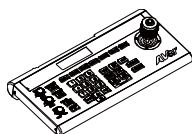

Contrôleur de la caméra (CL01)

Dimensions

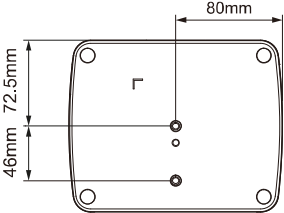
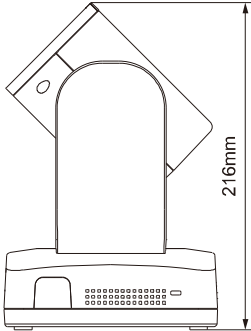
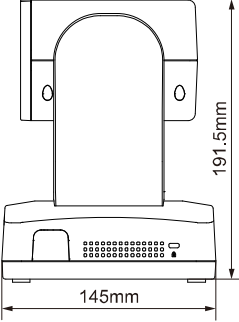
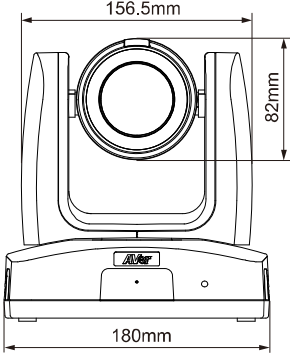

Montage au plafond

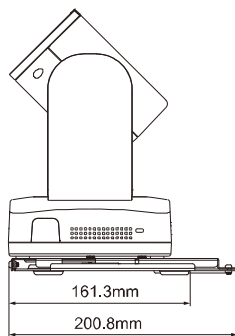
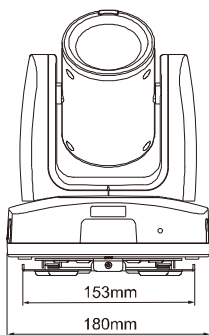
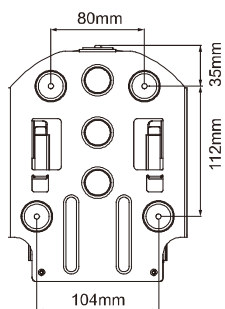
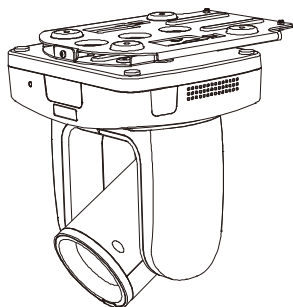

Montage mural

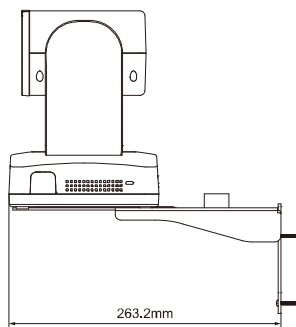
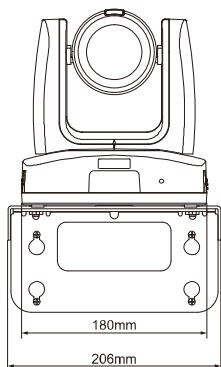
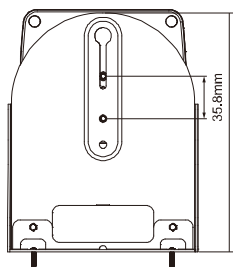
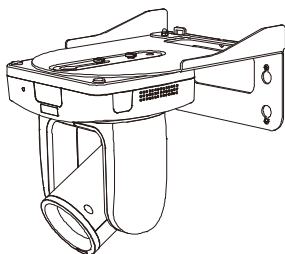
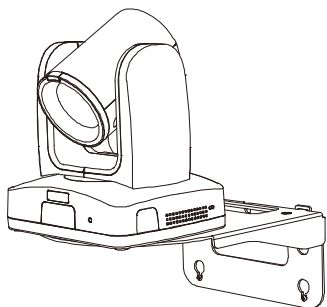

Angle Panoramique et d'Inclinaison

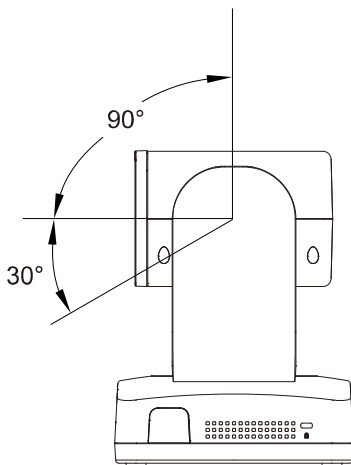
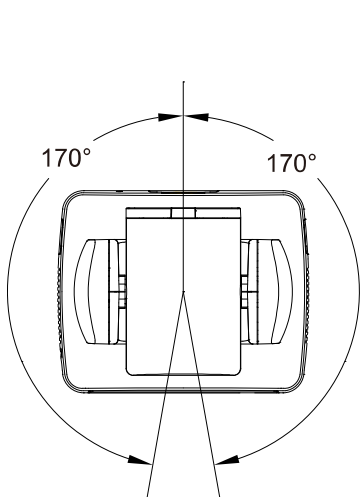

Installation

Plaque de fixation du câble

1. Fixez la plaque de fixation des câbles à la caméra à l'aide des vis M2 x 4 mm fournies dans l'emballage.

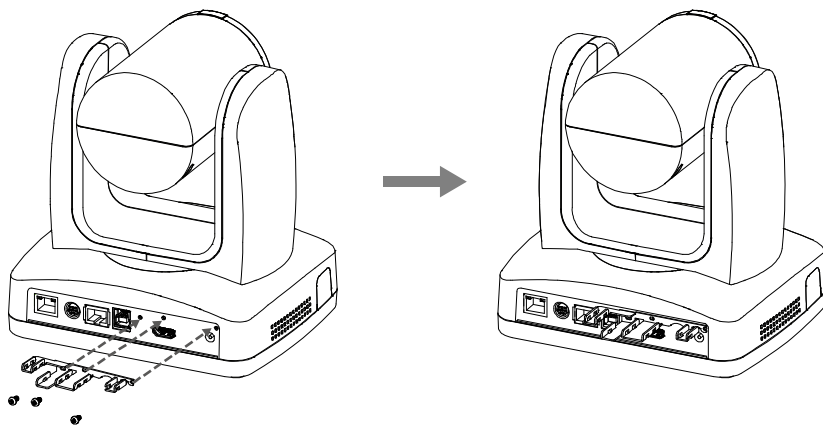

2. Branchez les câbles.

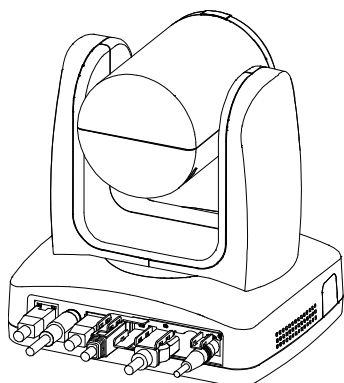

3. Fixez les câbles à la plaque de fixation du câble à l'aide de colliers de serrage à travers les fentes.

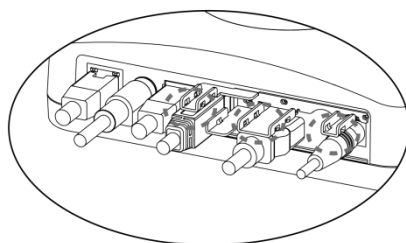

Montage au plafond

1. Fixez le support au plafond.
Vis : 4 vis M4 de 10 mm (non fournies)

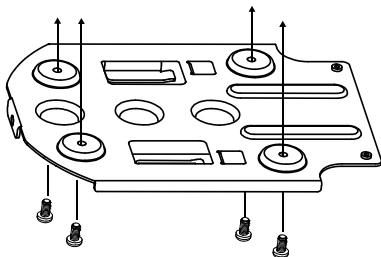

2. Fixez le support à la caméra.
Vis : 2 vis de 1/4"-20 (1/4 de pouce, 20 filets par pouce), L = 6,5 mm (fournies)

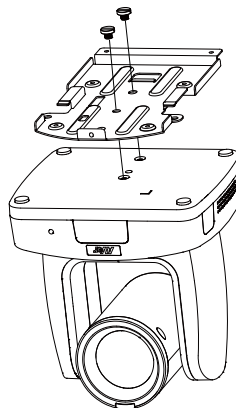

3. Faites glisser le support avec la caméra dans le support fixé au plafond. Et connectez les câbles.

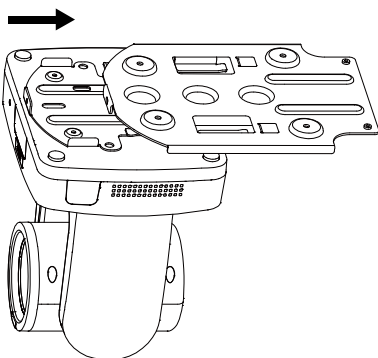

4. Fixez les supports avec des vis.
Vis : 3 vis M3 de 6 mm (non fournies)

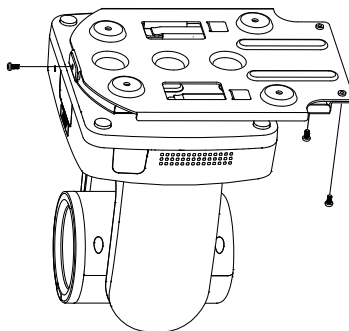

Connexion

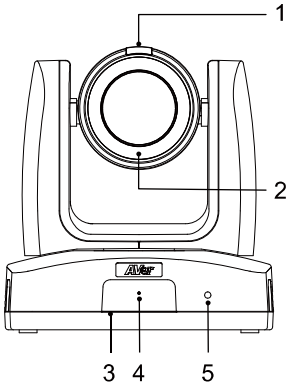

Vue frontale

1. Témoignage d'intimité
2. LED de vision nocturne par infrarouges*
3. Capteur IR
4. Micro
5. Indicateur LED

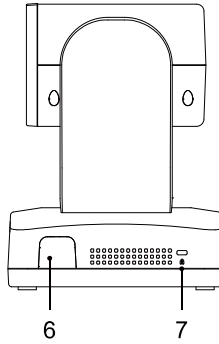

Vue latérale

6. Capteur IR
7. Dispositif antivol Kensington

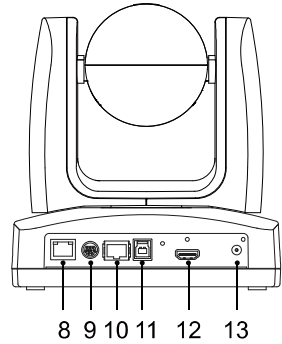

Vue arrière

8. Port PoE+
9. Port RS-232
10. Port RS-422
11. Port USB 3.1 de type-B
12. Port HDMI
13. Prise d'alimentation CC

*Pour éviter tout risque d'irradiation par infrarouges (IR), maintenez une distance supérieure à 1 mètre entre la LED IR et les yeux de toute personne quand vous utilisez le mode nocturne.

Témoignage d'intimité

Couleur	Statut
Vert fixe	Patient sous surveillance
Éteint	Mode d'intimité / hors tension

LED Indicator

Couleur	Statut
Bleu fixe	Normal
Bleu clignotant	Le suivi est activé
Orange fixe	Veille
Orange clignotant	Démarrage
Violet fixe	Le menu OSD est activé.
Violet clignotant	Mise à niveau du microprogramme en cours

Connexion de l'appareil

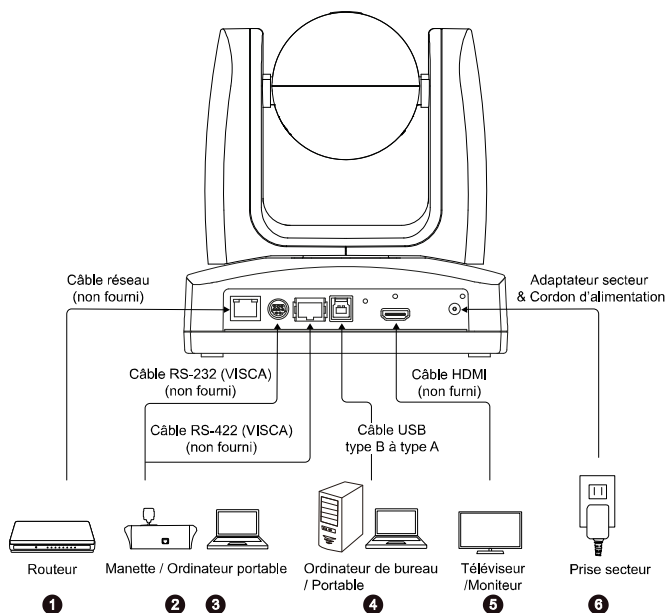

- LAN:** connectez la caméra à un routeur IP. (Remarque)
- RS-232:** connectez la caméra à une manette ou à un ordinateur portable pour la commander. Vous pouvez acheter en option un adaptateur RS-232. La définition des broches est illustrée ci-dessous. (Remarque)

- **Définition des broches**

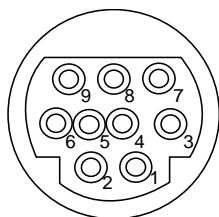

Fonction	Mini DIN9 broche #	Type d'E/S	Signal	Description
Entrée VISCA	1	Sortie	DTR	Terminal de données prêt
	2	Entrée	DSR	Jeu de données prêt
	3	Sortie	TXD	Transmission de données
	6	Entrée	RXD	Réception de données
Sortie VISCA	7	Sortie	DTR	Terminal de données prêt
	4	Entrée	DSR	Jeu de données prêt
	8	Sortie	TXD	Transmission de données
	9	Entrée	RXD	Réception de données
---	Bouclier	---	GND	Masse

3. **RS-422:** connectez la caméra à une manette ou à un ordinateur portable pour la commander.
 Pour connecter plusieurs caméras, utilisez un séparateur CAT5e.

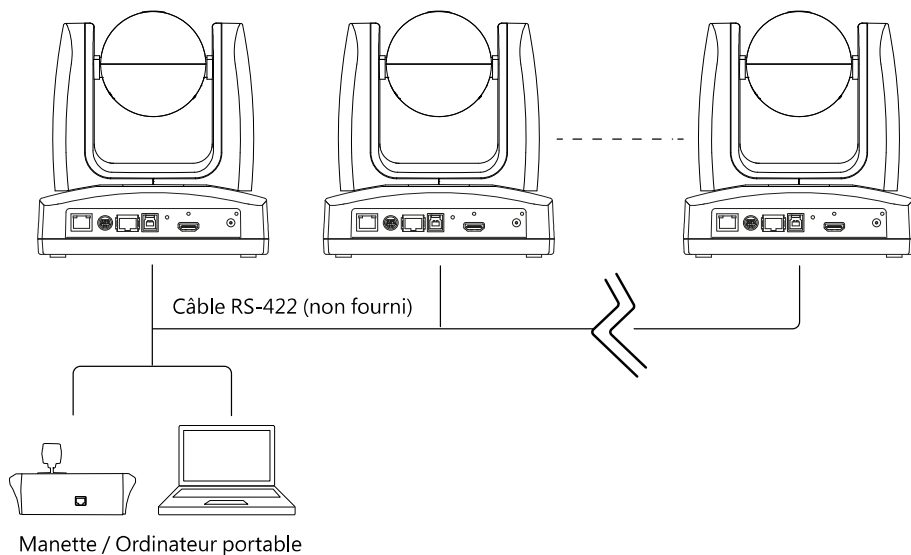

● **Définition des broches**

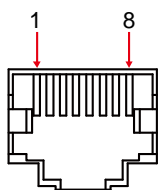

no	Broche	no	Broche
1	TX+	5	TX-
2	TX-	6	RX-
3	RX+	7	RX+
4	TX+	8	RX-

● **Affectation des broches du séparateur CAT5e**

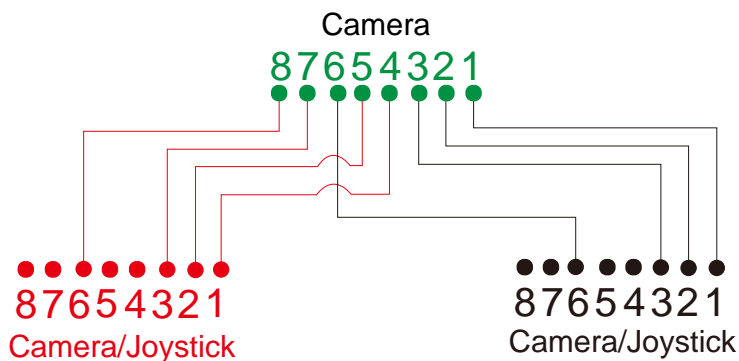

4. **USB Type-B:** connectez la caméra à un ordinateur de table ou portable pour transmettre de la vidéo, si vous utilisez un autre logiciel de visioconférence comme Skype ou Teams. (Remarque)
5. **HDMI:** connectez la caméra à un téléviseur ou à un moniteur pour afficher la sortie vidéo. La caméra et le téléviseur ou le moniteur connecté doivent avoir une conception de mise à la terre. (Remarque)
6. **Alimentation:** la caméra et le téléviseur ou le moniteur connecté doivent avoir une conception de mise à la terre. Utilisez l'adaptateur secteur et le cordon d'alimentation fournis pour brancher la caméra sur une prise secteur, et vérifiez que le cordon d'alimentation du poste TV ou du moniteur prend en charge la broche de terre.

Remarque :

Tout matériel accessoire connecté aux interfaces analogique ou numérique doit être conforme aux normes nationales IEC harmonisées (c.-à-d., IEC 60950 pour les appareils de traitement de données, IEC 60065 pour les appareils vidéo, IEC 61010-1 pour les appareils de laboratoire, ou IEC 60601-1 pour les appareils médicaux). Toutes les configurations doivent en plus être conformes aux exigences du système selon la norme IEC 60601-1. Toute personne qui connecte du matériel supplémentaire à l'entrée ou à la sortie de signal configure un système médical, et est donc responsable de la conformité de ce système aux exigences de la norme IEC 60601-1. Cet appareil ne doit être connecté qu'avec des matériels certifiés IEC 60601-1 dans des environnements avec présence de patients, ou certifiés IEC 60XXX dans des environnements sans présence de patients. Dans le doute, consultez la section des services techniques de votre représentant local.

Télécommande

La télécommande fonctionne avec deux piles de catégorie AAA. Assurez-vous que les piles sont correctement installées avant toute utilisation.

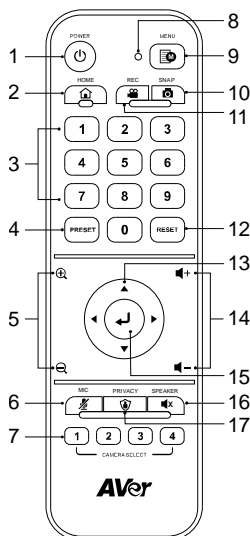







Model: LY033

Nom	Fonction
1. M/A	Appuyez brièvement pour activer ou désactiver le mode veille.
2. Position de repos	Déplacez la caméra jusqu'à la position de repos.
3. Boutons numériques	<ul style="list-style-type: none"> ● Appuyez sur les boutons de 0 à 9 pour déplacer la caméra jusqu'aux positions pré-réglées. ● Utilisez ces boutons pour définir des positions pré-réglées de 0 à 9.
4. Pré-réglages	<p>Utilisez le bouton Pré-réglage, les boutons numériques et les boutons directionnels pour configurer des positions pré-réglées.</p> <ol style="list-style-type: none"> 1. Utilisez les boutons numériques pour naviguer parmi les positions. En option, utilisez les boutons « Zoom + » et « Zoom - » pour faire des zooms avant et arrière sur l'image. 2. Appuyez et maintenez Pré-réglage, puis sur les boutons numériques (de 0 à 9) pour enregistrer la position pré-réglée.
5. Zoom AV/AR	Appuyez pour faire des zooms avant ou arrière sur les images.
6. Micro	Appuyez pour couper le micro. Réappuyez pour le réactiver.
7. Sélecteur de caméra	Sélectionnez une caméra pour l'utiliser. Spécifiez un numéro dans le menu OSD : System > Camera Selector.
8. LED de la télécommande	Quand vous appuyez sur les boutons de la télécommande, la LED s'éclaire en rouge.
9. Menu	Maintenez appuyé pendant 3 secondes pour ouvrir le menu OSD. Modifiez ce paramètre dans le menu OSD : System > Trigger OSD.
10. Instantané	N/A

11.Vidéo	N/A
12.Réinitialisation	Utilisez les boutons de réinitialisation et les boutons numériques pour annuler une position préréglée préconfigurée. Appuyez et maintenez Préréglage, puis sur les boutons numériques (de 0 à 9).
13.Boutons directionnels	Utilisez les boutons directionnels pour naviguer sur l'image en direct.
14.Volume +/-	N/A
15.Entrée	Lorsque l'appareil photo est allumé : appuyez sur Entrée pour régler une fois la mise au point. Lors de l'accès au menu OSD: Appuyez sur Entrée pour confirmer la sélection ou effectuer une sélection.
16.Haut-parleur	N/A
17.Intimité	Appuyez pour entrer dans le mode Intimité. La caméra se déplacera jusqu'à la position Intimité et le micro sera coupé.

Raccourcis

Appuyez sur	Pour
Menu  pendant 3 secondes	Ouvrir le menu OSD
Menu 	Fermer le menu OSD.
Page d'accueil 	Fermer le menu OSD et ramener la caméra à la position de repos.
Menu  puis Zoom 	Commuter entre les modes jour et nuit.
Menu  puis Zoom 	Commuter entre les modes jour et automatique.
5 fois 5 (55555)	Activation du DHCP.
6 fois 6 (666666)	Rétablissement des paramètres d'usine de la caméra.
8 fois 8 (88888888)	Définir l'adresse IP statique de la caméra comme 192.168.1.168.

Configuration de la caméra

La caméra peut être paramétrée depuis le menu OSD ou depuis son interface Web.

Menu sur écran (OSD)

Pour accéder au menu OSD, connectez la caméra à un moniteur ou à un poste TV à l'aide du câble HDMI. Vous pourrez alors utiliser le menu OSD depuis la télécommande fournie.

Appuyez sur le bouton **Menu**  pendant 3 secondes de la télécommande pour ouvrir le menu OSD et utilisez les boutons ▲▼◀▶ pour sélectionner parmi les pages et les options, et appuyez sur ↵ pour confirmer les paramètres.

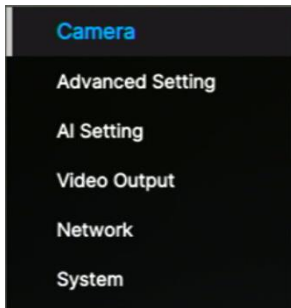

Configuration de l'adresse IP

Static IP

1. Appuyez sur le bouton Menu de la télécommande pour ouvrir le menu OSD.
2. Allez à **Network > Static IP**.

[Remarque] Éteignez le **DHCP** avant de configurer l'IP statique (**Network > DHCP > OFF**).

3. Sélectionnez **IP Address**, **Gateway**, **Netmask**, et **DNS** pour configurer. Appuyez sur ↵ et utilisez les boutons numériques pour saisir la valeur.

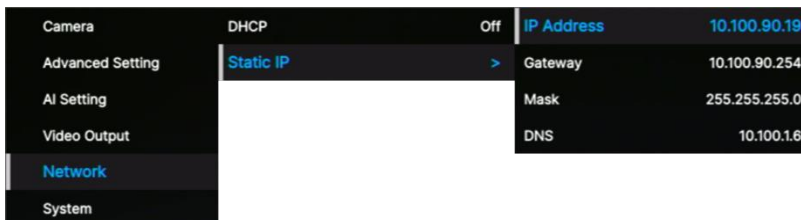

DHCP

1. Appuyez sur le bouton Menu de la télécommande pour ouvrir le menu OSD.
2. Sélectionnez **Network > DHCP > On**.
3. Appuyez sur **↩** pour confirmer les paramètres.



4. Après avoir activé le **DHCP**, vous pouvez aller à **System > Information** pour voir l'adresse IP.

Camera	Trigger OSD	Press Menu 3 sec	Model Name	MD120UI
Advanced Setting	Camera Selector	All	Serial Number	5100435000010
AI Setting	Status OSD	Off	Version	1.10502.0
Video Output	Language	English	IP Address	0.0.0.0
Network	Information	>	MAC	00:18:1A:0C:BA:4E
System	Factory Default	>	Lens	C004
	System Reboot	>	Mcu	A001

Arbre du menu OSD

1er niveau	2ème niveau	3ème niveau	4ème niveau
Camera	Exposure Mode	Full Auto	Exposure Value
			Gain Limit Level
			Slow Shutter
			BLC
			WDR
		Shutter Priority	Exposure Value
			Shutter Speed
			Gain Limit Level
		Iris Priority	Exposure Value
			Iris Level
			Gain Limit Level
			Slow Shutter
		Manual	Iris Level
			Shutter Speed
			Gain Level
		Bright mode	Bright value
	White Balance	Auto	
		ATW	
		Indoor	
		Outdoor	
		One push trigger	
		Manual	R gain
	B gain		
	Pan Tilt Zoom	Preset Speed	5, 25, 50, 100, 150, 200
		Preset Accuracy	Off / On
		Pan Speed	1~24
		Tilt Speed	1~24
		Zoom Speed	Low / High
		P/T Spd. Relative Z Ratio	Off / On
		Pan L/R Dir. Switch	Off / On

	Noise filter	Off / Low / Middle / High	
	Saturation	0 1 2 3 4 5 6 7 8 9 10	
	Contrast	0 1 2 3 4	
	Sharpness	0 1 2 3	
	Mirror	OFF / ON	
	Flip	OFF / ON	
Advanced Setting	Audio	Audio Volume	0~10
	Control	Type	RS232 / RS422
		Protocol	VISCA
		Camera Address	1 2 3 4 5 6 7
		Baud Rate	4800 / 9600 / 38400
	IR Cut Filter	Auto / Day / Night	
IR Cut Sensitivity	Low / Middle / High		
AI Setting	Facial Tracking	Eyes Tracking	On/Off
		Tracking Preset	Save
		Tracking Site	Full Face / Eyes
		Tracking Range	Close / Medium / Wide
		Timeout to Preset	3/5/7/10 sec
	AI Audio Detection	Audio Detection	On/Off
Video Output	Theme Mode	HDMI / UVC	
	Frequency	60	
		59.94	
		50	
	Resolution	2160p60	
		2160p59	
		2160p50	
		2160p30	
		2160p29	
		2160p25	
		1080p60	
		1080p59	
	1080p50		

		1080p30	
		1080p29	
		1080p25	
		1080i60	
		1080i59	
		1080i50	
		720p60	
		720p59	
		720p50	
Network	DHCP	OFF	
		ON	
	Static IP	IP Address	192.168.1.168
		Gateway	192.168.1.254
		Mask	255.255.255.0
DNS	8.8.8.8		
System	Trigger OSD	Click Menu to open, Press Menu 3 sec	
	Camera Selector	1,2,3,4,All channel, Disable Remote	
	Status OSD	OFF	
		ON	
	Language	English / 中文 / 日本語	
	Information	Model Name	MD120UI
		Serial number	xxxxxxxxxxxxx
		Firmware Version	0.0.0000.00
		IP	192.168.1.168
		MAC	00:18:1a:04:9e:81
		Lens	xxxx
Mcu	xxxx		
Factory Default	Off / On		
System Reboot	Off / On		

Configuration Web

Connectez la caméra depuis un site distant via Internet.

Accédez à l'interface Web de la caméra

Pour accéder à l'interface Web de la caméra, vous devez trouver son adresse IP à l'aide des logiciels **Aver IPCam Utility** ou **Aver PTZ Management**.

Accès à la caméra via Aver IPCam Utility

Pour trouver l'adresse IP de vos caméras à l'aide de l'assistant d'installation d'utilitaires IPCam, suivez les étapes ci-dessous.

1. Téléchargez l'utilitaire IPCam Utility depuis <https://www.aver.com/download-center> et exécutez-le. IPCam Utility.
2. Cliquez sur « **Rechercher** », et la liste de tous les périphériques disponibles s'affichera sur l'écran.
3. Sélectionnez une caméra dans la liste, et les informations sur celle-ci s'afficheront dans le champ Paramètres.

[Remarque] Le réseau par défaut de la caméra est l'IP statique (192.168.1.168) ; l'identifiant et le mot de passe par défaut sont **admin/admin**. Si vous voulez configurer le réseau sur le protocole DHCP, saisissez l'identifiant et le mot de passe dans le champ **Login**, sélectionnez dans la liste le « **Modèle de la caméra** », sélectionnez «DHCP» puis cliquez sur le bouton **Apply**.

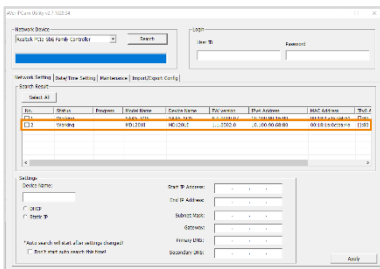

4. Pour accéder à l'interface Web, double-cliquez sur l'adresse IP dans la colonne des adresses IPv4. Si vous utilisez l'appareil pour la première fois, une fenêtre de connexion vous invitera à modifier l'identifiant et le mot de passe.

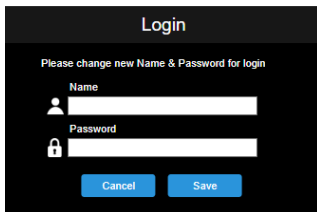

5. Connectez-vous avec le nouvel identifiant et le nouveau mot de passe ; l'interface Web de la caméra s'affichera (navigateur Chrome). Consultez la section <Vue en direct> pour de plus amples détails.

[Remarque] Si l'utilitaire IPCam ne trouve pas la caméra, vérifiez ce qui suit:

1. Que le câble Ethernet de la caméra est bien connecté.
2. Que la caméra et l'ordinateur (IPCamUtility) sont sur le même segment LAN.

Accès à la caméra via AVer PTZ Management

Pour trouver l'adresse IP de vos caméras à l'aide d'AVer PTZ Management, suivez les étapes ci-dessous.

1. Téléchargez le logiciel AVer PTZ Management depuis <https://www.aver.com/download-center>
2. Téléchargez le programme Windows et installez-le.
3. Après avoir paramétré l'identifiant d'utilisateur et le mot de passe, connectez-vous au logiciel (nom d'utilisateur et mot de passe par défaut : admin/admin).

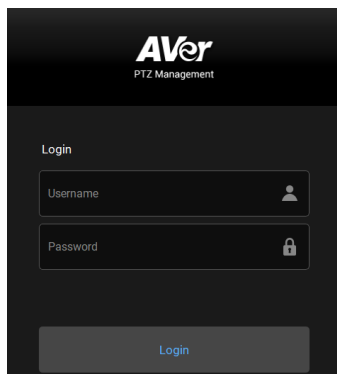

4. Sur la page principale de PTZ Management, cliquez sur **Setup > Add** puis sur **Auto Search**. Les caméras du même LAN connectées à l'ordinateur s'afficheront.

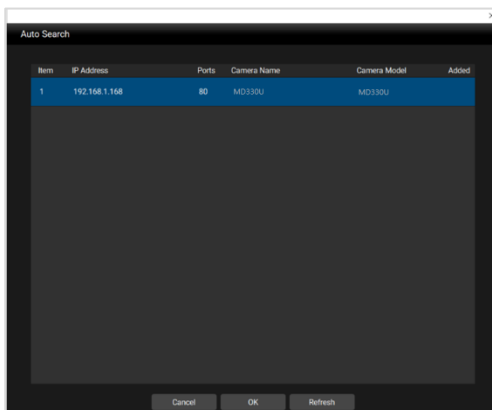
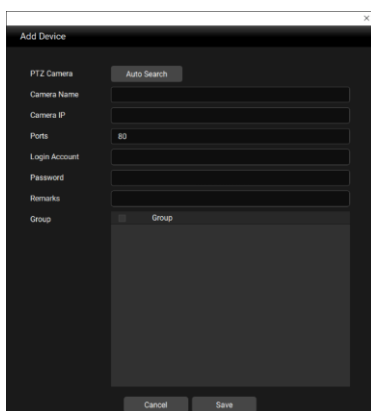

5. Cliquez sur la caméra et saisissez l'identifiant de celle-ci et le mot de passe pour ajouter la caméra à la liste des périphériques (l'identifiant et le mot de passe par défaut sont **admin/admin**). Cliquez sur le bouton **Go to Web** pour accéder à l'interface Web de la caméra.

Vue en direct (Live View)

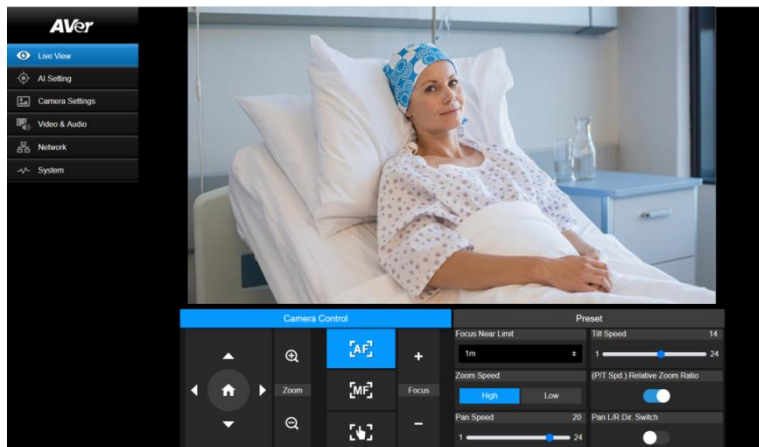

Commandes de la camera (Camera Control)

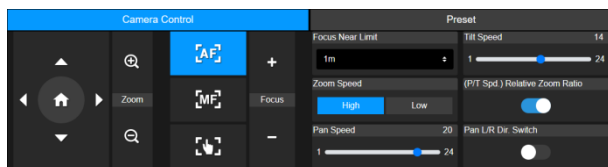

Élément	Description
<p>Commandes des pans horizontal et vertical</p>	<p>Positionner la caméra.</p> <ul style="list-style-type: none"> ● Déplacez la glissière pour régler la Pan Speed et la Tilt Speed. ● Activer Pan L/R Dir. Switch pour inverser la direction du panoramique. ● Activer P/T Spd. Relative Z Ratio pour régler automatiquement la vitesse des pans horiz. et vert. en fonction du rapport de zoom. <p>Vous pouvez aussi l'activer depuis le menu OSD : Camera > Pan Tilt Zoom > P/T Spd. Relative Z Ratio.</p>
<p>Position de repos </p>	<p>Déplacer la caméra jusqu'à la position de repos.</p>
<p>Zoom </p>	<p>Vue en direct de zoom AV et AR, et sélection de la Zoom Speed.</p>
<p>Focus +- </p>	<ul style="list-style-type: none"> ● Auto Focus : cliquez pour mise au point automatique. ● Manual Focus : cliquez pour mise au point manuelle. <p>Mise au point à l'aide des boutons +et -.</p> <ul style="list-style-type: none"> ● One Push Focus : cliquez pour mettre au point

automatiquement une fois.

- **Focus Near Limit** : définir la limite proche de mise au point.

Préréglages (Preset)

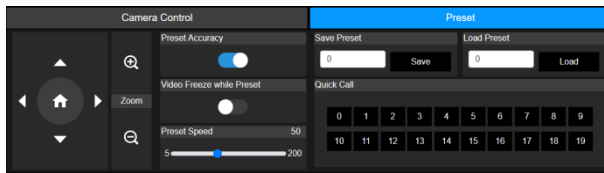

Élément	Description
Save Preset	<ol style="list-style-type: none">1. Positionnement de la caméra à l'aide des commandes de panos H et V et du zoom.2. Saisissez un numéro de préréglage (de 0 à 255) dans le champ Save Preset, puis cliquez sur Save.
Load Preset	<ol style="list-style-type: none">1. Saisissez un numéro de préréglage (de 0 à 255) dans le champ Load Preset, puis cliquez sur Load.2. Ou bien, cliquez sur un numéro de préréglage dans la section Quick Call.
Preset Accuracy	Activez pour améliorer la précision des déplacements vers les préréglages.
Video Freeze while Preset	Activez pour n'afficher que la vue en direct des préréglages. La vue en direct du chemin en mouvement ne s'affichera pas.
Preset Speed	Réglez la vitesse des déplacements de la caméra vers les préréglages.

Paramétrage de l'IA (AI Setting)



Suivi des yeux (Eyes Tracking)

Si vous réglez manuellement les panos ou le zoom pendant le suivi des yeux, ce dernier se désactive.

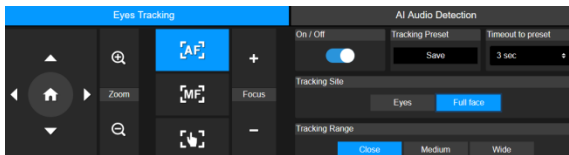

1. Positionnez la caméra à l'aide des commandes de pano horizontal et vertical et de zoom, puis cliquez sur **Save** pour enregistrer un **Tracking Preset**. La position par défaut est celle de repos.
2. Dans la liste déroulante **Timeout to preset**, sélectionnez un délai avant que la caméra retourne au préréglage de suivi lorsqu'il n'y a personne en vue. Le délai par défaut est de 3 secondes.
3. Cliquez sur l'interrupteur basculant **On/Off** pour activer le suivi des yeux lorsqu'un visage est en vue.
 - Une personne : la caméra suivra automatiquement le visage et y fera un zoom avant.
 - Plusieurs personnes : la caméra affichera des carrés autour des visages. Sélectionnez un visage à suivre automatiquement en cliquant sur l'un des carrés.
4. Choisissez le **Tracking Site** et la **Tracking Range**.

(Beta) Détection audio par IA ((Beta) AI Audio Detection)

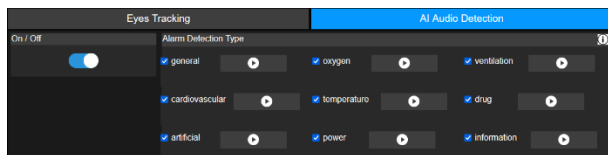

1. Activez pour détecter des alarmes sélectionnées.
2. Cliquez sur le bouton de lecture pour écouter les sons d'alarme.

Paramètres de la camera (Camera Settings)



Exposition (Exposure)

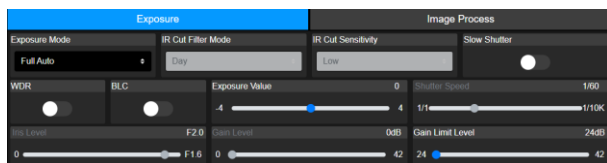

Élément	Description
Exposure Mode	Sélectionnez un mode d'exposition.
WDR	Activez ou désactivez WDR ou BLC .
BLC	
Exposure Value	Réglez l'exposition, l'obturateur, le diaphragme et le gain.
Shutter Speed	
Iris Level	
Gain Level	
Gain Limit Level	
IR Cut Filter Mode	Sélectionnez le mode Day ou le mode Night pour activer o désactiver la vision nocturne par infrarouges, ou bien sélectionnez le mode Auto et réglez la IR Cut Sensitivity .
Slow Shutter	Activez ou désactivez Slow Shutter .

Traitement de l'image (Image Process)

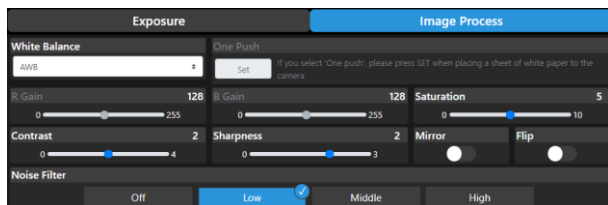

Élément	Description
White Balance	<ul style="list-style-type: none">● Sélectionnez un mode de balance des blancs. Si vous sélectionnez Manual, vous pouvez régler aussi le R Gain et le B Gain.● Si vous sélectionnez One Push, mettez une feuille blanche en face de l'objectif et cliquez sur Set pour régler la balance des blancs.
Saturation	
Contrast	Réglez la saturation, le contraste et la netteté.
Sharpness	
Mirror	
Flip	Activez ou désactivez Mirror et Flip .
Noise Filter	Sélectionnez un niveau de filtrage du bruit.

Vidéo et audio (Video & Audio)

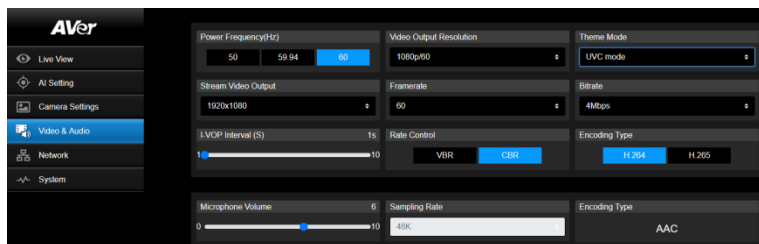

Paramétrage vidéo

Élément	Description
Power Frequency (Hz)	Sélectionnez 50 Hz , 59,94 Hz ou 60 Hz selon la fréquence du courant secteur dans votre pays ou région.
Video Out Resolution	Sélectionnez une résolution de sortie vidéo. RTSP : max. 4K / 60 i/s HDMI : max. 4K / 60 Hz
Theme Mode	Sélectionnez une superposition vidéo pour prioriser la sortie UVC ou HDMI.
Stream Video Output	Sélectionnez une résolution de sortie de diffusion pour la vue en direct.
Framerate	Sélectionnez une cadence
Bitrate	Sélectionnez un débit binaire
I-VOP Interval (S)	<ul style="list-style-type: none">● Déplacez la glissière pour choisir combien souvent des I-VOP apparaissent dans un flux vidéo.● Des intervalles plus brefs entre les I-VOP assurent une meilleure qualité vidéo, mais les fichiers sont plus volumineux.
Rate Control	Sélectionnez VBR ou CBR .
Encoding Type	Sélectionnez H.264 ou H.265 .

Paramétrage audio

Élément	Description
Microphone Volume	Déplacez la glissière pour régler le volume du micro.
Sampling Rate	48K
Encoding Type	AAC

Réseau (Network)

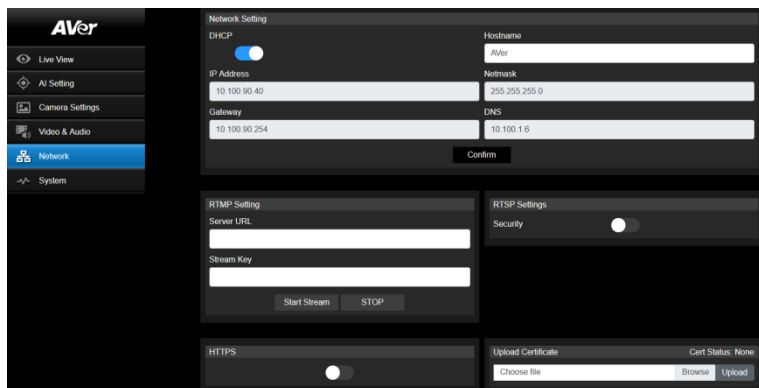

Élément	Description
Hostname	le nom d'hôte par défaut est AVer. Modifiez le nom d'hôte à afficher sur des appareils tels qu'un routeur IP.
DHCP	Définissez le réseau comme DHCP ou comme IP statique. <ul style="list-style-type: none">● DHCP : activez DHCP et cliquez sur Confirm pour enregistrer le paramètre. La caméra se verra affecter des paramètres IP automatiquement.● IP statique : désactivez DHCP, saisissez une IP Address, un Netmask, une Gateway et un DNS, puis cliquez sur Confirm pour enregistrer les paramètres.
RTMP Setting	Diffusez de la vidéo en direct vers une plateforme telle que YouTube. <ol style="list-style-type: none">1. Saisissez la Server URL et la Stream Key de votre plateforme vidéo. Reportez-vous aux instructions de la plateforme de diffusion que vous utilisez pour obtenir l'URL du serveur et la clé de diffusion.2. Cliquez sur Start Stream pour commencer à diffuser, et sur Stop pour arrêter.

RTSP Settings

Protégez votre flux vidéo sur les lecteurs multimédia comme VLC, PotPlayer ou QuickTime, en assurant que seuls les utilisateurs autorisés y aient accès.

- Si **Security** est désactivé :
 1. Saisissez l'URL du RTSP de votre caméra dans le lecteur multimédia.
 2. URL du RTSP : `rtsp://[adresse IP de la caméra]/live_st1`
Exemple : `rtsp://192.168.1.100/live_st1`

- Si **Security** est activé :
 1. Saisissez l'URL du RTSP de votre caméra dans le lecteur multimédia.
 2. URL du RTSP : `rtsp://[nom d'utilisateur:mot de passe]@[adresse IP de la caméra]/live_st1`
Exemple : `rtsp://1:1@192.168.1.100/live_st1`
 3. nom d'utilisateur/mot de passe : nom d'utilisateur/mot de passe de la caméra (connexion à l'interface Web)

HTTPS

Activez HTTPS pour établir une connexion sécurisée entre votre navigateur et votre caméra. Pour obtenir l'accès à HTTPS sur votre caméra :

1. Obtenez un certificat SSL pour le chiffrement et le déchiffrement au format encodé en base 64, et utilisez une clé privée au format PKCS#8 (non chiffrée).
 2. Rassemblez le contenu du certificat requis au format PEM. Le certificat SSL téléchargé dans la caméra doit être au format PEM.
 3. Cliquez sur **Browse** pour sélectionner le fichier du certificat, puis cliquez sur **Upload**.
 4. Activez HTTPS.
-

Système (System)

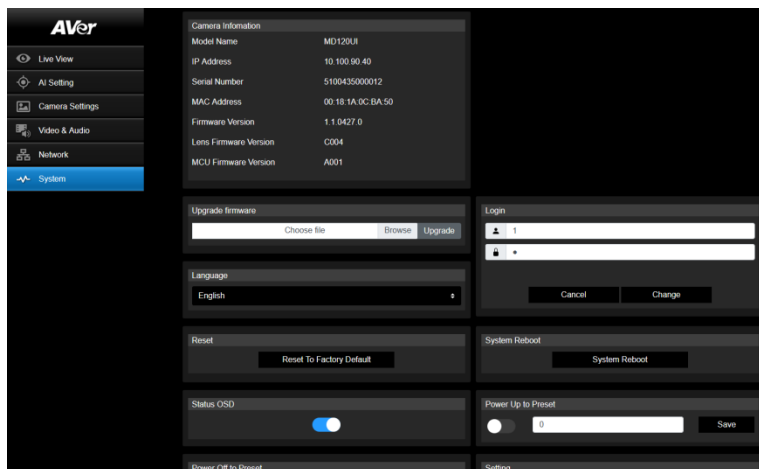

Élément	Description
Camera Information	Afficher les informations sur la caméra.
Upgrade Firmware	<p>Suivez les étapes ci-dessous pour mettre à niveau le microprogramme.</p> <ol style="list-style-type: none">1. Téléchargez le dernier microprogramme depuis le centre de téléchargement AVer (https://www.aver.com/download-center/).2. Sur la page Web, allez à System > Upgrade firmware.3. Cliquez sur Browse pour sélectionner le microprogramme.4. Cliquez sur Upgrade pour commencer la mise à niveau du microprogramme.5. Actualisez le navigateur une fois le processus de mise à jour terminé. <p>[Remarque] Laissez la caméra branchée sur une source d'alimentation pendant la mise à niveau du microprogramme. La connexion au réseau sera perdue au cours du processus et la caméra redémarrera automatiquement après la mise à niveau.</p>
Login	Le nom d'utilisateur et le mot de passe par défaut sont admin/admin . Pour modifier le nom d'utilisateur ou le mot de passe, saisissez le nouveau nom ou le nouveau mot et cliquez sur Change .
Language	Modification de la langue de l'IU Web.

Reset	Rétablissement des paramètres d'usine de la caméra.
System Reboot	Redémarrage de la caméra.
Status OSD	Activez l'affichage du statut des préréglages sur la sortie HDMI au cours des fonctions telles que l'enregistrement, le chargement et l'annulation des préréglages.
Power Up to Preset	Si ceci est activé, la caméra ira à la position définie dès sa mise sous tension. <ul style="list-style-type: none"> ● Cliquez sur l'interrupteur basculant pour activer > saisissez un numéro de préréglage > cliquez sur Save. ● Vérifiez que le numéro de préréglage a bien été défini avant d'activer cette fonction.
Power Off to Preset	Si elle est activée, la caméra ira à la position définie avant sa mise hors tension. <ul style="list-style-type: none"> ● Cliquez sur l'interrupteur basculant pour activer > saisissez un numéro de préréglage > cliquez sur Save. ● Vérifiez que le numéro de préréglage a bien été défini avant d'activer cette fonction.
Setting	Exportation ou importation de vos paramètres caméra
Help Us Improve	Acceptation o refus de fournir des données d'utilisation anonymes.

AVerCamera Setting Tool

L'outil de configuration (AVerCamera Setting Tool) est une application logicielle qui prend en charge le fonctionnement des caméras PTZ AVer quand vous diffusez vers un logiciel de tiers. Il permet aux utilisateurs de configurer les paramètres photo, son et vidéo sans télécommande, ainsi que de connecter la caméra par USB.

- Téléchargez l'outil AVerCamera Setting Tool depuis le site Web d'Aver:
(<https://www.aver.com/Downloads/search?q=AVer%20Camera%20Setting%20Tool>).
- Pour plus de détails sur les paramètres, consultez au chapitre <AVerCamera Setting Tool> dans le mode d'emploi de l'application CaptureShare.

Specification

Caméra	
Capteur d'image	CMOS de 1/2,8 pouce
Éléments image efficaces	8 mégapixels
Résolutions en sortie	Résolution : 4K/1080p/720p Cadences : 60/59,94/50/30/29,97/25
Éclairage minimal	0,5 lux (50 IRE, f:1,6, AGC max., 1/30e)
Rapport signal/bruit	≥50 dB
Gain	Automatique ou manuel
Lignes TV	1000 (centrées/écran large)
Vitesse d'obturation	De 1 seconde à 1/10 000e de seconde
Contrôle de l'exposition	Automatique, manuel, automatique à priorité (obturateur ou
Balance des blancs	Automatique ou manuelle
Zoom optique	x20
Zoom numérique	x1
Zoom total	x20
Angles de champ	Diagonal : de 69,2° (au gd angle) à 4,1° (au télé) Horizontal . de 62,3° (au gd angle) à 3,6° (au télé) Vertical : de 37,3° (au gd angle) à 2,1° (au télé)
Distances focales	f = de 4,5 mm (au gd angle) à 90 mm (au télé)
Ouverture (diaph.)	De f:1,8 (au gd angle) à f:4,7 (au télé)
Distance minimale de travail	Au gd angle : 0,1 m ; au télé : 1,2 m
Angles de panoramiques	Horizontal : ±170° ; vertical : +90° / -30°
Vitesse de pano (en manuel)	Horizontal : de 0,1° à 100° par seconde; vertical : de 0,1° a 100° par
Vitesse pré réglée	Horizontal : 200°/s ; vertical : 200°/s
Positions pré réglées	10 (IR), 256 (RS-232, RS-422, IP)
Commandes caméra –	RS-232 / RS-422 / Ethernet
Commandes caméra –	VISCA (RS-232/RS-422/IP), CGI (IP)
Traitement de l'image	Miroir / Retournement / Gel / WDR / BLC
Fréquences du courant	50 Hz, 60 Hz
Fonctions IA	
Modes	Suivi des yeux
Confidentialité	
Mode de protection	Mode intimité

Généralités	
Alimentation requise	12 V
Consommation	24 W
PoE	PoE+ (IEEE802.3at)
Dimensions (La x H x P)	180 (La) x 145 (P) x183 (H) mm
Poids net	1,7 ±0,1 kg
Utilisation	À l'intérieur
Voyant tally	Oui
Sécurité	Fente Kensington
Télécommande IR	Oui
Conditions de service	Température : de 0 à +40 °C Humidité : de 20 à 80 %
Conditions d'entreposage	Température : de -20 à +60 °C Humidité : de 20 à 95 %
Audio	
Canaux	Stéréo 2 canaux
Codecs	AAC-LC (48k)
Interface	
Sorties vidéo	HDMI, IP, USB
Sorties audio	HDMI, IP, USB
Entrées audio	S/O
Diffusion sur IP	
Résolution	4K à 60 i/s
Formats de compression vidéo réseau	H.264, H.265, MJPEG
Cadence maximale	4K à 60 i/s
Modes de contrôle de la vitesse	VBR, CBR
Plage de vitesses de	De 512 Kbits/s à 64 Mbits/s
Interfaces réseau	10 / 100 / 1000 Base-T
Capacité de multidiffusion	2 (RTSP/Page Web), MAX. : 4K à 60 i/s
Protocoles réseau	IPv6,IPv4, TCP, UDP, ARP, IMCP, IGMP, HTTP, DHCP RTP/RTCP, RTSP, RTMP,VISCA sur IP

USB	
Connecteur	USB 3.0 (type B)
Format vidéo	MJPEG
Maximum vidéo	2160p
USB Video Class (UVC)	UVC1.1
USB Audio Class (UAC)	UAC 1.0
Interface utilisateur Web	
Prévisualisation vidéo en direct	Oui
Commandes PTZ de la caméra	Pano horiz. / Pano vert. / Zoom / Mise au point / Commandes des
Caméra / Image	Exposition, balance des blancs, traitement de l'image
Configuration réseau	DHCP, adresse IP, passerelle, masque de sous-réseau, DNS
Outils logiciels	
Outil de recherche et de	Prend en charge Windows® 7 ou plus récent
Gestion PTZ	Prend en charge Windows® 7 ou plus récent
Panneau de commandes PTZ	Prend en charge iOS et iPadOS® 11 ou plus récent
Outil pour les réglages caméra	Prend en charge Windows® 7 et macOS® 10.14 ou plus récents

Les caractéristiques sont susceptibles de modifications sans avis préalable.

Dépannage

L'image est déformée ou floue.

- Sur l'interface Web, allez à **Live View > Camera Control** et cliquez sur  **Auto Focus**.
- Sur la télécommande, appuyez sur **Menu**  pendant 3 secondes > **Factory Default > On** pour rétablir tous les paramètres par défaut d'usine.

Comment ouvrir le menu sur écran (OSD) ?

1. Vérifiez que le câble HDMI est branché sur la caméra et sur l'afficheur.
2. Sur la télécommande, appuyez sur **Menu**  pendant 3 secondes pour ouvrir le menu OSD.
3. Le voyant LED allumé en violet fixe indiquera que le menu OSD est activé.

Annexe

Tableau de commande VISCA RS-232

Command Set	Command	Command Packet	Comments
Command Set	Command	Command Packet	Comments
IF_Clear	Broadcast	88 01 00 01 FF	I/F Clear (Clear Visca connection & command buffer queue)
CommandCancel	--	8x 2p FF	p: Socket No. (=1or2)
CAM_Power	On	8x 01 04 00 02 FF	Power OFF to Standby mode
	Off	8x 01 04 00 03 FF	Power ON supported in Standby mode only
CAM_Zoom	Stop	8x 01 04 07 00 FF	Zoom Control
	Tele(Standard)	8x 01 04 07 02 FF	
	Wide(Standard)	8x 01 04 07 03 FF	
	Tele(Variable)	8x 01 04 07 2p FF	p=0 (Low) to 7 (High)
	Wide(Variable)	8x 01 04 07 3p FF	
	Direct	8x 01 04 47 0p 0q 0r 0s FF	pqrs: Zoom Position. MD120UI: 0x00F0 (x1) ~ 0x5378 (x20)
CAM_Focus	Stop	8x 01 04 08 00 FF	Focus Control Each 'Far/Near' needs a 'stop'
	Far (Standard)	8x 01 04 08 02 FF	
	Near (Standard)	8x 01 04 08 03 FF	
	Far (Variable)	8x 01 04 08 2p FF	p=0 (Low) to 7 (High)
	Near (Variable)	8x 01 04 08 3p FF	
	Auto Focus	8x 01 04 38 02 FF	AF ON/OFF
	Manual Focus	8x 01 04 38 03 FF	
	Auto/Manual	8x 01 04 38 10 FF	
	One Push	8x 01 04 18 01 FF	
	Direct	8x 01 04 48 0p 0q 0r 0s FF	pqrs: Focus Position, MD120UI: 0x0000(wide) ~ 0x4000(tele)
	Near Limit	8x 01 04 28 0p 0q 0r 0s FF	pqrs: Focus Near Limit Position 0001: 0.01m 0002: 1m 0003: 1.5m 0004: 2m 0005: 3m 0006: 6m 0007: 10m

Command Set	Command	Command Packet	Comments
CAM_AFMode	Normal AF	8x 01 04 57 00 FF	Continuous AF ON
	Zoom Trigger AF	8x 01 04 57 02 FF	Continuous AF OFF, only trigger AF after PTZ done
CAM_WB	Auto	8x 01 04 35 00 FF	Normal Auto
	ATW	8x 01 04 35 04 FF	
	Indoor	8x 01 04 35 01 FF	
	Outdoor	8x 01 04 35 02 FF	
	One Push WB	8x 01 04 35 03 FF	One Push WB mode
	Manual	8x 01 04 35 05 FF	Manual Control mode
	One Push Trigger	8x 01 04 10 05 FF	One Push WB Trigger
CAM_RGain	Reset	8x 01 04 03 00 FF	Manual Control of R Gain
	Up	8x 01 04 03 02 FF	
	Down	8x 01 04 03 03 FF	
	Direct	8x 01 04 43 00 00 0p 0q FF	pq: R Gain
CAM_BGain	Reset	8x 01 04 04 00 FF	Manual Control of B Gain
	Up	8x 01 04 04 02 FF	
	Down	8x 01 04 04 03 FF	
	Direct	8x 01 04 44 00 00 0p 0q FF	pq: B Gain
CAM_AE	Full Auto	8x 01 04 39 00 FF	Automatic Exposure mode
	Manual	8x 01 04 39 03 FF	Manual Control mode
	Shutter Priority	8x 01 04 39 0A FF	Shutter Priority Automatic Exposure mode
	Iris Priority	8x 01 04 39 0B FF	Iris Priority Automatic Exposure mode
CAM_SlowShutter	Auto	8x 01 04 5A 02 FF	Auto Slow Shutter ON/OFF
	Manual	8x 01 04 5A 03 FF	
CAM_Shutter	Reset	8x 01 04 0A 00 FF	Shutter Setting
	Up	8x 01 04 0A 02 FF	
	Down	8x 01 04 0A 03 FF	
	Direct	8x 01 04 4A 00 00 0p 0q FF	pq: Shutter Position
CAM_Iris	Reset	8x 01 04 0B 00 FF	Iris Setting
	Up	8x 01 04 0B 02 FF	
	Down	8x 01 04 0B 03 FF	

Command Set	Command	Command Packet	Comments
	Direct	8x 01 04 4B 00 00 0p 0q FF	pq: Iris Position
CAM_Gain	Reset	8x 01 04 0C 00 FF	Gain Setting
	Up	8x 01 04 0C 02 FF	
	Down	8x 01 04 0C 03 FF	
	Direct	8x 01 04 4C 00 00 0p 0q FF	pq: Gain Position
	AE Gain Limit	8x 01 04 2C 0p FF	p: Gain Position (8 to E: 24db~42db)
CAM_Bright	Up	8x 01 04 0D 02 FF	--
	Down	8x 01 04 0D 03 FF	
	Direct	8x 01 04 4D 00 00 0p 0q FF	pq: Bright Position
CAM_ExpComp	Reset	8x 01 04 0E 00 FF	Exposure Comp Amount Setting
	Up	8x 01 04 0E 02 FF	
	Down	8x 01 04 0E 03 FF	
	Direct	8x 01 04 4E 00 00 0p 0q FF	pq: ExpComp Position
CAM_Backlight	On	8x 01 04 33 02 FF	Back Light Compensation ON/OFF
	Off	8x 01 04 33 03 FF	
CAM_LR_Reverse	On	8x 01 04 61 02 FF	Mirror Image ON/OFF
	Off	8x 01 04 61 03 FF	
CAM_Flip	On	8x 01 04 66 02 FF	Flip ON/OFF
	Off	8x 01 04 66 03 FF	
CAM_Preset	Reset	8x 01 04 3F 00 pp FF	Preset Cancel. pp: Preset Number 0x00~0xFF
	Set	8x 01 04 3F 01 pp FF	Preset Save.
	Recall	8x 01 04 3F 02 pp FF	Preset Load.
CAM_Menu	On	8x 01 06 06 02 FF	Menu Display ON/OFF
	Off	8x 01 06 06 03 FF	
	On/Off	8x 01 06 06 10 FF	
CAM_MenuEnter	--	8x 01 7E 01 02 00 01 FF	Enter Submenu
CAM_NR	--	8x 01 04 53 0p FF	p: Image NR Setting (0:OFF, Level1 to 3)
CAM_WDR	On	8x 01 04 3D 02 FF	Wdr ON/OFF
	Off	8x 01 04 3D 03 FF	
CAM_ICR	On	8x 01 04 01 02 FF	Infrared Mode ON (Night)

Command Set	Command	Command Packet	Comments
	Off	8x 01 04 01 03 FF	Infrared Mode OFF (Day)
CAM_AutoICR	On	8x 01 04 51 02 FF	Auto Infrared mode ON/OFF
	Off	8x 01 04 51 03 FF	
	Threshold	8x 01 04 21 00 00 0p 0q FF	pq: ICR OFF(Day)->ON(Night) threshold level 00: Low; 01: Middle; 02: High
CAM_IDWrite	--	8x 01 04 22 0p 0q 0r 0s FF	pqrs: Camera ID (=0000 to FFFF)
Video Format Change	--	8x 01 7E 01 1E 0p 0q FF	pq
			0x02: 1920x1080P/60
			0x03: 1920x1080P/59.94
			0x04: 1920x1080P/30
			0x05: 1920x1080P/29.97
			0x08: 1920x1080I/60
			0x0A: 1920x1080I/59.94
			0x0B: 1280x720P/60
			0x0C: 1280x720P/59.94
			0x0D: 1920x1080P/50
			0x18: 1920x1080P/25
			0x22: 1920x1080I/50
			0x26: 1280x720P/50
			0x30: 3840x2160P/60
			0x31: 3840x2160P/59.94
			0x32: 3840x2160P/50
			0x33: 3840x2160P/30
0x34: 3840x2160P/29.97			
0x35: 3840x2160P/25			
IR_Receive	On	8x 01 06 08 02 FF	Infrared remote commander reception ON
Pan-tilt Drive	Up	8x 01 06 01 VV WW 03 01 FF	VV: Pan speed setting 0x01 (low speed) to 0x18 (high speed) WW: Tilt speed setting 0x01 (low speed) to 0x18 (high speed) YYYY: Pan Position 7FFF(170°) to 8000(-170°)
	Down	8x 01 06 01 VV WW 03 02 FF	
	Left	8x 01 06 01 VV WW 01 03 FF	
	Right	8x 01 06 01 VV WW 02 03 FF	

Command Set	Command	Command Packet	Comments
	UpLeft	8x 01 06 01 VV WW 01 01 FF	(Normalized, CENTER 0000) ZZZZ: Tilt Position 7FFF(90°) to 8000(-30°) (Image Flip: OFF) (Normalized, CENTER 0000)
	UpRight	8x 01 06 01 VV WW 02 01 FF	
	DownLeft	8x 01 06 01 VV WW 01 02 FF	
	DownRight	8x 01 06 01 VV WW 02 02 FF	
	Stop	8x 01 06 01 VV WW 03 03 FF	
	AbsolutePosition	8x 01 06 02 VV WW 0Y 0Y 0Y 0Y 0Z 0Z 0Z 0Z FF	
	RelativePosition	8x 01 06 03 VV WW 0Y 0Y 0Y 0Y 0Z 0Z 0Z 0Z FF	
	Home	8x 01 06 04 FF	
	Reset	8x 01 06 05 FF	
Freeze	Freeze On	8x 01 04 62 02 FF	Freeze On Immediately
	Freeze Off	8x 01 04 62 03 FF	Freeze Off Immediately
	Preset Freeze On	8x 01 04 62 22 FF	Freeze On When Running Preset
	Preset Freeze Off	8x 01 04 62 23 FF	Freeze Off When Running Preset
RTMP	On	8x 01 04 A2 02 FF	RTMP ON/OFF
	Off	8x 01 04 A2 03 FF	
Reboot	On	8x 01 04 A4 FF	System reboot
P/T Spd. Relative Zoom Ratio	On	8x 01 04 A6 02 FF	P/T Speed Relative Zoom Ratio ON/OFF
	Off	8x 01 04 A6 03 FF	
Factory Reset	System Factory Reset	8x 01 04 3F 03 00 FF	
Preset Speed	Set Preset Speed	8x 01 06 20 0p FF	p=1 (Low) to 6 (High)

Inquiry Command	Command Packet	Inquiry Packet	Comments
Inquiry Command	Command Packet	Inquiry Packet	Comments
CAM_PowerInq	8x 09 04 00 FF	y0 50 02 FF	On
		y0 50 02 FF	Off
CAM_ZoomPosInq	8x 09 04 47 FF	y0 50 0p 0q 0r 0s FF	pqrs: Zoom Position
CAM_FocusModelInq	8x 09 04 38 FF	y0 50 02 FF	Auto Focus
		y0 50 03 FF	Manual Focus
CAM_FocusPosInq	8x 09 04 48 FF	y0 50 0p 0q 0r 0s FF	pqrs: Focus Position
CAM_FocusNearLimitInq	8x 09 04 28 FF	y0 50 0p 0q 0r 0s FF	pqrs: Focus Near Limit Position
CAM_AFModelInq	8x 09 04 57 FF	y0 50 00 FF	Continuous AF ON
		y0 50 02 FF	Continuous AF OFF, only trigger AF after PTZ done
CAM_WBModelInq	8x 09 04 35 FF	y0 55 00 FF	Auto
		y0 55 04 FF	ATW
		y0 55 01 FF	Indoor
		y0 55 02 FF	Outdoor
		y0 55 03 FF	One Push WB
		y0 55 05 FF	Manual
CAM_RGainInq	8x 09 04 43 FF	y0 50 00 00 0p 0q FF	pq: R Gain
CAM_BGainInq	8x 09 04 44 FF	y0 50 00 00 0p 0q FF	pq: B Gain
CAM_AEModelInq	8x 09 04 39 FF	y0 50 00 FF	Full Auto
		y0 50 03 FF	Manual
		y0 50 0A FF	Shutter Priority
		y0 50 0B FF	Iris Priority
		y0 50 0D FF	Bright
CAM_SlowShutterModelInq	8x 09 04 5A FF	y0 50 02 FF	Auto
		y0 50 03 FF	Manual
CAM_ShutterPosInq	8x 09 04 4A FF	y0 50 00 00 0p 0q FF	pq: Shutter Position
CAM_IrisPosInq	8x 09 04 4B FF	y0 50 00 00 0p 0q FF	pq: Iris Position
CAM_GainPosInq	8x 09 04 4C FF	y0 50 00 00 0p 0q FF	pq: Gain Position
CAM_GainLimitInq	8x 09 04 2C FF	y0 50 0q FF	p: Gain Limit
CAM_BrightPosInq	8x 09 04 4D FF	y0 50 00 00 0p 0q FF	pq: Bright Position

Inquiry Command	Command Packet	Inquiry Packet	Comments
CAM_ExpCompPosInq	8x 09 04 4E FF	y0 50 00 00 0p 0q FF	pq: ExpComp Position
CAM_BacklightModeInq	8x 09 04 33 FF	y0 50 02 FF	On
		y0 50 03 FF	Off
CAM_LR_Reverse_Inq	8x 09 04 61 FF	y0 50 02 FF	On
		y0 50 03 FF	Off
CAM_Flip_Inq	8x 09 04 66 FF	y0 50 02 FF	On
		y0 50 03 FF	Off
CAM_NRInq	8x 09 04 53 FF	y0 50 0p FF	p: NR Level
CAM_WDRInq	8x 09 04 3D FF	y0 50 02 FF	On
		y0 50 03 FF	Off
CAM_ICRModelInq	8x 09 04 01 FF	y0 50 02 FF	On (Night)
		y0 50 03 FF	Off (Day)
CAM_AutoICRModelInq	8x 09 04 51 FF	y0 50 02 FF	On
		y0 50 03 FF	Off
CAM_AutoICRThresholdInq	8x 09 04 21 FF	y0 50 00 00 0p 0q FF	pq: ICR OFF(Day)->ON(Night) threshold level 00: Low; 01: Middle; 02: High
CAM_IDInq	8x 09 04 22 FF	y0 50 0p 0q 0r 0s FF	pqrs: Camera ID
CAM_VersionInq	8x 09 00 02 FF	y0 50 ab cd mn pq rs tu vw FF	abcd: Vendor Code, AVer: 2574 mnpq: Model Code, MD120UI: 0565 rstu: Firmware version (ex: 4025 for 1.1.4025.0) vw: Socket Number (=02)
CAM_MenuModelInq	8x 09 06 06 FF	y0 50 02 FF	On
		y0 50 03 FF	Off
Video Format Inq	8x 09 06 23 FF	y0 50 02 FF	1920x1080P/60
		y0 50 03 FF	1920x1080P/59.94
		y0 50 04 FF	1920x1080P/30
		y0 50 05 FF	1920x1080P/29.97
		y0 50 08 FF	1920x1080I/60
		y0 50 0A FF	1920x1080I/59.94
		y0 50 0B FF	1280x720P/60
		y0 50 0C FF	1280x720P/59.94
		y0 50 0D FF	1920x1080P/50

Inquiry Command	Command Packet	Inquiry Packet	Comments
		y0 50 18 FF	1920x1080P/25
		y0 50 22 FF	1920x1080I/50
		y0 50 26 FF	1280x720P/50
		y0 50 30 FF	3840x2160P/60
		y0 50 31 FF	3840x2160P/59.94
		y0 50 32 FF	3840x2160P/50
		y0 50 33 FF	3840x2160P/30
		y0 50 34 FF	3840x2160P/29.97
		y0 50 35 FF	3840x2160P/25
IR_Receive	8x 09 06 08 FF	y0 50 02 FF	On
		y0 50 03 FF	Off
Pan-tiltPosInq	8x 09 06 12 FF	y0 50 0Y 0Y 0Y 0Y 0Z 0Z 0Z 0Z FF	YYYY: Pan Position 7FFF(170°) to 8000 (-170°) (Normalized, CENTER 0000) ZZZZ: Tilt Position 7FFF(90°) to 8000(-30°) (Image Flip: OFF) (Normalized, CENTER 0000)
CAM_Preset_Inq	8x 09 04 3F FF	y0 50 pp FF	Return the last preset number which has been operated pp:01-FF
Pan-tiltMaxSpeedInq	8x 09 06 11 FF	y0 50 ww zz FF	ww = Pan Max Speed zz = Tilt Max Speed
Freeze_Mode_Inq	8x 09 04 62 01 FF	y0 50 02 FF	On
		y0 50 03 FF	Off
Preset_Freeze_Inq	8x 09 04 62 02 FF	y0 50 02 FF	On
		y0 50 03 FF	Off
RTMP_Inq	8x 09 04 A2 FF	y0 50 02 FF	On
		y0 50 03 FF	Off
Preset_Speed_Inq	8x 09 06 20 FF	y0 50 0p FF	p=1 (Low) to 6 (High)
Firmware version	8x 09 36 69 04 FF	y0 50 0p 0q 0r 0s 0t 0u 0v 0w FF	fw_ver: p.q.rstu.vw

Paramètres VISCA sur IP

PORT

Internet protocol	IPv4
Transport protocol	UDP
Port address	52381

FORMAT

	byte 0	byte 1	byte 2	byte 3	byte 4	byte 5	byte 6	byte 7	byte 8 ~~~ byte 23	
func	Payload type		Payload Length		Sequence number				Payload (1 to 16 bytes)	
data	Value1	Value2	1~16(0x0001~0x0010)		0x00000000 ~ 0xFFFFFFFF				VISCA Packet (see page VISCA)	

Payload type

Name	Value1	Value2	Description
VISCA command	0x01	0x00	Stores the VISCA command.
VISCA inquiry	0x01	0x10	Stores the VISCA inquiry.
VISCA reply	0x01	0x11	Stores the reply for the VISCA command and VISCA inquiry, or VISCA device setting command
VISCA device setting command	0x01	0x20	Stores the VISCA device setting command.
Control command	0x02	0x00	Stores the control command
Control reply	0x02	0x01	Stores the reply for the control command.

Commande CGI

CGI List for Video Transmission					
CGI item name	URL	Command	Parameter Name	Parameter value	Description
Get JPEG	/snapshot				1280x720 jpg
Get 4K JPEG	/cgi-bin?OnePush=n				Step 1: request 4k snapshot
	/snapshot?res=4k				Step 2: get 3840x2160 jpg
Get RTSP stream	rtsp://ip/live_st1				

CGI List for Audio					
CGI item name	URL	Command	Parameter Name	Parameter value	Description
Audio In Volume	/cgi-bin?Set=	ado_vol,3,N		0 ~10	0 ~ 10 volume

CGI List for Camera Control					
CGI item name	URL	Command	Parameter Name	Parameter value	Description
up start	/cgi-bin?SetPtfz=	1,0,1			
up end	/cgi-bin?SetPtfz=	1,0,2			
down start	/cgi-bin?SetPtfz=	1,1,1			
down end	/cgi-bin?SetPtfz=	1,1,2			
left start	/cgi-bin?SetPtfz=	0,1,1			
left end	/cgi-bin?SetPtfz=	0,1,2			
right start	/cgi-bin?SetPtfz=	0,0,1			
right end	/cgi-bin?SetPtfz=	0,0,2			
zoom_in start	/cgi-bin?SetPtfz=	2,0,1			
zoom_in end	/cgi-bin?SetPtfz=	2,0,2			
zoom_out start	/cgi-bin?SetPtfz=	2,1,1			
zoom_out end	/cgi-bin?SetPtfz=	2,1,2			
set preset:	/cgi-bin?ActPreset=	1,N			N : position
load preset:	/cgi-bin?ActPreset=	0,N			N : position

CGI List for Various Settings					
CGI item name	URL	Command	Parameter Name	Parameter value	Description
exposure value	/cgi-bin?Set=	img_expo_expo,3,N	value	1 ~ 9	N : value
saturation	/cgi-bin?Set=	img_saturation,3,N	value	0 ~ 10	N : value
contrast	/cgi-bin?Set=	img_contrast,3,N	value	0 ~ 4	N : value

Tracking on:	/cgi-bin?Set=	trk_tracking_on,3,1			
Tracking off:	/cgi-bin?Set=	trk_tracking_on,3,0			
Reboot	GET(Basic Authentication)	/cgi-bin?OnePush=!			
Factory Reset	GET(Basic Authentication)	/cgi-bin?OnePush=d			
RTMP Start streaming	/cgi-bin?Set=	vdo_rtmp_enable,3,1			
RTMP Stop streaming	/cgi-bin?Set=	vdo_rtmp_enable,3,0			
Status get (Model name & mac & FW_VER)	/cgi-bin?GetString=	sys_name&net_mac&sys_fw_version			http://10.100.105.110/cgi-bin?GetString=sys_name&net_mac&sys_fw_version
Serial No. get	/cgi-bin?GetSerialNumber				http://10.100.105.110/cgi-bin?GetSerialNumber
oneclick	/cgi-bin?Set=	ptz_oneclick_x,3,N1&ptz_oneclick_y,3,N2&ptz_oneclick_spd,3,N3		ptz_one_click_spd 1~24	N1, N2 = X, Y coordinates (1080P, 0,0 at top left) N3=moving speed
IR Cut Filter	/cgi-bin?Set=	img_ircut_filter,3,N		0 ~ 2	0 = Day, 1 = Night, 2 = Auto
IR Cut Filter Sensitivity	/cgi-bin?Set=	img_ircut_sensitivity,3,N		0 ~ 2	0 = Low, 1 = Middle, 2 = High

CGI List for AI Settings					
CGI item name	URL	Command	Parameter Name	Parameter value	Description
Eyes Tracking On/Off	/cgi-bin?Set=	trk_tracking_on,3,N	value	0 / 1	0: OFF; 1: ON
Tracking Preset	/cgi-bin?ActPreset=1,255				Save current pos. for eye tracking preset point.
Timeout to preset	/cgi-bin?Set=	trk_lost_time,3, N	value	3 / 5 / 7 / 10	timeout in seconds
Tracking Site	/cgi-bin?Set=	trk_mode,3,N	value	0 / 1	0: Full face; 1: Eyes
Tracking Range	/cgi-bin?Set=	trk_sensitivity,3,N	value	0 ~ 2	0: Close; 1: Medium; 2: Wide
Eyes Tracking On/Off Get	/cgi-bin?Get=trk_tracking_on				
	- Reply	On trk_tracking_on=1			

		Off trk_tracking_on=0			
Audio Detection On/Off	/cgi-bin?Set=	ado_det_alarm,3,N	value	0 / 1	0: OFF; 1: ON
Alarm Detection Type	/cgi-bin?Set=	ado_alm_general,3,N	value	0 / 1	general type. 0: OFF; 1: ON
		ado_alm_oxygen,3,N	value	0 / 1	oxygen type. 0: OFF; 1: ON
		ado_alm_ventilation,3,N	value	0 / 1	ventilation type. 0: OFF; 1: ON
		ado_alm_cardiovascular,3,N	value	0 / 1	cardiovascular type. 0: OFF; 1: ON
		ado_alm_temperature,3,N	value	0 / 1	temperature type. 0: OFF; 1: ON
		ado_alm_drug,3,N	value	0 / 1	drug type. 0: OFF; 1: ON
		ado_alm_artificial,3,N	value	0 / 1	artificial type. 0: OFF; 1: ON
		ado_alm_power,3,N	value	0 / 1	power type. 0: OFF; 1: ON
		ado_alm_information,3,N	value	0 / 1	information type. 0: OFF; 1: ON

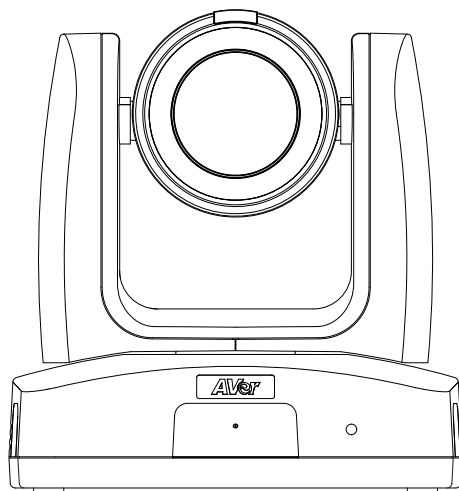

Cámara de seguimiento MD120UI

Manual del usuario



Cómo limpiar y desinfectar

Advertencia Riesgo de lesiones personales	No utilice productos de limpieza que contengan fenol, ya que el fenol puede causar quemaduras en la piel si no se enjuaga completamente y no contiene propiedades suficientes de limpieza o desinfección.
Precaución	<ol style="list-style-type: none">1. La cámara está diseñada para una limpieza y desinfección fáciles.2. Antes de limpiar la cámara, desconéctela de la fuente de alimentación.3. Los procedimientos de limpieza deben ser llevados a cabo sólo por personal familiarizado con el funcionamiento de la cámara.4. No rocíe líquidos de limpieza, especialmente agua, en ningún equipo eléctrico interno o partes de la cámara para evitar posibles cortocircuitos, corrosión, mal funcionamiento y riesgos de choque eléctrico para los usuarios o el personal de servicio.1. Los agentes de limpieza corrosivos pueden causar decoloración o dañar la cámara. Antes de usar cualquier agente de limpieza, pruébelo en un área poco visible.
Cuando	Limpie la cámara antes y después de su uso.
Pasos	<ol style="list-style-type: none">1. Desconecte la cámara de la fuente de alimentación.2. El personal de limpieza debe usar guantes de limpieza.3. Antes de usar alcohol de limpieza, asegúrese de que no haya caducado.4. Use un paño de limpieza humedecido con alcohol de limpieza (75%).5. Limpie cualquier superficie que pueda entrar en contacto con la cámara.<ol style="list-style-type: none">1. Después de limpiar el dispositivo, evite el contacto con las manos desnudas.
Frecuencia	No se requiere limpieza regular. Limpie antes y después de usar.

Símbolos en el producto

Los símbolos en este producto, incluidos los accesorios, representan lo siguiente.

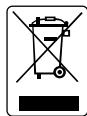

Símbolo WEEE.

Este símbolo indica que el producto no debe desecharse junto a los residuos domésticos. Por el contrario, se debe llevar a un punto de recogida designado para el reciclaje de residuos de aparatos eléctricos y electrónicos. Para obtener más información sobre dónde desechar los residuos de aparatos para su reciclaje, póngase en contacto con el servicio local de eliminación de residuos domésticos o con el establecimiento donde adquirió el producto.



Logotipo de cumplimiento CE.

Este logotipo indica que el producto cumple con las directrices/normas pertinentes de la legislación de armonización de la Unión Europea.



Logotipo de cumplimiento FCC.

Este logotipo indica que el producto cumple con las normas de la Comisión Federal de Comunicaciones.



Símbolo UKCA (UK Conformity Assessed).

Este símbolo indica que un producto comercializado en Gran Bretaña cumple los requisitos del mercado UKCA.



Logotipo de cumplimiento RCM.

Este logotipo indica que el producto se ajusta a las directrices RCM de Australia.



Este logotipo pretende alertar a los usuarios sobre la presencia de "tensión peligrosa" no aislada dentro de la carcasa del producto que puede ser de suficiente magnitud para constituir un riesgo de descarga eléctrica para las personas.



Este logotipo pretende alertar a los usuarios de la presencia de importantes instrucciones de funcionamiento y mantenimiento (servicio) en la literatura que acompaña el aparato.



Símbolo RoHS de China.

La cifra de este símbolo representa el número de años durante los cuales no se producirán fugas ni mutaciones de sustancias peligrosas en condiciones normales de uso.



Símbolo de corriente alterna.

Este símbolo indica que la entrada/salida de energía del producto es de corriente alterna.



Símbolo de corriente continua.

Este símbolo indica que la entrada/salida de energía del producto es de corriente continua.

Advertencia

Este dispositivo es un producto de Clase A. Este producto puede causar interferencias de radio en un entorno doméstico, en cuyo caso es posible que el usuario deba tomar las medidas pertinentes.

Información de seguridad de las baterías del control remoto

- Almacene las baterías en un lugar frío y seco.
- No deseche las baterías en la basura doméstica. Deseche las baterías en puntos de recolección especial o devuélvalas a las tiendas respectivas si aplica.
- Retire las baterías si no se utilizarán por un largo período de tiempo. El ácido derramado por una batería o la corrosión pueden dañar el control remoto, deseche las baterías con seguridad.
- No mezcle las baterías viejas con las nuevas.
- No mezcle ni use diferentes tipos de baterías: alcalinas, normales (carbón-zinc) o recargables (níquel-cadmio).
- No arroje las baterías al fuego.
- No trate de causar cortocircuito en los terminales de las baterías.

EXENCIÓN DE RESPONSABILIDAD

No se asume responsabilidad alguna, ya sea expresa o implícita, sobre el contenido de este documento, su calidad, rendimiento, comerciabilidad o idoneidad para un fin particular. Se ha revisado la fiabilidad de la información contenida en este documento; no obstante, no se asume ninguna responsabilidad en caso de imprecisiones. La información contenida en este documento está sujeta a cambios sin previo aviso.

En ningún caso, AVer será responsable de daños directos, indirectos, especiales, fortuitos o consecuentes derivados del uso o la incapacidad de usar este producto o su documentación, aun cuando se haya advertido de la posibilidad de dichos daños.

MARCAS COMERCIALES

«AVer» es una marca comercial propiedad de AVer Information Inc. Otras marcas comerciales utilizadas en este documento con fines descriptivos pertenecen exclusivamente a sus empresas correspondientes.

COPYRIGHT

©2023 AVer Information Inc. Todos los derechos reservados. | 6 de julio de 2023

Todos los derechos de este objeto pertenecen a AVer Information Inc. Se prohíbe la reproducción o transmisión en cualquier forma o por cualquier medio sin la previa autorización por escrito de AVer Information Inc. AVer Information Inc. se reserva el derecho a modificar sus productos, incluso sus especificaciones, y cualquier otra información aquí expuesta sin previo aviso.

Ayuda Adicional

Para preguntas frecuentes, soporte técnico y descargas de software y manuales de instrucciones, visite:

Centro de descargas: <https://www.avereurope.com/download-center>

Soporte técnico: <https://www.avereurope.com/technical-support>

Información de contacto

AVer Information Europe B.V.

<https://www.avereurope.com>

Westblaak 134, 3012KM, Rotterdam, The Netherlands

Tel: +31 (0) 10 7600 550

Soporte técnico: eu.rma@aver.com

Índice

Cómo limpiar y desinfectar	2
Vista general	1
Contenidos del paquete	1
Accesorios opcionales	1
Dimensiones	2
Soporte de techo	3
Soporte de pared	4
Ángulo de inclinación y panorámica	4
Instalación	5
Placa de fijación del cable	5
Soporte de techo	6
Conexión	7
Indicador de privacidad	7
Indicador LED	7
Conexión del dispositivo	8
Mando a distancia	11
Métodos abreviados	12
Configuración de la cámara	13
Menú OSD	13
Configuración de la dirección IP	13
Árbol del menú OSD	15
Configuración web	18
Acceso a la interfaz web de la cámara	18
Vista en vivo (Live View)	20
Configuración de IA (AI Setting)	22
Configuración de la cámara (Camera Settings)	24
Vídeo y audio (Video & Audio)	26

Red (Network)	27
Sistema (System).....	29
AVerCamera Setting Tool	31
Especificaciones.....	32
Solución de problemas	35
Anexo.....	36
Tabla de comandos VISCA RS-232	36
Configuración de VISCA over IP	44
Comando de CGI	45

Vista general

La cámara de seguimiento MD120UI es una cámara de calidad médica diseñada para la supervisión de pacientes. Dispone de visión nocturna infrarroja y carcasa resistente a rayos UV.

Contenidos del paquete

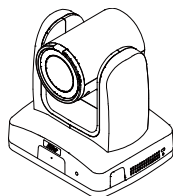

Cámara

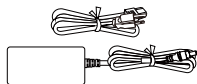

Adaptador de corriente y cable de alimentación

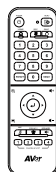

Mando a distancia



Cable USB 3.0 Tipo-B a Tipo-A (1.5 m)

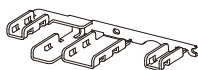

Placa de fijación del cable



Fijador de cable (x4)

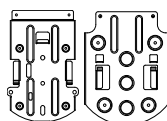

Soporte de montaje en techo (x2)

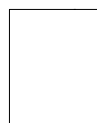

Plantilla de taladro



M2 x 4mm
Tornillo (x3)



M3 x 6mm
Tornillo (x3)



1/4"-20 L=6.5mm
Tornillo (x2)



Guía de Inicio Rápido

Accesorios opcionales

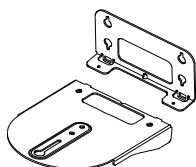

Soporte de montaje en pared

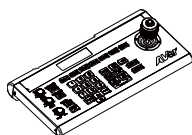

Controlador de cámara (CL01)

Dimensiones

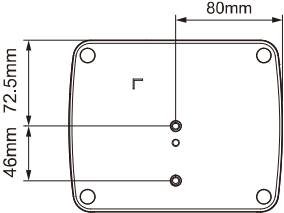
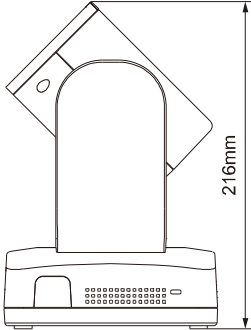
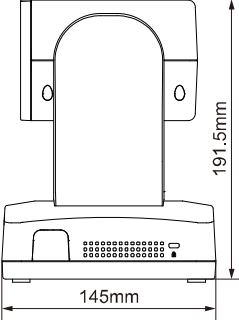
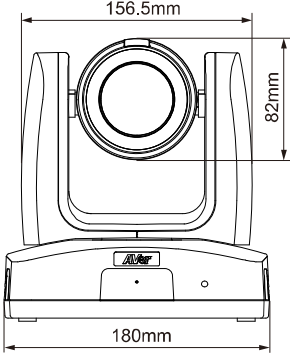

Soporte de techo

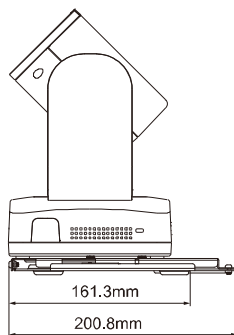
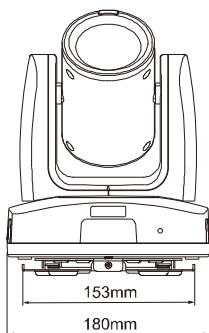
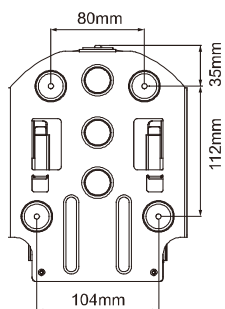
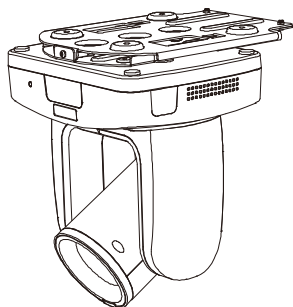

Soporte de pared

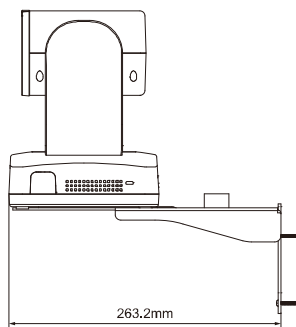
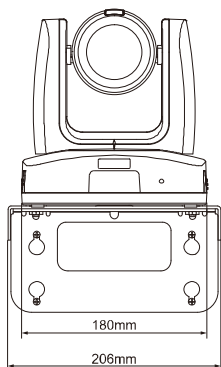
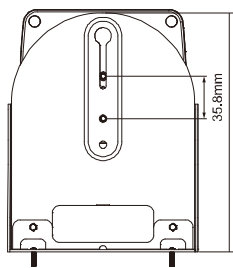
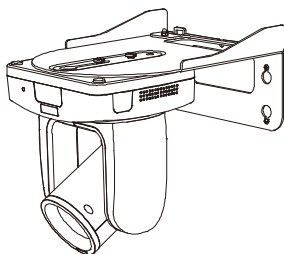
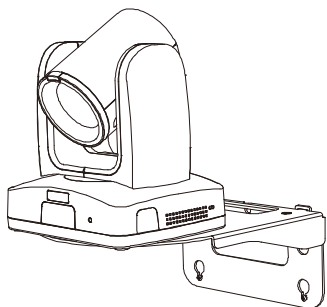

Ángulo de inclinación y panorámica

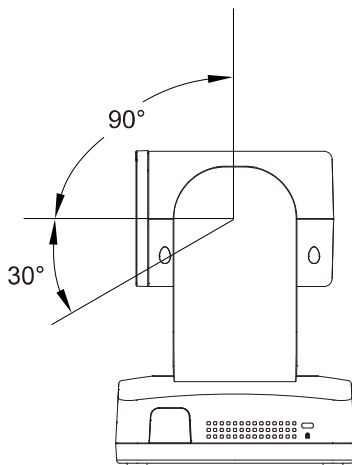
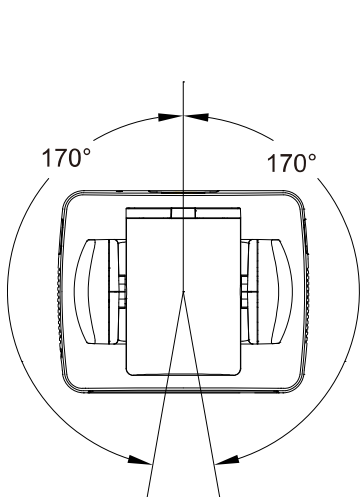

Instalación

Placa de fijación del cable

1. Asegure la placa de fijación del cable a la cámara con los tornillos M2 x 4 mm del paquete.

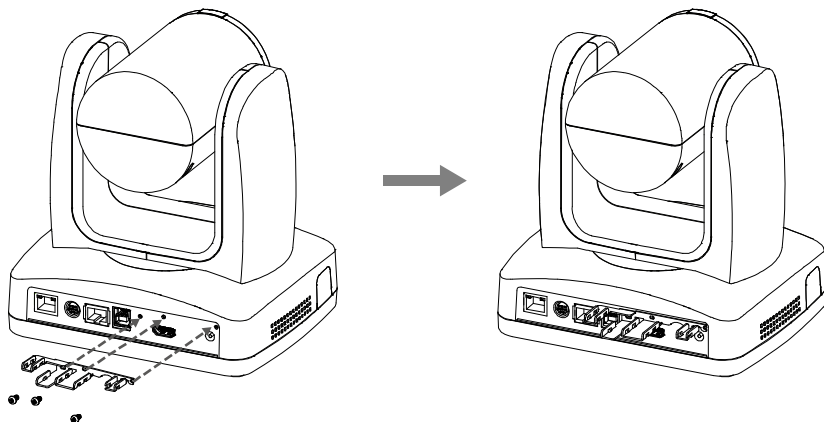

2. Conecte los cables.

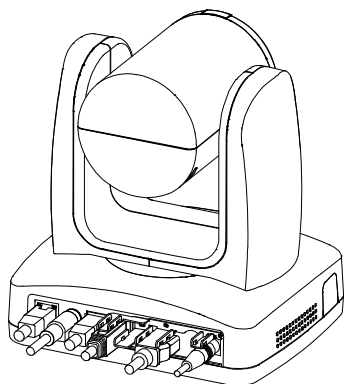

3. Fije los cables a la placa de fijación del cable con bridas a través de las ranuras.

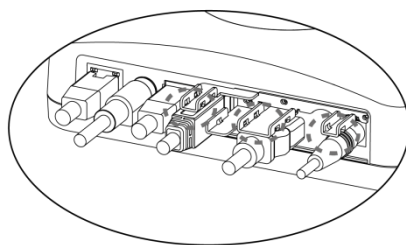

Soporte de techo

1. Asegure el soporte al techo.

Atornille: 4 tornillos, M4 x 10 mm (no incluidos)

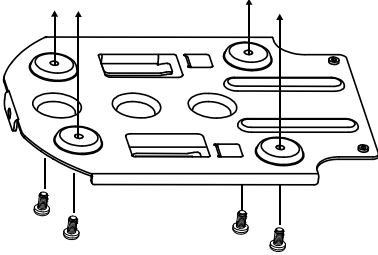

2. Asegure el soporte a la cámara.

Atornille: 2 tornillos, 1/4"-20 L = 6,5 mm (incluidos)

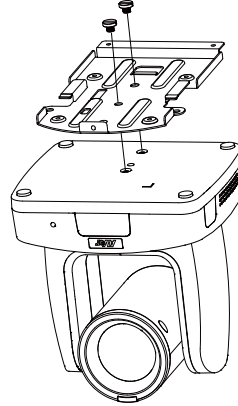

3. Deslice el soporte con la cámara en el soporte asegurado al techo. Y conecte los cables.

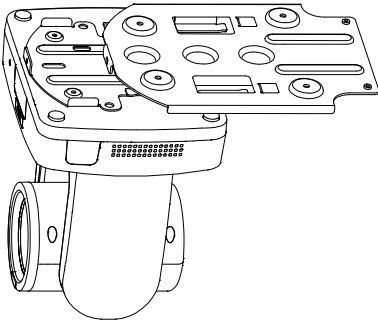

4. Fije los soportes con tornillos.

Atornille: 3 tornillos, M3 x 6 mm (incluidos)

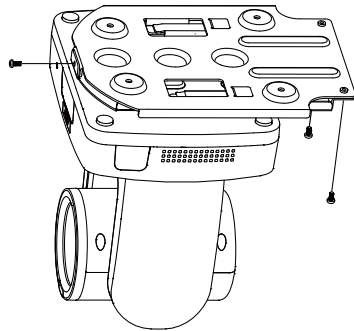

Conexión

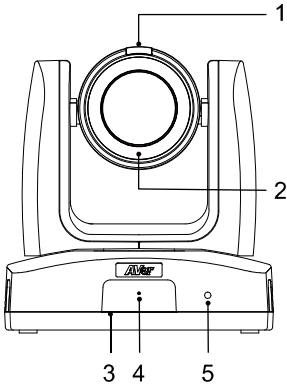

Parte delantera

1. Indicador de privacidad
2. Visión nocturna infrarroja led*
3. Sensor IR
4. Micrófono
5. Indicador LED

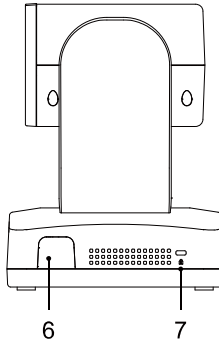

Lateral

6. Sensor IR
7. Bloqueo Kensington

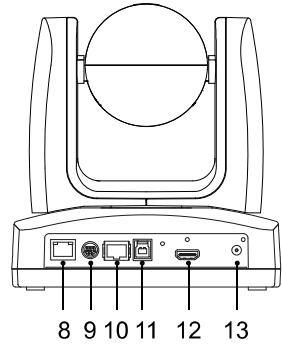

Parte posterior

8. Puerto PoE+
9. Puerto RS-232
10. Puerto RS-422
11. Puerto USB 3.1 Tipo-B
12. Puerto HDMI
13. Conector de fuente de alimentación CC

*Para evitar el peligro de radiación infrarroja, mantenga una distancia de más de un metro entre el led IR y la vista al utilizar el modo Noche.

Indicador de privacidad

Color	Estado
Verde fijo	Supervisando al paciente
Sin luz	Modo de privacidad/apagado

Indicador LED

Color	Estado
Azul fijo	Normal
Azul intermitente	El seguimiento está activado
Naranja fijo	Espera
Naranja intermitente	Inicio
Morado fijo	Menú OSD encendido
Morado intermitente	Actualizando el firmware

Conexión del dispositivo

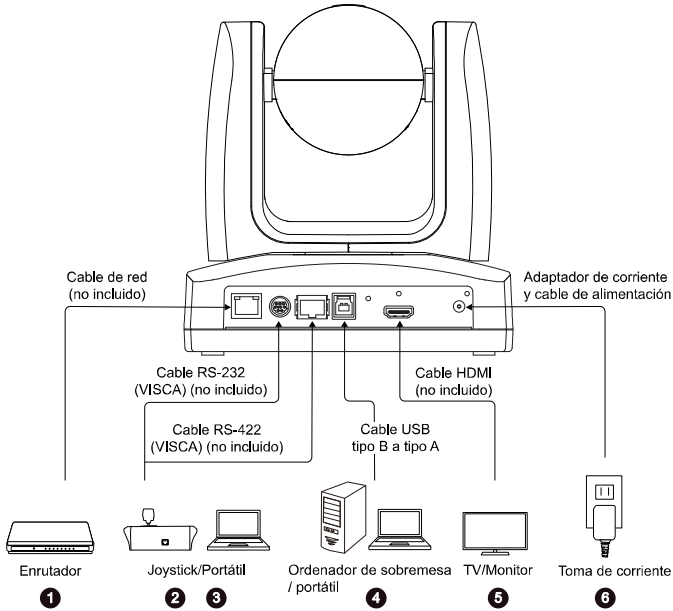

- 1. LAN:** Conecte la cámara a un enrutador IP a través del puerto LAN. (Nota)
- 2. RS-232:** Conecte la cámara a un joystick o a un ordenador portátil para controlarla. Puede adquirir opcionalmente el adaptador RS-232. La definición de los pines se muestra a continuación. (Nota)

● Definición de pines

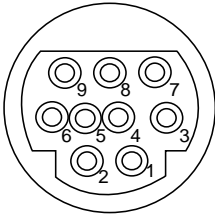

Función	Mini DIN9 N.º de pines	Tipo de E/S	Señal	Descripción
VISCA IN	1	Salida	DTR	Terminal de datos listo
	2	Entrada	DSR	Datos preparados
	3	Salida	TXD	Transmisión de datos
	6	Entrada	RXD	Recepción de datos
VISCA OUT	7	Salida	DTR	Terminal de datos listo
	4	Entrada	DSR	Datos preparados
	8	Salida	TXD	Transmisión de datos
	9	Entrada	RXD	Recepción de datos
	5	Entrada	E/S	Detecta DIN8/DIN9
---	Blindaje	---	GND	Tierra

3. **RS-422:** Conecte la cámara a una palanca de mando o portátil para controlar la cámara. Utilice un divisor CAT5e para conectar varias cámaras.

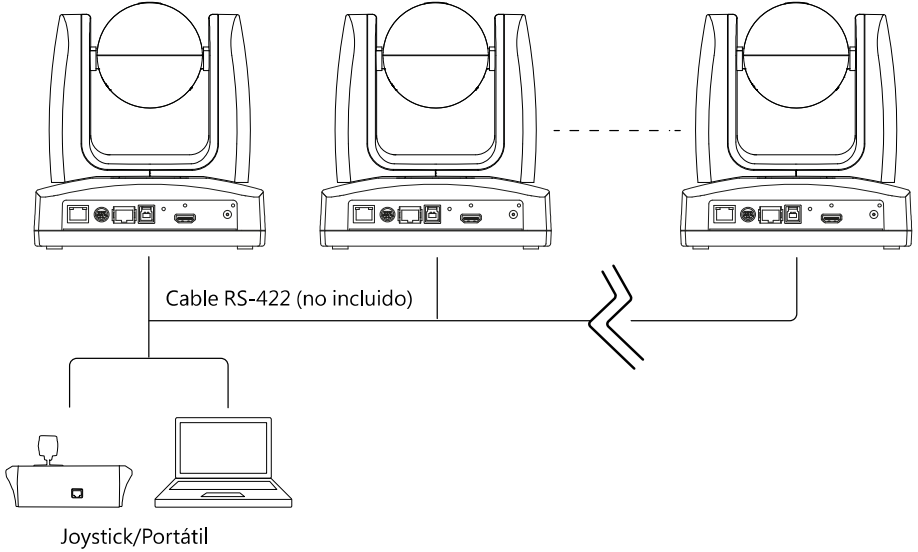

● **Definición de pines**

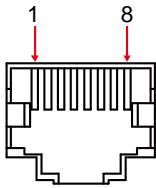

N.º	Pin	N.º	Pin
1	TX+	5	TX-
2	TX-	6	RX-
3	RX+	7	RX+
4	TX+	8	RX-

● **Asignación de pines del divisor CAT5e**

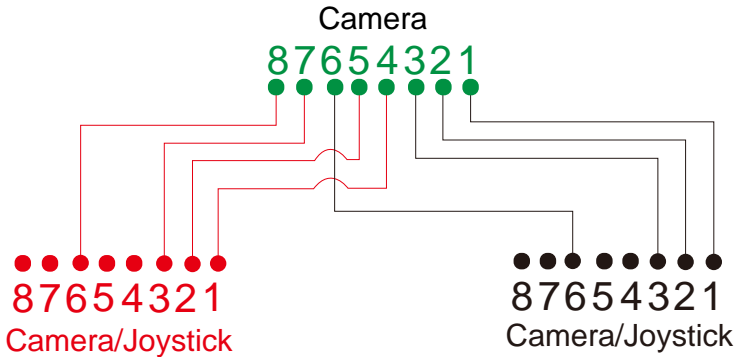

4. **USB Tipo-B:** Conecte la cámara a un ordenador de sobremesa o portátil para la transmisión de vídeo cuando utilice otro software de videoconferencia como Skype o Teams. (Nota)
5. **HDMI:** Conecta la cámara a un televisor o monitor para visualizar la salida de vídeo. La cámara y el televisor o monitor conectados deben tener un diseño de conexión a tierra. (Nota)
6. **Alimentación:** La cámara y el televisor o monitor conectados deben tener un diseño de conexión a tierra. Utilice el cable de alimentación y el adaptador de corriente suministrados para conectar la cámara a una toma de corriente y asegúrese de que el cable de alimentación del televisor o monitor admita el enchufe de toma a tierra.

Nota:

Los equipos accesorios conectados a las interfaces analógicas y digitales deben cumplir con las normas IEC armonizadas nacionalmente (es decir, IEC 60950 para equipos de procesamiento de datos, IEC 60065 para equipos de vídeo, IEC 61010-1 para equipos de laboratorio e IEC 60601-1 para equipos médicos). Además, todas las configuraciones deberán cumplir los requisitos del sistema de la norma IEC 60601-1. Todo aquel que conecte equipos adicionales a la parte de entrada de señal o a la parte de salida de señal estará configurando un sistema médico, y por lo tanto, será responsable de que el sistema cumpla con los requisitos establecidos en la norma IEC 60601-1. La unidad es para la interconexión exclusiva con equipos certificados IEC 60601-1 en el entorno del paciente y equipos certificados IEC 60XXX fuera del entorno del paciente. En caso de duda, consulte con el servicio técnico o su representante local.

Mando a distancia

El mando a distancia requiere de dos pilas AAA. Asegúrese de que las pilas estén instaladas correctamente antes de su uso.

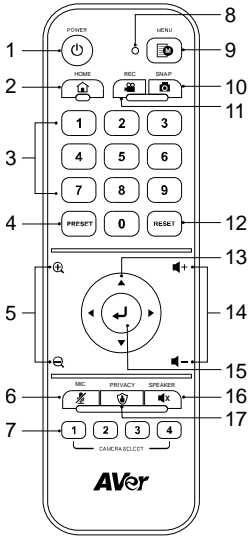







Model: LY033

Nombre	Función
1. Power	Pulse este botón para activar/desactivar el modo de espera.
2. Home	Mueva la cámara a la posición inicial.
3. Botones numéricos	<ul style="list-style-type: none"> ● Pulse los botones 0~9 para mover la cámara a las posiciones predefinidas. ● Utilice los botones para configurar las posiciones predefinidas 0~9.
4. Preset	<p>Utilice los botones Preset, numéricos y de dirección para configurar las posiciones predefinidas.</p> <ol style="list-style-type: none"> 1. Utilice los botones de dirección para desplazarse. También puede utilizar los botones "Zoom +" o "Zoom -" para acercar o alejar la imagen. 2. Mantenga presionado Preset, luego presione los botones numéricos (0~9) para guardar esta posición predefinida.
5. Zoom +/-	Pulse este botón para acercar o alejar las imágenes.
6. MIC	Pulse este botón para desactivar el micrófono. Vuelva a pulsarlo para activarlo.
7. Camera Select	Seleccione la cámara que desea utilizar. Especifique un número en el menú OSD: System > Camera Selector .
8. LED de mando a distancia	Al pulsar los botones del mando a distancia, el LED se iluminará en rojo.
9. Menu	Manténgalo pulsado durante 3 segundos para abrir el menú OSD. Edite este ajuste en el menú OSD: System > Trigger OSD .
10.Snap	N/A
11.Rec	N/A
12.Reset	Utilice los botones Reset y numéricos para cancelar una posición predefinida. Mantenga presionado Preset, luego presione los botones numéricos (0~9).

13.Botones de dirección	Utilice estos botones para desplazarse por la vista en vivo.
14.Volume +/-	N/A
15.Enter	Cuando la cámara está encendida: presione Entrar para ajustar el enfoque una vez. Al acceder al menú OSD: Presione Entrar para confirmar la selección o hacer una selección
16.Speaker	N/A
17.Privacy	Pulse este botón para entrar en modo de privacidad. La cámara se moverá a la posición de privacidad y se desactivará el micrófono.

Métodos abreviados

Pulsar	Para
Menu  durante 3 segundos	Abrir el menú OSD
Menu 	Cierra el menú OSD.
Home 	Cierra el menú OSD y la cámara regresa a la posición inicial.
Menu  seguido de Zoom 	Cambia entre los modos diurno y nocturno.
Menu  seguido de Zoom 	Cambia entre los modos diurno y automático.
5 cinco veces (55555)	Activa el DHCP.
6 seis veces (666666)	Restablece los ajustes predeterminados de fábrica de la cámara.
8 ocho veces (88888888)	Establece la dirección IP estática de la cámara en 192.168.1.168.

Configuración de la cámara

Puede configurar los ajustes de la cámara mediante el menú OSD o la interfaz web de la cámara.

Menú OSD

Para acceder al menú OSD, conecte la cámara a un monitor o televisor mediante el cable HDMI. A continuación, podrá utilizar el mando a distancia incluido para controlar el menú OSD. Mantenga pulsado el **Menu**  del mando a distancia durante 3 segundos para acceder al menú OSD y utilice **▲▼◀▶** para seleccionar las distintas páginas u opciones. Pulse **↵** para confirmar la configuración.

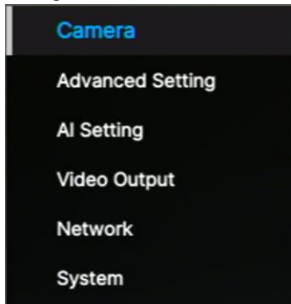

Configuración de la dirección IP

Static IP

1. Mantenga pulsado el **Menu**  del mando a distancia durante 3 segundos para acceder al menú OSD
2. Vaya a **Network > Static IP**.
[Nota] Desactive **DHCP** antes de configurar una dirección IP estática (**Network > DHCP > OFF**).
3. Seleccione **IP Address**, **Gateway**, **Netmask** y **DNS** para configurarlos. Pulse **↵** y utilice los botones numéricos para introducir el valor.

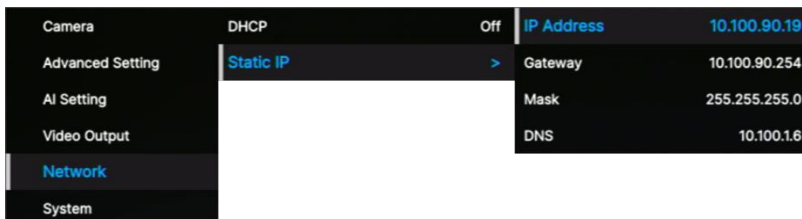

DHCP

1. Mantenga pulsado el **Menu**  del mando a distancia durante 3 segundos para acceder al menú OSD
2. Seleccione **Network > DHCP > On**.
3. Pulse **↵** para confirmar la configuración.

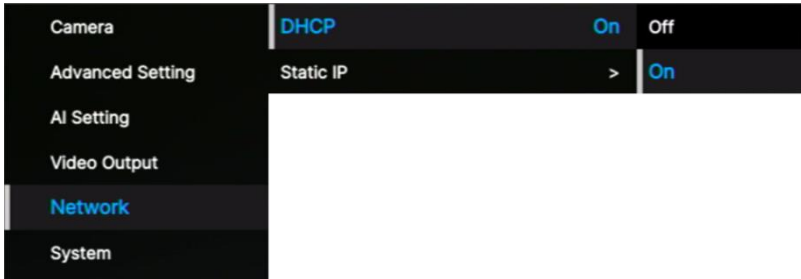

4. Después de activar **DHCP**, puede ir a **System > Information** para ver la dirección IP.

Camera	Trigger OSD	Press Menu 3 sec	Model Name	MD120UI
Advanced Setting	Camera Selector	All	Serial Number	5100435000010
AI Setting	Status OSD	Off	Version	1.1.0502.0
Video Output	Language	English	IP Address	0.0.0.0
Network	Information	>	MAC	00:18:1A:0C:BA:4E
System	Factory Default	>	Lens	C004
	System Reboot	>	Mcu	A001

Árbol del menú OSD

1er nivel	2do nivel	3er nivel	4to nivel
Camera	Exposure Mode	Full Auto	Exposure Value
			Gain Limit Level
			Slow Shutter
			BLC
			WDR
		Shutter Priority	Exposure Value
			Shutter Speed
			Gain Limit Level
		Iris Priority	Exposure Value
			Iris Level
			Gain Limit Level
			Slow Shutter
		Manual	Iris Level
			Shutter Speed
			Gain Level
	Bright mode	Bright value	
	White Balance	Auto	
		ATW	
		Indoor	
		Outdoor	
		One push trigger	
		Manual	R gain
			B gain
	Pan Tilt Zoom	Preset Speed	5, 25, 50, 100, 150, 200
		Preset Accuracy	Off / On
		Pan Speed	1~24
		Tilt Speed	1~24
		Zoom Speed	Low / High
		P/T Spd. Relative Z Ratio	Off / On
		Pan L/R Dir. Switch	Off / On

	Noise filter	Off / Low / Middle / High	
	Saturation	0 1 2 3 4 5 6 7 8 9 10	
	Contrast	0 1 2 3 4	
	Sharpness	0 1 2 3	
	Mirror	OFF / ON	
	Flip	OFF / ON	
Advanced Setting	Audio	Audio Volume	0~10
	Control	Type	RS232 / RS422
		Protocol	VISCA
		Camera Address	1 2 3 4 5 6 7
		Baud Rate	4800 / 9600 / 38400
	IR Cut Filter	Auto / Day / Night	
IR Cut Sensitivity	Low / Middle / High		
AI Setting	Facial Tracking	Eyes Tracking	On/Off
		Tracking Preset	Save
		Tracking Site	Full Face / Eyes
		Tracking Range	Close / Medium / Wide
		Timeout to Preset	3/5/7/10 sec
	AI Audio Detection	Audio Detection	On/Off
Video Output	Theme Mode	HDMI / UVC	
	Frequency	60	
		59.94	
		50	
	Resolution	2160p60	
		2160p59	
		2160p50	
		2160p30	
		2160p29	
		2160p25	
		1080p60	
		1080p59	
		1080p50	

		1080p30	
		1080p29	
		1080p25	
		1080i60	
		1080i59	
		1080i50	
		720p60	
		720p59	
		720p50	
Network	DHCP	OFF	
		ON	
	Static IP	IP Address	192.168.1.168
		Gateway	192.168.1.254
		Mask	255.255.255.0
DNS	8.8.8.8		
System	Trigger OSD	Click Menu to open, Press Menu 3 sec	
	Camera Selector	1,2,3,4,All channel, Disable Remote	
	Status OSD	OFF	
		ON	
	Language	English / 中文 / 日本語	
	Information	Model Name	MD120UI
		Serial number	xxxxxxxxxxxxx
		Firmware Version	0.0.0000.00
		IP	192.168.1.168
		MAC	00:18:1a:04:9e:81
		Lens	xxxx
Mcu	xxxx		
Factory Default	Off / On		
System Reboot	Off / On		

Configuración web

Conecte la cámara de un sitio remoto a través de Internet.

Acceso a la interfaz web de la cámara

Para acceder a la interfaz web de la cámara, deberá averiguar la dirección IP de la cámara mediante el software **AVer IPCam Utility** o **AVer PTZ Management**.

Acceder a la cámara a través de AVer IPCam Utility

Para averiguar la dirección IP de la cámara utilizando el instalador IPCam Utility, siga estos pasos.

1. Descargue IPCam Utility en <https://www.aver.com/download-center> y ejecute IPCam Utility.
2. Haga clic en **Search** (Buscar) para ver una lista de todos los dispositivos disponibles.
3. Seleccione una cámara en la lista. La información de la cámara se mostrará en el campo Settings (Configuración).

[Nota] La red predeterminada de la cámara es una IP estática (192.168.1.168) y el ID y la contraseña predeterminados son **admin/admin**. Si desea establecer la red en DHCP, introduzca el ID y la contraseña en el campo **Login**, seleccione el modelo de la cámara en la lista, seleccione "DHCP" y, por último, haga clic en el botón **Apply**.

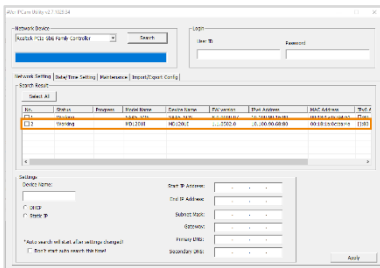

4. Para acceder a la interfaz web, haga doble clic en la dirección IP de la columna Dirección IPv4. Si es la primera vez que se conecta, se le pedirá que cambie el ID y la contraseña.

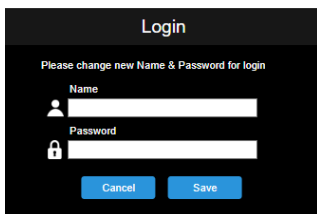

5. Inicie sesión con el nuevo ID/contraseña; se mostrará la interfaz web de la cámara (navegador Chrome). Consulte el capítulo <Vista en vivo> para obtener más detalles.

[Nota] Si IPCam Utility no puede encontrar la cámara, realice lo siguiente:

1. Asegúrese de que la conexión Ethernet de la cámara esté bien conectada.
2. La cámara y el PC (IPCam Utility) deben encontrarse en el mismo segmento de LAN.

Acceder a la cámara a través de AVer PTZ Management

Para averiguar la dirección IP de la cámara, utilice AVer PTZ Management. Siga estos pasos.

1. Descargue el software AVer PTZ Management en <https://www.aver.com/download-center>.
2. Descargue el programa para Windows e instálelo.
3. Después de configurar el ID de usuario y la contraseña, inicie sesión en el software (nombre de usuario/contraseña predeterminados: admin/admin).

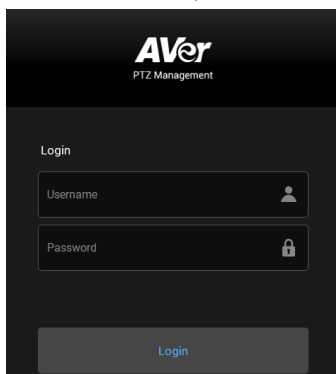

4. En la página principal de PTZ Management, haga clic en **Setup > Add** y, a continuación, en **Auto Search**. Se mostrarán las cámaras conectadas en la misma LAN que el ordenador.

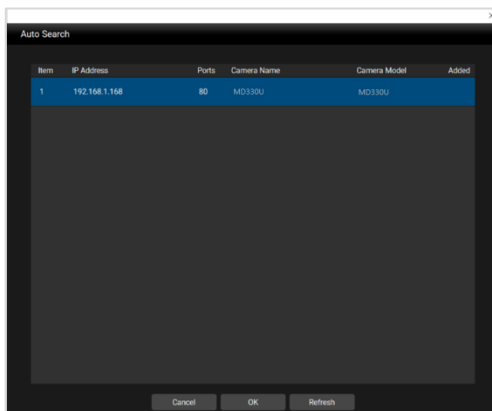
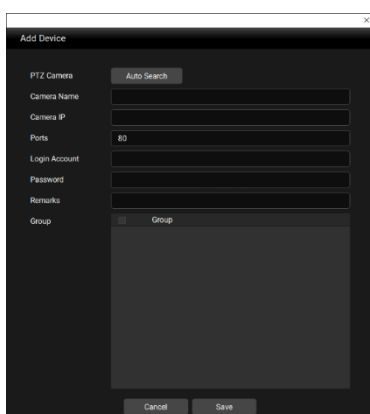

5. Haga clic en la cámara e introduzca el ID y la contraseña de la cámara para agregarla a la lista de dispositivos (el ID y la contraseña predeterminados son **admin/admin**). Haga clic en el botón **Go to Web** para acceder a la interfaz web de la cámara.

Vista en vivo (Live View)

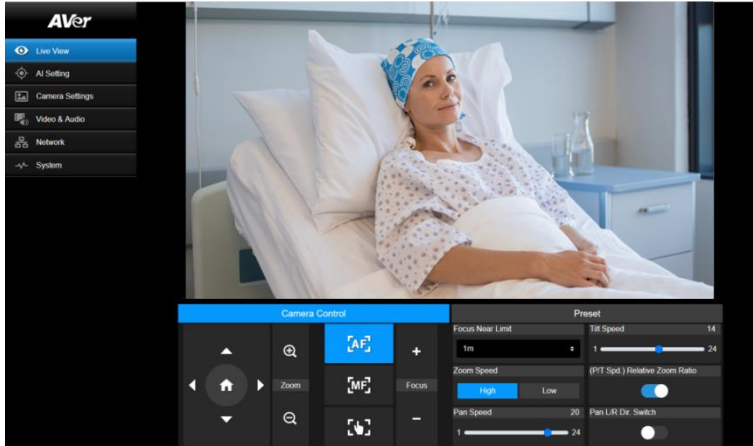

Control de la cámara(Camera Control)

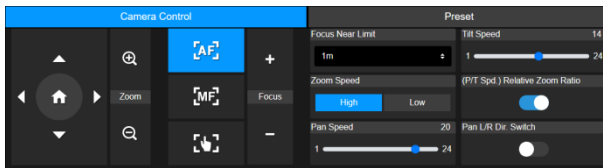

Elemento	Descripción
Controles de giro e inclinación	<p>Coloque la cámara.</p> <ul style="list-style-type: none"> ● Arrastre el control deslizante para ajustar la Pan Speed y la Tilt Speed. ● Active el Pan L/R Dir. Switch para invertir la dirección de giro. ● Active la P/T Spd. Relative Z Ratio para ajustar automáticamente las velocidades de giro y la inclinación en función de la relación de zoom. <p>También puede activarla en el menú OSD: Camera > Pan Tilt Zoom > P/T Spd. Relative Z Ratio.</p>
Posición inicial	Mueva la cámara a la posición inicial.
Zoom	Acerque o aleje la vista en directo y seleccione Zoom Speed .
Enfoque +-	<ul style="list-style-type: none"> ● Auto Focus: haga clic para enfocar automáticamente. ● Manual Focus: haga clic para enfocar manualmente. Ajuste el enfoque con los botones +-. ● One Push Focus: haga clic para enfocar automáticamente una

vez.

- **Focus Near Limit:** Configure el límite de enfoque más cercano.

Preajuste (Preset)

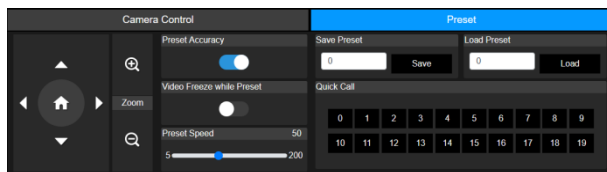

Elemento	Descripción
Guardar preajuste	<ol style="list-style-type: none">1. Coloque la cámara con los controles de giro, inclinación y zoom.2. Introduzca un número predefinido (0~255) en el campo Save Preset y haga clic en Save.
Cargar preajuste	<ol style="list-style-type: none">1. Introduzca un número predefinido (0~255) en el campo Load Preset y haga clic en Load.2. O haga clic en un número predefinido (0~19) en la sección Quick Call.
Precisión del preajuste	Active esta opción para mejorar la precisión del traslado a los preajustes.
Congelación de vídeo durante el preajuste	Active esta opción para mostrar únicamente la vista en directo desde los preajustes. No se mostrará la vista en directo de la trayectoria móvil.
Velocidad del preajuste	Ajuste la velocidad de la cámara durante el traslado a los preajustes.

Configuración de IA (AI Setting)



Seguimiento ocular (Eyes Tracking)

A ajustar manualmente los controles de giro, inclinación y zoom durante el seguimiento ocular, se desactivará la función.

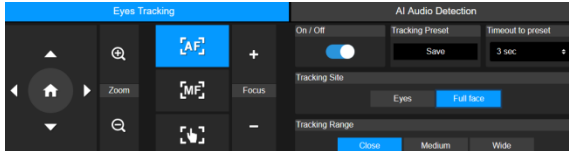

1. Coloque la cámara con los controles de giro, inclinación y zoom. A continuación, haga clic en **Save** para guardar un **Tracking Preset**. El valor predeterminado es la posición inicial.
2. En la lista desplegable **Timeout to preset**, seleccione un intervalo antes de que la cámara regrese al preajuste de seguimiento cuando nadie aparezca en la vista. El valor predeterminado es 3 segundos.
3. Haga clic en el botón de **On/Off** para activar el seguimiento ocular cuando aparezca una cara.
 - Una persona: la cámara automáticamente se acercará a la cara y la seguirá.
 - Varias personas: la cámara señalará las caras con cuadros. Seleccione una cara para seguirla automáticamente y acérquese haciendo clic en el cuadrado.
4. Elija el **Tracking Site** y el **Tracking Range**.

Detección de audio por IA (beta) ((Beta) AI Audio Detection)

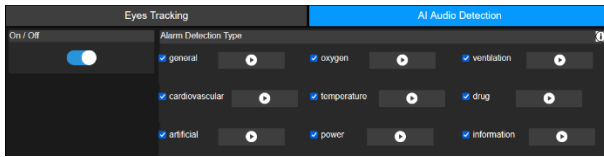

1. Actívela para detectar alarmas seleccionadas.
2. Haga clic en el botón de reproducción para escuchar ejemplos de alarma.

Configuración de la cámara (Camera Settings)



Exposición (Exposure)

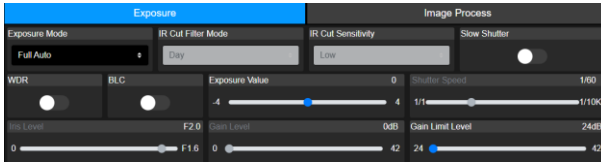

Elemento	Descripción
Exposure Mode	Seleccione un modo de exposición.
WDR	Active o desactive WDR o BLC .
BLC	
Exposure Value	Ajuste la exposición, la obturación, el iris y la ganancia.
Shutter Speed	
Iris Level	
Gain Level	
Gain Limit Level	Seleccione el modo Day , el modo Night , para activar o desactivar la visión nocturna infrarroja, o seleccione el modo Auto y ajuste la IR Cut Sensitivity .
IR Cut Filter Mode	
Obturación lenta	

Procesamiento de imágenes (Image Process)

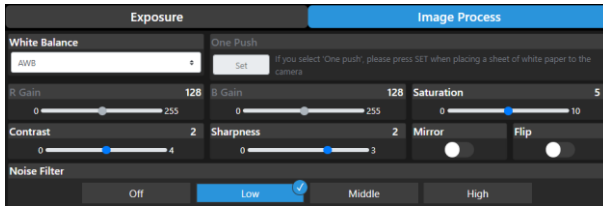

Elemento	Descripción
White Balance	<ul style="list-style-type: none">● Seleccione un modo de balance de blancos. Cuando seleccione la opción Manual, también podrá ajustar la R Gain y la B Gain.● Cuando esté seleccionada la opción de One Push, coloque un papel en blanco delante de la lente de la cámara y haga clic en Set para calibrar el balance de blancos.
Saturation	
Contrast	Ajuste la saturación, el contraste y la nitidez.
Sharpness	
Mirror	
Flip	Active o desactive Mirror o Flip .
Noise Filter	Seleccione un nivel de filtro de ruido.

Vídeo y audio (Video & Audio)

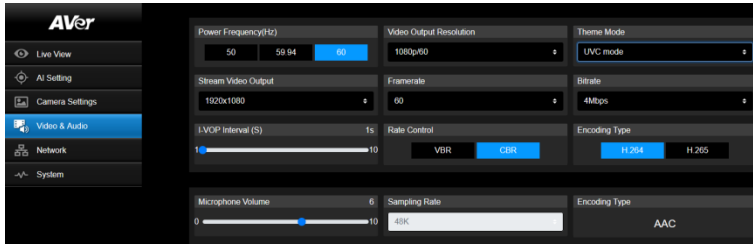

Configuración de vídeo

Elemento	Descripción
Power Frequency (Hz)	Seleccione 50 Hz , 59,94 Hz o 60 Hz en función de su país o región.
Video Out Resolution	Seleccione una resolución de vídeo de salida RTSP: 4K/60 fps máx. HDMI: 4K/60 Hz máx.
Theme Mode	Selecciona una superposición de vídeo para priorizar la salida UVC o HDMI.
Stream Video Output	Seleccione una resolución transmisión de salida.
Framerate	Seleccione una velocidad de fotogramas.
Bitrate	Seleccione una tasa de bits.
I-VOP Interval (S)	<ul style="list-style-type: none">● Arrastre el control deslizante para seleccionar con qué frecuencia aparecen los I-VOP en una transmisión de vídeo.● Intervalos I-VOP más cortos dan lugar a una calidad de vídeo más elevada, pero también a tamaños de archivo más grandes.
Rate Control	Seleccione VBR o CBR .
Encoding Type	Seleccione H.264 o H.265 .

Configuración de audio

Elemento	Descripción
Microphone Volume	Arrastre el control deslizante para ajustar el volumen del micrófono.
Sampling Rate	48K
Encoding Type	AAC

Red (Network)

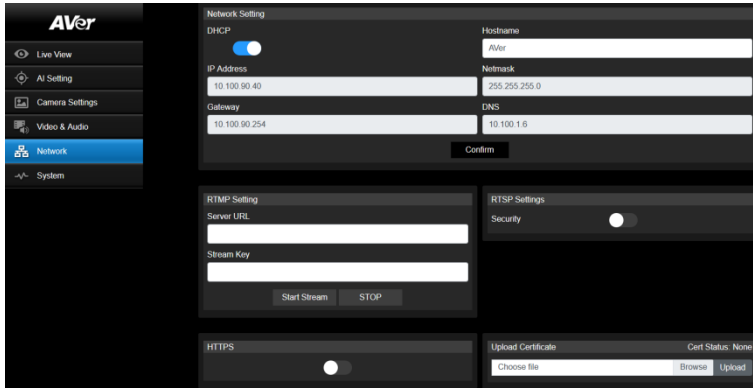

Elemento	Descripción
Hostname	El nombre de host predeterminado es AVer. Cambie el nombre de host que se mostrará en los dispositivos, como el router IP.
DHCP	<p>Establece la red en «DHCP» o «IP estática».</p> <ul style="list-style-type: none">● DHCP: Active el DHCP y haga clic en Confirm para guardar la configuración. A la cámara se le asignarán ajustes de IP de forma automática.● IP estática: Desactive el DHCP, introduzca la IP Address, la Netmask, la Gateway y el DNS, y haga clic en Confirm para guardar la configuración.
RTMP Setting	<p>Transmita vídeos en directo a una plataforma de vídeo como YouTube.</p> <ol style="list-style-type: none">1. Introduzca la Server URL y la Stream Key de su plataforma de vídeo. Consulte las indicaciones en su plataforma para obtener la URL del servidor y la clave de transmisión.2. Haga clic en Start Stream para empezar a emitir y en Stop para dejar de emitir.

RTSP Settings

Proteja su transmisión de vídeo en reproductores multimedia como VLC, PotPlayer y QuickTime, para asegurarse de que solo usuarios autorizados puedan acceder.

- Cuando la opción **Security** está desactivada:
 1. Introduzca la URL RTSP de su cámara en el reproductor multimedia.
 2. URL RTSP: `rtsp://[camera IP address]/live_st1`
Ejemplo: `rtsp://192.168.1.100/live_st1`

- Cuando la opción **Security** está activada:
 1. Introduzca la URL RTSP y el nombre de usuario y la contraseña de su cámara en el reproductor multimedia.
 2. URL RTSP: `rtsp://[username:password]@[camera IP address]/live_st1`
Ejemplo: `rtsp://1:1@192.168.1.100/live_st1`
 3. nombre de usuario/contraseña: cámara nombre de usuario/contraseña (inicio de sesión de la interfaz web)

HTTPS

Permita de HTTPS establezca una conexión segura entre su navegador y su cámara. Para permitir que HTTPS acceda a su cámara:

1. Consiga un certificado SSL para el cifrado y el descifrado en formato codificado Base64 y utilice una clave privada en formato PKCS#8 (no cifrado).
 2. Cree un paquete con el contenido del certificado necesario en formato PEM. El certificado SSL cargado en la cámara debe tener formato PEM.
 3. Haga clic en **Browse** para seleccionar el archivo del certificado y, a continuación, haga clic en **Upload**.
 4. Active HTTPS.
-

Sistema (System)

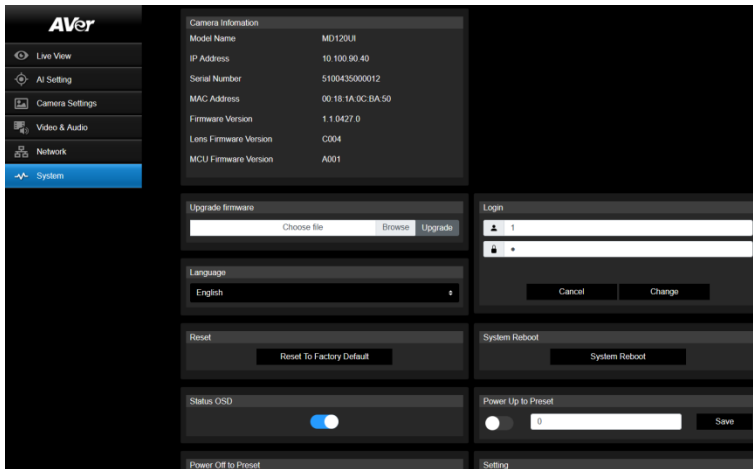

Elemento	Descripción
Camera Information	Muestra información sobre la cámara.
Upgrade Firmware	<p>Siga estos pasos para actualizar el firmware:</p> <ol style="list-style-type: none">1. Descargue el firmware más reciente del Centro de descargas de AVer (https://www.aver.com/download-center/).2. En el sitio web, vaya a System > Upgrade firmware.3. Haga clic en Browse para seleccionar el firmware.4. Haga clic en Upgrade para iniciar la actualización del firmware.5. Actualice el navegador una vez completada la actualización. <p>[Nota] Mantenga la cámara conectada a una fuente de alimentación durante la actualización del firmware. La conexión de red se perderá durante el proceso y la cámara se reiniciará automáticamente después de la actualización.</p>
Login	El nombre de usuario y la contraseña predeterminados son admin/admin . Para cambiar el nombre de usuario y la contraseña, introduzca el nombre de usuario y la contraseña nuevos y haga clic en Change .
Language	Cambie el idioma de la interfaz web.
Reset	Restablece los ajustes predeterminados de fábrica de la cámara.
System Reboot	Reinicie su cámara.

Status OSD	Permita que se muestre el estado del preajuste en la salida de HDMI durante funciones como guardar, cargar y cancelar preajustes.
Power Up to Preset	Una vez activado, la cámara se trasladará a la posición definida al encenderse. <ul style="list-style-type: none"> ● Haga clic en el botón para activarlo > Introduzca un número predefinido > Haga clic en Save. ● Asegúrese de que el número predefinido se haya identificado antes de habilitar esta función.
Power Off to Preset	Una vez activado, la cámara se trasladará a la posición definida antes de apagarse. <ul style="list-style-type: none"> ● Haga clic en el botón para activarlo > Introduzca un número predefinido > Haga clic en Save. ● Asegúrese de que el número predefinido se haya identificado antes de habilitar esta función.
Setting	Exporte o importe la configuración de su cámara
Help Us Improve	Acepte o rechace proporcionar datos de uso anónimos.

AVerCamera Setting Tool

AVerCamera Setting Tool es un software de aplicación que admite el funcionamiento de las cámaras AVer PTZ cuando se transmite a un software de terceros. Permite a los usuarios configurar ajustes de imagen, audio y vídeo sin un mando a distancia, así como conectar la cámara a través de USB.

- Descargue AVerCamera Setting Tool en el sitio web de AVer:
<https://www.aver.com/Downloads/search?q=AVer%20Camera%20Setting%20Tool>.
- Para obtener información sobre la configuración, consulte el capítulo <AVerCamera Setting Tool> en el manual de usuario de CaptureShare.

Especificaciones

Cámara	
Sensor de imagen	1/2,8" CMOS
Elementos fundamentales de la	8 megapíxeles
Resoluciones de salida	Resolución: 4K/1080p/720p Velocidad de fotogramas: 60/59,94/50/30/29,97/25
Iluminación mínima	0,5 lux (50 IRE, F1.6, Max. AGC, 1/30)
Relación S/R	≥50 dB
Ganancia	Automática, manual
Líneas de televisión	1000 (centro/ancho)
Velocidad de obturación	1/1 a 1/10 000 s
Control de exposición	Automático, manual, EA con prioridad (obturador, IRIS), BLC, WDR
Balance de blancos	Automática, manual
Zoom óptico	20X
Zoom digital	1X
Zoom total	20X
Ángulos de visualización	DFOV: 69,2° (gran angular) a 4,1° (teleobjetivo) HFOV: 62,3° (gran angular) a 3,6° (teleobjetivo) VFOV: 37,3° (gran angular) a 2,1° (teleobjetivo)
Distancia focal	f = 4,5 mm (gran angular) a 90 mm (teleobjetivo)
Apertura (iris)	F = 1,8 (gran angular) a 4,7 (teleobjetivo)
Distancia de trabajo mínima	Gran angular: 0,1 m, teleobjetivo: 1,2 m
Ángulos de giro/inclinación	Giro: ±170°, inclinación: +90°/-30°
Velocidad de giro/inclinación	Giro: 0,1° a 100°/s, inclinación: 0,1° a 100°/s
Velocidad del preajuste	Giro: 200°/s, inclinación: 200°/s
Posición del preajuste	10 (IR), 256 (RS-232, RS-422, IP)
Control de la cámara - Interfaces	RS-232/RS-422/Ethernet
Control de cámara - Protocolos	VISCA (RS-232/RS-422/IP), CGI (IP)
Procesamiento de imágenes	Reflejar/voltear/congelar/WDR/BLC
Frecuencias de alimentación	50 Hz, 60 Hz
Funciones de IA	
Modos	Seguimiento ocular
Privacidad	
Modo de protección	Modo de privacidad



General	
Requisito energético	12 V
Consumo energético	24 W
PoE	PoE+ (IEEE802.3at)
Dimensiones (An x Al x P)	180 (An) x 145(P) x 183,5(Al) mm
Peso neto	1,7 ± 0,1 kg
Aplicación	Interior
Luz de Tally	Sí
Seguridad	Conector Kensington
Mando a distancia IR	Sí
Condiciones de funcionamiento	Temperatura: 0 °C a 40 °C Humedad: 20 % a 80 %
Condiciones de almacenamiento	Temperatura: -20 °C a 60 °C Humedad: 20 % a 95 %
Audio	
Canales	Estéreo de 2 canales
Códecs	AAC-LC (48K)
Interfaz	
Salidas de vídeo	HDMI, IP, USB
Salidas de audio	HDMI, IP, USB
Entradas de audio	N/A
Transmisión IP	
Resolución	4K 60 fps
Formatos de compresión de vídeo en red	H.264, H.265, MJPEG
Velocidad de fotogramas	4K 60 fps
Modos de control de la tasa de	VBR, CBR
Rango de la tasa de bits	512 Kbps~ 64 Mbps
Interfaces de red	10/100/1000Base-T
Capacidad de transmisión	2 (RTSP/sitio web), máx: 4K 60 fps
Protocolos de red	IPv6, IPv4, TCP, UDP, ARP, ICMP, IGMP, HTTP, DHCP RTP/RTCP, RTSP, RTMP, VISCA over IP

USB	
Conector	USB 3.0 (tipo B)
Formatos de vídeo	MJPEG
Máximo de vídeo	2160p
Clase de vídeo (UVC)	UVC 1.1
Clase de audio (UAC)	UAC 1.0
IU web	
Vista previa del vídeo en directo	Sí
Control de la cámara PTZ	Giro, inclinación, zoom, enfoque, control de preajuste
Cámara/imagen	Exposición, balance de blancos, procesamiento de imágenes
Configuración de red	DHCP, dirección IP, puerta de enlace, máscara de subred, DNS
Herramientas de software	
Herramienta de configuración y	Compatible con Windows® 7 o posterior
Gestión PTZ	Compatible con Windows® 7 o posterior
Panel de control PTZ	Compatible con iOS & iPadOS® 11 o posterior
Herramienta de configuración de la	Compatible con Windows® 7 o posterior, macOS® 10.14 o

Los especificaciones están sujetos a cambiar sin aviso previo.

Solución de problemas

La imagen está distorsionada o borrosa.

- En la interfaz web, vaya a **Vista en directo > Control de la cámara** y haga clic en  **Enfoque automático**.
- En el mando a distancia, mantenga pulsado el **menú**  durante 3 segundos > **Ajustes predeterminados de fábrica > Activar** para devolver la configuración a los ajustes de fábrica.

¿Cómo se abre el menú en pantalla (OSD)?

1. Asegúrese de que el cable HDMI esté conectado a su cámara y pantalla.
2. En el mando a distancia, mantenga pulsado el **menú**  durante 3 segundos para abrir el menú OSD.
3. Una luz morada fija en el indicador led señalará que el menú OSD está activado.

Tabla de comandos VISCA RS-232

Command Set	Command	Command Packet	Comments
Command Set	Command	Command Packet	Comments
IF_Clear	Broadcast	88 01 00 01 FF	I/F Clear (Clear Visca connection & command buffer queue)
CommandCancel	--	8x 2p FF	p: Socket No. (=1or2)
CAM_Power	On	8x 01 04 00 02 FF	Power OFF to Standby mode
	Off	8x 01 04 00 03 FF	Power ON supported in Standby mode only
CAM_Zoom	Stop	8x 01 04 07 00 FF	Zoom Control
	Tele(Standard)	8x 01 04 07 02 FF	
	Wide(Standard)	8x 01 04 07 03 FF	
	Tele(Variable)	8x 01 04 07 2p FF	p=0 (Low) to 7 (High)
	Wide(Variable)	8x 01 04 07 3p FF	
	Direct	8x 01 04 47 0p 0q 0r 0s FF	pqrs: Zoom Position. MD120UI: 0x00F0 (x1) ~ 0x5378 (x20)
CAM_Focus	Stop	8x 01 04 08 00 FF	Focus Control Each 'Far/Near' needs a 'stop'
	Far (Standard)	8x 01 04 08 02 FF	
	Near (Standard)	8x 01 04 08 03 FF	
	Far (Variable)	8x 01 04 08 2p FF	p=0 (Low) to 7 (High)
	Near (Variable)	8x 01 04 08 3p FF	
	Auto Focus	8x 01 04 38 02 FF	AF ON/OFF
	Manual Focus	8x 01 04 38 03 FF	
	Auto/Manual	8x 01 04 38 10 FF	
	One Push	8x 01 04 18 01 FF	
	Direct	8x 01 04 48 0p 0q 0r 0s FF	pqrs: Focus Position, MD120UI: 0x0000(wide) ~ 0x4000(tele)
	Near Limit	8x 01 04 28 0p 0q 0r 0s FF	pqrs: Focus Near Limit Position 0001: 0.01m 0002: 1m 0003: 1.5m 0004: 2m 0005: 3m 0006: 6m 0007: 10m
CAM_AFMode	Normal AF	8x 01 04 57 00 FF	Continuous AF ON

Command Set	Command	Command Packet	Comments
	Zoom Trigger AF	8x 01 04 57 02 FF	Continuous AF OFF, only trigger AF after PTZ done
CAM_WB	Auto	8x 01 04 35 00 FF	Normal Auto
	ATW	8x 01 04 35 04 FF	
	Indoor	8x 01 04 35 01 FF	
	Outdoor	8x 01 04 35 02 FF	
	One Push WB	8x 01 04 35 03 FF	One Push WB mode
	Manual	8x 01 04 35 05 FF	Manual Control mode
	One Push Trigger	8x 01 04 10 05 FF	One Push WB Trigger
CAM_RGain	Reset	8x 01 04 03 00 FF	Manual Control of R Gain
	Up	8x 01 04 03 02 FF	
	Down	8x 01 04 03 03 FF	
	Direct	8x 01 04 43 00 00 0p 0q FF	pq: R Gain
CAM_BGain	Reset	8x 01 04 04 00 FF	Manual Control of B Gain
	Up	8x 01 04 04 02 FF	
	Down	8x 01 04 04 03 FF	
	Direct	8x 01 04 44 00 00 0p 0q FF	pq: B Gain
CAM_AE	Full Auto	8x 01 04 39 00 FF	Automatic Exposure mode
	Manual	8x 01 04 39 03 FF	Manual Control mode
	Shutter Priority	8x 01 04 39 0A FF	Shutter Priority Automatic Exposure mode
	Iris Priority	8x 01 04 39 0B FF	Iris Priority Automatic Exposure mode
CAM_SlowShutter	Auto	8x 01 04 5A 02 FF	Auto Slow Shutter ON/OFF
	Manual	8x 01 04 5A 03 FF	
CAM_Shutter	Reset	8x 01 04 0A 00 FF	Shutter Setting
	Up	8x 01 04 0A 02 FF	
	Down	8x 01 04 0A 03 FF	
	Direct	8x 01 04 4A 00 00 0p 0q FF	pq: Shutter Position
CAM_Iris	Reset	8x 01 04 0B 00 FF	Iris Setting
	Up	8x 01 04 0B 02 FF	
	Down	8x 01 04 0B 03 FF	
	Direct	8x 01 04 4B 00 00 0p 0q FF	pq: Iris Position

Command Set	Command	Command Packet	Comments
CAM_Gain	Reset	8x 01 04 0C 00 FF	Gain Setting
	Up	8x 01 04 0C 02 FF	
	Down	8x 01 04 0C 03 FF	
	Direct	8x 01 04 4C 00 00 0p 0q FF	pq: Gain Position
	AE Gain Limit	8x 01 04 2C 0p FF	p: Gain Position (8 to E: 24db~42db)
CAM_Bright	Up	8x 01 04 0D 02 FF	--
	Down	8x 01 04 0D 03 FF	
	Direct	8x 01 04 4D 00 00 0p 0q FF	pq: Bright Position
CAM_ExpComp	Reset	8x 01 04 0E 00 FF	Exposure Comp Amount Setting
	Up	8x 01 04 0E 02 FF	
	Down	8x 01 04 0E 03 FF	
	Direct	8x 01 04 4E 00 00 0p 0q FF	pq: ExpComp Position
CAM_Backlight	On	8x 01 04 33 02 FF	Back Light Compensation ON/OFF
	Off	8x 01 04 33 03 FF	
CAM_LR_Reverse	On	8x 01 04 61 02 FF	Mirror Image ON/OFF
	Off	8x 01 04 61 03 FF	
CAM_Flip	On	8x 01 04 66 02 FF	Flip ON/OFF
	Off	8x 01 04 66 03 FF	
CAM_Preset	Reset	8x 01 04 3F 00 pp FF	Preset Cancel. pp: Preset Number 0x00~0xFF
	Set	8x 01 04 3F 01 pp FF	Preset Save.
	Recall	8x 01 04 3F 02 pp FF	Preset Load.
CAM_Menu	On	8x 01 06 06 02 FF	Menu Display ON/OFF
	Off	8x 01 06 06 03 FF	
	On/Off	8x 01 06 06 10 FF	
CAM_MenuEnter	--	8x 01 7E 01 02 00 01 FF	Enter Submenu
CAM_NR	--	8x 01 04 53 0p FF	p: Image NR Setting (0:OFF, Level1 to 3)
CAM_WDR	On	8x 01 04 3D 02 FF	Wdr ON/OFF
	Off	8x 01 04 3D 03 FF	
CAM_ICR	On	8x 01 04 01 02 FF	Infrared Mode ON (Night)
	Off	8x 01 04 01 03 FF	Infrared Mode OFF (Day)

Command Set	Command	Command Packet	Comments
CAM_AutoICR	On	8x 01 04 51 02 FF	Auto Infrared mode ON/OFF
	Off	8x 01 04 51 03 FF	
	Threshold	8x 01 04 21 00 00 0p 0q FF	pp: ICR OFF(Day)->ON(Night) threshold level 00: Low; 01: Middle; 02: High
CAM_IDWrite	--	8x 01 04 22 0p 0q 0r 0s FF	pqrs: Camera ID (=0000 to FFFF)
Video Format Change	--	8x 01 7E 01 1E 0p 0q FF	pp
			0x02: 1920x1080P/60
			0x03: 1920x1080P/59.94
			0x04: 1920x1080P/30
			0x05: 1920x1080P/29.97
			0x08: 1920x1080I/60
			0x0A: 1920x1080I/59.94
			0x0B: 1280x720P/60
			0x0C: 1280x720P/59.94
			0x0D: 1920x1080P/50
			0x18: 1920x1080P/25
			0x22: 1920x1080I/50
			0x26: 1280x720P/50
			0x30: 3840x2160P/60
			0x31: 3840x2160P/59.94
			0x32: 3840x2160P/50
			0x33: 3840x2160P/30
0x34: 3840x2160P/29.97			
0x35: 3840x2160P/25			
IR_Receive	On	8x 01 06 08 02 FF	Infrared remote commander reception ON
Pan-tilt Drive	Up	8x 01 06 01 VV WW 03 01 FF	VV: Pan speed setting 0x01 (low speed) to 0x18 (high speed) WW: Tilt speed setting 0x01 (low speed) to 0x18 (high speed) YYYY: Pan Position 7FFF(170°) to 8000(-170°) (Normalized, CENTER 0000) ZZZZ: Tilt Position 7FFF(90°) to 8000(-30°)
	Down	8x 01 06 01 VV WW 03 02 FF	
	Left	8x 01 06 01 VV WW 01 03 FF	
	Right	8x 01 06 01 VV WW 02 03 FF	
	UpLeft	8x 01 06 01 VV WW 01 01 FF	

Command Set	Command	Command Packet	Comments
	UpRight	8x 01 06 01 VV WW 02 01 FF	(Image Flip: OFF) (Normalized, CENTER 0000)
	DownLeft	8x 01 06 01 VV WW 01 02 FF	
	DownRight	8x 01 06 01 VV WW 02 02 FF	
	Stop	8x 01 06 01 VV WW 03 03 FF	
	AbsolutePosition	8x 01 06 02 VV WW 0Y 0Y 0Y 0Y 0Z 0Z 0Z 0Z FF	
	RelativePosition	8x 01 06 03 VV WW 0Y 0Y 0Y 0Y 0Z 0Z 0Z 0Z FF	
	Home	8x 01 06 04 FF	
	Reset	8x 01 06 05 FF	
Freeze	Freeze On	8x 01 04 62 02 FF	Freeze On Immediately
	Freeze Off	8x 01 04 62 03 FF	Freeze Off Immediately
	Preset Freeze On	8x 01 04 62 22 FF	Freeze On When Running Preset
	Preset Freeze Off	8x 01 04 62 23 FF	Freeze Off When Running Preset
RTMP	On	8x 01 04 A2 02 FF	RTMP ON/OFF
	Off	8x 01 04 A2 03 FF	
Reboot	On	8x 01 04 A4 FF	System reboot
P/T Spd. Relative Zoom Ratio	On	8x 01 04 A6 02 FF	P/T Speed Relative Zoom Ratio ON/OFF
	Off	8x 01 04 A6 03 FF	
Factory Reset	System Factory Reset	8x 01 04 3F 03 00 FF	
Preset Speed	Set Preset Speed	8x 01 06 20 0p FF	p=1 (Low) to 6 (High)

Inquiry Command	Command Packet	Inquiry Packet	Comments
Inquiry Command	Command Packet	Inquiry Packet	Comments
CAM_PowerInq	8x 09 04 00 FF	y0 50 02 FF	On
		y0 50 02 FF	Off
CAM_ZoomPosInq	8x 09 04 47 FF	y0 50 0p 0q 0r 0s FF	pqrs: Zoom Position
CAM_FocusModelInq	8x 09 04 38 FF	y0 50 02 FF	Auto Focus
		y0 50 03 FF	Manual Focus
CAM_FocusPosInq	8x 09 04 48 FF	y0 50 0p 0q 0r 0s FF	pqrs: Focus Position
CAM_FocusNearLimitInq	8x 09 04 28 FF	y0 50 0p 0q 0r 0s FF	pqrs: Focus Near Limit Position
CAM_AFModelInq	8x 09 04 57 FF	y0 50 00 FF	Continuous AF ON
		y0 50 02 FF	Continuous AF OFF, only trigger AF after PTZ done
CAM_WBModelInq	8x 09 04 35 FF	y0 55 00 FF	Auto
		y0 55 04 FF	ATW
		y0 55 01 FF	Indoor
		y0 55 02 FF	Outdoor
		y0 55 03 FF	One Push WB
		y0 55 05 FF	Manual
CAM_RGainInq	8x 09 04 43 FF	y0 50 00 00 0p 0q FF	pq: R Gain
CAM_BGainInq	8x 09 04 44 FF	y0 50 00 00 0p 0q FF	pq: B Gain
CAM_AEModelInq	8x 09 04 39 FF	y0 50 00 FF	Full Auto
		y0 50 03 FF	Manual
		y0 50 0A FF	Shutter Priority
		y0 50 0B FF	Iris Priority
		y0 50 0D FF	Bright
CAM_SlowShutterModelInq	8x 09 04 5A FF	y0 50 02 FF	Auto
		y0 50 03 FF	Manual
CAM_ShutterPosInq	8x 09 04 4A FF	y0 50 00 00 0p 0q FF	pq: Shutter Position
CAM_IrisPosInq	8x 09 04 4B FF	y0 50 00 00 0p 0q FF	pq: Iris Position
CAM_GainPosInq	8x 09 04 4C FF	y0 50 00 00 0p 0q FF	pq: Gain Position
CAM_GainLimitInq	8x 09 04 2C FF	y0 50 0q FF	p: Gain Limit
CAM_BrightPosInq	8x 09 04 4D FF	y0 50 00 00 0p 0q FF	pq: Bright Position

Inquiry Command	Command Packet	Inquiry Packet	Comments
CAM_ExpCompPosInq	8x 09 04 4E FF	y0 50 00 00 0p 0q FF	pq: ExpComp Position
CAM_BacklightModeInq	8x 09 04 33 FF	y0 50 02 FF	On
		y0 50 03 FF	Off
CAM_LR_Reverse_Inq	8x 09 04 61 FF	y0 50 02 FF	On
		y0 50 03 FF	Off
CAM_Flip_Inq	8x 09 04 66 FF	y0 50 02 FF	On
		y0 50 03 FF	Off
CAM_NRInq	8x 09 04 53 FF	y0 50 0p FF	p: NR Level
CAM_WDRInq	8x 09 04 3D FF	y0 50 02 FF	On
		y0 50 03 FF	Off
CAM_ICRModelInq	8x 09 04 01 FF	y0 50 02 FF	On (Night)
		y0 50 03 FF	Off (Day)
CAM_AutoICRModelInq	8x 09 04 51 FF	y0 50 02 FF	On
		y0 50 03 FF	Off
CAM_AutoICRThresholdInq	8x 09 04 21 FF	y0 50 00 00 0p 0q FF	pq: ICR OFF(Day)->ON(Night) threshold level 00: Low; 01: Middle; 02: High
CAM_IDInq	8x 09 04 22 FF	y0 50 0p 0q 0r 0s FF	pqrs: Camera ID
CAM_VersionInq	8x 09 00 02 FF	y0 50 ab cd mn pq rs tu vw FF	abcd: Vendor Code, AVer: 2574 mnpq: Model Code, MD120UI: 0565 rstu: Firmware version (ex: 4025 for 1.1.4025.0) vw: Socket Number (=02)
CAM_MenuModelInq	8x 09 06 06 FF	y0 50 02 FF	On
		y0 50 03 FF	Off
Video Format Inq	8x 09 06 23 FF	y0 50 02 FF	1920x1080P/60
		y0 50 03 FF	1920x1080P/59.94
		y0 50 04 FF	1920x1080P/30
		y0 50 05 FF	1920x1080P/29.97
		y0 50 08 FF	1920x1080I/60
		y0 50 0A FF	1920x1080I/59.94
		y0 50 0B FF	1280x720P/60
		y0 50 0C FF	1280x720P/59.94
		y0 50 0D FF	1920x1080P/50

Inquiry Command	Command Packet	Inquiry Packet	Comments
		y0 50 18 FF	1920x1080P/25
		y0 50 22 FF	1920x1080I/50
		y0 50 26 FF	1280x720P/50
		y0 50 30 FF	3840x2160P/60
		y0 50 31 FF	3840x2160P/59.94
		y0 50 32 FF	3840x2160P/50
		y0 50 33 FF	3840x2160P/30
		y0 50 34 FF	3840x2160P/29.97
		y0 50 35 FF	3840x2160P/25
IR_Receive	8x 09 06 08 FF	y0 50 02 FF	On
		y0 50 03 FF	Off
Pan-tiltPosInq	8x 09 06 12 FF	y0 50 0Y 0Y 0Y 0Y 0Z 0Z 0Z 0Z FF	YYYY: Pan Position 7FFF(170°) to 8000 (-170°) (Normalized, CENTER 0000) ZZZZ: Tilt Position 7FFF(90°) to 8000(-30°) (Image Flip: OFF) (Normalized, CENTER 0000)
CAM_Preset_Inq	8x 09 04 3F FF	y0 50 pp FF	Return the last preset number which has been operated pp:01-FF
Pan-tiltMaxSpeedInq	8x 09 06 11 FF	y0 50 ww zz FF	ww = Pan Max Speed zz = Tilt Max Speed
Freeze_Mode_Inq	8x 09 04 62 01 FF	y0 50 02 FF	On
		y0 50 03 FF	Off
Preset_Freeze_Inq	8x 09 04 62 02 FF	y0 50 02 FF	On
		y0 50 03 FF	Off
RTMP_Inq	8x 09 04 A2 FF	y0 50 02 FF	On
		y0 50 03 FF	Off
Preset_Speed_Inq	8x 09 06 20 FF	y0 50 0p FF	p=1 (Low) to 6 (High)
Firmware version	8x 09 36 69 04 FF	y0 50 0p 0q 0r 0s 0t 0u 0v 0w FF	fw_ver: p.q.rstu.vw

Configuración de VISCA over IP

PORT

Internet protocol	IPv4
Transport protocol	UDP
Port address	52381

FORMAT

	byte 0	byte 1	byte 2	byte 3	byte 4	byte 5	byte 6	byte 7	byte 8 ~~~ byte 23
func	Payload type		Payload Length		Sequence number			Payload (1 to 16 bytes)	
data	Value1	Value2	1~16(0x0001~0x0010)		0x00000000 ~ 0xFFFFFFFF			VISCA Packet (see page VISCA)	

Payload type

Name	Value1	Value2	Description
VISCA command	0x01	0x00	Stores the VISCA command.
VISCA inquiry	0x01	0x10	Stores the VISCA inquiry.
VISCA reply	0x01	0x11	Stores the reply for the VISCA command and VISCA inquiry, or VISCA device setting command
VISCA device setting command	0x01	0x20	Stores the VISCA device setting command.
Control command	0x02	0x00	Stores the control command
Control reply	0x02	0x01	Stores the reply for the control command.

Comando de CGI

CGI List for Video Transmission					
CGI item name	URL	Command	Parameter Name	Parameter value	Description
Get JPEG	/snapshot				1280x720 jpg
Get 4K JPEG	/cgi-bin?OnePush=n				Step 1: request 4k snapshot
	/snapshot?res=4k				Step 2: get 3840x2160 jpg
Get RTSP stream	rtsp://ip/live_st1				

CGI List for Audio					
CGI item name	URL	Command	Parameter Name	Parameter value	Description
Audio In Volume	/cgi-bin?Set=	ado_vol,3,N		0 ~10	0 ~ 10 volume

CGI List for Camera Control					
CGI item name	URL	Command	Parameter Name	Parameter value	Description
up start	/cgi-bin?SetPtf=	1,0,1			
up end	/cgi-bin?SetPtf=	1,0,2			
down start	/cgi-bin?SetPtf=	1,1,1			
down end	/cgi-bin?SetPtf=	1,1,2			
left start	/cgi-bin?SetPtf=	0,1,1			
left end	/cgi-bin?SetPtf=	0,1,2			
right start	/cgi-bin?SetPtf=	0,0,1			
right end	/cgi-bin?SetPtf=	0,0,2			
zoom_in start	/cgi-bin?SetPtf=	2,0,1			
zoom_in end	/cgi-bin?SetPtf=	2,0,2			
zoom_out start	/cgi-bin?SetPtf=	2,1,1			
zoom_out end	/cgi-bin?SetPtf=	2,1,2			
set preset:	/cgi-bin?ActPreset=	1,N			N : position
load preset:	/cgi-bin?ActPreset=	0,N			N : position

CGI List for Various Settings					
CGI item name	URL	Command	Parameter Name	Parameter value	Description
exposure value	/cgi-bin?Set=	img_expo_expo,3,N	value	1 ~ 9	N : value
saturation	/cgi-bin?Set=	img_saturation,3,N	value	0 ~ 10	N : value
contrast	/cgi-bin?Set=	img_contrast,3,N	value	0 ~ 4	N : value

Tracking on:	/cgi-bin?Set=	trk_tracking_on,3,1			
Tracking off:	/cgi-bin?Set=	trk_tracking_on,3,0			
Reboot	GET(Basic Authentication)	/cgi-bin?OnePush=!			
Factory Reset	GET(Basic Authentication)	/cgi-bin?OnePush=d			
RTMP Start streaming	/cgi-bin?Set=	vdo_rtmp_enable,3,1			
RTMP Stop streaming	/cgi-bin?Set=	vdo_rtmp_enable,3,0			
Status get (Model name & mac & FW_VER)	/cgi-bin?GetString=	sys_name&net_mac&sys_fw_version			http://10.100.105.110/cgi-bin?GetString=sys_name&net_mac&sys_fw_version
Serial No. get	/cgi-bin?GetSerialNumber				http://10.100.105.110/cgi-bin?GetSerialNumber
oneclick	/cgi-bin?Set=	ptz_oneclick_x,3,N1&ptz_oneclick_y,3,N2&ptz_oneclick_spd,3,N3		ptz_one_click_spd 1~24	N1, N2 = X, Y coordinates (1080P, 0,0 at top left) N3=moving speed
IR Cut Filter	/cgi-bin?Set=	img_ircut_filter,3,N		0 ~ 2	0 = Day, 1 = Night, 2 = Auto
IR Cut Filter Sensitivity	/cgi-bin?Set=	img_ircut_sensitivity,3,N		0 ~ 2	0 = Low, 1 = Middle, 2 = High

CGI List for AI Settings					
CGI item name	URL	Command	Parameter Name	Parameter value	Description
Eyes Tracking On/Off	/cgi-bin?Set=	trk_tracking_on,3,N	value	0 / 1	0: OFF; 1: ON
Tracking Preset	/cgi-bin?ActPreset=1,255				Save current pos. for eye tracking preset point.
Timeout to preset	/cgi-bin?Set=	trk_lost_time,3, N	value	3 / 5 / 7 / 10	timeout in seconds
Tracking Site	/cgi-bin?Set=	trk_mode,3,N	value	0 / 1	0: Full face; 1: Eyes
Tracking Range	/cgi-bin?Set=	trk_sensitivity,3,N	value	0 ~ 2	0: Close; 1: Medium; 2: Wide
Eyes Tracking On/Off Get	/cgi-bin?Get=trk_tracking_on				
	- Reply	On trk_tracking_on=1			

		Off trk_tracking_on=0			
Audio Detection On/Off	/cgi-bin?Set=	ado_det_alarm,3,N	value	0 / 1	0: OFF; 1: ON
Alarm Detection Type	/cgi-bin?Set=	ado_alm_general,3,N	value	0 / 1	general type. 0: OFF; 1: ON
		ado_alm_oxygen,3,N	value	0 / 1	oxygen type. 0: OFF; 1: ON
		ado_alm_ventilation,3,N	value	0 / 1	ventilation type. 0: OFF; 1: ON
		ado_alm_cardiovascular,3,N	value	0 / 1	cardiovascular type. 0: OFF; 1: ON
		ado_alm_temperature,3,N	value	0 / 1	temperature type. 0: OFF; 1: ON
		ado_alm_drug,3,N	value	0 / 1	drug type. 0: OFF; 1: ON
		ado_alm_artificial,3,N	value	0 / 1	artificial type. 0: OFF; 1: ON
		ado_alm_power,3,N	value	0 / 1	power type. 0: OFF; 1: ON
		ado_alm_information,3,N	value	0 / 1	information type. 0: OFF; 1: ON

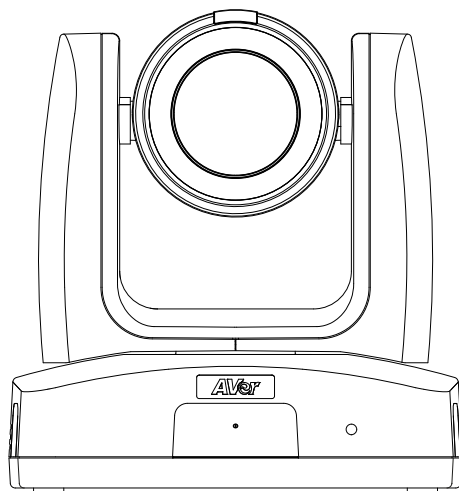

MD120UI Telecamera di tracciamento

Manuale utente



Come pulire e disinfettare

Attenzione Rischio di lesioni personali	Non utilizzare agenti di pulizia contenenti fenolo, poiché il fenolo può causare ustioni cutanee se non risciacquato accuratamente e non contiene sufficienti proprietà detergenti o disinfettanti.
Cautela	<ol style="list-style-type: none">1. La fotocamera è progettata per una facile pulizia e disinfezione.2. Prima di pulire la fotocamera, scollegarla dalla fonte di alimentazione.3. Le procedure di pulizia dovrebbero essere eseguite solo dal personale che conosce bene il funzionamento della fotocamera.4. Non spruzzare liquidi per la pulizia, in particolare acqua, in qualsiasi apparecchiatura elettrica interna o parti della fotocamera per evitare possibili cortocircuiti, corrosione, malfunzionamenti e rischi di scossa elettrica per gli utenti o il personale di servizio.1. Gli agenti di pulizia corrosivi possono causare decolorazione o danneggiare la fotocamera. Prima di utilizzare qualsiasi agente di pulizia, testarlo in un'area poco visibile.
Quando	Pulire la fotocamera prima e dopo l'uso.
Passaggi	<ol style="list-style-type: none">1. Scollegare la fotocamera dalla fonte di alimentazione.2. Il personale di pulizia deve indossare i guanti per la pulizia.3. Prima di utilizzare l'alcol per la pulizia, assicurarsi che non sia scaduto.4. Utilizzare un panno per la pulizia inumidito con alcol per la pulizia (75%).5. Pulire qualsiasi superficie che potrebbe entrare in contatto con la fotocamera.1. Dopo aver pulito il dispositivo, evitare il contatto con le mani nude.
Frequenza	Non è richiesta una pulizia regolare. Pulire prima e dopo l'uso.

Simboli sul prodotto

I simboli su questo prodotto, accessori inclusi, rappresentano quanto segue.

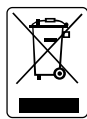

Il simbolo WEEE.

Questo simbolo indica che il prodotto non deve essere smaltito con gli altri rifiuti domestici. Sarà necessario smaltire la strumentazione di scarto presso un apposito punto di smaltimento per il riciclaggio della strumentazione elettrica ed elettronica. Per ulteriori informazioni sui punti in cui scaricare i dispositivi di scarto per procedere al riciclaggio degli stessi invitiamo a contattare il proprio servizio di smaltimento dei rifiuti oppure il negozio presso il quale è stato acquistato il prodotto.



Il logo di conformità CE.

Questo logo indica che il prodotto è conforme alle linee guida/standard pertinenti per la legislazione di armonizzazione dell'Unione Europea.



Il logo di conformità FCC.

Questo logo indica che il prodotto è conforme agli standard di conformità della Federal Communications Commission.



Il simbolo UKCA (UK Conformity Assessed).

Questo simbolo indica che un prodotto immesso sul mercato britannico soddisfa i requisiti del marchio UKCA.



Il logo di conformità RCM.

Questo logo indica che il prodotto è conforme alle linee guida australiane RCM.



Questo logo è stato pensato per avvisare gli utenti della presenza di "tensione pericolosa" non isolata all'interno del prodotto. Questa tensione potrebbe essere di entità tale a costituire un rischio di scossa elettrica per le persone.



Questo logo è stato pensato per avvisare gli utenti della presenza di importanti istruzioni d'uso e di manutenzione nella documentazione che accompagna il dispositivo.



Il simbolo RoHS della Cina.

La cifra di questo simbolo rappresenta il numero di anni durante i quali, in condizioni d'uso normali, non si verificherebbero perdite o mutazioni di sostanze pericolose.



Il simbolo della corrente alternata.

Questo simbolo indica che l'ingresso/uscita di corrente del prodotto è a corrente alternata.



Il simbolo della corrente continua.

Questo simbolo indica che l'ingresso/uscita di potenza del prodotto è in corrente continua.

Avvertenza

Questo è un prodotto di classe A. In ambienti domestici, il dispositivo può provocare interferenze radio; in questo caso è opportuno prendere le adeguate contromisure.

Informazioni sulla sicurezza delle batterie del telecomando

- Conservare le pile in un luogo fresco e secco.
- Non smaltire le pile usate insieme ai rifiuti domestici. Smaltire le pile presso gli specifici punti di raccolta o, eventualmente, riportarle in negozio.
- Rimuovere le batterie se non vengono utilizzate per un lungo periodo di tempo. Le perdite delle pile e la corrosione potrebbero danneggiare il telecomando. Smaltire le pile in modo sicuro.
- Non mescolare e usare pile vecchie e nuove.
- Non mescolare e usare diversi tipi di pile alcaline, standard (carbone-zinco) o ricaricabili (nickel-cadmio).
- Non smaltire le pile nel fuoco.
- Non cercare di cortocircuitare i terminali della batteria.

RINUNCIA

Non viene fornita nessuna garanzia o rappresentazione, espressa o implicita, relativamente ai contenuti della presente documentazione, oltre che a livello di qualità, performance, commerciabilità o idoneità per un determinato scopo. La correttezza delle informazioni contenute in questa documentazione è stata attentamente vagliata; non ci assumiamo tuttavia alcuna responsabilità per eventuali imprecisioni. Le informazioni contenute in questa documentazione sono soggette a modifiche senza preavviso.

AVer non sarà in nessun caso responsabile per danni diretti, indiretti, speciali, accidentali o consequenziali derivanti dall'uso o dall'incapacità di usare il prodotto o la documentazione, anche qualora siano state fornite informazioni relativamente alla possibilità dei summenzionati danni.

MARCHI COMMERCIALI

"AVer" è un marchio registrato da AVer Information Inc. Altri marchi commerciali qui usati unicamente a scopo descrittivo appartengono alle rispettive aziende.

COPYRIGHT

©2023 Tutti i diritti di questo oggetto appartengono ad AVer Information Inc. | 7 luglio 2023
La riproduzione o la trasmissione in qualsiasi forma, o con qualsiasi mezzo senza disporre del previo consenso di AVer Information Inc. è vietata. Tutte le informazioni o le specifiche sono soggette a variazioni senza previa notifica.

Altro Aiuto

Per Domande tecniche, assistenza tecnica, download di software e manuale di istruzioni, invitiamo a visitare:

Centro download: <https://www.avereurope.com/download-center>

Assistenza tecnica: <https://www.avereurope.com/technical-support>

Informazioni di contatto

AVer Information Europe B.V.

<https://www.avereurope.com>

Westblaak 134, 3012KM, Rotterdam, The Netherlands

Tel: +31 (0) 10 7600 550

Assistenza tecnica: eu.rma@aver.com

Contenuti

Come pulire e disinfettare	2
Panoramica	1
Contenuto della confezione	1
Accessori opzionali	1
Dimensioni	2
Montaggio a soffitto.....	3
Montaggio a parete	4
Panoramica e angolo inclinazione	4
Installazione	5
Piastra di fissaggio dei cavi.....	5
Montaggio a soffitto.....	6
Collegamento.....	7
Indicatore Privacy.....	7
Indicatore LED	7
Connessione del dispositivo.....	8
Telecomando	11
Collegamenti	12
Configurare la telecamera	13
Menu OSD	13
Configurazione dell'indirizzo IP	13
Struttura del Menu OSD	15
Configurazione web	18
Accedere all'interfaccia web della telecamera.....	18
Vista in diretta (Live View).....	20
Impostazione IA (AI Setting).....	22
Impostazioni della telecamera (Camera Settings).....	24
Video & Audio (Video & Audio).....	26
Rete (Network).....	27

Sistema (System).....	29
AVerCamera Setting Tool	31
Specifiche.....	32
Risoluzione dei problemi	35
Appendice	36
Tabella dei comandi RS-232 VISCA	36
Impostazioni VISCA over IP	44
Comando CGI	45

Panoramica

La telecamera MD120UI, con funzionalità di tracking, è una telecamera di livello medico progettata per il monitoraggio dei pazienti. È dotata di visione notturna a infrarossi e di un alloggiamento resistente ai raggi UV.

Contenuto della confezione

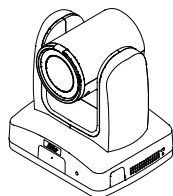

Telecamera

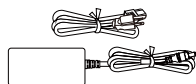

Adattatore di alimentazione
cavo di alimentazione

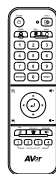

Telecomando



Cavo USB 3.0 da Tipo
B a Tipo A (1.5M)

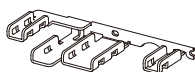

Piastra di fissaggio
dei cavi

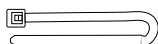

Ferma cavi (x4)

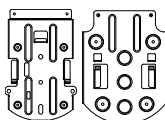

Staffa di montaggio a
soffitto (2)

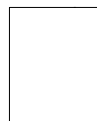

Modello per
l'esecuzione dei fori



M2 x 4mm
vite (x3)



M3 x 6mm
vite (x3)



1/4"-20 L=6.5mm
vite (x2)



Guida rapida

Accessori opzionali

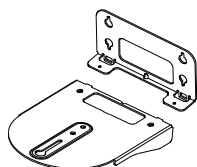

Staffa per il
montaggio a parete

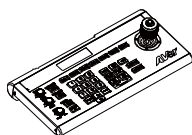

Controller della
telecamera (CL01)

Dimensioni

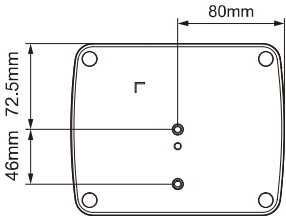
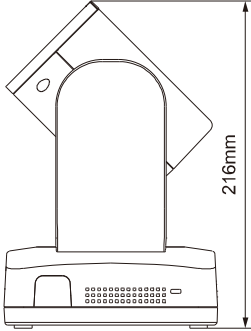
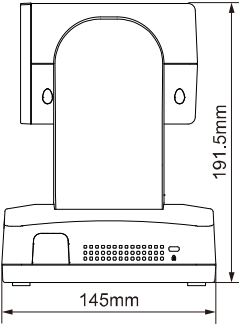
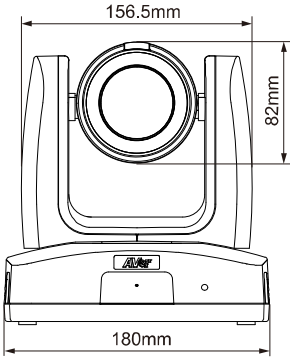

Montaggio a soffitto

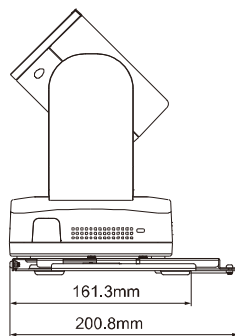
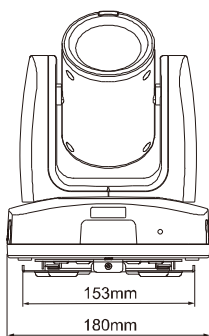
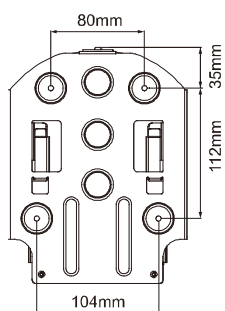
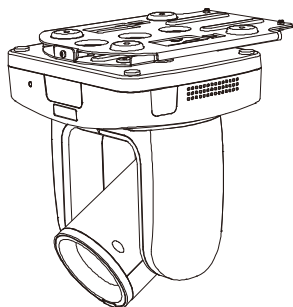

Montaggio a parete

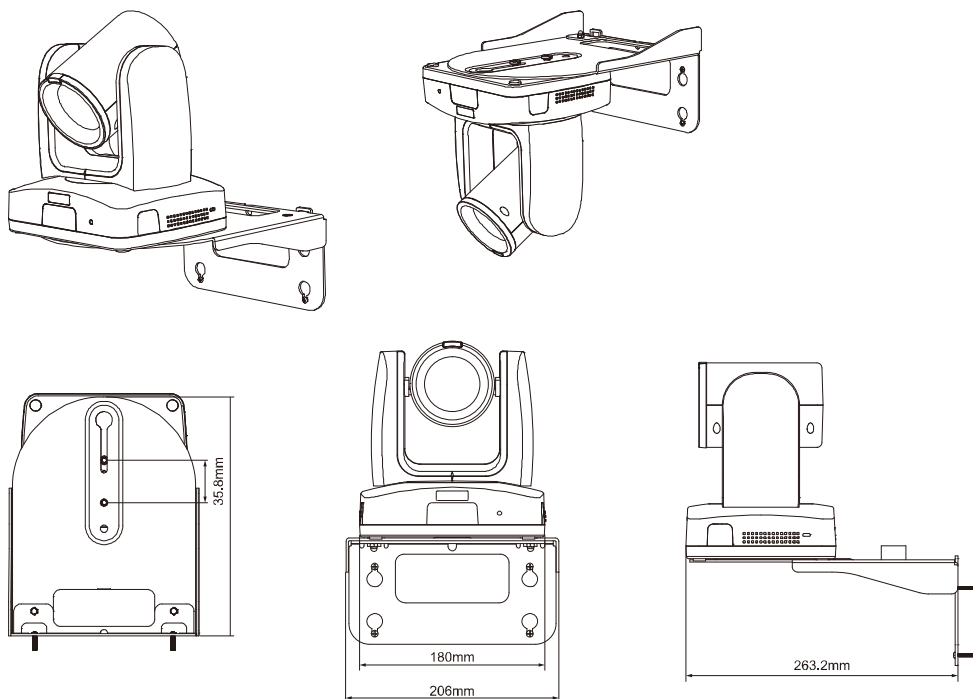

Panoramica e angolo inclinazione

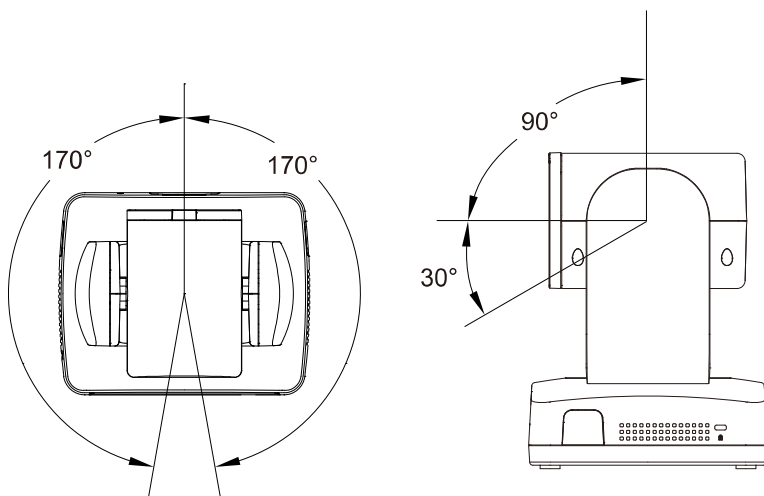

Installazione

Piastra di fissaggio dei cavi

1. Fissate la piastra di fissaggio dei cavi alla telecamera usando le viti M2 x 4 mm presenti nella confezione.

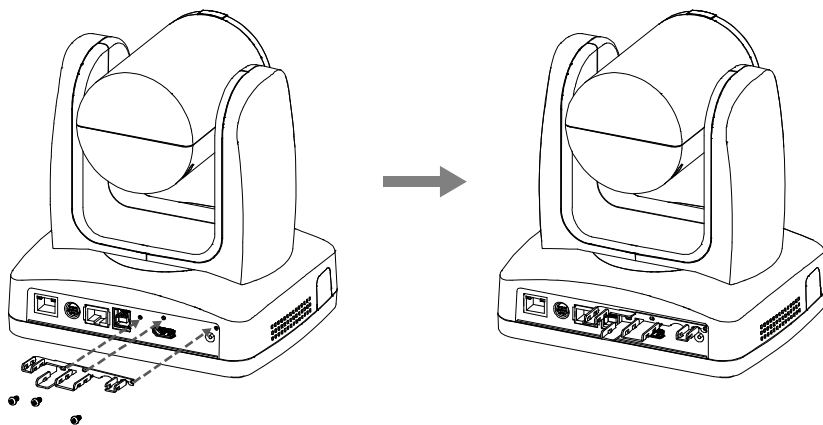

2. Collegare i cavi.

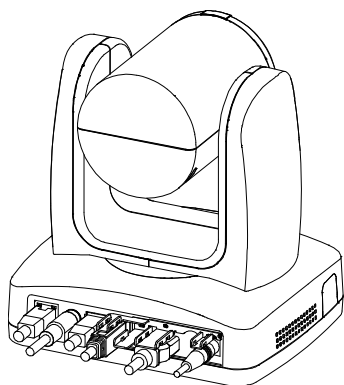

3. Fissate i cavi alla piastra di fissaggio dei cavi con fascette stringicavo attraverso le fessure.

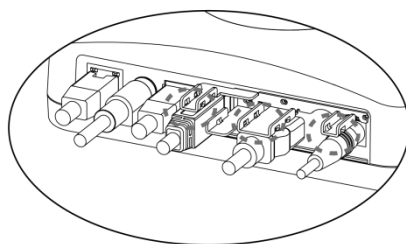

Montaggio a soffitto

1. Fissare la staffa di montaggio al soffitto.

Viti: 4 viti, M4 x 10 mm (non incluse)

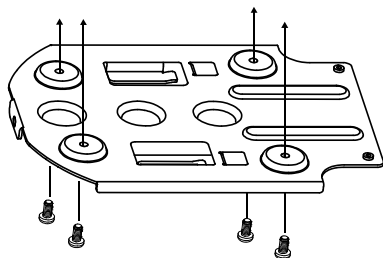

2. Fissare la staffa di montaggio sulla telecamera.

Viti: 2 viti, 1/4"-20 L=6,5mm (incluse)

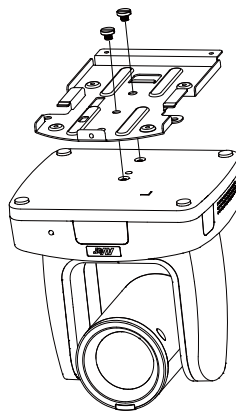

3. Far scorrere la staffa di montaggio con la telecamera nella staffa di montaggio fissata al soffitto. E collegare i cavi.

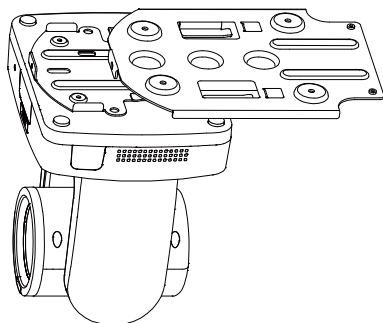

4. Fissare le staffe con delle viti.

Viti: 3 viti, M3 x 6mm (incluse)

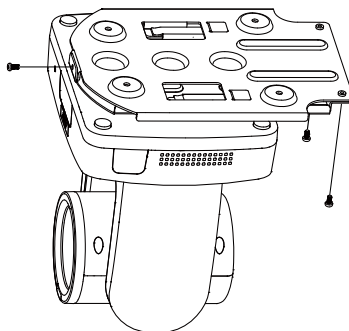

Collegamento

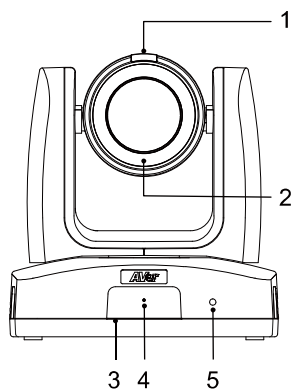

Fronte

1. Indicatore Privacy
2. LED per la visione notturna a infrarossi*
3. Sensore IR
4. Microfono
5. Indicatore LED

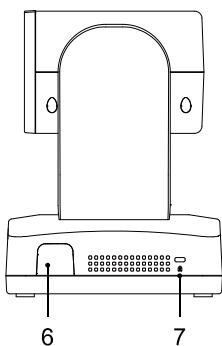

Lato

6. Sensore IR
7. Blocco Kensington

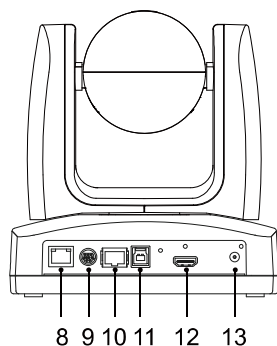

Retro

8. Porta PoE+
9. Porta RS-232
10. Porta RS-422
11. Porta USB 3.1 di tipo B
12. Porta HDMI
13. Presa di alimentazione CC

*Per evitare il rischio di radiazioni infrarosse, mantenere una distanza di oltre 1 metro tra il LED IR e gli occhi umani quando si utilizza la modalità notturna.

Indicatore Privacy

Colore	Stato
Verde fisso	Monitoraggio del paziente in corso...
Nessuna luce	Modalità Privacy / Spegnimento

Indicatore LED

Colore	Stato
Blu fisso	Normale
Blu lampeggiante	La modalità tracking è attiva
Arancione fisso	Standby
Arancione lampeggiante	Avvio
Viola fisso	Il menu OSD è attivato.
Viola lampeggiante	Aggiornamento del firmware in corso

Connessione del dispositivo

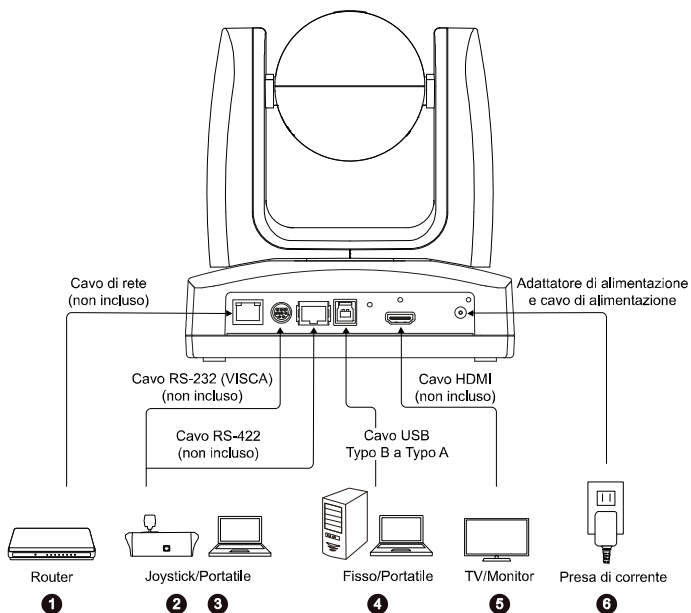

1. **LAN:** Collegare la telecamera a un router IP attraverso la porta LAN. (Nota)
2. **RS-232:** Collegare la telecamera a un joystick o a un computer portatile per controllarla. È possibile acquistare l'adattatore RS-232. La definizione dei PIN viene indicata qui di seguito. (Nota)

- **Definizione PIN**

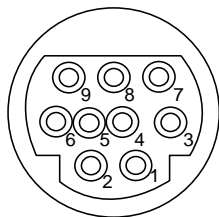

Funzione	Mini DIN9 PIN #	Tipo I/O	Segnale	Descrizione
INGRESSO VISCA	1	Uscita	DTR	Terminale Dati Pronto
	2	Ingresso	DSR	Set Dati Pronto
	3	Uscita	TXD	Dati di trasmissione
	6	Ingresso	RXD	Dati del ricevitore
USCITA VISCA	7	Uscita	DTR	Terminale Dati Pronto
	4	Ingresso	DSR	Set Dati Pronto
	8	Uscita	TXD	Dati di trasmissione
	9	Ingresso	RXD	Dati del ricevitore
	5	Ingresso	I/O	Rilevare DIN8/DIN9
---	Schermatura	---	TERRA	Terra

3. **RS-422:** Collegare la telecamera a un joystick o a un computer portatile per controllarla. Utilizzare uno splitter CAT5e per il collegamento di più telecamere.

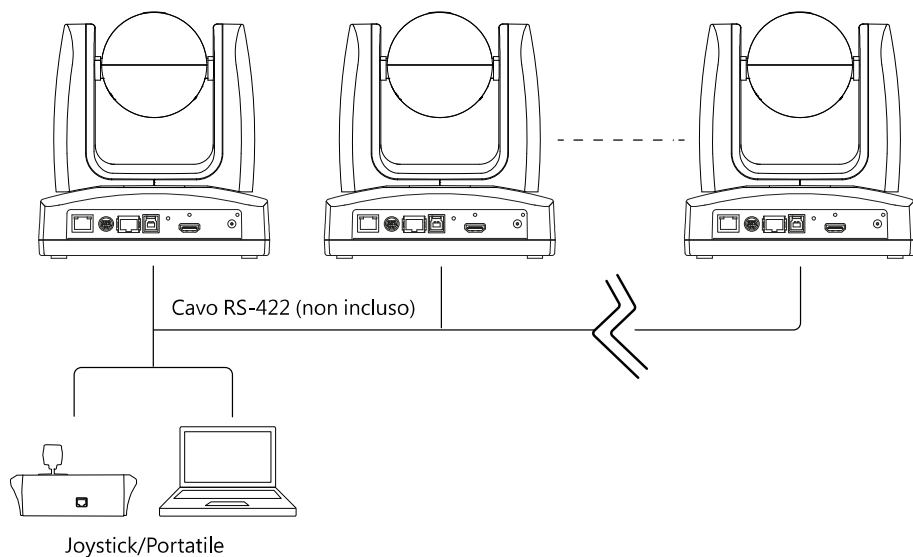

● **Definizione PIN**

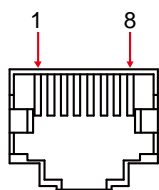

Numero	Pin	Numero	Pin
1	TX+	5	TX-
2	TX-	6	RX-
3	RX+	7	RX+
4	TX+	8	RX-

● **Assegnazione PIN Splitter CAT5e**

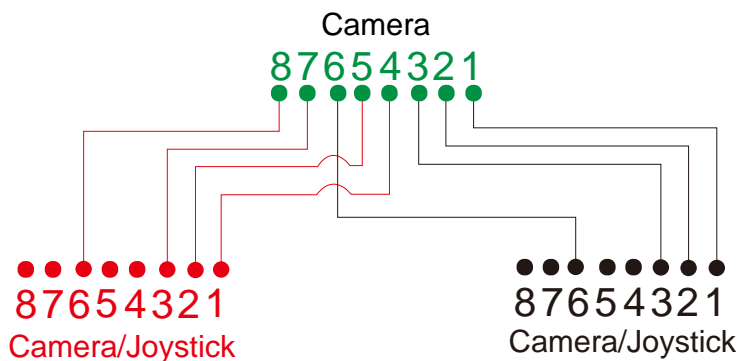

4. **USB Type-B:** Collegare la telecamera a un computer fisso o portatile per la trasmissione video quando si utilizza un altro software di videoconferenza come ad esempio Skype o Teams.
(Nota)
5. **HDMI:** Collegare la telecamera a un televisore o a un monitor per visualizzare l'uscita video. La fotocamera e la TV o il monitor collegati devono essere dotati di messa a terra. (Nota)
6. **Alimentazione:** La fotocamera e la TV o il monitor collegati devono essere dotati di messa a terra. Usare l'adattatore di alimentazione e il cavo di alimentazione in dotazione per collegare la telecamera a una presa di corrente e verificare che il cavo di alimentazione della TV o del monitor supporti la spina di messa a terra.

Nota:

Accessory equipment connected to the analog and digital interfaces must be in compliance with the respective nationally harmonized IEC standards (i.e. IEC 60950 for data processing equipment, IEC 60065 for video equipment, IEC 61010-1 for laboratory equipment, and IEC 60601-1 for medical equipment.) Furthermore all configurations shall comply with the requirements of the system in standard IEC 60601-1. Everybody who connects additional equipment to the signal input part or signal output part configures a medical system, and is therefore, responsible that the system complies with the requirements of the system in standard IEC 60601-1. The unit is for exclusive interconnection with IEC 60601-1 certified equipment in the patient environment and IEC 60XXX certified equipment outside of the patient environment. If in doubt, consult the technical services department or your local representative.

Telecomando

Per il telecomando sono necessarie due batterie "AAA". Assicurarsi che le batterie siano inserite correttamente prima dell'uso.

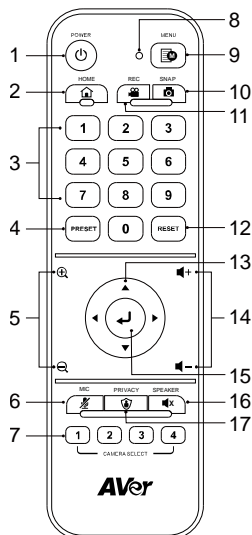







Model: LY033

Nome	Funzione
1. Alimentazione	Premere brevemente per attivare/disattivare la Modalità Standby.
2. Home	Portare la telecamera in posizione Home. <ul style="list-style-type: none"> ● Premere i pulsanti 0~9 per spostare la telecamera sulle posizioni pre-configurate. ● Utilizzare i pulsanti per impostare le posizioni di preselezione 0~9.
3. Pulsanti numerici	Utilizzare i pulsanti Preset, Numero e Direzione per impostare le posizioni preimpostate. <ol style="list-style-type: none"> Usare i pulsanti di Direzione per spostarsi su una determinata posizione. Sarà possibile utilizzare i pulsanti "Zoom +" o "Zoom -" per ingrandire o ridurre l'immagine. Tenere premuto Preset, quindi premere i pulsanti numerici (0~9) per salvare la posizione di preselezione.
4. Preset	Premere per ingrandire o rimpicciolire l'immagine.
5. Zoom +/-	Premere per disattivare il microfono. Premere nuovamente per riattivarlo.
6. Microfono	Selezionare una telecamera da usare. Indicare un numero nel menu OSD: Sistema > Camera Selector .
7. Selezione della telecamera	Quando si premono i tasti del telecomando, il LED si illumina di rosso.
8. Telecomando LED	Premere e tenere premuto il pulsante per 3 secondi per aprire il menu OSD. Modificare questa impostazione nel menu OSD: System > Trigger OSD .
9. Menu	N/A
10.Scatta	N/A
11.Rec	N/A
12.Reset	Servirsi dei pulsanti Reset e Numero per annullare una posizione preconfigurata. Tenere premuto Reset, quindi premere i pulsanti numerici (0~9).

13.Pulsanti direzione	Usare i pulsanti di Direzione per spostarsi all'interno della vista dal vivo.
14.Volume +/-	N/A
15.Invio	Quando la fotocamera è accesa: premi Invio per regolare la messa a fuoco una volta. Quando si accede al menu OSD: premere Invio per confermare la selezione o effettuare una selezione.
16.Altoparlanti	N/A
17.Privacy	Premere per accedere alla modalità Privacy. La telecamera si sposterà nella posizione Privacy e il microfono sarà spento.

Collegamenti

Press	To
Menu  per 3 secondi	Aprire il menu OSD.
Menu 	Chiudere il menu OSD.
Home 	Chiudere il menu OSD e riportare la telecamera in posizione Home.
Menu  poi Zoom 	Alternare fra Modalità Giorno e Modalità Notte.
Menu  poi Zoom 	Alternare fra Modalità Giorno e Modalità Auto.
5 cinque volte (55555)	Attivare DHCP.
6 sei volte (666666)	Ripristinare le impostazioni di fabbrica della fotocamera.
8 otto volte (88888888)	Impostare l'indirizzo IP statico della telecamera su 192.168.1.168.

Configurare la telecamera

Sarà possibile configurare le impostazioni della telecamera utilizzando il menu OSD o l'interfaccia Web della telecamera.

Menu OSD

Per accedere al menu OSD, collegare la telecamera a un monitor o a un televisore utilizzando il cavo HDMI, quindi sarà possibile utilizzare il telecomando in dotazione per azionare il menu OSD.

Premere e tenere premuto **Menu**  per 3 secondi sul telecomando per richiamare il menu OSD e utilizzare **▲▼◀▶** per selezionare le pagine o le opzioni e premere **↵** per confermare le impostazioni.

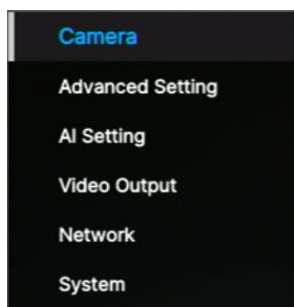

Configurazione dell'indirizzo IP

Static IP

1. Premere il pulsante **Menu**  per 3 secondi sul telecomando per richiamare il menu OSD.
2. Andare su **Network > Static IP**.

[Nota] Attivare l'opzione **DHCP** prima di impostare un IP statico (**Network > DHCP > OFF**).

3. Selezionare **IP Address**, **Gateway**, **Netmask**, e **DNS** per configurare. Premere **↵** e utilizzare i tasti numerici per inserire il valore.

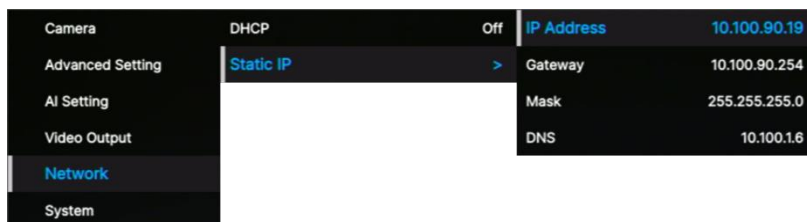

DHCP

1. Premere il pulsante **Menu**  per 3 secondi sul telecomando per richiamare il menu OSD.
2. Selezionare **Network > DHCP > On**.
3. Premere **↵** per confermare l'impostazione.



4. Dopo aver attivato la funzione **DHCP** è possibile andare in **System > Information** per visualizzare l'indirizzo IP.

Camera	Trigger OSD	Press Menu 3 sec	Model Name	MD120UI
Advanced Setting	Camera Selector	All	Serial Number	5100435000010
AI Setting	Status OSD	Off	Version	1.1.0502.0
Video Output	Language	English	IP Address	0.0.0.0
Network	Information	>	MAC	00:18:1A:0C:BA:4E
System	Factory Default	>	Lens	C004
	System Reboot	>	Mcu	A001

Struttura del Menu OSD

1° livello	2° livello	3° livello	4° livello
Telecamera	Exposure Mode	Full Auto	Exposure Value
			Gain Limit Level
			Slow Shutter
			BLC
			WDR
		Shutter Priority	Exposure Value
			Shutter Speed
			Gain Limit Level
		Iris Priority	Exposure Value
			Iris Level
			Gain Limit Level
			Slow Shutter
		Manual	Iris Level
			Shutter Speed
			Gain Level
	Bright mode	Bright value	
	White Balance	Auto	
		ATW	
		Indoor	
		Outdoor	
		One push trigger	
		Manual	R gain
			B gain
	Pan Tilt Zoom	Preset Speed	5, 25, 50, 100, 150, 200
		Preset Accuracy	Off / On
		Pan Speed	1~24
		Tilt Speed	1~24
		Zoom Speed	Low / High
		P/T Spd. Relative Z Ratio	Off / On
		Pan L/R Dir. Switch	Off / On

	Noise filter	Off / Low / Middle / High	
	Saturation	0 1 2 3 4 5 6 7 8 9 10	
	Contrast	0 1 2 3 4	
	Sharpness	0 1 2 3	
	Mirror	OFF / ON	
	Flip	OFF / ON	
Advanced Setting	Audio	Audio Volume	0~10
	Control	Type	RS232 / RS422
		Protocol	VISCA
		Camera Address	1 2 3 4 5 6 7
		Baud Rate	4800 / 9600 / 38400
	IR Cut Filter	Auto / Day / Night	
IR Cut Sensitivity	Low / Middle / High		
AI Setting	Facial Tracking	Eyes Tracking	On/Off
		Tracking Preset	Save
		Tracking Site	Full Face / Eyes
		Tracking Range	Close / Medium / Wide
		Timeout to Preset	3/5/7/10 sec
	AI Audio Detection	Audio Detection	On/Off
Video Output	Theme Mode	HDMI / UVC	
	Frequency	60	
		59,94	
		50	
	Resolution	2160p60	
		2160p59	
		2160p50	
		2160p30	
		2160p29	
		2160p25	
		1080p60	
		1080p59	
	1080p50		

		1080p30	
		1080p29	
		1080p25	
		1080i60	
		1080i59	
		1080i50	
		720p60	
		720p59	
		720p50	
Network	DHCP	OFF	
		ON	
	Static IP	IP Address	192.168.1.168
		Gateway	192.168.1.254
		Mask	255.255.255.0
DNS	8.8.8.8		
System	Trigger OSD	Click Menu to open, Press Menu 3 sec	
	Camera Selector	1,2,3,4,All channel, Disable Remote	
	Status OSD	OFF	
		ON	
	Language	English / 中文 / 日本語	
	Information	Model Name	MD120UI
		Serial number	xxxxxxxxxxxxx
		Firmware Version	0.0.0000.00
		IP	192.168.1.168
		MAC	00:18:1a:04:9e:81
		Lens	xxxx
Mcu	xxxx		
Factory Default	Off / On		
System Reboot	Off / On		

Configurazione web

Collegare la telecamera da un sito remoto tramite Internet.

Accedere all'interfaccia web della telecamera

Per accedere all'interfaccia Web della telecamera, è necessario trovare l'indirizzo IP della telecamera utilizzando il software **AVer IPCam Utility** oppure **AVer PTZ Management**.

Accesso alla telecamera tramite AVer IPCam Utility

Per trovare l'indirizzo IP delle telecamere utilizzando il programma di installazione di IPCam Utility, procedere come segue.

1. Scaricare IPCam Utility da <https://www.aver.com/download-center> e avviare IPCam Utility.
2. Fare clic su **Cerca** e sullo schermo verranno elencati tutti i dispositivi disponibili.
3. Selezionare una telecamera dall'elenco, le informazioni sulla telecamera verranno visualizzate nel campo Impostazioni.

[Nota] La rete predefinita della telecamera è IP statico (192.168.1.168) e l'ID/Password predefiniti sono **admin/admin**. Se si desidera configurare la rete su DHCP, inserire l'ID/Password nel campo **Login** selezionare il "modello di telecamera" dall'elenco, selezionare "DHCP" e quindi fare clic sul pulsante **Apply**.

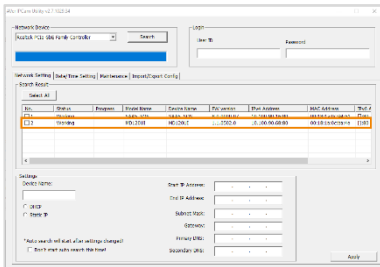

4. Per accedere all'interfaccia Web, fare doppio clic sull'indirizzo IP nella colonna Indirizzo IPv4. Per il primo utente, verrà richiesta una finestra di accesso per modificare l'ID e la password.

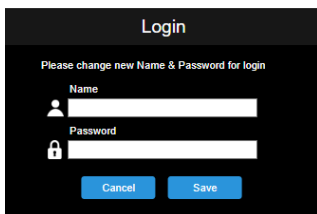

5. Effettuare il login con il nuovo ID/Password; verrà visualizzata l'interfaccia Web della telecamera (browser Chrome). Rimandiamo al capitolo <Vista in diretta> per ulteriori dettagli in merito.

[Nota] Se IPCam utility non riesce a trovare la telecamera, controllare quanto segue:

1. Assicurarsi che la connessione Ethernet della telecamera sia ben collegata.
2. Verificare che la telecamera e il PC (IPCam Utility) si trovino nello stesso segmento LAN.

Accesso alla telecamera tramite AVer PTZ Management

Per trovare l'indirizzo IP delle telecamere utilizzando la funzione AVer PTZ Management attenersi alla seguente procedura.

1. Scaricare il file AVer PTZ Management dal sito <https://www.aver.com/download-center>
2. Scaricare il programma per Windows e installarlo.
3. Dopo aver impostato l'ID utente e la password, accedere al software (nome utente/password di default: admin/admin).

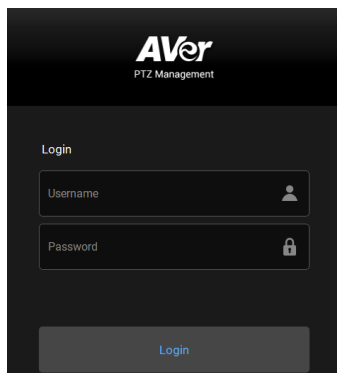

4. Nella pagina principale di PTZ Management fare clic su **Setup > Add** e quindi fare clic su **Auto Search**. Verranno visualizzate le telecamere collegate alla stessa LAN del computer.

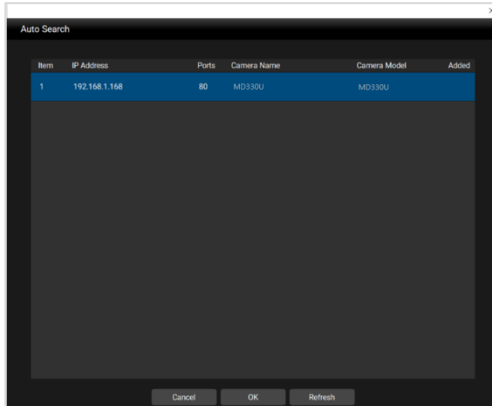
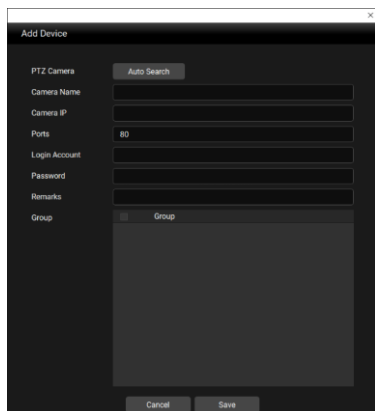





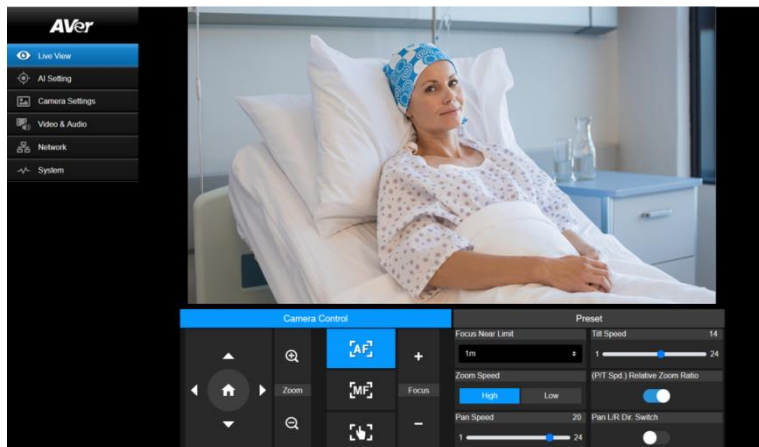

5. Fare clic sulla telecamera e immettere l'ID e la password della telecamera per aggiungerla all'elenco dei dispositivi (l'ID e la password predefinite sono **admin/admin**). Fare clic sul pulsante **Go to Web** per accedere all'interfaccia Web della telecamera.

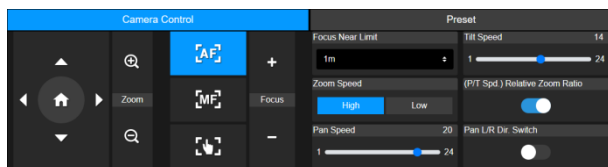
Vista in diretta (Live View)



Controllo telecamera (Camera Control)



Elemento	Descrizione
Controlli pan e tilt 	Posizionare la telecamera. <ul style="list-style-type: none"> ● Trascinare il cursore per regolare i valori Pan Speed e Tilt Speed. ● Attivare Pan L/R Dir. Switch per invertire la direzione di pan. ● Attivare P/T Spd. Relative Z Ratio per regolare automaticamente le velocità di pan e tilt sulla base del rapporto di zoom. Sarà anche possibile attivare questa funzione nel menu OSD: Camera > Pan Tilt Zoom > P/T Spd. Relative Z Ratio.
Posizione Home 	Spostare la telecamera in posizione Home.
Zoom 	Ingrandire o rimpicciolire la vista in tempo reale e selezionare Zoom Speed .
Focus +-	<ul style="list-style-type: none"> ●  Auto Focus: Cliccare per mettere automaticamente a fuoco. ●  Manual Focus: Cliccare per mettere manualmente a fuoco.

Regolare la messa a fuoco con i pulsanti+/-.

-  **One Push Focus:** Cliccare per mettere automaticamente a fuoco una volta.
 - **Focus Near Limit:** Configurare il limite di messa a fuoco più vicino.
-

Preset (Preset)

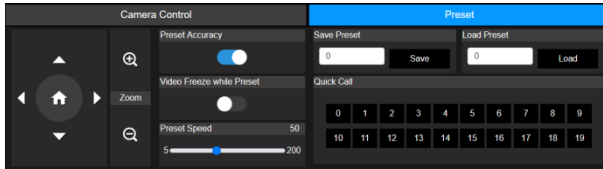

Elemento	Descrizione
Save Preset	<ol style="list-style-type: none">1. Posizionare la telecamera utilizzando i comandi di panoramica, inclinazione e zoom.2. Inserire un numero di preset (0~255) nel campo Save Preset e fare clic su Save.
Load Preset	<ol style="list-style-type: none">1. Inserire un numero di preset (0~255) nel campo Load preset e fare clic su Load.2. In alternativa, cliccare su un numero di preset (0~19) nella sezione Quick Call.
Preset Accuracy	Attivare per migliorare la precisione di spostamento sui preset.
Video Freeze while Preset	Attivare per visualizzare solo la vista dal vivo delle preimpostazioni. La vista dal vivo del percorso in movimento non verrà visualizzata.
Preset Speed	Regolare la velocità della fotocamera quando si passa alle preimpostazioni.

Impostazione IA (AI Setting)



Tracciamento degli occhi (Eyes Tracking)

La regolazione manuale dei controlli di pan, tilt e zoom durante il tracciamento degli occhi disattiva la funzione.

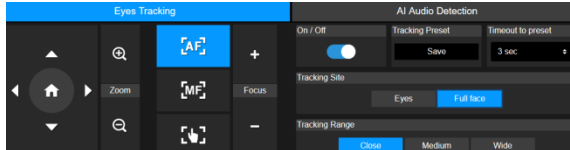

1. Posizionare la telecamera utilizzando i controlli di panoramica, inclinazione e zoom, quindi fare clic su **Save** per salvare un **Tracking Preset**. L'impostazione predefinita è la posizione Home.
2. Dall'elenco a discesa **Timeout to preset**, selezionare un intervallo di tempo prima che la telecamera ritorni alla preimpostazione di tracciamento quando non c'è nessuno in vista. L'impostazione predefinita è 3 secondi.
3. Fare clic sulla levetta **On/Off** per attivare il tracciamento degli occhi quando si vede un volto.
 - Una persona: La telecamera segue e ingrandisce automaticamente il volto.
 - Più persone: La telecamera contrassegna i volti in riquadri. Selezionare un volto da seguire e ingrandire automaticamente facendo clic su un quadrato.
4. Scegliere il **Tracking Site** e il **Tracking Range**.

(Beta) Rilevamento Audio con IA ((Beta) AI Audio Detection)

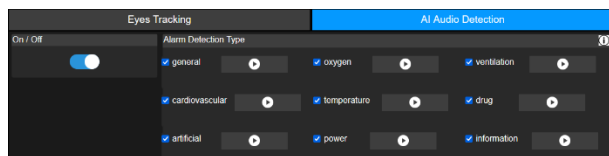

1. Attivare per rilevare gli allarmi selezionati.
2. Fare clic sul pulsante di riproduzione per visualizzare l'anteprima dei suoni degli allarmi.

Impostazioni della telecamera (Camera Settings)



Esposizione (Exposure)

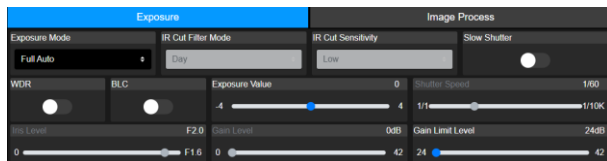

Elemento	Descrizione
Exposure Mode	Selezionare una modalità di esposizione.
WDR	Attivare o disattivare WDR o BLC .
BLC	
Exposure Value	Regolare l'esposizione, l'otturatore, l'iride e il guadagno.
Velocità dell'otturatore	
Iris Level	
Gain Level	
Gain Limit Level	
IR Cut Filter Mode	Selezionare la modalità Day , Night per accendere o spegnere la modalità di visione notturna a infrarossi. In alternativa selezionare la modalità Auto e regolare il valore IR Cut Sensitivity .
Slow Shutter	Attivare o disattivare la funzionalità Slow Shutter .

Elaborazione immagine (Image Process)

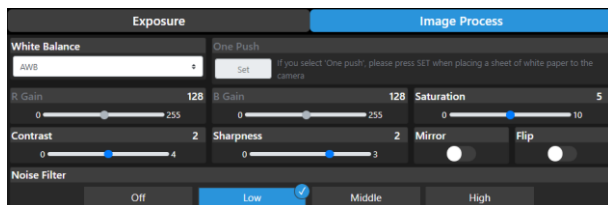

Elemento	Descrizione
White Balance	<ul style="list-style-type: none">● Selezionare una modalità di bilanciamento del bianco. Quando si seleziona Manual, è possibile regolare anche il R Gain e il B Gain.● Quando viene selezionata l'opzione One Push, mettere un pezzo di carta bianca davanti all'obiettivo della telecamera e cliccare su Set per calibrare il bilanciamento dei bianchi.
Saturation	
Contrast	Regolare saturazione, contrasto e nitidezza.
Sharpness	
Mirror	
Flip	Attivare o disattivare Mirror oppure Flip .
Noise Filter	Selezionare un livello di filtraggio del rumore.

Video & Audio (Video & Audio)



Impostazione video

Elemento	Descrizione
Power Frequency (Hz)	Selezionare 50Hz , 59,94Hz o 60Hz in base al paese o alla regione.
Video Out Resolution	Selezionare una risoluzione di uscita video. RTSP: Max. 4K/60fps HDMI: Max. 4K 60Hz
Theme Mode	Selezionare una sovrapposizione video per dare priorità all'uscita UVC o HDMI.
Stream Video Output	Selezionare una risoluzione di uscita dello streaming per la visualizzazione dal vivo.
Framerate	Selezionare un framerate
Bitrate	Selezionare un bitrate.
I-VOP Interval (S)	<ul style="list-style-type: none">● Trascinare il cursore per scegliere la frequenza di comparsa degli I-VOP in un flusso video.● Intervalli più brevi di I-VOP comportano una qualità video superiore, ma anche file di dimensioni maggiori.
Rate Control	Selezionare VBR oppure CBR .
Encoding Type	Selezionare H.264 oppure H.265 .

Audio Setting

Elemento	Descrizione
Microphone Volume	Trascinare il cursore per regolare il volume del microfono.
Sampling Rate	48K
Encoding Type	AAC

Rete (Network)

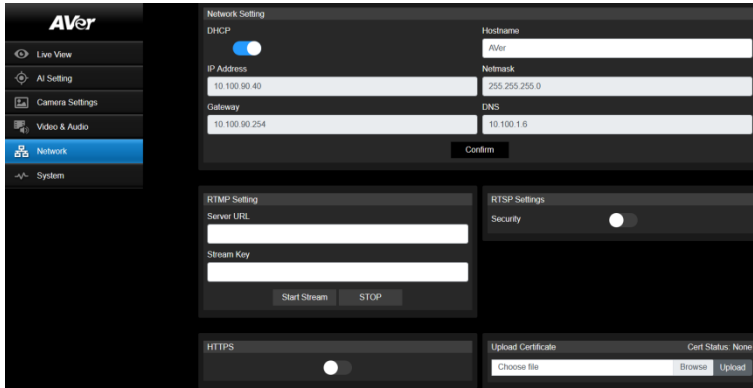

Elemento	Descrizione
Hostname	Il nome host predefinito è AVer. Modificare il nome host per visualizzarlo su dispositivi come un router IP.
DHCP	Impostare la rete su DHCP o IP statico. <ul style="list-style-type: none">● DHCP: Attivare DHCP e fare clic su Confirm per salvare l'impostazione. Alla telecamera verranno assegnate automaticamente le impostazioni IP.● IP statico: disattivare il DHCP, inserire IP Address, Netmask, Gateway e DNS e fare clic su Confirm per salvare le impostazioni.
RTMP Setting	Trasmettere video in diretta a una piattaforma video come YouTube. <ol style="list-style-type: none">1. Inserire Server URL e Stream Key della piattaforma video. Per ottenere l'URL del server e la chiave di streaming, consultare le istruzioni della piattaforma.2. Fare clic su Start Stream per avviare lo streaming, Stop per interrompere lo streaming.

RTSP Settings

Proteggere il flusso video su lettori multimediali quali ad esempio VLC, PotPlayer e QuickTime, garantendo che solo gli utenti autorizzati possano accedervi.

- Quando la funzione **Security** è disattivata:
 1. Immettere l'URL RTSP della videocamera nel lettore multimediale.
 2. URL di RTSP: `rtsp://[camera IP address]/live_st1`
Esempio: `rtsp://192.168.1.100/live_st1`

- Quando la funzione **Security** è attivata:
 1. Immettere l'URL di RTSP della telecamera e il nome utente/password nel lettore multimediale.
 2. URL di RTSP:
`rtsp://[username:password]@[camera IP address]/live_st1`
Esempio: `rtsp://1:1@192.168.1.100/live_st1`
 3. nome utente/password: nome utente/password della telecamera (accesso interfaccia web)

HTTPS

Attivare HTTPS per stabilire una connessione sicura tra il browser e la fotocamera. Per abilitare l'accesso HTTPS sulla fotocamera:

1. Ottenere un certificato SSL per la crittografia e la decrittografia in formato codificato base-64 e utilizzare una chiave privata in formato PKCS#8 (non crittografata).
 2. Confezionare il contenuto del certificato richiesto in formato PEM. Il certificato SSL caricato sulla telecamera deve essere in formato PEM.
 3. Fare clic su **Browse** per selezionare il file del certificato, quindi fare clic su **Upload**.
 4. Attivare HTTPS.
-

Sistema (System)

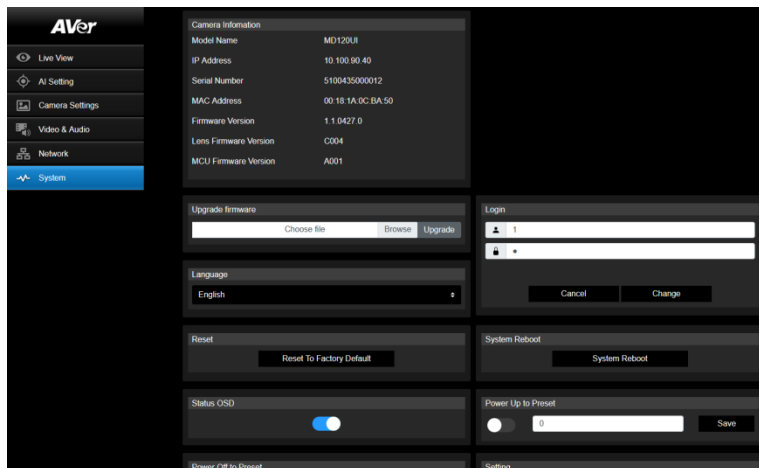

Elemento	Descrizione
Camera Information	Visualizza le informazioni sulla telecamera.
Upgrade Firmware	<p>Per aggiornare il firmware, procedere come segue:</p> <ol style="list-style-type: none">1. Scaricare il firmware più recente dall'AVer Download Center (https://www.aver.com/download-center/).2. Nella pagina Web, andare su System > Upgrade firmware.3. Fare clic su Browse per selezionare il firmware.4. Fare clic su Upgrade per avviare l'aggiornamento del firmware.5. Aggiornare il browser al termine del processo di aggiornamento. <p>[Nota] Durante l'aggiornamento del firmware, la fotocamera deve essere collegata a una fonte di alimentazione. La connessione di rete verrà persa durante il processo e la telecamera si riavvierà automaticamente dopo l'aggiornamento.</p>
Login	Il nome utente/password predefinito è admin/admin . Per modificare il nome utente/password, immettere il nuovo nome utente/password e fare clic su Change .
Language	Modificare la lingua dell'interfaccia web.
Reset	Ripristinare le impostazioni di fabbrica della fotocamera.
System Reboot	Riavviare la telecamera.

Status OSD	Consente di visualizzare lo stato delle preimpostazioni sull'uscita HDMI durante funzioni quali il salvataggio, il caricamento e l'annullamento delle preimpostazioni.
Power Up to Preset	Quando questa funzione è abilitata, la telecamera si sposta nella posizione definita dopo l'accensione. <ul style="list-style-type: none"> ● Fare clic sulla levetta per attivare la funzione > inserire un numero di preselezione > fare clic su Save. ● Assicurarsi che il numero di preselezione sia stato definito prima di abilitare questa funzione.
Power Off to Preset	Quando questa funzione è abilitata, la telecamera si sposta nella posizione definita prima di spegnersi. <ul style="list-style-type: none"> ● Fare clic sulla levetta per attivare la funzione > inserire un numero di preselezione > fare clic su Save. ● Assicurarsi che il numero di preselezione sia stato definito prima di abilitare questa funzione.
Setting	Esporta o importa le impostazioni della tua telecamera.
Help Us Improve	Accetta o rifiuta di fornire dati in modo anonimo.

AVerCamera Setting Tool

Lo AVerCamera Setting Tool è un software applicativo che supporta il funzionamento delle telecamere AVer PTZ quando si effettua lo streaming con un software di terze parti. Consente agli utenti di configurare le impostazioni dell'immagine, dell'audio e del video senza un telecomando, oltre a collegare la telecamera via USB.

- Scaricare lo AVerCamera Setting Tool dal sito web AVer:
(<https://www.aver.com/Downloads/search?q=AVer%20Camera%20Setting%20Tool>).
- Per dettagli sulle impostazioni, cfr. il capitolo <AVerCamera Setting Tool> nel manuale utente per lo CaptureShare.

Specifiche

Telecamera	
Sensore immagine	1/2.8" CMOS
Elementi immagine effettivi	8 Megapixel
Risoluzioni di uscita	Risoluzione: 4K/1080p/720p Frame Rate: 60/59.94/50/30/29.97/25
Illuminazione minima	0.5 lux (50 IRE, F1.6, Max. AGC, 1/30)
Rapporto segnale/rumore	≥ 50dB
Guadagno	Auto, Manuale
Righe TV	1000 (centro/largo)
Velocità dell'otturatore	Da 1/1 a 1/10,000 sec
Controllo dell'esposizione	Auto, Manuale, Priorità AE (Otturatore, IRIDE), BLC, WDR
White Balance	Auto, Manuale
Zoom ottico	20X
Zoom digitale	1X
Zoom totale	20X
Angoli di visualizzazione	DFOV : 69.2° (Largo) to 4.1° (Tele) HFOV: 62.3° (Largo) to 3.6° (Tele) VFOV: 37.3° (Largo) to 2.1° (Tele)
Lunghezza focale	f = da 4.5 mm (Largo) a 90 mm (Tele)
Apertura (Iride)	F = da 1.8 (Wide) a 4.7 (Tele)
Distanza di funzionamento	Largo: 0.1 m, Tele: 1.2 m
Angoli di Pan/Tilt	Pan: ±170°, Tilt: +90° / -30°
Velocità di Pan / Tilt (Manuale)	Pan: Da 0.1° a 100°/sec, Tilt: Da 0.1° a 100°/sec
Preset Speed	Pan: 200°/sec, Tilt: 200°/sec
Posizione di preset	10 (IR), 256 (RS-232, RS-422, IP)
Controllo telecamera - Interfaccia	RS-232 / RS-422 / Ethernet
Controllo telecamera - Protocolli	VISCA (RS-232/RS-422/IP), CGI (IP)
Elaborazione immagine	Rispecchia / Capovolgì / Blocca / WDR / BLC
Frequenze di alimentazione	50 Hz, 60 Hz
Funzioni AI	
Modalità	Tracciamento degli occhi (Eyes Tracking)
Privacy	
Modalità di protezione	Modalità privacy



Generale	
Requisiti di alimentazione	12V
Consumo di corrente	24W
PoE	PoE+ (IEEE802.3at)
Dimensioni (L x H x P)	180(L) x 145(P) x 183.5(H) mm
Peso netto	1.7±0.1 kg
Applicazione	All'interno
Lampada Tally	Sì
Sicurezza	Alloggiamento Kensington
Controllo remoto a infrarossi	Sì
Condizioni di funzionamento	Temperatura: Da 0°C a +40°C Umidità: Dal 20% all'80%
Condizioni di stoccaggio	Temperatura: Da -20°C a +60°C Umidità: Dal 20% all'95%
Audio	
Canali	Stereo 2 canali
Codec	AAC-LC (48K)
Interfaccia	
Uscite video	HDMI, IP, USB
Uscite audio	HDMI, IP, USB
Ingressi audio	N/D
Streaming IP	
Risoluzione	4K 60fps
Formati di compressione video di rete	H.264, H.265, MJPEG
Frame Rate Massimo	4K 60fps
Modalità di controllo Bit-Rate	VBR, CBR
Intervallo di Bit-Rate	512Kbps ~ 64Mbps
Interfacce di rete	10 / 100 / 1000 Base-T
Capacità Multi-Stream	2 (RTSP/Pagina Web), MAX: 4K 60fps
Protocolli di rete	IPv6, IPv4, TCP, UDP, ARP, ICMP, IGMP, HTTP, DHCP RTP/RTCP, RTSP, RTMP, VISCA over IP

USB	
Connettore	USB3.0 (Tipo-B)
Formati video	MJPEG
Video max	2160p
Classe video USB (UVC)	UVC1.1
Classe audio USB (UAC)	UAC 1.0
Interfaccia utente Web	
Anteprima video in tempo reale	Sì
Controllo PTZ telecamera	Pan, Tilt, Zoom, Messa a fuoco, Controllo Preset
Telecamera / Immagine	Esposizione, Bilanciamento dei bianchi, Elaborazione immagine
Configurazione di rete	DHCP, IP Address, Gateway, Subnet Mask, DNS
Strumenti Software	
Strumento di ricerca e	Supporta Windows® 7 o versioni successive
Gestione PTZ	Supporta Windows® 7 o versioni successive
Pannello di controllo PTZ	Supporta iOS & iPadOS® 11 o versioni successive
Strumento di impostazione	Supporta Windows® 7 o versioni successive, macOS® 10.14 o

Le specifiche sono soggette a variazione senza preavviso.

Risoluzione dei problemi

L'immagine è distorta o sfocata.

- Nell'interfaccia web, andare su **Live View > Camera Control** e fare clic su  **Auto Focus**.
- Sul telecomando, tenere premuto **Menu**  per 3 secondi > **Factory Default > On** per riportare tutte le impostazioni ai valori predefiniti.

Come aprire il menu OSD (On Screen Display)?

1. Accertarsi che il cavo HDMI sia collegato alla fotocamera e al display.
2. Sul telecomando, tenere premuto **Menu**  per 3 secondi per aprire il menu OSD.
3. Una luce viola fissa sull'indicatore LED indica che il menu OSD è attivo.

Appendice

Tabella dei comandi RS-232 VISCA

Command Set	Command	Command Packet	Comments
Command Set	Command	Command Packet	Comments
IF_Clear	Broadcast	88 01 00 01 FF	I/F Clear (Clear Visca connection & command buffer queue)
CommandCancel	--	8x 2p FF	p: Socket No. (=1or2)
CAM_Power	On	8x 01 04 00 02 FF	Power OFF to Standby mode
	Off	8x 01 04 00 03 FF	Power ON supported in Standby mode only
CAM_Zoom	Stop	8x 01 04 07 00 FF	Zoom Control
	Tele(Standard)	8x 01 04 07 02 FF	
	Wide(Standard)	8x 01 04 07 03 FF	
	Tele(Variable)	8x 01 04 07 2p FF	p=0 (Low) to 7 (High)
	Wide(Variable)	8x 01 04 07 3p FF	
	Direct	8x 01 04 47 0p 0q 0r 0s FF	pqrs: Zoom Position. MD120UI: 0x00F0 (x1) ~ 0x5378 (x20)
CAM_Focus	Stop	8x 01 04 08 00 FF	Focus Control Each 'Far/Near' needs a 'stop'
	Far (Standard)	8x 01 04 08 02 FF	
	Near (Standard)	8x 01 04 08 03 FF	
	Far (Variable)	8x 01 04 08 2p FF	p=0 (Low) to 7 (High)
	Near (Variable)	8x 01 04 08 3p FF	
	Auto Focus	8x 01 04 38 02 FF	AF ON/OFF
	Manual Focus	8x 01 04 38 03 FF	
	Auto/Manual	8x 01 04 38 10 FF	
	One Push	8x 01 04 18 01 FF	
	Direct	8x 01 04 48 0p 0q 0r 0s FF	pqrs: Focus Position, MD120UI: 0x0000(wide) ~ 0x4000(tele)
	Near Limit	8x 01 04 28 0p 0q 0r 0s FF	pqrs: Focus Near Limit Position 0001: 0.01m 0002: 1m 0003: 1.5m 0004: 2m 0005: 3m 0006: 6m 0007: 10m
CAM_AFMode	Normal AF	8x 01 04 57 00 FF	Continuous AF ON

Command Set	Command	Command Packet	Comments
	Zoom Trigger AF	8x 01 04 57 02 FF	Continuous AF OFF, only trigger AF after PTZ done
CAM_WB	Auto	8x 01 04 35 00 FF	Normal Auto
	ATW	8x 01 04 35 04 FF	
	All'interno	8x 01 04 35 01 FF	
	Outdoor	8x 01 04 35 02 FF	
	One Push WB	8x 01 04 35 03 FF	One Push WB mode
	Manual	8x 01 04 35 05 FF	Manual Control mode
	One Push Trigger	8x 01 04 10 05 FF	One Push WB Trigger
CAM_RGain	Reset	8x 01 04 03 00 FF	Manual Control of R Gain
	Up	8x 01 04 03 02 FF	
	Down	8x 01 04 03 03 FF	
	Direct	8x 01 04 43 00 00 0p 0q FF	pq: R Gain
CAM_BGain	Reset	8x 01 04 04 00 FF	Manual Control of B Gain
	Up	8x 01 04 04 02 FF	
	Down	8x 01 04 04 03 FF	
	Direct	8x 01 04 44 00 00 0p 0q FF	pq: B Gain
CAM_AE	Full Auto	8x 01 04 39 00 FF	Automatic Exposure mode
	Manual	8x 01 04 39 03 FF	Manual Control mode
	Shutter Priority	8x 01 04 39 0A FF	Shutter Priority Automatic Exposure mode
	Iris Priority	8x 01 04 39 0B FF	Iris Priority Automatic Exposure mode
CAM_SlowShutter	Auto	8x 01 04 5A 02 FF	Auto Slow Shutter ON/OFF
	Manual	8x 01 04 5A 03 FF	
CAM_Shutter	Reset	8x 01 04 0A 00 FF	Shutter Setting
	Up	8x 01 04 0A 02 FF	
	Down	8x 01 04 0A 03 FF	
	Direct	8x 01 04 4A 00 00 0p 0q FF	pq: Shutter Position
CAM_Iris	Reset	8x 01 04 0B 00 FF	Iris Setting
	Up	8x 01 04 0B 02 FF	
	Down	8x 01 04 0B 03 FF	
	Direct	8x 01 04 4B 00 00 0p 0q FF	pq: Iris Position

Command Set	Command	Command Packet	Comments
CAM_Gain	Reset	8x 01 04 0C 00 FF	Gain Setting
	Up	8x 01 04 0C 02 FF	
	Down	8x 01 04 0C 03 FF	
	Direct	8x 01 04 4C 00 00 0p 0q FF	pq: Gain Position
	AE Gain Limit	8x 01 04 2C 0p FF	p: Gain Position (8 to E: 24db~42db)
CAM_Bright	Up	8x 01 04 0D 02 FF	--
	Down	8x 01 04 0D 03 FF	
	Direct	8x 01 04 4D 00 00 0p 0q FF	pq: Bright Position
CAM_ExpComp	Reset	8x 01 04 0E 00 FF	Exposure Comp Amount Setting
	Up	8x 01 04 0E 02 FF	
	Down	8x 01 04 0E 03 FF	
	Direct	8x 01 04 4E 00 00 0p 0q FF	pq: ExpComp Position
CAM_Backlight	On	8x 01 04 33 02 FF	Back Light Compensation ON/OFF
	Off	8x 01 04 33 03 FF	
CAM_LR_Reverse	On	8x 01 04 61 02 FF	Mirror Image ON/OFF
	Off	8x 01 04 61 03 FF	
CAM_Flip	On	8x 01 04 66 02 FF	Flip ON/OFF
	Off	8x 01 04 66 03 FF	
CAM_Preset	Reset	8x 01 04 3F 00 pp FF	Preset Cancel. pp: Preset Number 0x00~0xFF
	Set	8x 01 04 3F 01 pp FF	Preset Save.
	Recall	8x 01 04 3F 02 pp FF	Preset Load.
CAM_Menu	On	8x 01 06 06 02 FF	Menu Display ON/OFF
	Off	8x 01 06 06 03 FF	
	On/Off	8x 01 06 06 10 FF	
CAM_MenuEnter	--	8x 01 7E 01 02 00 01 FF	Enter Submenu
CAM_NR	--	8x 01 04 53 0p FF	p: Image NR Setting (0:OFF, Level1 to 3)
CAM_WDR	On	8x 01 04 3D 02 FF	Wdr ON/OFF
	Off	8x 01 04 3D 03 FF	
CAM_ICR	On	8x 01 04 01 02 FF	Infrared Mode ON (Night)
	Off	8x 01 04 01 03 FF	Infrared Mode OFF (Day)

Command Set	Command	Command Packet	Comments
CAM_AutoICR	On	8x 01 04 51 02 FF	Auto Infrared mode ON/OFF
	Off	8x 01 04 51 03 FF	
	Threshold	8x 01 04 21 00 00 0p 0q FF	pp: ICR OFF(Day)->ON(Night) threshold level 00: Low; 01: Middle; 02: High
CAM_IDWrite	--	8x 01 04 22 0p 0q 0r 0s FF	pprs: Camera ID (=0000 to FFFF)
Video Format Change	--	8x 01 7E 01 1E 0p 0q FF	pp
			0x02: 1920x1080P/60
			0x03: 1920x1080P/59.94
			0x04: 1920x1080P/30
			0x05: 1920x1080P/29.97
			0x08: 1920x1080I/60
			0x0A: 1920x1080I/59.94
			0x0B: 1280x720P/60
			0x0C: 1280x720P/59.94
			0x0D: 1920x1080P/50
			0x18: 1920x1080P/25
			0x22: 1920x1080I/50
			0x26: 1280x720P/50
			0x30: 3840x2160P/60
			0x31: 3840x2160P/59.94
			0x32: 3840x2160P/50
0x33: 3840x2160P/30			
0x34: 3840x2160P/29.97			
0x35: 3840x2160P/25			
IR_Receive	On	8x 01 06 08 02 FF	Infrared remote commander reception ON
Pan-tilt Drive	Up	8x 01 06 01 VV WW 03 01 FF	VV: Pan speed setting 0x01 (low speed) to 0x18 (high speed) WW: Tilt speed setting 0x01 (low speed) to 0x18 (high speed) YYYY: Pan Position 7FFF(170°) to 8000(-170°) (Normalized, CENTER 0000) ZZZZ: Tilt Position 7FFF(90°) to 8000(-30°)
	Down	8x 01 06 01 VV WW 03 02 FF	
	Left	8x 01 06 01 VV WW 01 03 FF	
	Right	8x 01 06 01 VV WW 02 03 FF	
	UpLeft	8x 01 06 01 VV WW 01 01 FF	

Command Set	Command	Command Packet	Comments
	UpRight	8x 01 06 01 VV WW 02 01 FF	(Image Flip: OFF) (Normalized, CENTER 0000)
	DownLeft	8x 01 06 01 VV WW 01 02 FF	
	DownRight	8x 01 06 01 VV WW 02 02 FF	
	Stop	8x 01 06 01 VV WW 03 03 FF	
	AbsolutePosition	8x 01 06 02 VV WW 0Y 0Y 0Y 0Y 0Z 0Z 0Z 0Z FF	
	RelativePosition	8x 01 06 03 VV WW 0Y 0Y 0Y 0Y 0Z 0Z 0Z 0Z FF	
	Home	8x 01 06 04 FF	
	Reset	8x 01 06 05 FF	
Freeze	Freeze On	8x 01 04 62 02 FF	Freeze On Immediately
	Freeze Off	8x 01 04 62 03 FF	Freeze Off Immediately
	Preset Freeze On	8x 01 04 62 22 FF	Freeze On When Running Preset
	Preset Freeze Off	8x 01 04 62 23 FF	Freeze Off When Running Preset
RTMP	On	8x 01 04 A2 02 FF	RTMP ON/OFF
	Off	8x 01 04 A2 03 FF	
Reboot	On	8x 01 04 A4 FF	System reboot
P/T Spd. Relative Zoom Ratio	On	8x 01 04 A6 02 FF	P/T Speed Relative Zoom Ratio ON/OFF
	Off	8x 01 04 A6 03 FF	
Factory Reset	System Factory Reset	8x 01 04 3F 03 00 FF	
Preset Speed	Set Preset Speed	8x 01 06 20 0p FF	p=1 (Low) to 6 (High)

Inquiry Command	Command Packet	Inquiry Packet	Comments
Inquiry Command	Command Packet	Inquiry Packet	Comments
CAM_PowerInq	8x 09 04 00 FF	y0 50 02 FF	On
		y0 50 02 FF	Off
CAM_ZoomPosInq	8x 09 04 47 FF	y0 50 0p 0q 0r 0s FF	pqrs: Zoom Position
CAM_FocusModelInq	8x 09 04 38 FF	y0 50 02 FF	Auto Focus
		y0 50 03 FF	Manual Focus
CAM_FocusPosInq	8x 09 04 48 FF	y0 50 0p 0q 0r 0s FF	pqrs: Focus Position
CAM_FocusNearLimitInq	8x 09 04 28 FF	y0 50 0p 0q 0r 0s FF	pqrs: Focus Near Limit Position
CAM_AFModelInq	8x 09 04 57 FF	y0 50 00 FF	Continuous AF ON
		y0 50 02 FF	Continuous AF OFF, only trigger AF after PTZ done
CAM_WBModelInq	8x 09 04 35 FF	y0 55 00 FF	Auto
		y0 55 04 FF	ATW
		y0 55 01 FF	All'interno
		y0 55 02 FF	Outdoor
		y0 55 03 FF	One Push WB
		y0 55 05 FF	Manual
CAM_RGainInq	8x 09 04 43 FF	y0 50 00 00 0p 0q FF	pq: R Gain
CAM_BGainInq	8x 09 04 44 FF	y0 50 00 00 0p 0q FF	pq: B Gain
CAM_AEModelInq	8x 09 04 39 FF	y0 50 00 FF	Full Auto
		y0 50 03 FF	Manual
		y0 50 0A FF	Shutter Priority
		y0 50 0B FF	Iris Priority
		y0 50 0D FF	Bright
CAM_SlowShutterModelInq	8x 09 04 5A FF	y0 50 02 FF	Auto
		y0 50 03 FF	Manual
CAM_ShutterPosInq	8x 09 04 4A FF	y0 50 00 00 0p 0q FF	pq: Shutter Position
CAM_IrisPosInq	8x 09 04 4B FF	y0 50 00 00 0p 0q FF	pq: Iris Position
CAM_GainPosInq	8x 09 04 4C FF	y0 50 00 00 0p 0q FF	pq: Gain Position
CAM_GainLimitInq	8x 09 04 2C FF	y0 50 0q FF	p: Gain Limit
CAM_BrightPosInq	8x 09 04 4D FF	y0 50 00 00 0p 0q FF	pq: Bright Position

Inquiry Command	Command Packet	Inquiry Packet	Comments
CAM_ExpCompPosInq	8x 09 04 4E FF	y0 50 00 00 0p 0q FF	pq: ExpComp Position
CAM_BacklightModeInq	8x 09 04 33 FF	y0 50 02 FF	On
		y0 50 03 FF	Off
CAM_LR_Reverse_Inq	8x 09 04 61 FF	y0 50 02 FF	On
		y0 50 03 FF	Off
CAM_Flip_Inq	8x 09 04 66 FF	y0 50 02 FF	On
		y0 50 03 FF	Off
CAM_NRInq	8x 09 04 53 FF	y0 50 0p FF	p: NR Level
CAM_WDRInq	8x 09 04 3D FF	y0 50 02 FF	On
		y0 50 03 FF	Off
CAM_ICRModelInq	8x 09 04 01 FF	y0 50 02 FF	On (Night)
		y0 50 03 FF	Off (Day)
CAM_AutoICRModelInq	8x 09 04 51 FF	y0 50 02 FF	On
		y0 50 03 FF	Off
CAM_AutoICRThresholdInq	8x 09 04 21 FF	y0 50 00 00 0p 0q FF	pq: ICR OFF(Day)->ON(Night) threshold level 00: Low; 01: Middle; 02: High
CAM_IDInq	8x 09 04 22 FF	y0 50 0p 0q 0r 0s FF	pqrs: Camera ID
CAM_VersionInq	8x 09 00 02 FF	y0 50 ab cd mn pq rs tu vw FF	abcd: Vendor Code, AVer: 2574 mnpq: Model Code, MD120UI: 0565 rstu: Firmware version (ex: 4025 for 1.1.4025.0) vw: Socket Number (=02)
CAM_MenuModelInq	8x 09 06 06 FF	y0 50 02 FF	On
		y0 50 03 FF	Off
Video Format Inq	8x 09 06 23 FF	y0 50 02 FF	1920x1080P/60
		y0 50 03 FF	1920x1080P/59.94
		y0 50 04 FF	1920x1080P/30
		y0 50 05 FF	1920x1080P/29.97
		y0 50 08 FF	1920x1080I/60
		y0 50 0A FF	1920x1080I/59.94
		y0 50 0B FF	1280x720P/60
		y0 50 0C FF	1280x720P/59.94
		y0 50 0D FF	1920x1080P/50

Inquiry Command	Command Packet	Inquiry Packet	Comments
		y0 50 18 FF	1920x1080P/25
		y0 50 22 FF	1920x1080I/50
		y0 50 26 FF	1280x720P/50
		y0 50 30 FF	3840x2160P/60
		y0 50 31 FF	3840x2160P/59.94
		y0 50 32 FF	3840x2160P/50
		y0 50 33 FF	3840x2160P/30
		y0 50 34 FF	3840x2160P/29.97
		y0 50 35 FF	3840x2160P/25
IR_Receive	8x 09 06 08 FF	y0 50 02 FF	On
		y0 50 03 FF	Off
Pan-tiltPosInq	8x 09 06 12 FF	y0 50 0Y 0Y 0Y 0Y 0Z 0Z 0Z 0Z FF	YYYY: Pan Position 7FFF(170°) to 8000 (-170°) (Normalized, CENTER 0000) ZZZZ: Tilt Position 7FFF(90°) to 8000(-30°) (Image Flip: OFF) (Normalized, CENTER 0000)
CAM_Preset_Inq	8x 09 04 3F FF	y0 50 pp FF	Return the last preset number which has been operated pp:01-FF
Pan-tiltMaxSpeedInq	8x 09 06 11 FF	y0 50 ww zz FF	ww = Pan Max Speed zz = Tilt Max Speed
Freeze_Mode_Inq	8x 09 04 62 01 FF	y0 50 02 FF	On
		y0 50 03 FF	Off
Preset_Freeze_Inq	8x 09 04 62 02 FF	y0 50 02 FF	On
		y0 50 03 FF	Off
RTMP_Inq	8x 09 04 A2 FF	y0 50 02 FF	On
		y0 50 03 FF	Off
Preset_Speed_Inq	8x 09 06 20 FF	y0 50 0p FF	p=1 (Low) to 6 (High)
Firmware version	8x 09 36 69 04 FF	y0 50 0p 0q 0r 0s 0t 0u 0v 0w FF	fw_ver: p.q.rstu.vw

Impostazioni VISCA over IP

PORT

Internet protocol	IPv4
Transport protocol	UDP
Port address	52381

FORMAT

	byte 0	byte 1	byte 2	byte 3	byte 4	byte 5	byte 6	byte 7	byte 8 ~~~ byte 23
func	Payload type		Payload Length		Sequence number			Payload (1 to 16 bytes)	
data	Value1	Value2	1~16(0x0001~0x0010)		0x00000000 ~ 0xFFFFFFFF			VISCA Packet (see page VISCA)	

Payload type

Name	Value1	Value2	Descrizione
VISCA command	0x01	0x00	Stores the VISCA command.
VISCA inquiry	0x01	0x10	Stores the VISCA inquiry.
VISCA reply	0x01	0x11	Stores the reply for the VISCA command and VISCA inquiry, or VISCA device setting command
VISCA device setting command	0x01	0x20	Stores the VISCA device setting command.
Control command	0x02	0x00	Stores the control command
Control reply	0x02	0x01	Stores the reply for the control command.

Comando CGI

CGI List for Video Transmission					
CGI item name	URL	Command	Parameter Name	Parameter value	Descrizione
Get JPEG	/snapshot				1280x720 jpg
Get 4K JPEG	/cgi-bin?OnePush=n				Step 1: request 4k snapshot
	/snapshot?res=4k				Step 2: get 3840x2160 jpg
Get RTSP stream	rtsp://ip/live_st1				

CGI List for Audio					
CGI item name	URL	Command	Parameter Name	Parameter value	Descrizione
Audio In Volume	/cgi-bin?Set=	ado_vol,3,N		0 ~10	0 ~ 10 volume

CGI List for Camera Control					
CGI item name	URL	Command	Parameter Name	Parameter value	Descrizione
up start	/cgi-bin?SetPtfz=	1,0,1			
up end	/cgi-bin?SetPtfz=	1,0,2			
down start	/cgi-bin?SetPtfz=	1,1,1			
down end	/cgi-bin?SetPtfz=	1,1,2			
left start	/cgi-bin?SetPtfz=	0,1,1			
left end	/cgi-bin?SetPtfz=	0,1,2			
right start	/cgi-bin?SetPtfz=	0,0,1			
right end	/cgi-bin?SetPtfz=	0,0,2			
zoom_in start	/cgi-bin?SetPtfz=	2,0,1			
zoom_in end	/cgi-bin?SetPtfz=	2,0,2			
zoom_out start	/cgi-bin?SetPtfz=	2,1,1			
zoom_out end	/cgi-bin?SetPtfz=	2,1,2			
set preset:	/cgi-bin?ActPreset=	1,N			N : position
load preset:	/cgi-bin?ActPreset=	0,N			N : position

CGI List for Various Settings					
CGI item name	URL	Command	Parameter Name	Parameter value	Descrizione
exposure value	/cgi-bin?Set=	img_expo_expo,3,N	value	1 ~ 9	N : value
saturation	/cgi-bin?Set=	img_saturation,3,N	value	0 ~ 10	N : value
contrast	/cgi-bin?Set=	img_contrast,3,N	value	0 ~ 4	N : value

Tracking on:	/cgi-bin?Set=	trk_tracking_on,3,1			
Tracking off:	/cgi-bin?Set=	trk_tracking_on,3,0			
Reboot	GET(Basic Authentication)	/cgi-bin?OnePush=!			
Factory Reset	GET(Basic Authentication)	/cgi-bin?OnePush=d			
RTMP Start streaming	/cgi-bin?Set=	vdo_rtmp_enable,3,1			
RTMP Stop streaming	/cgi-bin?Set=	vdo_rtmp_enable,3,0			
Status get (Model name & mac & FW_VER)	/cgi-bin?GetString=	sys_name&net_mac&sys_fw_version			http://10.100.105.110/cgi-bin?GetString=sys_name&net_mac&sys_fw_version
Serial No. get	/cgi-bin?GetSerialNumber				http://10.100.105.110/cgi-bin?GetSerialNumber
oneclick	/cgi-bin?Set=	ptz_oneclick_x,3,N1&ptz_oneclick_y,3,N2&ptz_one_click_spd,3,N3		ptz_one_click_spd 1~24	N1,N2=X,Y座標(1080P,左上方為0,0的座標系統)N3=移動速度
IR Cut Filter	/cgi-bin?Set=	img_ircut_filter,3,N		0 ~ 2	0 = Day, 1 = Night, 2 = Auto
IR Cut Filter Sensitivity	/cgi-bin?Set=	img_ircut_sensitivity,3,N		0 ~ 2	0 = Low, 1 = Middle, 2 = High

CGI List for AI Settings					
CGI item name	URL	Command	Parameter Name	Parameter value	Descrizione
Eyes Tracking On/Off	/cgi-bin?Set=	trk_tracking_on,3,N	value	0 / 1	0: OFF; 1: ON
Tracking Preset	/cgi-bin?ActPreset=1,255				Save current pos. for eye tracking preset point.
Timeout to preset	/cgi-bin?Set=	trk_lost_time,3, N	value	3 / 5 / 7 / 10	timeout in seconds
Tracking Site	/cgi-bin?Set=	trk_mode,3,N	value	0 / 1	0: Full face; 1: Eyes
Tracking Range	/cgi-bin?Set=	trk_sensitivity,3,N	value	0 ~ 2	0: Close; 1: Medium; 2: Wide
Eyes Tracking On/Off Get	/cgi-bin?Get=trk_tracking_on				
	- Reply	On trk_tracking_on=1 Off			

		trk_tracking_on=0			
Audio Detection On/Off	/cgi-bin?Set=	ado_det_alarm,3,N	value	0 / 1	0: OFF; 1: ON
Alarm Detection Type	/cgi-bin?Set=	ado_alm_general,3,N	value	0 / 1	general type. 0: OFF; 1: ON
		ado_alm_oxygen,3,N	value	0 / 1	oxygen type. 0: OFF; 1: ON
		ado_alm_ventilation,3,N	value	0 / 1	ventilation type. 0: OFF; 1: ON
		ado_alm_cardiovascular,3,N	value	0 / 1	cardiovascular type. 0: OFF; 1: ON
		ado_alm_temperature,3,N	value	0 / 1	temperature type. 0: OFF; 1: ON
		ado_alm_drug,3,N	value	0 / 1	drug type. 0: OFF; 1: ON
		ado_alm_artificial,3,N	value	0 / 1	artificial type. 0: OFF; 1: ON
		ado_alm_power,3,N	value	0 / 1	power type. 0: OFF; 1: ON
		ado_alm_information,3,N	value	0 / 1	information type. 0: OFF; 1: ON