

OptiPlex 5090 Small Form Factor

Service Manual

Notes, cautions, and warnings

 **NOTE:** A NOTE indicates important information that helps you make better use of your product.

 **CAUTION:** A CAUTION indicates either potential damage to hardware or loss of data and tells you how to avoid the problem.

 **WARNING:** A WARNING indicates a potential for property damage, personal injury, or death.

Chapter 1: Working inside your computer	6
Safety instructions.....	6
Before working inside your computer.....	6
Safety precautions.....	7
Electrostatic discharge—ESD protection.....	7
ESD field service kit	8
Transporting sensitive components.....	9
After working inside your computer.....	9
Chapter 2: Removing and installing components	10
Recommended tools.....	10
Screw List.....	10
Major components of your system.....	11
SD-card reader.....	12
Removing the SD-card reader.....	12
Installing the SD-card reader.....	13
Side cover.....	14
Removing the side cover.....	14
Installing the side cover.....	16
Front bezel.....	17
Removing the front bezel.....	17
Installing the front bezel.....	18
2.5-inch hard drive.....	19
Removing the 2.5-inch hard-drive caddy.....	19
Removing the 2.5-inch hard drive.....	20
Installing the 2.5-inch hard drive.....	21
Installing the 2.5-inch hard-drive caddy.....	22
3.5-inch hard drive.....	23
Removing the 3.5-inch hard-drive caddy.....	23
Removing the 3.5-inch hard drive.....	24
Installing the 3.5-inch hard drive.....	25
Installing the 3.5-inch hard-drive caddy.....	26
Solid-state drive.....	27
Removing the M.2 2230 solid-state drive.....	27
Installing the M.2 2230 solid-state drive.....	28
Removing the M.2 2280 solid-state drive.....	29
Installing the M.2 2280 solid-state drive.....	30
Memory modules.....	31
Removing the memory modules.....	31
Installing the memory modules.....	32
Hard-drive and optical-drive bracket.....	33
Removing the hard-drive and optical-drive bracket.....	33
Installing the hard-drive and optical-drive bracket.....	35
Optical drive.....	38

Removing the slim optical-drive.....	38
Installing the slim optical-drive.....	39
WLAN card.....	40
Removing the WLAN card.....	40
Installing the WLAN card.....	41
Heat-sink and fan assembly.....	42
Removing the heat-sink and fan assembly.....	42
Installing the heat-sink and fan assembly.....	43
Heat-sink fan.....	43
Removing the heat-sink fan.....	43
Installing the heat-sink fan.....	44
Expansion card.....	45
Removing the graphics card.....	45
Installing the graphics card.....	46
Optional I/O modules (Type C/ HDMI / DPI).....	47
Removing optional I/O modules (Type-C/ HDMI/VGA/DP/Serial).....	47
Installing optional I/O modules (Type C/ HDMI/VGA/DP/Serial).....	48
Coin-cell battery.....	49
Removing the coin-cell battery.....	49
Installing the coin-cell battery.....	50
Intrusion switch.....	51
Removing the intrusion switch.....	51
Installing the intrusion switch.....	52
Power-supply unit.....	53
Removing the power-supply unit.....	53
Installing the power-supply unit.....	55
Processor.....	58
Removing the processor.....	58
Installing the processor.....	59
System board.....	61
System board callouts - 5090 Small Form Factor.....	61
Removing the system board.....	62
Installing the system board.....	64

Chapter 3: Software..... 69

Drivers and downloads.....	69
----------------------------	----

Chapter 4: System setup..... 70











Boot menu.....	70
Navigation keys.....	70
Boot Sequence.....	71
System setup options.....	71
Overview.....	75
Boot Configuration.....	77
Integrated Devices.....	78
Storage.....	79
Display.....	80
Connection.....	80
Power.....	81

Security.....	82
Passwords.....	84
Update Recovery.....	85
System Management.....	86
Keyboard.....	87
Virtualization.....	87
Performance.....	87
System Logs.....	88
Updating the BIOS.....	88
Updating the BIOS in Windows.....	88
Updating the BIOS in Linux and Ubuntu.....	89
Updating the BIOS using the USB drive in Windows.....	89
Updating the BIOS from the F12 One-Time boot menu.....	89
System and setup password.....	90
Assigning a system setup password.....	90
Deleting or changing an existing system setup password.....	91
Clearing CMOS settings.....	91
Clearing BIOS (System Setup) and System passwords.....	92
Chapter 5: Troubleshooting.....	93
Dell SupportAssist Pre-boot System Performance Check diagnostics.....	93
Running the SupportAssist Pre-Boot System Performance Check.....	93
Diagnostic LED behavior.....	93
Real-Time Clock (RTC Reset).....	95
Recovering the operating system.....	95
Backup media and recovery options.....	95
WiFi power cycle.....	95
Drain residual flea power (perform hard reset).....	95
Chapter 6: Getting help and contacting Dell.....	97

Working inside your computer

Safety instructions

Use the following safety guidelines to protect your computer from potential damage and to ensure your personal safety. Unless otherwise noted, each procedure included in this document assumes that you have read the safety information that shipped with your computer.

-  **WARNING:** Before working inside your computer, read the safety information that is shipped with your computer. For more safety best practices, see the Regulatory Compliance home page at www.dell.com/regulatory_compliance.
-  **WARNING:** Disconnect your computer from all power sources before opening the computer cover or panels. After you finish working inside the computer, replace all covers, panels, and screws before connecting your computer to an electrical outlet.
-  **CAUTION:** To avoid damaging the computer, ensure that the work surface is flat, dry, and clean.
-  **CAUTION:** To avoid damaging the components and cards, handle them by their edges, and avoid touching the pins and the contacts.
-  **CAUTION:** You should only perform troubleshooting and repairs as authorized or directed by the Dell technical assistance team. Damage due to servicing that is not authorized by Dell is not covered by your warranty. See the safety instructions that is shipped with the product or at www.dell.com/regulatory_compliance.
-  **CAUTION:** Before touching anything inside your computer, ground yourself by touching an unpainted metal surface, such as the metal at the back of the computer. While you work, periodically touch an unpainted metal surface to dissipate static electricity which could harm internal components.
-  **CAUTION:** When you disconnect a cable, pull it by its connector or its pull tab, not the cable itself. Some cables have connectors with locking tabs or thumbscrews that you must disengage before disconnecting the cable. When disconnecting cables, keep them evenly aligned to avoid bending the connector pins. When connecting cables, ensure that the ports and the connectors are correctly oriented and aligned.
-  **CAUTION:** Press and eject any installed card from the media-card reader.
-  **CAUTION:** Exercise caution when handling Lithium-ion batteries in laptops. Swollen batteries should not be used and should be replaced and disposed properly.
-  **NOTE:** The color of your computer and certain components may appear differently than shown in this document.

Before working inside your computer

About this task

-  **NOTE:** The images in this document may differ from your computer depending on the configuration you ordered.

Steps

1. Save and close all open files and exit all open applications.
2. Shut down your computer. Click **Start** >  **Power** > **Shut down**.

 **NOTE:** If you are using a different operating system, see the documentation of your operating system for shut-down instructions.

3. Disconnect your computer and all attached devices from their electrical outlets.
4. Disconnect all attached network devices and peripherals, such as keyboard, mouse, and monitor from your computer.

 **CAUTION:** To disconnect a network cable, first unplug the cable from your computer and then unplug the cable from the network device.

5. Remove any media card and optical disc from your computer, if applicable.

Safety precautions

The safety precautions chapter details the primary steps to be taken before performing any disassembly instructions.

Observe the following safety precautions before you perform any installation or break/fix procedures involving disassembly or reassembly:

- Turn off the system and all attached peripherals.
- Disconnect the system and all attached peripherals from AC power.
- Disconnect all network cables, telephone, and telecommunications lines from the system.
- Use an ESD field service kit when working inside any to avoid electrostatic discharge (ESD) damage.
- After removing any system component, carefully place the removed component on an anti-static mat.
- Wear shoes with non-conductive rubber soles to reduce the chance of getting electrocuted.

Standby power

Dell products with standby power must be unplugged before you open the case. Systems that incorporate standby power are essentially powered while turned off. The internal power enables the system to be remotely turned on (wake on LAN) and suspended into a sleep mode and has other advanced power management features.

Unplugging, pressing and holding the power button for 20 seconds should discharge residual power in the system board.

Bonding

Bonding is a method for connecting two or more grounding conductors to the same electrical potential. This is done through the use of a field service electrostatic discharge (ESD) kit. When connecting a bonding wire, ensure that it is connected to bare metal and never to a painted or non-metal surface. The wrist strap should be secure and in full contact with your skin, and ensure that you remove all jewelry such as watches, bracelets, or rings prior to bonding yourself and the equipment.

Electrostatic discharge—ESD protection

ESD is a major concern when you handle electronic components, especially sensitive components such as expansion cards, processors, memory DIMMs, and system boards. Very slight charges can damage circuits in ways that may not be obvious, such as intermittent problems or a shortened product life span. As the industry pushes for lower power requirements and increased density, ESD protection is an increasing concern.

Due to the increased density of semiconductors used in recent Dell products, the sensitivity to static damage is now higher than in previous Dell products. For this reason, some previously approved methods of handling parts are no longer applicable.

Two recognized types of ESD damage are catastrophic and intermittent failures.

- **Catastrophic** – Catastrophic failures represent approximately 20 percent of ESD-related failures. The damage causes an immediate and complete loss of device functionality. An example of catastrophic failure is a memory DIMM that has received a static shock and immediately generates a "No POST/No Video" symptom with a beep code emitted for missing or nonfunctional memory.
- **Intermittent** – Intermittent failures represent approximately 80 percent of ESD-related failures. The high rate of intermittent failures means that most of the time when damage occurs, it is not immediately recognizable. The DIMM receives a static shock, but the tracing is merely weakened and does not immediately produce outward symptoms related to the damage. The weakened trace may take weeks or months to melt, and in the meantime may cause degradation of memory integrity, intermittent memory errors, etc.

The more difficult type of damage to recognize and troubleshoot is the intermittent (also called latent or "walking wounded") failure.

Perform the following steps to prevent ESD damage:

- Use a wired ESD wrist strap that is properly grounded. The use of wireless anti-static straps is no longer allowed; they do not provide adequate protection. Touching the chassis before handling parts does not ensure adequate ESD protection on parts with increased sensitivity to ESD damage.
- Handle all static-sensitive components in a static-safe area. If possible, use anti-static floor pads and workbench pads.
- When unpacking a static-sensitive component from its shipping carton, do not remove the component from the anti-static packing material until you are ready to install the component. Before unwrapping the anti-static packaging, ensure that you discharge static electricity from your body.
- Before transporting a static-sensitive component, place it in an anti-static container or packaging.

ESD field service kit

The unmonitored Field Service kit is the most commonly used service kit. Each Field Service kit includes three main components: anti-static mat, wrist strap, and bonding wire.

Components of an ESD field service kit

The components of an ESD field service kit are:

- **Anti-Static Mat** – The anti-static mat is dissipative and parts can be placed on it during service procedures. When using an anti-static mat, your wrist strap should be snug and the bonding wire should be connected to the mat and to any bare metal on the system being worked on. Once deployed properly, service parts can be removed from the ESD bag and placed directly on the mat. ESD-sensitive items are safe in your hand, on the ESD mat, in the system, or inside a bag.
- **Wrist Strap and Bonding Wire** – The wrist strap and bonding wire can be either directly connected between your wrist and bare metal on the hardware if the ESD mat is not required, or connected to the anti-static mat to protect hardware that is temporarily placed on the mat. The physical connection of the wrist strap and bonding wire between your skin, the ESD mat, and the hardware is known as bonding. Use only Field Service kits with a wrist strap, mat, and bonding wire. Never use wireless wrist straps. Always be aware that the internal wires of a wrist strap are prone to damage from normal wear and tear, and must be checked regularly with a wrist strap tester in order to avoid accidental ESD hardware damage. It is recommended to test the wrist strap and bonding wire at least once per week.
- **ESD Wrist Strap Tester** – The wires inside of an ESD strap are prone to damage over time. When using an unmonitored kit, it is a best practice to regularly test the strap prior to each service call, and at a minimum, test once per week. A wrist strap tester is the best method for doing this test. If you do not have your own wrist strap tester, check with your regional office to find out if they have one. To perform the test, plug the wrist-strap's bonding-wire into the tester while it is strapped to your wrist and push the button to test. A green LED is lit if the test is successful; a red LED is lit and an alarm sounds if the test fails.
- **Insulator Elements** – It is critical to keep ESD sensitive devices, such as plastic heat sink casings, away from internal parts that are insulators and often highly charged.
- **Working Environment** – Before deploying the ESD Field Service kit, assess the situation at the customer location. For example, deploying the kit for a server environment is different than for a desktop or portable environment. Servers are typically installed in a rack within a data center; desktops or portables are typically placed on office desks or cubicles. Always look for a large open flat work area that is free of clutter and large enough to deploy the ESD kit with additional space to accommodate the type of system that is being repaired. The workspace should also be free of insulators that can cause an ESD event. On the work area, insulators such as Styrofoam and other plastics should always be moved at least 12 inches or 30 centimeters away from sensitive parts before physically handling any hardware components
- **ESD Packaging** – All ESD-sensitive devices must be shipped and received in static-safe packaging. Metal, static-shielded bags are preferred. However, you should always return the damaged part using the same ESD bag and packaging that the new part arrived in. The ESD bag should be folded over and taped shut and all the same foam packing material should be used in the original box that the new part arrived in. ESD-sensitive devices should be removed from packaging only at an ESD-protected work surface, and parts should never be placed on top of the ESD bag because only the inside of the bag is shielded. Always place parts in your hand, on the ESD mat, in the system, or inside an anti-static bag.
- **Transporting Sensitive Components** – When transporting ESD sensitive components such as replacement parts or parts to be returned to Dell, it is critical to place these parts in anti-static bags for safe transport.

ESD protection summary

It is recommended that all field service technicians use the traditional wired ESD grounding wrist strap and protective anti-static mat at all times when servicing Dell products. In addition, it is critical that technicians keep sensitive parts separate from all insulator parts while performing service and that they use anti-static bags for transporting sensitive components.

Transporting sensitive components

When transporting ESD sensitive components such as replacement parts or parts to be returned to Dell, it is critical to place these parts in anti-static bags for safe transport.

After working inside your computer

About this task

 **CAUTION:** Leaving stray or loose screws inside your computer may severely damage your computer.

Steps

1. Replace all screws and ensure that no stray screws remain inside your computer.
2. Connect any external devices, peripherals, or cables you removed before working on your computer.
3. Replace any media cards, discs, or any other parts that you removed before working on your computer.
4. Connect your computer and all attached devices to their electrical outlets.
5. Turn on your computer.

Removing and installing components

NOTE: The images in this document may differ from your computer depending on the configuration you ordered.

Recommended tools







The procedures in this document may require the following tools:

- Phillips #0 screwdriver
- Phillips #1 screwdriver
- Plastic scribe-Recommended for field technician

Screw List

The following table shows the screw list and the images for different components.

Table 1. Screw list

Component	Screw type	Quantity	Image
M.2 2230/2280 solid-state drive	M2x3	1	
SD-card reader	M3x5	2	
WLAN card	M2x3	1	
Fan and heatsink assembly	Captive screws	4	
Power-supply unit	6x32	3	
System board	6-32	4	

Major components of your system

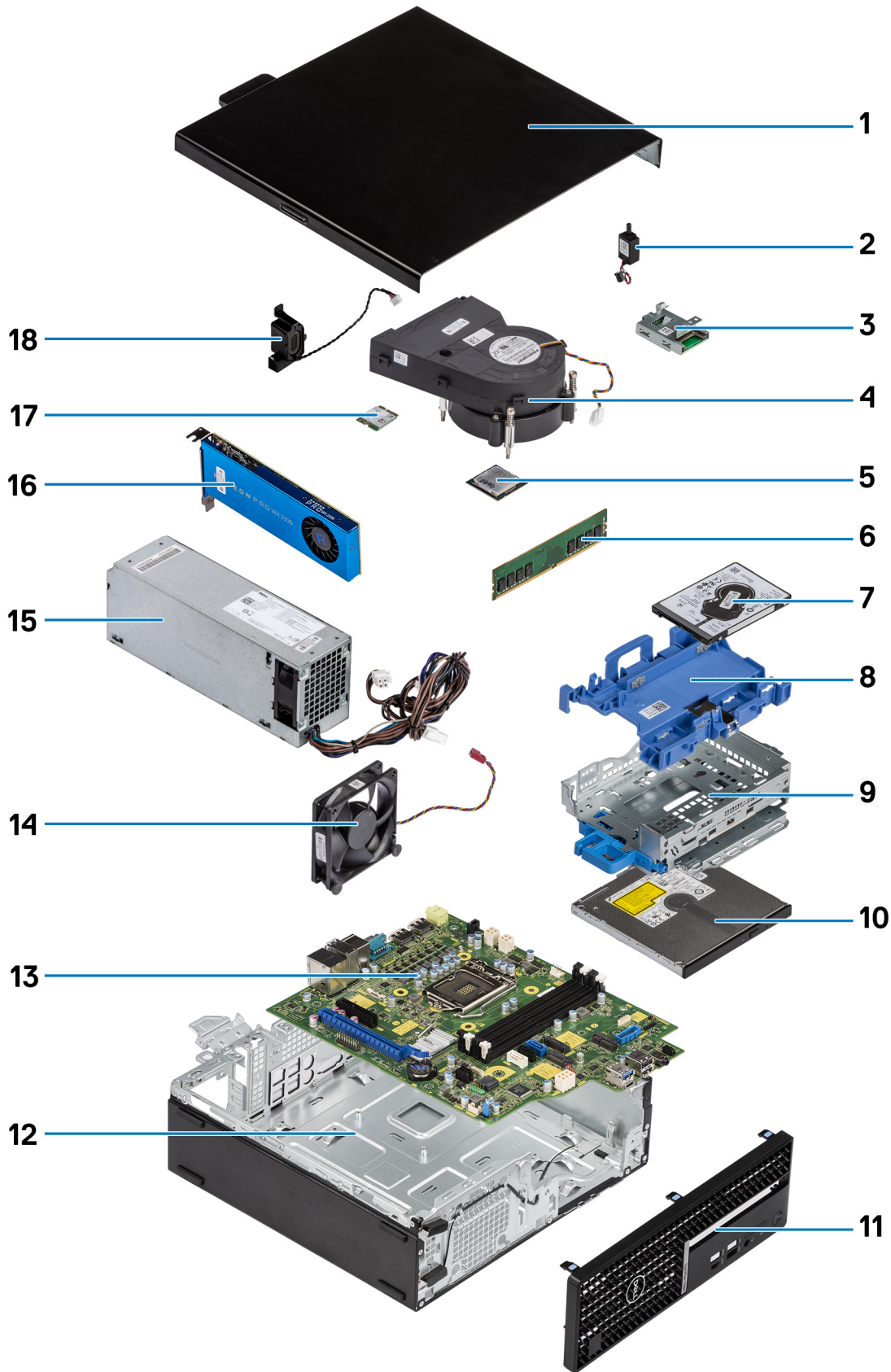

1. Side cover

2. Intrusion switch
3. SD-card reader
4. Processor fan and heat-sink assembly
5. Processor
6. Memory module
7. 2.5-inch hard-drive
8. 2.5/3.5-inch hard-drive caddy
9. Hard-drive and Optical-drive bracket
10. Optical Drive
11. Front bezel
12. Chassis
13. System board
14. Chassis fan
15. Power Supply Unit
16. Powered Graphical processing unit
17. M.2 WLAN
18. Speaker

NOTE: Dell provides a list of components and their part numbers for the original system configuration purchased. These parts are available according to warranty coverages purchased by the customer. Contact your Dell sales representative for purchase options.

SD-card reader

Removing the SD-card reader

Prerequisites

1. Follow the procedure in [before working inside your computer](#).
2. Remove the [side cover](#).
3. Remove the [front bezel](#).
4. Remove the [2.5/3.5-inch hard-drive caddy](#).
5. Remove the [hard-drive and optical-drive bracket](#).

About this task

The following images indicate the location of the SD card and provide a visual representation of the removal procedure.



2x
M3x5

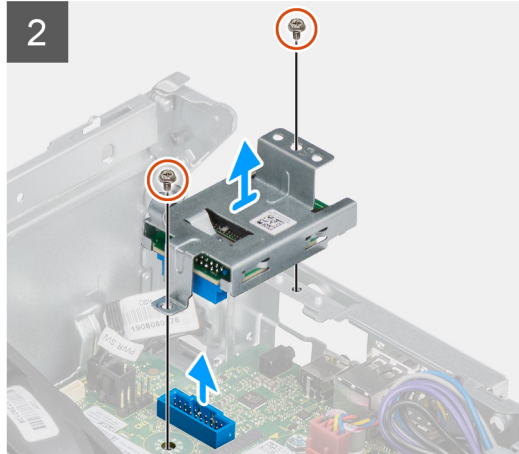
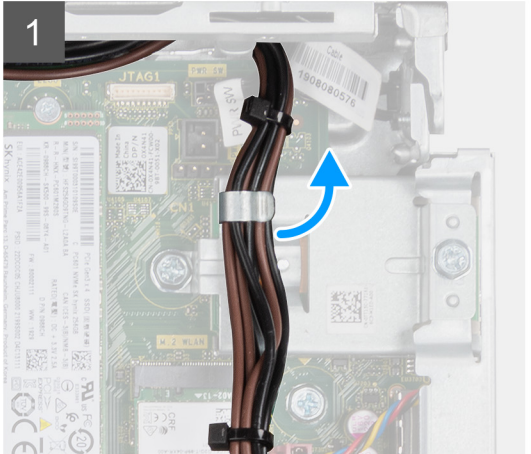

Steps

1. Unroute the PSU cable from the routing guides on the SD-card reader bracket.
2. Remove the two screws (M3x5) that secure the SD-card bracket to the system board and computer.
3. Lift the SD-card reader from the connector on the system board.

Installing the SD-card reader

Prerequisites

If you are replacing a component, remove the existing component before performing the installation procedure.

About this task

The following image indicates the location of the SD-card reader and provides a visual representation of the installation procedure.



2x
M3x5

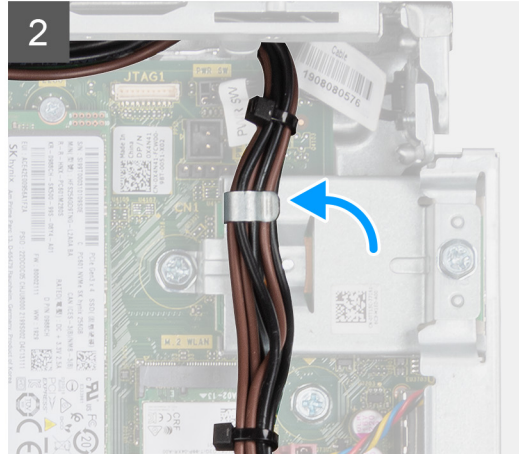
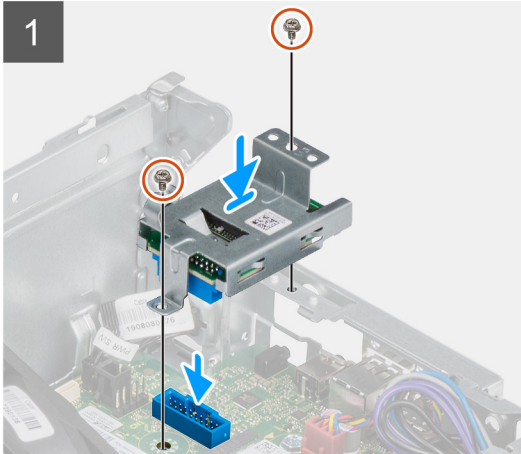

Steps

1. Place the SD-card reader onto the connector on the system board.
2. Install the two screws (M3x5) that secure the SD-card bracket to the system board and computer.
3. Reroute the cables through the routing guides on the SD-card reader bracket.

Next steps

1. Install the [2.5/3.5-inch hard-drive caddy](#).
2. Install the [hard-drive and optical-drive bracket](#).
3. Install the [front bezel](#).
4. Install the [side cover](#).
5. Follow the procedure in [after working inside your computer](#).

Side cover

Removing the side cover

Prerequisites

1. Follow the procedure in [before working inside your computer](#).
 **NOTE:** Ensure that you remove the security cable from the security-cable slot (if applicable).

About this task

The following images show the side covers and provide a visual representation of the removal procedure.



Steps

1. Slide the release latch to the right until you hear a click and slide the cover towards the back of the computer.
2. Lift the side cover from the computer.

Installing the side cover

Prerequisites

If you are replacing a component, remove the existing component before performing the installation procedure.

About this task

The following image shows the side cover and provides a visual representation of the installation procedure.



Steps

1. Place the side cover onto the system aligning the tabs on the chassis.
2. Slide the side cover towards the front of the computer until you hear the release latch click.

Next steps

1. Follow the procedure in [after working inside your computer](#).

Front bezel

Removing the front bezel

Prerequisites

1. Follow the procedure in [before working inside your computer](#).
2. Remove the [side cover](#).

About this task

The following images indicate the location of the front bezel and provide a visual representation of the removal procedure.

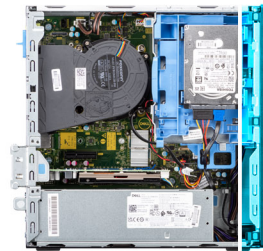

Steps

1. Gently pry and release the front-bezel tabs sequentially from the top.
2. Rotate the front bezel outward from the chassis.
3. Remove the front bezel from the chassis.

Installing the front bezel

Prerequisites

If you are replacing a component, remove the existing component before performing the installation procedure.

About this task

The following image indicates the location of the front bezel and provides a visual representation of the installation procedure.

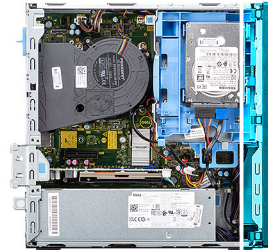

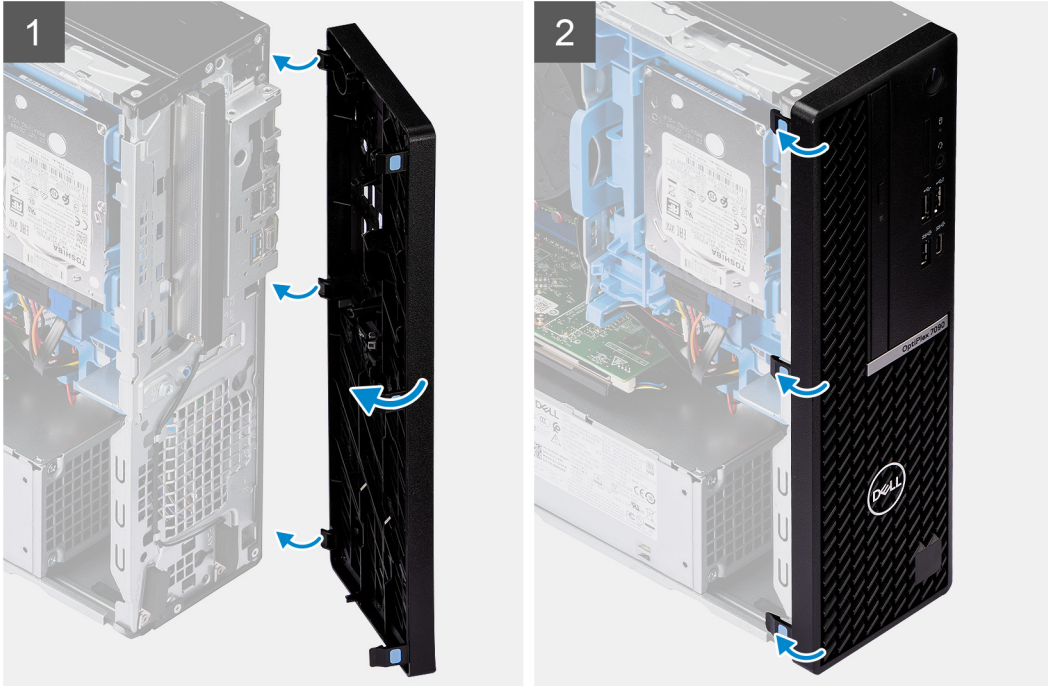
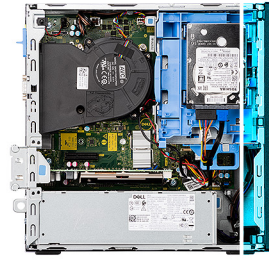

Steps

1. Align and insert the front-bezel tabs with the slots on the chassis.
2. Rotate the front bezel towards the chassis and snap it into place.

Next steps

1. Install the [side cover](#).
2. Follow the procedure in [after working inside your computer](#).

2.5-inch hard drive

Removing the 2.5-inch hard-drive caddy

Prerequisites

1. Follow the procedure in [before working inside your computer](#).
2. Remove the [side cover](#).
3. Remove the [front bezel](#).

About this task

The following images indicate the location of the 2.5-inch hard-drive caddy and provide a visual representation of the removal procedure.

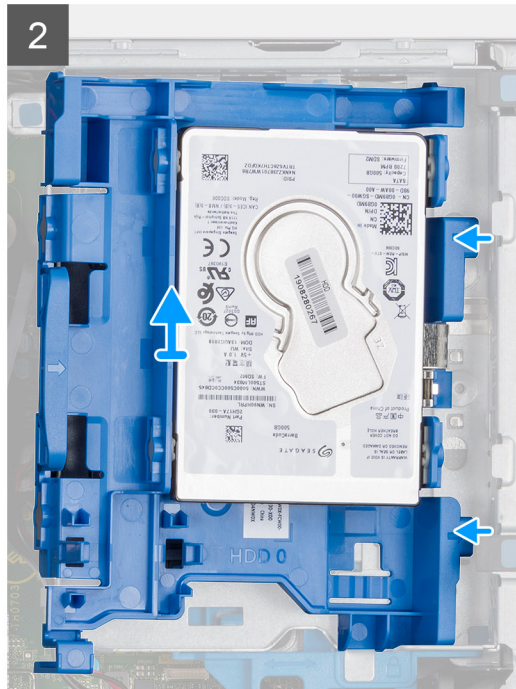
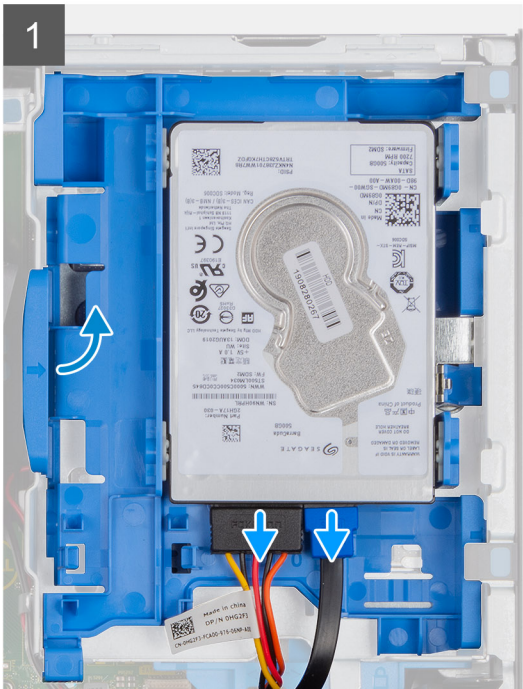
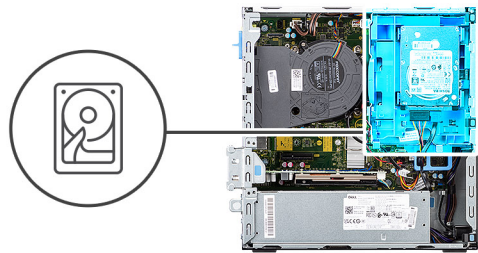

Steps

1. Disconnect the hard-drive data and power cables from the connectors on the hard drive and push the left tab towards the hard-drive to free the caddy from the chassis
2. Release the hard-drive caddy from the tabs on the right side and slide the hard-drive caddy out.

i **NOTE:** The hard-drive's power and data cables can only be connected from the bottom side of the caddy. Make a note of the orientation of the hard drive to avoid errors during installation.

Removing the 2.5-inch hard drive

Prerequisites

1. Follow the procedure in [before working inside your computer](#).
2. Remove the [side cover](#).
3. Remove the [front bezel](#).
4. Remove the [2.5-inch hard-drive caddy](#).

About this task

The following images indicate the location of the 2.5-inch hard drive and provide a visual representation of the removal procedure.

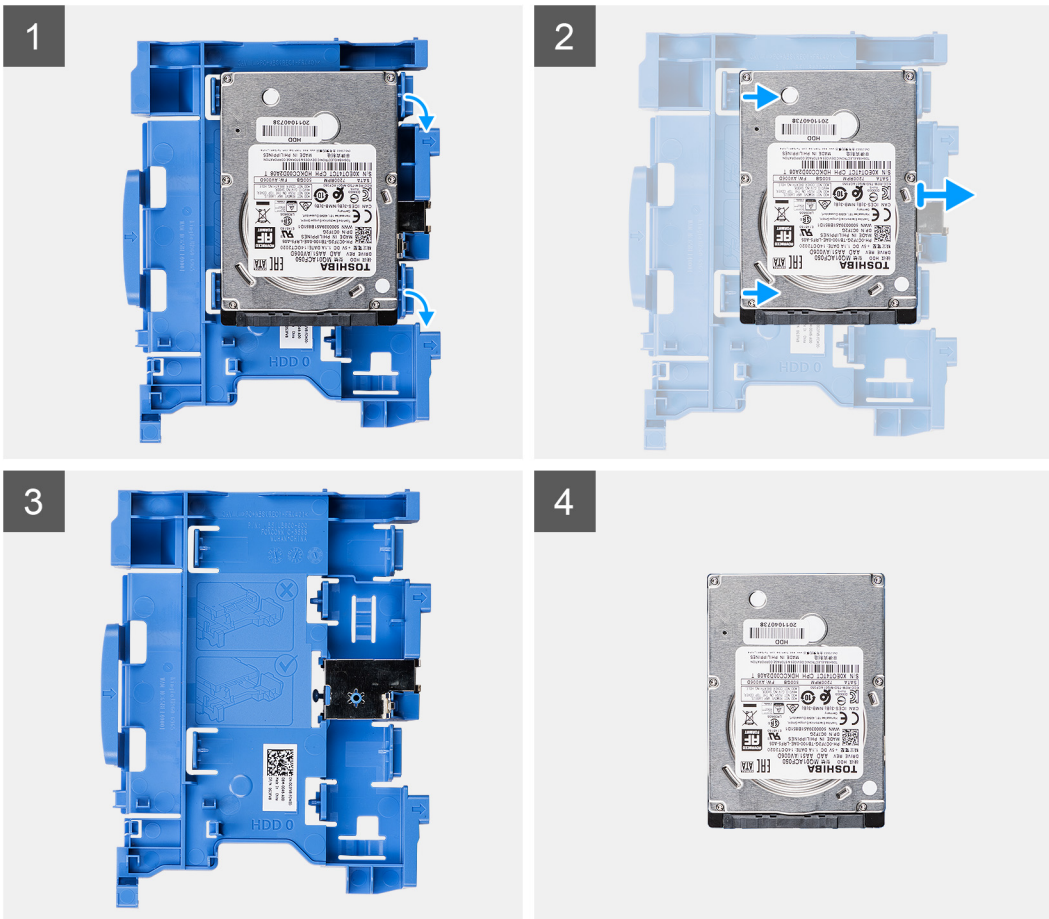

Steps

1. Pull the two tabs from the hard-drive caddy away from the hard-drive.
2. Slide the hard-drive towards the right to free it from the mounting points on the caddy and lift it away from the system.

Installing the 2.5-inch hard drive

Prerequisites

If you are replacing a component, remove the existing component before performing the installation procedure.

About this task

The following image shows the 2.5-inch hard drive and provides a visual representation of the installation procedure.

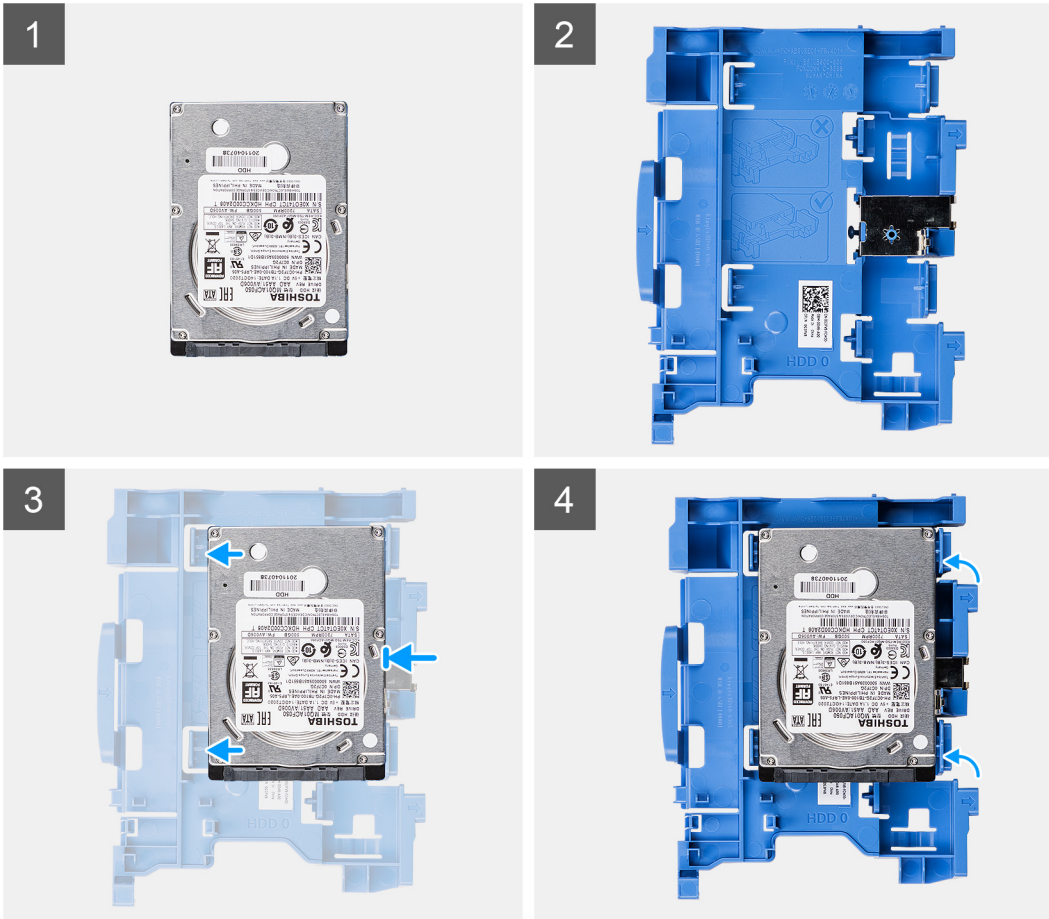

Steps

1. Align the hard-drive with the mounting points on the caddy and place the hard-drive onto it.
2. Pull the tabs on the right side of the caddy until the hard-drive clicks into place.

Next steps

1. Install the [2.5-inch hard-drive caddy](#).
2. Install the [front bezel](#).
3. Install the [side cover](#).
4. Follow the procedure in [after working inside your computer](#).

Installing the 2.5-inch hard-drive caddy

Prerequisites

If you are replacing a component, remove the existing component before performing the installation procedure.

About this task

The following image indicates the location of the 2.5-inch hard-drive caddy and provides a visual representation of the installation procedure.

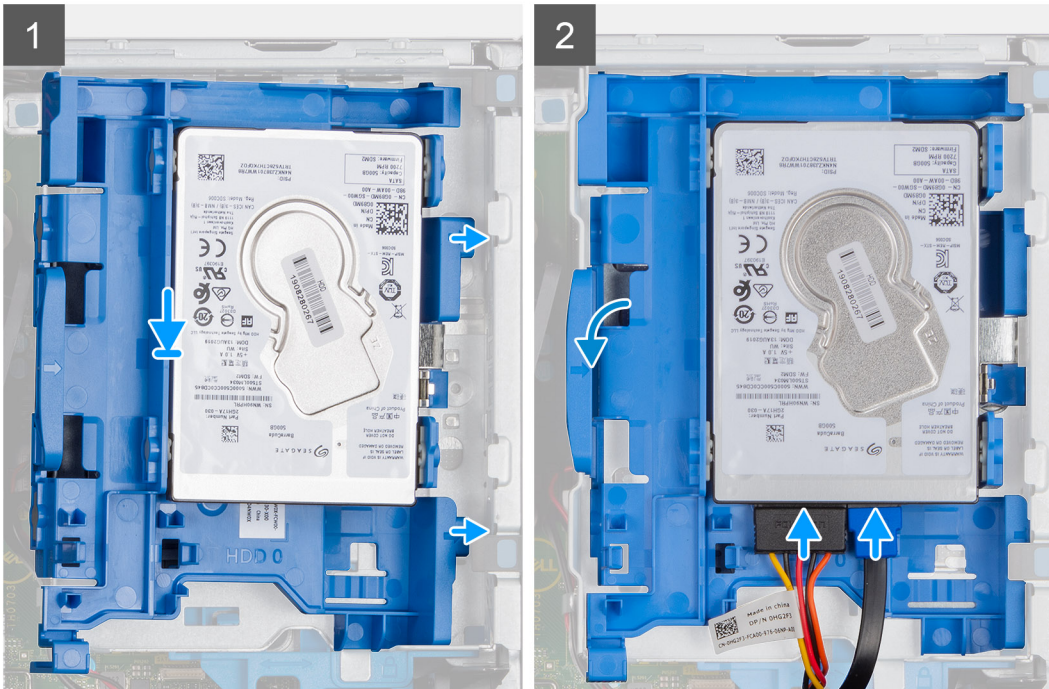
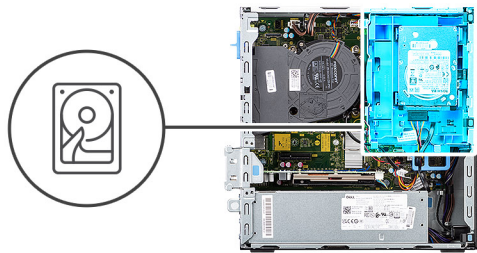

Steps

1. Place the tabs on the right side of the hard-drive caddy onto the holders on the chassis and push the left side of the caddy down until it clicks into place.

NOTE: Use the arrows seen on the caddy as guides to identify the tabs on the tray.

2. Connect the hard-drive data and power cables to the connectors on the hard drive.

Next steps

1. Install the [front bezel](#).
2. Install the [side cover](#).
3. Follow the procedure in [after working inside your computer](#).

3.5-inch hard drive

Removing the 3.5-inch hard-drive caddy

Prerequisites

1. Follow the procedure in [before working inside your computer](#).
2. Remove the [side cover](#).
3. Remove the [front bezel](#).

About this task

The following images indicate the location of the 3.5-inch hard-drive caddy and provide a visual representation of the removal procedure.

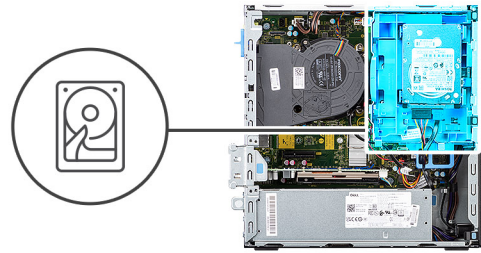

Steps

1. Disconnect the hard-drive data and power cables from the connectors on the hard drive and push the left tab towards the hard-drive to free the caddy from the chassis
2. Release the hard-drive caddy from the tabs on the right side and slide the hard-drive caddy out.

NOTE: The hard-drive's power and data cables can only be connected from the bottom side of the caddy. Make a note of the orientation of the hard drive to avoid errors during installation.

Removing the 3.5-inch hard drive

Prerequisites

1. Follow the procedure in [before working inside your computer](#).
2. Remove the [side cover](#).
3. Remove the [front bezel](#).
4. Remove the [3.5-inch hard-drive caddy](#).

About this task

The following images indicate the location of the 3.5-inch hard drive and provide a visual representation of the removal procedure.

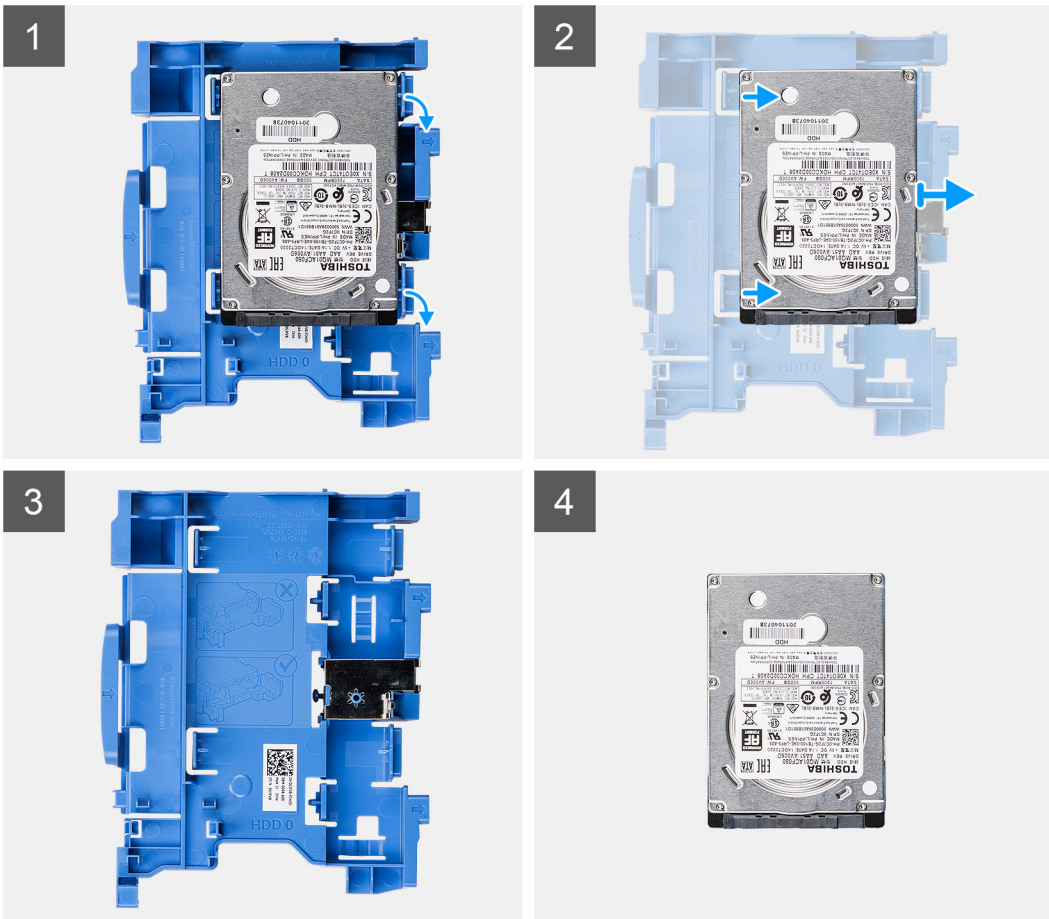

Steps

1. Pull the two tabs from the hard-drive caddy away from the hard-drive.
2. Slide the hard-drive towards the right to free it from the mounting points on the caddy and lift it away from the system.

Installing the 3.5-inch hard drive

Prerequisites

If you are replacing a component, remove the existing component before performing the installation procedure.

About this task

The following image shows the 3.5-inch hard drive and provides a visual representation of the installation procedure.

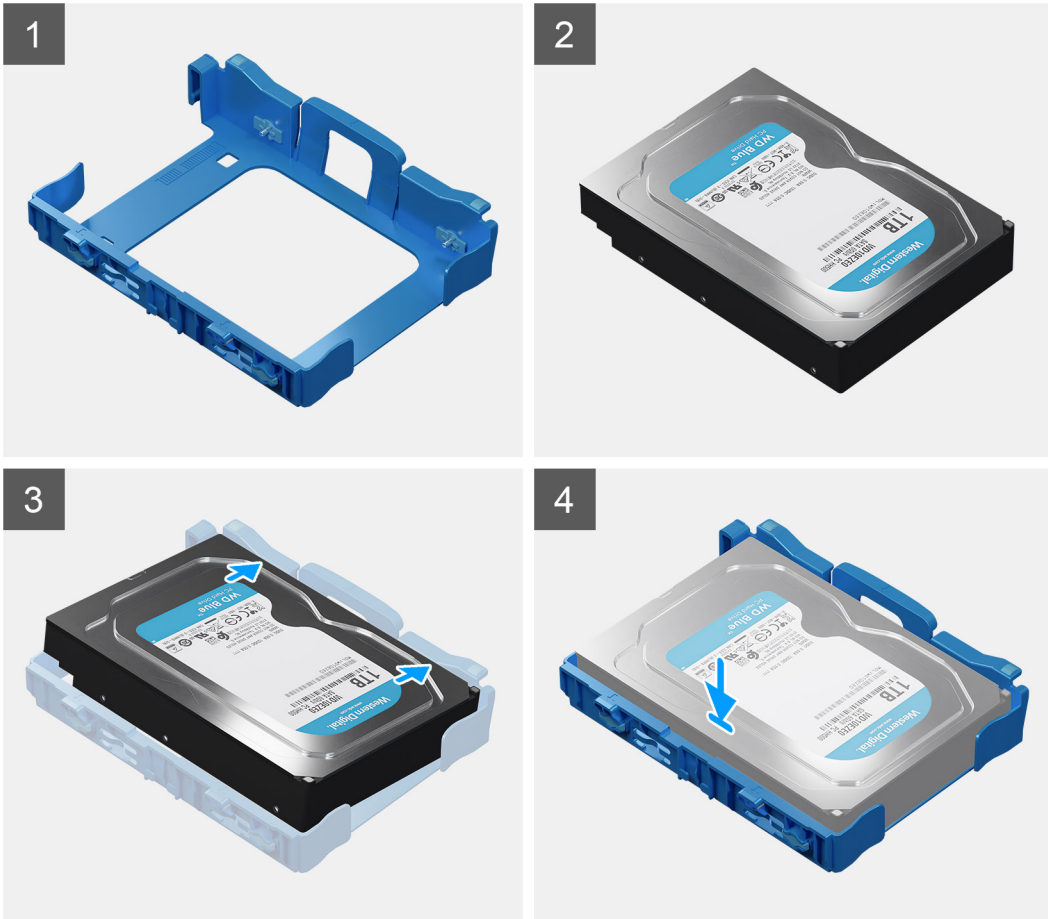

Steps

1. Align the hard-drive with the mounting points on the caddy and place the hard-drive onto it.
2. Pull the tabs on the right side of the caddy until the hard-drive clicks into place.

Next steps

1. Install the [3.5-inch hard-drive caddy](#).
2. Install the [front bezel](#).
3. Install the [side cover](#).
4. Follow the procedure in [after working inside your computer](#).

Installing the 3.5-inch hard-drive caddy

Prerequisites

If you are replacing a component, remove the existing component before performing the installation procedure.

About this task

The following image indicates the location of the 3.5-inch hard-drive caddy and provides a visual representation of the installation procedure.

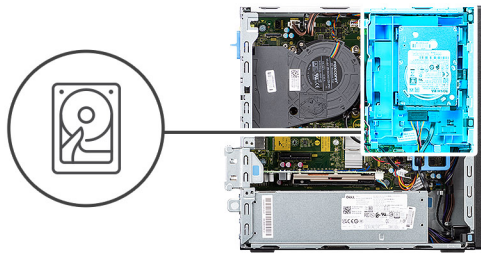

Steps

1. Place the tabs on the right side of the hard-drive caddy onto the holders on the chassis and push the left side of the caddy down until it clicks into place.

NOTE: Use the arrows seen on the caddy as guides to identify the tabs on the tray.

2. Connect the hard-drive data and power cables to the connectors on the hard drive.

Next steps

1. Install the [front bezel](#).
2. Install the [side cover](#).
3. Follow the procedure in [after working inside your computer](#).

Solid-state drive

Removing the M.2 2230 solid-state drive

Prerequisites

1. Follow the procedure in [before working inside your computer](#).
2. Remove the [side cover](#).
3. Remove the [front bezel](#).
4. Remove the [2.5/3.5-inch caddy](#).

About this task

The following images indicate the location of the M.2 2230 solid-state drive and provide a visual representation of the removal procedure.



1x
M2x3

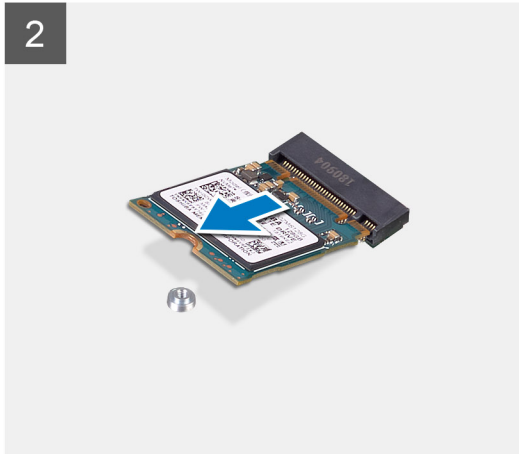
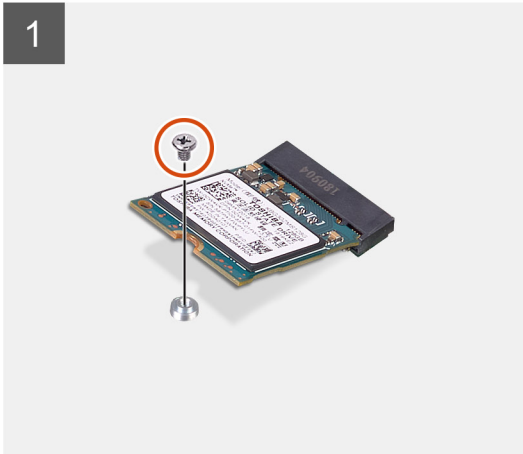
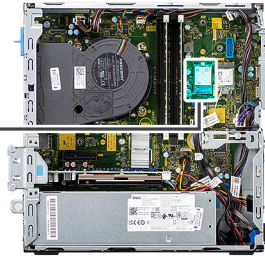

Steps

1. Remove the single (M2x3) screw that secures the solid-state drive to the system board.
2. Slide and lift the solid-state drive off the system board.

Installing the M.2 2230 solid-state drive

Prerequisites

If you are replacing a component, remove the existing component before performing the installation procedure.

About this task

The following image indicates the location of the M.2 2230 solid-state drive and provides a visual representation of the installation procedure.



1x
M2x3

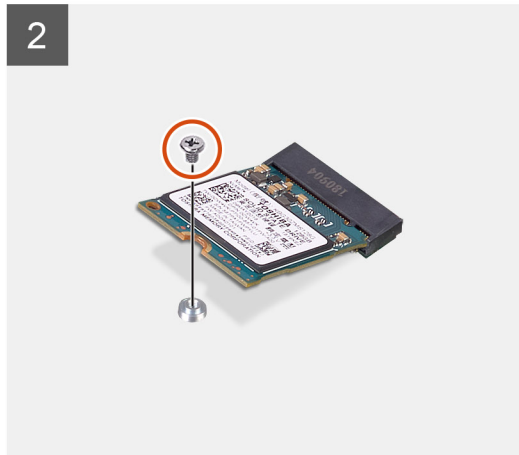
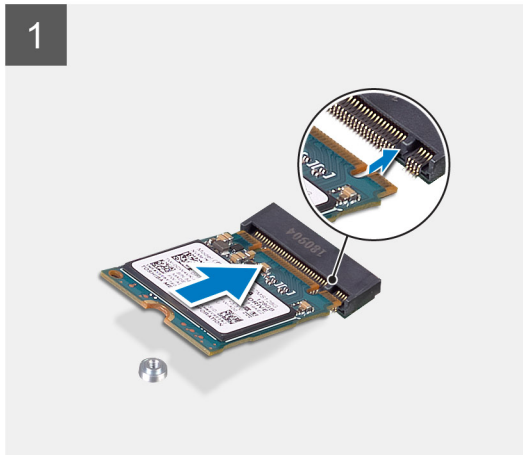
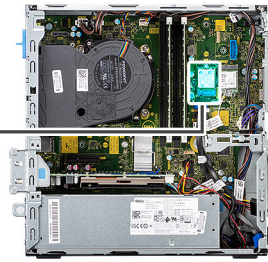

Steps

1. Align the solid-state drive with the socket on the system board and slide it in.
2. Replace the single (M2X3) screw that secures the M.2 solid-state drive to the system board.

Next steps

1. Install the [2.5/3.5-inch hard-drive caddy](#).
2. Install the [front bezel](#).
3. Install the [side cover](#).
4. Follow the procedure in [after working inside your computer](#).

Removing the M.2 2280 solid-state drive

Prerequisites

1. Follow the procedure in [before working inside your computer](#).
2. Remove the [side cover](#).
3. Remove the [front bezel](#).
4. Remove the [2.5/3.5-inch hard-drive caddy](#).

About this task

The following images indicate the location of the M.2 2280 solid-state drive and provide a visual representation of the removal procedure.



1x
M2x3

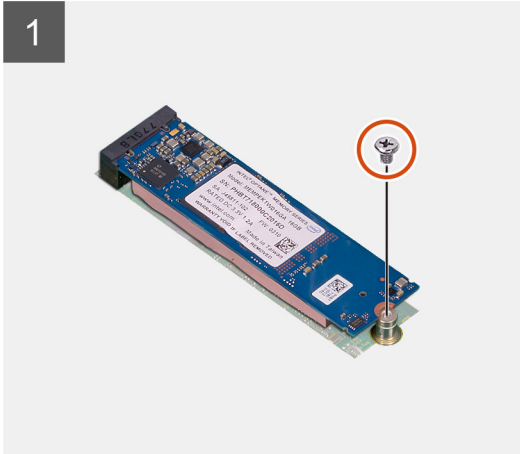
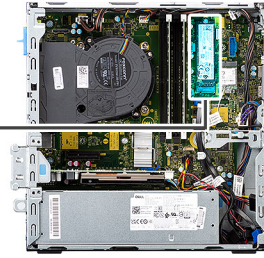

Steps

1. Remove the screw (M2x3) that secures the solid-state drive to the system board.
2. Slide and lift the solid-state drive off the system board.

Installing the M.2 2280 solid-state drive

Prerequisites

If you are replacing a component, remove the existing component before performing the installation procedure.

About this task

The following image indicates the location of the M.2 2280 solid-state drive and provides a visual representation of the installation procedure.



1x
M2x3

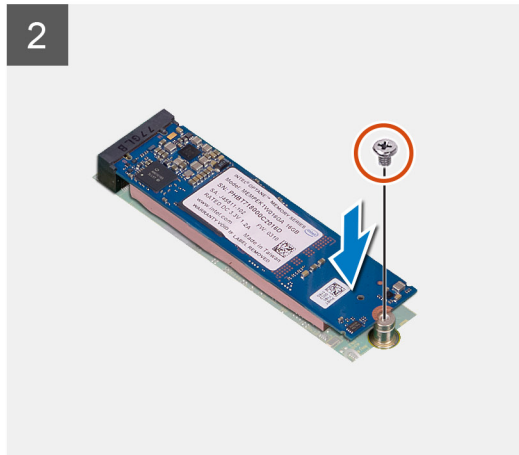
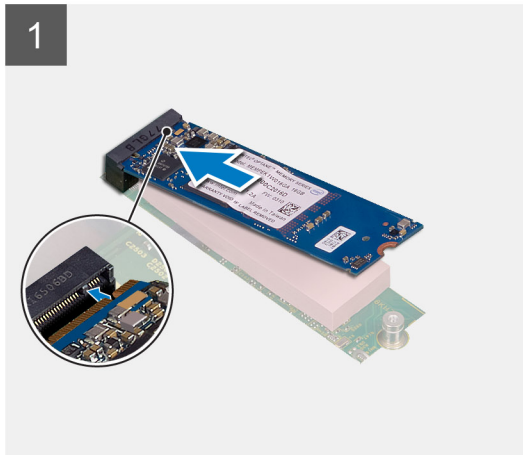
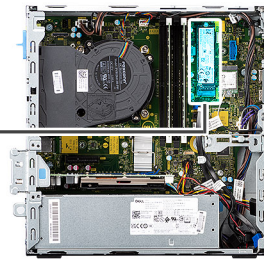

Steps

1. Align the solid-state drive with the socket on the system board and slide it in.
2. Replace the single (M2X3) screw that secures the M.2 solid-state drive to the system board.

Next steps

1. Install the [2.5/3.5-inch hard-drive caddy](#).
2. Install the [front bezel](#).
3. Install the [side cover](#).
4. Follow the procedure in [after working inside your computer](#).

Memory modules

Removing the memory modules

Prerequisites

1. Follow the procedure in [before working inside your computer](#).
2. Remove the [side cover](#).
3. Remove the [2.5/3.5-inch hard-drive caddy](#).
4. Remove the [hard-drive and optical-drive bracket](#).

 **NOTE:** CAUTION: To prevent damage to the memory module, hold the memory module by the edges. Do not touch the components on the memory module.

About this task

The following images indicate the location of the memory modules and provide a visual representation of the removal procedure.

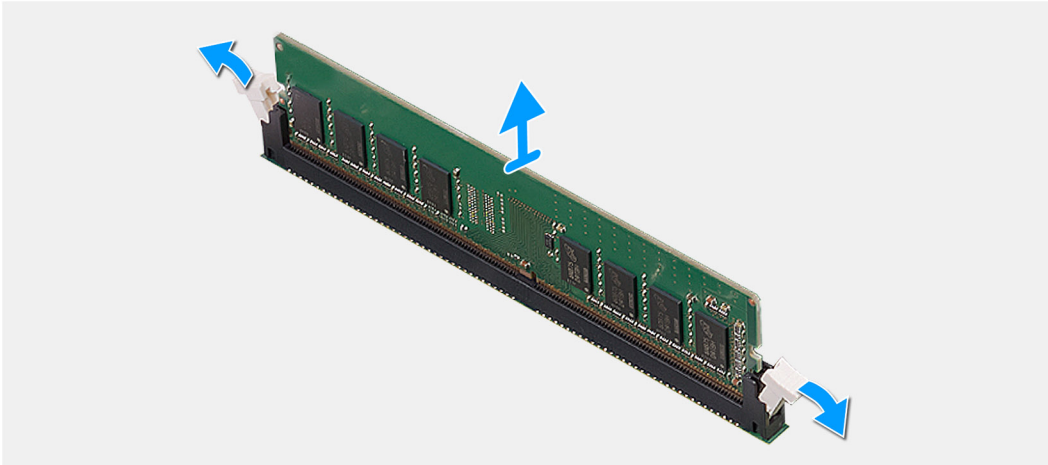
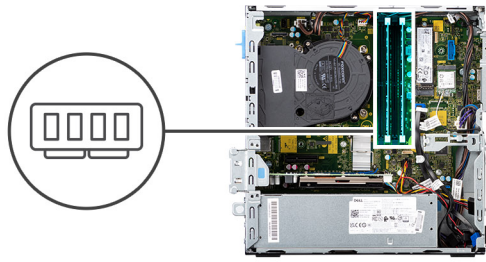

Steps

1. Use your fingertips to carefully spread apart the securing-clips on each end of the memory-module slot.
2. Grasp the memory module near the securing clip, and then gently ease the memory module out of the memory-module slot.

i **NOTE:** Grasp the memory module near the securing clip, and then gently ease the memory module out of the memory-module slot.

i **NOTE:** If the memory module is difficult to remove, gently ease the memory module back and forth to remove it from the slot.

Installing the memory modules

Prerequisites

If you are replacing a component, remove the existing component before performing the installation procedure.

About this task

The following image indicates the location of the memory modules and provides a visual representation of the installation procedure.

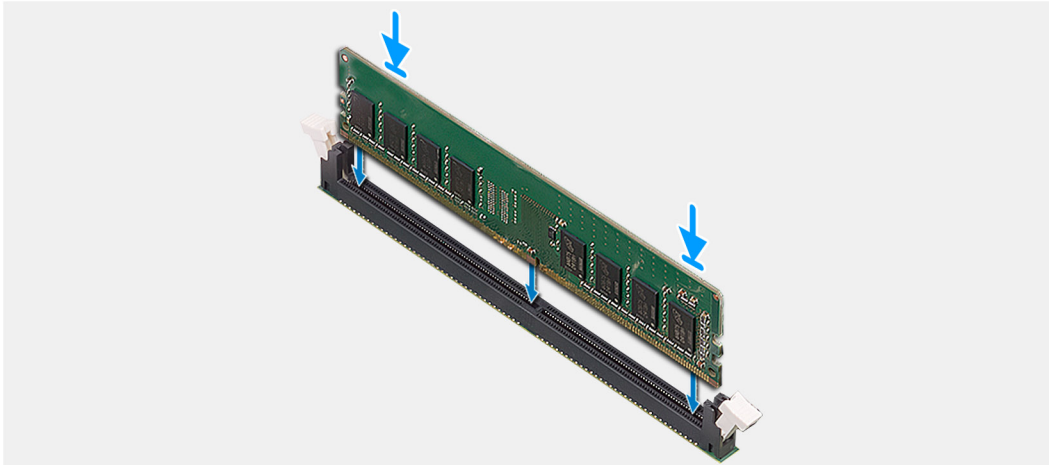
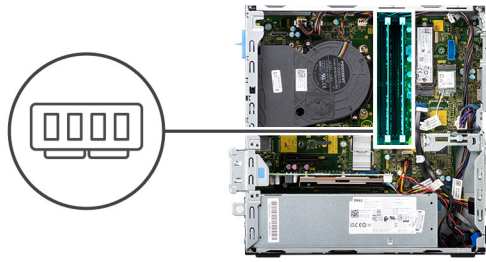

Steps

1. Ensure that the securing clips are in an open position.
2. Align the notch on the memory module with the tab on the memory-module slot.
3. Insert the memory module into the memory-module connector until the memory module snaps into position and the securing clip locks in place.

i **NOTE:** The securing clips return to the locked position. If you do not hear the click, remove the memory module and reinstall it.

i **NOTE:** Repeat step 1 to step 3 when installing more than one memory module in your computer.

Next steps

1. Install the [2.5/3.5-inch hard-drive caddy](#).
2. Install the [side cover](#).
3. Follow the procedure in [after working inside your computer](#).

Hard-drive and optical-drive bracket

Removing the hard-drive and optical-drive bracket

Prerequisites

1. Follow the procedure in [before working inside your computer](#).
2. Remove the [side cover](#).
3. Remove the [front bezel](#).
4. Remove the [2.5/3.5-inch hard-drive caddy](#).

About this task

The following images indicate the location of the hard-drive and optical-drive bracket and provide a visual representation of the removal procedure.

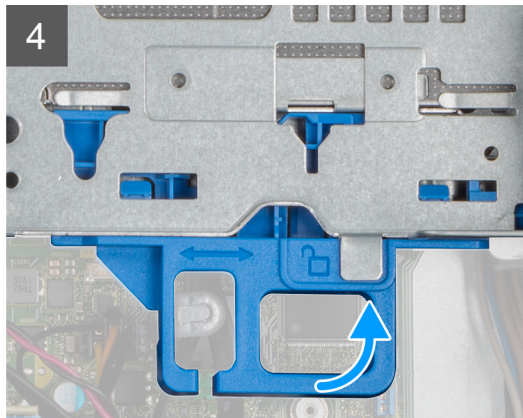
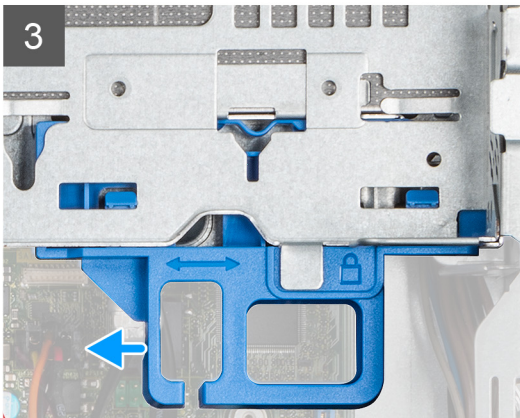
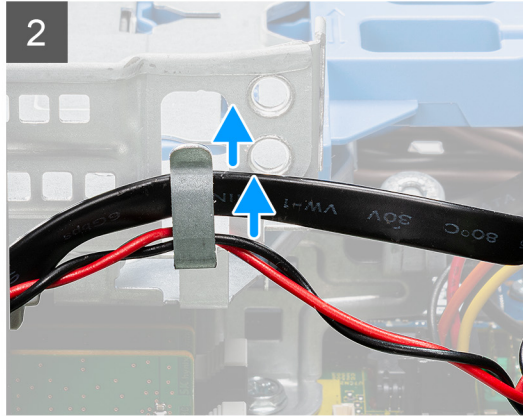
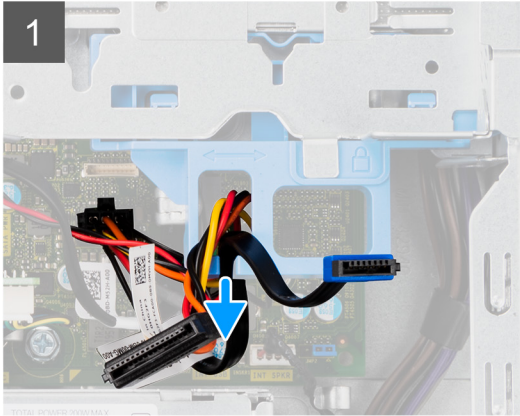
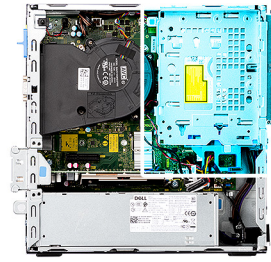

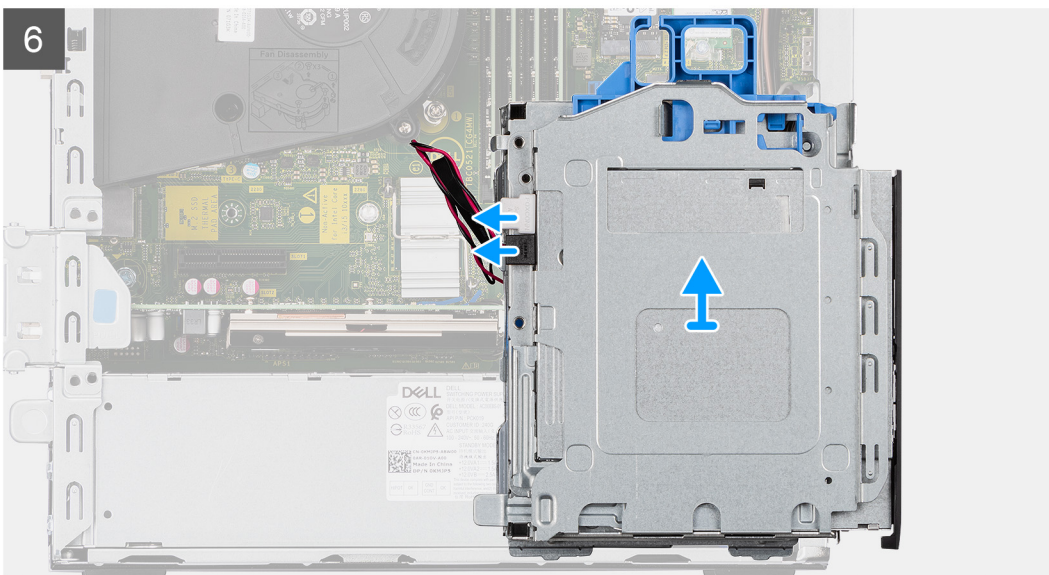
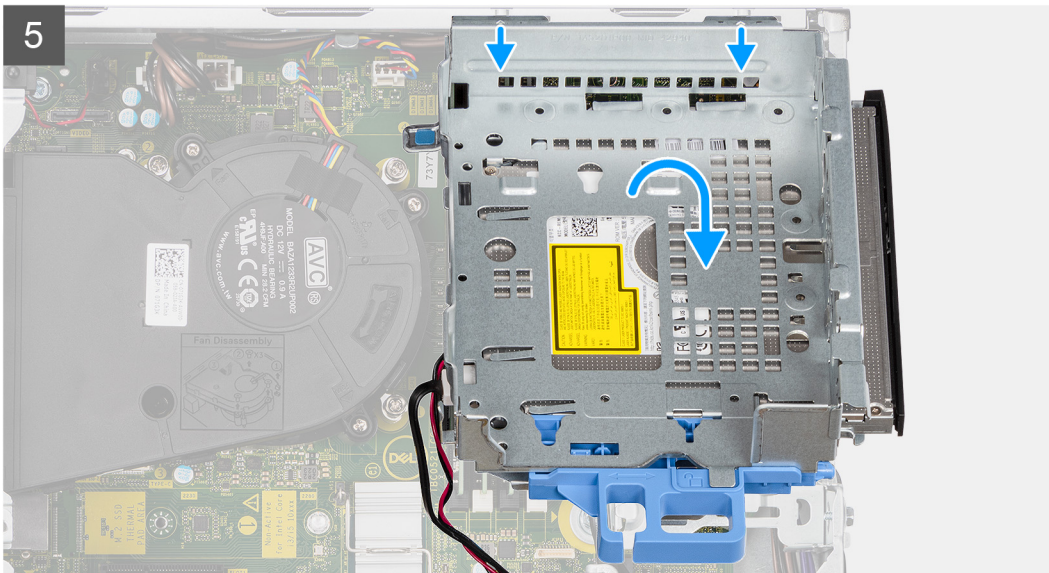

Steps

1. Remove the hard-drive power and data cables that are routed via the locking mechanism.
2. Remove the cables from the routing points on the bracket.
3. Move the lock handle from the locking mechanism towards the left to unlock the bracket and detach it from the chassis.
4. Hold the lock handle to lift the bracket.
5. Lift the bracket upwards and detach it from the mounting points on the top portion of the chassis.
6. Disconnect the power and SATA cables from the optical drive and lift the bracket away from the computer.

Installing the hard-drive and optical-drive bracket

Prerequisites

If you are replacing a component, remove the existing component before performing the installation procedure.

About this task

The following image indicates the location of the hard-drive and optical-drive bracket and provides a visual representation of the installation procedure.

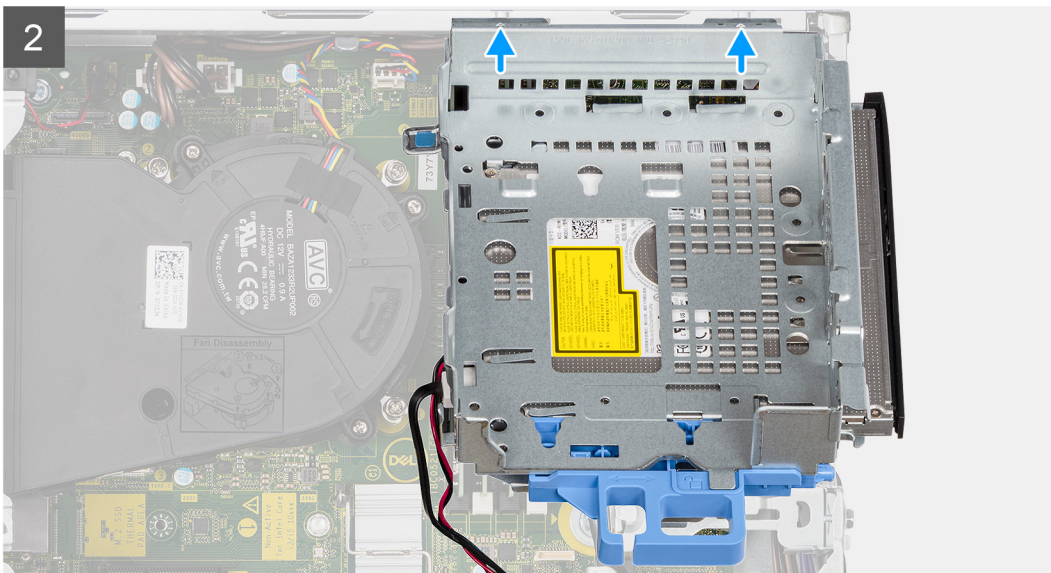
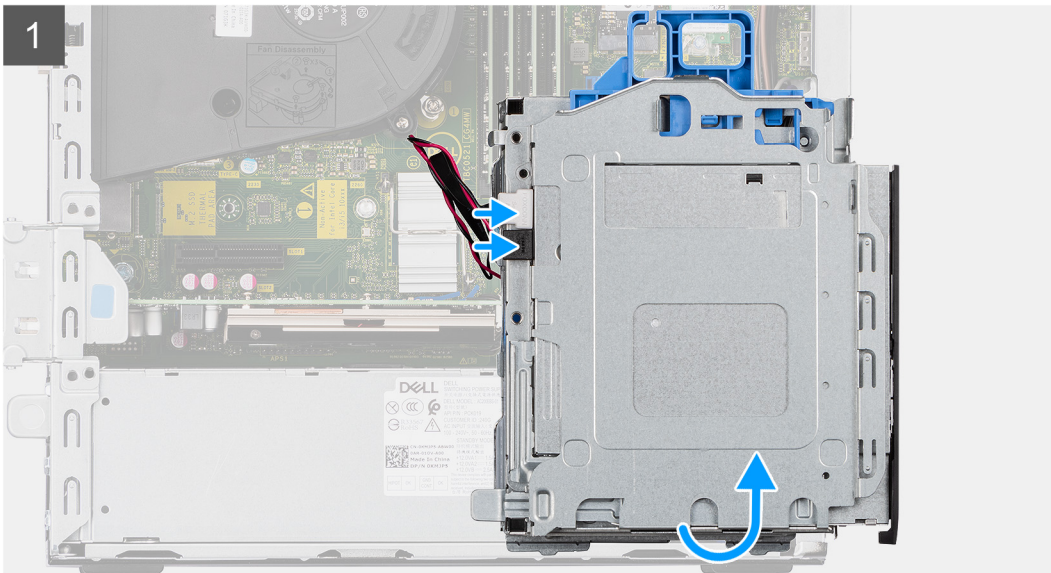

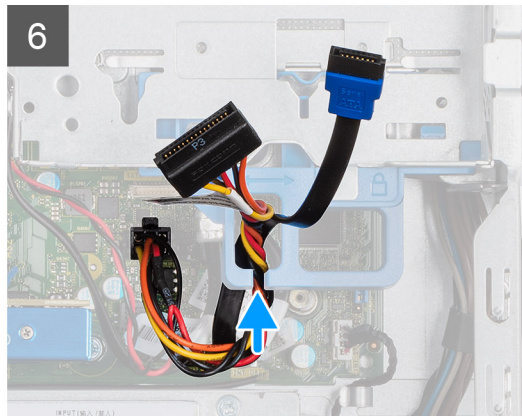
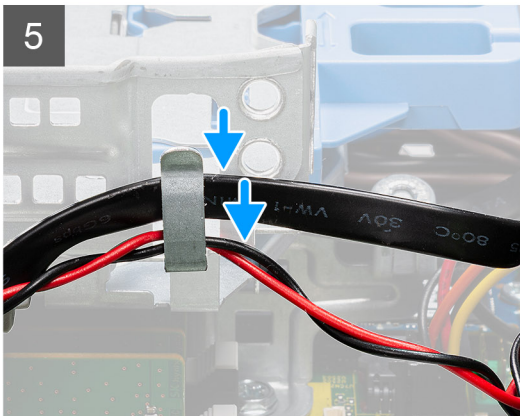
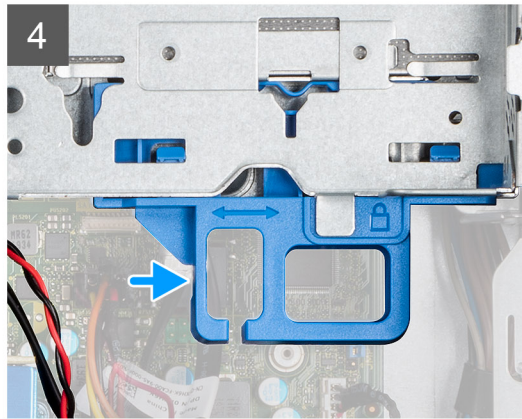
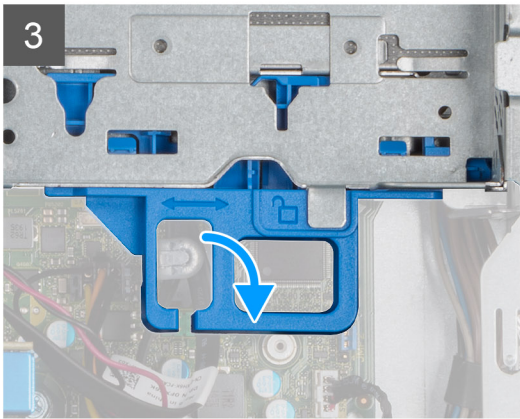
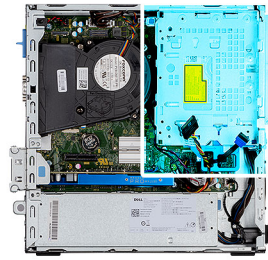

Steps

1. Connect the power and SATA cables to the optical drive while holding the bracket upside down.
2. Hold the bracket upright and align the mounting points with the ones on the chassis.
3. Push the bracket until the assembly is secured onto the chassis.
4. Move the lock handle from the locking mechanism towards the right to lock the bracket in place.
5. Route the optical drive's power and data cables through the routing guide on the bracket.
6. Route the hard-drive power and SATA cables through the routing guide on the lock.

Next steps

1. Install the [2.5/3.5-inch hard-drive caddy](#).
2. Install the [front bezel](#).
3. Install the [side cover](#).
4. Follow the procedure in [after working inside your computer](#).

Optical drive

Removing the slim optical-drive

Prerequisites

1. Follow the procedure in [before working inside your computer](#).
2. Remove the [side cover](#).
3. Remove the [front bezel](#).
4. Remove the [2.5/3.5-inch hard-drive caddy](#).
5. Remove the [hard-drive and optical-drive caddy](#).

About this task

The following images show the slim optical-drive and provide a visual representation of the removal procedure.

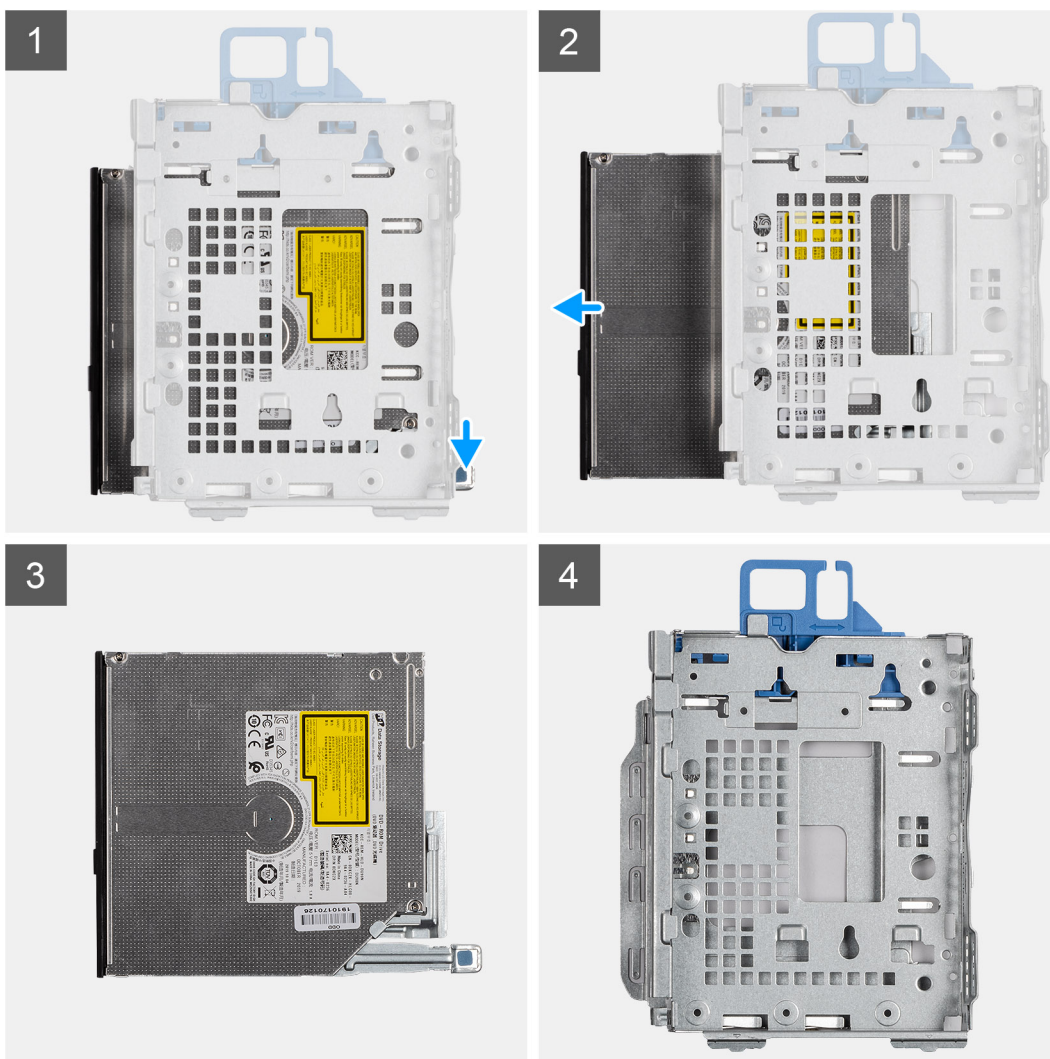

Steps

1. Press the tab on the optical drive to release the optical drive from the hard-drive and optical drive bracket.
2. Slide the optical drive out of the hard-drive and optical drive bracket.

Installing the slim optical-drive

Prerequisites

If you are replacing a component, remove the existing component before performing the installation procedure.

About this task

The following images show the slim optical-drive and provide a visual representation of the installation procedure.

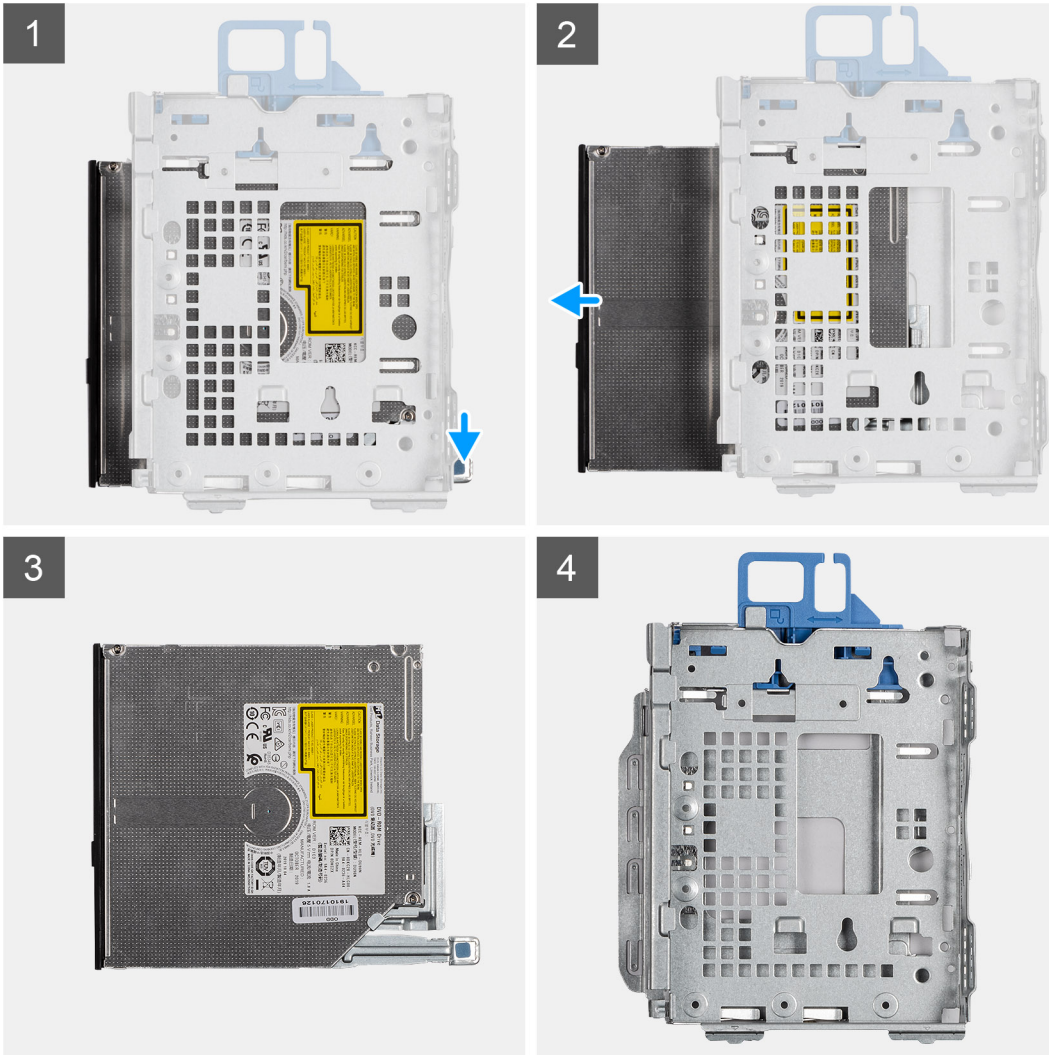

Steps

1. Insert and slide in the optical drive into the hard-drive and optical drive bracket.
2. Push the optical drive unit until it clicks in place.

Next steps

1. Install the [hard-drive and optical-drive caddy](#).
2. Install the [2.5/3.5-inch hard-drive caddy](#).
3. Install the [front bezel](#).
4. Install the [side cover](#).
5. Follow the procedure in [after working inside your computer](#).

WLAN card

Removing the WLAN card

Prerequisites

1. Follow the procedure in [before working inside your computer](#).
2. Remove the [side cover](#).
3. Remove the [front bezel](#).
4. Remove the [2.5/3.5-inch hard-drive caddy](#).
5. Remove the [hard-drive and optical-drive bracket](#).

About this task

The following images indicate the location of the wireless card and provide a visual representation of the removal procedure.



1x
M2x3

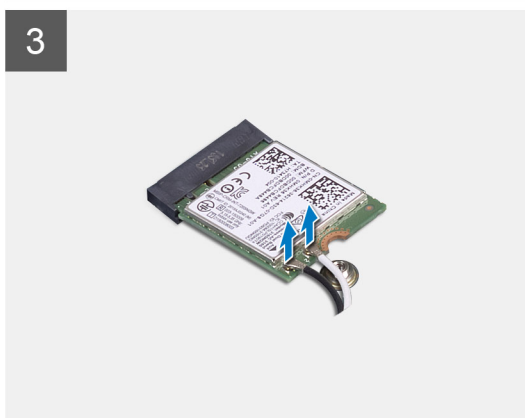
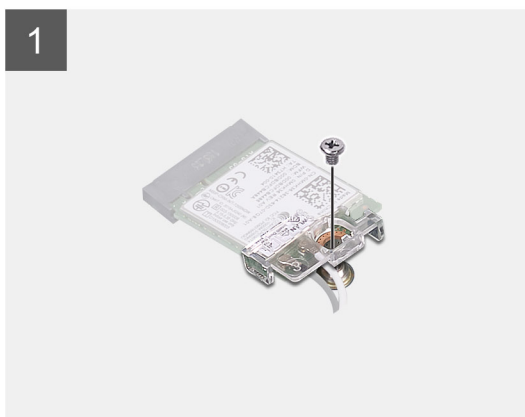
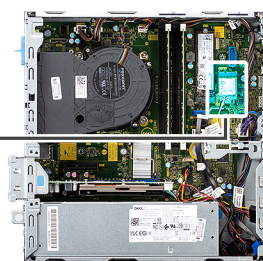

Steps

1. Remove the screw (M2x3) that secures the wireless card to the system board.
2. Slide and lift the wireless-card bracket off the wireless card.
3. Disconnect the antenna cables from the wireless card.

- Slide and remove the wireless card at an angle from the wireless-card slot.

Installing the WLAN card

Prerequisites

If you are replacing a component, remove the existing component before performing the installation procedure.

About this task

The following image indicates the location of the wireless card and provides a visual representation of the installation procedure.



1x
M2x3

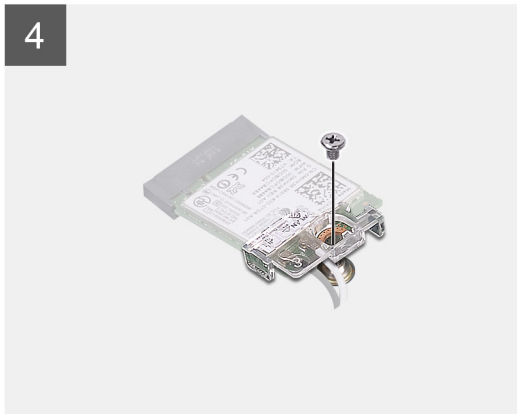
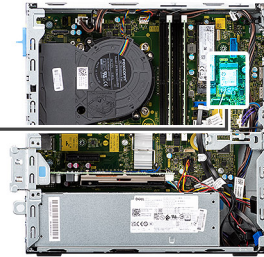

Steps

- Connect the antenna cables to the WLAN card.

The following table provides the antenna-cable color scheme for the WLAN card of your computer.

Table 2. Antenna-cable color scheme

Connectors on the wireless card	Antenna-cable color
Main (white triangle)	White
Auxiliary (black triangle)	Black

2. Slide and place the wireless-card bracket on the wireless card.
3. Align the notch on the wireless card with the tab on the wireless-card slot.
4. Slide the wireless card at an angle into the wireless-card slot.
5. Replace the screw (M2x3) that secures the wireless card to the system board.

Next steps

1. Install the [2.5/3.5-inch hard-drive caddy](#).
2. Install the [hard-drive and optical-drive bracket](#).
3. Install the [front bezel](#).
4. Install the [side cover](#).
5. Follow the procedure in [after working inside your computer](#).

Heat-sink and fan assembly

Removing the heat-sink and fan assembly

Prerequisites

1. Follow the procedure in [before working inside your computer](#).
2. Remove the [side cover](#).
3. Remove the [front bezel](#).

About this task

The following images indicate the location of the heat-sink and fan assembly and provide a visual representation of the removal procedure.

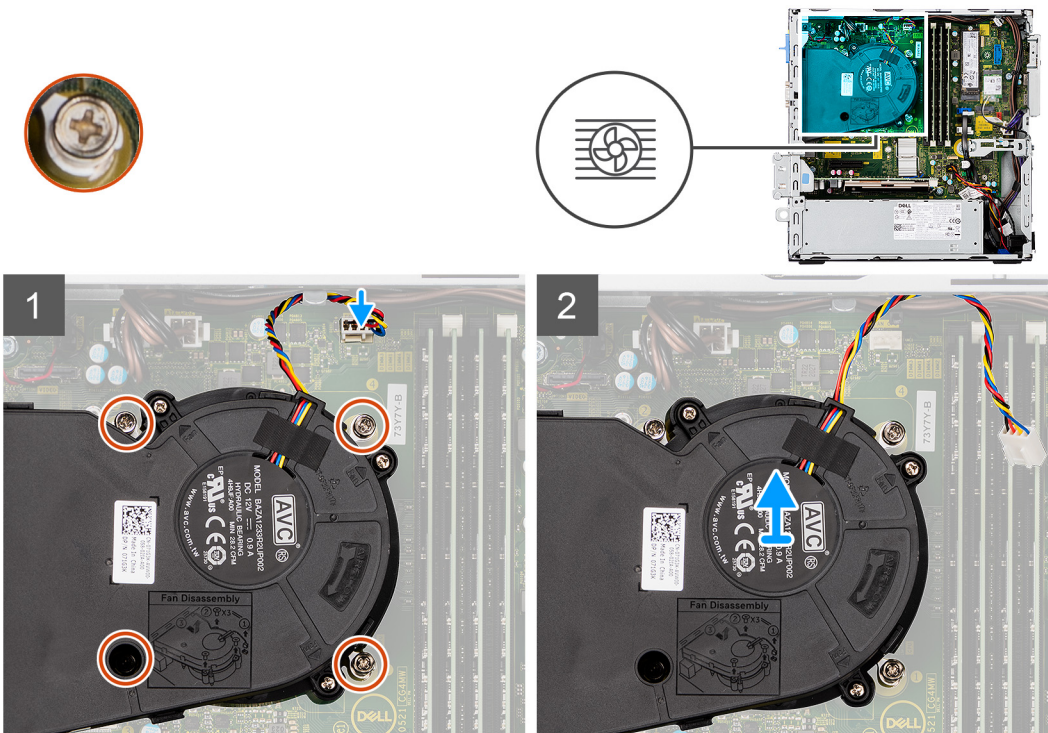

Steps

1. Disconnect the fan cable from the connector on the system board.
2. Loosen the four captive screws that secure the heat-sink and fan assembly to the system.
3. Lift the heat-sink and fan assembly from the system.

Installing the heat-sink and fan assembly

Prerequisites

If you are replacing a component, remove the existing component before performing the installation procedure.

About this task

The following image indicates the location of the heat-sink and fan assembly and provides a visual representation of the installation procedure.

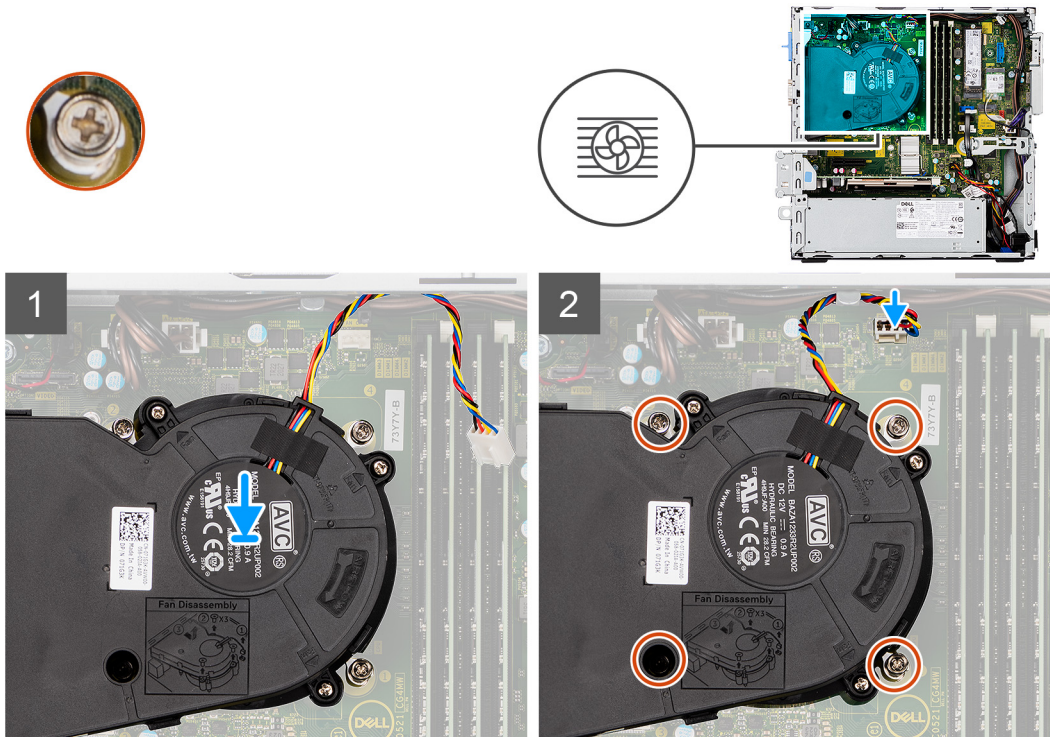

Steps

1. Place the heat-sink and fan assembly onto the system board.
2. Tighten the captive screws that secure the heat-sink and fan assembly to the system board.
3. Connect the fan cable to the connector on the system board.

Next steps

1. Install the [front bezel](#).
2. Install the [side cover](#).
3. Follow the procedure in [after working inside your computer](#).

Heat-sink fan

Removing the heat-sink fan

Prerequisites

1. Follow the procedure in [before working inside your computer](#).
2. Remove the [side cover](#).
3. Remove the [front bezel](#).

About this task

The following images indicate the location of the fan and provide a visual representation of the removal procedure.

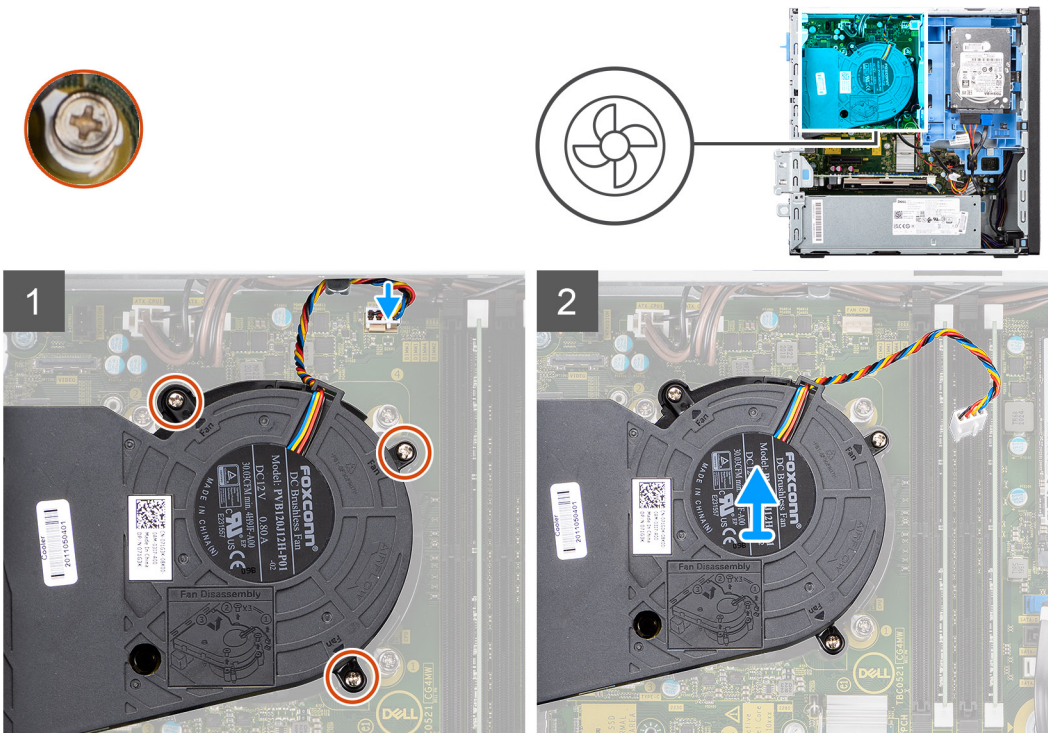

Steps

1. Disconnect the fan cable from the connector on the system board.
2. Loosen the four captive screws that secure the fan to the heat-sink assembly.
3. Lift the fan assembly from the system.

Installing the heat-sink fan

Prerequisites

If you are replacing a component, remove the existing component before performing the installation procedure.

About this task

The following image indicates the location of the fan and provides a visual representation of the installation procedure.

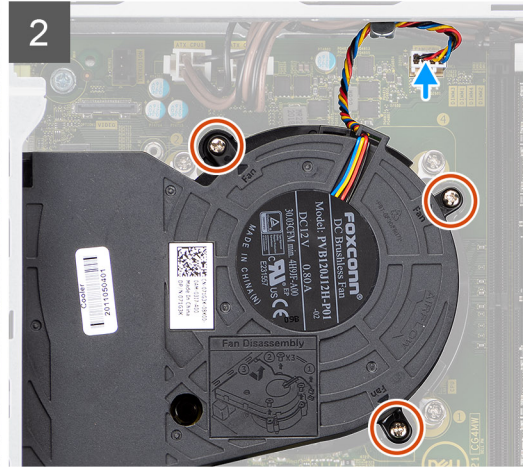
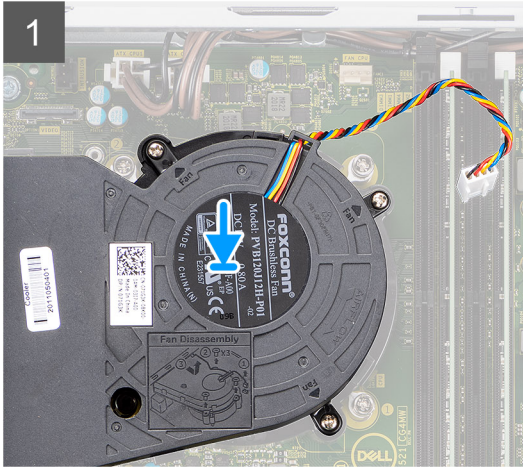
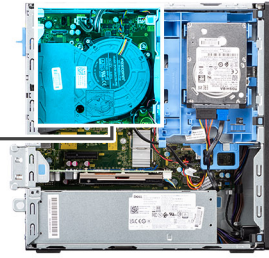
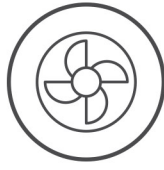

Steps

1. Place the fan onto the heat-sink assembly.
2. Tighten the captive screws that secure the fan to the heat-sink assembly.
3. Connect the fan cable to the connector on the system board.

Next steps

1. Install the [front bezel](#).
2. Install the [side cover](#).
3. Follow the procedure in [after working inside your computer](#).

Expansion card

Removing the graphics card

Prerequisites

1. Follow the procedure in [before working inside your computer](#).
2. Remove the [side cover](#).

About this task

The following images indicate the location of the graphics card and provide a visual representation of the removal procedure.

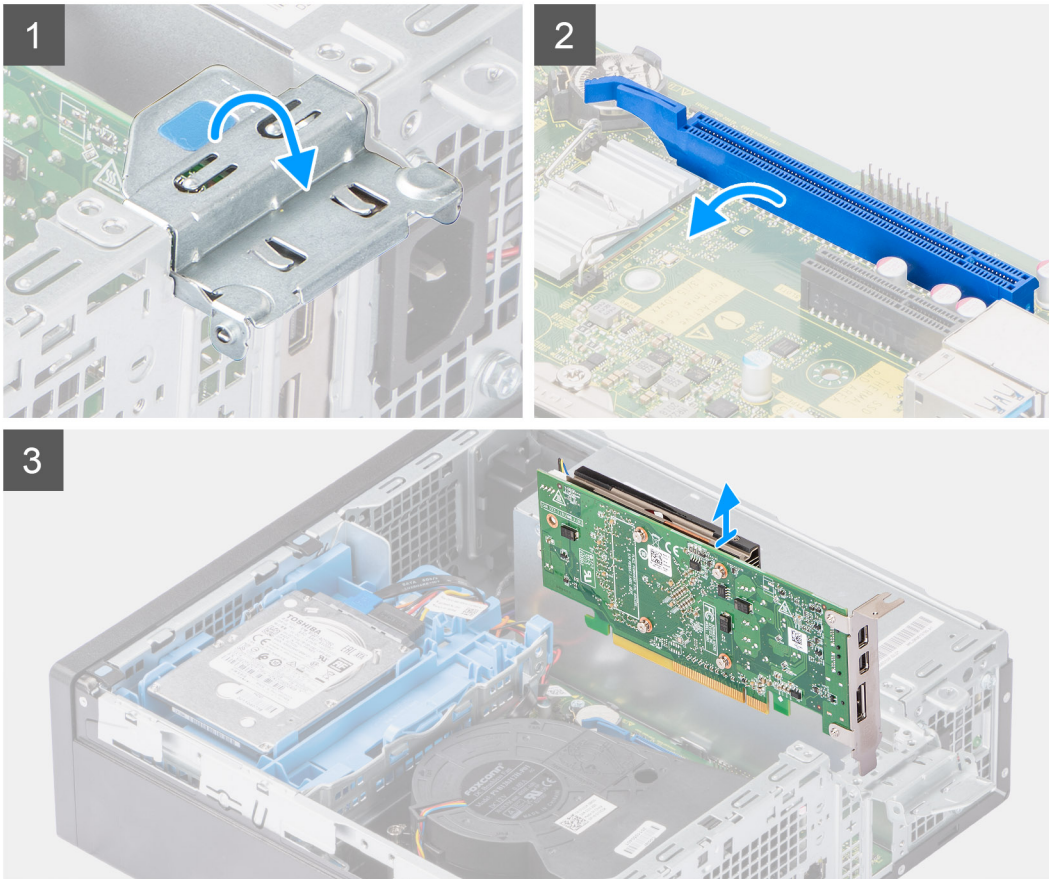
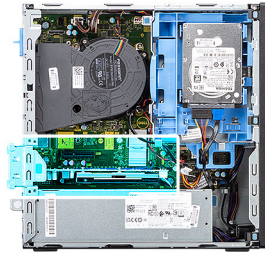

Steps

1. Lift the pull tab and open the expansion-card door.
2. Push and hold the securing tab on the graphics-card slot and lift the graphics card from the PCIe x16 card slot.

Installing the graphics card

Prerequisites

If you are replacing a component, remove the existing component before performing the installation procedure.

About this task

The following image indicates the location of the graphics card and provides a visual representation of the installation procedure.

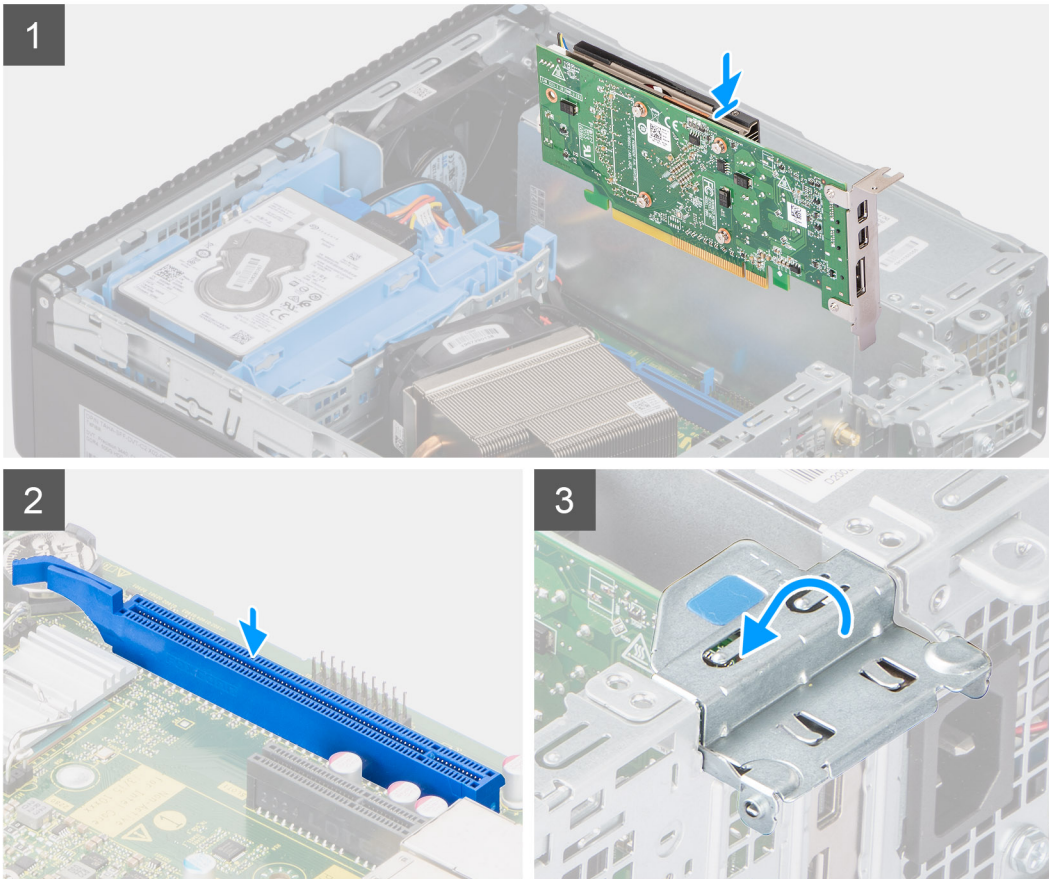
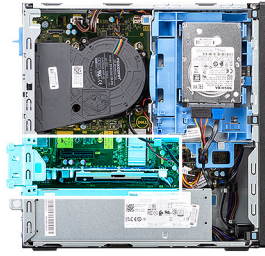

Steps

1. Align the graphics card with the PCIe x16 card slot on the system board.
2. Using the alignment post, connect the card in the connector and press down firmly. Ensure that the card is firmly seated.
3. Close the expansion-card door, and press until it clicks into place.

Next steps

1. Install the [side cover](#).
2. Follow the procedure in [after working inside your computer](#).

Optional I/O modules (Type C/ HDMI / DPI)

Removing optional I/O modules (Type-C/ HDMI/VGA/DP/Serial)

Prerequisites

1. Follow the procedure in [before working inside your computer](#).
2. Remove the [side cover](#).
3. Remove the [front bezel](#).

4. Remove the [fan assembly](#).

About this task

The following images indicate the location of the optional I/O Modules and provides a visual representation of the removal procedure.



2x
M2x3

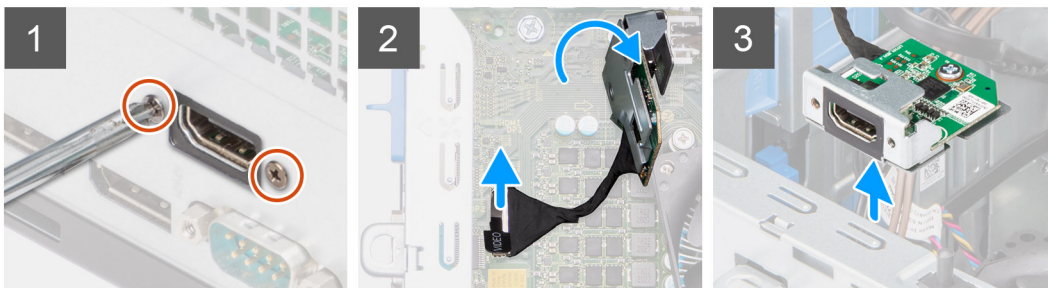

Steps

1. Remove the two (M2X3) screws that secure the optional I/O module to the computer chassis.
2. Disconnect the I/O-module cable from the connector on the system board.
3. Remove the I/O module from the computer.

Installing optional I/O modules (Type C/ HDMI/VGA/DP/Serial)

Prerequisites

If you are replacing a component, remove the existing component before performing the installation procedure.

About this task

The following images indicate the location of the system board and provide a visual representation of the installation procedure.



2x
M2x3

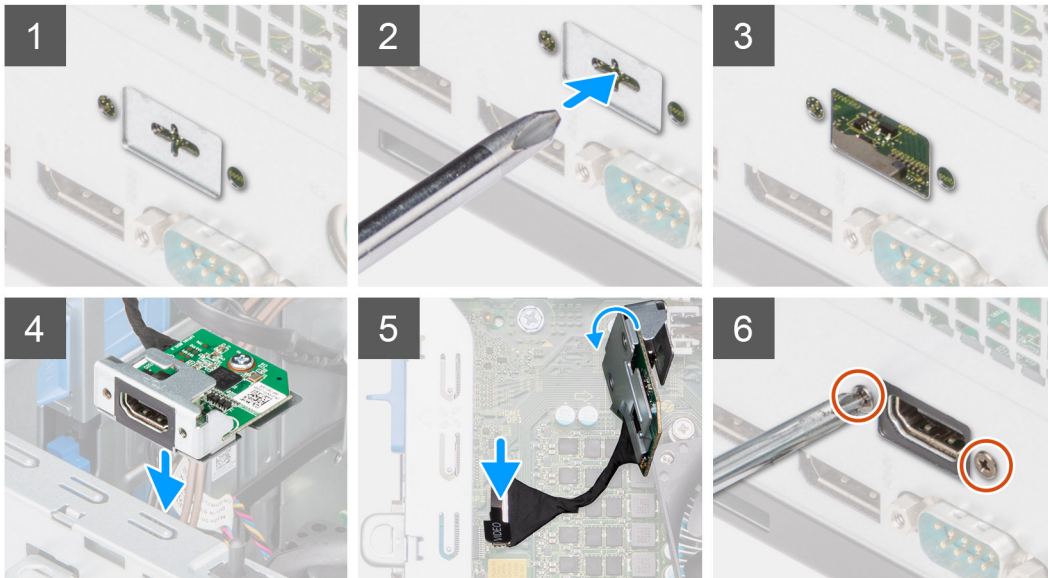

Steps

1. To remove the dummy metal bracket, insert a flat-head screwdriver in the hole of the bracket. Push the bracket to release the bracket, and then lift the bracket out from the system.
2. Insert the optional I/O module (Type-C/HDMI/VGA/DP/Serial) into its slot from the inside of your computer.
3. Connect the I/O cable to the connector on the system board.
4. Replace the two (M3X3) screws to secure the optional I/O module to the system.

Next steps

1. Install the [fan assembly](#).
2. Install the [side cover](#).
3. Follow the procedure in [after working inside your computer](#).

Coin-cell battery

Removing the coin-cell battery

Prerequisites

1. Follow the procedure in [before working inside your computer](#).
2. Remove the [side cover](#).
3. Remove the [graphics card](#).

i **NOTE:** Removing the coin-cell battery resets the BIOS setup program settings to default. It is recommended that you note the BIOS setup program settings before removing the coin-cell battery.

About this task

The following images indicate the location of the coin-cell battery and provide a visual representation of the removal procedure.

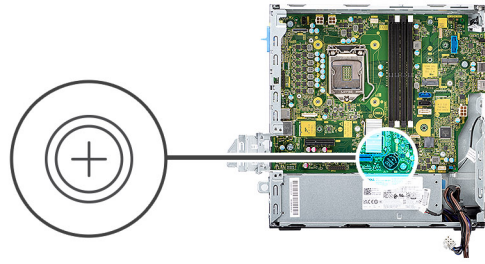

Steps

1. Using a plastic scribe, push the coin-cell battery securing-clip on the coin-cell battery socket to release the coin-cell battery out of the slot on the system board.
2. Lift the coin-cell battery off its slot on the system board.

Installing the coin-cell battery

Prerequisites

If you are replacing a component, remove the existing component before performing the installation procedure.

About this task

The following image indicates the location of the coin-cell battery and provides a visual representation of the installation procedure.

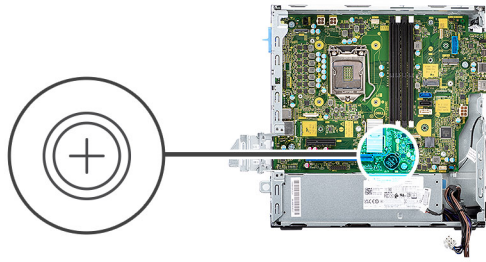

Steps

1. Insert the coin-cell battery into its slot on the system board with the positive side (+) label facing up.
2. Press down and snap the coin-cell battery into the slot on the system board.

Next steps

1. Install the [graphics card](#).
2. Install the [side cover](#).
3. Follow the procedure in [after working inside your computer](#).

Intrusion switch

Removing the intrusion switch

Prerequisites

1. Follow the procedure in [before working inside your computer](#).
2. Remove the [side cover](#).

About this task

The following image indicate the location of the intrusion switch and provide a visual representation of the removal procedure.

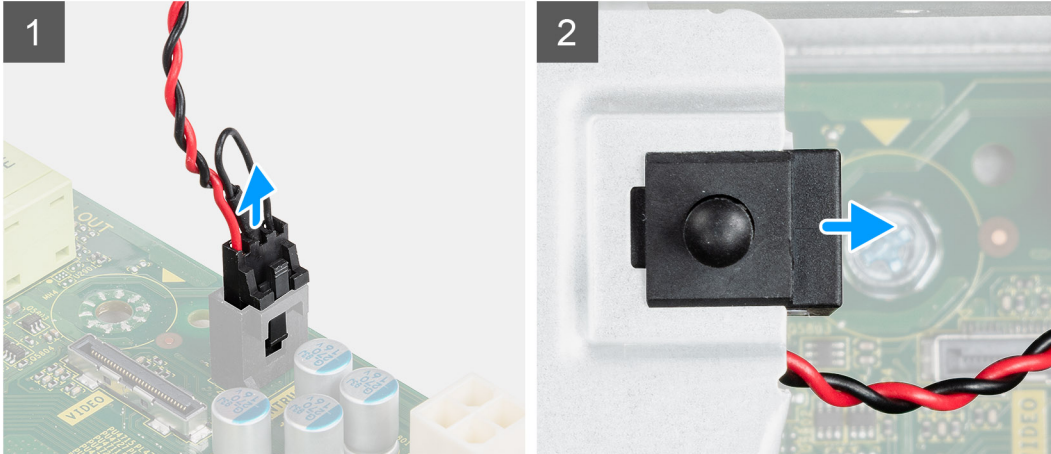

Steps

1. Press down on the latch on the intrusion switch cable and disconnect it from the connector on the system board.
2. Slide the intrusion switch and lift it away from the computer .

Installing the intrusion switch

Prerequisites

If you are replacing a component, remove the existing component before performing the installation procedure.

About this task

The following image indicates the location of the intrusion switch and provides a visual representation of the installation procedure.

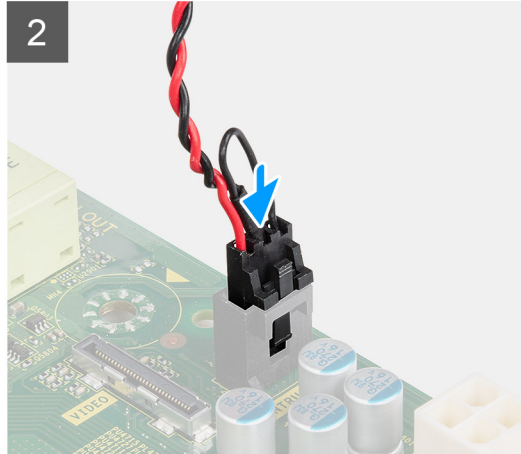
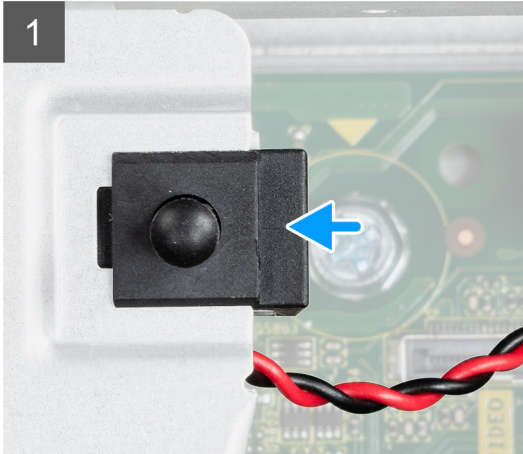

Steps

1. Slide the intrusion switch into the slot on the chassis.
2. Insert the connector from intrusion switch cable into the connector on the system board until it clicks into place.

Next steps

1. Install the [side cover](#).
2. Follow the procedure in [after working inside your computer](#).

Power-supply unit

Removing the power-supply unit

Prerequisites

1. Follow the procedure in [before working inside your computer](#).
2. Remove the [side cover](#).
3. Remove the [2.5-inch hard-drive assembly](#).
4. Remove the [hard-drive and optical-drive bracket](#).

About this task

The following images indicate the location of the power-supply unit and provide a visual representation of the removal procedure.



5x
6x32

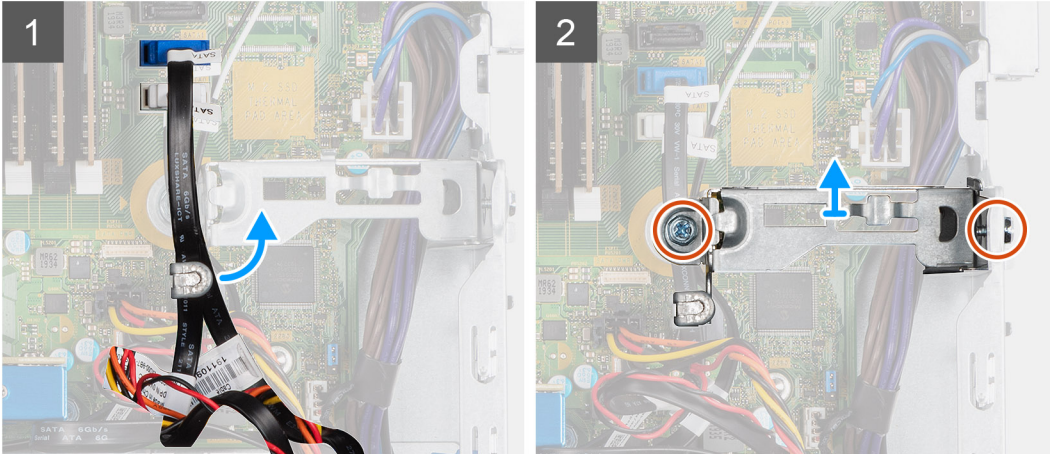
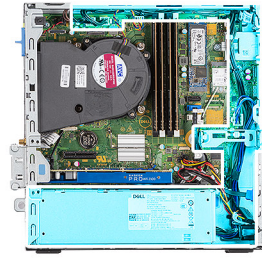



Steps

1. Remove the optical-drive SATA cables from the retention clip on the support bracket.
2. Remove the two screws (M6X32) and slide the support bracket out from the slot.
3. Disconnect and unroute the power-supply cable from the routing guides on the chassis.
4. Remove the three screws (M6X32) that secure the power-supply unit to the chassis.
5. Press down on the securing clip to release the power supply from the chassis.
6. Slide and lift the power supply from its slot on the chassis.

Installing the power-supply unit

Prerequisites

If you are replacing a component, remove the existing component before performing the installation procedure.

About this task

The following image indicates the location of the power-supply unit and provides a visual representation of the installation procedure.

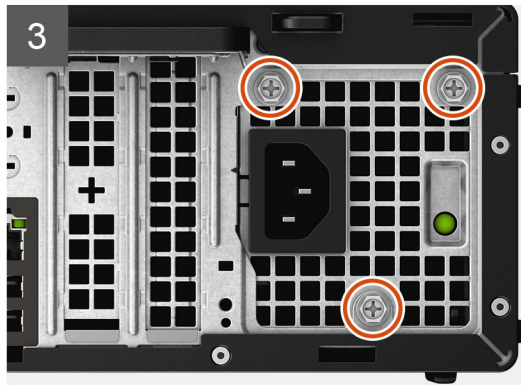
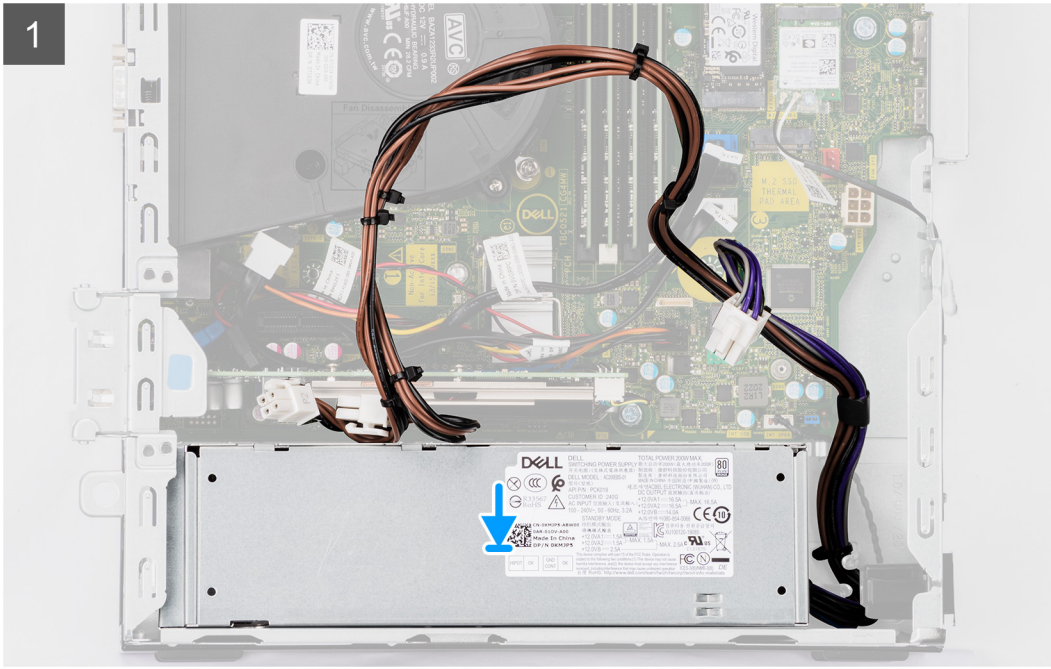



5x
6x32

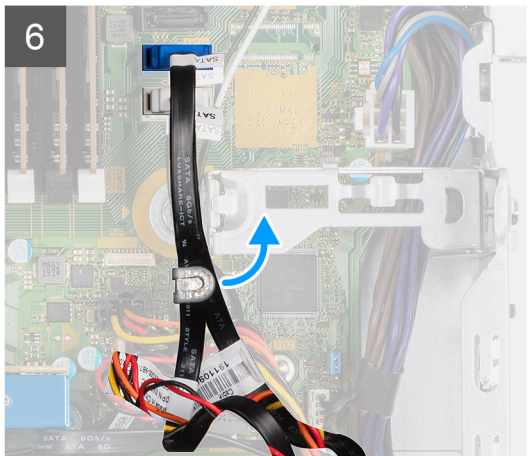
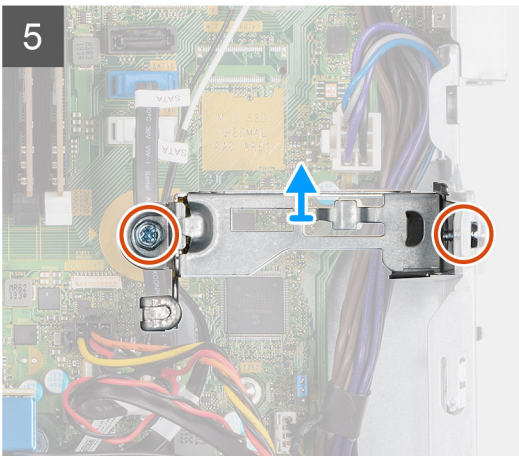

Steps

1. Align and place the power-supply unit into the slot on the chassis.
2. Slide the power-supply unit into the slot until it clicks in place.
3. Replace the three screws (M6X32) to secure the power-supply unit to the chassis.
4. Route the power-supply cables through routing guides and connect it to the connectors on the system board.
5. Place the support bracket into the slot and secure it with the two screws (M6X32).
6. Connect the optical-drive SATA cable through the retention clip on the support bracket.

Next steps

1. Install the [2.5-inch hard-drive assembly](#).
2. Install the [hard-drive and optical-drive bracket](#).
3. Install the [side cover](#).
4. Follow the procedure in [after working inside your computer](#).

Processor

Removing the processor

Prerequisites

1. Follow the procedure in [before working inside your computer](#).
2. Remove the [2.5/3.5-inch hard-drive caddy](#).
3. Remove the [side cover](#).
4. Remove the [fan and heat-sink assembly](#).

 **NOTE:** The processor may become hot during normal operation. Allow sufficient time for the heat sink to cool before you touch it.

 **CAUTION:** For maximum cooling of the processor, do not touch the heat transfer areas on the heat sink. The oils in your skin can reduce the heat transfer capability of the thermal grease.

About this task

The following images indicate the location of the processor and provide a visual representation of the removal procedure.

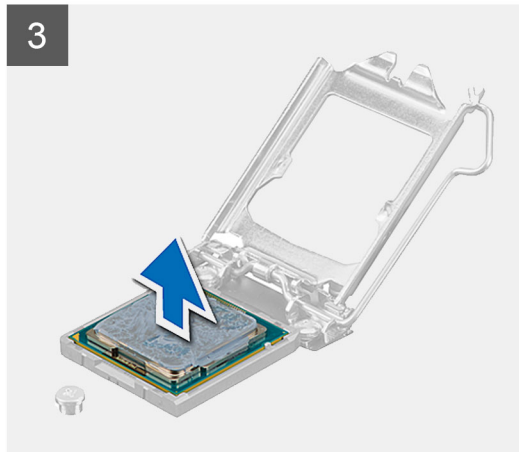
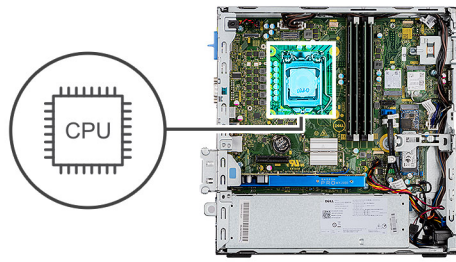

Steps

1. Press the release lever down and then push it away from the processor to release it from the securing tab.
2. Extend the release lever completely and open the processor cover.
3. Gently lift the processor from the processor socket on the system board.

 **CAUTION:** When removing the processor, do not touch any of the pins inside the socket or allow any objects to fall on the pins in the socket.

Installing the processor

Prerequisites

If you are replacing a component, remove the existing component before performing the installation procedure.

About this task

The following image indicates the location of the processor and provides a visual representation of the installation procedure.

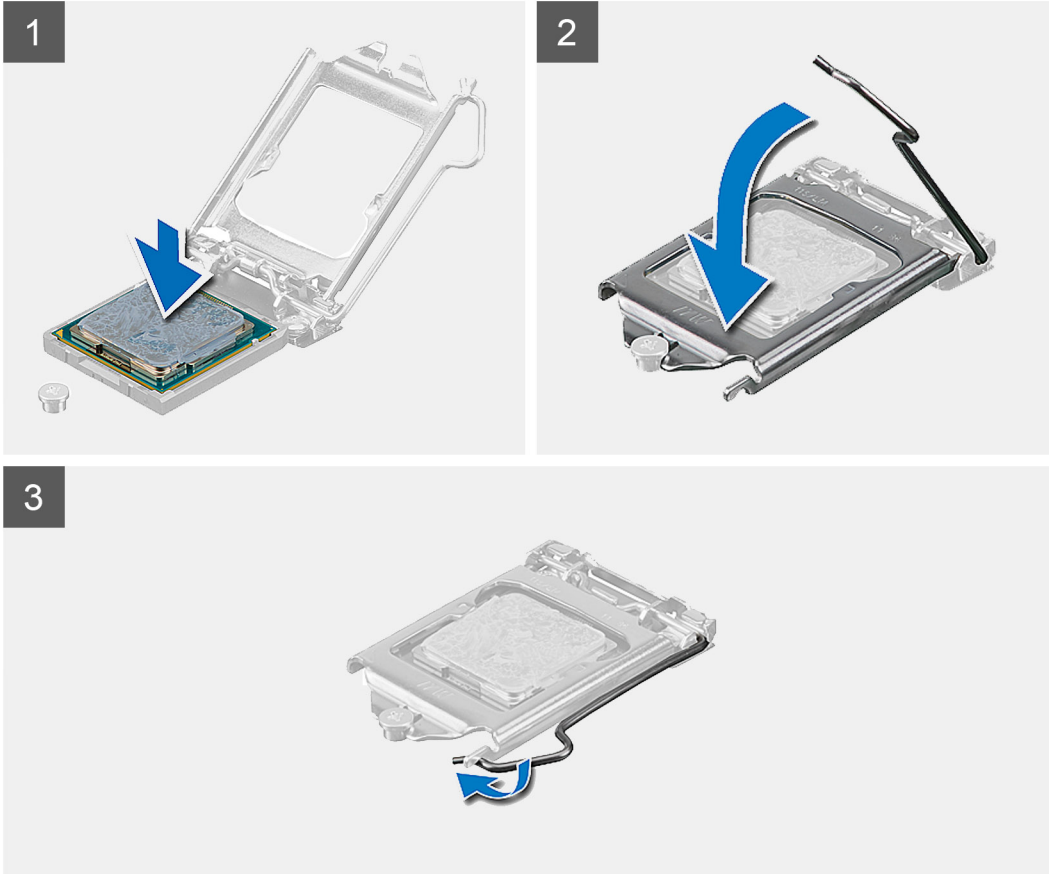
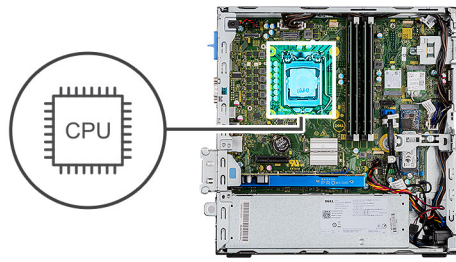

Steps

1. Ensure that the release lever on the processor socket is fully extended in the open position.
2. Align the notches on the processor with the tabs on the processor socket and place the processor in the processor socket on the system board.
 - i** **NOTE:** Ensure that the processor-cover notch is positioned underneath the alignment post.
 - i** **NOTE:** The pin-1 corner of the processor has a triangle that aligns with the triangle on the pin-1 corner on the processor socket. When the processor is properly seated, all four corners are aligned at the same height. If one or more corners of the processor are higher than the others, the processor is not seated properly.
3. When the processor is fully seated in the socket, pivot the release-lever down and place it under the tab on the processor cover.

Next steps

1. Install the [fan and heat-sink assembly](#).
2. Install the [2.5/3.5-inch hard-drive caddy](#).
3. Install the [side cover](#).
4. Follow the procedure in [after working inside your computer](#).

System board

System board callouts - 5090 Small Form Factor

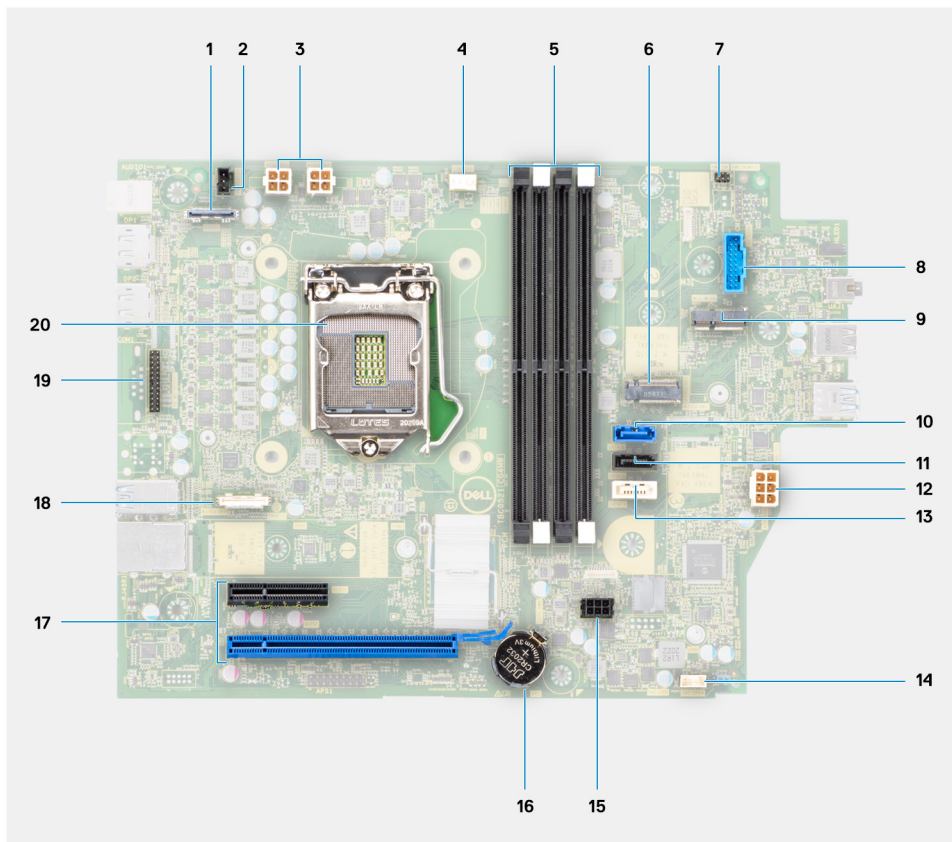

1. Video connector
2. Intrusion switch connector
3. ATX CPU power connector
4. Processor fan connector
5. Memory module connector
6. M.2 SSD PCIe connector
7. Power button connector
8. SD-card reader connector
9. M.2 WLAN connector
10. SATA 0 connector
11. SATA 1 connector
12. ATX system power connector
13. SATA 3 connector
14. SATA power connector
15. Internal speaker cable connector
16. Coin-cell battery
17. PCIe x16 (Slot2) and PCIe x4 (Slot1)
18. Type-C connector
19. PS/2 KB/Mouse Connector
20. Processor socket

Removing the system board

Prerequisites

1. Follow the procedure in [before working inside your computer](#).
2. Remove the [side cover](#).
3. Remove the [front bezel](#).
4. Remove the [2.5/3.5-inch hard-drive caddy](#).
5. Remove the [graphics card](#).
6. Remove the [solid-state drive](#).
7. Remove the [WLAN card](#).
8. Remove the [fan assembly](#).
9. Remove the [memory modules](#).
10. Remove the [processor](#).

About this task

The following images indicate the location of the system board and provide a visual representation of the removal procedure.

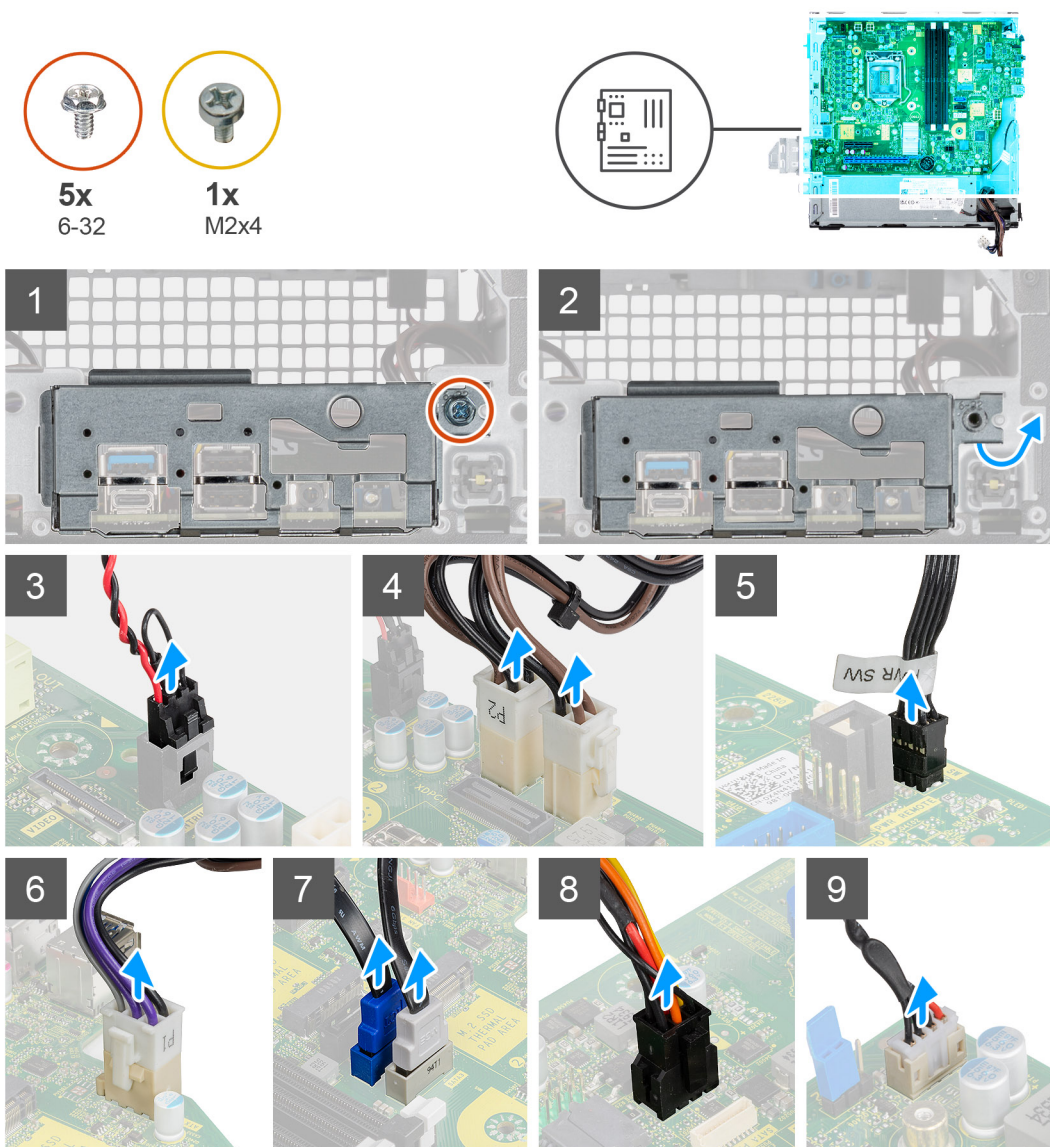

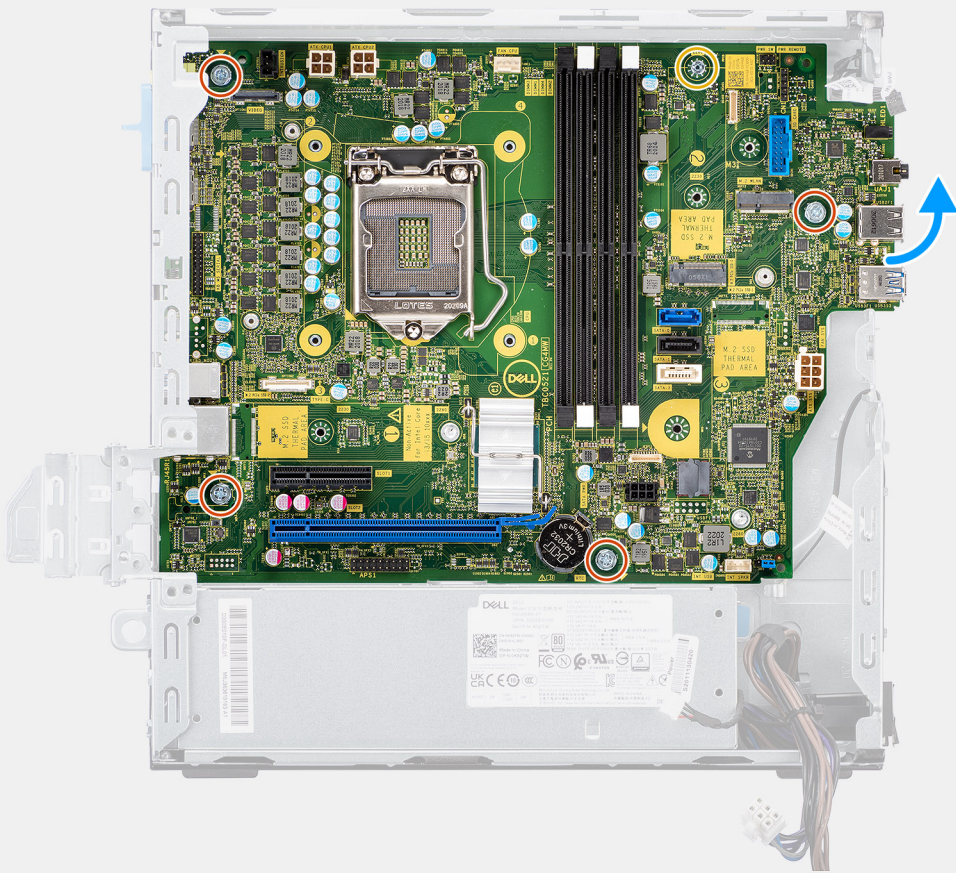

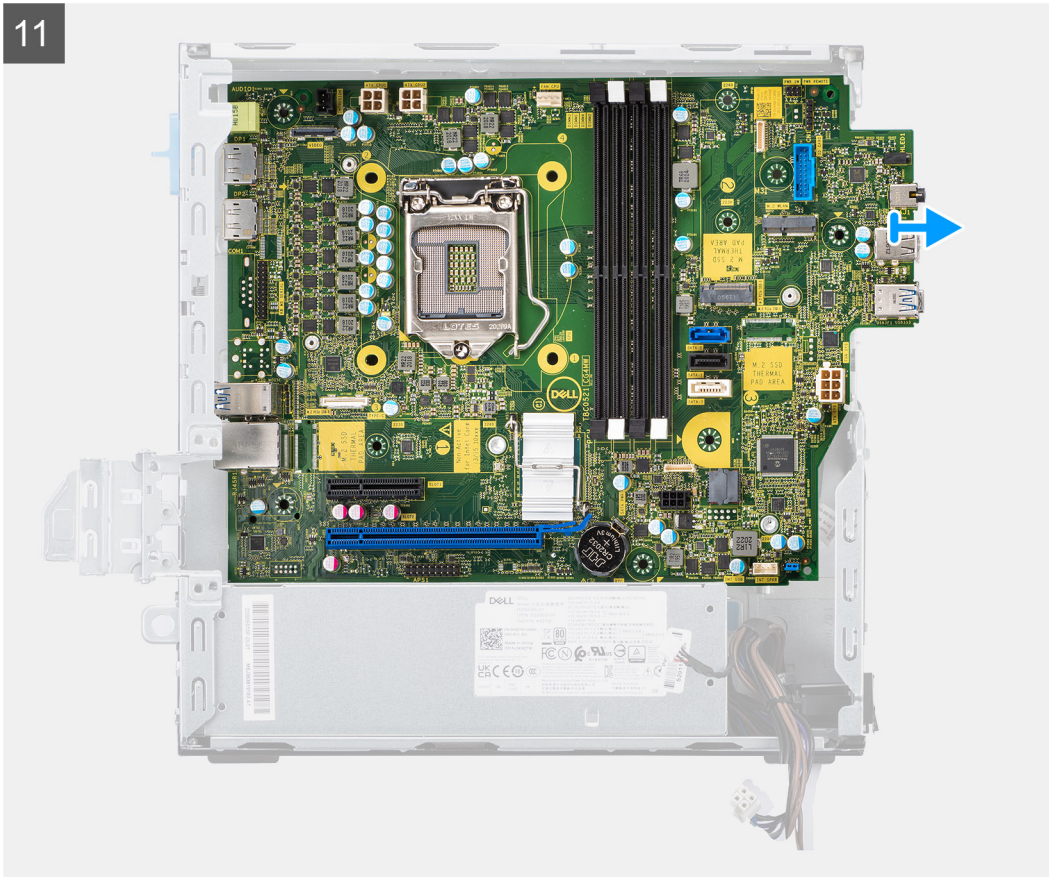

Steps

1. Remove the screw (6-32) that secures the front I/O bracket to the chassis.
2. Lift the front I/O panel away from the chassis.
3. Disconnect the following cables from their connectors on the system board:
 - Intrusion switch
 - ATX system board power supply cables
 - Power button switch
 - ATX CPU power supply cable
 - SATA data cables
 - SATA power cable
 - Fan cable
4. Remove the four screws (6-32) and the single standoff screw (M2x4) which secure the system board to the chassis.
5. Free the system board from the back I/O panel by sliding it towards the right and lift the system board out of the chassis.

Installing the system board

Prerequisites

If you are replacing a component, remove the existing component before performing the installation procedure.

About this task

The following image indicates the location of the system board and provides a visual representation of the installation procedure.

1

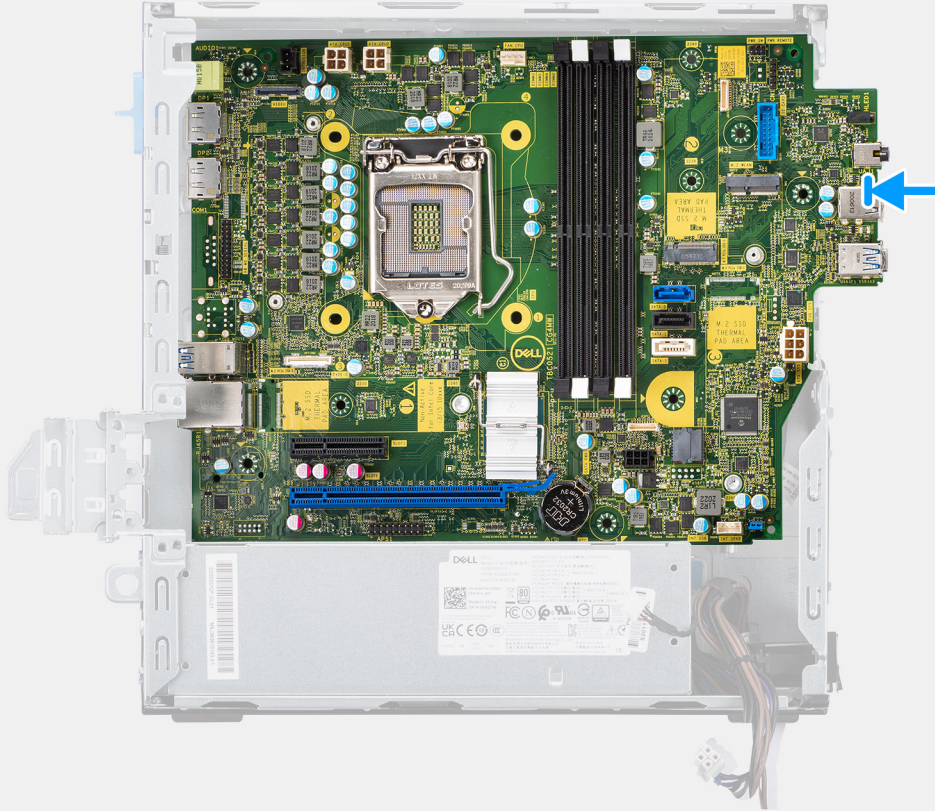

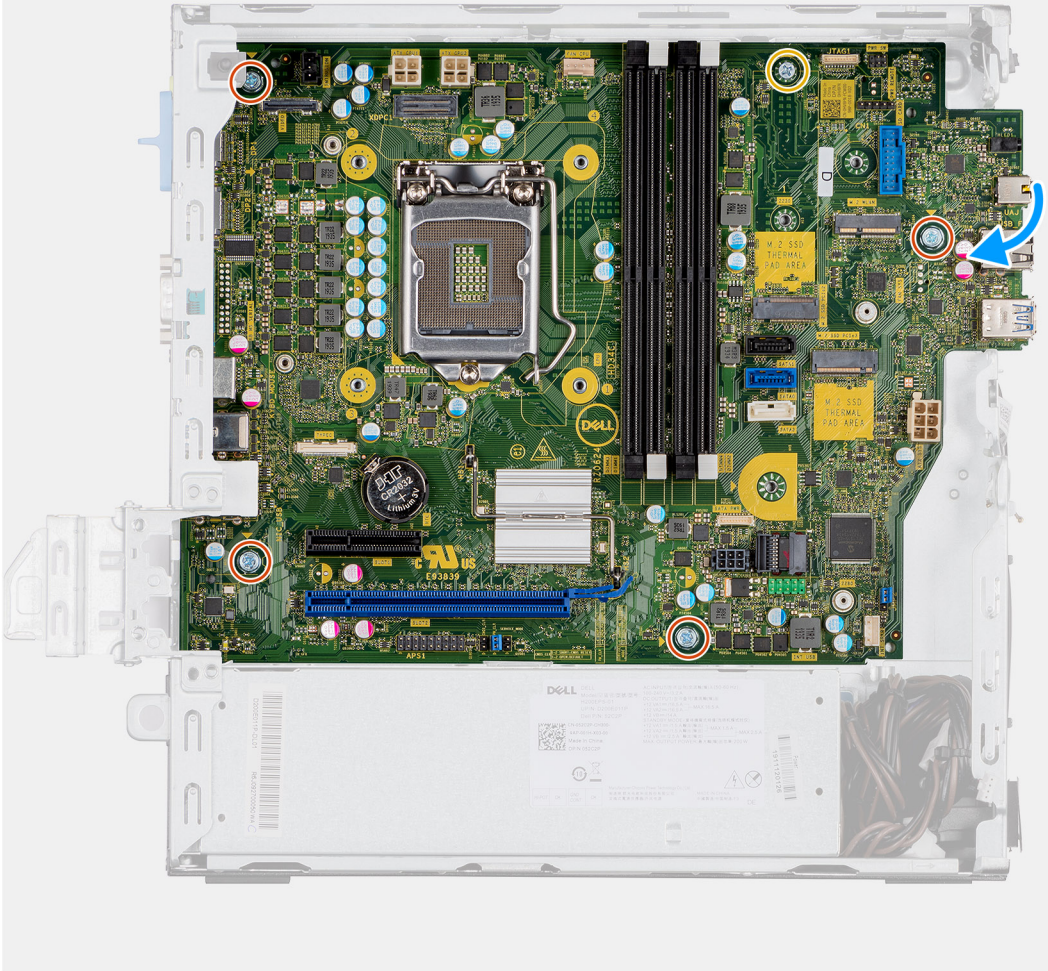

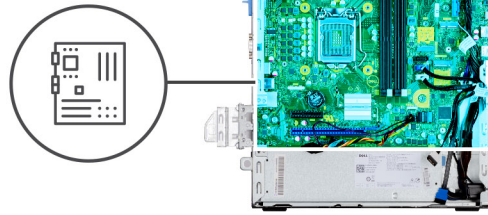
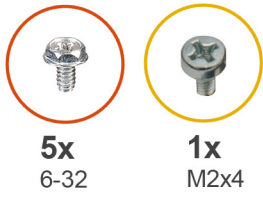

Steps

1. Align and lower the system board into the system until the stand-off points at the back of the system board align with those on the chassis.
2. Replace the four screws (6-32) and the single standoff screw (M2X4) screw to secure the system board to the chassis.
3. Connect the following cables to the respective connectors on the system board:
 - Intrusion switch
 - ATX system board power supply cables
 - Power button switch
 - ATX CPU power supply cable
 - SATA data cables
 - SATA power cable
 - System fan cable
4. Align and lower the I/O panel into the slot on the chassis.
5. Replace the screws (6-32) to secure the I/O panel to the chassis.

Next steps

1. Install the [processor](#).
2. Install the [fan assembly](#).
3. Install the [WLAN card](#).

4. Install the [solid-state drive](#).
5. Install the [memory modules](#).
6. Install the [graphics card](#).
7. Install the [2.5/3.5-inch hard-drive caddy](#).
8. Install the [side cover](#).
9. Follow the procedure in [after working inside your computer](#).

Software

This chapter details the supported operating systems along with instructions on how to install the drivers.

Drivers and downloads

When troubleshooting, downloading or installing drivers it is recommended that you read the Dell Knowledge Based article, Drivers and Downloads FAQ [000123347](#).

System setup

CAUTION: Unless you are an expert computer user, do not change the settings in the BIOS Setup program. Certain changes can make your computer work incorrectly.

NOTE: Before you change BIOS Setup program, it is recommended that you write down the BIOS Setup program screen information for future reference.

Use the BIOS Setup program for the following purposes:

- Get information about the hardware installed in your computer, such as the amount of RAM and the size of the hard drive.
- Change the system configuration information.
- Set or change a user-selectable option, such as the user password, type of hard drive installed, and enabling or disabling base devices.

Boot menu

Press <F12> when the Dell logo appears to initiate a one-time boot menu with a list of the valid boot devices for the system. Diagnostics and BIOS Setup options are also included in this menu. The devices listed on the boot menu depend on the bootable devices in the system. This menu is useful when you are attempting to boot to a particular device or to bring up the diagnostics for the system. Using the boot menu does not make any changes to the boot order stored in the BIOS.

The options are:

- UEFI Boot:
 - Windows Boot Manager
- Other Options:
 - BIOS Setup
 - BIOS Flash Update
 - Diagnostics
 - Change Boot Mode Settings

Navigation keys

NOTE: For most of the System Setup options, changes that you make are recorded but do not take effect until you restart the system.

Keys	Navigation
Up arrow	Moves to the previous field.
Down arrow	Moves to the next field.
Enter	Selects a value in the selected field (if applicable) or follow the link in the field.
Spacebar	Expands or collapses a drop-down list, if applicable.
Tab	Moves to the next focus area.
Esc	Moves to the previous page until you view the main screen. Pressing Esc in the main screen displays a message that prompts you to save any unsaved changes and restarts the system.

Boot Sequence

Boot sequence enables you to bypass the System Setup–defined boot device order and boot directly to a specific device (for example: optical drive or hard drive). During the Power-on Self-Test (POST), when the Dell logo appears, you can:

- Access System Setup by pressing F2 key
- Bring up the one-time boot menu by pressing F12 key.

The one-time boot menu displays the devices that you can boot from including the diagnostic option. The boot menu options are:

- Removable Drive (if available)
- STXXXX Drive
 - NOTE:** XXXX denotes the SATA drive number.
- Optical Drive (if available)
- SATA Hard Drive (if available)
- Diagnostics
 - NOTE:** Choosing **Diagnostics**, displays the **SupportAssist** screen.

The boot sequence screen also displays the option to access the System Setup screen.

System setup options

NOTE: Depending on this computer and its installed devices, the items listed in this section may or may not appear.

Table 3. System setup options—System information menu

General-System Information	
System Information	
BIOS Version	Displays the BIOS version number.
Service Tag	Displays the Service Tag of the computer.
Asset Tag	Displays the Asset Tag of the computer.
Ownership Tag	Displays the ownership tag of the computer.
Manufacture Date	Displays the manufacture date of the computer.
Ownership Date	Displays the ownership date of the computer.
Express Service Code	Displays the express service code of the computer.
Memory Information	
Memory Installed	Displays the total computer memory installed.
Memory Available	Displays the total computer memory available.
Memory Speed	Displays the memory speed.
Memory Channel Mode	Displays single or dual channel mode.
Memory Technology	Displays the technology used for the memory.
DIMM 1 Size	Displays the DIMM 1 memory size.
DIMM 2 Size	Displays the DIMM 2 memory size.
PCI Information	
SLOT2	Displays the PCI information of the computer.
SLOT3	Displays the PCI information of the computer.
SLOT5_M.2	Displays the PCI information of the computer.
Processor Information	

Table 3. System setup options—System information menu (continued)

General-System Information	
Processor Type	Displays the processor type.
Core Count	Displays the number of cores on the processor.
Processor ID	Displays the processor identification code.
Current Clock Speed	Displays the current processor clock speed.
Minimum Clock Speed	Displays the minimum processor clock speed.
Maximum Clock Speed	Displays the maximum processor clock speed.
Processor L2 Cache	Displays the Processor L2 Cache size.
Processor L3 Cache	Displays the Processor L2 Cache size.
HT Capable	Displays whether the processor is HyperThreading (HT) capable.
64-Bit Technology	Displays whether 64-bit technology is used.
Device Information	
SATA-0	Displays the SATA device information of the computer.
SATA-1	Displays the SATA device information of the computer.
M.2 PCIe SSD-2	Displays the M.2 PCIe SSD information of the computer.
LOM MAC Address	Displays the LOM MAC address of the computer.
Video Controller	Displays the video controller type of the computer.
Audio Controller	Displays the audio controller information of the computer.
Wi-Fi Device	Displays the wireless device information of the computer.
Bluetooth Device	Displays the Bluetooth device information of the computer.
Boot Sequence	
Boot Sequence	Displays the boot sequence.
Boot List Option	Displays the available boot options.
UEFI Boot Path Security	
Always,Except Internal HDD	Enable or disable the system to prompt the user to enter the Admin password when booting a UEFI boot path from the F12 boot menu. Default: Enabled
Always	Enable or disable the system to prompt the user to enter the Admin password when booting a UEFI boot path from the F12 boot menu. Default: Disabled
Never	Enable or disable the system to prompt the user to enter the Admin password when booting a UEFI boot path from the F12 boot menu. Default: Disabled
Date/Time	Displays the current date in MM/DD/YY format and current time in HH:MM:SS AM/PM format.

Table 4. System setup options—System Configuration menu

System Configuration	
Integrated NIC	
Enable UEFI Network Stack	Enable or disable UEFI Network Stack.
SATA Operation	
Configure operating mode of the integrated SATA hard drive controller.	
Drives	
Enable or disable various drives on board.	
SATA-0	Displays the SATA device information of the computer.
SATA-1	Displays the SATA device information of the computer.
M.2 PCIe SSD-2	Displays the M.2 PCIe SSD information of the computer.

Table 4. System setup options—System Configuration menu (continued)

System Configuration	
SMART Reporting	Enable or disable SMART Reporting during system startup.
USB Configuration	
Enable USB Boot Support	Enable or disable booting from USB mass storage devices such as external hard drive, optical drive, and USB drive.
Enable front USB Port	Enable or disable the front USB ports.
Enable rear USB Port	Enable or disable the rear USB ports.
Front USB Configuration	Enable or disable the front USB ports.
Rear USB Configuration	Enable or disable the rear USB ports.
Audio	Enable or disable the integrated audio controller.
Miscellaneous Devices	Enable or disable various onboard devices.

Table 5. System setup options—Video menu

Video	
Multi-Display	Enable or disable multiple displays.
Primary Display	Set or change the primary display.

Table 6. System setup options—Security menu

Security	
Admin Password	Set, change, or delete the administrator password.
System Password	Set, change, or delete the system password.
Internal HDD-0 Password	Set, change, or delete the internal hard-disk drive password.
Password Configuration	Control the minimum and maximum number of characters allowed for Admin and System passwords.
Password Change	Enable or disable changes to the System and Hard Disk passwords when an administrator password is set.
UEFI Capsule Firmware Updates	Enable or disable BIOS updates through UEFI capsule update packages.
PTT Security	
PTT On	Enable or disable Platform Trust Technology (PTT) visibility to the operating system.
Clear	Default: Disabled
PPI ByPass for Clear Command	Enable or disable the TPM Physical Presence Interface (PPI). When enabled, this setting will allow the OS to skip BIOS PPI user prompts when issuing the Clear command. Changes to this setting take effect immediately. Default: Disabled
Absolute(R)	Enable or disable the BIOS module interface of the optional Computrace(R) Service from Absolute Software.
Admin Setup Lockout	Enable to prevent users from entering Setup when an Admin Password is set.
Master Password Lockout	Disables the master password support. Hard Disk passwords need to be cleared before changing the setting.
SMM Security Mitigation	Enable or disable SMM Security Mitigation

Table 7. System setup options—Secure Boot menu

Secure Boot	
Secure Boot Enable	Enable or disable the secure boot feature.

Table 7. System setup options—Secure Boot menu (continued)

Secure Boot	
Secure Boot Mode	Modifies the behavior of Secure Boot to allow evaluation or enforcement of UEFI driver signatures. <ul style="list-style-type: none"> • Deployed Mode-Default: Enabled • Audit Mode-Default: Disabled
Deployed Mode	Enable or disable the deployed mode.
Audit Mode	Enable or disable the audit mode.
Expert Key Management	
Expert Key Management	Enable or disable Expert Key Management.
Custom Mode Key Management	Select the custom values for expert key management.

Table 8. System setup options—Intel Software Guard Extensions menu

Intel Software Guard Extensions	
Intel SGX Enable	Enable or disable Intel Software Guard Extensions.
Enclave Memory Size	Set the Intel Software Guard Extensions Enclave Reserve Memory Size.
Performance	
Multi Core Support	Enable multiple cores. Default: Enabled.
Intel SpeedStep	Enable or disable Intel Speedstep Technology. Default: Enabled. NOTE: If enabled, the processor clock speed and core voltage are adjusted dynamically based on the processor load.
C-States Control	Enable or disable additional processor sleep states. Default: Enabled.
Intel TurboBoost	Enable or disable Intel TurboBoost mode of the processor. Default: Enabled.
HyperThread control	Enable or disable HyperThreading in the processor. Default: Enabled.
Power Management	
AC Recovery	Sets what action the computer takes when power is restored.
Enable Intel Speed Shift Technology	Enable or disable Intel Speed Shift Technology.
Auto On Time	Enable to set the computer to turn on automatically every day or on a preselected date and time. This option can be configured only if the Auto On Time is set to Everyday, Weekdays or Selected Days. Default: Disabled.
USB Wake Support	Enable the USB devices to wake the computer from Standby.
Deep Sleep Control	Enables you to control the Deep Sleep mode support.
Wake on LAN/WLAN	Enables the computer to be powered on by special LAN signals.
Block sleep	Enables you to block entering to sleep mode in OS environment.
POST Behavior	
Numlock LED	Enables the NumLock function when computer boots.

Table 8. System setup options—Intel Software Guard Extensions menu (continued)

Intel Software Guard Extensions	
Keyboard Errors	Enables the keyboard error detection.
Fastboot	Enable to set the speed of the boot process. Default: Thorough.
Extend BIOS POST Time	Configure additional pre-boot delay.
Full Screen Logo	Enable or disable to display full screen logo.
Warnings and Errors	Sets the boot process to pause when Warnings or Errors are detected.

Table 9. System setup options—Virtualization Support menu

Virtualization Support	
Virtualization	Specify whether a Virtual Machine Monitor (VMM) can utilize the additional hardware capabilities provided by Intel Virtualization Technology.
VT for Direct I/O	Specify whether a Virtual Machine Monitor (VMM) can utilize the additional hardware capabilities provided by Intel Virtualization Technology for Direct I/O.

Table 10. System setup options—Wireless menu

Wireless	
Wireless Device Enable	Enable or disable internal wireless devices.

Table 11. System setup options—Maintenance menu

Maintenance	
Service Tag	Display the system's Service Tag.
Asset Tag	Create a system Asset Tag.
SERR Messages	Enable or disable SERR messages.
BIOS Downgrade	Control flashing of the system firmware to previous revisions.
Data Wipe	Enable to securely erase data from all internal storage devices.
BIOS Recovery	Enable the user to recover from certain corrupted BIOS conditions from a recovery file on the user primary hard drive or an external USB key.

Table 12. System setup options—System Logs menu

System Logs	
BIOS Events	Display BIOS events.

Table 13. System setup options—SupportAssist System Resolution menu

SupportAssist System Resolution	
Auto OS Recovery Threshold	Control the automatic boot flow for SupportAssist System Resolution Console and for Dell OS Recovery tool.

Overview

This section provides hardware specification for the system and contains no modifiable settings.

Table 14. BIOS Overview Page

Options	Description
Series and system model number	This field shows the following information:

Table 14. BIOS Overview Page (continued)

Options	Description
	<ul style="list-style-type: none"> ● BIOS Version - The version of the BIOS installed on the computer. ● Service tag - The unique 7 digit hexadecimal identification number for the computer. ● Asset tag ● Manufacture Date - The date for when the unit was manufactured. ● Ownership Date - The date for when the unit's ownership was transferred to the end user. ● Express Service Code - An alternative to Service Tag, 11-digit numerical identification number for the computer. ● Ownership Tag ● Signed Firmware Update - This helps to verify that only Dell Signed and released BIOS can be installed on the computer.
Processor	<p>The Processor field provides information related to the CPU on the computer:</p> <ul style="list-style-type: none"> ● Processor Type - This field mentions the CPU model and generation information. ● Maximum Clock Speed - This field mentions the maximum clock speed that the CPU is capable of reaching. ● Minimum Clock Speed - This field mentions the minimum clock speed that the CPU is capable of reaching. ● Current Clock Speed - This field mentions the clock speed that the CPU is running at currently. ● Core Count - This field gives the count of the physical cores on the CPU. ● Processor ID ● Processor L3 Cache - This field shows the amount of cache storage available on the CPU. ● Microcode Version ● Intel Hyper-Threading Capable - This field helps identify if the CPU is capable of Hyper-Threading. ● 64-bit Technology - This field helps identify the CPU architecture.
Memory	<p>The Memory field provides information related to the memory on the computer:</p> <ul style="list-style-type: none"> ● Memory Installed - This field gives the amount of memory installed on the computer. ● Memory Available - This field gives the amount of memory available for use on the computer. ● Memory Speed - This field mentions the speed at which the memory runs on the computer. ● Memory Channel Mode - This field helps us identify if the computer has Dual-Channel memory utilization capability. ● DIMM_SLOT 1 - This field shows the capacity of the memory installed in the first DIMM slot. ● DIMM_SLOT 2 - This field shows the capacity of the memory installed in the second DIMM slot.
Devices	<p>The Devices field provides information related to the memory on the computer:</p> <ul style="list-style-type: none"> ● Panel Type - This field mentions the type of display panel used on the computer.

Table 14. BIOS Overview Page (continued)

Options	Description
	<ul style="list-style-type: none"> ● Video controller - This field mentions the type of video controller used on the computer. ● Video Memory - This field gives the capacity of the video memory available for use on the computer. ● Wi-Fi Device - This field mentions the type of wireless device available for use on the computer. ● Native Resolution - This field mentions the native video resolution supported on the computer. ● Video BIOS Version - The version of the BIOS installed on the computer. ● Audio Controller - This field mentions the type of audio controller used on the computer. ● Bluetooth Device - This field mentions the type of Bluetooth device available for use on the computer. ● LOM MAC Address - This field provides the unique MAC address for the computer.

Boot Configuration

This section provides Boot Configuration related details and settings.

Table 15. Boot Configuration:

Options	Description
Boot Sequence	
Boot Mode: UEFI only	<p>This section allows the user to choose the first bootable device that the computer should use to boot the system. It lists all potential bootable devices.</p> <ul style="list-style-type: none"> ● Windows Boot Manager (Enabled by default) ● UEFI Boot Drive (Enabled by default) ● Add Boot option - Allows the user to manually add a Boot path.
Secure Digital(SD) Card Boot	<p>This section contains a toggle switch that allows the user to enable or disable the option to allow the computer to boot from an SD Card.</p>
Secure Boot	
Enable Secure Boot	<p>This section contains a toggle switch that allows the user to enable or disable Secure Boot. (OFF by default)</p>
Secure Boot Mode	<p>This section allows the user to select one of the two Secure Boot options available on the computer:</p> <ul style="list-style-type: none"> ● Deployed Mode - This mode checks the integrity of UEFI drivers and bootloaders before allowing execution. This option allows for full Secure Boot protections (Enabled by default.) ● Audit Mode - This mode performs a signature check but never does a block execution of all UEFI drivers and bootloaders. This mode is only used when making changes to Secure Boot Keys.
Expert Key Management	

Table 15. Boot Configuration: (continued)

Options	Description
Enable Custom Mode	This section contains a toggle switch that allows the user to enable or disable Custom Mode. This mode allows the PK, KEK, db and dbx security key databases to be manipulated. (OFF by default)
Custom Mode Key Management	This section helps the user to select the Key Database to allow modification. The options available are as below: <ul style="list-style-type: none"> ● PK (Selected by default) ● KEK ● db ● dbx

Integrated Devices

This section provides Integrated Devices details and settings.

Table 16. Integrated Devices

Options	Description
Date/Time	
Date	This section allows the user to change the date which takes effect immediately. The format used is MM/DD/YYYY.
Time	This section allows the user to change the time which takes effect immediately. The format used is HH/MM/SS in 24 hour format. The user also has an option to switch between 12-hours or 24-hours clock.
Audio	
Enable Audio	This section contains a toggle switch that allows the user to enable or disable the audio on the computer. It also allows the user to: <ul style="list-style-type: none"> ● Enable Microphone (Enabled by default.)
Serial Port	This section allows the user to set the Serial Port Configuration: <ul style="list-style-type: none"> ● Disabled ● COM1: Port is configured at 3F8h with IRQ4 (Selected by default) ● COM2: Port is configured at F28h with IRQ3 ● COM3: Port is configured with 2E8h with IRQ4
USB Configuration	This section helps the user to make changes to the USB settings on the computer. The options available are as follows(All options are enabled by default): <ul style="list-style-type: none"> ● Enable Front USB Ports ● Enable Rear USB Ports ● Enable USB Boot Support
Front USB Configuration	This section allows the user to manually enable the 4 USB ports on the front bezel (All USB ports are enabled by default.). The options are: <ul style="list-style-type: none"> ● Front Port 1 (Bottom Left) ● Front Port 2 (Bottom Right)

Table 16. Integrated Devices (continued)

Options	Description
	<ul style="list-style-type: none"> ● Front Port 3 (Top Left) ● Front Port 4 (Top Right)
Rear USB Configuration	<p>This section allows the user to manually enable the 4 USB ports on the back (All USB ports are enabled by default.). The options are:</p> <ul style="list-style-type: none"> ● Rear Port 1 (Top Left) ● Rear Port 2 (Left Middle) ● Rear Port 3 (Bottom Left) ● Rear Port 4 (Bottom Right) ● Rear Port 4 (Middle Right) ● Rear Port 4 (Top Right)
Dust Filter Maintenance	<p>This field enabled or disabled BIOS messages for maintaining the optional dust filter. BIOS will generate a pre-boot reminder to clean or replace the dust filter based on the following time intervals:</p> <ul style="list-style-type: none"> ● Disabled (selected by default) ● 15 days ● 30 days ● 60 days ● 90 days ● 120 days ● 150 days ● 180 days

Storage

This section provides storage details and settings.

Table 17. Storage

Options	Description
SATA Operation	
SATA Operation	<p>This section allows the user to select the operating mode of the integrated SATA hard drive controller. The following options are available:</p> <ul style="list-style-type: none"> ● Disabled - SATA controllers are disabled. ● AHCI - SATA is configured in AHCI mode. ● RAID On - SATA is setup to support RAID (Intel Rapid Storage Technology). (Selected by default)
Storage Interface	
Port Enablement	<p>This section allows the user to enable or disable the onboard drives on the computer. The following options is available (ON by default).</p> <ul style="list-style-type: none"> ● SATA-0 ● SATA-1 ● SATA-3 ● M.2 PCIe SSD-0 ● M.2 PCIe SSD-1
SMART Reporting	

Table 17. Storage (continued)

Options	Description
Enable SMART Reporting	This section contains a toggle switch that allows the user to enable or disable the S.M.A.R.T.(Self-Monitoring, Analysis, and Reporting Technology) option on the system (OFF by default).
Drive Information	This section provides information about the connected and active drives on the computer. The following options are available: <ul style="list-style-type: none"> • M.2 PCIe SSD-0 <ul style="list-style-type: none"> ○ Type ○ Device
Enable MediaCard	This section allows setting the media cards ON/OFF or enable/disable media card in read-only state. The following options are available: <ul style="list-style-type: none"> • Secure Digital (SD) Card (Enabled by default) • Secure Digital (SD) Card Read-Only Mode

Display

This section provides display details and settings.

Table 18. Display

Options	Description
Multi-Display	This section contains a toggle switch which allows the user to enable/disable Multi-Display. (disabled by default). This feature is only supported on Windows 7 and above.
Primary Display	
Video Primary Display	This section allows the user to select the video controller for the primary display when multiple video controllers are detected. The options are: <ul style="list-style-type: none"> • Auto (Selected by default) • Onboard Video
Full Screen Logo	
Full Screen Logo	This section contains a toggle switch which allows the user to enable/disable the option to view a full screen logo (disabled by default).

Connection

This section provides connection details and settings.

Table 19. Connection

Options	Description
Network Controller Configuration	
Integrated NIC	This section allows the user to change the on-board LAN controller options. The options are as follows:

Table 19. Connection (continued)

Options	Description
	<ul style="list-style-type: none"> • Disabled - The internal LAN is off and not visible to the operating system. • Enabled - The internal LAN is enabled. • Enabled with PXE (Selected by default) - The internal LAN is enabled with PXE boot capabilities.
Wireless Device Enable	<p>This section contains a toggle switch that allows the user to enable or disable WLAN and Bluetooth on the computer. The options are as follows:</p> <ul style="list-style-type: none"> • WLAN (Enabled by default). • Bluetooth (Enabled by default).
Enable UEFI Network Stack	<p>This section contains a toggle switch that allows the user to enable or disable installation of UEFI networking protocols. (ON by default)</p>
Wireless Radio Control	<p>This section contains a toggle switch that allows the user to enable or disable a feature where the system will sense a connection to a wired network and disable the WLAN or WWAN connection (OFF by default).</p>
HTTP(s) Boot Feature	
HTTP(s) Boot Feature	<p>This section contains a toggle switch that allows the user to enable or disable HTTP(s) Boot capabilities (ON by default).</p>
HTTP(s) Boot Modes	<ul style="list-style-type: none"> • Auto Mode - HTTP(s) Boot automatically extracts Boot URL from DHCP(Dynamic Host Configuration Protocol) - Selected by default. • Manual Mode - HTTP(s) Boot reads Boot URL provided by the user. <p>This section also contains an "Upload" and "Delete" option for provisioning of the certificates required to connect to HTTPs Boot server.</p>

Power

This section provides power details and settings.

Table 20. Power

Options	Description
USB Wake Support	
Enable USB Wake Support	<p>This section contains a toggle switch to allow the user to enable or disable USB Wake Support. It allows the system to use USB devices like a mouse and keyboard to wake the system from standby mode (OFF by default).</p> <p>NOTE: This feature only works if the power adapter is connected to the system.</p>
AC Behavior	<p>This section allows the user to control the behavior of the system when power is restored after an unexpected loss of power. The options here are:</p> <ul style="list-style-type: none"> • Power Off - System stays off after AC power is restored (Selected by default)

Table 20. Power (continued)

Options	Description
	<ul style="list-style-type: none"> • Power On - System powers on after AC power is restored • Last Power State - System returns to the previous state after AC power recovery
Active State Power Management (ASPM)	<p>This section allows the user to set the ASPM level. The options here are:</p> <ul style="list-style-type: none"> • Auto - There is handshaking between the device and PCI Express hub (Selected by default) • Disabled - ASPM power management is turned off at all times • L1 Only - ASPM power management is set to level 1
Block Sleep	<p>This section determines how aggressively the system is conserving power while in Shutdown (S5) or Hiernate (S4) mode. The options are:</p> <ul style="list-style-type: none"> • Disabled • Enabled in S5 only • Enabled in S4 and S5 (Selected by default)
Intel Speed Shift Technology	
Intel Speed Shift Technology	<p>This section contains a toggle switch to allow the user to enable or disable Intel Speed Shift Technology support. This feature enables the operating system to select appropriate processor performance automatically (ON by default).</p>

Security

This section provides security details and settings.

Table 21. Security

Options	Description
TPM 2.0 Security	
TPM 2.0 Security On	<p>This section contains a toggle switch to select whether Trusted Platform Module(TPM) is visible to the Operating System(OS). (ON by default)</p>
Attestation Enable	<p>This section contains a toggle switch which lets the user control whether the TPM Endorsement Hierarchy is available to the operating system (OFF by default).</p>
Key Storage Enable	<p>This section contains a toggle switch that allows the user to control whether TPM Storage Hierarchy is available to the operating system (ON by default).</p>
SHA-256	<p>This section contains a toggle switch that when enabled, allows the BIOS and the TPM to use the SHA-256 hash algorithm to extend measurements into the TPM PCRs during BIOS boot (ON by default).</p>
Clear	<p>This section contains a toggle switch which clears the TPM owner information, and returns the TPM to the default state (OFF by default).</p>

Table 21. Security (continued)

Options	Description
PPI Bypass for Clear Commands	This section contains a toggle switch which controls the TPM Physical Presence Interface(PPI). When enabled, this setting will allow the OS to skip BIOS PPI user prompts when issuing the clear command (OFF by default).
TPM State	This section allows the user to enable or disable the TPM. This is the default operating state for the TPM when you want to use its complete arrays of capabilities (enabled by default).
Intel Total Memory Encryption	
Total Memory Encryption(TME)	This section allows the user to enable/disable TME to protect memory from physical attacks including freeze spray, probing DDR to read the cycles etc. All of the system memory is encrypted by the TME block attached to the memory controller
Chassis Intrusion	
Chassis Intrusion	This field controls the chassis intrusion feature <ul style="list-style-type: none"> ● Disabled - Will not report intrusions during POST ● Enabled - Will report intrusions during POST ● On-silent - Detects intrusions but does not display any detected intrusions during POST (Selected by default)
Clear Intrusion Warning	This section contains a toggle switch to enable/disable warnings on intrusion (OFF by default).
SMM Security Mitigation	This section allows the user to enable or disable UEFI SMM security Mitigation protections (ON by default).
Data Wipe on Next Boot	
Start Data Wipe	This section contains toggle switch which when enabled ensures that the BIOS will queue up a data wipe cycle for storage device(s) connected to the system board on the next reboot (OFF by default).
Absolute	
Absolute	This section lets the user enable, disable or permanently disable the BIOS module interface of the optional Absolute Persistence Module service from Absolute Software. The options available are as follows: <ul style="list-style-type: none"> ● Enable Absolute - Enables Absolute Persistence and load the firmware Persistence Module (Selected by default) ● Disable Absolute - Disables Absolute Persistence. The firmware Persistence Module is not installed. ● Permanently Disable Absolute - Permanently disables Absolute Persistence module interface from further use.
UEFI Boot Path Security	
UEFI Boot Path Security	This section lets the user control whether the system will prompt the user to enter the admin password(if set) when booting to a UEFI boot path device from F12 boot menu. The options available are as below: <ul style="list-style-type: none"> ● Never ● Always ● Always Except Internal HDD (Selected by default)

Table 21. Security (continued)

Options	Description
	<ul style="list-style-type: none"> Always Except Internal HDD&PXE
SafeShutter	
SafeShutter	<p>This section allows the user to choose between dynamic and manual shutter control:</p> <ul style="list-style-type: none"> Dynamic Shutter - Camera shutter will automatically open when user grants application permission and close when permission ends. Can be disabled by using the F9 camera mute key(LED on). This is the default selected option. Manual Shutter Control - Shutter opens when F9 key is pressed(LED off) and closes when F9 key is pressed(LED on)

Passwords

This section provides details on password settings.

Table 22. Passwords

Options	Description
Admin Password	This field allows the user to set, change, or delete the administrator password.
System Password	This field allows the user to set, change, or delete the system password.
Internal HDD-0 Password	This field allows the user to set, change, or delete the HDD-0's password.
NVMe SSD0	This field allows the user to set, change, or delete the NVMe SSD-0's password.
Password Configurator	
Upper Case Letter	Enable or disable reinforced use of upper case letters (OFF by default).
Lower Case Letter	Enable or disable reinforced use of lower case letters (OFF by default).
Digit	Enable or disable reinforced use of at least one digit (OFF by default).
Special Character	Enable or disable reinforced use of at least one special character (OFF by default).
Minimum Character	Allows the user to select the number of characters allowed for a password (4 is the default value).
Password Bypass	<p>This section allows the user to enable/disable the feature where the user must enter the system and internal hard drive password when the system is powered on from OFF state. The options are:</p> <ul style="list-style-type: none"> Disabled (Selected by default) Reboot Bypass
Password Changes	

Table 22. Passwords (continued)

Options	Description
Enable Non-Admin Password Changes	This section contains a toggle switch which when on, user can change system and hard drive password without the need for admin password (OFF by default).
Admin Setup Lockout	
Enable Admin Setup Lockout	This section contains a toggle switch which allows the administrator to control how users can or cannot access BIOS setup (OFF by default).
Master Password Lockout	
Enable Active Password Lockout	This section contains a toggle switch which allows the user to disable active password support (OFF by default).

Update Recovery

This section provides details on Update Recovery settings.

Table 23. Update Recovery

Options	Description
UEFI capsule Firmware Updates	
Enable UEFI Capsule Firmware Updates	This field contains a toggle switch which allows the user to enable or disable BIOS updates through UEFI capsule update packages (ON by default).
BIOS Recovery from Hard Drive	
BIOS Recovery from Hard Drive	This field contains a toggle switch which allows the user to enable or disable recovery from certain corrupted BIOS conditions from a recovery file on the user's primary hard drive or an external USB key (ON by default).
BIOS Downgrade	
Allow BIOS Downgrade	This field contains a toggle switch which allows the user to enable or disable flashing of the system firmware to previous revisions.
SupportAssist OS Recovery	
SupportAssist OS Recovery	This field contains a toggle switch which allows the user to enable or disable the boot flow for SupportAssist OS Recovery tool in the events of certain system errors (ON by default).
BIOSConnect	
BIOSConnect	This field contains a toggle switch which allows the user to enable or disable BIOSConnect setup to attempt cloud Service OS recovery if the main operating system fails to boot with a set number of failures (ON by default).
Dell Auto OS Recovery Threshold	
Dell Auto OS Recovery Threshold	This field allows the user to select the number of failed boot attempts by the system before SupportAssist OS Recovery is triggered. The options here are as below:

Table 23. Update Recovery (continued)

Options	Description
	<ul style="list-style-type: none"> • Off • 1 • 2 (selected by default) • 3

System Management

This section provides System Management settings.

Table 24. System Management

Options	Description
Service Tag	
Service Tag	This field provides the unique Service Tag of the computer.
Asset Tag	
Asset Tag	This field provides the asset tag which is a unique and up to 64-character identification that can be set by the IT administrator.
Wake on LAN	
Wake on LAN	<p>This field allows the user to select if and how the system should boot when connected to LAN. The options here are as follows:</p> <ul style="list-style-type: none"> • Disabled - The system will not boot with any special LAN signals (selected by default). • LAN only - Allows the system to be powered on by a special LAN signal from a network computer. • WLAN only - Allows the system to power on by special WLAN signals. • LAN or WLAN - Allows the system to power on by special LAN or wireless LAN signals. • LAN with PXE Boot - Allows the system to wake-up from S4 or S5 state and boot to PXE.
Auto On Time	
Auto On Time	<p>This field allows the user to set defined days/time when the system can automatically power on. The options here are as follows:</p> <ul style="list-style-type: none"> • Disabled (selected by default) • Everyday • Weekdays • Select Days
SERR Messages	<p>This section allows the user to enable or disable(ON/OFF) the SERR message mechanism (ON by default).</p> <p> NOTE: Some graphics cards require SERR message mechanism to be disabled.</p>
First Power On Date	This option if enabled lets the user see the ownership date (disabled by default).

Keyboard

This section provides keyboard settings.

Table 25. Keyboard

Options	Description
Enable keyboard Error Detection	This field contains a toggle switch(ON/OFF) to allow the keyboard-related errors to be reported when the system boots.
Numlock LED	This field contains a toggle switch(ON/OFF) to allow the user to decide if the Numlock LED should be on when the system boots.

Virtualization

This section provides details on Virtualization settings.

Table 26. Virtualization

Options	Description
Intel Virtualization Technology	
Enable Intel Virtualization Technology(VT)	This field contains a toggle switch to enable or disable Virtualization to run Virtual machine monitor(VMM) (enabled by default).
VT for Direct I/O	
Enable Intel VT for Direct I/O	This field allows the user to enable or disable the system from being able to perform VT for Direct I/O (enabled by default).

Performance

This section provides Performance settings.

Table 27. Performance

Options	Description
Multi-Core Support	
Active Cores	This field allows the user to configure the number of active cores on the computer. The options are as follows: <ul style="list-style-type: none">• All Cores (selected by default)• 1• 2• 3
Intel SpeedStep	
Enable Intel SpeedStep Technology	This field contains a toggle switch to enable or disable Intel SpeedStep Technology which allows the computer to dynamically adjust processor voltage and core frequency, decreasing average power consumption and heat production (enabled by default).
C-States Control	

Table 27. Performance (continued)

Options	Description
Enable C-States Control	This field contains a toggle switch to enable or disable C-States Control that configures the CPU's ability to enter and exit low power states. When off, it disables all C-States (enabled by default).
Intel Turbo Boost Technology	
Enable Intel Turbo Boost Technology	This field allows the user to enable or disable Intel Turbo Boost Technology (enabled by default). <ul style="list-style-type: none"> • Disabled - Does not allow the Intel Turbo Boost Technology driver to increase the performance state of the processor above the standard performance. • Enabled - Allows the Intel Turbo Boost Technology to increase the performance of the CPU or graphics processor.
Intel Hyper-Threading Technology	
Enable Intel Hyper-Threading Technology	This field allows the user to configure this feature where the processor resources are used more effectively, enabling multiple threads to run on each core (enabled by default).
Dynamic Tuning: Machine Learning	
Enable Dynamic Tuning: Machine Learning	This field allows the user to configure the OS' capability to enhance dynamic power tuning capabilities based on detected workloads (disabled by default)

System Logs

This section contains BIOS, Thermal and Power event logs.

Table 28. System Logs

Options	Description
BIOS Event Log	
Clear BIOS Event log	This field contains a toggle switch to Keep or Clear BIOS Event logs. It also lists all saved events(Date, Time, Message) - ("Keep" selected by default).

Updating the BIOS

Updating the BIOS in Windows

About this task

CAUTION: If BitLocker is not suspended before updating the BIOS, the next time you reboot the system it will not recognize the BitLocker key. You will then be prompted to enter the recovery key to progress and the system will ask for this on each reboot. If the recovery key is not known this can result in data loss or an unnecessary operating system re-install. For more information on this subject, see Knowledge Article: <https://www.dell.com/support/article/sln153694>

Steps

1. Go to www.dell.com/support.
2. Click **Product support**. In the **Search support** box, enter the Service Tag of your computer, and then click **Search**.
 **NOTE:** If you do not have the Service Tag, use the SupportAssist feature to automatically identify your computer. You can also use the product ID or manually browse for your computer model.
3. Click **Drivers & Downloads**. Expand **Find drivers**.
4. Select the operating system installed on your computer.
5. In the **Category** drop-down list, select **BIOS**.
6. Select the latest version of BIOS, and click **Download** to download the BIOS file for your computer.
7. After the download is complete, browse the folder where you saved the BIOS update file.
8. Double-click the BIOS update file icon and follow the on-screen instructions.
For more information, see knowledge base article [000124211](https://www.dell.com/support/article/000124211) at www.dell.com/support.

Updating the BIOS in Linux and Ubuntu

To update the system BIOS on a computer that is installed with Linux or Ubuntu, see the knowledge base article [000131486](https://www.dell.com/support/article/000131486) at www.dell.com/support.

Updating the BIOS using the USB drive in Windows

About this task

 **CAUTION:** If BitLocker is not suspended before updating the BIOS, the next time you reboot the system it will not recognize the BitLocker key. You will then be prompted to enter the recovery key to progress and the system will ask for this on each reboot. If the recovery key is not known this can result in data loss or an unnecessary operating system re-install. For more information on this subject, see Knowledge Article: <https://www.dell.com/support/article/sln153694>

Steps

1. Follow the procedure from step 1 to step 6 in [Updating the BIOS in Windows](#) to download the latest BIOS setup program file.
2. Create a bootable USB drive. For more information, see the knowledge base article [000145519](https://www.dell.com/support/article/000145519) at www.dell.com/support.
3. Copy the BIOS setup program file to the bootable USB drive.
4. Connect the bootable USB drive to the computer that needs the BIOS update.
5. Restart the computer and press **F12**.
6. Select the USB drive from the **One Time Boot Menu**.
7. Type the BIOS setup program filename and press **Enter**.
The **BIOS Update Utility** appears.
8. Follow the on-screen instructions to complete the BIOS update.

Updating the BIOS from the F12 One-Time boot menu

Update your computer BIOS using the BIOS update.exe file that is copied to a FAT32 USB drive and booting from the F12 One-Time boot menu.

About this task

 **CAUTION:** If BitLocker is not suspended before updating the BIOS, the next time you reboot the system it will not recognize the BitLocker key. You will then be prompted to enter the recovery key to progress and the system will ask for this on each reboot. If the recovery key is not known this can result in data loss or an unnecessary operating system re-install. For more information on this subject, see Knowledge Article: <https://www.dell.com/support/article/sln153694>

BIOS Update

You can run the BIOS update file from Windows using a bootable USB drive or you can also update the BIOS from the F12 One-Time boot menu on the computer.

Most of the Dell computers built after 2012 have this capability, and you can confirm by booting your computer to the F12 One-Time Boot Menu to see if BIOS FLASH UPDATE is listed as a boot option for your computer. If the option is listed, then the BIOS supports this BIOS update option.

 **NOTE:** Only computers with BIOS Flash Update option in the F12 One-Time boot menu can use this function.

Updating from the One-Time boot menu

To update your BIOS from the F12 One-Time boot menu, you need the following:

- USB drive formatted to the FAT32 file system (key does not have to be bootable)
- BIOS executable file that you downloaded from the Dell Support website and copied to the root of the USB drive
- AC power adapter that is connected to the computer
- Functional computer battery to flash the BIOS

Perform the following steps to perform the BIOS update flash process from the F12 menu:

 **CAUTION:** Do not turn off the computer during the BIOS update process. The computer may not boot if you turn off your computer.

Steps

1. From a turn off state, insert the USB drive where you copied the flash into a USB port of the computer.
2. Turn on the computer and press F12 to access the One-Time Boot Menu, select BIOS Update using the mouse or arrow keys then press Enter.
The flash BIOS menu is displayed.
3. Click **Flash from file**.
4. Select external USB device.
5. Select the file and double-click the flash target file, and then click **Submit**.
6. Click **Update BIOS**. The computer restarts to flash the BIOS.
7. The computer will restart after the BIOS update is completed.

System and setup password

Table 29. System and setup password

Password type	Description
System password	Password that you must enter to log on to your system.
Setup password	Password that you must enter to access and make changes to the BIOS settings of your computer.

You can create a system password and a setup password to secure your computer.

 **CAUTION:** The password features provide a basic level of security for the data on your computer.

 **CAUTION:** Anyone can access the data stored on your computer if it is not locked and left unattended.

 **NOTE:** System and setup password feature is disabled.

Assigning a system setup password

Prerequisites

You can assign a new **System or Admin Password** only when the status is in **Not Set**.

About this task

To enter the system setup, press F2 immediately after a power-on or reboot.

Steps

1. In the **System BIOS** or **System Setup** screen, select **Security** and press **Enter**.
The **Security** screen is displayed.
2. Select **System/Admin Password** and create a password in the **Enter the new password** field.
Use the following guidelines to assign the system password:
 - A password can have up to 32 characters.
 - The password can contain the numbers 0 through 9.
 - Only lower case letters are valid, upper case letters are not allowed.
 - Only the following special characters are allowed: space, ("), (+), (.), (-), (.), (/), (;), ([), (\), (]), (`).
3. Type the system password that you entered earlier in the **Confirm new password** field and click **OK**.
4. Press **Esc** and a message prompts you to save the changes.
5. Press **Y** to save the changes.
The computer reboots.

Deleting or changing an existing system setup password

Prerequisites

Ensure that the **Password Status** is Unlocked (in the System Setup) before attempting to delete or change the existing System and Setup password. You cannot delete or change an existing System or Setup password, if the **Password Status** is Locked.

About this task

To enter the System Setup, press **F2** immediately after a power-on or reboot.

Steps

1. In the **System BIOS** or **System Setup** screen, select **System Security** and press **Enter**.
The **System Security** screen is displayed.
2. In the **System Security** screen, verify that **Password Status** is **Unlocked**.
3. Select **System Password**, alter or delete the existing system password and press **Enter** or **Tab**.
4. Select **Setup Password**, alter or delete the existing setup password and press **Enter** or **Tab**.
 **NOTE:** If you change the System and/or Setup password, re enter the new password when prompted. If you delete the System and Setup password, confirm the deletion when prompted.
5. Press **Esc** and a message prompts you to save the changes.
6. Press **Y** to save the changes and exit from System Setup.
The computer restarts.

Clearing CMOS settings

About this task

 **CAUTION:** Clearing CMOS settings will reset the BIOS settings on your computer.

Steps

1. Remove the [side cover](#).
2. Remove the [coin-cell battery](#).
3. Wait for one minute.
4. Replace the [coin-cell battery](#).

5. Replace the [base cover](#).

Clearing BIOS (System Setup) and System passwords

About this task

To clear the system or BIOS passwords, contact Dell technical support as described at www.dell.com/contactdell.

 **NOTE:** For information on how to reset Windows or application passwords, refer to the documentation accompanying Windows or your application.

Troubleshooting

Dell SupportAssist Pre-boot System Performance Check diagnostics

About this task

SupportAssist diagnostics (also known as system diagnostics) performs a complete check of your hardware. The Dell SupportAssist Pre-boot System Performance Check diagnostics is embedded with the BIOS and is launched by the BIOS internally. The embedded system diagnostics provides a set of options for particular devices or device groups allowing you to:

- Run tests automatically or in an interactive mode
- Repeat tests
- Display or save test results
- Run thorough tests to introduce additional test options to provide extra information about the failed device(s)
- View status messages that inform you if tests are completed successfully
- View error messages that inform you of problems encountered during testing

NOTE: Some tests for specific devices require user interaction. Always ensure that you are present at the computer terminal when the diagnostic tests are performed.

For more information, see <https://www.dell.com/support/kbdoc/000180971>.

Running the SupportAssist Pre-Boot System Performance Check

Steps

1. Turn on your computer.
2. As the computer boots, press the F12 key as the Dell logo appears.
3. On the boot menu screen, select the **Diagnostics** option.
4. Click the arrow at the bottom left corner.
Diagnostics front page is displayed.
5. Click the arrow in the lower-right corner to go to the page listing.
The items detected are listed.
6. To run a diagnostic test on a specific device, press Esc and click **Yes** to stop the diagnostic test.
7. Select the device from the left pane and click **Run Tests**.
8. If there are any issues, error codes are displayed.
Note the error code and validation number and contact Dell.

Diagnostic LED behavior

Table 30. Diagnostic LED behavior

Blinking pattern		Problem description	Suggested resolution
Amber	White		
1	2	Unrecoverable SPI Flash Failure	
2	1	CPU failure	<ul style="list-style-type: none"> • Run the Dell Support Assist/Dell Diagnostics tool.

Table 30. Diagnostic LED behavior (continued)

Blinking pattern		Problem description	Suggested resolution
Amber	White		
			<ul style="list-style-type: none"> • If problem persists, replace the system board.
2	2	System board failure (included BIOS corruption or ROM error)	<ul style="list-style-type: none"> • Flash latest BIOS version • If problem persists, replace the system board.
2	3	No memory/RAM detected	<ul style="list-style-type: none"> • Confirm that the memory module is installed properly. • If problem persists, replace the memory module.
2	4	Memory/RAM failure	<ul style="list-style-type: none"> • Reset the memory module. • If problem persists, replace the memory module.
2	5	Invalid memory installed	<ul style="list-style-type: none"> • Reset the memory module. • If problem persists, replace the memory module.
2	6	System board / Chipset Error / Clock failure / Gate A20 failure / Super I/O failure / Keyboard controller failure	<ul style="list-style-type: none"> • Flash latest BIOS version • If problem persists, replace the system board.
3	1	CMOS battery failure	<ul style="list-style-type: none"> • Reset the CMOS battery connection. • If problem persists, replace the RTS battery.
3	2	PCI or Video card/chip failure	Replace the system board.
3	3	BIOS Recovery image not found	<ul style="list-style-type: none"> • Flash latest BIOS version • If problem persists, replace the system board.
3	4	BIOS Recovery image found but invalid	<ul style="list-style-type: none"> • Flash latest BIOS version • If problem persists, replace the system board.
3	5	Power rail failure	<ul style="list-style-type: none"> • EC ran into power sequencing failure. • If problem persists, replace the system board.
3	6	SBIOS Flash corruption	<ul style="list-style-type: none"> • Flash corruption detected by SBIOS • If problem persists, replace the system board.
3	7	Intel ME (Management Engine) Error	<ul style="list-style-type: none"> • Timeout waiting on ME to reply to HECI message • If problem persists, replace the system board.
4	2	CPU Power Cable Connection Issue	

Real-Time Clock (RTC Reset)

The Real Time Clock (RTC) reset function allows you or the service technician to recover Dell systems from No POST/No Power/No Boot situations. The legacy jumper enabled RTC reset has been retired on these models.

Start the RTC reset with the system powered off and connected to AC power. Press and hold the power button for thirty (30) seconds. The system RTC Reset occurs after you release the power button.

Recovering the operating system

When your computer is unable to boot to the operating system even after repeated attempts, it automatically starts Dell SupportAssist OS Recovery.

Dell SupportAssist OS Recovery is a standalone tool that is preinstalled in all Dell computers installed with Windows operating system. It consists of tools to diagnose and troubleshoot issues that may occur before your computer boots to the operating system. It enables you to diagnose hardware issues, repair your computer, back up your files, or restore your computer to its factory state.

You can also download it from the Dell Support website to troubleshoot and fix your computer when it fails to boot into their primary operating system due to software or hardware failures.

For more information about the Dell SupportAssist OS Recovery, see *Dell SupportAssist OS Recovery User's Guide* at www.dell.com/serviceabilitytools. Click **SupportAssist** and then, click **SupportAssist OS Recovery**.

Backup media and recovery options

It is recommended to create a recovery drive to troubleshoot and fix problems that may occur with Windows. Dell proposes multiple options for recovering Windows operating system on your Dell PC. For more information, see [Dell Windows Backup Media and Recovery Options](#).

WiFi power cycle

About this task

If your computer is unable to access the internet due to WiFi connectivity issues a WiFi power cycle procedure may be performed. The following procedure provides the instructions on how to conduct a WiFi power cycle:

 **NOTE:** Some ISPs (Internet Service Providers) provide a modem/router combo device.

Steps

1. Turn off your computer.
2. Turn off the modem.
3. Turn off the wireless router.
4. Wait for 30 seconds.
5. Turn on the wireless router.
6. Turn on the modem.
7. Turn on your computer.

Drain residual flea power (perform hard reset)

About this task

Flea power is the residual static electricity that remains in the computer even after it has been powered off and the battery is removed.

For your safety, and to protect the sensitive electronic components in your computer, you are requested to drain residual flea power before removing or replacing any components in your computer.

Draining residual flea power, also known as a performing a "hard reset", is also a common troubleshooting step if your computer does not power on or boot into the operating system.

To drain residual flea power (perform a hard reset)

Steps

1. Turn off your computer.
2. Disconnect the power adapter from your computer.
3. Remove the base cover.
4. Remove the battery.
5. Press and hold the power button for 20 seconds to drain the flea power.
6. Install the battery.
7. Install the base cover.
8. Connect the power adapter to your computer.
9. Turn on your computer.



 **NOTE:** For more information about performing a hard reset, see the knowledge base article [000130881](https://www.dell.com/support) at www.dell.com/support.

Getting help and contacting Dell

Self-help resources

You can get information and help on Dell products and services using these self-help resources:

Table 31. Self-help resources

Self-help resources	Resource location
Information about Dell products and services	www.dell.com
My Dell app	
Tips	
Contact Support	In Windows search, type <code>Contact Support</code> , and press Enter.
Online help for operating system	www.dell.com/support/windows
Access top solutions, diagnostics, drivers and downloads, and learn more about your computer through videos, manuals and documents.	Your Dell computer is uniquely identified by a Service Tag or Express Service Code. To view relevant support resources for your Dell computer, enter the Service Tag or Express Service Code at www.dell.com/support . For more information on how to find the Service Tag for your computer, see Locate the Service Tag on your computer .
Dell knowledge base articles for a variety of computer concerns	<ol style="list-style-type: none"> 1. Go to www.dell.com/support. 2. On the menu bar at the top of the Support page, select Support > Knowledge Base. 3. In the Search field on the Knowledge Base page, type the keyword, topic, or model number, and then click or tap the search icon to view the related articles.

Contacting Dell

To contact Dell for sales, technical support, or customer service issues, see www.dell.com/contactdell.

 **NOTE:** Availability varies by country/region and product, and some services may not be available in your country/region.

 **NOTE:** If you do not have an active Internet connection, you can find contact information about your purchase invoice, packing slip, bill, or Dell product catalog.