

# QuickStart Guide

FortiAP 432FR

FAP-432FR

# Before you begin

Register your device to access FortiGuard updates, cloud management, firmware upgrades, technical support and warranty coverage.

<https://support.fortinet.com>



This guide covers: FAP-432FR

July 6, 2023

Copyright © 2023 Fortinet, Inc. All rights reserved. Fortinet®, FortiGate®, FortiCare® and FortiGuard®, and certain other marks are registered trademarks of Fortinet, Inc., in the U.S. and other jurisdictions, and other Fortinet names herein may also be registered and/or common law trademarks of Fortinet. All other product or company names may be trademarks of their respective owners. Performance and other metrics contained herein were attained in internal lab tests under ideal conditions, and actual performance and other results may vary. Network variables, different network environments and other conditions may affect performance results. Nothing herein represents any binding commitment by Fortinet, and Fortinet disclaims all warranties, whether express or implied, except to the extent Fortinet enters a binding written contract, signed by Fortinet's General Counsel, with a purchaser that expressly warrants that the identified product will perform according to certain expressly-identified performance metrics and, in such event, only the specific performance metrics expressly identified in such binding written contract shall be binding on Fortinet. For absolute clarity, any such warranty will be limited to performance in the same ideal conditions as in Fortinet's internal lab tests. In no event does Fortinet make any commitment related to future deliverables, features or development, and circumstances may change such that any forward-looking statements herein are not accurate. Fortinet disclaims in full any covenants, representations, and guarantees pursuant hereto, whether express or implied. Fortinet reserves the right to change, modify, transfer, or otherwise revise this publication without notice, and the most current version of the publication shall be applicable.

For Product License Agreement / EULA and Warranty Terms, visit <https://www.fortinet.com/content/dam/fortinet/assets/legal/EULA.pdf>

# The Essentials

## Default Logins

 <https://192.168.1.2>  
Username: **admin**  
Password: **leave blank**

 <http://fortilancloud.com>  
Username: **user-defined**  
Password: **user-defined**

## Admin Guide

For a detailed FortiAP setup and configuration information, refer to the Admin Guide on <https://docs.fortinet.com/product/fortiap>

## Customer Service

For contracts, licensing, product registration and account management, contact FortiCare Support at <https://www.fortinet.com/support/contact>

## Self-service Resources

Access our knowledge base, forums, videos and technical experts at <https://www.fortinet.com/support/support-services/forticare-support>

Thank you for choosing Fortinet

# Package Contents

FortiAP 432FR  
FAP-432FR



QuickStart Guide



FortiAP Device



1x PoE Injector and AC Cord  
(100V-220V AC Input,  
54V DC Output)

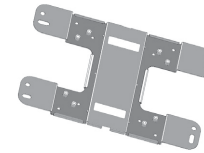

Wall Mount  
Bracket

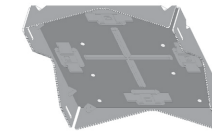

Pole Mount  
Bracket

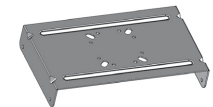

External Antenna  
Bracket

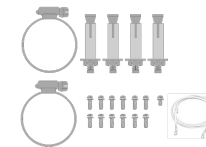

Mounting Kit  
(2x Pole Straps,  
4x Mounting Bolts with Screws,  
1x Grounding Cable,  
13x Mounting Screws)

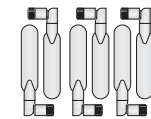

6x N-Type Omni Antennas  
(5x 2.4GHz/5.0GHz,  
1x 2.4GHz)

# Setup Options

## FortiLAN Cloud

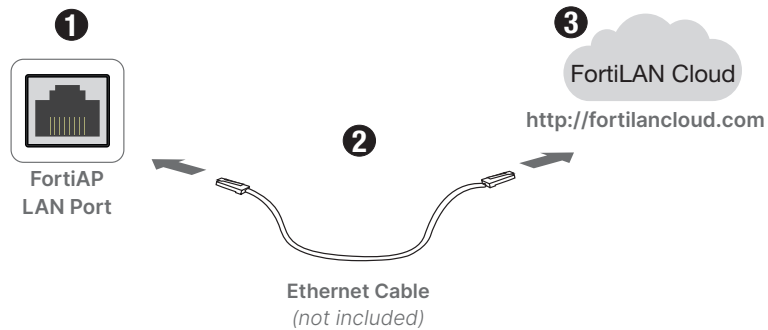

**Note:** Use your FortiCloud credentials to log in, then click Inventory, Import AP Key and enter the Cloud Key on the device sticker

## Network Connection

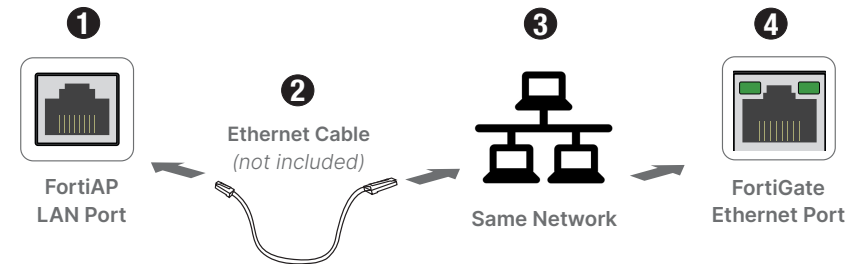

**Note:** Connect to the FortiAP using 192.168.1.2 with username *admin* and set a password. Specify the FortiGate IP using:

```
cfg -a AC_IPADDR=0.0.0.0  
cfg -c
```

where 0.0.0.0 is the FortiGate IP.

## Direct Connection

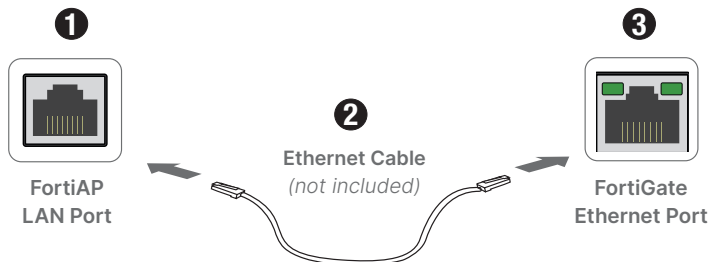

**Note:** To self-configure, preauthorize the FortiAP on your FortiGate. Otherwise once connected, wait for the FortiAP to appear on the Managed FortiAP page in FortiOS.

## Wall Installation

1. Mark the location of the mounting bolts using the wallmount bracket
2. Drill holes and hammer the bolts into the drilled holes
3. Attach the wallmount bracket to the device with the provided screws
4. Secure the device on the wall using the mounting bolts

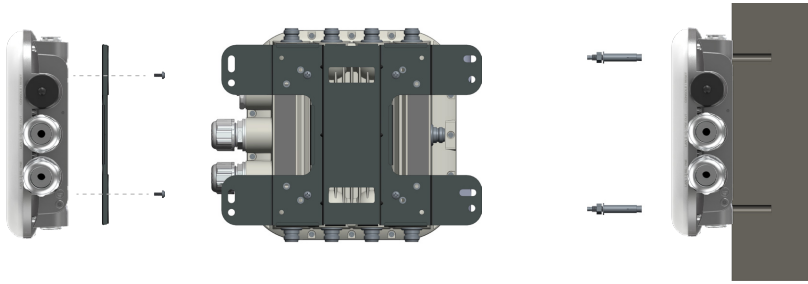

## External Antenna Installation

Attach the bracket to the device using the provided screws.

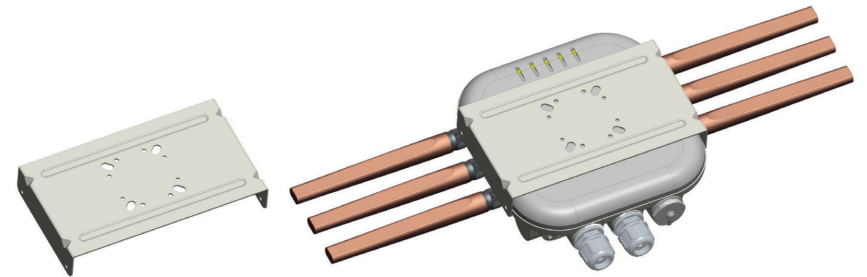

## Pole Installation

1. Attach the wallmount bracket, then the pole mount bracket to the device using the provided mounting screws
2. Loop the pole straps through the bracket slots, then around the pole
3. Tighten the straps

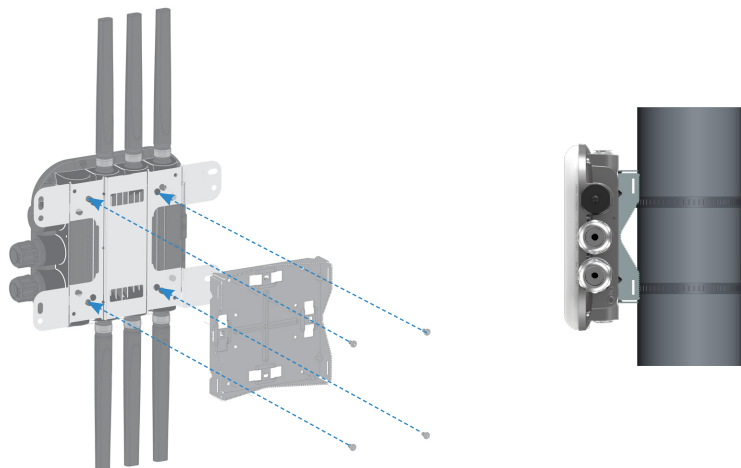

## Antenna Installation

1. Insert the antenna base firmly into the appropriate antenna mount
2. Securely hand tighten the antenna fastening collar
3. Repeat for the remaining antennas



**Note:** Antennas A1/A2/A3/A4 radiate Radio1/Radio2 at 2.4/5.0GHz

## PoE Injector Installation

1. Attach the supplied AC power cord to the PoE injector
2. Plug the power cord into a power outlet or UPS
3. Connect an Ethernet cable from the injector POE port to LAN 1 on the FortiAP
4. Use the LAN port on the injector to connect to a network device

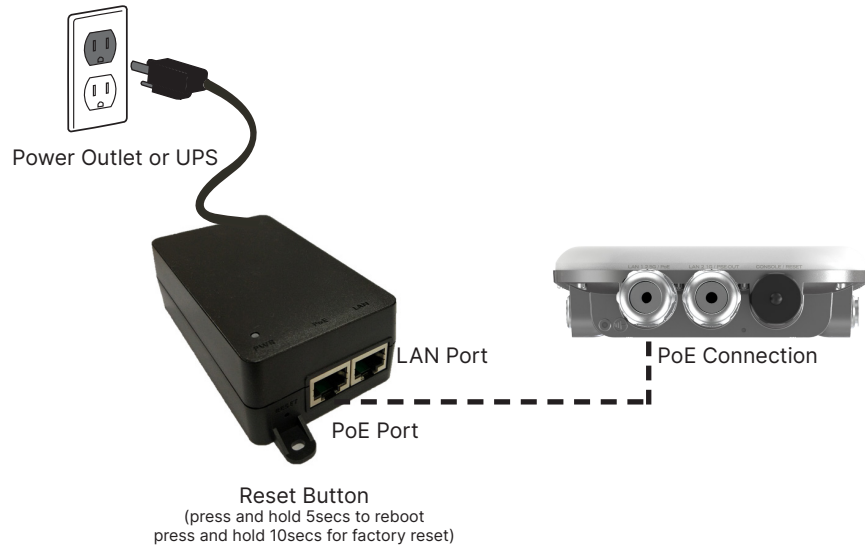

## Waterproof Cabling

1. Unscrew the sealing nut from the panel connector and remove the seal and claw
2. Thread the RJ45 plug through the sealing nut, then the panel connector
3. Wrap the seal and claw around the cable between the sealing nut and connector
4. Insert the RJ45 plug into the port and screw the panel connector onto the threads
5. Slide the seal and claw along the cable into the panel connector
6. Threat the coupling ring onto the panel connector and tighten it

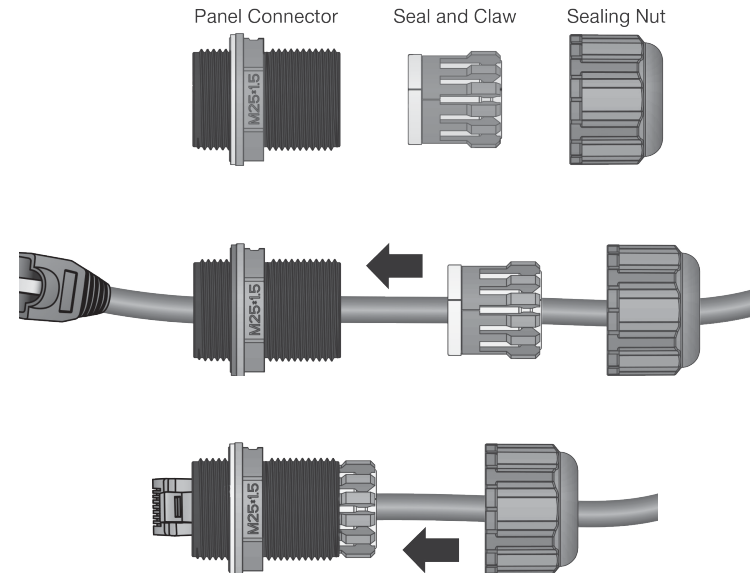

## Interfaces

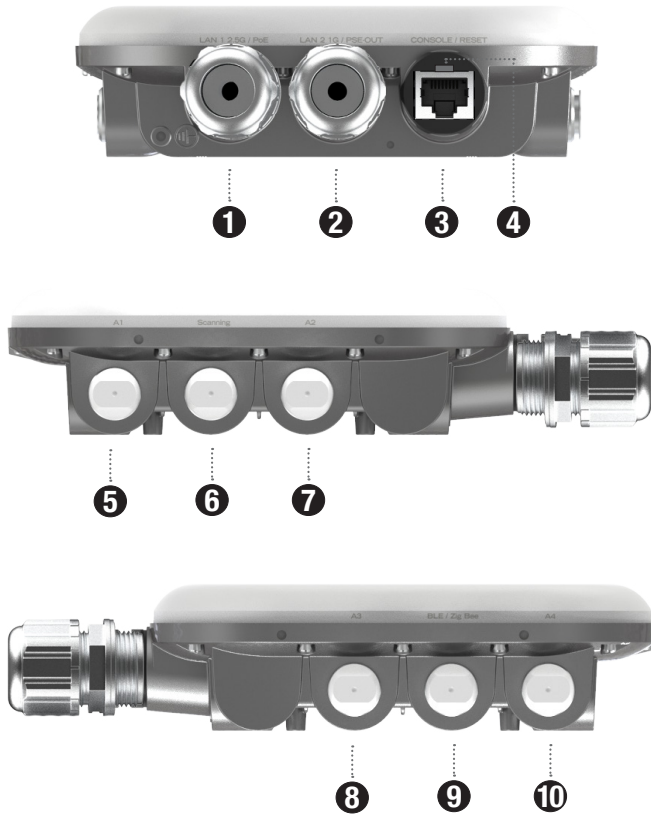

- |                                     |                                    |
|-------------------------------------|------------------------------------|
| <b>1</b> LAN 1 2.5GE / PoE (RJ45)   | <b>6</b> Scanning Antenna          |
| <b>2</b> LAN 2 1GE / PSE OUT (RJ45) | <b>7</b> A2 2.4GHz/5.0GHz Antenna  |
| <b>3</b> CONSOLE (RJ45)             | <b>8</b> A3 2.4GHz/5.0GHz Antenna  |
| <b>4</b> RESET Button               | <b>9</b> BLE/Zigbee Antenna        |
| <b>5</b> A1 2.4GHz/5.0GHz Antenna   | <b>10</b> A4 2.4GHz/5.0GHz Antenna |

## LED Indicators



- |   |  |
|---|--|
| <p><b>1</b> BLE, Zigbee &amp; Scanning</p> <ul style="list-style-type: none"> <li>✖ Off: BLE, Zigbee &amp; Radio 3 are off</li> <li>✖ Amber: Radio 3 is on</li> <li>✖ Blinking Amber: Radio 3 is scanning</li> <li>✖ Blue: BLE is on</li> <li>✖ Blinking Blue: BLE is transmitting</li> <li>✖ Red: Zigbee is on</li> <li>✖ Blinking Red: Zigbee is transmitting</li> <li>✖ Green: BLE, Zigbee &amp; Radio 3 are on</li> <li>✖ Blinking Green: BLE, Zigbee &amp; Radio 3 are transmitting</li> </ul> | <p><b>2</b> WiFi</p> <ul style="list-style-type: none"> <li>✖ Off: Radio 1 &amp; 2 are off</li> <li>✖ Blue: Radio 1 is on</li> <li>✖ Blinking Blue: Radio 1 is transmitting</li> <li>✖ Amber: Radio 2 is on</li> <li>✖ Blinking Amber: Radio 2 is transmitting</li> <li>✖ Green: Radio 1 &amp; 2 are on</li> <li>✖ Blinking Green: Radio 1 &amp; 2 are transmitting</li> </ul> |
| <p><b>3</b> LAN 2 (1Gbps 802.3at PSE OUT RJ45)</p> <ul style="list-style-type: none"> <li>✖ Off: Link is off</li> <li>✖ Green: Link is on</li> <li>✖ Blinking Green: Transmitting at 1Gbps</li> <li>✖ Blinking Amber: Transmitting at 100Mbps</li> </ul>  | <p><b>4</b> LAN 1 (2.5 Gbps 802.3at PoE RJ45)</p> <ul style="list-style-type: none"> <li>✖ Off: Link is off</li> <li>✖ Green: Link is on</li> <li>✖ Blinking Green: Transmitting at 2.5Gbps</li> <li>✖ Blinking Amber: Transmitting at 100Mbps</li> </ul>  |
|   | <p><b>5</b> Power</p> <ul style="list-style-type: none"> <li>✖ Off: Device is off</li> <li>✖ Green: Device is on</li> <li>✖ Blinking Green: Booting up or upgrading</li> <li>✖ Amber: Reserved for customizations</li> </ul>   |

## Cautions and Warnings

### Environmental specifications

Ambient operating temperature: -30°C to 60°C

Refer to specific Product Model Data Sheet for Environmental Specifications (Operating Temperature, Storage Temperature, Humidity, and Altitude)

Référez à la Fiche Technique de ce produit pour les caractéristiques environnementales (Température de fonctionnement, température de stockage, humidité et l'altitude).

### Safety

**Warning:** Equipment intended for installation in Restricted Access Location.  
**Avvertissement:** équipement destiné à être installé dans un endroit à accès restreint.

**Caution:** This equipment is to be used in a Network Environment 0 per IECTR 62101. This product is connected only to PoE networks without routing to the outside plant.

**Attention:** Ce matériel doit être utilisé dans un Environnement Réseau 0 par IECTR 62101. Ce produit est uniquement connecté aux réseaux PoE sans installation externe de routage.

FAP-432FR is intended to be supplied by a Listed Direct Plug-In Power Unit marked LPS or Class 2 and rated 54 Vdc, 1.11A from PoE source.

Le FAP-432FR est conçu pour être alimenté par un bloc d'alimentation enfichable direct répertorié marqué LPS ou Classe 2 et évalué à 54 Vcc, 1,11 A à partir de la source PoE.

**Grounding** — To prevent damage to your equipment, connections that enter from outside the building should pass through a lightning/surge protector, and be properly grounded. Use an electrostatic discharge workstation (ESD) and/or wear anti-static wrist strap while you work. In addition to the grounding terminal of the plug, on the back panel, there is another, separate terminal for earthing.

**Mise à la terre** — Pour éviter d'endommager votre équipement, les connexions qui entrent de l'extérieur du bâtiment doivent passer par un parafoudre / surtension et être correctement mises à la terre. Utilisez une station de travail à décharge électrostatique (ESD) et / ou portez un bracelet antistatique pendant que vous travaillez. En plus de la borne de mise à la terre de la fiche, sur le panneau arrière, il y a une autre borne séparée pour la mise à la terre.

### INSTALLATION AND OPERATING INSTRUCTIONS:

1. Temperature code (T-Code) – T4
2. Maximum Ambient Temperature: -30°C ≤ Tamb ≤ 60°C
3. "This equipment is suitable for use in Class I, Division 2, Groups A, B, C, and D or non-hazardous locations only."
4. "This equipment is intended to be mounted on a pole with the mounting bracket or wall mounting" Or equivalent.
5. "Product is UL Listed with UL Listed Conduit Fittings for use with UL Listed liquid-tight flexible metal conduit. This wiring method is suitable for flexible connections in accordance with Article 501.10(B)(2) of the National Electrical Code (ANSI/NFPA 70). Disconnection and reconnection should be performed only by trained service personnel. Suitability for installation in particular applications is at the discretion of the Authority Having Jurisdiction (AHJ)."
6. **"WARNING** – EXPLOSION HAZARD. DO NOT REMOVE OR REPLACE WHILE CIRCUIT IS LIVE UNLESS THE AREA IS FREE OF IGNITIBLE CONCENTRATIONS."  
**"AVERTISSEMENT** – RISQUE D'EXPLOSION. NE PAS RETIRER NI REMPLACER PENDANT QUE LE CIRCUIT EST SOUS TENSION À MOINS QUE L'EMPLACEMENT NE SOIT EXEMPT DE CONCENTRATIONS INFLAMMABLES."

## Regulatory Notices

### Federal Communication Commission (FCC) – USA

This device complies with Part 15 of the FCC Rules. Operation is subject to the following two conditions:  
(1) this device may not cause harmful interference, and  
(2) this device must accept any interference received; including interference that may cause undesired operation.

This equipment has been tested and found to comply with the limits for a Class B digital device, pursuant to Part 15 of the FCC Rules. These limits are designed to provide reasonable protection against harmful interference in residential installation. This equipment generates, uses, and can radiate radio frequency energy, and if it is not installed and used in accordance with the instruction manual, it may cause harmful interference to radio communications. However, there is no guarantee that interference will not occur in a particular installation.

If this equipment does cause harmful interference to radio or television reception, which can be determined by turning the equipment off and on, the user is encouraged to try to correct the interference by one or more of the following measures:

- Reorient or relocate the receiving antenna.
- Increase the separation between the equipment and receiver.
- Connect the equipment into an outlet on a circuit different from that to which the receiver is connected.
- Consult the dealer or an experienced radio/TV technician for help.

**WARNING:** Any changes or modifications to this unit not expressly approved by the party responsible for compliance could void the user's authority to operate the equipment

This equipment complies with FCC radiation exposure limits set forth for an uncontrolled environment. This equipment should be installed and operated with minimum distance 42cm between the radiator and your body. This transmitter must not be co-located or operating in conjunction with any other antenna or transmitter.

This device meets all the other requirements specified in Part 15E, Section 15.407 of the FCC Rules.

### Industry Canada Equipment Standard for Digital Equipment (ICES) – Canada

This Class B digital apparatus complies with Canadian ICES-003.

Cet appareil numérique de la classe B est conforme à la norme NMB-003 du Canada.

### Innovation, Science and Economic Development (ISED) – Canada

This device contains licence-exempt transmitter(s)/receiver(s) that comply with Innovation, Science and Economic Development Canada's licence-exempt RSS(s). Operation is subject to the following two conditions:  
1.This device may not cause interference.  
2.This device must accept any interference, including interference that may cause undesired operation of the device.

L'émetteur/récepteur exempt de licence contenu dans le présent appareil est conforme aux CNR d'Innovation, Sciences et Développement économique Canada applicables aux appareils radio exempts de licence. L'exploitation est autorisée aux deux conditions suivantes:

- 1.L'appareil ne doit pas produire de brouillage;
- 2.L'appareil doit accepter tout brouillage radioélectrique subi, même si le brouillage est susceptible d'en compromettre le fonctionnement.

For product available in the USA/Canada market, only channel 1–11 can be operated. Selection of other channels is not possible. Pour les produits disponibles aux États-Unis / Canada du marché, seul le canal 1 à 11 peuvent être exploités. Sélection d'autres canaux n'est pas possible.

This equipment complies with ISED radiation exposure limits set forth for an uncontrolled environment. This equipment should be installed and operated with minimum distance 52cm between the radiator & your body.

Cet équipement est conforme aux limites d'exposition aux rayonnements ISED établies pour un environnement non contrôlé. Cet équipement doit être installé et utilisé avec un minimum de 52cm de distance entre la source de rayonnement et votre corps.

The maximum antenna gain permitted for devices in the band 5725-5850 MHz shall be such that the equipment still complies with the e.i.r.p. limits specified for point-to-point and non-point-to-point operation as appropriate.

Le gain maximal d'antenne permis (pour les dispositifs utilisant la bande 5725-5850 MHz) doit se conformer à la limite de p.i.r.e. spécifiée pour l'exploitation point à point et non point à point, selon le cas.

**Caution:** The maximum antenna gain permitted for devices in the bands 5250-5350 MHz and 5470-5725 MHz shall comply with the e.i.r.p. limit; and the maximum antenna gain permitted for devices in the band 5725-5825 MHz shall comply with the e.i.r.p. limits specified for point-to-point and non point-to-point operation as appropriate.

**Attention:** Le gain maximal d'antenne permis pour les dispositifs utilisant les bandes 5 250-5 350 MHz et 5 470-5 725 MHz doit se conformer à la limite de p.i.r.e.; le gain maximal d'antenne permis (pour les dispositifs utilisant la bande 5 725-5 825 MHz) doit se conformer à la limite de p.i.r.e. spécifiée pour l'exploitation point à point et non point à point, selon le cas.

(iii) where applicable, antenna type(s), antenna model(s), and worst-case tilt angle(s) necessary to remain compliant with the e.i.r.p. elevation mask requirement set forth in section 6.2.2.3 shall be clearly indicated.

(iii) lorsqu'il y a lieu, les types d'antennes (s'il y en a plusieurs), les numéros de modèle de l'antenne et les pires angles d'inclinaison nécessaires pour rester conforme à l'exigence de la p.i.r.e. applicable au masque d'élévation, énoncée à la section 6.2.2.3, doivent être clairement indiqués.

This radio transmitter (IC: 7280B-3417T0966 / Model: FAP-432FR) has been approved by ISED to operate with the antenna types listed below with the maximum permissible gain and required antenna impedance for each antenna type indicated. Antenna types not included in this list, having a gain greater than the maximum gain indicated for that type, are strictly prohibited for use with this device.

Le présent émetteur radio (IC: 7280B-3417T0966 / Model: FAP-432FR) a été approuvé par ISED pour fonctionner avec les types d'antenne énumérés ci-dessous et ayant un gain admissible maximal et l'impédance requise pour chaque type d'antenne. Les types d'antenne non inclus dans cette liste, ou dont le gain est supérieur au gain maximal indiqué, sont strictement interdits pour l'exploitation de l'émetteur.

This device and it's antennas(s) must not be co-located or operating in conjunction with any other antenna or transmitter except in accordance with IC multi-transmitter product procedures.

Cet appareil et son antenne (s) ne doit pas être co-localisés ou fonctionner en association avec une autre antenne ou transmetteur.



## FAP-432FR

Antenna Type	Dipole					
	N-Type					
	Frequency					
Gain (dBi)	2400MHz	2450MHz	2500MHz	UNII-1 & UNII-2A	UNII-2C	UNII-3
Wi-Fi Scanning	5.1	5.0	5.5	6.7	7.2	7.0
BLE/Zigbee	4.1	4.2	4.5	–	–	–

### Professional Installation Instructions

#### 1. Installation Personnel

This product is designed for specific application and needs to be installed by qualified personnel who has RF and related rule knowledge. The general user shall not attempt to install or change the settings.

#### 2. Installation Location

The product shall be installed at a location where the radiating antenna can be kept 42/52 cm from nearby person in normal operation condition to meet regulatory RF exposure requirement.

#### 3. External Antenna

Use only the antenna which have been approved by the applicant. The non-approved antenna(s) may produce unwanted spurious or excessive RF transmitting power which may lead to the violation of FCC/IC limit and is prohibited.

#### 4. Installation Procedure

Please refer to user's manual for the detail.

#### 5. Warning

Please carefully select the installation position and make sure that the final output power does not exceed the limit set forth in relevant rules. The violation of the rule could lead to serious federal penalty.

### Instructions d'installation professionnelle

#### 1. Installation

Ce produit est destiné à un usage spécifique et doit être installé par un personnel qualifié maîtrisant les radiofréquences et les règles s'y rapportant. L'installation et les réglages ne doivent pas être modifiés par l'utilisateur final.

#### 2. Emplacement d'installation

En usage normal, afin de respecter les exigences réglementaires concernant l'exposition aux radiofréquences, ce produit doit être installé de façon à respecter une distance de 42/52 cm entre l'antenne émettrice et les personnes.

#### 3. Antenne externe

Utiliser uniquement les antennes approuvées par le fabricant. L'utilisation d'autres antennes peut conduire à un niveau de rayonnement essentiel ou non essentiel dépassant les niveaux limites définis par FCC/IC, ce qui est interdit.

#### 4. Procédure d'installation

Consulter le manuel d'utilisation.

#### 5. Avertissement

Choisir avec soin la position d'installation et s'assurer que la puissance de sortie ne dépasse pas les limites en vigueur. La violation de cette règle peut conduire à de sérieuses pénalités fédérales.

### European Conformity (CE) – EU

This is a Class B product. In a domestic environment, this product may cause radio interference, in which case the user may be required to take adequate measures.



The product transmits within the frequency ranges and less than or equal to the power listed below:

2402-2480MHz less than 20dBm (BT/BLE)

2405-2480MHz less than 20dBm (Zigbee)

2412-2472MHz less than 20dBm

5180-5240MHz less than 23dBm \*

5260-5320MHz less than 23dBm \*

5500-5700MHz less than 30dBm \*

Note: \* Only with DFS bands certification.

This equipment should be installed and operated with minimum distance 20cm between the radiator and your body.

### Simplified EU Declaration of Conformity

This declaration is only valid for Fortinet products (including, combinations of software, firmware and hardware) provided by Fortinet or Fortinet's authorized partners to the end customer directly for use within the EU or countries that have implemented the EU Directives and/or spectrum regulation. Any Fortinet products not obtained directly from Fortinet or Fortinet's authorized partners may not comply with EU Directives and Fortinet makes no assurances for such products.

#### Български

Този продукт е в съответствие с Директива 2014/53/ЕС.

#### Česky

Tento produkt je v souladu se směrnici 2014/53/EU.

#### Dansk

Dette produkt er i overensstemmelse med direktiv 2014/53/EU.

#### Deutsch

Dieses Produkt entspricht der Richtlinie 2014/53/EU.

#### Eesti

See toode vastab direktiivile 2014/53/EL.

#### English

This product is in compliance with Directive 2014/53/EU.

#### Español

Este producto cumple con la Directiva 2014/53/UE.

#### Ελληνική

Το προϊόν αυτό συμμορφώνεται με την Οδηγία 2014/53/ΕΕ.

#### Français

Ce produit est conforme à la Directive 2014/53/UE.

#### Hrvatski

Ovaj proizvod je u skladu s Direktivom 2014/53/UE.

#### Italiano

Questo prodotto è conforme alla Direttiva 2014/53/EU.

#### Latviski

Šis produkts atbilst Direktīvai 2014/53/EU.

#### Lietuvių

Šis gaminytis atitinka direktyvą 2014/53/ES.

#### Malti

Dan il-prodott huwa konformi mad-Direttiva 2014/53/UE.

#### Magyar

Ez a termék megfelel a 2014/53/EU irányelvnek.

#### Nederlands

Dit product is in overeenstemming met Richtlijn 2014/53/EU.

#### Norsk

Dette produktet er i samsvar med direktiv 2014/53/EU.

#### Polski

Ten produkt jest zgodny z dyrektywą 2014/53/UE.

#### Português

Este produto está em conformidade com a Diretiva 2014/53/UE.

#### Rumunski

Acest produs este în conformitate cu Directiva 2014/53/UE.

#### Slovensky

Tento produkt je v súlade so smernicou 2014/53/EÚ.

#### Slovensko

Ta izdelek je v skladu z Direktivo 2014/53/EU.

#### Suomi

Tämä tuote on direktiivin 2014/53/EU mukainen.

#### Svenska

Denna produkt överensstämmer med direktiv 2014/53/EU.

Note: The full declaration of conformity for this product is available at the link below:  
<https://site.fortinet.com/ProductRegulatory/EU>



