



User Guide

SUMMARY

This guide provides basic information for using and upgrading this product, including topics such as components, features, networks, and HP resources.

Legal information

© Copyright 2023 HP Development Company, L.P.

Bluetooth is a trademark owned by its proprietor and used by HP Inc. under license. Chrome, ChromeOS, Chromebook, Chromebox, Google, and Google Drive are trademarks of Google LLC. The terms HDMI, HDMI High-Definition Multimedia Interface, and the HDMI Logo are trademarks or registered trademarks of HDMI Licensing Administrator, Inc. Celeron and Intel are trademarks of Intel Corporation or its subsidiaries in the U.S. and/or other countries. Windows is either a registered trademark or trademark of Microsoft Corporation in the United States and/or countries. The microSD logo and microSD are trademarks of SD-3C LLC. USB Type-C® and USB-C® are registered trademarks of USB Implementers Forum. DisplayPort™ and the DisplayPort™ logo are trademarks owned by the Video Electronics Standards Association (VESA) in the United States and other countries.

First Edition: July 2023

Document Part Number: N56383-001

Product notice

This guide describes features that are common to most models. Some features may not be available on your computer.

Software terms

By installing, copying, downloading, or otherwise using any software product preinstalled on this computer, you agree to be bound by the terms of the HP End User License Agreement (EULA). If you do not accept these license terms, your sole remedy is to return the entire unused product (hardware and software) within 14 days for a full refund subject to the refund policy of your seller.

For any further information or to request a full refund of the price of the computer, please contact your seller.

Safety warning notice

Reduce the possibility of heat-related injuries or of overheating the computer by following the practices described.

-
- ⚠ WARNING!** To reduce the possibility of heat-related injuries or of overheating the computer, do not place the computer directly on your lap or obstruct the computer air vents. Use the computer only on a hard, flat surface. Do not allow another hard surface, such as an adjoining optional printer, or a soft surface, such as pillows or rugs or clothing, to block airflow. Also, do not allow the AC adapter to come into contact with the skin or a soft surface, such as pillows or rugs or clothing, during operation. The computer and the AC adapter comply with the user-accessible surface temperature limits defined by applicable safety standards.
-

Table of contents

1 About this guide	1
2 Components	2
Right	2
Front	2
Rear	4
Bottom	5
Labels	5
3 Using your Chromebox	8
Using audio	8
Connecting speakers	8
Connecting headphones	8
Using video	8
Connecting an HDMI device	8
Connecting to a wireless network	9
Enabling and disabling Wake on LAN	9
Turning WOL on or off	9
Managing apps	10
4 Securing your Chromebox and information	11
Securing your wireless network	11
Backing up your software applications and information	11
Recovering your Chromebox	11
Using an optional security cable	12
5 Printing	13
Printing with built-in ChromeOS solution	13
Printing from Google Chrome	13
6 More HP resources	14
7 Electrostatic discharge	15
8 Accessibility	16
HP and accessibility	16
Finding the technology tools you need	16
The HP commitment	16
International Association of Accessibility Professionals (IAAP)	17
Finding the best assistive technology	17
Assessing your needs	17

Accessibility for HP products	17
Standards and legislation	18
Standards.....	18
Mandate 376 - EN 301 549	18
Web Content Accessibility Guidelines (WCAG).....	18
Legislation and regulations.....	19
Useful accessibility resources and links	19
Organizations	19
Educational institutions	19
Other disability resources	20
HP links.....	20
Contacting support.....	20
Index.....	21

1 About this guide

This guide provides basic information for using and upgrading this product.

-
-  **WARNING!** Indicates a hazardous situation that, if not avoided, **could** result in serious injury or death.
 -  **CAUTION:** Indicates a hazardous situation that, if not avoided, **could** result in minor or moderate injury.
 -  **IMPORTANT:** Indicates information considered important but not hazard-related (for example, messages related to property damage). Warns the user that failure to follow a procedure exactly as described could result in loss of data or in damage to hardware or software. Also contains essential information to explain a concept or to complete a task.
 -  **NOTE:** Contains additional information to emphasize or supplement important points of the main text.
 -  **TIP:** Provides helpful hints for completing a task.
-

2 Components

Your Chromebox™ features top-rated components. This chapter provides details about your components, where they are located, and how they work.

Right

Use the illustration and table to identify the components on the right side of the Chromebox.

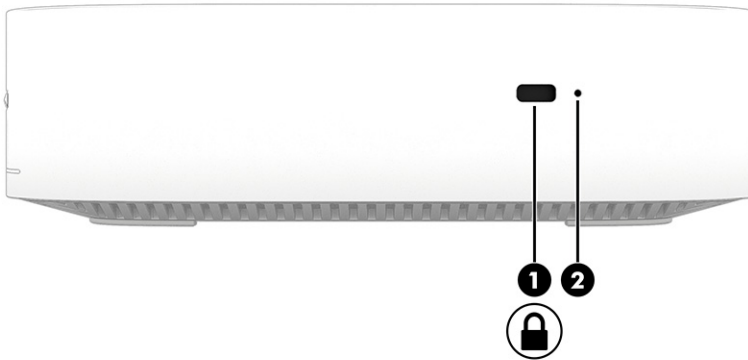



Table 21 Right-side components and their descriptions

Component	Description
(1)  Security cable slot	Attaches an optional security cable to the Chromebox. NOTE: The security cable is designed to act as a deterrent, but it might not prevent the Chromebox from being mishandled or stolen.
(2) Recovery button	When your Chromebox's operating system (OS) doesn't work properly, you can recover it. Recovery removes and reinstalls the OS. You can also recover the OS with an internet connection. See https://support.google.com/ for directions on performing the recovery process for your device. IMPORTANT: Recovery permanently erases everything on your Chromebox's hard drive, even your downloaded files. If possible, before you recover your Chromebook, back up your files.

Front

Use the illustration and table to identify the components on the front of the Chromebox.

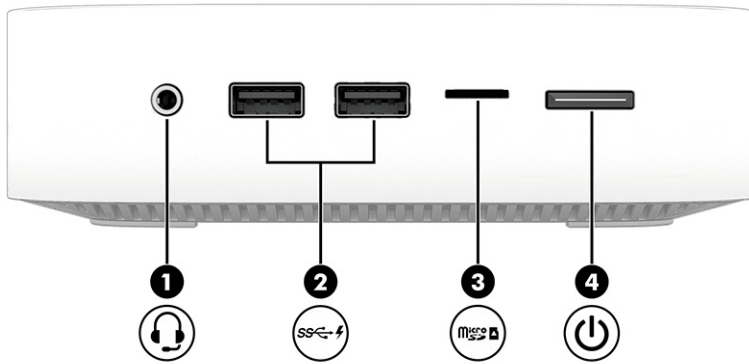

Table 2-2 Front-side components and their descriptions





Component	Description
(1)  Audio-out (headphone)/Audio-in (microphone) combo jack	Connects optional powered stereo speakers, headphones, earbuds, a headset, or a television audio cable. Also connects an optional headset microphone. This jack does not support optional standalone microphones. WARNING! To reduce the risk of personal injury, adjust the volume before putting on headphones, earbuds, or a headset. For additional safety information, see the <i>Regulatory, Safety, and Environmental Notices</i> . NOTE: When a device is connected to the jack, the computer speakers are disabled.
(2)  USB ports (2)	Connect a USB device, provide high-speed data transfer, and (for select products) charge small devices when the Chromebox is on or in Sleep mode.
(3)  microSD™ memory card reader	Reads optional memory cards that store, manage, share, or access information. To insert a card: <ol style="list-style-type: none"> 1. Hold the card label-side up, with the connectors facing the Chromebox. 2. Insert the card into the memory card reader, and then press in on the card until it is firmly seated. To remove a card: <ul style="list-style-type: none"> ■ Press in on the card, and then remove it from the memory card reader.

Table 2-2 Front-side components and their descriptions (continued)

Component	Description
(4)  Power button	<ul style="list-style-type: none"> When the Chromebox is off, press the button briefly to turn on the Chromebox. When the Chromebox is in the Sleep state, press the button briefly to exit Sleep (select products only). <p>NOTE: Chromebox has no Hibernation mode. The device cannot enter Sleep mode after pressing the power button briefly.</p> <p>IMPORTANT: Pressing and holding down the power button results in the loss of unsaved information.</p> <p>If the Chromebox has stopped responding and shutdown procedures are ineffective, press and hold the power button for at least 10 seconds to turn off the Chromebox.</p>

Rear

Use the illustration and table to identify the components on the rear of the Chromebox.

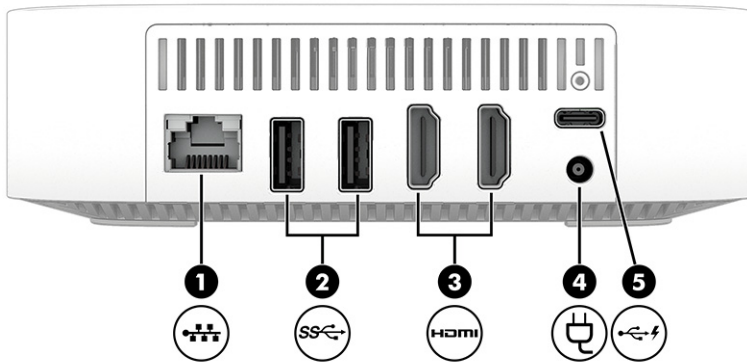

Table 2-3 Rear-side components and their descriptions





Component	Description
(1)  RJ-45 (network) jack	Connects a network cable.
(2)  USB ports (2)	<p>Connect a USB device, provide data transfer, and (for select products) charge small devices when the Chromebox is on or in Sleep mode.</p> <p>NOTE: Cables, adapters, or both (purchased separately) might be required.</p>
(3)  HDMI ports (2)	Connect an optional video or audio device, such as a high-definition television, any compatible digital or audio component, or a high-speed High Definition Multimedia Interface® (HDMI®) device.
(4)  AC adapter	Connects an AC adapter.

Table 2-3 Rear-side components and their descriptions (continued)

Component	Description
(5)  USB Type-C® port with HP Sleep and Charge	Connects a USB device, provides data transfer, and (for select products) charges small devices when the Chromebox is on or in Sleep mode.

Bottom

Use the illustration and table to identify the bottom components.

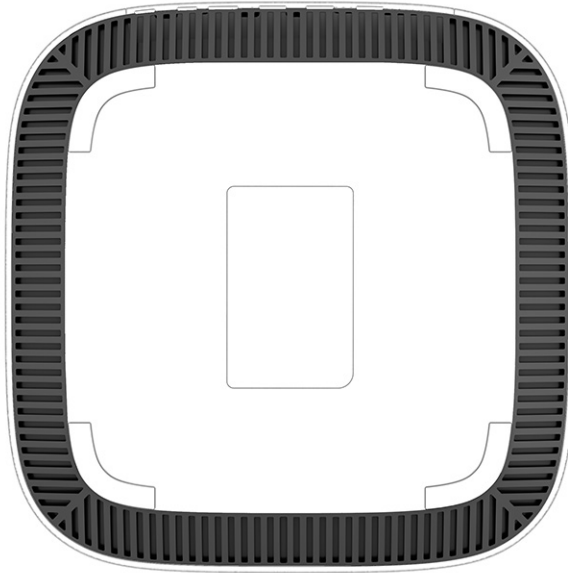



Table 2-4 Bottom component and description

Components	Description
Vent	Enables airflow to cool internal components. NOTE: The fan starts automatically to cool internal components and prevent overheating. It is normal for the internal fan to cycle on and off during routine operation.

Labels

The labels affixed to the computer provide information you might need when you troubleshoot system problems or travel internationally with the computer. Labels might be in paper form or imprinted on the product.

 **IMPORTANT:** Check the following locations for the labels described in this section: the bottom of the computer, inside the battery bay, under the service door, on the back of the display, or on the bottom of a tablet kickstand.

- Service label—Provides important information to identify your computer. When contacting support, you might be asked for the serial number, the product number, or the model number. Locate this information before you contact support.

Your service label will resemble one of the following examples. Refer to the illustration that most closely matches the service label on your computer.

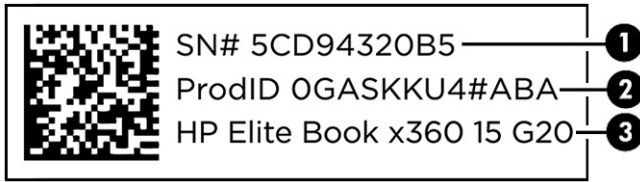

Table 2-5 Service label components

Component	
(1)	Serial number
(2)	Product ID
(3)	HP product name

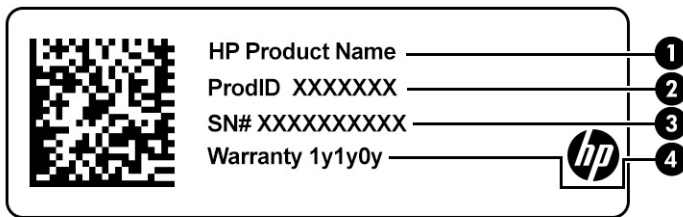

Table 2-6 Service label components

Component	
(1)	HP product name
(2)	Product ID
(3)	Serial number
(4)	Warranty period

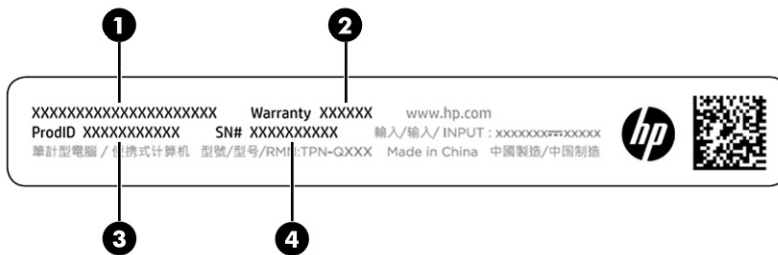

Table 2-7 Service label components

Component	
(1)	HP product name
(2)	Warranty period
(3)	Product ID
(4)	Serial number

- Regulatory labels—Provide regulatory information about the computer.
- Wireless certification labels—Provide information about optional wireless devices and the approval markings for the countries or regions where the devices have been approved for use.

3 Using your Chromebox

Use your Chromebox as an entertainment hub for such activities as managing music and downloading movies. In addition, you can connect external devices such as a monitor, projector, TV, speakers, or headphones to your Chromebox to make it an even more powerful entertainment center.

Using audio

On your device you can download and listen to music, stream audio content from the web (including radio), record audio, or mix audio and video to create multimedia. To enhance your listening enjoyment, attach external audio devices such as speakers or headphones.

Connecting speakers

You can attach wired speakers to your device by connecting them to a USB port or to the audio-out (headphone)/audio-in (microphone) combo jack on your device or on a docking station.

To connect wireless speakers to your device, follow the device manufacturer's instructions. To connect high-definition speakers to the device, see [Connecting an HDMI device on page 8](#). Before connecting speakers, lower the volume setting.

Connecting headphones

You can connect wired headphones to the headphone jack or to the audio-out (headphone)/audio-in (microphone) combo jack on your Chromebox.

 **WARNING!** To reduce the risk of personal injury, lower the volume setting before putting on headphones, earbuds, or a headset. For additional safety information, see the *Regulatory, Safety, and Environmental Notices* included with your documentation.

To connect wireless headphones to your Chromebox, follow the device manufacturer's instructions.

Using video

Your Chromebox is a powerful video device that enables you to watch streaming video from your favorite websites and download video and movies to watch later without needing to connect to a network.

Use one of the video ports on the device to connect an external monitor, projector, or TV. Your device has both a high-definition multimedia interface (HDMI) port, which allows you to connect a high-definition monitor or TV, and a DisplayPort™ interface, for connecting a DisplayPort-compatible device.

 **IMPORTANT:** Be sure that the external device is connected to the correct port on the Chromebox, using the correct cable. Follow the device manufacturer's instructions.

Connecting an HDMI device

To see the video image on a high-definition TV or monitor, connect the high-definition device according to the following instructions:

 **NOTE:** To connect an HDMI device to your Chromebox, you need an HDMI cable, sold separately.

1. Connect one end of the HDMI cable to the HDMI port on the Chromebox.

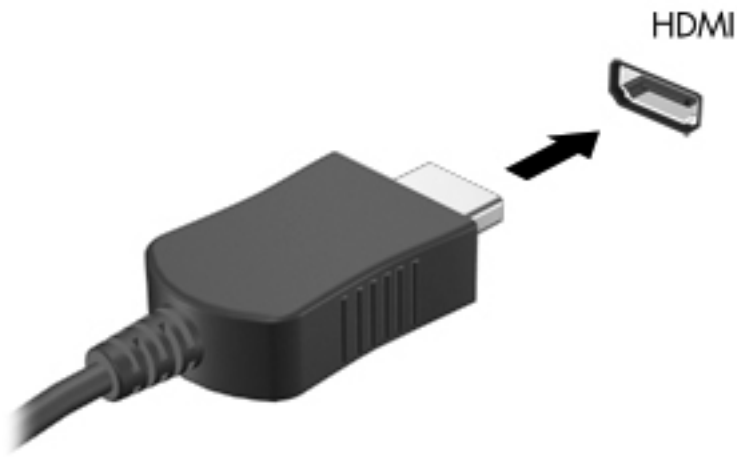

2. Connect the other end of the cable to the high-definition TV or monitor. You now see the Chrome™ desktop on your display device.

Connecting to a wireless network

To connect to a wireless network, use the following steps.

1. From the Chrome desktop, select the **Chrome menu** and then select **Wireless networks available**, or select the wireless icon in the status area on the lower-right side of the screen.
2. Select the wireless network you want to access and select **Connect**.
3. Provide passwords and encryption keys as prompted. A network protected with a password, encryption key, or both will be indicated by the secure connection icon. Contact your network administrator for more information, if needed.

Enabling and disabling Wake on LAN

Wake on LAN (WOL) is a function that allows your device to be turned on by a message sent across your local area network, or LAN.

 **NOTE:** Wake on LAN functions only when a LAN cable is attached. WOL resets to its default setting (WOL-enabled) after a system restart.

Accessing the WOL function requires initiating a recovery and entering developer mode. Be sure that all of your files are saved to the cloud or to an external drive before proceeding.

Turning WOL on or off

To turn this function on or off:

 **NOTE:** You can apply changes to Wake on LAN functions only when a LAN cable is attached. WOL will be reset to its default setting (WOL-enabled) after a system reboot. For further information and

updates, go to <http://www.hp.com/support> and select your country. Follow the on-screen instructions to find documentation relevant to your device.

1. You must enter developer mode to alter WOL settings. See <http://www.chromium.org/chromium-os/developer-information-for-chrome-os-devices> for directions about accessing developer mode on your device. The process for enabling and disabling WOL could change as the operating system is updated.
2. After initiating developer mode, the system restarts automatically, and you are prompted to set up your language and keyboard again and sign into your user account.
3. After you sign in, you see the Chrome desktop. From here, press `ctrl + alt + f2` or `ctrl + alt + →` to enter console mode.
4. On the console screen, type `root` and press `enter`.
5. At the next prompt, type `ethtool -s eth0 wol d` and press `enter` to disable the WOL function. To enable the WOL function, type `ethtool -s eth0 wol g` and press `enter`.
6. Press `ctrl + alt + f1` or `ctrl + alt + →` to return to the Chrome desktop.

Managing apps

You can expand the productivity and entertainment capabilities of your Chromebox with free or purchased apps that you can download directly to your device.

To find and install apps, go to the Chrome webstore. Using the store requires a Google account, but the store will maintain a list of every app you have ever installed, even if you've uninstalled them. This way, you'll never lose an app when you reformat the operating system. Apps update automatically, ensuring that you always have the most recent version installed.

- To open an app you've installed, select the Launcher icon and select the app from the list, or select the icon for the app you want from the apps pinned to the shelf at the bottom of the screen.
- To pin or unpin an app to the shelf on the main screen, select the Launcher icon, and select the app. Right-click the app, and then select **Pin to shelf**. To unpin an app, right-click it and select **Unpin**.
- To uninstall an app, select the Launcher icon, and select the app. Right-click the app, and then select **Remove from Chrome**.

For more information about managing apps, go to https://support.google.com/chrome_webstore/answer/1053346?hl=en.

4 Securing your Chromebox and information

Device security is essential for protecting the confidentiality, integrity, and availability of your information. Standard security solutions and third-party software can help protect your device from a variety of risks, such as viruses, worms, and other types of malicious code.

When you sign in to Chrome and enable sync, Chrome keeps your information secure by using your Google account credentials to encrypt your synced passwords. Alternatively, you can encrypt all of your synced data with a sync passphrase. This sync passphrase is stored on your device and isn't sent to Google. For more information about syncing your data, go to <https://support.google.com/chrome/answer/1181035?hl=en>.

 **IMPORTANT:** Some security features listed in this chapter might not be available on your device.

Table 4-1 Chromebox security options

Device risk	Security feature
Unauthorized use of the device	Power-on password
Viruses	Antivirus software
Ongoing or future threats to the device	Software updates
Unauthorized removal of the device	Security cable lock

Securing your wireless network

When you set up your wireless network, always enable security features.

Backing up your software applications and information

All apps update automatically, and a record of your downloads and purchases is kept on the Chrome Store. Google also saves your last synced settings automatically. If you must perform a recovery on your device, you can log in with your Google account and automatically retrieve all of your settings, favorites, and apps.

HP recommends that you save important documents and files either to a USB flash drive, memory card, external hard drive, or to Google Cloud™ storage. You can save your files to the cloud at any time by selecting the Google Drive as your file-save location.

Recovering your Chromebox

If you want to give your Chromebox to someone else, reset owner permissions, or solve problems with your account profile, you can clear all local user data by resetting your device.

 **NOTE:** Performing a factory reset deletes all information stored on your device, including permissions, settings, and user-owned files for all accounts. Resetting your device does not affect your accounts or any information synced to those accounts.

1. Select the status area in the lower-right corner.
2. Select **Settings**, and then select **Show advanced settings**.
3. Find the Powerwash section and select **Powerwash**.
4. After the dialog box opens, select **Restart**.

For more detailed information about resetting your Chromebox, see <https://support.google.com/chromebook/answer/183084>.

Using an optional security cable

A security cable lock, which you can purchase separately, is designed to act as a deterrent, but it might not prevent the device from being mishandled or stolen. Security cables are only one of several methods that you should use as part of a complete security system to help maximize theft prevention.

The security cable slot on your Chromebox might look slightly different from the illustration in this section. For the location of the security cable slot on your device, see [Components on page 2](#).

1. Loop the security cable lock around a secured object.
2. Insert the key (1) into the security cable lock (2).
3. Insert the security cable lock into the security cable slot on the device (3), and then lock the security cable lock with the key.

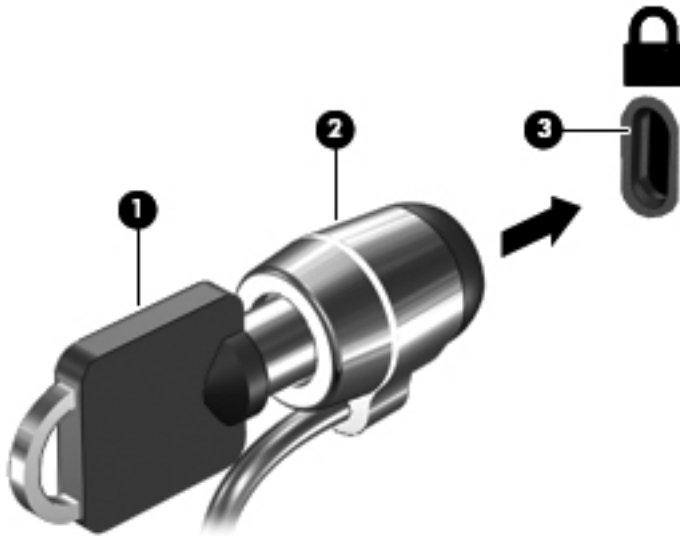

4. Remove the key and keep it in a safe place.

5 Printing

You have several ways to print from your computer.

- Print with built-in ChromeOS solution.
- Print from Google Chrome using the HP Print for Chrome app.



NOTE: If you use HP Print for Chrome, you cannot register the printer with the Google ChromeOS printing solution.

Printing with built-in ChromeOS solution

Google Chrome has a built-in printing solution for Chromeboxes™. HP printers produced in 2017 and later are supported automatically. For more information, see the Google Chrome support website.

1. Go to <https://support.google.com/chrome>.
2. Select the search icon, type `set up printer`, and then select **Set up printer**.



NOTE: Do not press `enter`.

3. Follow the on-screen instructions.

Printing from Google Chrome

For an alternate method to print from Google Chrome, use the HP Print for Chrome app. You can install the HP Print for Chrome app from the Chrome Web Store. For more information, see the HP website.

1. Go to <http://www.hp.com/support>.
2. Select the search icon at the upper right of the page, type `Printing with the HP Print for Chrome App`, and then press `enter`.
3. Follow the on-screen instructions.

6 More HP resources

To locate resources that provide product details, how-to information, and more, use this table.

Table 6-1 Additional information

Resource	Contents
<i>Setup Instructions</i>	<ul style="list-style-type: none">• How to set up the computer• Help to identify computer components
<i>HP Support Assistant</i> app (select products only) Install HP Support Assistant to get access to HP tools and troubleshooting for printers and peripherals. Go to the Chrome Web Store and install the HP Support Assistant app.	<ul style="list-style-type: none">• Optimizes computer performance and resolves problems using the latest software updates, diagnostic tools, and guided assistance
HP website To access the latest user guide, go to http://www.hp.com/support , and follow the instructions to find your product. Then select Manuals .	<ul style="list-style-type: none">• Support information• Ordering parts and finding additional help• Accessories available for the device
Worldwide support To get support in your language, go to http://www.hp.com/support , and select your country.	<ul style="list-style-type: none">• Online chat with an HP technician• Support telephone numbers• HP service center locations
<i>Safety & Comfort Guide</i> Go to http://www.hp.com/ergo .	<ul style="list-style-type: none">• Proper workstation setup• Guidelines for posture and work habits that increase comfort and decrease risk of injury• Electrical and mechanical safety information
<i>Regulatory, Safety, and Environmental Notices</i> This guide is provided in the box.	<ul style="list-style-type: none">• Regulatory and safety information• Battery disposal information
<i>Limited Warranty*</i> Go to http://www.hp.com/go/orderdocuments .	<ul style="list-style-type: none">• Warranty information

*You can find your HP Limited Warranty located with the user guides on your product and/or on the CD or DVD provided in the box. In some countries or regions, HP may provide a printed warranty in the box. For countries or regions where the warranty is not provided in printed format, you can request a copy from <http://www.hp.com/go/orderdocuments>. For products purchased in Asia Pacific, you can write to HP at POD, PO Box 161, Kitchener Road Post Office, Singapore 912006. Include your product name, and your name, phone number, and postal address.

7 Electrostatic discharge

Electrostatic discharge is the release of static electricity when two objects come into contact—for example, the shock you receive when you walk across the carpet and touch a metal door knob.

A discharge of static electricity from fingers or other electrostatic conductors may damage electronic components.

 **IMPORTANT:** To prevent damage to the computer, damage to a drive, or loss of information, observe these precautions:

- If removal or installation instructions direct you to unplug the computer, first be sure that it is properly grounded.
 - Keep components in their electrostatic-safe containers until you are ready to install them.
 - Avoid touching pins, leads, and circuitry. Handle electronic components as little as possible.
 - Use nonmagnetic tools.
 - Before handling components, discharge static electricity by touching an unpainted metal surface.
 - If you remove a component, place it in an electrostatic-safe container.
-

8 Accessibility

HP's goal is to design, produce, and market products, services, and information that everyone everywhere can use, either on a standalone basis or with appropriate third-party assistive technology (AT) devices or applications.

HP and accessibility

Because HP works to weave diversity, inclusion, and work/life into the fabric of the company, it is reflected in everything HP does. HP strives to create an inclusive environment focused on connecting people to the power of technology throughout the world.

Finding the technology tools you need

Technology can unleash your human potential. Assistive technology removes barriers and helps you create independence at home, at work, and in the community. Assistive technology helps increase, maintain, and improve the functional capabilities of electronic and information technology.

For more information, see [Finding the best assistive technology on page 17](#).

The HP commitment

HP is committed to providing products and services that are accessible for people with disabilities. This commitment supports the company's diversity objectives and helps ensure that the benefits of technology are available to all.

The HP accessibility goal is to design, produce, and market products and services that can be effectively used by everyone, including people with disabilities, either on a standalone basis or with appropriate assistive devices.

To achieve that goal, this Accessibility Policy establishes seven key objectives to guide HP actions. All HP managers and employees are expected to support these objectives and their implementation in accordance with their roles and responsibilities:

- Raise the level of awareness of accessibility issues within HP, and provide employees with the training they need to design, produce, market, and deliver accessible products and services.
- Develop accessibility guidelines for products and services, and hold product development groups accountable for implementing these guidelines where competitively, technically, and economically feasible.
- Involve people with disabilities in the development of accessibility guidelines and in the design and testing of products and services.
- Document accessibility features, and make information about HP products and services publicly available in an accessible form.
- Establish relationships with leading assistive technology and solution providers.
- Support internal and external research and development that improves assistive technology relevant to HP products and services.

- Support and contribute to industry standards and guidelines for accessibility.

International Association of Accessibility Professionals (IAAP)

IAAP is a not-for-profit association focused on advancing the accessibility profession through networking, education, and certification. The objective is to help accessibility professionals develop and advance their careers and to better enable organizations to integrate accessibility into their products and infrastructure.

As a founding member, HP joined to participate with other organizations to advance the field of accessibility. This commitment supports HP's accessibility goal of designing, producing, and marketing products and services that people with disabilities can effectively use.

IAAP will make the profession strong by globally connecting individuals, students, and organizations to learn from one another. If you are interested in learning more, go to <http://www.accessibilityassociation.org> to join the online community, sign up for newsletters, and learn about membership options.

Finding the best assistive technology

Everyone, including people with disabilities or age-related limitations, should be able to communicate, express themselves, and connect with the world using technology. HP is committed to increasing accessibility awareness within HP and with our customers and partners.

Whether it's large fonts that are easy on the eyes, voice recognition that lets you give your hands a rest, or any other assistive technology to help with your specific situation—a variety of assistive technologies make HP products easier to use. How do you choose?

Assessing your needs

Technology can unleash your potential. Assistive technology removes barriers and helps you create independence at home, at work, and in the community. Assistive technology (AT) helps increase, maintain, and improve the functional capabilities of electronic and information technology.

You can choose from many AT products. Your AT assessment should allow you to evaluate several products, answer your questions, and facilitate your selection of the best solution for your situation. You will find that professionals qualified to do AT assessments come from many fields, including those licensed or certified in physical therapy, occupational therapy, speech/language pathology, and other areas of expertise. Others, while not certified or licensed, can also provide evaluation information. You will want to ask about the individual's experience, expertise, and fees to determine if they are appropriate for your needs.

Accessibility for HP products

These links provide information about accessibility features and assistive technology, if applicable and available in your country or region, that are included in various HP products. These resources will help you select the specific assistive technology features and products most appropriate for your situation.

- HP Aging & Accessibility: Go to <http://www.hp.com>, type **Accessibility** in the search box. Select **Office of Aging and Accessibility**.
- HP computers: For Windows products, go to <http://www.hp.com/support>, type **Windows Accessibility Options** in the **Search our knowledge** search box. Select the appropriate operating system in the results.
- HP Shopping, peripherals for HP products: Go to <http://store.hp.com>, select **Shop**, and then select **Monitors** or **Accessories**.

If you need additional support with the accessibility features on your HP product, see [Contacting support on page 20](#).

Additional links to external partners and suppliers that may provide additional assistance:

- [Microsoft Accessibility information \(Windows and Microsoft Office\)](#)
- [Google Products accessibility information \(Android, Chrome, Google Apps\)](#)

Standards and legislation

Countries worldwide are enacting regulations to improve access to products and services for persons with disabilities. These regulations are historically applicable to telecommunications products and services, PCs and printers with certain communications and video playback features, their associated user documentation, and their customer support.

Standards

The US Access Board created Section 508 of the Federal Acquisition Regulation (FAR) standards to address access to information and communication technology (ICT) for people with physical, sensory, or cognitive disabilities.

The standards contain technical criteria specific to various types of technologies, as well as performance-based requirements which focus on functional capabilities of covered products. Specific criteria cover software applications and operating systems, web-based information and applications, computers, telecommunications products, video and multimedia, and self-contained closed products.

Mandate 376 – EN 301 549

The European Union created the EN 301 549 standard within Mandate 376 as an online toolkit for public procurement of ICT products. The standard specifies the accessibility requirements applicable to ICT products and services, with a description of the test procedures and evaluation methodology for each requirement.

Web Content Accessibility Guidelines (WCAG)

Web Content Accessibility Guidelines (WCAG) from the W3C's Web Accessibility Initiative (WAI) helps web designers and developers create sites that better meet the needs of people with disabilities or age-related limitations.

WCAG advances accessibility across the full range of web content (text, images, audio, and video) and web applications. WCAG can be precisely tested, is easy to understand and use, and allows web developers flexibility for innovation. WCAG 2.0 has also been approved as [ISO/IEC 40500:2012](#).

WCAG specifically addresses barriers to accessing the web experienced by people with visual, auditory, physical, cognitive, and neurological disabilities, and by older web users with accessibility needs. WCAG 2.0 provides characteristics of accessible content:

- **Perceivable** (for instance, by addressing text alternatives for images, captions for audio, adaptability of presentation, and color contrast)
- **Operable** (by addressing keyboard access, color contrast, timing of input, seizure avoidance, and navigability)
- **Understandable** (by addressing readability, predictability, and input assistance)
- **Robust** (for instance, by addressing compatibility with assistive technologies)

Legislation and regulations

Accessibility of IT and information has become an area of increasing legislative importance.

The [HP policy landscape](#) website provides information about key legislation, regulations, and standards in the following locations:

- United States
- Canada
- Europe
- Australia

Useful accessibility resources and links

These organizations, institutions, and resources might be good sources of information about disabilities and age-related limitations.



NOTE: This is not an exhaustive list. These organizations are provided for informational purposes only. HP assumes no responsibility for information or contacts you encounter on the internet. Listing on this page does not imply endorsement by HP.

Organizations

These organizations are a few of the many that provide information about disabilities and age-related limitations.

- American Association of People with Disabilities (AAPD)
- The Association of Assistive Technology Act Programs (ATAP)
- Hearing Loss Association of America (HLAA)
- Information Technology Technical Assistance and Training Center (ITTATC)
- Lighthouse International
- National Association of the Deaf
- National Federation of the Blind
- Rehabilitation Engineering & Assistive Technology Society of North America (RESNA)
- Telecommunications for the Deaf and Hard of Hearing, Inc. (TDI)
- W3C Web Accessibility Initiative (WAI)

Educational institutions

Many educational institutions, including these examples, provide information about disabilities and age-related limitations.

- California State University, Northridge, Center on Disabilities (CSUN)
- University of Wisconsin - Madison, Trace Center

- University of Minnesota computer accommodations program

Other disability resources

Many resources, including these examples, provide information about disabilities and age-related limitations.

- ADA (Americans with Disabilities Act) Technical Assistance Program
- ILO Global Business and Disability network
- EnableMart
- European Disability Forum
- Job Accommodation Network
- Microsoft Enable

HP links

These HP-specific links provide information that relates to disabilities and age-related limitations.

[HP comfort and safety guide](#)

[HP public sector sales](#)

Contacting support

HP offers technical support and assistance with accessibility options for customers with disabilities.



NOTE: Support is in English only.

- Customers who are deaf or hard of hearing who have questions about technical support or accessibility of HP products:
 - Use TRS/VRS/WebCapTel to call (877) 656-7058 Monday through Friday, 6 a.m. to 9 p.m. Mountain Time.
- Customers with other disabilities or age-related limitations who have questions about technical support or accessibility of HP products:
 - Call (888) 259-5707 Monday through Friday, 6 a.m. to 9 p.m. Mountain Time.

Index

A

- AC adapter 4
- accessibility 16, 17, 19, 20
- accessibility needs
 - assessment 17
- assistive technology (AT)
 - finding 17
 - purpose 16
- AT (assistive technology)
 - finding 17
 - purpose 16
- audio 8
 - headphones 8
 - speakers 8
- audio-in (microphone) jack,
 - identifying 3
- audio-out (headphone) jack,
 - identifying 3

B

- Bluetooth device 9, 10
- Bluetooth label 5
- buttons
 - power 4
- buttons, recovery 2

C

- components
 - bottom 5
 - front side 2
 - rear side 4
 - right side 2
- connecting to a wireless network 9, 10
- customer support,
 - accessibility 20

E

- electrostatic discharge 15

H

- headphone (audio-out) jack 3
- headphones, connecting 8
- HP Assistive Policy 16
- HPSA, identifying 14

I

- International Association of Accessibility Professionals 17

J

- jack, RJ-45 network, identifying 4
- jacks
 - audio-in (microphone) 3
 - audio-out (headphone) 3

L

- labels
 - Bluetooth 5
 - regulatory 5
 - serial number 5
 - service 5
 - wireless certification 5
 - WLAN 5

M

- micro memory card reader,
 - identifying 3
- microphone (audio-in) jack,
 - identifying 3

P

- ports 3
 - USB SuperSpeed 4
 - USB Type-C with HP Sleep and Charge 5
- power button, identifying 4
- printing 13
- product name and number,
 - computer 5

R

- recovery button, identifying 2
- regulatory information
 - regulatory label 5
 - wireless certification labels 5
- resources, accessibility 19

S

- Section 508 accessibility standards 18

- security cable slot, identifying 2
- serial number, computer 5
- service labels, locating 5
- slots
 - security cable 2
- sound
 - See* audio
- speakers
 - connecting 8
- standards and legislation,
 - accessibility 18
- support 14

T

- traveling with the computer 5

U

- USB port 3
- USB port, identifying 3, 4
- USB Type-C port with HP Sleep and Charge, identifying 5

V

- vent, identifying 5
- video, using 8

W

- wireless certification label 5
- WLAN device 5
- WLAN label 5