

# **dji** AIR 3

## User Manual

v1.2 2023.09

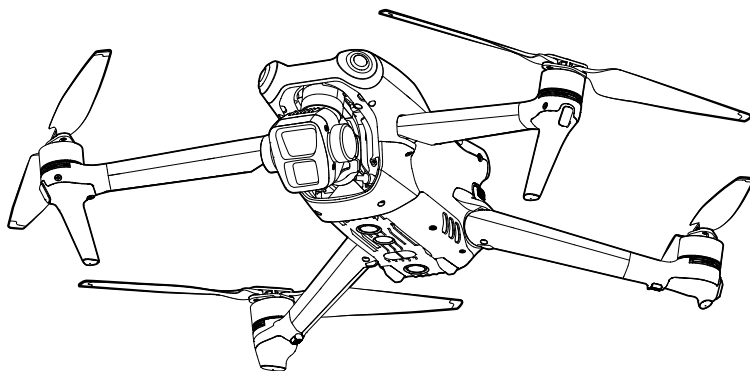



This document is copyrighted by DJI with all rights reserved. Unless otherwise authorized by DJI, you are not eligible to use or allow others to use the document or any part of the document by reproducing, transferring or selling the document. Users should only refer to this document and the content thereof as instructions to operate DJI UAV. The document should not be used for other purposes.

### **Searching for Keywords**

Search for keywords such as “battery” and “install” to find a topic. If you are using Adobe Acrobat Reader to read this document, press Ctrl+F on Windows or Command+F on Mac to begin a search.

### **Navigating to a Topic**

View a complete list of topics in the table of contents. Click on a topic to navigate to that section.

### **Printing this Document**

This document supports high resolution printing.

## Revision Log

| Version | Date    | Revisions   |
|---------|---------|---|
| v1.2    | 2023.09 | Added support for AR RTH and taking 5 48MP photos when using AEB and Burst Shooting, etc. |

# Using this Manual

## Legend

⚠ Important

💡 Hints and Tips

📖 Reference

## Read Before the First Flight

Read the following documents before using the DJI™ Air 3:

1. Safety Guidelines
2. Quick Start Guide
3. User Manual

It is recommended to watch all tutorial videos on the official DJI website and read safety guidelines before using for the first time. Prepare for your first flight by reviewing the quick start guide and refer to this user manual for more information.

## Video Tutorials

Go to the address below or scan the QR code to watch the DJI Air 3 tutorial videos, which demonstrate how to use the Air 3 safely.



<https://s.dji.com/guide58>

## Download the DJI Fly App

Make sure to use DJI Fly during flight. Scan the QR code above to download the latest version.

- ⚠ • The DJI RC 2 remote controller has the DJI Fly app already installed. Users are required to download DJI Fly to their mobile device when using DJI RC-N2 remote controller.
- The Android version of DJI Fly is compatible with Android v7.0 and later. The iOS version of DJI Fly is compatible with iOS v11.0 and later.

\* For increased safety, flight is restricted to a height of 98.4 ft (30 m) and a range of 164 ft (50 m) when not connected or logged into the app during flight. This applies to DJI Fly and all apps compatible with DJI aircraft.

## Download DJI Assistant 2 (Consumer Drones Series)

Download DJI ASSISTANT™ 2 (Consumer Drones Series) at <https://www.dji.com/air-3/downloads>.

- 
-  • The operating temperature of this product is -10° to 40° C. It does not meet the standard operating temperature for military grade application (-55° to 125° C), which is required to endure greater environmental variability. Operate the product appropriately and only for applications that it meets the operating temperature range requirements of that grade.
-

# Contents

|   |           |
|---|-----------|
| <b>Using this Manual</b>                          | <b>3</b>  |
| Legend  | 3         |
| Read Before the First Flight                      | 3         |
| Video Tutorials                                   | 3         |
| Download the DJI Fly App                          | 3         |
| Download DJI Assistant 2 (Consumer Drones Series) | 4         |
| <b>Product Profile</b>                            | <b>10</b> |
| Introduction                                      | 10        |
| Feature Highlights                                | 10        |
| Using for the First Time                          | 11        |
| Preparing the Aircraft                            | 11        |
| Preparing the Remote Controller                   | 14        |
| Activating the DJI Air 3 Aircraft                 | 15        |
| Binding the Aircraft and Remote Controller        | 15        |
| Updating Firmware                                 | 15        |
| Diagram   | 16        |
| Aircraft  | 16        |
| DJI RC 2 Remote Controller                        | 17        |
| DJI RC-N2 Remote Controller                       | 19        |
| <b>Flight Safety</b>                              | <b>21</b> |
| Flight Environment Requirements                   | 21        |
| Operating the Aircraft Responsibly                | 22        |
| Flight Limits                                     | 22        |
| GEO (Geospatial Environment Online) System        | 22        |
| Flight Limits                                     | 22        |
| Unlocking GEO Zones                               | 24        |
| Pre-Flight Checklist                              | 24        |
| Basic Flight                                      | 25        |
| Auto Takeoff/Landing                              | 25        |
| Starting/Stopping the Motors                      | 26        |
| Controlling the Aircraft                          | 27        |
| Takeoff/Landing Procedures                        | 28        |
| Video Suggestions and Tips                        | 28        |

|  |           |
|--|-----------|
| Intelligent Flight Mode                                      | 29        |
| FocusTrack   | 29        |
| MasterShots  | 34        |
| QuickShots   | 35        |
| Hyperlapse   | 37        |
| Waypoint Flight  | 39        |
| Cruise Control   | 44        |
| <b>Aircraft</b>  | <b>47</b> |
| Flight Modes   | 47        |
| Aircraft Status Indicator                                    | 48        |
| Return to Home   | 49        |
| Advanced RTH   | 50        |
| Landing Protection   | 54        |
| Precision Landing  | 54        |
| Vision Systems and Three-Dimensional Infrared Sensing System | 55        |
| Detection Range  | 55        |
| Using the Vision Systems                                     | 56        |
| Advanced Pilot Assistance Systems (APAS)                     | 58        |
| Landing Protection   | 58        |
| Flight Recorder  | 59        |
| Propellers   | 59        |
| Attaching the Propellers                                     | 59        |
| Detaching the Propellers                                     | 60        |
| Intelligent Flight Battery                                   | 60        |
| Battery Features   | 60        |
| Using the Battery  | 61        |
| Charging the Battery   | 62        |
| Inserting the Intelligent Flight Battery                     | 67        |
| Removing the Intelligent Flight Battery                      | 67        |
| Gimbal and Camera  | 68        |
| Gimbal Profile   | 68        |
| Gimbal Operation Mode  | 68        |
| Camera Profile   | 69        |
| Storing and Exporting Photos and Videos                      | 70        |

|  |           |
|--|-----------|
| QuickTransfer                                  | 71        |
| Usage  | 71        |
| <b>Remote Controller</b>                       | <b>73</b> |
| DJI RC 2                                       | 73        |
| Operation                                      | 73        |
| Remote Controller LEDs                         | 78        |
| Remote Controller Alert                        | 78        |
| Optimal Transmission Zone                      | 78        |
| Linking the Remote Controller                  | 79        |
| Operating the Touchscreen                      | 80        |
| Advanced Features                              | 82        |
| DJI RC-N2                                      | 82        |
| Operation                                      | 82        |
| Remote Controller Alert                        | 86        |
| Optimal Transmission Zone                      | 86        |
| Linking the Remote Controller                  | 87        |
| <b>DJI Fly App</b>                             | <b>89</b> |
| Home   | 89        |
| Camera View                                    | 90        |
| Button Descriptions                            | 90        |
| Screen Shortcuts                               | 94        |
| Settings                                       | 94        |
| Safety   | 94        |
| Control  | 95        |
| Camera   | 96        |
| Transmission                                   | 97        |
| About  | 97        |
| <b>Appendix</b>                                | <b>99</b> |
| Specifications                                 | 99        |
| Camera Function Matrix                         | 106       |
| Firmware Update                                | 107       |
| Using DJI Fly                                  | 107       |
| Using DJI Assistant 2 (Consumer Drones Series) | 107       |

|                                      |     |
|--------------------------------------|-----|
| Post-Flight Checklist                | 108 |
| Maintenance Instructions             | 108 |
| Troubleshooting Procedures           | 109 |
| Risk and Warnings                    | 110 |
| Disposal                             | 110 |
| C1 Certification                     | 110 |
| FAR Remote ID Compliance Information | 115 |
| Aftersales Information               | 115 |



# Product Profile

---

This section introduces DJI Air 3 and lists the components of the aircraft and remote controller.

# Product Profile

## Introduction

DJI Air 3 features both an omnidirectional vision system and a three-dimensional infrared sensing system, capable of hovering and flying indoors and outdoors, and can automatically Return to Home while sensing and bypassing obstacles in all directions. The aircraft has a maximum flight speed of 47 mph (75.6 kph) and a maximum flight time of 46 minutes.

DJI Air 3 can work with both the DJI RC 2 and DJI RC-N2 remote controllers. Refer to the Remote Controller chapter for more information.

## Feature Highlights

**Gimbal and Camera:** DJI Air 3 is equipped with a dual-camera system with 1/1.3-inch sensors. In addition to the 24mm F1.7 wide-angle camera, a 70mm F2.8 medium tele camera has been added. Both cameras support shooting 48MP photos and 4K/60fps videos, and support 10-bit D-Log M color mode. The wide-angle camera supports up to 3x zoom while the medium tele camera supports up to 9x zoom.

**Video Transmission:** With DJI's long-range transmission O4 (OCUSYNC 4.0) technology, DJI Air 3 offers a maximum transmission range of 20 km and video quality at up to 1080p 60fps from the aircraft to the DJI Fly app. The remote controller works at 2.4, 5.8, and 5.1 GHz and is capable of selecting the best transmission channel automatically.

**Intelligent Flight Modes:** With the Advanced Pilot Assistance System (APAS), the aircraft can quickly sense and bypass obstacles in all directions while the user is operating the aircraft for a safer flight and smoother footage. Intelligent Flight Modes such as FocusTrack, MasterShots, QuickShots, Hyperlapse, and Waypoint Flight enable users to capture cinematic videos effortlessly.

- 
- ⚠ • The maximum flight speed was tested at sea level altitude without wind. The maximum flight time was tested in an environment without wind while flying at a consistent flight speed of 17.9 mph (28.8 kph).
  - The remote control devices reach their maximum transmission distance (FCC) in a wide open area with no electromagnetic interference at an altitude of about 120 m (400 ft). The maximum transmission distance refers to the maximum distance that the aircraft can still send and receive transmissions. It does not refer to the maximum distance the aircraft can fly in a single flight.
  - 5.8 GHz is not supported in certain regions. Observe local laws and regulations.
  - 5.1 GHz can be used only in countries and regions where it is permitted by local laws and regulations.
  - The maximum flight speed is 42.5 mph (68.4 kph) in EU and 47 mph (75.6 kph) for other countries and regions.
-

## Using for the First Time



Visit the link below to watch the tutorial video before first time use.



<https://s.dji.com/guide58>

### Preparing the Aircraft

All aircraft arms are folded before the aircraft is packaged. Follow the steps below to unfold the aircraft.

1. Remove the gimbal protector.

First turn over the aircraft. Press down the gimbal protector slightly to release the clips from the notches at the bottom of the aircraft body ①, then remove the gimbal protector ②.

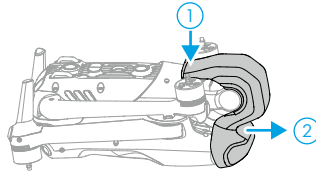

2. All Intelligent Flight Batteries are in hibernation mode before shipment to ensure safety. Charge to activate the batteries for the first time. There is no charger included in the package. It is recommended to use the DJI 65W Portable Charger or the DJI 100W USB-C Power Adapter. Users can also use other USB Power Delivery chargers. The battery is activated when it begins charging.
  - a. If connecting the DJI 65W Portable Charger or the DJI 100W USB-C Power Adapter to the USB-C connector on the aircraft, it takes approximately 1 hour and 20 minutes to fully charge an Intelligent Flight Battery mounted on the aircraft.

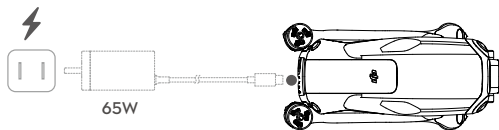

or

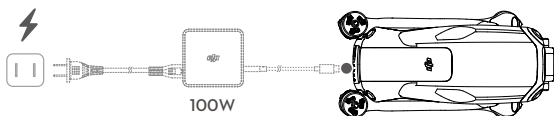

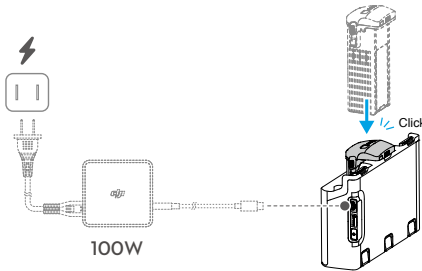

- b. If connecting the DJI 100W USB-C Power Adapter to the DJI Air 3 Battery Charging Hub, it takes approximately 1 hour to fully charge an Intelligent Flight Battery inserted into the charging hub.

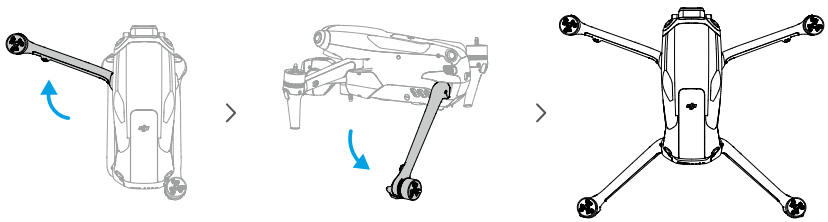

- 3. Unfold the front arms before unfolding the rear arms.



- 4. Attach the Propellers.

There are two types of propellers in the package of DJI Air 3, which are propellers A and propellers B. The packaging of the two propeller types is labeled with A and B respectively, together with the installation location illustrations. Attach propellers A with grey circle markings to the motors with grey markings. Likewise, attach propellers B without markings to the motors without markings. Hold the motor with one hand, press the propeller down with the other hand, and rotate in the direction  /  marked on the propeller until it pops up and locks in place. Unfold the propeller blades.

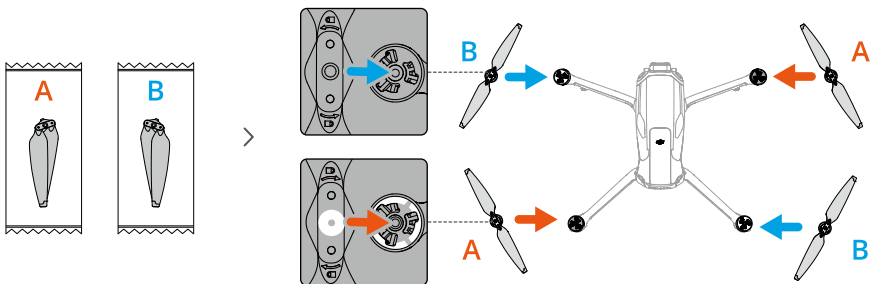

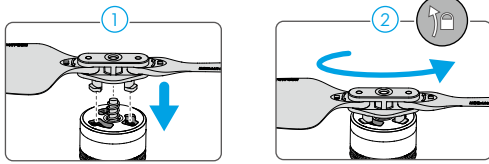

- ⚠ • It is recommended to use official DJI chargers to charge the Intelligent Flight Batteries, such as the DJI 65W Portable Charger or the DJI 100W USB-C Power Adapter. If you use chargers that are not officially provided by DJI, even if their maximum output power meets the requirements, they may not be able to maintain the maximum power output during the whole charging process due to the limitation of the charger's thermal performance, so the charger may overheat and the charging speed may slow down.
- When charging the battery mounted to the aircraft, the maximum charging power supported is 65 W. Therefore, it takes the same amount of time when using the DJI 65W Portable Charger or the DJI 100W USB-C Power Adapter to fully charge a battery mounted to the aircraft, which is 1 hour and 20 minutes.
- Make sure to unfold the front arms before unfolding the rear arms.
- Make sure the gimbal protector is removed and all arms are unfolded before powering on the aircraft. Otherwise, it may affect the aircraft self-diagnostics.
- It is recommended to attach the gimbal protector to protect the gimbal when the aircraft is not in use. First turn over the aircraft and rotate the camera to make it horizontal and forward-facing. To attach the gimbal protector, first insert the two clips on the gimbal protector into the two notches at the bottom of the aircraft nose ① , make sure the curved shape of the gimbal protector fits with the gimbal pitch axis ② , and then slightly press down the gimbal protector to insert the clips into the two notches at the bottom of the aircraft body ③ .

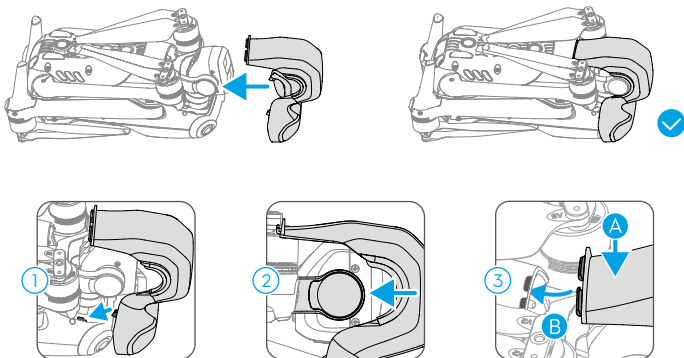

- Make sure to place the propellers of the front arms into the two dents on both sides of the aircraft back. DO NOT push the propeller blades onto the back of the aircraft, which may cause the propeller blades to deform.

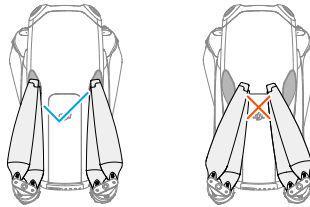

---

## Preparing the Remote Controller

Follow the steps below to prepare the DJI RC 2 remote controller.

1. Remove the control sticks from the storage slots and mount them on the remote controller.

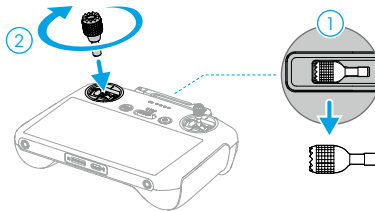

2. Unfold the antennas.

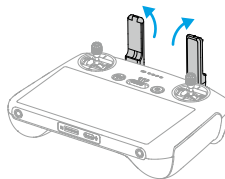

3. The remote controller needs to be activated before first use and an internet connection is required for activation. Press, and then press again and hold the power button to power on the remote controller. Follow the on-screen prompts to activate the remote controller.

Follow the steps below to prepare the DJI RC-N2 remote controller.

1. Remove the control sticks from the storage slots and mount them on the remote controller.
2. Pull out the mobile device holder. Choose the appropriate remote controller cable based on the port type of your mobile device (a Lightning connector cable and a USB-C cable are included in the packaging). Place your mobile device in the holder, then connect the end of the cable without the remote controller logo to your mobile device. Make sure your mobile device is securely in place.

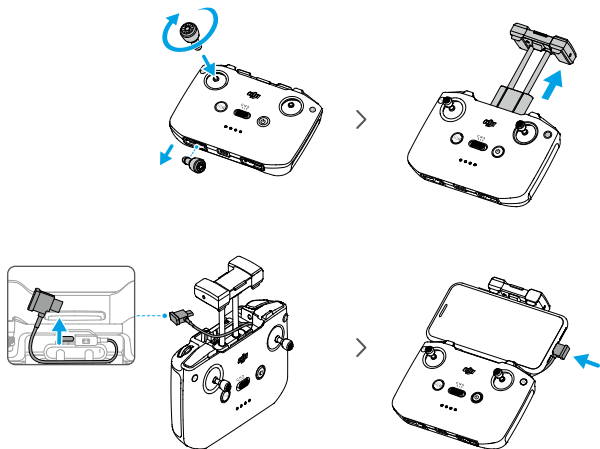

**⚠** • If a USB connection prompt appears when an Android mobile device is used, select the option to charge only. Other options may cause the connection to fail.

## Activating the DJI Air 3 Aircraft

DJI Air 3 requires activation before first use. Press, and then press again and hold the power button to power on the aircraft and remote controller respectively, and then follow the on-screen prompts to activate DJI Air 3 using DJI Fly. An internet connection is required for activation.

## Binding the Aircraft and Remote Controller

After activation, the aircraft is bound to the remote controller automatically. If automatic binding fails, follow the on-screen prompts on DJI Fly to bind the aircraft and remote controller for optimal warranty services.

## Updating Firmware

A prompt will appear in DJI Fly when new firmware is available. Update the firmware whenever prompted to ensure optimal user experience.

## Diagram

### Aircraft

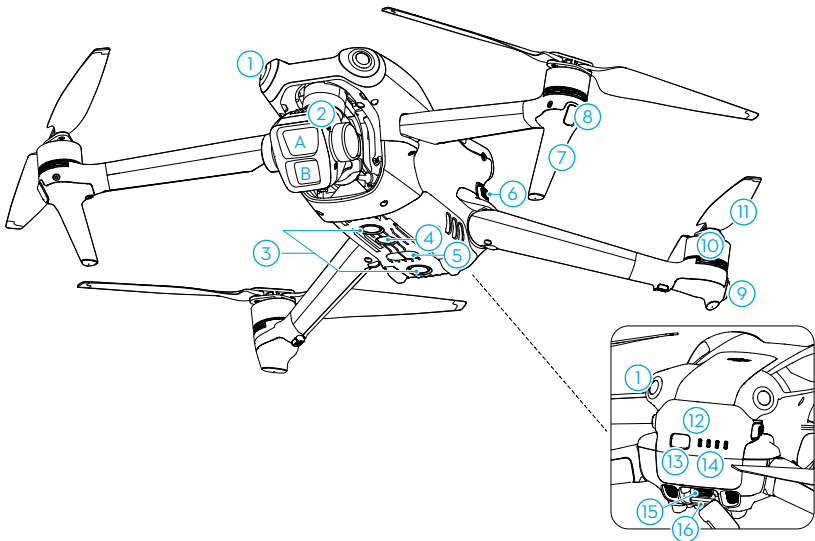

- |   |                                |
|---|--------------------------------|
| 1. Omnidirectional Vision System <sup>[1]</sup> | 8. Front LEDs                  |
| 2. Gimbal and Camera                            | 9. Aircraft Status Indicators  |
| A. Medium Tele Camera                           | 10. Motors                     |
| B. Wide-angle Camera                            | 11. Propellers                 |
| 3. Downward Vision System                       | 12. Intelligent Flight Battery |
| 4. Auxiliary Light                              | 13. Power Button               |
| 5. Three-Dimensional Infrared Sensing System    | 14. Battery Level LEDs         |
| 6. Battery Buckles                              | 15. USB-C Port                 |
| 7. Landing Gears (Built-in antennas)            | 16. microSD Card Slot          |

[1] The omnidirectional vision system can sense obstacles in horizontal directions and above.



## DJI RC 2 Remote Controller

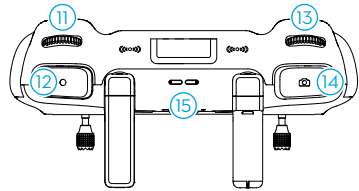
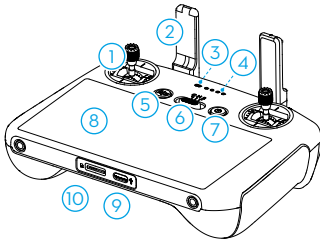

### 1. Control Sticks

Use the control sticks to control the movement of the aircraft. The control sticks are removable and easy to store. Set the flight control mode in DJI Fly.

### 2. Antennas

Relay aircraft control and video wireless signals.

### 3. Status LED

Indicates the status of the remote controller.

### 4. Battery Level LEDs

Displays the current battery level of the remote controller.

### 5. Flight Pause/Return to Home (RTH) Button

Press once to make the aircraft brake and hover in place (only when GNSS or Vision Systems are available). Press and hold to initiate RTH. Press again to cancel RTH.

### 6. Flight Mode Switch

Switch between Cine, Normal, and Sport mode.

### 7. Power Button

Press once to check the current battery

level. Press, and then press and hold to power the remote controller on or off. When the remote controller is powered on, press once to turn the touchscreen on or off.

### 8. Touchscreen

Touch the screen to operate the remote controller. Note that the touchscreen is not waterproof. Operate with caution.

### 9. USB-C Port

For charging and connecting the remote controller to your computer.

### 10. microSD Card Slot

For inserting a microSD card.

### 11. Gimbal Dial

Controls the tilt of the camera.

### 12. Record Button

Press once to start or stop recording.

### 13. Camera Control Dial

For zoom control. Set the function in DJI Fly by entering Camera View > Settings > Control > Button Customization.

### 14. Focus/Shutter Button

Press halfway down on the button to auto focus and press all the way down to take a photo.

### 15. Speaker

Outputs sound.

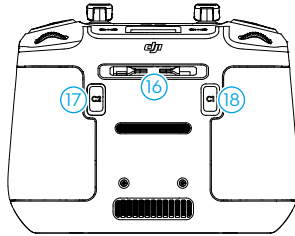

### 16. Control Sticks Storage Slot

For storing the control sticks.

### 17. Customizable C2 Button

Press once to turn the auxiliary light on or off. Set the function in DJI Fly by entering Camera View > Settings > Control > Button Customization.

### 18. Customizable C1 Button

Switch between recentring the gimbal and pointing the gimbal downward. The function can be set in DJI Fly. Set the function in DJI Fly by entering Camera View > Settings > Control > Button Customization.

## DJI RC-N2 Remote Controller

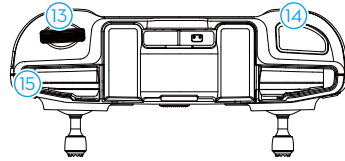
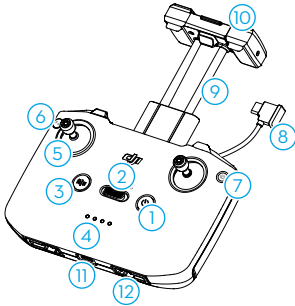

### 1. Power Button

Press once to check the current battery level. Press, and then press and hold to power the remote controller on or off.

### 2. Flight Mode Switch

Switch between Sport, Normal, and Cine mode.

### 3. Flight Pause/Return to Home (RTH) Button

Press once to make the aircraft brake and hover in place (only when GNSS or Vision Systems are available). Press and hold to initiate RTH. Press again to cancel RTH.

### 4. Battery Level LEDs

Displays the current battery level of the remote controller.

### 5. Control Sticks

The control sticks are removable and easy to store. Set the flight control mode in DJI Fly.

### 6. Customizable Button

Press once to recenter the gimbal or point the gimbal downward (default settings). Set the function in DJI Fly by entering Camera View > Settings > Control > Button Customization.

### 7. Photo/Video Toggle

Press once to switch between photo and video mode.

### 8. Remote Controller Cable

Connect to a mobile device for video linking via the remote controller cable. Select the cable according to the port type on your mobile device.

### 9. Mobile Device Holder

For mounting the mobile device securely on the remote controller.

### 10. Antennas

Transmit aircraft control and wireless video signals.

### 11. USB-C Port

For charging and connecting the remote controller to your computer.

### 12. Control Sticks Storage Slot

For storing the control sticks.

### 13. Gimbal Dial

Controls the tilt of the camera. Press and hold the customizable button to use the gimbal dial for zoom control.

### 14. Shutter/Record Button

Press once to take photos or start or stop recording.

### 15. Mobile Device Slot

For securing the mobile device.

# Flight Safety

---

This section describes safe flight practices, flight restrictions, basic flight operations, and the intelligent flight modes.

# Flight Safety

After completing the pre-flight preparation, it is recommended to train your flying skills and practice flying safely. Pick a suitable area to fly in according to the following flight requirements and restrictions. Strictly abide by local laws and regulations when flying. Read the Safety Guidelines before flight to ensure the safe use of the product.

## Flight Environment Requirements

1. DO NOT operate the aircraft in severe weather conditions including wind speeds exceeding 12 m/s, snow, rain, fog, hail, ice, and thunderstorm.
2. Only fly in open areas. Tall buildings and large metal structures may affect the accuracy of the onboard compass and GNSS system. Therefore, DO NOT take off from a balcony or anywhere within 5 m of buildings. Keep a distance of at least 5 m from buildings during flight. After takeoff, make sure you are notified with the voice prompt Home Point is updated before continuing flight. If the aircraft has taken off near buildings, the accuracy of the Home Point cannot be guaranteed. In this case, pay close attention to the current position of the aircraft during auto RTH. When the aircraft is close to the Home Point, it is recommended to cancel auto RTH and manually control the aircraft to land at an appropriate location.
3. The braking distance of the aircraft is affected by the flight altitude. The higher the altitude, the greater the braking distance. When flying at an altitude above 3,000 m (9,843 ft), the user should reserve at least 20 m of vertical braking distance and 30 m of horizontal braking distance to ensure flight safety.
4. Avoid obstacles, crowds, high-voltage power lines, trees, and bodies of water (recommended height is at least 3 m above water).
5. Minimize interference by avoiding areas with high levels of electromagnetism such as locations near power lines, base stations, electrical substations, and broadcasting towers.
6. DO NOT take off from an altitude more than 6,000 m (19,685 ft) above sea level. The performance of the aircraft and its battery is limited when flying at high altitudes. Fly with caution.
7. GNSS cannot be used on the aircraft in the polar regions. Use the vision systems instead.
8. DO NOT take off from moving objects such as cars, ships, and airplanes.
9. DO NOT take off from solid-colored surfaces or surfaces with strong reflection such as a car roof.
10. DO NOT use the aircraft, remote controller, battery, battery charger, and the battery charging hub near accidents, fire, explosions, floods, tsunamis, avalanches, landslides, earthquakes, dust, sandstorms, salt spray, or fungus.
11. Operate the aircraft, remote controller, battery, battery charger, and the battery charging hub in a dry environment.
12. DO NOT operate the aircraft in an environment at risk of a fire or explosion.
13. DO NOT operate the aircraft near bird flocks.

## Operating the Aircraft Responsibly

To avoid serious injury and property damage, observe the following rules:

1. Make sure you are NOT under the influence of anesthesia, alcohol, or drugs or suffering from dizziness, fatigue, nausea, or other conditions that could impair the ability to operate the aircraft safely.
2. When landing, power off the aircraft first, then switch off the remote controller.
3. DO NOT drop, launch, fire, or otherwise project any dangerous payloads on or at any buildings, persons, or animals, which could cause personal injury or property damage.
4. DO NOT use an aircraft that has been crashed or accidentally damaged or an aircraft that is not in good condition.
5. Make sure to train sufficiently and have contingency plans for emergencies or when an incident occurs.
6. Make sure to have a flight plan. DO NOT fly the aircraft recklessly.
7. Respect the privacy of others when using the camera. Make sure to comply with local privacy laws, regulations, and moral standards.
8. DO NOT use this product for any reason other than general personal use.
9. DO NOT use it for illegal or inappropriate purposes such as spying, military operations, or unauthorized investigations.
10. DO NOT use this product to defame, abuse, harass, stalk, threaten, or otherwise violate legal rights such as the right to privacy and publicity of others.
11. DO NOT trespass onto the private property of others.
12. Make sure the drone owner is registered at his or her national authority (unless already registered).

## Flight Limits

### GEO (Geospatial Environment Online) System

DJI's Geospatial Environment Online (GEO) System is a global information system that provides real-time information on flight safety and restriction updates and prevents UAVs from flying in restricted airspace. Under exceptional circumstances, restricted areas can be unlocked to allow flights in. Prior to that, the user must submit an unlocking request based on the current restriction level in the intended flight area. The GEO system may not fully comply with local laws and regulations. Users shall be responsible for their own flight safety and must consult with the local authorities on the relevant legal and regulatory requirements before requesting to unlock a flight in a restricted area. For more information about the GEO system, visit <https://fly-safe.dji.com>.

### Flight Limits

For safety reasons, flight limits are enabled by default to help users operate this aircraft safely. Users can set flight limits on height and distance. Altitude limits, distance limits, and GEO zones function concurrently to manage flight safety when GNSS is available. Only altitude can be limited when GNSS is unavailable.

## Flight Altitude and Distance Limits

Max altitude restricts an aircraft's flight altitude, while max distance restricts an aircraft's flight radius around the Home Point. These limits can be changed in the DJI Fly app for improved flight safety.

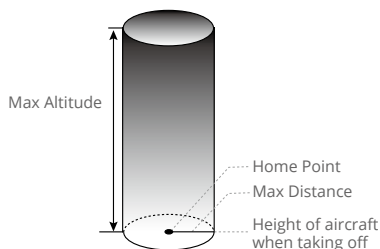

Home Point not manually updated during flight

### Strong GNSS Signal

|              | Flight Restrictions  | Prompt in DJI Fly App        |
|--------------|--|------------------------------|
| Max Altitude | Altitude of the aircraft cannot exceed the value set in DJI Fly.   | Max flight altitude reached. |
| Max Distance | The straight-line distance from the aircraft to the Home Point cannot exceed the max flight distance set in DJI Fly. | Max flight distance reached. |

### Weak GNSS Signal

|              | Flight Restrictions   | Prompt in DJI Fly App        |
|--------------|---|------------------------------|
| Max Altitude | <ul style="list-style-type: none"> <li>Altitude is restricted to 30 m from the takeoff point if lighting is sufficient.</li> <li>Altitude is restricted to 3 m above the ground if lighting is not sufficient and the three-dimensional infrared sensing system is operating.</li> <li>Altitude is restricted to 30 m from the takeoff point if lighting is not sufficient and the three-dimensional infrared sensing system is not operating.</li> </ul> | Max flight altitude reached. |
| Max Distance | No limits   |                              |

- ⚠**
- The altitude limit of 3 m or 30 m when the GNSS is weak will be lifted if there was a strong GNSS signal (GNSS signal strength  $\geq 2$ ) when the aircraft was powered on.
  - If the aircraft reaches a limit, you can still control the aircraft, but you cannot fly it any further. If the aircraft flies out of the max radius, it will automatically fly back within range when the GNSS signal is strong.

- For safety reasons, do not fly close to airports, highways, railway stations, railway lines, city centers, or other sensitive areas. Fly the aircraft only within your line of sight.
- 

## GEO Zones

DJI's GEO system designates safe flight locations, provides risk levels and safety notices for individual flights and offers information on restricted airspace. All restricted flight areas are referred to as GEO Zones, which are further divided into Restricted Zones, Authorization Zones, Warning Zones, Enhanced Warning Zones, and Altitude Zones. Users can view such information in real-time in the DJI Fly app. GEO Zones are specific flight areas, including but not limited to airports, large event venues, locations where public emergencies have occurred (such as forest fires), nuclear power plants, prisons, government properties, and military facilities. By default, the GEO system limits takeoffs and flights in zones that may cause safety or security concerns. A GEO Zone map that contains comprehensive information on GEO Zones around the globe is available on the official DJI website: <https://fly-safe.dji.com/nfz/nfz-query>.

## Unlocking GEO Zones

To satisfy the needs of different users, DJI provides two unlocking modes: Self-Unlocking and Custom Unlocking. Users may request on the DJI FlySafe website.

**Self-Unlocking** is intended for unlocking Authorization Zones. To complete Self-Unlocking, the user must submit an unlocking request via the DJI Fly Safe website at <https://fly-safe.dji.com>. Once the unlocking request is approved, the user may synchronize the unlocking license through the DJI Fly app. To unlock the zone, alternatively, the user may launch or fly the aircraft directly into the approved Authorization Zone and follow the prompts in DJI Fly to unlock the zone.

**Custom Unlocking** is tailored for users with special requirements. It designates user-defined custom flight areas and provides flight permission documents specific to the needs of different users. This unlocking option is available in all countries and regions and can be requested via the DJI FlySafe website at <https://fly-safe.dji.com>.



- To ensure flight safety, the aircraft will not be able to fly out of the unlocked zone after entering it. If the Home Point is outside the unlocked zone, the aircraft will not be able to return home.
- 

## Pre-Flight Checklist

1. Make sure the gimbal protector is removed.
2. Make sure the remote controller, mobile device, and Intelligent Flight Battery are fully charged.
3. Make sure the aircraft arms are unfolded.
4. Make sure the Intelligent Flight Battery and the propellers are mounted securely.
5. Make sure the gimbal and camera are functioning normally.



6. Make sure that there is nothing obstructing the motors and that they are functioning normally.
7. Make sure that DJI Fly is successfully connected to the aircraft.
8. Make sure all camera lenses and sensors are clean.
9. Only use genuine DJI parts or parts authorized by DJI. Unauthorized parts may cause the system to malfunction and compromise flight safety.
10. Make sure the Obstacle Avoidance Action is set in DJI Fly, and the max flight altitude, max flight distance and RTH altitude are all set properly according to the local laws and regulations.

## Basic Flight

### Auto Takeoff/Landing



#### Auto Takeoff

Use the Auto Takeoff function:

1. Launch DJI Fly and enter the camera view.
2. Complete all steps in the pre-flight checklist.
3. Tap . If conditions are safe for takeoff, press and hold the button to confirm.
4. The aircraft will take off and hover approximately 1.2 m (3.9 ft) above the ground.

#### Auto Landing

Use the Auto Landing function:

1. Tap . If conditions are safe for landing, press and hold the button to confirm.
2. Auto landing can be cancelled by tapping .
3. If the Downward Vision System is working normally, Landing Protection will be enabled.
4. Motors will stop automatically after landing.

---

 • Choose the proper place for landing.

---

## Starting/Stopping the Motors

### Starting the Motors

Perform the Combination Stick Command (CSC) as shown below to start the motors. Once the motors have started spinning, release both sticks simultaneously.

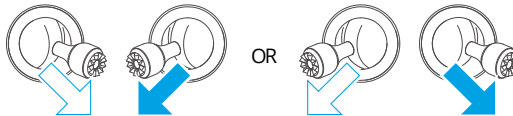

### Stopping the Motors

When the aircraft is on the ground and the motors are spinning, there are two ways to stop the motors:

**Method 1:** When the aircraft has landed, push the throttle stick down and hold until the motors stop.

**Method 2:** When the aircraft has landed, perform the same CSC used to start the motors until the motors stop.



Method 1

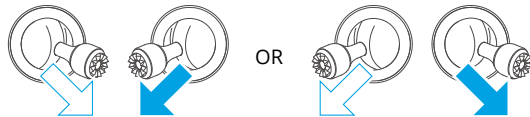

Method 2

### Stopping the Motors Mid-Flight

Stopping the motors mid-flight will cause the aircraft to crash. The default setting for Emergency Propeller Stop in the DJI Fly app is Emergency Only, which means that the motors can only be stopped mid-flight when the aircraft detects that it is in an emergency situation such as the aircraft is involved in a collision, a motor has stalled, the aircraft is rolling in the air, or the aircraft is out of control and is ascending or descending very quickly. To stop the motors mid-flight, perform the same CSC that was used to start the motors. Note that the user needs to hold the control sticks for two seconds while performing the CSC to stop the motors. Emergency Propeller Stop can be changed to Anytime in the app by users. Use this option with caution.

## Controlling the Aircraft

The control sticks of the remote controller can be used to control the aircraft movements. The control sticks can be operated in Mode 1, Mode 2, or Mode 3, as shown below. The default control mode of the remote controller is Mode 2. Refer to the Remote Controller section for more details.

### Mode 1

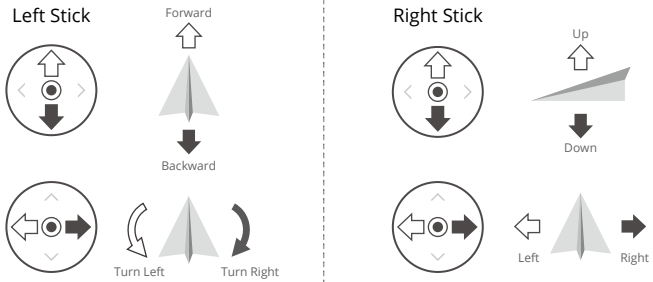

### Mode 2

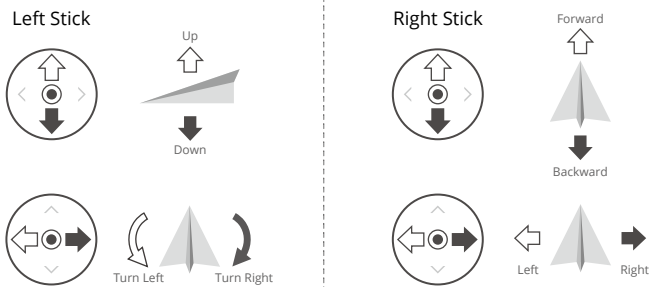

### Mode 3

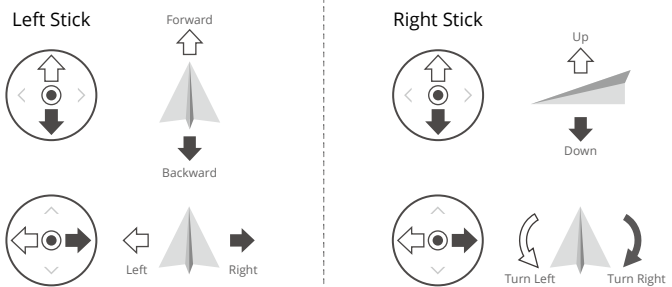

## Takeoff/Landing Procedures

1. Place the aircraft in an open, flat area with the rear of the aircraft facing towards you.
2. Power on the remote controller and the aircraft.
3. Launch DJI Fly and enter the camera view.
4. Tap Settings > Safety, and then set the Obstacle Avoidance Action to Bypass or Brake. Make sure to set an appropriate Max Altitude and RTH Altitude.
5. Wait for the aircraft self-diagnostics to complete. If DJI Fly does not show any irregular warning, you can start the motors.
6. Push the throttle stick up slowly to take off.
7. To land, hover over a level surface and gently push the throttle stick down to descend.
8. The motors will stop automatically after landing.
9. Power off the aircraft before the remote controller.

## Video Suggestions and Tips

1. The pre-flight checklist is designed to help you fly safely and shoot videos during flight. Go through the full pre-flight checklist before each flight.
2. Select the desired gimbal operation mode in DJI Fly.
3. It is recommended to take photos or record videos when flying in Normal or Cine mode.
4. DO NOT fly in bad weather such as on rainy or windy days.
5. Choose the camera settings that best suit your needs.
6. Perform flight tests to establish flight routes and preview scenes.
7. Push the control sticks gently to ensure smooth and stable movement of the aircraft.



- Make sure to place the aircraft on a flat and steady surface before takeoff. DO NOT launch the aircraft from your palm or while holding it with your hand.
-

## Intelligent Flight Mode

### FocusTrack

FocusTrack includes Spotlight, Point of Interest, and ActiveTrack.

- 💡 • Refer to the Controlling the Aircraft section in the Remote Controller chapter for more information about the roll, pitch, throttle, and yaw control sticks.
- The aircraft does not automatically take photos or record videos while using FocusTrack. Users need to manually control the aircraft to take photos or record videos.

|                           | Spotlight   | Point of Interest (POI)   | ActiveTrack   |
|---------------------------|---|---|---|
| <b>Description</b>        | The aircraft does not fly automatically, but the camera remains locked on the subject while the user manually controls the flight.  | The aircraft tracks the subject in a circle based on the set radius and flight speed. The max flight speed is 12 m/s and the flight speed may be adjusted dynamically according to the actual radius.   | The aircraft keeps a certain distance and altitude from the tracked subject, and there are two modes: Trace and Parallel. The max flight speed is 12 m/s.   |
| <b>Supported Subjects</b> | <ul style="list-style-type: none"> <li>• Stationary subjects</li> <li>• Moving subjects such as vehicles, boats, and people</li> </ul>  |   | <ul style="list-style-type: none"> <li>• Moving subjects such as vehicles, boats, and people</li> </ul>   |
| <b>Control</b>            | Using the control sticks to move the aircraft: <ul style="list-style-type: none"> <li>• Move the roll stick to circle the subject</li> <li>• Move the pitch stick to alter the distance from the subject</li> <li>• Move the throttle stick to change the altitude</li> <li>• Move the yaw stick to adjust the frame</li> </ul> | Using the control sticks to move the aircraft: <ul style="list-style-type: none"> <li>• Move the roll stick to change the circling speed of the aircraft around the subject</li> <li>• Move the pitch stick to alter the distance from the subject</li> <li>• Move the throttle stick to change the altitude</li> <li>• Move the yaw stick to adjust the frame</li> </ul> | Using the control sticks to move the aircraft: <ul style="list-style-type: none"> <li>• Move the roll stick to circle the subject</li> <li>• Move the pitch stick to alter the distance from the subject</li> <li>• Move the throttle stick to change the altitude</li> <li>• Move the yaw stick to adjust the frame</li> </ul> |
| <b>Obstacle Avoidance</b> | When the vision systems are working normally, the aircraft will hover if an obstacle is detected, regardless of whether the obstacle avoidance action is set to Bypass or Brake in DJI Fly.<br>Note: obstacle avoidance is disabled in Sport mode.  | The aircraft will bypass obstacles regardless of the flight modes or obstacle avoidance action setting in DJI Fly when the vision systems are working normally.   |   |

ActiveTrack

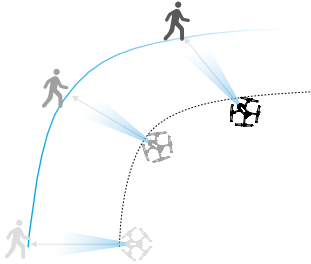
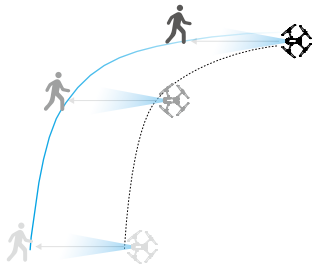
| Trace   | Parallel   |
|---|--|
| <p>There are eight types of tracking directions: Front, Back, Left, Right, Front Diagonal Left, Front Diagonal Right, Back Diagonal Left, and Back Diagonal Right. After setting the tracking direction, the aircraft will follow the subject from the tracking direction relative to the direction of the subject movements.</p>  | <p>The aircraft tracks the subject while maintaining the same geographical orientation in relation to the subject.</p>  |

⚠ • In Trace mode, the direction setting is only effective when the subject is moving in a stable direction. If the moving direction of the subject is not stable, the aircraft will track the subject from a certain distance and altitude. Once the tracking starts, the direction of tracking can be adjusted through the direction wheel.

In ActiveTrack, the supported follow ranges of the aircraft and subject are as follows:

| Subject  | People                      |                    | Vehicles/Boats                |                    |
|----------|-----------------------------|--------------------|-------------------------------|--------------------|
| Camera   | Wide-angle Camera           | Medium Tele Camera | Wide-angle Camera             | Medium Tele Camera |
| Distance | 4-20 m<br>(Optimal: 5-10 m) | 7-20 m             | 6-100 m<br>(Optimal: 20-50 m) | 16-100 m           |
| Altitude | 2-20 m (Optimal: 2-10 m)    |                    | 6-100 m (Optimal: 10-50 m)    |                    |

⚠ • The aircraft will fly to the supported distance and altitude range if the distance and altitude is out of range when ActiveTrack begins. Fly the aircraft at the optimal distance and altitude for the best tracking performance.

## Using FocusTrack

1. Launch the aircraft.

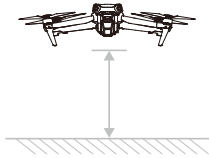

2. Drag-select the subject in the camera view or enable Subject Scanning under Control settings in DJI Fly Control and tap the recognized subject to enable FocusTrack.

- ☀️ • FocusTrack must be used within the supported zoom ratio as follows. Otherwise, subject recognition will be affected.
  - a. Spotlight/Point of Interest: supports up to 9x zoom for moving subjects such as vehicles, boats, people, and stationary subjects.
  - b. ActiveTrack: supports up to 3x zoom for moving subjects such as vehicles, boats, and people.

- a. The aircraft enters Spotlight by default and does not fly automatically. The user needs to manually control the flight of the aircraft by using the control sticks. Tap the shutter/record button on the camera view in DJI Fly or press the shutter/record button on the remote controller to start shooting.

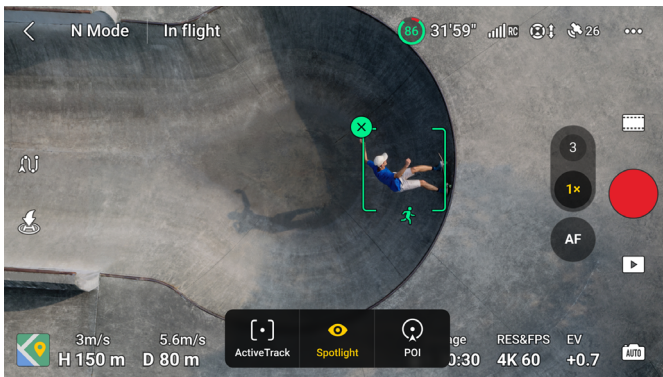

- b. Tap on the bottom of the screen to switch to Point of Interest. After setting the flight direction and speed, tap GO and the aircraft will automatically start circling around the subject at the current altitude. The user can also move the control sticks to manually control the flight while the aircraft is automatically flying. Tap the shutter/record button on the camera view in DJI Fly or press the shutter/record button on the remote controller to start shooting.

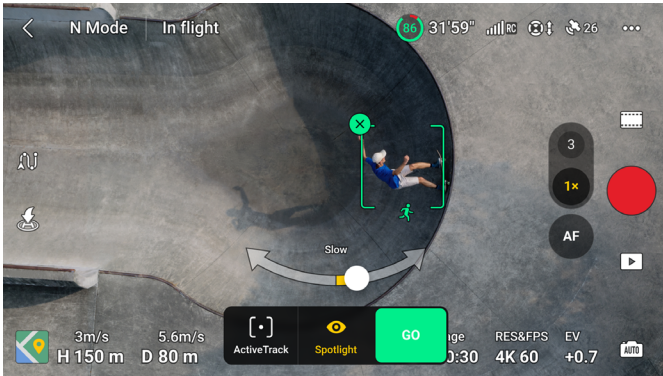

- c. Tap on the bottom of the screen to switch to ActiveTrack. In Trace mode, the tracking direction can be changed using the direction wheel (Front, Back, Left, Right, Front Diagonal Left, Front Diagonal Right, Back Diagonal Left, and Back Diagonal Right). The direction wheel will be minimized if there is no operation for an extended period or any other area of the screen is tapped.

Swipe the mode icon in the center of the direction wheel left or right to switch between Trace or Parallel. The tracking direction will be automatically set to back once Trace is selected again. Tap GO, the aircraft will start tracking the subject automatically. The user can also move the control sticks to manually control the flight while the aircraft is automatically flying. Tap the shutter/record button on the camera view in DJI Fly or press the shutter/record button on the remote controller to start shooting.





## Exiting FocusTrack

In Point of Interest or ActiveTrack, press the Flight Pause button once on the remote controller or tap Stop on the screen to return to Spotlight.

In Spotlight, press the Flight Pause button once on the remote controller to exit FocusTrack.

After exiting FocusTrack, tap  to view the footage in Playback.



- DO NOT use FocusTrack in areas with people and animals running or vehicles moving.
  - DO NOT use FocusTrack in areas with small or thin objects (e.g., tree branches or power lines), transparent objects (e.g., water or glass), or monochrome surfaces (e.g., white walls).
  - Always be prepared to press the Flight Pause button on the remote controller or tap Stop in DJI Fly to operate the aircraft manually in case any emergency situation occurs.
  - Be extra vigilant when using FocusTrack in any of the following situations:
    - a. The tracked subject is not moving on a level plane.
    - b. The tracked subject changes shape drastically while moving.
    - c. The tracked subject is out of sight for an extended period.
    - d. The tracked subject is moving on a snowy surface.
    - e. The tracked subject has a similar color or pattern to its surrounding environment.
    - f. The lighting is extremely dark (<300 lux) or bright (>10,000 lux).
  - Make sure to follow local privacy laws and regulations when using FocusTrack.
  - It is recommended to only track vehicles, boats, and people (but not children). Fly with caution when tracking other subjects.
  - In supported moving subjects, vehicles refer to cars and small to medium-sized yachts. DO NOT track a remotely controlled model car or boat.
  - The tracking subject may be inadvertently swapped to another subject if they pass nearby each other.
  - ActiveTrack is unavailable when the lighting is insufficient and the vision systems are unavailable. Spotlight and POI for static subjects can still be used, but obstacle sensing is not available.
  - FocusTrack is unavailable in the Night video mode.
  - FocusTrack is unavailable when the aircraft is on the ground.
  - FocusTrack may not function properly when the aircraft is flying near flight limits or in a GEO Zone.
  - If the subject is obstructed and is lost by the aircraft, the aircraft will keep flying at the current speed and orientation for 8 seconds to try to re-identify the subject. If the aircraft fails to re-identify the subject in 8 seconds, it will exit ActiveTrack automatically.
-

## MasterShots

MasterShots keeps the subject at the center of the frame while executing different maneuvers in sequence to generate a short cinematic video.

### Using MasterShots

1. Launch the aircraft and make it hover at least 2 m (6.6 ft) above ground.

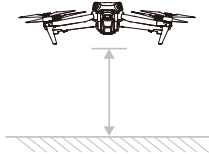

2. In DJI Fly, tap the shooting mode icon to select MasterShots and read the instructions. Make sure you understand how to use MasterShots and there are no obstacles in the surrounding area.
3. Drag-select the subject in the camera view, and set the flight range. Enter the map view to check the estimated flight range and flight paths, and ensure there is no obstacle in the flight range, such as high buildings. Tap Start, the aircraft will start flying and recording automatically. The aircraft will fly back to its original position once recording is finished.

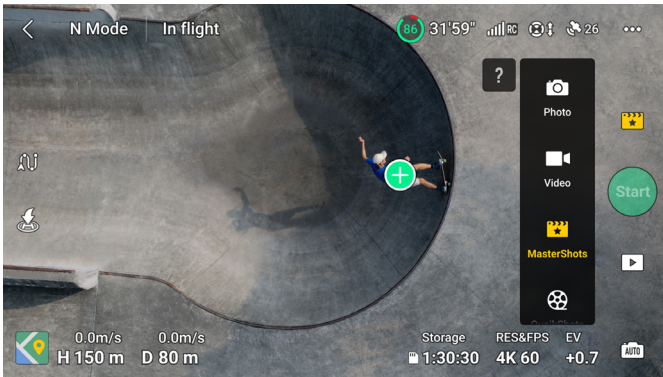

4. Tap  to access, edit, or share the video to social media.







## Exiting MasterShots

Press the Flight Pause button once or tap  in DJI Fly to exit MasterShots. The aircraft will brake and hover in place.

-  • Use MasterShots at locations that are clear of buildings and other obstacles. Make sure there are no humans, animals, or other obstacles in the flight path. When the lighting is sufficient and the environment is suitable for vision systems, the aircraft will brake and hover in place if there is an obstacle detected.
- Always pay attention to objects around the aircraft and use the remote controller to avoid collisions or the aircraft getting obstructed.
- DO NOT use MasterShots in any of the following situations:
  - a. When the subject is blocked for an extended period or outside the line of sight.
  - b. When the subject is similar in color or pattern with the surroundings.
  - c. When the subject is in the air.
  - d. When the subject is moving fast.
  - e. The lighting is extremely dark (< 300 lux) or bright (> 10,000 lux).
- DO NOT use MasterShots in places close to buildings or where the GNSS signal is weak. Otherwise, the flight path may become unstable.
- Make sure to follow local privacy laws and regulations when using MasterShots.
- Only when using the wide-angle camera to take MasterShots will the aircraft automatically select one of the three flight routes based on the subject type and distance (portrait, proximity, or landscape). There is only one flight route when using the medium tele camera to take MasterShots, regardless of the subject type and distance.

## QuickShots

QuickShots shooting modes include Dronie, Rocket, Circle, Helix, Boomerang, and Asteroid. The aircraft records according to the selected shooting mode and automatically generates a short video. The video can be viewed, edited, or shared to social media from playback.

-  **Dronie:** The aircraft flies backward and ascends with the camera locked on the subject.
-  **Rocket:** The aircraft ascends with the camera pointing downward.
-  **Circle:** The aircraft circles around the subject.
-  **Helix:** The aircraft ascends and spirals around the subject.
-  **Boomerang:** The aircraft flies around the subject in an oval path, ascending as it flies away from its starting point and descending as it flies back. The starting point of the aircraft forms one end of the long axis of the oval, while the other end is at the opposite side of the subject from the starting point.
-  **Asteroid:** The aircraft flies backward and upward, takes several photos, and then flies back to the starting point. The video generated starts with a panorama of the highest position and then shows the view from the aircraft as it descends.

- ⚠️ • Make sure there is sufficient space when using Boomerang. Allow a radius of at least 30 m (99 ft) around the aircraft and a space of at least 10 m (33 ft) above the aircraft.
- Make sure there is sufficient space when using Asteroid. Allow at least 40 m (131 ft) behind and 50 m (164 ft) above the aircraft.
- The medium tele camera does not support the Asteroid mode in QuickShots.

## Using QuickShots

1. Launch the aircraft and make it hover at least 2 m (6.6 ft) above ground.

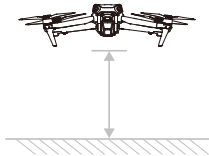

2. In DJI Fly, tap the shooting mode icon to select QuickShots and follow the prompts. Make sure you understand how to use QuickShots and there are no obstacles in the surrounding area.
3. Choose a shooting mode, drag-select the subject in the camera view. Tap Start, the aircraft will start flying and recording automatically. The aircraft will fly back to its original position once recording is finished.

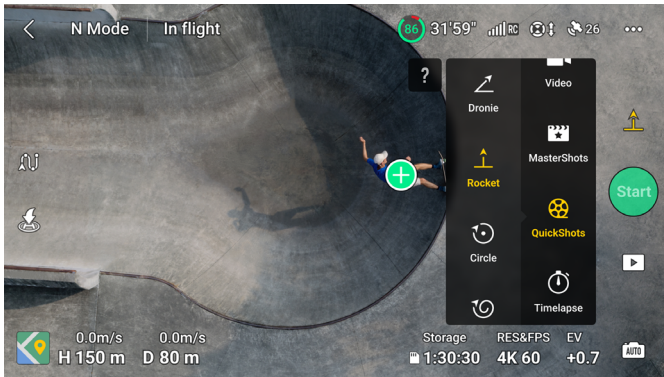

4. Tap  to access, edit, or share the video to social media.

## Exiting QuickShots

Press the Flight Pause button once or tap  in DJI Fly to exit QuickShots. The aircraft will brake and hover. Tap the screen again and the aircraft will continue shooting.

Note: if you accidentally move a control stick, the aircraft will exit QuickShots and hover in place.

-  • Use QuickShots at locations that are clear of buildings and other obstacles. Make sure there are no people, animals, or other obstacles in the flight path. The aircraft will brake and hover if an obstacle is detected.
- Always pay attention to objects around the aircraft and use the remote controller to avoid collisions or the aircraft getting obstructed.
- DO NOT use QuickShots in any of the following situations:
  - a. When the subject is blocked for an extended period or outside the line of sight.
  - b. When the subject is more than 50 m away from the aircraft.
  - c. When the subject is similar in color or pattern with the surroundings.
  - d. When the subject is in the air.
  - e. When the subject is moving fast.
  - f. When the lighting is extremely dark ( $< 300$  lux) or bright ( $> 10,000$  lux).
- DO NOT use QuickShots in places close to buildings or where the GNSS signal is weak. Otherwise, the flight path will become unstable.
- Make sure to follow local privacy laws and regulations when using QuickShots.

## Hyperlapse

Hyperlapse shooting modes include Free, Circle, Course Lock, and Waypoint.

-  • After selecting the Hyperlapse shooting mode, go to Settings > Camera > Hyperlapse in DJI Fly to select the photo type of the original hyperlapse photos to be saved, or select Off to not save any original hyperlapse photos.

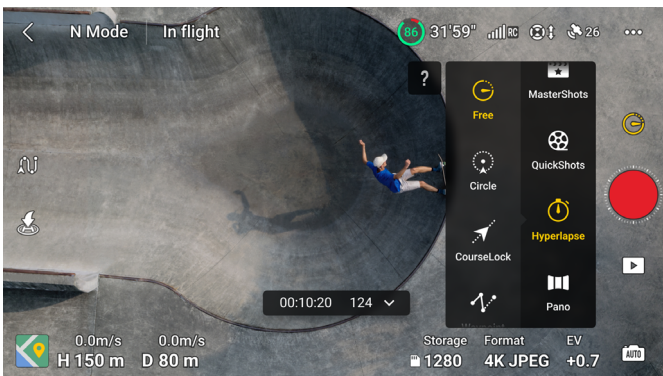

## Free

The aircraft automatically takes photos and generates a timelapse video. Free mode can be used while the aircraft is on the ground. After takeoff, control the aircraft's movements and gimbal angle using the remote controller.

### Follow the steps below to use Free:

1. Set the interval time, video duration, and max speed. The screen displays the number of photos that will be taken and the shooting duration.
2. Tap the shutter/record button to begin.

## Circle

The aircraft automatically takes photos while flying around the selected subject to generate a timelapse video.

### Follow the steps below to use Circle:

1. Set the interval time, video duration, max speed, and circle direction. The screen displays the number of photos that will be taken and the shooting duration.
2. Drag-select a subject on the screen. Use the yaw stick and gimbal dial to adjust the frame.
3. Tap the shutter/record button to begin.

## Course Lock

Course Lock allows the user to lock the flight direction. While doing so, the user may either select a subject for the camera to point toward while taking hyperlapse photos, or not select any subject while being able to control the aircraft orientation and gimbal.

### Follow the steps below to use Course Lock:

1. Adjust the aircraft to the desired orientation, and then lock the current orientation as the flight direction.
2. Set the interval time, video duration, and max speed. The screen displays the number of photos that will be taken and the shooting duration.
3. If applicable, drag-select a subject. After selecting the subject, the aircraft will automatically adjust the orientation or gimbal angle to center the subject in the camera view. In this case, the frame cannot be adjusted manually.
4. Tap the shutter/record button to begin. Move the pitch stick and roll stick to control the horizontal flight speed and briefly alter the aircraft orientation. Move the throttle stick to control the vertical flight speed.

## Waypoints

The aircraft automatically takes photos on a flight path of multiple waypoints and generates a timelapse video. The aircraft can fly in sequence from the first waypoint to the final waypoint or in reverse order.

### Follow the steps below to use Waypoints:

1. Set the desired waypoints. Fly the aircraft to the desired locations and adjust the aircraft

orientation and the gimbal angle.

2. Set the interval time, video duration, and max speed. The screen displays the number of photos that will be taken and the shooting duration.
3. Tap the shutter/record button to begin.

The aircraft will generate a timelapse video automatically, which is viewable in playback.

- ⚠ • For optimal performance, use Hyperlapse at an altitude higher than 50 m and set a difference of at least two seconds between the interval time and shutter.
- It is recommended to select a static subject (e.g., high-rise buildings, mountainous terrain) located at a safe distance from the aircraft (further than 15 m). Do not select a subject that is too close to the aircraft, people, or a moving car, etc.
- When the lighting is sufficient and the environment is suitable for the vision systems to operate, the aircraft will brake and hover in place if an obstacle is detected during Hyperlapse. If the lighting becomes insufficient or the environment is unsuitable for the vision systems to operate during Hyperlapse, the aircraft will continue shooting without obstacle sensing. Fly with caution.
- The aircraft will only generate a video after at least 25 photos have been taken, which is the amount required to generate a one-second video. The video will be generated by default regardless of whether Hyperlapse concludes normally or the aircraft exits from the mode unexpectedly (such as when Low Battery RTH is triggered).

## Waypoint Flight

Waypoint Flight enables the aircraft to capture images during a flight according to the waypoint flight route generated by the preset waypoints. Points of Interest (POI) can be linked to the waypoints. The heading will point toward the POI during flight. A waypoint flight route can be saved and repeated.

### Using Waypoint Flight

#### 1. Enable Waypoint Flight

Tap  on the left of the camera view in DJI Fly to enable Waypoint Flight.

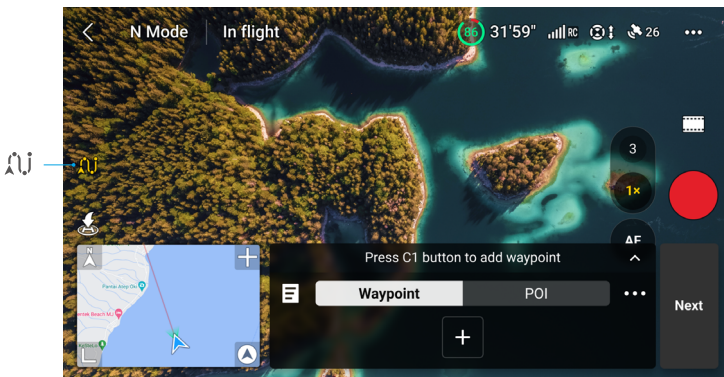

## 2. Plan a Waypoint Flight

Tap **⋮** on the operation panel to set the parameters for the flight route such as Global Speed, Camera, the behavior of End of Flight, On Signal Lost, and Start Point. The settings apply to all waypoints.

|                |   |
|----------------|---|
| Global Speed   | The default flight speed of the entire flight route. Drag the speed bar to set the global speed.  |
| Camera         | Select the camera which will perform the preset shooting actions during the entire flight route: 1-3x (wide-angle camera) or 3-9x (medium tele camera). |
| End of Flight  | The behavior of the aircraft after the flight task ends. It can be set to Hover, RTH, Land, or Back to Start.   |
| On Signal Lost | The behavior of the aircraft when the remote controller signal is lost during flight. It can be set to RTH, Hover, Land, or Continue.                   |
| Start Point    | After selecting the start waypoint, the flight route will be started from this waypoint to the subsequent waypoints.                                    |

- Make sure to select the camera before pinning waypoints. If 1-3x (wide-angle camera) is selected, the custom range of the zoom ratio for all waypoints on this route is 1-3x. If 3-9x (medium tele camera) is selected, the custom range of the zoom ratio for all waypoints on this route is 3-9x.
- When using Waypoint Flight in the EU, the behavior of the aircraft when the remote controller signal is lost cannot be set to Continue.

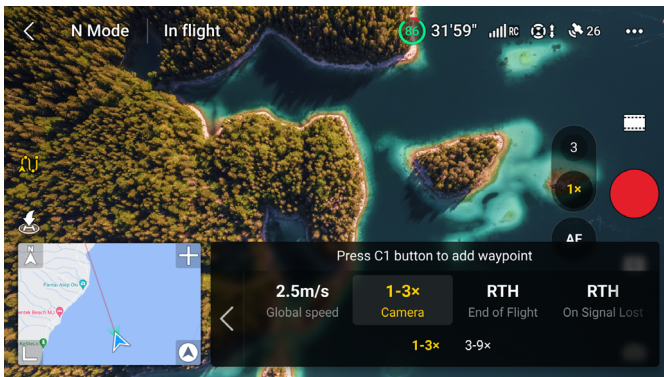

## 3. Waypoint Settings

### a. Pin Waypoint

Waypoints can be pinned via the map before takeoff.

Waypoints can be pinned via the remote controller, operation panel, and map after takeoff. In this case, GNSS is required.



- Using the Remote Controller: Press once the Fn button (RC-N2) or C1 button (DJI RC 2) to pin a waypoint.
- Using the Operation Panel: Tap  $\oplus$  on the operation panel to pin a waypoint.
- Using the Map: Enter the map view and tap on the map to pin a waypoint.

Press and hold on a waypoint to move its position on the map.



- When setting a waypoint, it is recommended to fly to the location for a more accurate and smoother imaging result.
  - The aircraft horizontal GNSS position, altitude from the takeoff point, heading, gimbal tilt, and camera zoom ratio will be recorded if the waypoint is pinned via the remote controller or the operation panel.
  - If the user need to add waypoints during the flight, make sure to use the camera selected in the flight route parameters. When the user switches to other camera in the camera view while adding waypoints during the flight, the zoom ratio of the waypoints created with the other camera cannot be recorded by the aircraft, and the zoom setting of these waypoints will be restored to manual.
  - Connect the remote controller to the internet and download the map before using the map to pin a waypoint. When the waypoint is pinned via the map, only the aircraft horizontal GNSS can be recorded, and the default altitude of the waypoint is set to 50 m.
-  • The flight route will curve between waypoints, so the aircraft altitude between waypoints may become lower than the altitudes of the waypoints during the flight. Make sure to avoid any obstacles below when setting a waypoint.

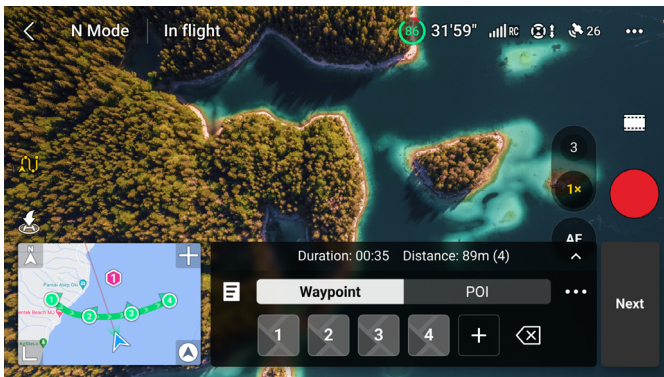

#### b. Settings

Tap the waypoint number for settings. The waypoint parameters are described as follows:

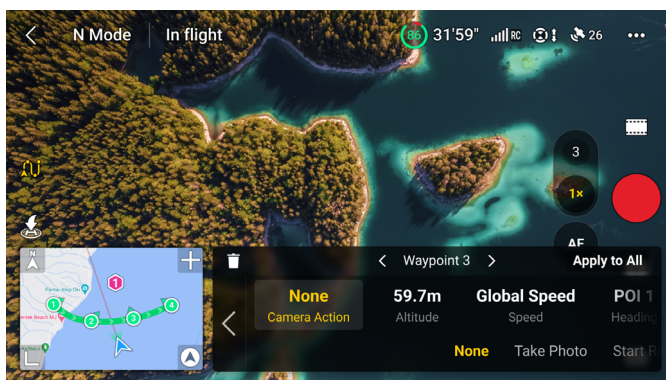

|               |   |
|---------------|---|
| Camera Action | The camera action at the waypoint. Choose between None, Take Photo, and Start or Stop Recording.  |
| Altitude      | The altitude at the waypoint from the takeoff point. Make sure to take off at the same takeoff altitude of the original flight to obtain higher accuracy of altitude when a Waypoint Flight is repeated.  |
| Speed         | <p>The flight speed from the current waypoint to the next waypoint.</p> <ul style="list-style-type: none"> <li>Global Speed: the aircraft will fly at the set global speed from the current waypoint to the next waypoint.</li> <li>Custom: the aircraft will smoothly accelerate or decelerate from the current waypoint to the next waypoint, and reach the custom speed during the process.</li> </ul>   |
| Heading       | <p>The aircraft heading at the waypoint.</p> <ul style="list-style-type: none"> <li>Follow Course: the heading of the aircraft is the same as the horizontal tangent to the flight route.</li> <li>POI<sup>[1]</sup>: tap the POI number to point the aircraft heading toward the specific POI.</li> <li>Manual: the aircraft heading can be adjusted by the user during a Waypoint Flight.</li> <li>Custom: drag the bar to adjust the heading. The heading can be previewed in the map view.</li> </ul> |
| Gimbal Tilt   | <p>The gimbal tilt at the waypoint.</p> <ul style="list-style-type: none"> <li>POI<sup>[1]</sup>: tap the POI number to point the camera toward the specific POI.</li> <li>Manual: the gimbal tilt between the previous waypoint and the current waypoint can be adjusted by the user during a Waypoint Flight.</li> <li>Custom: drag the bar to adjust the tilt of the gimbal.</li> </ul>  |
| Zoom          | <p>The camera zoom at the waypoint.</p> <ul style="list-style-type: none"> <li>Digital Zoom (1-3x / 3-9x): drag the bar to adjust the zoom ratio.</li> <li>Manual: the zoom ratio between the previous waypoint and the current waypoint can be adjusted by the user during a Waypoint Flight.</li> <li>Auto<sup>[2]</sup>: the zoom ratio from the previous waypoint to the next waypoint will be adjusted smoothly by the aircraft.</li> </ul>  |
| Hovering Time | The duration of the aircraft hovering at the current waypoint.  |

- [1] Before selecting POI for heading or gimbal tilt, make sure there are POIs in the flight route. If a POI is linked to a waypoint, the heading and gimbal tilt of the waypoint will be reset to toward the POI.
- [2] The zoom of the Start Point and the End Point cannot be set to auto.

All the settings except camera action can be applied to all the waypoints after selecting Apply to All. Tap  to delete the currently selected waypoint.

#### 4. POI Settings

Tap POI on the operation panel to switch to POI settings. Use the same method to pin a POI as used with a waypoint.

Tap the POI number to set the altitude of the POI and link the POI to waypoints.

Multiple waypoints can be linked to the same POI, and the camera will point toward the POI during the Waypoint Flight.





#### 5. Perform a Waypoint Flight



- Check the Obstacle Avoidance Action settings in the Settings > Safety page of DJI Fly before performing a Waypoint Flight. When set to Bypass or Brake, the aircraft will brake and hover in place if an obstacle is detected during the Waypoint Flight. The aircraft cannot sense obstacles if the Obstacle Avoidance Action is disabled. Fly with caution.
- Observe the environment and ensure there are no obstacles on the route before performing a Waypoint Flight.
- Make sure to maintain visual line of sight (VLOS) of the aircraft. Always be prepared to press the flight pause button in case any emergency situation occurs.



- Tap GO, the aircraft will automatically switch to the camera selected in the flight route parameters setting page. DO NOT switch to the other camera manually.
- When the remote controller signal is lost during flight, the aircraft will perform the action set in On Signal Lost.
- When the Waypoint Flight is finished, the aircraft will perform the action set in End of Flight.

- a. Tap Next or  on the operation panel to enter the flight route parameters setting page and check again. Users can change the Start Point if necessary. Tap GO to upload the waypoint flight task. Tap  to cancel the uploading process and return to the flight route parameters setting page.
- b. The waypoint flight task will be performed after being uploaded. The flight duration, waypoints, and distance will be displayed on the camera view. The pitch stick can be used to change the flight speed during a Waypoint Flight.
- c. Tap  to pause the Waypoint Flight after the task begins. Tap  to continue the Waypoint Flight. Tap  to stop Waypoint Flight and return to the waypoint flight edit status.

#### 6. Library

When planning a Waypoint Flight, the task will be generated automatically and saved every minute. Tap  on the left to enter Library and save the task manually.

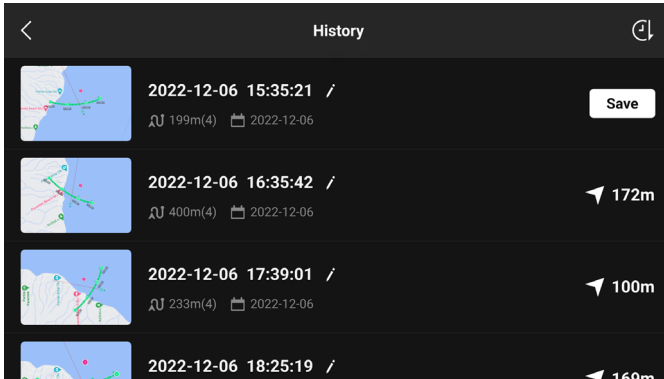

- In the flight route library, users can check the saved tasks, and tap to open or edit a task.
- Tap / to edit the name of the task.
- Slide left to delete a task.
- Tap the icon on the top right corner to change the order the tasks are displayed.

🔄 : tasks will be sorted based on the date they were saved.

📏 : tasks will be sorted based on the distance between the current position of the remote controller and the start waypoints, from closest to farthest.

## 7. Exit Waypoint Flight

Tap ⏪ to exit Waypoint Flight. Tap Save and Exit to save the task to Library and exit.

## Cruise Control

The Cruise Control function enables the aircraft to lock the current control stick input of the remote controller when conditions permit, and to automatically fly at the speed corresponding to the current control stick input. Without the need to continually move the control sticks, long-distance flights become more effortless, and image shaking which often happens during manual operating can be avoided. More camera movements such as spiraling up can be achieved by increasing the control stick input.

## Using Cruise Control

1. Set the Cruise Control Button

Go to DJI Fly, select System Settings > Control > and then set the customizable button of the remote controller to Cruise Control.

## 2. Enter Cruise Control

- Press the cruise control button while pushing the control stick, then the aircraft will automatically fly at the current speed corresponding to the control stick input. Once the cruise control speed is set, the control stick can be released.
- Before the control stick returns to the center, press the cruise control button again to reset the flight speed based on the current control stick input.
- Push the control stick after it returns to the center, the aircraft will fly at the updated speed based on the previous speed. In this case, press the cruise control button again, and the aircraft will automatically fly at the updated speed.

## 3. Exit Cruise Control

Press the cruise control button without a control stick input, press the flight pause button on the remote controller, or tap  on the screen to exit cruise control. The aircraft will brake and hover.



- Cruise control is available when the user is manually operating the aircraft in Normal, Cine, and Sport mode. Cruise control is also available when using APAS, Free Hyperlapse, and Spotlight.
  - Cruise control cannot be started without a control stick input.
  - The aircraft cannot enter or will exit Cruise Control in the following situations:
    - a. When near the max altitude or max distance.
    - b. When the aircraft disconnects from the remote controller or DJI Fly.
    - c. When the aircraft senses an obstacle and thus brakes and hovers in place.
    - d. During RTH or auto landing.
  - Cruise control will exit automatically when switching flight modes.
  - The obstacle sensing in Cruise Control follows the current flight mode. Fly with caution.
-

# Aircraft

---

DJI Air 3 contains a flight controller, video downlink system, vision systems, three-dimensional infrared sensing system, propulsion system, and an Intelligent Flight Battery.

# Aircraft

DJI Air 3 includes a flight controller, video downlink system, vision system, propulsion system, and an Intelligent Flight Battery.

## Flight Modes

DJI Air 3 has three flight modes, plus a fourth flight mode that the aircraft switches to in certain scenarios. Flight modes can be switched via the Flight Mode switch on the remote controller.

### Normal Mode

The aircraft utilizes GNSS, the omnidirectional vision system, the downward vision system, and the three-dimensional infrared sensing system to locate and stabilize itself. When the GNSS signal is strong, the aircraft uses GNSS to locate itself and stabilize. When the GNSS is weak, but the lighting and other environmental conditions are sufficient, the aircraft uses the vision systems for positioning. When the vision systems are enabled, and lighting and other environmental conditions are sufficient, the maximum pitch angle is 30° and the maximum flight speed is 12 m/s.

### Sport Mode

In Sport Mode, the aircraft utilizes GNSS and the downward vision system for positioning, and the aircraft responses are optimized for agility and speed, making it more responsive to control stick movements. The maximum flight speed is 21 m/s. Note that obstacle sensing is disabled in Sport Mode.

### Cine Mode

Cine mode is based on Normal mode with a limited flight speed, making the aircraft more stable during shooting.

The aircraft automatically changes to Attitude (ATTI) mode when the vision systems are unavailable or disabled and when the GNSS signal is weak or the compass experiences interference. In ATTI mode, the aircraft may be more easily affected by its surroundings. Environmental factors such as wind can result in horizontal shifting, which may present hazards especially when flying in confined spaces. The aircraft will not be able to hover or brake automatically, therefore the pilot should land the aircraft as soon as possible to avoid accidents.



• The flight modes are only effective for manual flight and cruise control.



- The vision systems are disabled in Sport mode, which means the aircraft cannot sense obstacles on its route automatically. The user must stay alert to the surrounding environment and control the aircraft to avoid obstacles.
- The maximum speed and braking distance of the aircraft significantly increase in Sport mode. A minimum braking distance of 30 m is required in windless conditions.
- A minimum braking distance of 10 m is required in windless conditions while the aircraft is ascending and descending in Sport mode or Normal mode.
- The responsiveness of the aircraft significantly increases in Sport mode, which means a small control stick movement on the remote controller translates into the aircraft moving a large distance. Make sure to maintain adequate maneuvering space during flight.
- The maximum flight speed is 19 m/s in the EU.

## Aircraft Status Indicator

DJI Air 3 has front LEDs and aircraft status indicators.

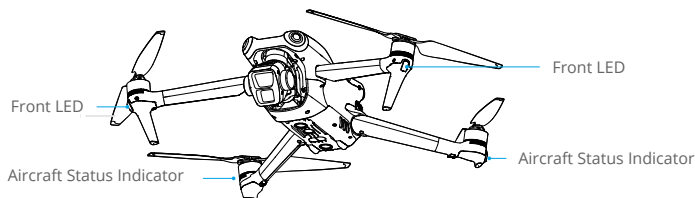

When the aircraft is powered on but the motors are not running, the front LEDs glow solid green.

**When the aircraft is powered on but the motors are not running**, the aircraft status indicators will display the current status of the flight control system. Refer to the table below for more information about the aircraft status indicators.

### Aircraft Status Indicator Descriptions

#### Normal States

|  |   |  |
|--|---|--|
|  | Blinks red, yellow, and green alternately | Powering on and performing self-diagnostic tests |
|  | Blinks green slowly                       | GNSS enabled                                     |
|  | Blinks green twice repeatedly             | Vision systems enabled                           |

#### Warning States

|  |                                   |  |
|--|-----------------------------------|--|
|  | Blinks yellow quickly             | Remote controller signal lost          |
|  | Blinks red slowly                 | Takeoff is disabled, e.g. low battery* |
|  | Blinks red quickly                | Critically low battery                 |
|  | Solid red                         | Critical error                         |
|  | Blinks red and yellow alternately | Compass calibration required           |

\* If the aircraft cannot take off while the status indicators are blinking red slowly, view the warning prompt in DJI Fly.

**After the motor starts**, the front LEDs blink green, and the aircraft status indicators blink red and green alternately. The green lights indicate the aircraft is a UAV, and the green and red lights indicate the heading and position of the aircraft.

- ⚠ • To obtain better footage, the front LEDs turn off automatically when shooting if the front LEDs are set to auto in DJI Fly. Lighting requirements vary depending on the region. Observe local laws and regulations.



## Return to Home

The Return to Home (RTH) function brings the aircraft back to the last recorded Home Point. The RTH can be triggered in three ways: the user actively triggers RTH, the aircraft has low battery, or the control signal between the remote controller and the aircraft is lost. If the aircraft records the Home Point successfully and the positioning system is functioning normally, when the RTH function is triggered, the aircraft will automatically fly back and land at the Home Point.

| 📖          | GNSS            | Descriptions  |
|------------|-----------------|---|
| Home Point | 📶 <sup>10</sup> | <p>The first location where the aircraft receives a strong to moderately strong GNSS signal (indicated by a white icon) will be recorded as the default Home Point. The Home Point can be updated before takeoff as long as the aircraft receives another strong to moderately strong GNSS signal. If the signal is weak, the Home Point will not be updated. After the Home Point is recorded, DJI Fly will issue a voice prompt.</p> <p>If it is necessary to update the Home Point during a flight (such as where the position of the user has changed), the Home Point can be manually updated in Settings &gt; Safety page in DJI Fly.</p> |

During RTH, the aircraft will automatically adjust the gimbal tilt to point the camera toward the RTH route by default. If the video transmission signal is normal, the AR Home Point, AR RTH route, and AR aircraft shadow will be displayed in the camera view by default. This improves the flight experience by helping users view the RTH route and Home Point and avoid obstacles on the route. The display can be changed in System Settings > Safety > AR Settings.

- ⚠️ • The AR RTH route is only used for reference, and may deviate from the actual flight route in different scenarios. Always pay attention to the liveview on the screen during RTH. Fly with caution.
- During RTH, use the gimbal dial to adjust the camera orientation or press the customizable buttons on the remote controller to recenter the camera will stop the aircraft from automatically adjusting the gimbal tilt, which may prevent the AR RTH route from being viewed.
- When reaching the Home Point, the aircraft will automatically adjust the gimbal tilt vertically down.

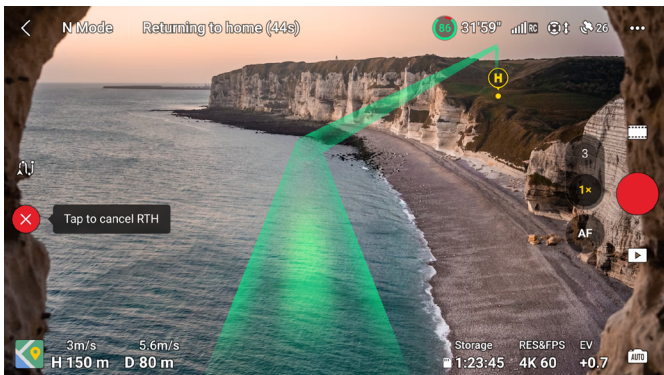

## Advanced RTH

When Advanced RTH is triggered, the aircraft will automatically plan the best RTH path, which will be displayed in DJI Fly and will adjust according to the environment.

If the control signal between the remote controller and the aircraft is good, exit RTH by tapping  in DJI Fly or by pressing the RTH button on the remote controller. After exiting RTH, users will regain control of the aircraft.

### Trigger Method

- **The user actively triggers RTH**

Advanced RTH can be initiated either by tapping  in DJI Fly or by pressing and holding the RTH button on the remote controller until it beeps.

- **Aircraft low battery**

When the Intelligent Flight Battery level is too low and there is not enough power to return home, land the aircraft as soon as possible.

To avoid unnecessary danger caused by insufficient power, the aircraft automatically calculates if the battery power is sufficient to return to the Home Point according to the current position, environment, and flight speed. A warning prompt will appear in DJI Fly when the battery level is low and only enough to complete an RTH flight. The aircraft will automatically fly to the Home Point if no action is taken after a countdown.

The user can cancel RTH by pressing the RTH button on the remote controller. If RTH is canceled following the warning, the Intelligent Battery may not have enough power for the aircraft to land safely, which may lead to the aircraft crashing or being lost.

The aircraft will land automatically if the current battery level can only support the aircraft long enough to descend from its current altitude. Auto landing cannot be canceled, but the remote controller can be used to control the horizontal movement and the descent speed of the aircraft during landing. If there is sufficient power, the throttle stick can be used to make the aircraft ascend at a speed of 1 m/s.

During auto landing, move the aircraft horizontally to find an appropriate place to land as soon as possible. The aircraft will fall if the user keeps pushing the throttle stick upward until the power is depleted.

- **Loss of remote controller signal**

The action of the aircraft when the remote controller signal is lost can be set to RTH, land, or hover in Setting > Safety > Advanced Safety Settings in DJI Fly. If the action is set to RTH, the Home Point was successfully recorded and the compass is functioning normally, Failsafe RTH automatically activates after the remote controller signal is lost for more than six seconds.

When the lighting is sufficient and the environment is suitable for the vision systems to work normally, DJI Fly will display the RTH path that was generated by the aircraft before the remote controller signal was lost. The aircraft will start RTH using Advanced RTH according to the RTH settings. The aircraft will remain in RTH even if the remote controller signal is restored. DJI Fly will update the RTH path accordingly.

When the lighting is not sufficient or the environment is not suitable for the vision systems to work normally, the aircraft will enter Original Route RTH. The aircraft will enter or remain in Preset RTH if the remote controller signal is restored during RTH. The Original Route RTH procedure is as follows:

1. The aircraft brakes and hovers in place.
2. When RTH begins:
  - If the RTH distance (the horizontal distance between the aircraft and the Home Point) is farther than 50 m, the aircraft adjusts its orientation and flies backward for 50 m on its original flight route before entering Preset RTH.
  - If the RTH distance is farther than 5 m but less than 50 m, it adjusts its orientation and flies to the Home Point in a straight line at the current altitude.
  - The aircraft lands immediately if the RTH distance is less than 5 m.
3. The aircraft begins to land when it reaches above the Home Point.

- 
-  If RTH is triggered through DJI Fly and the RTH distance is farther than 5 m, DJI Fly will display the two following options: RTH and Landing. Users can select either RTH or directly land the aircraft.
- The aircraft may not be able to return to the Home Point normally if the positioning system is functioning abnormally. During Failsafe RTH, the aircraft may enter ATTI mode and land automatically if the positioning system is functioning abnormally.
  - It is important to set a suitable RTH altitude before each flight. Launch DJI Fly and set the RTH altitude. The default RTH altitude is 100 m.
  - The aircraft cannot sense obstacles during Failsafe RTH if the vision systems are unavailable.
  - GEO zones may affect the RTH. Avoid flying near GEO zones.
  - The aircraft may not be able to return to a Home Point when the wind speed is too high. Fly with caution.
  - Pay extra attention to small or fine objects (such as tree branches or power lines) or transparent objects (such as water or glass) during RTH. Exit RTH and control the aircraft manually in an emergency.
- 

## RTH Procedure

1. The Home Point is recorded.
2. Advanced RTH is triggered.
3. The aircraft brakes and hovers in place. When RTH begins:
  - The aircraft lands immediately if the RTH distance is less than 5 m.
  - If the RTH distance is farther than 5 m, the aircraft will adjust its orientation to the Home Point and plan the best path according to the RTH settings, lighting, and environmental conditions.
4. The aircraft will fly automatically according to the RTH settings, environment, and transmission signal during RTH.
5. The aircraft lands and the motors stop after reaching the Home Point.

## RTH Settings

RTH settings are available for Advanced RTH. Go to the camera view in DJI Fly, tap Settings > Safety, and then RTH.

## 1. Optimal:



- If the lighting is sufficient and the environment is suitable for the vision systems, the aircraft will automatically plan the optimal RTH path and adjust the altitude according to environmental factors, such as obstacles and transmission signals, regardless of the RTH Altitude setting. The optimal RTH path means the aircraft will travel the shortest distance possible to reduce the amount of battery power used and to increase flight time.
- If the lighting is insufficient or the environment is not suitable for the vision systems, the aircraft will execute Preset RTH based on the RTH Altitude setting.

## 2. Preset:



| Lighting and Environment Conditions |                                 | Suitable for Vision Systems   | Unsuitable for Vision Systems   |
|-------------------------------------|---------------------------------|---|---|
| RTH distance > 50 m                 | Current altitude < RTH altitude | The aircraft will plan the RTH path, fly to an open area while bypassing obstacles, ascend to the RTH Altitude, and return to home using the best path. | The aircraft will ascend to the RTH altitude, and fly to the Home Point in a straight line at the RTH altitude. |
|                                     | Current altitude ≥ RTH altitude | The aircraft will return to home using the best path at the current altitude.   | The aircraft will fly to the Home Point in a straight line at the current altitude.                             |
| RTH distance is within 5-50 m       |                                 |   |   |

When the aircraft is approaching the Home Point, if the current altitude is higher than the RTH altitude, the aircraft will intelligently decide whether to descend while flying forward according to the surrounding environment, lighting, the set RTH altitude, and the current altitude. When the aircraft reaches above the Home Point, the current altitude of the aircraft will not be lower than the set RTH altitude. **Note that when the lighting is insufficient or the environment is not suitable for the vision systems, the aircraft cannot avoid obstacles. Make sure to set a safe RTH altitude and pay attention to the surrounding environment to ensure flight safety.**

The RTH plans for different environments, RTH trigger methods, and RTH settings are as follows:

| Lighting and Environment Conditions | Suitable for Vision Systems   | Unsuitable for Vision Systems   |
|-------------------------------------|---|---|
| The user actively triggers RTH      | The aircraft can bypass obstacles and GEO zones   | The aircraft cannot bypass obstacles but can bypass GEO zones               |
| Aircraft low battery                | The aircraft will execute RTH based on the RTH setting: <ul style="list-style-type: none"> <li>• Optimal</li> <li>• Preset</li> </ul> | Preset  |
| Loss of remote controller signal    |   | Original route RTH, Preset RTH will be executed when the signal is restored |

-  • During Advanced RTH, the aircraft will adjust the flight speed automatically to suit environmental factors such as wind speed and obstacles.
- The aircraft cannot avoid small or fine objects such as tree branches or power lines. Fly the aircraft to an open area before using RTH.
  - Set Advanced RTH as Preset if there are power lines or towers that the aircraft cannot bypass on the RTH path and make sure the RTH Altitude is set higher than all obstacles.
  - The aircraft will brake and return to home according to the latest settings if the RTH settings are changed during RTH.
  - If the max altitude is adjusted below the current altitude during RTH, the aircraft will descend to the max altitude first and then continue returning to home.
  - The RTH Altitude cannot be changed during RTH.
  - If there is a large difference between the current altitude and the RTH altitude, the amount of battery power used cannot be calculated accurately due to wind speed difference at different altitudes. Pay extra attention to the battery power prompts and warning prompts in DJI Fly.
  - During Advanced RTH, the aircraft will enter Preset RTH if the lighting condition or environment becomes unsuitable for the vision systems. In this case, the aircraft cannot bypass the obstacles. An appropriate RTH altitude must be set before entering RTH.
  - When the remote controller signal is normal during Advanced RTH, the pitch stick can be used to control the flight speed, but the orientation and altitude cannot be controlled and the aircraft cannot be controlled to fly to the left or right. Constantly pushing the pitch stick to accelerate will increase the battery power consumption speed. The aircraft cannot bypass obstacles if the flight speed exceeds the effective sensing speed. The aircraft will brake and hover in place and exit RTH if the pitch stick is pushed all the way down. The aircraft can be controlled after the pitch stick is released.
  - If the aircraft reaches the altitude limit of the aircraft current location or of the Home Point while it is ascending during Preset RTH, the aircraft stops ascending and returns to the Home Point at the current altitude. Pay attention to flight safety during RTH.
  - If the Home Point is within the Altitude Zone but the aircraft is not, when the aircraft reaches the Altitude Zone it will descend below the altitude limit, which may be lower than the set RTH altitude. Fly with caution.

- The aircraft will bypass any GEO zones encountered when it is flying forward during Advanced RTH. Fly with caution.
  - The aircraft will exit RTH if the surrounding environment is too complex to complete RTH, even if the vision systems are working properly.
- 

## Landing Protection

Landing Protection will activate during RTH.

Landing Protection is enabled once the aircraft begins to land.

1. During Landing Protection, the aircraft will automatically detect and carefully land on suitable ground.
2. If the ground is determined unsuitable for landing, the aircraft will hover and wait for pilot confirmation.
3. If Landing Protection is not operational, DJI Fly will display a landing prompt when the aircraft descends to 0.5 m from the ground. Tap confirm or push the throttle stick all the way down and hold for one second, and the aircraft will land.

## Precision Landing

The aircraft automatically scans and attempts to match the terrain features below during RTH. The aircraft will land when the current terrain matches the Home Point. A prompt will appear in DJI Fly if the terrain match fails.

---



- Landing Protection is activated during Precision Landing.
  - The performance of Precision Landing is subject to the following conditions:
    - a. The Home Point must be recorded upon takeoff and must not be changed during flight. Otherwise, the aircraft will have no record of the terrain features of the Home Point.
    - b. During takeoff, the aircraft must ascend at least 7 m before moving horizontally.
    - c. The Home Point terrain features must remain largely unchanged.
    - d. The terrain features of the Home Point must be sufficiently distinctive. Terrain such as a snow-covered field is not suitable.
    - e. The lighting conditions must not be too bright or too dark.
  - The following actions are available during Precision Landing:
    - a. Press the throttle stick down to accelerate landing.
    - b. Movement of any other control stick apart from the throttle stick will be regarded as giving up Precision Landing. The aircraft will descend vertically after the control sticks are released. Landing Protection is still effective in this case.
-

## Vision Systems and Three-Dimensional Infrared Sensing System

DJI Air 3 is equipped with both an omnidirectional vision system (forward, backward, lateral, upward), the downward vision system, and the three-dimensional infrared sensing system, which allows for positioning and omnidirectional obstacle sensing.

The omnidirectional vision system consists of four cameras which are located at the front and rear of the aircraft. The downward vision system consists of two cameras, located at the bottom of the aircraft. The vision systems sense obstacles by image ranging.

The three-dimensional infrared sensing system located at the bottom of the aircraft consists of a three-dimensional infrared emitter and a receiver. The three-dimensional infrared sensing system helps the aircraft to assess the distance to obstacles, the distance to the ground, and calculate the aircraft position together with the downward vision system. The three-dimensional infrared sensing system meets the human eye safety requirement for Class 1 laser products.

In addition, the Auxiliary Light located at the bottom of the aircraft can assist the downward vision system. It will automatically turn on by default in low-light environments when the flight altitude is under 5 m. Users can also turn it on or off manually in DJI Fly. Each time the aircraft is restarted, the auxiliary light will revert back to the default setting Auto.

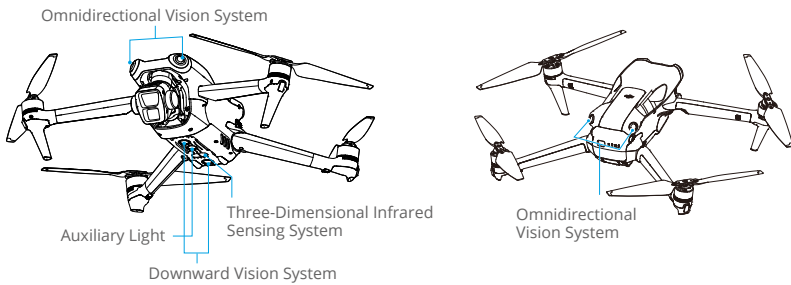

## Detection Range

|  |   |
|--|---|
| <b>Forward Vision System</b>                     | Precision Measurement Range: 0.5-18 m;<br>FOV: 90° (horizontal), 72° (vertical)                               |
| <b>Backward Vision System</b>                    | Precision Measurement Range: 0.5-18 m;<br>FOV: 90° (horizontal), 72° (vertical)                               |
| <b>Lateral Vision System</b>                     | Precision Measurement Range: 0.5-30 m;<br>FOV: 90° (horizontal), 72° (vertical)                               |
| <b>Upward Vision System<sup>[1]</sup></b>        | Precision Measurement Range: 0.5-18 m;<br>FOV: 72° (front and back), 90° (left and right)                     |
| <b>Downward Vision System</b>                    | Precision Measurement Range: 0.3-14 m;<br>FOV: 106° (front and back), 90° (left and right)                    |
| <b>Three-Dimensional Infrared Sensing System</b> | Precision Measurement Range: 0.1-8 m (> 10% reflectivity);<br>FOV: 60° (front and back), 60° (left and right) |

[1] The omnidirectional vision system can sense obstacles in horizontal directions and above.

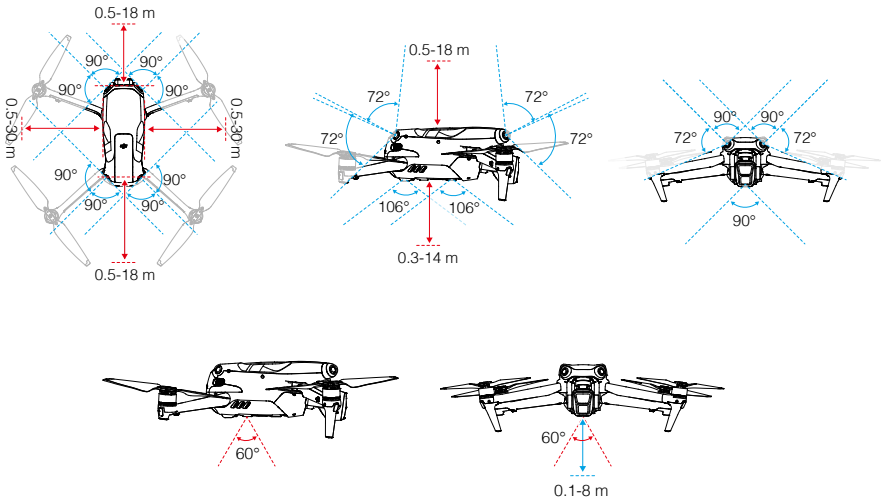

## Using the Vision Systems

The positioning function of the downward vision system is applicable when GNSS signals are unavailable or weak. It is automatically enabled in Normal or Cine mode.

The omnidirectional vision system will activate automatically when the aircraft is in Normal or Cine mode and Obstacle Avoidance is set to Bypass or Brake in DJI Fly. The omnidirectional vision system works best with adequate lighting and clearly marked or textured obstacles. Due to inertia, users must make sure to brake the aircraft within a reasonable distance.

- ⚠ • Pay attention to the flight environment. The vision systems and the three-dimensional infrared sensing system only work in certain scenarios and cannot replace human control and judgment. During a flight, always pay attention to the surrounding environment and the warnings in DJI Fly, and be responsible for and maintain control of the aircraft at all times.
- The downward vision system works best when the aircraft is at an altitude from 0.5 to 30 m if there is no GNSS available. Extra caution is required if the altitude of the aircraft is above 30 m as the vision positioning performance may be affected.
- In low-light environments, the vision systems may not achieve optimal positioning performance even if the auxiliary light is turned on. Fly with caution if the GNSS signal is weak in such environments.
- The downward vision system may not work properly when the aircraft is flying near water. Therefore, the aircraft may not be able to actively avoid water below it when landing. It is recommended to maintain flight control at all times, make reasonable judgments based on the surrounding environment, and avoid over-relying on the downward vision system.



- The vision systems cannot accurately identify large frame structures with frames and cables, such as tower cranes, high-voltage transmission towers, high-voltage transmission lines, cable-stayed bridges and suspension bridges.
  - The vision systems cannot work properly near surfaces without clear pattern variations or where the light is too weak or too strong. The vision systems cannot work properly in the following situations:
    - a. Flying near monochrome surfaces (e.g., pure black, white, red, or green).
    - b. Flying near highly reflective surfaces.
    - c. Flying near water or transparent surfaces.
    - d. Flying near moving surfaces or objects.
    - e. Flying in an area with frequent and drastic lighting changes.
    - f. Flying near extremely dark (< 10 lux) or bright (> 40,000 lux) surfaces.
    - g. Flying near surfaces that strongly reflect or absorb infrared waves (e.g., mirrors).
    - h. Flying near surfaces without clear patterns or textures.
    - i. Flying near surfaces with repeating identical patterns or textures (e.g., tiles with the same design).
    - j. Flying near obstacles with small surface areas (e.g., tree branches and power lines).
  - Keep the sensors clean at all times. DO NOT scratch or tamper with the sensors. DO NOT use the aircraft in dusty or humid environments.
  - Vision system cameras may need to be calibrated after being stored for an extended period. A prompt will appear in DJI Fly and calibration will be performed automatically.
  - DO NOT fly when it is rainy, smoggy, or the visibility is lower than 100 m.
  - Check the following each time before takeoff:
    - a. Make sure there are no stickers or any other obstructions over the glass of the infrared sensing systems and vision systems.
    - b. Use soft cloth if there is any dirt, dust, or water on the glass of the vision systems and infrared sensing system. DO NOT use any cleaning product that contains alcohol.
    - c. Contact DJI Support if there is any damage to the lenses of the infrared sensing and vision systems.
  - DO NOT obstruct the infrared sensing system and vision systems.
  - The aircraft can fly at any time of the day or night. However, the vision systems become unavailable when flying the aircraft at night. Fly with caution.
-

## Advanced Pilot Assistance Systems (APAS)

The Advanced Pilot Assistance Systems (APAS) feature is available in Normal mode and Cine mode. When APAS is enabled, the aircraft will continue to respond to user commands and plan its path according to both control stick inputs and the flight environment. APAS makes it easier to bypass obstacles, obtain smoother footage, and provide a better flying experience.

Keep moving the control sticks in any direction. The aircraft will bypass obstacles by flying above, below, or to the left or right of the obstacle. The aircraft can also respond to the control stick inputs while bypassing obstacles.

When APAS is enabled, the aircraft can be stopped by pressing the Flight Pause button on the remote controller. The aircraft brakes and hovers for three seconds and awaits further pilot commands.

To enable APAS, open DJI Fly, enter Settings > Safety, and enable APAS by selecting Bypass. Select Normal or Nifty mode when using Bypass. In Nifty mode, the aircraft can fly faster, smoother, and closer to obstacles, obtaining better footage while bypassing obstacles. However, the risk of crashing into obstacles will increase. Fly with caution.

Nifty mode cannot work normally in the following situations:

1. When aircraft orientation changes rapidly flying near obstacles.
2. When flying through narrow obstacles such as canopies or bushes at high speed.
3. When flying near obstacles that are too small to detect.
4. When flying with the propeller guard.

## Landing Protection

Landing Protection will activate if Obstacle Avoidance is set to Bypass or Brake and the user pulls the throttle stick down to land the aircraft. Landing Protection is enabled once the aircraft begins to land.

- During Landing Protection, the aircraft will automatically detect if an area is suitable for landing, and then land the aircraft.
- If the ground is determined to be unsuitable for landing, the aircraft will hover when the aircraft descends to 0.8 m above ground. Pull down on the throttle stick for at least five seconds, and the aircraft will land without obstacle sensing.



- Make sure to use APAS when the vision systems are available. Make sure there are no people, animals, objects with small surface areas (e.g., tree branches), or transparent objects (e.g., glass or water) along the desired flight path.
  - Make sure to use APAS when the downward vision systems are available or the GNSS signal is strong. APAS may not function properly when the aircraft is flying over water or snow-covered areas.
  - Be extra cautious when flying in extremely dark (<300 lux) or bright (>10,000 lux) environments.
  - Pay attention to DJI Fly and make sure APAS is working normally.
  - APAS may not function properly when the aircraft is flying near flight limits or in a GEO zone.
-

## Flight Recorder

Flight data including flight telemetry, aircraft status information, and other parameters are automatically saved to the internal data recorder of the aircraft. The data can be accessed using DJI Assistant 2 (Consumer Drones Series).

## Propellers

There are two types of DJI Air 3 Low-Noise Quick Release propellers, which are designed to spin in different directions. Marks are used to indicate which propellers should be attached to which motors. Make sure to match the propeller and motor following the instructions.

### Attaching the Propellers

There are two types of propellers in the package of DJI Air 3, which are propellers A and propellers B. The packaging of the two propeller types is labeled with A and B respectively, together with the installation location illustrations. Attach propellers A with grey circle marks to the motors with grey marks. Likewise, attach propellers B without marks to the motors without marks. Hold the motor with one hand, press the propeller down with the other hand, and rotate in the direction of the arrows marked on the propeller until it pops up and locks in place. Unfold the propeller blades.

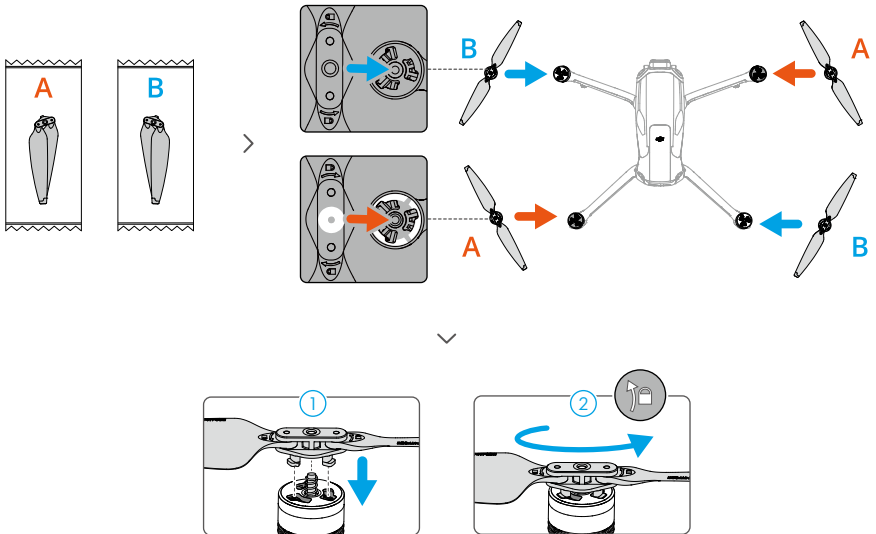

## Detaching the Propellers

Press the propellers down onto the motors and rotate them in the unlock direction.

- ⚠ • The propeller blades are sharp. Handle with care.
- Only use official DJI propellers. DO NOT mix propeller types.
- Propellers are consumable components. Purchase additional propellers if necessary.
- Make sure that the propellers and motors are installed securely before each flight.
- Make sure that all propellers are in good condition before each flight. DO NOT use aged, chipped, or broken propellers.
- To avoid injury, stay away from rotating propellers or motors.
- To avoid damaging the propellers, place the aircraft correctly during transportation or storage. DO NOT squeeze or bend the propellers. If propellers are damaged, the flight performance may be affected.
- Make sure the motors are mounted securely and rotating smoothly. Land the aircraft immediately if a motor is stuck and unable to rotate freely.
- DO NOT attempt to modify the structure of the motors.
- DO NOT touch or let hands or body parts come in contact with the motors after flight, as they may be hot.
- DO NOT block any of the ventilation holes on the motors or the body of the aircraft.
- Make sure the ESCs sound normal when powered on.

## Intelligent Flight Battery

DJI Air 3 Intelligent Flight Battery is a 14.76V and 4241mAh battery with smart charging and discharging functionality.

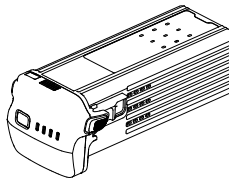

### Battery Features

1. **Battery Level Display:** the battery level LEDs display the current battery level.
2. **Auto-Discharging Function:** to prevent swelling, the battery automatically discharges to 96% of the battery level when it is idle for three days, and automatically discharges to 60% of the battery level when it is idle for nine days. It is normal to feel moderate heat being emitted from the battery during the discharging process.
3. **Balanced Charging:** during charging, the voltages of the battery cells are automatically balanced.

4. Overcharge Protection: the battery stops charging automatically once fully charged.
5. Temperature Detection: to prevent damage, the battery only charges when the temperature is between 5° and 40° C (41° and 104° F).
6. Overcurrent Protection: the battery stops charging if an excess current is detected.
7. Over-Discharge Protection: discharging stops automatically to prevent excess discharge when the battery is not in use. Over-discharge protection is not enabled when the battery is in use.
8. Short Circuit Protection: the power supply is automatically cut if a short circuit is detected.
9. Battery Cell Damage Protection: the app will display a warning prompt when a damaged battery cell is detected.
10. Hibernation Mode: the battery switches off after 5 to 20 seconds of inactivity to save power. If the battery level is less than 5%, the battery enters Hibernation mode to prevent over-discharge after being idle for six hours. In Hibernation mode, the battery level LEDs do not illuminate when the power button is pressed. Charge the battery to wake it from hibernation.
11. Communication: information about the voltage, capacity, and current of the battery is transmitted to the aircraft.
12. Maintenance Instructions: the battery automatically checks the voltage differences between battery cells and decides whether maintenance is required. If maintenance is required, the four battery level LEDs will blink twice every second and blink for two seconds when the user presses the power button to check the battery level. In this case, if the battery is inserted into the aircraft and powered on, the aircraft will not be able to take off, and a prompt for maintenance will appear in DJI Fly. If the battery level LEDs blink for maintenance or the maintenance prompt appears in DJI Fly, follow the prompt to fully charge the battery and then let it rest for 48 hours. If the battery still does not work after two times of maintenance, contact DJI Support.

---

 • Refer to the Safety Guidelines and the stickers on the battery before use. Users take full responsibility for any violations of the safety requirements stated on the label.

---



## Using the Battery



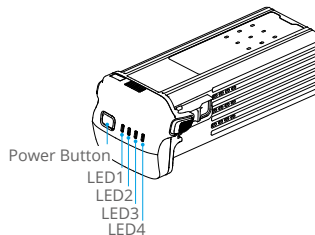





























### Checking the Battery Level

Press the power button once to check the battery level when the battery is powered off.



 The battery level LEDs display the power level of the battery during discharging. The statuses of the LEDs are defined below:

 : LED is on       : LED is flashing       : LED is off

| LED1  | LED2  | LED3  | LED4  | Battery Level |
|---|---|---|---|---------------|
|  |  |  |  | 88%-100%      |
|  |  |  |  | 76%-87%       |
|  |  |  |  | 63%-75%       |
|  |  |  |  | 51%-62%       |
|  |  |  |  | 38%-50%       |
|  |  |  |  | 26%-37%       |
|  |  |  |  | 13%-25%       |
|  |  |  |  | 0%-12%        |

## Powering On/Off

Press the power button once and then press again and hold for two seconds to power the battery on or off. The battery level LEDs display the battery level when the battery is powered on. The battery level LEDs turn off when the battery is powered off.

## Low Temperature Notice

1. Battery capacity is significantly reduced when flying at low temperatures from -10° to 5° C (14° to 41° F). It is recommended to hover the aircraft in place for a while to heat the battery. Make sure to fully charge the battery before takeoff.
2. Batteries cannot be used in extremely low-temperature environments of lower than -10° C (14° F).
3. When in low-temperature environments, end the flight as soon as DJI Fly displays the low battery level warning.
4. To ensure optimal performance, keep the battery temperature above 20° C (68° F).
5. The reduced battery capacity in low-temperature environments reduces the wind speed resistance performance of the aircraft. Fly with caution.
6. Take extra caution when flying at a high elevation with a low temperature.

## Charging the Battery

Fully charge the battery before each use. It is recommended to use the charging devices provided by DJI, such as the DJI Air 3 Battery Charging Hub, DJI 100W USB-C Power Adapter, DJI 65W Portable Charger, or other USB Power Delivery chargers. Visit the official DJI online store for more information about DJI official charging devices.

## Using a Charger

1. Connect a charger to an AC power supply (100-240V, 50/60 Hz; use a power cable with suitable specifications for charging, and use a power adapter if necessary).
2. Connect the aircraft to the charger using the battery charging cable with the battery powered off.
3. The battery level LEDs display the current battery level during charging.

4. The battery is fully charged when all the battery level LEDs are off. Detach the charger when the battery is fully charged.

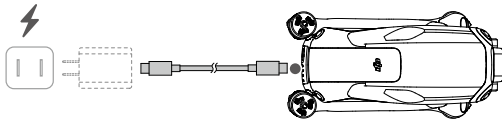

- ⚠ • DO NOT charge an Intelligent Flight Battery immediately after flight as it may be too hot. Wait for the battery to cool down to room temperature before charging again.
  - The charger stops charging the battery if the battery cell temperature is not within 5° to 40° C (41° to 104° F). The ideal charging temperature is from 22° to 28° C (71.6° to 82.4° F).
  - Fully charge the battery at least once every three months to maintain battery health.
- 
- 💡 • It is recommended to discharge the batteries to 30% or lower before transportation. This can be done by flying the aircraft outdoors until there is less than 30% charge left.

The table below shows the battery level LED statuses during charging.

| LED1 | LED2 | LED3 | LED4 | Battery Level |
|------|------|------|------|---------------|
|      |      |      |      | 0%-50%        |
|      |      |      |      | 51%-75%       |
|      |      |      |      | 76%-99%       |
|      |      |      |      | 100%          |

## Using the Charging Hub



Visit the link below to watch the tutorial videos for DJI Air 3 Battery Charging Hub.



<https://s.dji.com/guide65>

The DJI Air 3 Battery Charging Hub is designed to charge up to three Intelligent Flight Batteries. After the Intelligent Flight Batteries are installed, the charging hub can supply power to external devices via the USB-C port, such as remote controllers or mobile phones. The charging hub can also use the power accumulation function to transfer the remaining power of multiple low-power batteries into the battery with the highest remaining power.

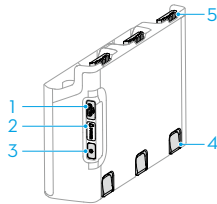

1. USB-C Connector
2. Status LED
3. Function Button
4. Battery Release Button
5. Battery Port

- 
- ⚠** • The charging hub is only compatible with BWX233-4241-14.76 Intelligent Flight Battery. DO NOT use the charging hub with other battery models.
- Place the charging hub on a flat and stable surface with good ventilation when charging an external device or accumulating power. Make sure the device is properly insulated to prevent fire hazards.
  - DO NOT touch the metal terminals on the battery ports. Clean the metal terminals with a clean and dry cloth if there is any noticeable buildup.
  - Make sure to charge batteries with low battery power in time. It is recommended to store the batteries in the charging hub. The charging hub automatically checks the battery power every seven days. When a battery has 0% power level, the battery with a high power level will charge the low power level battery until its power reaches 5% to prevent over-discharging.
- 

### Charging Intelligent Flight Battery

1. Insert the batteries into the charging hub until there is a click.
2. Connect the charging hub to a power outlet using a charger. It is recommended to use the DJI 100W USB-C Power Adapter. The Intelligent Flight Battery with the highest power level will be charged first, and then the rest will be charged in sequence according to their power levels. The status LED indicates the battery level during charging. Refer to the Status LED Descriptions for more information about the blinking patterns of the status LED.
3. The battery can be stored in the charging hub after charging. Press and hold the battery release button to remove the corresponding battery from the charging hub.



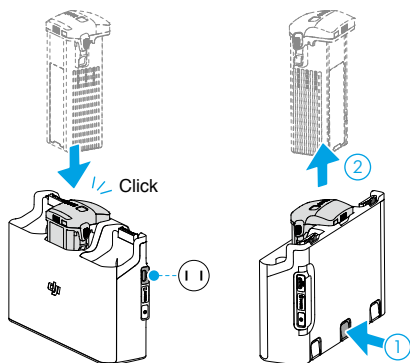

### Using Charging Hub as a Power Bank

1. Insert one or more batteries into the charging hub. Connect an external device via the USB-C port, such as a mobile phone or remote controller.
2. Press the function button, and the status LED of the charging hub turns solid green. The battery with the lowest power level will be discharged first, followed by the remaining batteries to be discharged sequentially.
3. To stop charging the external device, disconnect the external device from the charging hub.

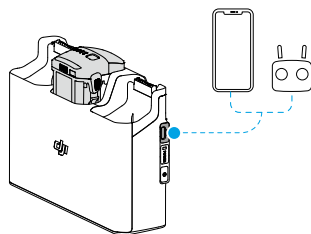





**⚠** • If the remaining charge of a battery is lower than 7%, the battery cannot charge the external device.

### Accumulating Power

1. Insert more than one battery into the charging hub, and press and hold the function button until the status LED turns green. The status LED of the charging hub pulses green, and the charge is transferred from the battery with the lowest power level to the battery with the highest power level.
2. To stop accumulating power, press and hold the function button until the status LED turns yellow. After stopping power accumulation, press the function button to check the power level of the batteries.

























- ⚠ • Power accumulation stops automatically in the following situations:
  - a. The receiving battery is fully charged, or the power of the output battery is lower than 5%.
  - b. A charger or external device is connected to the charging hub or any battery is inserted or withdrawn from the charging hub during power accumulation.
  - c. Power accumulation is interrupted for more than 15 minutes due to abnormal battery temperature.
- After accumulating power, charge the battery with the lowest power level as soon as possible to avoid discharge.

### Status LED Descriptions

| Blinking Pattern   | Description  |
|--|--|
|  —     | Solid yellow<br>The charging hub is idle   |
|  ····· | Pulses green<br>Charging the battery or accumulating power   |
|  —     | Solid green<br>All batteries fully charged or supplying power to external devices                                      |
|  ····· | Blinks yellow<br>Temperature of the batteries is too low or too high (no further operation needed)                     |
|  —     | Solid red<br>Power supply error or battery error (remove and reinsert the batteries or unplug and plug in the charger) |

### Battery Protection Mechanisms

The battery level LEDs can display battery protection notifications triggered by abnormal charging conditions.

| Battery Protection Mechanisms  |   |   |   |                                    |                                  |
|--|---|---|---|------------------------------------|----------------------------------|
| LED1   | LED2  | LED3  | LED4  | Blinking Pattern                   | Status                           |
|  |  |  |  | LED2 blinks twice per second       | Overcurrent detected             |
|  |  |  |  | LED2 blinks three times per second | Short circuit detected           |
|  |  |  |  | LED3 blinks twice per second       | Overcharge detected              |
|  |  |  |  | LED3 blinks three times per second | Over-voltage charger detected    |
|  |  |  |  | LED4 blinks twice per second       | Charging temperature is too low  |
|  |  |  |  | LED4 blinks three times per second | Charging temperature is too high |

If any of the battery protection mechanisms are activated, unplug the charger, and plug it in again to resume charging. If the charging temperature is abnormal, wait for it to return to normal. The battery will automatically resume charging without the need to unplug and plug the charger again.

## Inserting the Intelligent Flight Battery

Insert the Intelligent Flight Battery into the battery compartment of the aircraft. Make sure the battery is fully inserted with a clicking sound, which indicates the battery buckles are securely fastened.

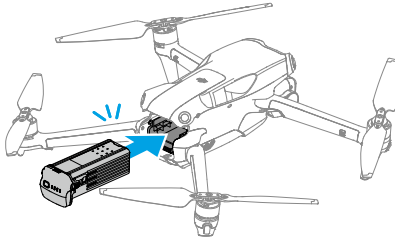

## Removing the Intelligent Flight Battery

Press the battery buckles on the sides of the battery to remove it from the compartment.

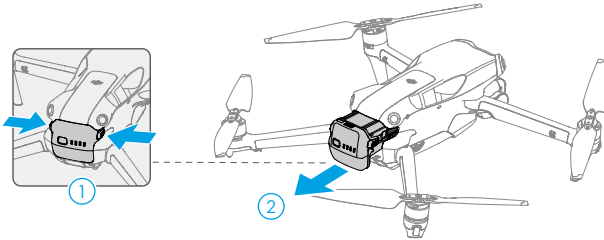

- DO NOT insert or remove the battery while the aircraft is powered on.
- Make sure the battery is mounted securely.

## Gimbal and Camera

### Gimbal Profile

The 3-axis gimbal stabilizes the camera, allowing you to capture clear and steady images and videos at high flight speed. The gimbal has a control tilt range of  $-90^{\circ}$  to  $+60^{\circ}$  and a control pan range of  $-5^{\circ}$  to  $+5^{\circ}$ .

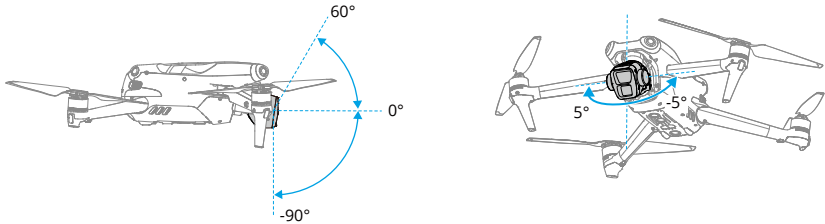

Use the gimbal dial on the remote controller to control the tilt of the gimbal. Alternatively, do so through the camera view in DJI Fly. Press and hold the screen until the gimbal adjustment bar appears. Drag the bar up or down to control the tilt and left or right to control the pan.

### Gimbal Operation Mode

Two gimbal operation modes are available. Switch between the different operation modes in DJI Fly.

**Follow Mode:** the angle of the gimbal remains stable relative to the horizontal plane. Users can adjust the gimbal tilt. This mode is suitable for shooting stills.

**FPV Mode:** when the aircraft is flying forward, the gimbal synchronizes with the movement of the aircraft to provide a first-person flying experience.

- ⚠ • DO NOT tap or knock the gimbal after the aircraft is powered on. Launch the aircraft from open and flat ground to protect the gimbal during takeoff.
- After installing the wide-angle lens, make sure the gimbal is level and forward before takeoff, so that the aircraft can correctly detect the installation status of the wide-angle lens. The gimbal will be level when the aircraft is powered on, if the gimbal rotates, recenter the gimbal using the remote controller or DJI Fly as follows:
  - a. Tap Recenter Gimbal on the Settings > Control page of DJI Fly.
  - b. Press the Fn button (DJI RC-N2) or the Customizable C1 Button (DJI RC 2) on the remote controller. The default function is recentering the gimbal or pointing the gimbal downward, which can be customized.
- Pano and Asteroid functions will not be available after the wide-angle lens is installed.
- Precision elements in the gimbal may be damaged by a collision or impact, which may cause the gimbal to function abnormally.
- Avoid getting dust or sand on the gimbal, especially in the gimbal motors.

- A gimbal motor may enter protection mode if the gimbal is obstructed by other objects when the aircraft is put on uneven ground or on grass, or if the gimbal experiences an excessive external force, such as during a collision.
- DO NOT apply external force to the gimbal after the aircraft is powered on.
- DO NOT add any extra payload other than an official accessory to the gimbal, as this may cause the gimbal to function abnormally or lead to permanent motor damage.
- Remove the gimbal protector before powering on the aircraft. Attach the gimbal protector when the aircraft is not in use.
- Flying in heavy fog or clouds may make the gimbal wet, leading to temporary failure. The gimbal will recover full functionality once it is dry.

## Camera Profile

DJI Air 3 features a dual-camera system which consists of a wide-angle camera and a medium tele camera, suitable for different shooting scenarios.

The wide-angle camera boasts a 1/1.3-in CMOS sensor with 48MP effective pixels. With an aperture of  $f/1.7$  and an equivalent focal length of 24 mm, the wide-angle camera can shoot from 1 m to infinity and can take 4K 60fps videos and 48MP photos. In addition, it supports up to 3x zoom.

The medium tele camera boasts a 1/1.3-in CMOS sensor with 48MP effective pixels. With an aperture of  $f/2.8$  and an equivalent focal length of 70 mm, the medium tele camera can shoot from 3 m to infinity and can take 4K 60fps videos and 48MP photos. In addition, it supports up to 9x zoom.



- DO NOT expose the camera lens in an environment with laser beams, such as a laser show, or point the camera at intense light sources for an extended period, such as the sun on a clear day, in order to avoid damaging the sensor.
- Make sure the temperature and humidity are suitable for the camera during use and storage.
- Use a lens cleanser to clean the lens to avoid damage or poor image quality.
- DO NOT block any ventilation holes on the camera as the heat generated may damage the device and injure the user.
- The cameras may not focus correctly in the following situations:
  - a. Shooting dark objects far away.
  - b. Shooting objects with repeating identical patterns and textures or objects without clear patterns or textures.
  - c. Shooting shiny or reflective objects (such as street lighting and glass).
  - d. Shooting flashing objects.
  - e. Shooting fast-moving objects.
  - f. When the aircraft/gimbal is moving fast.
  - g. Shooting objects with varying distances in the focus range.

## Storing and Exporting Photos and Videos

### Storing Photos and Videos

DJI Air 3 has 8 GB of built-in storage and supports the use of a microSD card to store your photos and videos. A SDXC, or UHS-I microSD card is required due to the fast read and write speeds necessary for high-resolution video data. Refer to the Specifications section for more information about recommended microSD cards.

### Exporting Photos and Videos

- Use QuickTransfer to export the footage to a mobile device.
- Connect the aircraft to a computer using a data cable, export the footage in the built-in storage of the aircraft or in the microSD card mounted on the aircraft. The aircraft does not need to be powered on during the exporting process.
- Remove the microSD card from the aircraft and insert it into a card reader, and export the footage in the microSD card through the card reader.



- DO NOT remove the microSD card from the aircraft when taking photos or videos. Otherwise, the microSD card may be damaged.
  - To ensure the stability of the camera system, single video recordings are limited to 30 minutes.
  - Check camera settings before use to ensure they are configured correctly.
  - Before shooting important photos or videos, shoot a few images to test whether the camera is operating correctly.
  - Make sure to power off the aircraft correctly. Otherwise, the camera parameters will not be saved, and any recorded videos may be affected. DJI is not responsible for any loss caused by an image or video recorded in a way that is not machine-readable.
-

## QuickTransfer

DJI Air 3 can connect directly to mobile devices via Wi-Fi, enabling users to download photos and videos from the aircraft to the mobile device through DJI Fly without using the remote controller. Users can enjoy faster and more convenient downloads with a transmission rate of up to 30 MB/s.

### Usage

#### Method 1: mobile device is not connected to the remote controller

1. Power on the aircraft and wait until the self-diagnostic tests of the aircraft are complete.
2. Make sure Bluetooth and Wi-Fi are enabled on the mobile device. Launch DJI Fly and a prompt will appear to connect to the aircraft.
3. Tap Connect. Once successfully connected, the files on the aircraft can be accessed and downloaded at high speed. When connecting the mobile device to the aircraft for the first time, press and hold the power button of the aircraft for two seconds to confirm.

#### Method 2: mobile device is connected to the remote controller

1. Make sure that the aircraft is connected to the mobile device via the remote controller and the motors are off.
2. Enable Bluetooth and Wi-Fi on the mobile device.
3. Launch DJI Fly, enter playback, and tap  in the upper right corner to access the files on the aircraft to download at high speed.



• DJI RC 2 does not support QuickTransfer.

- The maximum download rate can only be achieved in countries and regions where the 5.8 GHz frequency is permitted by laws and regulations, when using devices that support 5.8 GHz frequency band and Wi-Fi connection, and in an environment without interference or obstruction. If 5.8 GHz is not allowed by local regulations (such as in Japan), or the mobile device of the user does not support the 5.8 GHz frequency band, or the environment has severe interference, then QuickTransfer will use the 2.4 GHz frequency band and its maximum download rate will reduce to 6 MB/s.
  - Make sure that Bluetooth, Wi-Fi, and location services are enabled on the mobile device before using QuickTransfer.
  - When using QuickTransfer, it is not necessary to enter the Wi-Fi password on the settings page of the mobile device in order to connect. Launch DJI Fly and a prompt will appear to connect the aircraft.
  - Use QuickTransfer in an unobstructed environment with no interference and stay away from sources of interference such as wireless routers, Bluetooth speakers, or headphones.
-

# Remote Controller

---

This section describes the features of the remote controller and includes instructions for controlling the aircraft and the camera.



# Remote Controller

## DJI RC 2

The DJI RC 2 remote controller features O4 video transmission when used with DJI Air 3, and works at 2.4 GHz, 5.8 GHz, and 5.1 GHz frequency bands. It is capable of selecting the best transmission channel automatically and can transmit 1080p 60fps HD live view from the aircraft to the remote controller at a distance of up to 20 km (12.4 mi) (compliant with FCC standards, and measured in a wide open area without interference). Equipped with a 5.5-in touchscreen (1920×1080 pixel resolution) and a wide range of controls and customizable buttons, DJI RC 2 enables users to easily control the aircraft and remotely change the aircraft settings. DJI RC 2 comes with many other functions such as built-in GNSS (GPS+Galileo+BeiDou), Bluetooth and Wi-Fi connection.

The remote controller has detachable control sticks, built-in speakers, a 32GB internal storage, and supports the use of a microSD card for additional storage needs.

The 6200mAh 22.32Wh battery provides the remote controller a maximum operating time of three hours.

---

 • The 5.1 GHz band can be used only in countries and regions where it is permitted by local laws and regulations.

---

## Operation

### Powering On/Off

Press the power button once to check the current battery level.

Press once then press again and hold to power the remote controller on or off.

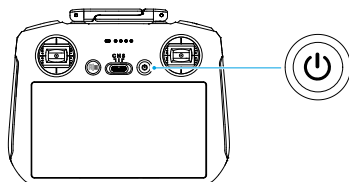

## Charging the Battery

Connect a charger to the USB-C port on the remote controller. It takes approximately 1 hour and 30 minutes to fully charge the remote controller (with a 9V/3A USB charger).

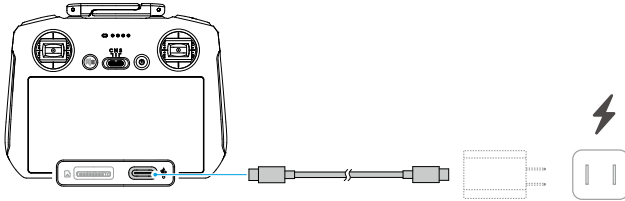

## Controlling the Gimbal and Camera

1. **Focus/Shutter Button:** press halfway down to auto-focus and press all the way down to take a photo.
2. **Record Button:** press once to start or stop recording.
3. **Camera Control Dial:** use to adjust the zoom by default. The dial function can be set to adjust the focal length, EV, aperture, shutter speed, and ISO.
4. **Gimbal Dial:** control the tilt of the gimbal.

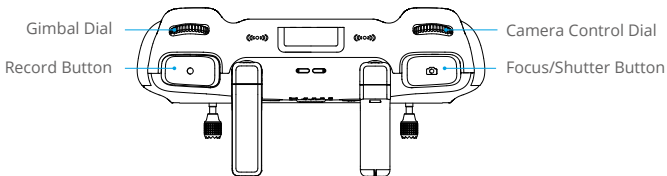

## Controlling the Aircraft

Three preprogrammed modes (Mode 1, Mode 2, and Mode 3) are available and custom modes can be configured in the DJI Fly app.

### Mode 1

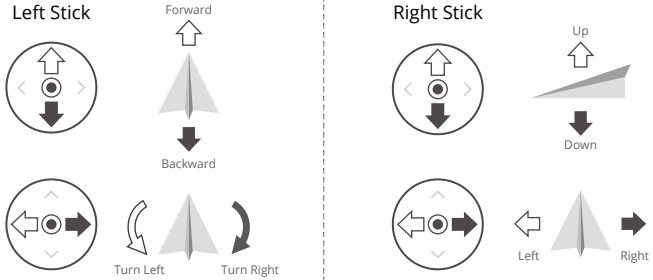

### Mode 2

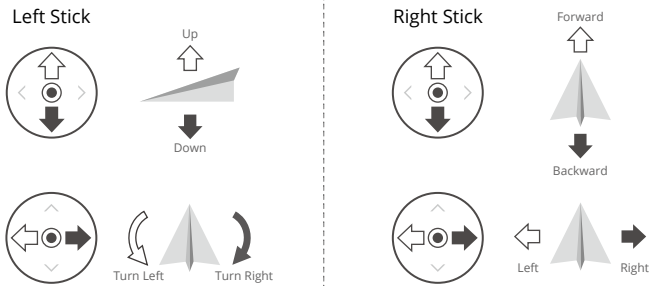

### Mode 3

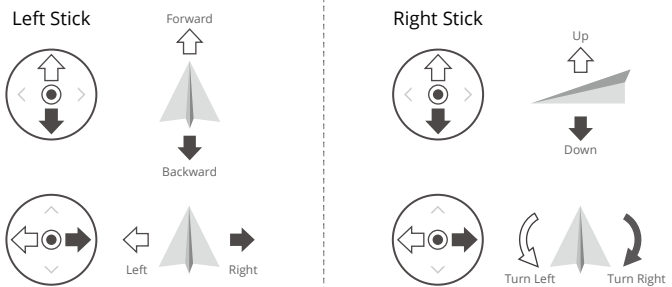







The default control mode of the remote controller is Mode 2. In this manual, Mode 2 is used as an example to illustrate how to use the control sticks.

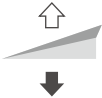

- Stick Neutral/Center Point: control sticks are in the center.

- Moving the control stick: the control stick is pushed away from the center position.

| Remote Controller (Mode 2)  | Aircraft  | Remarks   |
|---|---|---|
|    |    | <p><b>Throttle Stick:</b> moving the left stick up or down changes the altitude of the aircraft.</p> <ul style="list-style-type: none"> <li>• Push the stick up to ascend and push down to descend.</li> <li>• The aircraft hovers in place if the stick is in the center.</li> <li>• The more the stick is pushed away from the center, the faster the aircraft changes elevation.</li> </ul> <p>Use the left stick to take off when the motors are spinning at an idle speed. Push the stick gently to prevent sudden and unexpected changes in altitude.</p> |
|    |    | <p><b>Yaw Stick:</b> moving the left stick to the left or right controls the orientation of the aircraft.</p> <ul style="list-style-type: none"> <li>• Push the stick left to rotate the aircraft counterclockwise and right to rotate the aircraft clockwise.</li> <li>• The aircraft hovers in place if the stick is in the center.</li> <li>• The more the stick is pushed away from the center, the faster the aircraft rotates.</li> </ul>   |
|   |   | <p><b>Pitch Stick:</b> moving the right stick up and down to change the pitch of the aircraft.</p> <ul style="list-style-type: none"> <li>• Push the stick up to fly forward and down to fly backward.</li> <li>• The aircraft hovers in place if the stick is in the center.</li> <li>• The more the stick is pushed away from the center, the faster the aircraft moves.</li> </ul>   |
|  |  | <p><b>Roll Stick:</b> moving the right stick to the left or right changes the roll of the aircraft.</p> <ul style="list-style-type: none"> <li>• Push the stick left to fly left and right to fly right.</li> <li>• The aircraft hovers in place if the stick is in the center.</li> <li>• The more the stick is pushed away from the center, the faster the aircraft moves.</li> </ul>   |

## Flight Mode Switch

Toggle the switch to select the desired flight mode.

| Position | Flight Mode |
|----------|-------------|
| S        | Sport Mode  |
| N        | Normal Mode |
| C        | Cine Mode   |

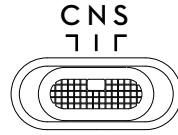

## Flight Pause/RTH Button

Press once to make the aircraft brake and hover in place. Press and hold the button until the remote controller beeps and starts RTH, and the aircraft will return to the last recorded Home Point. Press this button again to cancel RTH and regain control of the aircraft.

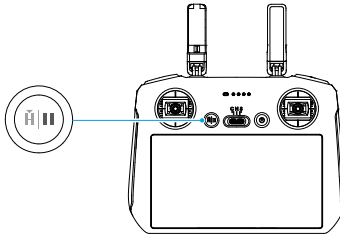





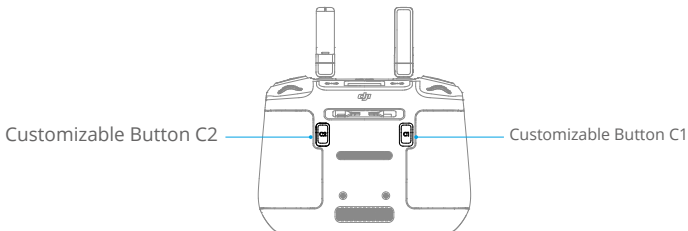



## Customizable Buttons

Go to Settings in DJI Fly and select Control to set the functions of the customizable C1 and C2 buttons.



















## Remote Controller LEDs

### Status LED

| Blinking Pattern   | Descriptions                                       |
|--|--|
|  — Solid red           | Disconnected from the aircraft.                    |
|  ..... Blinking red    | The battery level of the aircraft is low.          |
|  — Solid green         | Connected with the aircraft.                       |
|  ..... Blinking blue   | The remote controller is linking to an aircraft.   |
|  — Solid yellow        | Firmware update failed.                            |
|  — Solid blue          | Firmware update successful.                        |
|  ..... Blinking yellow | The battery level of the remote controller is low. |
|  ..... Blinking cyan   | Control sticks not centered.                       |

### Battery Level LEDs

| Blinking Pattern  |   |   |   | Battery Level |
|---|---|---|---|---------------|
|  |  |  |  | 76%-100%      |
|  |  |  |  | 51%-75%       |
|  |  |  |  | 26%-50%       |
|  |  |  |  | 0%-25%        |

## Remote Controller Alert

The remote controller beeps when there is an error or warning. Pay attention when prompts appear on the touchscreen or in DJI Fly. Slide down from the top of the screen and select Mute to disable all alerts, or slide the volume bar to 0 to disable some alerts.

The remote controller sounds an alert during RTH. The alert cannot be canceled. The remote controller sounds an alert when the battery level of the remote controller is low (6% to 10%). A low battery level alert can be canceled by pressing the power button. The critical low battery level alert, which is triggered when the battery level is less than 5%, cannot be canceled.

## Optimal Transmission Zone

The signal between the aircraft and the remote controller is most reliable when the antennas are positioned in relation to the aircraft as illustrated below.

The optimal transmission range is where the antennas face toward the aircraft and the angle between the antennas and the back of the remote controller is 180° or 270°.

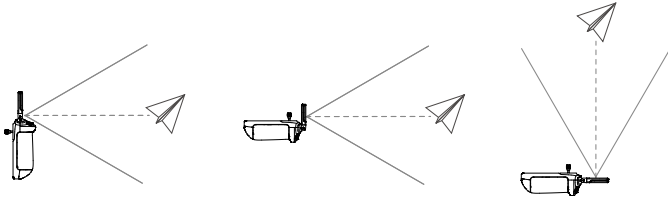

- 
- ⚠ • DO NOT use other wireless devices operating at the same frequency as the remote controller. Otherwise, the remote controller will experience interference.
  - A prompt will be displayed in DJI Fly if the transmission signal is weak during flight. Adjust the antennas to make sure that the aircraft is in the optimal transmission range
- 

## Linking the Remote Controller

The remote controller is already linked to the aircraft when purchased together as a combo. Otherwise, follow the steps below to link the remote controller and the aircraft after activation.

1. Power on the aircraft and the remote controller.
2. Launch DJI Fly.
3. In camera view, tap ●●● and select Control and then Re-pair to Aircraft. During linking, the status LED of the remote controller blinks blue and the remote controller beeps.
4. Press and hold the power button of the aircraft for more than four seconds. The aircraft beeps twice after a short beep, and its battery level LEDs blink in sequence to indicate it is ready to link. The remote controller will beep twice, and its status LED will turn solid green to indicate linking is successful.

- 
- 💡 • Make sure the remote controller is within 0.5 m of the aircraft during the linking.
    - The remote controller will automatically unlink from an aircraft if a new remote controller is linked to the same aircraft.
    - Turn off Bluetooth and Wi-Fi for optimal video transmission.
- 

- ⚠ • Fully charge the remote controller before each flight. The remote controller sounds an alert when the battery level is low.
    - If the remote controller is powered on and not in use for five minutes, an alert will sound. After six minutes, the remote controller automatically powers off. Move the control sticks or press any button to cancel the alert.
    - Fully charge the battery at least once every three months to maintain the battery's health.
    - DO NOT operate the aircraft when the light condition is too bright or too dark using the remote controller to monitor flight. User is responsible for the correct adjustment of display brightness and shall take care of direct sunshine onto the screen during flight operation.
-

## Operating the Touchscreen

### Home

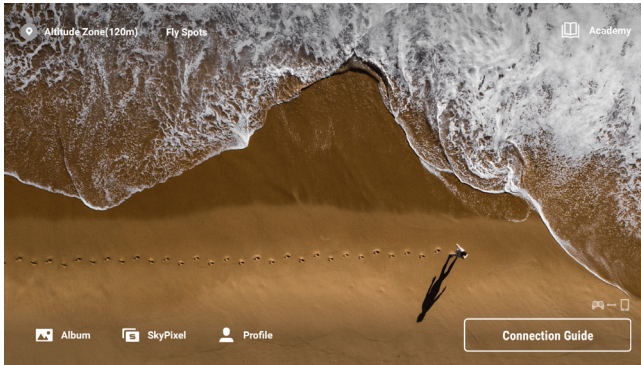

### Operations

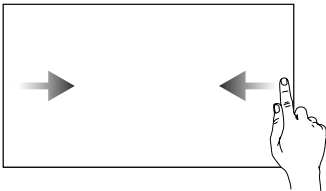

Slide from the left or right to the center of the screen to return to the previous screen.

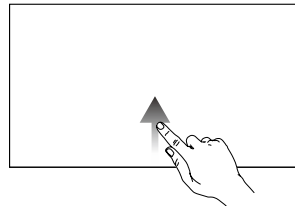

Slide up from the bottom of the screen to return to DJI Fly.

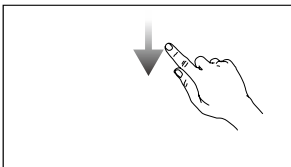

Slide down from the top of the screen to open the status bar when in DJI Fly.

The status bar displays the time, Wi-Fi signal, battery level of the remote controller, etc.

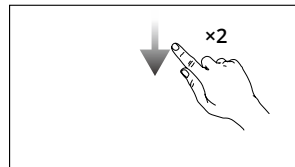

Slide down twice from the top of the screen to open Quick Settings when in DJI Fly.



## Quick Settings

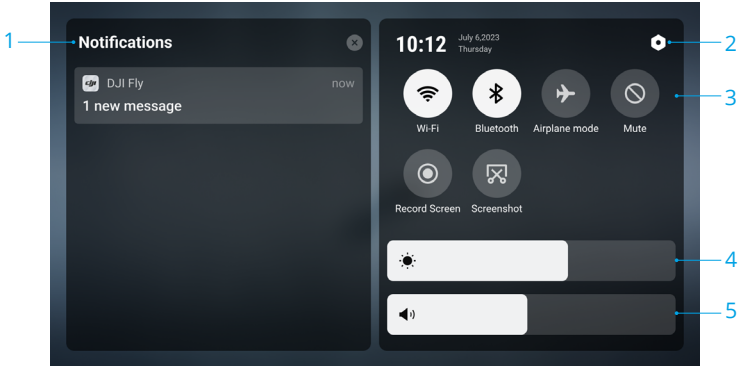

### 1. Notifications

Tap to check system notifications.

### 2. System Settings

Tap to access system settings and configure settings such as Bluetooth, volume, and network. Users can also view the Guide to learn more about the controls and status LEDs.

### 3. Shortcuts

 : tap to enable or disable Wi-Fi. Hold to enter settings and then connect to or add a Wi-Fi network.

 : tap to enable or disable Bluetooth. Hold to enter settings and connect with nearby Bluetooth devices.

 : tap to enable Airplane mode. Wi-Fi and Bluetooth will be disabled.

 : tap to turn off system notifications and disable all alerts.

 : tap to start recording the screen.

 : tap to take a screenshot.

### 4. Adjusting Brightness

Slide the bar to adjust the screen brightness.

### 5. Adjusting Volume

Slide the bar to adjust the volume.

## Advanced Features

### Calibrating the Compass

The compass may need to be calibrated after the remote controller is used in areas with electromagnetic interference. A warning prompt will appear if the compass of the remote controller requires calibration. Tap the warning prompt to start calibrating. In other cases, follow the steps below to calibrate the remote controller.

1. Power on the remote controller, and enter Quick Settings.
2. Select System Settings , scroll down, and tap Compass.
3. Follow the on-screen instructions to calibrate the compass.
4. A prompt will be displayed when the calibration is successful.

### DJI RC-N2

The DJI RC-N2 remote controller features O4 video transmission when used with DJI Air 3, works at 2.4 GHz, 5.8 GHz and 5.1 GHz frequency bands. The remote controller is capable of selecting the best transmission channel automatically and can transmit 1080p 60fps HD live view from the aircraft to DJI Fly on a mobile device (depending on mobile device performance) at a maximum transmission range of 20 km (12.4 mi) (compliant with FCC standards, and measured in a wide open area without interference). Users can control the aircraft and change the settings easily within this range.

The built-in battery has a capacity of 5200 mAh and power of 18.72 Wh that supports a maximum run time of six hours (when not charging the mobile device).

---

 • 5.1 GHz can be used only in countries and regions where it is permitted by local laws and regulations.

---

## Operation

### Powering On/Off

Press the power button once to check the current battery level. If the battery level is too low, recharge before use.

Press once then press again and hold for two seconds to power the remote controller on or off.

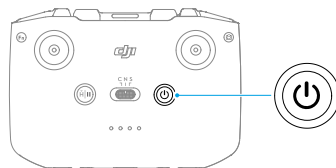

## Charging the Battery

Use a USB-C cable to connect a USB charger to the USB-C port of the remote controller.

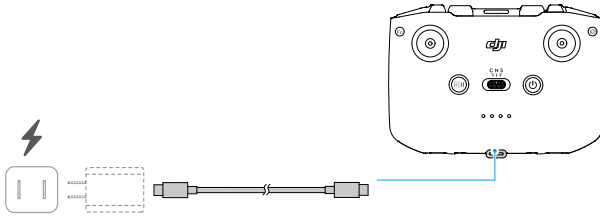

## Controlling the Gimbal and Camera

1. **Shutter/Record Button:** press once to take a photo or to start or stop recording.
2. **Photo/Video Toggle:** press once to switch between photo and video mode.
3. **Gimbal Dial:** for controlling the tilt of the gimbal.
4. **Customizable Button:** press and hold the customizable button and then use the gimbal dial to zoom in or out.

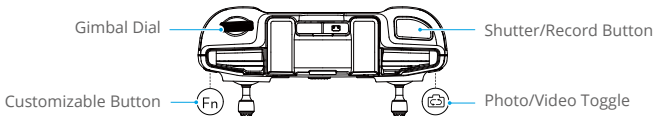

## Controlling the Aircraft

Three preprogrammed modes (Mode 1, Mode 2, and Mode 3) are available and custom modes can be configured in the DJI Fly app.

### Mode 1

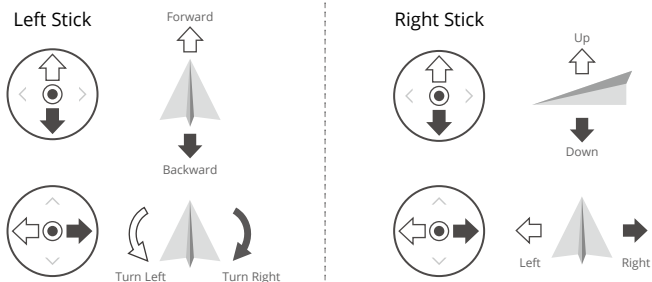

### Mode 2

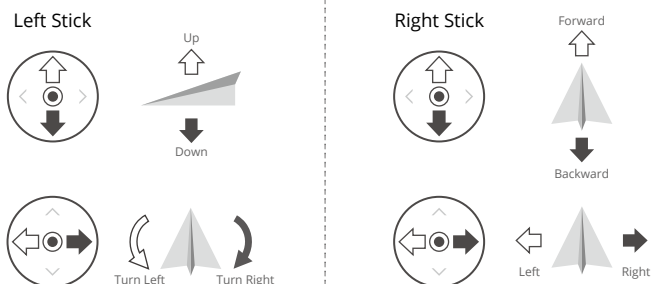



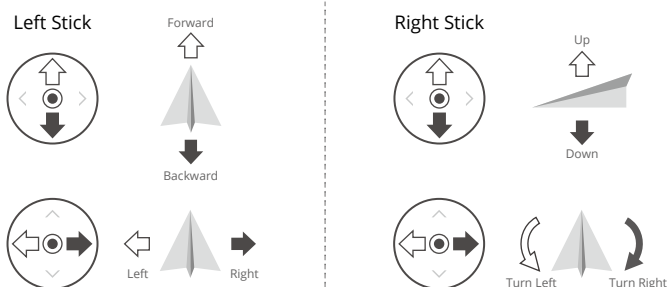



### Mode 3

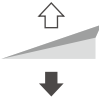

The default control mode of the remote controller is Mode 2. In this manual, Mode 2 is used as an example to illustrate how to use the control sticks.

- Stick Neutral/Center Point: control sticks are in the center.
- Moving the control stick: the control stick is pushed away from the center position.

| Remote Controller (Mode 2)  | Aircraft  | Remarks   |
|---|---|---|
|    |    | <p><b>Throttle Stick:</b> moving the left stick up or down changes the altitude of the aircraft.</p> <ul style="list-style-type: none"> <li>• Push the stick up to ascend and push down to descend.</li> <li>• The aircraft hovers in place if the stick is in the center.</li> <li>• The more the stick is pushed away from the center, the faster the aircraft changes elevation.</li> </ul> <p>Use the left stick to take off when the motors are spinning at an idle speed. Push the stick gently to prevent sudden and unexpected changes in altitude.</p> |
|    |    | <p><b>Yaw Stick:</b> moving the left stick to the left or right controls the orientation of the aircraft.</p> <ul style="list-style-type: none"> <li>• Push the stick left to rotate the aircraft counterclockwise and right to rotate the aircraft clockwise.</li> <li>• The aircraft hovers in place if the stick is in the center.</li> <li>• The more the stick is pushed away from the center, the faster the aircraft rotates.</li> </ul>   |
|    |    | <p><b>Pitch Stick:</b> moving the right stick up and down to change the pitch of the aircraft.</p> <ul style="list-style-type: none"> <li>• Push the stick up to fly forward and down to fly backward.</li> <li>• The aircraft hovers in place if the stick is in the center.</li> <li>• The more the stick is pushed away from the center, the faster the aircraft moves.</li> </ul>   |
|  |  | <p><b>Roll Stick:</b> moving the right stick to the left or right changes the roll of the aircraft.</p> <ul style="list-style-type: none"> <li>• Push the stick left to fly left and right to fly right.</li> <li>• The aircraft hovers in place if the stick is in the center.</li> <li>• The more the stick is pushed away from the center, the faster the aircraft moves.</li> </ul>   |

### Flight Mode Switch

Toggle the switch to select the desired flight mode.

| Position | Flight Mode |
|----------|-------------|
| S        | Sport Mode  |
| N        | Normal Mode |
| C        | Cine Mode   |

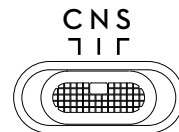

## Flight Pause/RTH Button

Press once to make the aircraft brake and hover in place. Press and hold the button until the remote controller beeps and starts RTH, the aircraft will return to the last recorded Home Point. Press this button again to cancel RTH and to regain control of the aircraft.

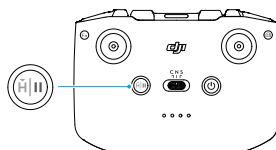

## Customizable Button

To customize the function of this button, go to Settings in DJI Fly and select Control.

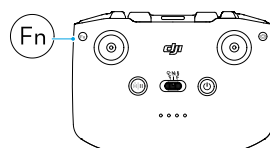

## Remote Controller Alert

The remote controller sounds an alert during RTH. The alert cannot be canceled. The remote controller sounds an alert when the battery level of the remote controller is 6% to 10%. A low battery level alert can be canceled by pressing the power button. The critical low battery level alert, which is triggered when the battery level is less than 5%, cannot be cancelled.

The battery level LEDs will start blinking slowly after disconnecting with the aircraft. DJI Fly will prompt warning after disconnecting with the aircraft.

## Optimal Transmission Zone

The signal between the aircraft and the remote controller is most reliable when the remote controller is positioned towards the aircraft as depicted below.

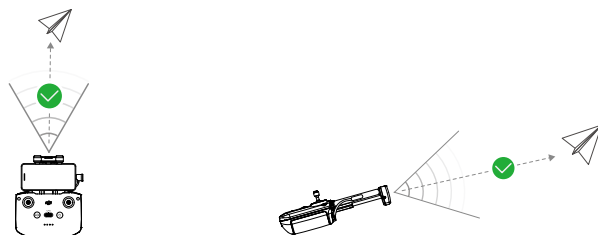

Optimal Transmission Zone

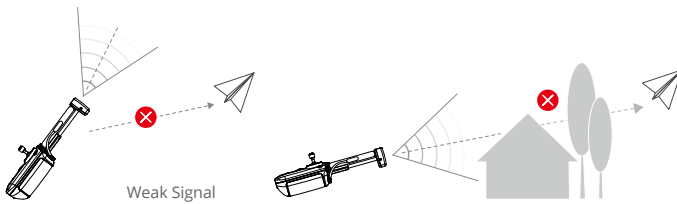

## Linking the Remote Controller

The remote controller is already linked to the aircraft when purchased together as a combo. Otherwise, follow the steps below to link the remote controller and the aircraft after activation.

1. Power on the aircraft and the remote controller.
2. Connect a mobile device to the remote controller, and Launch DJI Fly.
3. In camera view, tap ●●● and select Control and then Re-pair to Aircraft.
4. Press and hold the power button of the aircraft for more than four seconds. The aircraft will beep once when it is ready to link. After the linking is successful, the aircraft will beep twice and the battery level LEDs of the remote controller will appear on and solid.



- Make sure the remote controller is within 0.5 m of the aircraft during the linking.
- The remote controller will automatically unlink from an aircraft if a new remote controller is linked to the same aircraft.
- Turn off Bluetooth and Wi-Fi for optimal video transmission.



- Fully charge the remote controller before each flight. The remote controller sounds an alert when the battery level is low.
- If the remote controller is powered on and not in use for five minutes, an alert will sound. After six minutes, the remote controller automatically powers off. Move the control sticks or press any button to cancel the alert.
- Adjust the mobile device holder to make sure your mobile device is secure.
- Fully charge the battery at least once every three months to maintain the battery's health.
- DO NOT operate the aircraft when the light condition is too bright or too dark using mobile phone to monitor flight. User is responsible for the correct adjustment of display brightness and shall take care of direct sunshine onto the screen during flight operation.
- Make sure to use a mobile device together with the DJI RC-N2 remote controller to control the aircraft. If the mobile device turns off for any reason, land the aircraft as soon as possible for safety.

# DJI Fly App

---

This section introduces the main functions of the DJI Fly app.



# DJI Fly App

## Home

Launch DJI Fly and enter the home screen.

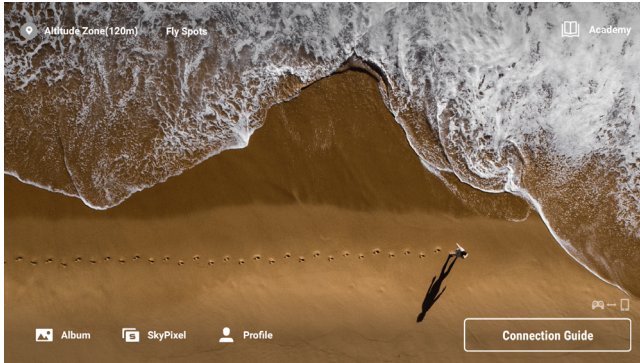

### Fly Spots

View or share flight and shooting locations nearby, learn more about GEO Zones, and preview aerial photos of different locations taken by other users.

### Academy

Tap the icon in the top right corner to enter Academy and view product tutorials, flight tips, flight safety notices, and manual documents.

### Album

Allows you to view photos and videos from the aircraft album or saved on the local device. Tap Create and select Templates or Pro. Templates provides an auto-edit feature for imported footage. Pro allows users to edit footage manually.

### SkyPixel

Enter SkyPixel to view videos and photos shared by other users.

### Profile

View account information and flight records, visit the DJI forum and online store, access the Find My Drone feature, offline maps, and other settings such as firmware updates, camera view, cached data, account privacy, and language.

## Camera View

### Button Descriptions

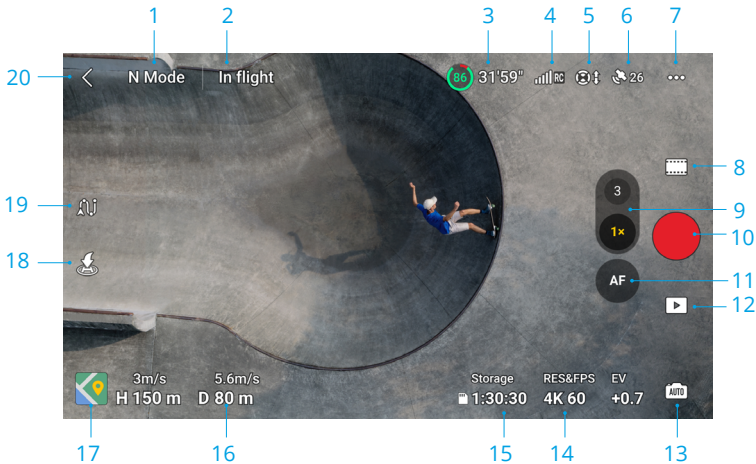

#### 1. Flight Mode

**N Mode:** displays the current flight mode.

#### 2. System Status Bar

**In Flight:** displays aircraft flight status and various warning messages.

#### 3. Battery Information

**86% 31:59:** displays the current battery level and remaining flight time. Tap to view more information about the battery.

#### 4. Video Downlink Signal Strength

**[Signal Icon]:** displays the video downlink signal strength between the aircraft and the remote controller.

#### 5. Vision System Status

**[Vision Icon]:** the left side of the icon indicates the status of the horizontal vision system and the right side of the icon indicates the status of the upward and downward vision systems. The icon is white when the vision system is working normally and turns red when the vision system is unavailable.

#### 6. GNSS Status

**[GNSS Icon] 26:** displays the current GNSS signal strength. Tap to check the GNSS signal status. The Home Point can be updated when the icon is white, which indicates the GNSS signal is strong.

## 7. Settings

☰ : tap to view or set parameters for safety, control, camera, and transmission. Refer to the Settings section for more information.

## 8. Shooting Modes



Photo: Single, AEB, Burst Shooting, and Time Shot.



Video: Normal, Night, and Slow Motion.



MasterShots: drag-select a subject. The aircraft will record while executing different maneuvers in sequence and keep the subject in the center of the frame. A short cinematic video will be generated afterwards.



QuickShots: Dronie, Rocket, Circle, Helix, Boomerang, and Asteroid.



Hyperlapse: Free, Circle, Course Lock, and Waypoints.



Pano: Sphere, 180°, Wide Angle, and Vertical. The aircraft will automatically take several photos and synthesize a panoramic photo based on the selected panoramic photo type.



- The Night video mode provides better noise reduction and cleaner footage, supports up to 12800 ISO.



- The Night video mode currently supports 4K 24/25/30fps and 1080P 24/25/30fps.
- FocusTrack is not supported in the Night video mode.

## 9. Camera Switch Button

Tap **3x** to switch to medium tele camera, tap again to change the zoom ratio. Tap **1x** to switch to the wide-angle camera, tap again to change the zoom ratio.

Tap and hold **3x** or **1x** to bring up the zoom bar to adjust the digital zoom. Use two fingers on the screen to zoom in or out.



- Digital zoom is only supported in Normal video and Night video modes.

- When zooming in or out, the larger the zoom ratio, the slower the aircraft will rotate to achieve a smooth view.

## 10. Shutter/Record Button

● : tap to take a photo or to start or stop recording a video.

## 11. Focus Button

AF/MF: tap to switch between AF and MF. Tap and hold the icon to bring up the focus bar to adjust the focus.

## 12. Playback

▶ : tap to enter playback and preview photos and videos as soon as they are captured.

## 13. Camera Modes Switch



tap to switch between Auto and Pro mode. Different parameters can be set in different modes.

## 14. Shooting Parameters

**RES/AFP5 4K 60** : displays the current shootings parameters. Tap to access parameter settings.

## 15. Storage Information

**Storage 1:30:30** : displays the remaining number of photos or video recording time of the current storage. Tap to view the available capacity of the internal storage or the microSD card.

## 16. Flight Telemetry

Displays the distance between the aircraft and the Home Point, height from the Home Point, aircraft horizontal speed, and aircraft vertical speed.

## 17. Maps

 : tap to expand to the mini map, and tap the center of the mini map to switch from the camera view to the map view. The mini map can be switched to the attitude indicator.

- **Mini Map:** displays the map in the bottom left corner of the screen so that the user can simultaneously check the camera view, the real-time position and orientation of the aircraft and the remote controller, the Home Point location, and flight paths, etc.

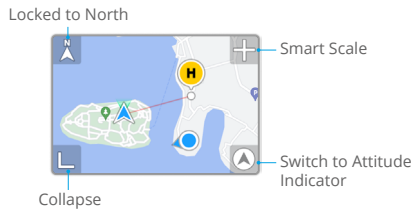

|                              |  |
|------------------------------|--|
| Locked to North              | North is locked on the map with North pointing upward in the map view. Tap to switch from Lock to North to the remote controller orientation where the map rotates when the remote controller changes the orientation. |
| Smart Scale                  | tap the + / - icon to slightly zoom in or out.   |
| Switch to Attitude Indicator | tap to switch from the mini map to the attitude indicator.   |
| Collapse                     | tap to minimize the map.   |

- **Attitude Indicator:** displays the attitude indicator in the bottom left corner of the screen so that the user can simultaneously check the camera view, the relative location and orientation of the aircraft and the remote controller, the Home Point location, and the aircraft horizontal attitude information, etc. The attitude indicator supports displaying the aircraft or the remote controller as the center.

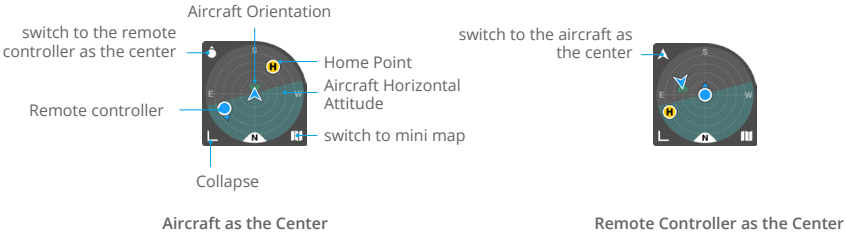

|  |   |
|--|---|
| Switch to the aircraft / remote controller as the center | Tap to switch to aircraft / remote controller as the center of the attitude indicator.  |
| Aircraft Orientation                                     | Indicates the aircraft orientation. When the aircraft is displayed as the center of the attitude indicator and the user is changing the aircraft orientation, all the other elements on the attitude indicator will rotate around the aircraft icon. The arrow direction of the aircraft icon stays unchanged.  |
| Aircraft Horizontal Attitude                             | Indicates the aircraft horizontal attitude information (including pitch and roll). The deep cyan area is horizontal and in the center of the attitude indicator when the aircraft hovers in place. If not, it indicates that the wind is changing the aircraft attitude. Fly with caution. The deep cyan area changes in real time based on the aircraft horizontal attitude. |
| Switch to the Mini Map                                   | Tap to switch from the attitude indicator to the mini map.  |
| Collapse   | Tap to minimize the attitude indicator.   |
| Home Point   | The location of the Home Point. To manually control the aircraft to return home, adjust the aircraft orientation to point towards the Home Point first.   |
| Remote Controller  | The dot indicates the remote controller location, while the arrow on the dot indicates the remote controller orientation. Adjust the remote controller orientation during the flight to make sure the arrow points towards the aircraft icon for optimal signal transmission.   |

18. Auto Takeoff/Landing/RTH

⬆️ / ⬆️ : tap the icon. When the prompt appears, press and hold the button to initiate auto takeoff or landing.

🏠 : tap to initiate Smart RTH and have the aircraft return to the last recorded Home Point.

19. Waypoint Flight

📍 : tap to enable/disable Waypoint Flight.

## 20. Back

⏪ : tap to return to the home screen.

## Screen Shortcuts

### Gimbal Angle Adjustment

Press and hold on the screen to bring up the gimbal adjustment bar to adjust the gimbal angle.

### Focus/Spot Metering

Tap on the screen to enable focus or spot metering. Focus or spot metering will display differently depending on the shooting mode, focus mode, exposure mode, and spot metering mode.

After using spot metering:

- Drag  next to the box up and down to adjust the EV (exposure value).
- Press and hold the box on the screen to lock the exposure. To unlock the exposure, tap and hold on the screen again or tap on other area of the screen.

## Settings

### Safety

- Flight Assistance

|                           |   |
|---------------------------|---|
| Obstacle Avoidance Action | Omnidirectional vision system is enabled after setting Obstacle Avoidance Action to Bypass or Brake. The aircraft cannot sense obstacles if Obstacle Avoidance is disabled. |
|---------------------------|---|

|                   |  |
|-------------------|--|
| Bypassing Options | Select Normal or Nifty mode when using Bypass. |
|-------------------|--|

|                   |   |
|-------------------|---|
| Display Radar Map | When enabled, the real-time obstacle detection radar map will be displayed. |
|-------------------|---|

- Return to Home (RTH): set Advanced RTH, Auto RTH Altitude, and to update the Home Point.
- AR Settings: enable display of AR Home Point, AR RTH Route, and AR Aircraft Shadow.
- Flight Protection: set the max altitude and the max distance for flights.
- Sensors: view the IMU and compass statuses and start calibration if necessary.
- Battery: tap to view battery information such as battery cell status, serial number, and number of times charged.
- Auxiliary LED: tap to set the auxiliary LED to auto, on, or off. DO NOT turn on the Auxiliary LED before takeoff.
- Aircraft Front Arm LEDs: tap to set the aircraft front arm LEDs to auto or on. In auto mode, the aircraft front LEDs will be disabled during shooting to ensure the quality is not affected.
- Unlock GEO Zone: tap to view information about unlocking GEO Zones.

- Find My Drone: this feature helps to find the location of the aircraft, either by enabling the aircraft LEDs, beeping, or by using the map.
- Advanced Safety Settings

|                          |  |
|--------------------------|--|
| Signal Lost              | The behavior of the aircraft when the remote controller signal is lost can be set to RTH, Descend, or Hover.   |
| Emergency Propeller Stop | Emergency Only indicates that the motors can only be stopped by performing a combination stick command (CSC) for at least 2 seconds mid-flight in an emergency situation such as if there is a collision, a motor has stalled, the aircraft is rolling in the air, or the aircraft is out of control and is ascending or descending very quickly. Anytime indicates that the motors can be stopped mid-flight anytime once user performs a CSC.<br><br><b>Stopping the motors mid-flight will cause the aircraft to crash.</b> |
| AirSense                 | An alert will appear in DJI Fly when a manned aircraft is detected if AirSense is enabled. Read the disclaimer in the DJI Fly prompt before using AirSense.  |

## Control

- Aircraft Settings

|                      |  |
|----------------------|--|
| Units                | Can be set to metric or imperial.  |
| Subject Scanning     | When enabled, the aircraft automatically scans and displays subjects in the camera view (only available for single-shot and normal video modes).   |
| Gain and Expo Tuning | Supports the gain and expo settings to be fine-tuned for the aircraft and the gimbal in different flight modes, including the max horizontal speed, max ascent speed, max descent speed, max angular velocity, yaw smoothness, brake sensitivity, expo, and the gimbal max tilt control speed and tilt smoothness. |



- When releasing the control stick, an increased brake sensitivity reduces the braking distance of the aircraft, while a decreased brake sensitivity increases the braking distance. Fly with caution.

- Gimbal Settings: tap to set the gimbal mode, perform gimbal calibration, and recenter or move the gimbal downward.
- Remote Controller Settings: tap to set the function of the customizable button, calibrate the remote controller, switch control stick modes. Make sure to understand the operations of a stick mode before changing the control stick mode.
- Flight Tutorial: view the flight tutorial.
- Re-pair to Aircraft (Link): tap to start linking when the aircraft is not linked to the remote controller.

## Camera

- Camera Parameter Settings: displays different settings according to the shooting mode.

| Shooting Modes | Settings                              |
|----------------|---------------------------------------|
| Photo Mode     | Format, Aspect Ratio, Resolution      |
| Record Mode    | Color, Coding Format, Video Subtitles |
| MasterShots    | Color, Coding Format, Video Subtitles |
| QuickShots     | Color, Coding Format, Video Subtitles |
| Hyperlapse     | Photo Type, Shot Frame                |
| Pano           | Photo Type                            |

- General Settings

|                      |  |
|----------------------|--|
| Anti-Flicker         | When enabled, the footage flicker caused by the light source will be reduced when shooting in environments with lights.<br> In Pro mode, anti-flicker will only take effect when shutter speed and ISO are set to auto. |
| Histogram            | When enabled, users can check the screen to view whether the exposure is appropriate.  |
| Peaking Level        | When enabled in MF mode, the objects in focus will be outlined in red. The higher the peaking level, the thicker the outline.  |
| Overexposure Warning | When enabled, the overexposure area will be identified with diagonal lines.  |
| Gridlines            | Enable gridlines such as diagonal lines, nine-square grids, and center point.  |
| White Balance        | Set to auto, or manually adjust the color temperature.   |

- Storage

|                          |   |
|--------------------------|---|
| Storage                  | Store the recorded files to the microSD card on the aircraft or the internal storage of the aircraft.<br>DJI Air 3 has an internal storage of 8 GB. |
| Custom Folder Naming     | When changed, a new folder will be automatically created on the aircraft storage to store future files.   |
| Custom File Naming       | When changed, the new name will be applied to future files on the aircraft storage.   |
| Cache When Recording     | When enabled, the liveview on the remote controller will be stored in the remote controller storage when recording video.                           |
| Max Video Cache Capacity | When the cache limit is reached, the earliest caches will be automatically deleted.   |

- Reset Camera Settings: tap to restore camera parameters to the default settings.



---

## Transmission

A livestreaming platform can be selected to broadcast the camera view in real time. The frequency band and channel mode can also be set in the transmission settings.

## About

Displays information such as the Device Name, Wi-Fi Name, Model, App Version, Aircraft Firmware, RC Firmware, FlySafe Data, SN, etc.

Tap Reset All Settings to reset settings including camera, gimbal, and safety settings to default.



- Fully charge the device before launching DJI Fly.
  - Mobile cellular data is required when using DJI Fly. Contact your wireless carrier for data charges.
  - DO NOT accept phone calls or use texting features during flight if you are using a mobile phone as your display device.
  - Read all safety prompts, warning messages, and disclaimers carefully. Familiarize yourself with relevant regulations in your area. You are solely responsible for being aware of all relevant regulations and flying in a way that is compliant.
    - a. Read and understand the warning messages before using the auto-takeoff and auto-landing features.
    - b. Read and understand the warning messages and disclaimers before setting the altitude beyond the default limit.
    - c. Read and understand the warning messages and disclaimers before switching flight modes.
    - d. Read and understand the warning messages and disclaimer prompts near or in GEO zones.
    - e. Read and understand the warning messages before using the Intelligent Flight modes.
  - Land the aircraft immediately at a safe location if a prompt appears in the app instructing you to do so.
  - Review all warning messages on the checklist displayed in the app before each flight.
  - Use the in-app tutorial to practice your flight skills if you have never operated the aircraft or if you do not have sufficient experience to operate the aircraft with confidence.
  - The app is designed to assist your operation. Use sound discretion and DO NOT rely on the app to control the aircraft. The use of the app is subject to DJI Fly Terms of Use and DJI Privacy Policy. Read them carefully in the app.
-

# Appendix

---

# Appendix

## Specifications

### Aircraft (Model: EB3WBC)

|   |   |
|---|---|
| Takeoff Weight  | 720 g   |
| Dimensions (L×W×H)  | Folded (without propellers): 207×100.5×91.1 mm<br>Unfolded (without propellers): 258.8×326×105.8 mm   |
| Max Ascent Speed  | 10 m/s  |
| Max Descent Speed   | 10 m/s  |
| Max Horizontal Speed (near sea level, no wind) <sup>[1]</sup> | 21 m/s  |
| Max Takeoff Altitude  | 6,000 m (19,685 ft)   |
| Max Flight Time <sup>[2]</sup>                                | 46 minutes  |
| Max Hovering Time <sup>[3]</sup>                              | 42 minutes  |
| Max Flight Distance   | 32 km   |
| Max Wind Speed Resistance                                     | 12 m/s  |
| Max Pitch Angle   | 35°   |
| Operating Temperatures  | -10° to 40° C (14° to 104° F)   |
| GNSS  | GPS + Galileo + BeiDou  |
| Hovering Accuracy Range                                       | <b>Vertical:</b><br>±0.1 m (with vision positioning)<br>±0.5 m (with GNSS positioning)<br><br><b>Horizontal:</b><br>±0.3 m (with vision positioning)<br>±0.5 m (with high-precision positioning system) |
| Internal Storage  | 8 GB  |

### Camera

|              |   |
|--------------|---|
| Image Sensor | <b>Wide-Angle Camera:</b> 1/1.3-inch CMOS, Effective Pixels: 48 MP<br><b>Medium Tele Camera:</b> 1/1.3-inch CMOS, Effective Pixels: 48 MP   |
| Lens         | <b>Wide-Angle Camera</b><br>FOV: 82°<br>Format Equivalent: 24 mm<br>Aperture: f/1.7<br>Focus: 1 m to ∞<br><br><b>Medium Tele Camera</b><br>FOV: 35°<br>Format Equivalent: 70 mm<br>Aperture: f/2.8<br>Focus: 3 m to ∞ |

|                                       |  |
|---------------------------------------|--|
| <p>ISO</p>                            | <p><b>Video</b><br/>         Normal and Slow Motion:<br/>         100-6400 (Normal Color)<br/>         100-1600 (D-Log M)<br/>         100-1600 (HLG)<br/>         Night:<br/>         100-12800 (Normal Color)</p> <p><b>Photo</b><br/>         100-6400 (12 MP)<br/>         100-3200 (48 MP)</p>  |
| <p>Electronic Shutter Speed</p>       | <p><b>Wide-Angle Camera</b><br/>         12MP Photo: 1/16000-2 s (2.5-8 s for simulated long exposure)<br/>         48MP Photo: 1/8000-2 s</p> <p><b>Medium Tele Camera</b><br/>         12MP Photo: 1/16000-2 s (2.5-8 s for simulated long exposure)<br/>         48MP Photo: 1/8000-2 s</p>   |
| <p>Max Image Size</p>                 | <p>Wide-Angle Camera: 8064×6048<br/>         Medium Tele Camera: 8064×6048</p>   |
| <p>Still Photography Modes</p>        | <p><b>Wide-Angle Camera</b><br/>         Single Shot: 12 MP and 48 MP<br/>         Burst Shooting: 12 MP, 3/5/7 frames; 48 MP, 3/5 frames<br/>         Automatic Exposure Bracketing (AEB): 12 MP, 3/5 frames; 48 MP, 3/5 frames at 0.7 EV step<br/>         Timed:<br/>         12 MP, 2/3/5/7/10/15/20/30/60 s; 48 MP, 5/7/10/15/20/30/60 s</p> <p><b>Medium Tele Camera</b><br/>         Single Shot: 12 MP and 48 MP<br/>         Burst Shooting: 12 MP, 3/5/7 frames; 48 MP, 3/5 frames<br/>         Automatic Exposure Bracketing (AEB): 12 MP, 3/5 frames; 48 MP, 3/5 frames at 0.7 EV step<br/>         Timed:<br/>         12 MP, 2/3/5/7/10/15/20/30/60 s; 48 MP, 5/7/10/15/20/30/60 s</p> |
| <p>Photo Format</p>                   | <p>JPEG/DNG (RAW)</p>  |
| <p>Video Resolution<sup>[4]</sup></p> | <p><b>Wide-Angle Camera:</b><br/>         H.264/H.265<br/>         4K: 3840×2160@24/25/30/48/50/60/100 fps<br/>         FHD: 1920×1080@24/25/30/48/50/60/100/200 fps<br/>         2.7K Vertical Shooting: 1512×2688@24/25/30/48/50/60 fps<br/>         FHD Vertical Shooting: 1080×1920@24/25/30/48/50/60 fps</p> <p><b>Medium Tele Camera:</b><br/>         H.264/H.265<br/>         4K: 3840×2160@24/25/30/48/50/60/100 fps<br/>         FHD: 1920×1080@24/25/30/48/50/60/100/200 fps<br/>         2.7K Vertical Shooting: 1512×2688@24/25/30/48/50/60 fps<br/>         FHD Vertical Shooting: 1080×1920@24/25/30/48/50/60 fps</p>   |

|                                |   |
|--------------------------------|---|
| Video Format                   | MP4 (MPEG-4 AVC/H.264, HEVC/H.265)  |
| Max Video Bitrate              | H.264/H.265: 150 Mbps   |
| Supported File System          | exFAT   |
| Color Mode and Sampling Method | <b>Wide-Angle Camera</b><br>Normal: 8-bit 4:2:0 (H.264/H.265)<br>HLG/D-Log M: 10-bit 4:2:0 (H.265)  |
|                                | <b>Medium Tele Camera</b><br>Normal: 8-bit 4:2:0 (H.264/H.265)<br>HLG/D-Log M: 10-bit 4:2:0 (H.265) |
| Digital Zoom                   | Wide-Angle Camera: 1-3x<br>Medium Tele Camera: 3-9x   |

### Gimbal

|                  |   |
|------------------|---|
| Stabilization    | 3-axis (tilt, roll, pan)                                    |
| Mechanical Range | Tilt: -135° to 70°<br>Roll: -50° to 50°<br>Pan: -27° to 27° |
| Mechanical Range | Tilt: -90° to 60°<br>Pan: -5° to 5°                         |

|                          |          |
|--------------------------|----------|
| Max Control Speed (tilt) | 100°/s   |
| Angular Vibration Range  | ±0.0037° |

### Sensing Systems

|                       |   |
|-----------------------|---|
| Sensing Type          | Omnidirectional binocular vision system, supplemented with a three-dimensional infrared sensing system at the bottom of the aircraft  |
| Forward               | Measurement Range: 0.5-18 m<br>Detection Range: 0.5-200 m<br>Effective Sensing Speed: Flight Speed ≤ 15 m/s<br>FOV: Horizontal 90°, Vertical 72°  |
| Backward              | Measurement Range: 0.5-18 m<br>Effective Sensing Speed: Flight Speed ≤ 14 m/s<br>FOV: Horizontal 90°, Vertical 72°  |
| Lateral               | Measurement Range: 0.5-30 m<br>Effective Sensing Speed: Flight Speed ≤ 14 m/s<br>FOV: Horizontal 90°, Vertical 72°  |
| Upward                | Measurement Range: 0.5-18 m<br>Effective Sensing Speed: Flight Speed ≤ 6 m/s<br>FOV: Front and Back 72°, Left and Right 90°   |
| Downward              | Measurement Range: 0.3-14 m<br>Effective Sensing Speed: Flight Speed ≤ 6 m/s<br>FOV: Front and Back 106°, Left and Right 90°  |
| Operating Environment | Forward, Backward, Left, Right, and Upward:<br>Surfaces with discernible patterns and adequate lighting (lux > 15)<br>Downward:<br>Surfaces with discernible patterns, diffuse reflectivity > 20% (e.g. walls, trees, people), and adequate lighting (lux > 15) |

|   |  |
|---|--|
| 3D Infrared Sensor  | Measurement Range: 0.1-8 m (reflectivity > 10%)<br>FOV: Front and Back 60°, Left and Right 60°   |
| <b>Video Transmission</b>   |  |
| Video Transmission System   | O4   |
| Live View Quality   | Remote Controller: 1080p/30fps, 1080p/60fps  |
| Operating Frequency <sup>[5]</sup>  | 2.4000-2.4835 GHz, 5.170-5.250 GHz, 5.725-5.850 GHz  |
| Transmitter Power (EIRP)  | 2.4 GHz: < 33 dBm (FCC), < 20 dBm (CE/SRRC/MIC)<br>5.1 GHz: < 23 dBm (CE)<br>5.8 GHz: < 33 dBm (FCC), < 30 dBm (SRRC), < 14 dBm (CE)                                     |
| Max Transmission Distance (unobstructed, free of interference) <sup>[6]</sup> | 20 km (FCC), 10 km (CE/SRRC/MIC)   |
| Max Transmission Distance (unobstructed, with interference) <sup>[7]</sup>    | Strong Interference: urban landscape, approx. 1.5-4 km<br>Medium Interference: suburban landscape, approx. 4-10 km<br>Low Interference: suburb/seaside, approx. 10-20 km |
| Max Transmission Distance (obstructed, with interference) <sup>[8]</sup>      | Low Interference and Obstructed by Buildings: approx. 0-0.5 km<br>Low Interference and Obstructed by Trees: approx. 0.5-3 km   |
| Max Download Speed <sup>[9]</sup>   | O4:<br>10 MB/s (with DJI RC 2 Remote Controller)<br>10 MB/s (with DJI RC-N2 Remote Controller)<br>Wi-Fi 5: 30 MB/s   |
| Lowest Latency <sup>[10]</sup>  | Aircraft + Remote Controller: Approx. 120 ms   |
| Antenna   | 6 antennas, 2T4R   |
| <b>Wi-Fi</b>  |  |
| Protocol  | 802.11 a/b/g/n/ac  |
| Operating Frequency   | 2.4000-2.4835 GHz, 5.725-5.850 GHz   |
| Transmitter Power (EIRP)  | 2.4 GHz: <20 dBm (FCC/CE/SRRC/MIC)<br>5.8 GHz: <20 dBm(FCC/SRRC), <14 dBm(CE)  |
| <b>Bluetooth</b>  |  |
| Protocol  | Bluetooth 5.2  |
| Operating Frequency   | 2.4000-2.4835 GHz  |
| Transmitter Power (EIRP)  | <10 dBm  |
| <b>Intelligent Flight Battery (Model: BWX233-4241-14.76)</b>                  |  |
| Battery Capacity  | 4241 mAh   |
| Weight  | 267 g  |
| Nominal Voltage   | 14.76 V  |
| Max Charging Voltage  | 17 V   |
| Battery Type  | Li-ion 4S  |
| Chemical System   | LiNiMnCoO2   |
| Energy  | 62.6 Wh  |
| Charging Temperature  | 5° to 40° C (41° to 104° F)  |

|               |   |
|---------------|---|
| Charging Time | Approx. 80 minutes (with DJI 65W Portable Charger)<br>Approx. 60 minutes (with DJI 100W USB-C Power Adapter and the DJI Air 3 Battery Charging Hub) |
|---------------|---|

### Charger

|                        |   |
|------------------------|---|
| Input                  | <b>DJI 65W Portable Charger:</b><br>100-240 V (AC), 50-60 Hz, 2 A   |
|                        | <b>DJI 100W USB-C Power Adapter:</b><br>100-240 V (AC), 50-60 Hz, 2.5 A   |
| Output <sup>[11]</sup> | <b>DJI 65W Portable Charger:</b><br>USB-C: 5 V=5 A; 9 V=5 A; 12 V=5 A; 15 V=4.3 A; 20 V=3.25 A; 5-20 V=3.25 A<br>USB-A: 5 V=2 A |
|                        | <b>DJI 100W USB-C Power Adapter:</b><br>Max 100 W (total)   |
| Rated Power            | DJI 65W Portable Charger: 65 W<br>DJI 100W USB-C Power Adapter: 100 W   |

### Battery Charging Hub

|                             |   |
|-----------------------------|---|
| Input                       | USB-C: 5-20 V, max 5 A                                  |
| Output (power accumulation) | Battery Port: 12-17 V, max 3.5 A                        |
| Output (charging)           | Battery Port: 12-17 V, max 5 A                          |
| Output (USB-C)              | USB-C: 5 V=3 A; 9 V=5 A; 12 V=5 A; 15 V=5 A; 20 V=4.1 A |
| Charging Type               | Charge three batteries in sequence                      |
| Compatibility               | DJI Air 3 Intelligent Flight Battery                    |

### Car Charger

|                      |  |
|----------------------|--|
| Input                | Car Power Input: 12.7-16 V, 6.5 A, rated voltage 14 V (DC)                                       |
| Output               | USB-C: 5 V=5 A; 9 V=5 A; 12 V=5 A; 15 V=4.3 A; 20 V=3.25 A; 5~20 V, 3.25 A<br><br>USB-A: 5 V=2 A |
| Rated Power          | 65 W   |
| Charging Temperature | 5° to 40° C (41° to 104° F)  |

### Storage

|                           |   |
|---------------------------|---|
| Recommended microSD Cards | SanDisk Extreme PRO 32GB V30 U3 A1 microSDHC<br>Lexar 1066x 64GB V30 U3 A2 microSDXC<br>Lexar 1066x 128GB V30 U3 A2 microSDXC<br>Lexar 1066x 256GB V30 U3 A2 microSDXC<br>Lexar 1066x 512GB V30 U3 A2 microSDXC<br>Kingston Canvas GO! Plus 64GB V30 U3 A2 microSDXC<br>Kingston Canvas GO! Plus 128GB V30 U3 A2 microSDXC<br>Kingston Canvas React Plus 64GB V90 U3 A1 microSDXC<br>Kingston Canvas React Plus 128GB V90 U3 A1 microSDXC<br>Kingston Canvas React Plus 256GB V90 U3 A1 microSDXC<br>Samsung EVO Plus 512GB V30 U3 A2 microSDXC |
|---------------------------|---|

**DJI RC-N2 Remote Controller (Model: RC151)**

|   |  |
|---|--|
| Max Operating Time                                    | Without charging any mobile device: 6 hours<br>When charging a mobile device: 3.5 hours  |
| Max Supported Mobile Device Size                      | 180×86×10 mm   |
| Operating Temperature                                 | -10° to 40° C (14° to 104° F)  |
| Charging Temperature                                  | 5° to 40° C (41° to 104° F)  |
| Charging Time   | 2.5 hours  |
| Charging Type   | It is recommended to use a 5V/2A charger.  |
| Battery Capacity                                      | 18.72 Wh (3.6 V, 2600 mAh×2)   |
| Battery Type  | 18650 Li-ion   |
| Dimensions  | 104.22×149.95×45.25 mm   |
| Weight  | 375 g  |
| Supported USB Port Types                              | Lightning, USB-C, Micro USB (purchase separately)  |
| Video Transmission Operating Frequency <sup>[5]</sup> | 2.4000-2.4835 GHz, 5.170-5.250 GHz, 5.725-5.850 GHz  |
| Transmitter Power (EIRP)                              | 2.4 GHz: <33 dBm (FCC), <20 dBm (CE/SRRC/MIC)<br>5.1 GHz: <23 dBm (CE)<br>5.8 GHz: <33 dBm (FCC), <14 dBm (CE), <30 dBm (SRRC) |

**DJI RC 2 Remote Controller (Model: RC331)**

|                           |  |
|---------------------------|--|
| Max Operating Time        | 3 hours  |
| Operating Temperature     | -10° to 40° C (14° to 104° F)  |
| Storage Temperature       | Within one month: -30° to 60° C (-22° to 140° F)<br>One to three months: -30° to 45° C (-22° to 113° F)<br>Three to six months: -30° to 35° C (-22° to 95° F)<br>More than six months: -30° to 25° C (-22° to 77° F)   |
| Charging Temperature      | 5° to 40° C (41° to 104° F)  |
| Charging Time             | 1.5 hours  |
| Charging Type             | Supports up to 9V/3A charging  |
| Battery Capacity          | 22.32 Wh (3.6 V, 3100 mAh×2)   |
| Battery Type              | 18650 Li-ion   |
| Chemical System           | LiNiMnCoO <sub>2</sub>   |
| GNSS                      | GPS + Galileo + BeiDou   |
| Internal Storage Capacity | 32 GB + expandable storage (via microSD card)  |
| Supported SD Cards        | UHS-I Speed Grade 3 rating microSD card or above   |
| Recommended microSD cards | SanDisk Extreme PRO 64GB V30 A2 microSDXC<br>SanDisk High Endurance 64GB V30 microSDXC<br>Lexar 256GB V30 A2 microSDXC<br>Samsung EVO 64GB V30 microSDXC<br>Samsung EVO Plus 128GB V30 microSDXC<br>Samsung EVO Plus 256GB V30 microSDXC<br>Kingston 256GB V30 microSDXC |
| Screen Brightness         | 700 nits   |



|   |  |
|---|--|
| Screen Resolution                                     | 1920×1080  |
| Screen Size   | 5.5-inch   |
| Screen Frame Rate                                     | 60 fps   |
| Touchscreen Control                                   | 10-point multi-touch   |
| Dimensions  | Without control sticks: 168.4×132.5×46.2 mm<br>With control sticks: 168.4×132.5×62.7 mm  |
| Weight  | Approx. 420 g  |
| <b>Video Transmission</b>                             |  |
| Antennas  | 4 antennas, 2T4R   |
| Video Transmission Operating Frequency <sup>[5]</sup> | 2.4000-2.4835 GHz, 5.170-5.250 GHz, 5.725-5.850 GHz  |
| Transmitter Power (EIRP)                              | 2.4 GHz: <33 dBm (FCC), <20 dBm (CE/SRRC/MIC)<br>5.1 GHz: <23 dBm (CE)<br>5.8 GHz: <33 dBm (FCC), <14 dBm (CE), <30 dBm (SRRC)   |
| <b>Wi-Fi</b>  |  |
| Wi-Fi Protocol  | 802.11 a/b/g/n/ac/ax   |
| Wi-Fi Operating Frequency                             | 2.4000-2.4835 GHz, 5.150-5.250 GHz, 5.725-5.850 GHz  |
| Wi-Fi Transmitter Power (EIRP)                        | 2.4 GHz: <26 dBm (FCC), <20 dBm (CE/SRRC/MIC)<br>5.1 GHz: <23 dBm (FCC/CE/SRRC/MIC)<br>5.8 GHz: <23 dBm (FCC/SRRC), <14 dBm (CE) |
| <b>Bluetooth</b>                                      |  |
| Bluetooth protocol                                    | BT 5.2   |
| Bluetooth Operating Frequency                         | 2.4000-2.4835 GHz  |
| Bluetooth Transmitter Power (EIRP)                    | < 10 dBm   |

[1] 19 m/s in the EU.

[2] Measured by DJI Air 3 flying at a constant speed of 28.8 kph in a windless environment at sea level, with APAS off, AirSense off, camera parameters set to 1080p/24fps, video mode off, and from 100% battery level until 0%. Data is for reference only. Always pay attention to reminders in the app during flight.

[3] Measured by DJI Air 3 hovering in a windless environment at sea level, with APAS off, AirSense off, camera parameters set to 1080p/24fps, video mode off, and from 100% battery level until 0%. Data is for reference only. Always pay attention to reminders in the app during flight.

[4] The 100 fps and 200 fps are recording frame rates. The corresponding video plays as slow-motion video. 4K/100fps only supports H.265.

[5] 5.170-5.250 GHz can be used only in countries and regions where it is permitted by local laws and regulations.

[6] Measured in an unobstructed outdoor environment free of interference. The above data shows the farthest communication range for one-way, non-return flights under each standard. Always pay attention to RTH reminders in the app during your flight.

[7] Data tested under FCC standard in unobstructed environments with typical interference. Used for reference purposes only and provides no guarantee for actual transmission distance.

[8] Data tested under FCC standard in obstructed environments with typical low interference. Used for reference purposes only and provides no guarantee for actual transmission distance.

[9] Measured in a laboratory environment with little interference in countries/regions that support both 2.4 GHz and 5.8 GHz. Download speeds may vary depending on the actual conditions.

[10] Depending on the actual environment and mobile device.

[11] When both ports are used, the max output power of one port is 82 W, and the charger will dynamically allocate the output power of the two ports according to the power load.

## Camera Function Matrix

|       |                | Wide-angle Camera | Medium Tele Camera |
|-------|----------------|-------------------|--------------------|
| Photo | Single Shot    | √                 | √                  |
|       | Burst Shooting | √                 | √                  |
|       | AEB            | √                 | √                  |
|       | Timed          | √                 | √                  |
|       | Pano           | √                 | x                  |
|       | Hyperlapse     | √                 | √                  |
| Video | Slow Motion    | √                 | √                  |
|       | Night Mode     | √                 | √                  |
|       | MasterShots    | √                 | √                  |
|       | QuickShots     | √                 | √ <sup>[1]</sup>   |
|       | FocusTrack     | √                 | √                  |

[1] The medium tele camera does not support the Asteroid mode of QuickShots.

## Firmware Update

Use DJI Fly or DJI Assistant 2 (Consumer Drones Series) to update the aircraft and the remote controller firmware.

### Using DJI Fly

When connecting the aircraft or remote controller to DJI Fly, you will be notified if a new firmware update is available. To start updating, connect your remote controller or mobile device to the internet and follow the on-screen instructions. Note that you cannot update the firmware if the remote controller is not linked to the aircraft. An internet connection is required.

### Using DJI Assistant 2 (Consumer Drones Series)

Update the aircraft and remote controller firmware separately using DJI Assistant 2 (Consumer Drones Series).

#### Follow the instructions below to update the aircraft firmware:

1. Launch DJI Assistant 2 (Consumer Drones Series) on your computer and log in with your DJI account.
2. Power on the aircraft and connect the aircraft to the computer via the USB-C port within 20 seconds.
3. Select DJI Air 3 and click Firmware Updates.
4. Select the firmware version.
5. Wait for the firmware to download. The firmware update will start automatically.
6. Wait for the firmware update to complete.

#### Follow the instructions below to update the remote controller firmware:

1. Launch DJI Assistant 2 (Consumer Drones Series) on your computer and log in with your DJI account.
2. Power on the remote controller and connect it to the computer via the USB-C port.
3. Select the corresponding remote controller and click Firmware Updates.
4. Select the firmware version.
5. Wait for the firmware to download. The firmware update will start automatically.
6. Wait for the firmware update to complete.

- ⚠ • The battery firmware is included in the aircraft firmware. Be sure to update all batteries.
  - Make sure to follow all the steps to update the firmware, otherwise the update may fail.
  - Make sure the computer is connected to the internet during the update.
  - Before performing an update, make sure the Intelligent Flight Battery is at least 40% charged and the remote controller is at least 20% charged.
  - Do not unplug the USB-C cable during an update.
  - The firmware update will take approximately 10 minutes. It is normal for the gimbal to go limp, aircraft status indicators to blink, and the aircraft to reboot. Wait patiently until the update is complete.
- 

Visit the link below to refer to the Air 3 Release Notes for more firmware update information for traceability.

<https://www.dji.com/air-3/downloads>

## Post-Flight Checklist

- Make sure to perform a visual inspection so that the aircraft, remote controller, gimbal camera, Intelligent Flight Batteries, and propellers are in good condition. Contact DJI support if any damage is noticed.
- Make sure that the camera lens and vision system sensors are clean.
- Make sure to store aircraft correctly before transporting it.

## Maintenance Instructions

To avoid serious injury to children and animals, observe the following rule:

1. Small parts, such as cables and straps, are dangerous if swallowed. Keep all parts out of reach of children and animals.
2. Store the Intelligent Flight Battery and remote controller in a cool, dry place away from direct sunlight to ensure the built-in LiPo battery does NOT overheat. Recommended storage temperature: between 22° and 28° C (71° and 82° F) for storage periods of more than three months. Never store in environments outside the temperature range of 14° to 113° F (-10° to 45° C).
3. DO NOT allow the camera to come into contact with or become immersed in water or other liquids. If it gets wet, wipe dry with a soft, absorbent cloth. Turning on an aircraft that has fallen in water may cause permanent component damage. DO NOT use substances containing alcohol, benzene, thinners, or other flammable substances to clean or maintain the camera. DO NOT store the camera in humid or dusty areas.
4. DO NOT connect this product to any USB interface older than version 3.0. DO NOT connect this product to any "power USB" or similar devices.
5. Check every aircraft part after any crash or serious impact. If there are any problems or questions, contact a DJI authorized dealer.

6. Regularly check the Battery Level Indicators to see the current battery level and overall battery life. The battery is rated for 200 cycles. It is not recommended to continue use afterward.
7. Make sure to transport the aircraft with the arms folded when powered off.
8. Make sure to transport the remote controller with antennas folded when powered off.
9. The battery will enter sleep mode after long-term storage. Charge the battery to exit from sleep mode.
10. Use the ND filter if the exposure time needs to be prolonged. Refer to the product information on how to install the ND filters.
11. Store and transport the aircraft, remote controller, battery, and charger in a dry environment. It is recommended to store and transport the product in an environment with an ambient temperature of 15° to 25° C and a humidity of about 40%. There is no special requirement for altitude during transportation or storage.
12. Remove the battery before servicing the aircraft (e.g., cleaning or attaching and detaching the propellers). Make sure that the aircraft and the propellers are clean by removing any dirt or dust with a soft cloth. Do not clean the aircraft with a wet cloth or use a cleanser that contains alcohol. Liquids can penetrate the aircraft housing, which can cause a short circuit and destroy the electronics.
13. Make sure to turn off the battery to replace or to check the propellers.

## Troubleshooting Procedures

1. Why can the battery not be used before the first flight?  
The battery must be activated by charging before using it for the first time.
2. How to solve the gimbal drift issue during flight?  
Calibrate IMU and compass in DJI Fly. If the problem persists, contact DJI Support.
3. No function  
Check if the Intelligent Flight battery and the remote controller are activated by charging. If the problems persist, contact DJI support.
4. Power-on and start-up problems  
Check if the battery has power. If yes, contact DJI support if it cannot be started normally.
5. SW update issues  
Follow the instructions in the user manual to update the firmware. If the firmware update fails, restart all the devices and try again. If the problem persists, contact DJI support.
6. Procedures to reset to factory default or last known working configuration  
Use the DJI Fly app to reset to factory default.
7. Shutdown and power-off problems  
Contact DJI support.
8. How to detect careless handling or storage in unsafe conditions  
Contact DJI support.

## Risk and Warnings

When the aircraft detects a risk after powering on, there will be a warning prompt on DJI Fly. Pay attention to the list of situations below.

1. If the location is not suitable for takeoff.
2. If an obstacle is detected during flight.
3. If the location is not suitable for landing.
4. If the compass and IMU experience interference and need to be calibrated.
5. Follow the on-screen instructions when prompted.

## Disposal



Observe the local regulations related to electronic devices when disposing of the aircraft and remote controller.

### Battery Disposal

Dispose of the batteries in specific recycling containers only after a complete discharge. DO NOT dispose of the batteries in regular trash containers. Strictly follow the local regulations regarding the disposal and recycling of batteries.

Dispose of a battery immediately if it cannot be powered on after over-discharging.

If the power on/off button on the Intelligent Flight Battery is disabled and the battery cannot be fully discharged, contact a professional battery disposal/recycling agency for further assistance.

## C1 Certification

DJI Air 3 (Model EB3WBC) is compliant with the requirements of the C1 certification. There are some requirements and restrictions when using DJI Air 3 in European Economic Area (EEA, i.e. EU plus Norway, Iceland and Liechtenstein). DJI Air 3 and its similar products can be distinguished by their model number.

|                         |          |
|-------------------------|----------|
| UAS Class               | C1       |
| Sound Power Level       | 81 dB    |
| Maximum Propeller Speed | 8400 RPM |

### MTOM Statement

DJI Air 3 is a quadrotor aircraft. The MTOM of DJI Air 3 (Model EB3WBC) is 720 g, including the propellers, the Intelligent Flight Battery and a microSD card, which is compliant with C1 requirements.

Users must follow the instructions below to comply with the MTOM C1 requirements. Otherwise, the aircraft cannot be used as a C1 aircraft:

1. DO NOT add any payload to the aircraft except the items listed in the List of Items including qualified accessories section.
2. DO NOT use any non-qualified replacement parts, such as intelligent flight batteries or propellers, etc.
3. DO NOT retrofit the aircraft.

- 
-  • The prompt "Low Battery RTH" will not appear in case of a horizontal distance between the pilot and aircraft is lower than 5 m.
- FocusTrack will exit automatically if the horizontal distance between the subject and the aircraft is further than 50 m (only available when using FocusTrack in the EU).
  - The auxiliary LED is set to auto when used in the EU and cannot be changed. The aircraft Front Arm LEDs are always on when used in the EU and cannot be changed.
- 

## Direct Remote ID

1. Transport Method: Wi-Fi Beacon
2. Method of uploading the UAS Operator Registration Number to the aircraft: Enter DJI Fly > Safety > UAS Remote Identification, and then upload UAS Operator Registration Number.

- 
-  • The remote identification transmission feature will be unavailable if stopping the motors mid-flight.
- 

## List of Items including qualified accessories

1. DJI Air 3 Low-Noise Propellers (Model: 8747F, 6.4 g each propeller)
2. DJI Air 3 ND Filters Sets (Model: EBCWBC-NDFS, 2.6 g)
3. DJI Air 3 Wide-Angle Lens (Model: EBCWBC-WAL, approx. 9.1 g)
4. DJI Air 3 Intelligent Flight Battery (Model: BWX233-4241-14.76, approx. 267 g)
5. MicroSD Card (Approx. 0.3 g)

## List of Spare and Replacement Parts

1. DJI Air 3 Low-Noise Propellers (Model: 8747F, 6.4 g each piece)
2. DJI Air 3 Intelligent Flight Battery (Model: BWX233-4241-14.76, approx. 267 g)

- 
-  • There is no change of endurance when installing items above onto the aircraft.
- 

## List of Safe Guards

Below is the list of the mechanical safeguards and operation safeguards for DJI Air 3.

1. The Combination Stick Command (CSC) can be performed to stop the propellers in case of an emergency. Refer to the Starting/Stopping the Motors section for details.
2. The Return to Home (RTH) function. Refer to the Return to Home section for details.
3. The vision system and three-dimensional infrared sensing system. Refer to the Vision System and Three-Dimensional Infrared Sensing System section for details.

4. Advanced Pilot Assistance Systems (APAS). Refer to the Advanced Pilot Assistance Systems (APAS) section for details.
5. DJI's GEO system provides real-time information on flight safety and restriction updates and prevents UAVs from flying in restricted airspace. Refer to the Flight Limits section for details.

## GEO Awareness

GEO Awareness contains the features listed below.

**UGZ (Unmanned Geographical Zone) Data update:** user can update the fly safe data through GPS by using the data update feature and store the data in the aircraft.

**GEO Awareness Map Drawing:** after the latest UGZ data is updated, a flight map with a restricted zone will be displayed in the DJI Fly app. Name, effective time, height limit, etc., can be viewed by tapping the area.

**GEO Awareness Pre-Warning:** the app will prompt the user with warning information when the aircraft is near or in a restricted area, the horizontal distance is less than 160 m, or the vertical distance is less than 40 m from the zone to remind the user to fly with caution.

## AGL (Above Ground Level) Statement

The vertical part of "Geo-awareness" may use the AMSL altitude or the AGL height. The choice between these two references is specified individually for each UGZ. Neither AMSL altitude nor the AGL height is supported by DJI Air 3. The height H appears in the DJI Fly app camera view, which is the height from the aircraft takeoff point to the aircraft. The height above the takeoff point may be used as an approximation but may differ more or less from the given altitude/height for a specific UGZ. The remote pilot remains responsible for not breaching the vertical limits of the UGZ.

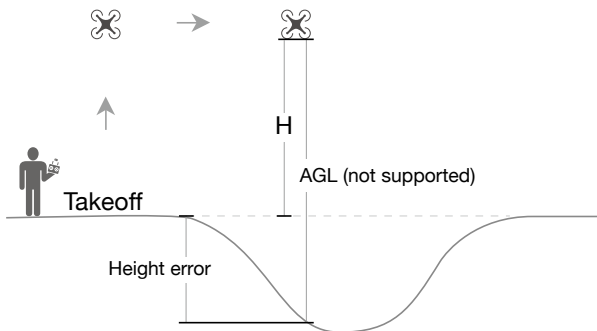

## Restricted Zones

Appear red in the DJI app. Users will be prompted with a warning, and flight is prevented. UA cannot fly or takeoff in these zones. Restricted Zones may be unlocked, to unlock contact [flysafe@dji.com](mailto:flysafe@dji.com) or go to Unlock A Zone at [dji.com/flysafe](http://dji.com/flysafe).



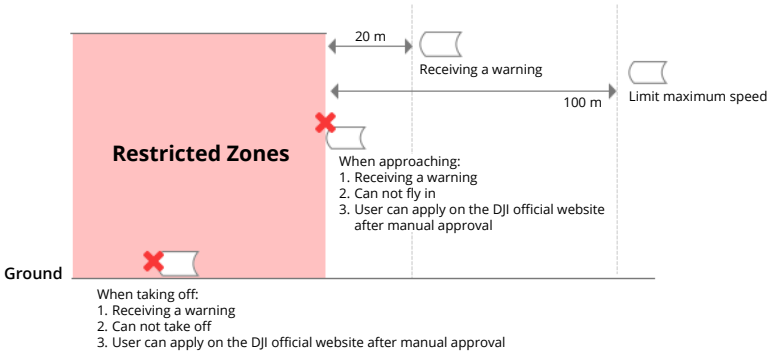

### Authorization Zones

Appear blue in the DJI app. Users will be prompted with a warning, and flight is limited by default. UA cannot fly or takeoff in these zones unless authorized. Authorization Zones may be unlocked by authorized users using a DJI verified account.

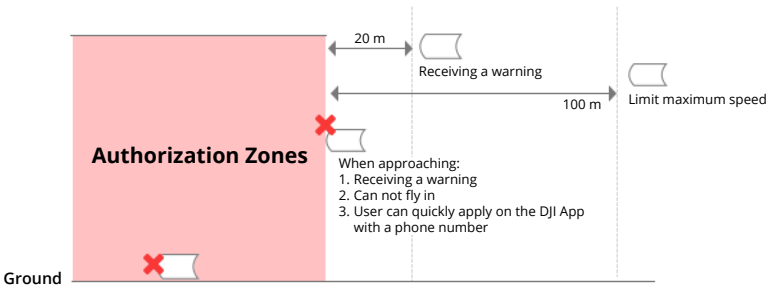

### Altitude Zones

Altitude zones are zones with a limited altitude and appear in gray on the map. When approaching, users receive warnings in the DJI app.

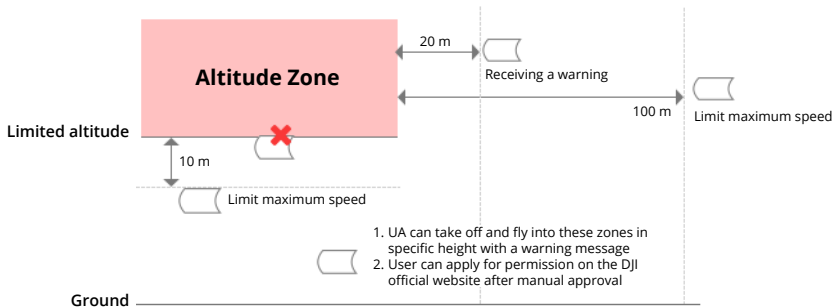

### Enhanced Warning Zones

A warning message will prompt users when the drone reaches the edge of the zone.



### Warning Zones

A warning message will prompt users when the drone reaches the edge of the zone.

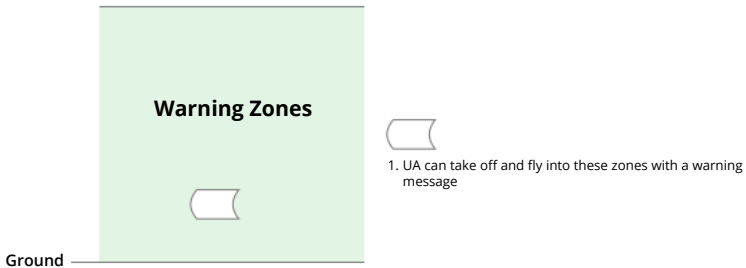

---

 • When the aircraft and DJI Fly app cannot obtain a GPS signal, the GEO awareness function will be inoperative. Interference of the aircraft antenna or disabling the GPS authorization in DJI Fly will cause the GPS signal fails to be obtained.

---

### EASA Notice

Make sure to read the Drone Information Notices document included in the package before use.

Visit the link below for more EASA notice information on traceability.

<https://www.easa.europa.eu/en/document-library/general-publications/drones-information-notices>

### Original Instructions

This manual is provided by SZ DJI Technology, Inc., and the content is subject to change.

Address: Lobby of T2, DJI Sky City, No. 53 Xianyuan Road, Xili Community, Xili Street, Nanshan District, Shenzhen, China, 518055.

## FAR Remote ID Compliance Information

The aircraft complies with the requirements of 14 CFR Part 89:

- The aircraft automatically broadcasts Remote ID messages from takeoff to shut down. An external device such as a cell phone or tablet is required to be connected as a location source to DJI mobile devices without an integrated GNSS system<sup>[1]</sup>, and must run the DJI flight control app such as DJI Fly in the foreground and always allow the DJI flight control app to obtain its accurate location information. The connected external device must minimally be one of the following:
  - 1) FCC Certified personal wireless device that uses GPS with SBAS (WAAS) for location services; or
  - 2) FCC Certified personal wireless device with integrated GNSS.Also, the external device must be operated in a way that does not interfere with the location reported and its correlation to the operator location.
- The aircraft automatically initiates a pre-flight self-test (PFST) of the Remote ID system before takeoff and cannot take off if it does not pass the PFST<sup>[2]</sup>. The results of the PFST of the Remote ID system can be viewed in either a DJI flight control app such as DJI Fly or DJI goggles.
- The aircraft monitors the Remote ID system functionality from pre-flight to shut down. If the Remote ID system malfunctions or has a failure, an alarm will be displayed in either a DJI flight control app such as DJI Fly or DJI goggles.

### Footnotes

[1] DJI mobile devices without an integrated GNSS system such as DJI RC-N2.

[2] The pass criterion for PFST is that the hardware and software of the Remote ID required-data source and radio transmitter in the Remote ID system are functioning properly.

## Aftersales Information

Visit <https://www.dji.com/support> to learn more about aftersales service policies, repair services, and support.

WE ARE HERE FOR YOU



Contact  
DJI SUPPORT

This content is subject to change.

**<https://www.dji.com/air-3/downloads>**

If you have any questions about this document, please contact DJI by sending a message to **DocSupport@dji.com**.

DJI is a trademark of DJI.

Copyright © 2023 DJI All Rights Reserved.