

Veritas™ 5360 Appliance Hardware Installation Guide

VERITAS™

Veritas 5360 Appliance Hardware Installation Guide

Last updated: 2024-01-19

Legal Notice

Copyright © 2024 Veritas Technologies LLC. All rights reserved.

Veritas, the Veritas Logo, and NetBackup are trademarks or registered trademarks of Veritas Technologies LLC or its affiliates in the U.S. and other countries. Other names may be trademarks of their respective owners.

This product may contain third-party software for which Veritas is required to provide attribution to the third party ("Third-party Programs"). Some of the Third-party Programs are available under open source or free software licenses. The License Agreement accompanying the Software does not alter any rights or obligations you may have under those open source or free software licenses. Refer to the Third-party Legal Notices document accompanying this Veritas product or available at:

<https://www.veritas.com/about/legal/license-agreements>

The product described in this document is distributed under licenses restricting its use, copying, distribution, and decompilation/reverse engineering. No part of this document may be reproduced in any form by any means without prior written authorization of Veritas Technologies LLC and its licensors, if any.

THE DOCUMENTATION IS PROVIDED "AS IS" AND ALL EXPRESS OR IMPLIED CONDITIONS, REPRESENTATIONS AND WARRANTIES, INCLUDING ANY IMPLIED WARRANTY OF MERCHANTABILITY, FITNESS FOR A PARTICULAR PURPOSE OR NON-INFRINGEMENT, ARE DISCLAIMED, EXCEPT TO THE EXTENT THAT SUCH DISCLAIMERS ARE HELD TO BE LEGALLY INVALID. VERITAS TECHNOLOGIES LLC SHALL NOT BE LIABLE FOR INCIDENTAL OR CONSEQUENTIAL DAMAGES IN CONNECTION WITH THE FURNISHING, PERFORMANCE, OR USE OF THIS DOCUMENTATION. THE INFORMATION CONTAINED IN THIS DOCUMENTATION IS SUBJECT TO CHANGE WITHOUT NOTICE.

The Licensed Software and Documentation are deemed to be commercial computer software as defined in FAR 12.212 and subject to restricted rights as defined in FAR Section 52.227-19 "Commercial Computer Software - Restricted Rights" and DFARS 227.7202, et seq. "Commercial Computer Software and Commercial Computer Software Documentation," as applicable, and any successor regulations, whether delivered by Veritas as on premises or hosted services. Any use, modification, reproduction release, performance, display or disclosure of the Licensed Software and Documentation by the U.S. Government shall be solely in accordance with the terms of this Agreement.

Veritas Technologies LLC
2625 Augustine Drive
Santa Clara, CA 95054

<https://www.veritas.com>

Technical Support

Technical Support maintains support centers globally. All support services will be delivered in accordance with your support agreement and the then-current enterprise technical support policies. For information about our support offerings and how to contact Technical Support, visit our website:

<https://www.veritas.com/support>

You can manage your Veritas account information at the following URL:

<https://my.veritas.com>

If you have questions regarding an existing support agreement, please email the support agreement administration team for your region as follows:

Worldwide (except Japan)

CustomerCare@veritas.com

Japan

CustomerCare_Japan@veritas.com

Documentation

Make sure that you have the current version of the documentation. Each document displays the date of the last update on page 2. The latest documentation is available on the Veritas website:

https://www.veritas.com/content/support/en_US/dpp.Appliances.html

Documentation feedback

Your feedback is important to us. Suggest improvements or report errors or omissions to the documentation. Include the document title, document version, chapter title, and section title of the text on which you are reporting. Send feedback to:

APPL.docs@veritas.com

You can also see documentation information or ask a question on the Veritas community site:

<https://www.veritas.com/community/>

Veritas Services and Operations Readiness Tools (SORT)

Veritas Services and Operations Readiness Tools (SORT) is a website that provides information and tools to automate and simplify certain time-consuming administrative tasks. Depending on the product, SORT helps you prepare for installations and upgrades, identify risks in your datacenters, and improve operational efficiency. To see what services and tools SORT provides for your product, see the data sheet:

https://sort.veritas.com/data/support/SORT_Data_Sheet.pdf

Contents

Chapter 1	Hardware overview	6
	About the appliance and the storage shelves	6
	Compute node drives	8
	About the 5360 Appliance control panel	8
	About the System Status LED states	11
	About the Power button LED states	14
	About the integrated BMC beep codes	15
	Compute node rear panel	16
	5U84 storage shelf drawers and disk drives	16
	5U84 storage shelf control panel	19
	5U84 storage shelf rear panel	21
	5U84 storage shelf RAID controller	21
	5U84 storage shelf Expansion module	22
	Cables and connectors	22
	About IPMI configuration	23
Chapter 2	Preinstallation requirements	25
	Customer-provided environment and supplies	25
	Appliance shipping container contents	26
	Storage shelf shipping container contents	27
	Dimensions and determining rack locations	27
	Best practices for rack installation	29
	Storage shelf rack requirements	30
	Heat dissipation	30
	Cable length verification	31
	Prerequisites for IPMI configuration	31
Chapter 3	Hardware installation procedures	33
	Overview	33
	Installing a storage shelf	34
	Installing disk drives into a full-capacity storage shelf	44
	Installing disk drives and blanks into a half-capacity storage shelf	47
	Installing the compute node rack rails	53
	Installing the compute node into a rack	58

	Connecting the hardware to one compute node	60
	Connecting the hardware to two compute nodes	67
	Connecting Flex nodes to the network	75
	Connecting the power cords	76
	Turning on the hardware and verifying operation	78
	Configuring the Veritas Remote Management Interface from a Flex Appliance	81
	Accessing and using the Veritas Remote Management interface	85
Appendix A	Adding Expansion Storage Shelves to an operating appliance that does not have any Expansion shelves	88
	Overview	88
	Turning off the existing hardware	89
	Installation instructions	90
	Connecting one Expansion Shelf to the Primary Shelf	90
	Connecting two Expansion Shelves to the Primary Shelf	93
	Connecting three Expansion Shelves to the Primary Shelf	97
Appendix B	Adding Expansion Storage Shelves to an operating appliance that has at least one operating Expansion shelf	101
	Overview	101
	Turning off the existing hardware	102
	Installation instructions	103
	Connecting one Expansion Shelf to a system that has one existing Expansion Shelf	104
	Connecting two Expansion Shelves to a system that has one existing Expansion Shelf	106
	Connecting one Expansion Shelf to a system that has two existing Expansion Shelves	111
Appendix C	Configuring the disk space for new Flex Expansion Storage Shelves	116
	Adding the disk space of an Expansion Storage Shelf from the Flex Appliance Console	116

Hardware overview

This chapter includes the following topics:

- [About the appliance and the storage shelves](#)
- [Compute node drives](#)
- [About the 5360 Appliance control panel](#)
- [Compute node rear panel](#)
- [5U84 storage shelf drawers and disk drives](#)
- [5U84 storage shelf control panel](#)
- [5U84 storage shelf rear panel](#)
- [5U84 storage shelf RAID controller](#)
- [5U84 storage shelf Expansion module](#)
- [Cables and connectors](#)
- [About IPMI configuration](#)

About the appliance and the storage shelves

The Veritas 5360 Appliance is a hardware and software storage system designed for large workloads. It provides high performance with multiple service offerings and gets deployed in less than 60 minutes.

Figure 1-1 Veritas 5360 Appliance

The Veritas 5360 appliance is available as a single-node or a two-node appliance.

The Veritas 5360 appliance and storage shelves provide storage capacity in several configurations. The 5360 compute node does not provide any storage. The 5U84 storage shelves provide storage capacity for the appliance system. You must have a Primary Storage Shelf that connects to the compute node. You can add up to three optional Expansion Storage Shelves for additional storage.

The Veritas 5360 high availability (HA) configuration includes two compute nodes, one required Primary Storage Shelf, and up to three optional Expansion Storage Shelves.

The Veritas 5360 Appliance supports the following software:

- Flex Appliance release 3.2 and above

Before you install the hardware, refer to the following section for important details about the dimensions of the hardware.

See [“Dimensions and determining rack locations”](#) on page 27.

The compute node is two rack units (2RU) high.

Each storage shelf is 5RU high and contains 2 drawers with 42 disk drive slots per drawer.

The rear of the Primary shelf includes two redundant RAID controller I/O modules. The Expansion shelves contain two I/O modules for connectivity to the Primary shelf and to other Expansion shelves. Half capacity storage shelves are also available for the 5360 appliances.

Refer to the *Veritas 5360 Product Description Guide* at the following site for details about usable storage capacity.

[Veritas Appliance documentation](#)

Compute node and storage shelf power requirements

With the required 5U84 Primary Storage Shelf, the compute node operates at 220 VAC at 3.1 A with C13 and C14 connectors. The Storage shelves operate with C19 and C20 connectors.

Compute node drives

The front panel of the compute node contains 8 drive slots. The slots are numbered from zero in the left corner to 7 in the right corner.

Figure 1-2 Veritas 5360 Appliance front drive assignments



- Slots 0 and 1 - RAID-1 OS and log volume
- Slot 2 - OS/log hot spare
- Slots 3 through 7 - blank

About the 5360 Appliance control panel

The front control panel provides push button system controls and LED indicators for several system features.

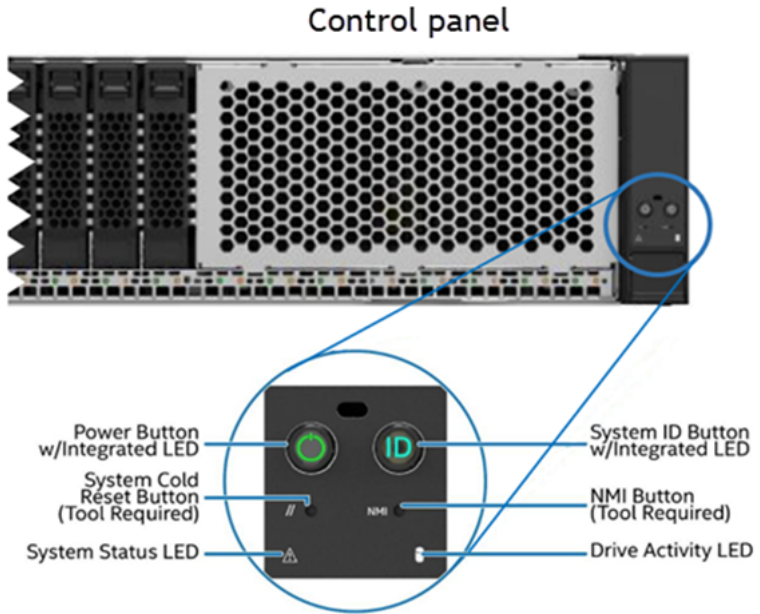

Table 1-1 Control panel system LED descriptions

LED	System information
Power button with integrated LED	<p>The Power button toggles the system on and off. This button also functions as a sleep button if enabled by an ACPI compliant operating system. Pressing this button sends a signal to the integrated BMC that either powers on or powers off the system. Holding the power button for 10 seconds or more leads to a hard shutdown.</p> <p>The integrated LED is a single color (green) and supports different indicator states as defined in the following table. See “About the Power button LED states” on page 14.</p>
Drive Activity LED	<p>The drive activity LED on the front panel indicates drive activity from the server board SATA and sSATA storage controllers. The server board also has an I2C header labeled “SAS_MODULE_MISC” to provide access to this LED for add-in SATA or sSATA storage controllers.</p>

Table 1-1 Control panel system LED descriptions (*continued*)

LED	System information
System ID button with integrated LED	<p>Toggles the integrated ID LED and the blue server board system ID LED on and off. Both LEDs are tied together and show the same state. The onboard system ID LED is on the back edge of the server board, viewable from the back of the system. The system ID LEDs are used to identify the system for maintenance when installed in a rack of similar server systems. Two options available for illuminating the system ID LEDs are:</p> <ul style="list-style-type: none"> ■ The front panel system ID LED button is pushed, which causes the LEDs to illuminate to a solid On state until the button is pushed again. ■ An IPMI <code>Chassis Identify</code> command is remotely entered that causes the LEDs to blink for 15 seconds.
NMI button (recessed, tool required for use)	<p>When the NMI button is pressed, it puts the system in a halt state and issues a non-maskable interrupt (NMI). This situation can be useful when performing diagnostics for a given issue where a memory download is necessary to help determine the cause of the problem. To prevent an inadvertent system halt, the actual NMI button is behind the front control panel faceplate where it is only accessible with the use of a small tipped tool like a pin or paper clip.</p>
System Cold Reset Button	<p>When pressed, this button reboots and re-initializes the system. Unlike the power button, the reset button does not disconnect the power to the system. It just starts the system's Power-On Self-Test (POST) sequence over again.</p>

Table 1-1 Control panel system LED descriptions (*continued*)

LED	System information
System Status LED	<p>The system status LED is a bi-color (green/amber) indicator that shows the current health of the server system.</p> <p>The system provides two locations for this feature; one is on the front control panel and the other is on the back edge of the server board, viewable from the back of the system. Both LEDs are tied together and show the same state. The system status LED states are driven by the server board platform management subsystem. When the server is powered down (transitions to the DC-Off state or S5), the BMC is still on standby power and retains the sensor and front panel status LED state established before the power-down event.</p> <p>Two locations are provided for you to monitor the health of the system. You can find the first location on the front control panel, while the second location is located on the back edge of the server board. It is viewable from the rear of the appliance. Both LEDs show the same state of health.</p> <p>See “About the System Status LED states” on page 11.</p>

About the System Status LED states

The following table provides a description of each LED state.

Table 1-2 System Status LED states

Color	State	Criticality	Description
No color	Off - The system is not operating.	Not ready	<ul style="list-style-type: none"> ■ System power is off (AC and/or DC) ■ System is in EuP Lot6 Off Mode

Table 1-2 System Status LED states (*continued*)

Color	State	Criticality	Description
Green	Solid on (SO)	Healthy	<ul style="list-style-type: none"> ■ System is in S5 Soft-Off State ■ Indicates that the system is running (in S0 State) and its status is “Healthy”. The system is not exhibiting any errors. AC power is present and BMC has booted and manageability functionality is up and running. ■ After a BMC reset, and with the chassis ID solid on, the BMC is booting Linux*. Control has been passed from BMC uBoot to BMC Linux*. The BMC is in this state for roughly 10–20 seconds.
Green	~1 Hz blink	<p>Degraded</p> <p>The system is operating in a degraded state although still functional.</p> <p>or</p> <p>The system is operating in a redundant state but with an impending failure warning.</p>	<p>System degraded:</p> <ul style="list-style-type: none"> ■ Redundant loss, such as power supply or fan. Applies only if the associated platform sub-system has redundancy capabilities. ■ Fan warning or failure when the number of fully operational fans is more than minimum number needed to cool the system. ■ Non-critical threshold crossed: Temperature (including HSBP temp), voltage, input power to power supply, output current for main power rail from power supply and Processor Thermal Control (Therm Ctrl) sensors. ■ Power supply predictive failure occurred while redundant power supply configuration was present. ■ Unable to use all of the installed memory (one or more DIMMs failed/disabled but functional memory remains available). ■ Battery failure ■ BMC executing in uBoot. (Indicated by Chassis ID blinking at 3Hz). System in degraded state (no manageability). BMC uBoot is running but has not transferred control to the BMC Linux. Server will be in this state 6-8 seconds after BMC reset while it pulls the Linux image into flash.

Table 1-2 System Status LED states (*continued*)

Color	State	Criticality	Description
Green	~1 Hz blink	Degraded (continued)	<p>System degraded (continued):</p> <ul style="list-style-type: none"> ■ BMC Watchdog has reset the BMC. ■ Power unit sensor offset for configuration error is asserted. ■ SSD Hot Swap Controller is off-line or degraded.
Green and amber alternately	~1 Hz blink	System is initializing after source power is applied	<ul style="list-style-type: none"> ■ PFR in the process of updating/authenticating/recovering when source power is connected, system firmware being updated. ■ System not ready to take power button event/signal.
Amber	~1 Hz blink	<p>Non-critical</p> <p>The system is operating in a degraded state with an impending failure warning. However, the system is still functioning.</p>	<p>Non-fatal, although the system is likely to fail due to the following issues:</p> <ul style="list-style-type: none"> ■ Critical threshold crossed – Voltage, temperature (including HSBP temp), input power to power supply, output current for main power rail from power supply and PROCHOT (Therm Ctrl) sensors. ■ VRD Hot asserted ■ Minimum number of fans to cool the system not present or failed ■ Hard drive fault ■ Power Unit Redundancy sensor – Insufficient resources offset (indicates not enough power supplies present) ■ In non-sparing and non-mirroring mode, if the threshold of correctable errors is crossed within the window. ■ Invalid firmware image detected during boot up or firmware update.

Table 1-2 System Status LED states (*continued*)

Color	State	Criticality	Description
Amber	Solid on	Critical, non-recoverable – System is halted	<p>Fatal alarm – system has failed or shutdown:</p> <ul style="list-style-type: none"> ■ CPU CATERR signal asserted ■ MSID mismatch detected (CATERR also asserts for this case) ■ CPU0 is missing ■ CPU Thermal Trip ■ No power – power fault ■ DIMM failure when there is only one DIMM present; no other good DIMM memory present ■ Runtime memory uncorrectable error in non-redundant mode. ■ DIMM Thermal Trip or equivalent ■ BMC/Video memory test failed (Chassis ID shows blue/solid-on for this condition) ■ SBB Thermal Trip or equivalent ■ 240VA fault ■ Both uBoot BMC FW images are bad (Chassis ID shows blue/solid-on for this condition) ■ Fatal Error in processor initialization: <ul style="list-style-type: none"> ■ Processor family not identical ■ Processor model not identical ■ Processor core/thread counts not identical ■ Processor cache size not identical ■ Unable to synchronize processor frequency ■ Unable to synchronize QPI link frequency ■ BMC fail authentication with non-recoverable condition, system hang at T-1; boot PCH only, system hang; PIT failed, system lockdown.

About the Power button LED states

The following table provides a description of each power state.

Table 1-3 Power button LED states

State	Power Mode	LED	Description
Power - off	Non-ACPI	Off	The system power is off, and the BIOS has not initialized the chipset.
Power - on	Non-ACPI	On	The system power is on and the green Power button LED is active.
S0	ACPI (Advanced Configuration and Power Interface)	Steady on	The system and the operating system are up and running.
S5	ACPI (Advanced Configuration and Power Interface)	Off	Mechanical is off and the operating system has not saved any context to the hard disk drive.

About the integrated BMC beep codes

The integrated BMC may generate beep codes upon detection of failure conditions. Beep codes are sounded each time the problem is discovered, such as on each power-up attempt, but are not sounded continuously.

Table 1-4 Integrated BMC beep codes

Associated sensors	Reason for beep
CPU missing sensor	No CPUs installed or first CPU socket is empty.
MSID mismatch sensor	MSID mismatch occurs if a processor is installed into a system board that has incompatible power capabilities.
Power fault	DC power unexpectedly lost (power good dropout) – Power unit sensors report power unit failure offset.
Power unit – soft power control failure offset	Power control fault (power good assertion timeout).
VR watchdog timer	VR Watchdog Timer sensor assertion
PS status	The system does not power on or unexpectedly power off and a power supply unit (PSU) is present that is an

Compute node rear panel

The rear panel of the compute node contains several components and default ports. Three PCIe riser assemblies support various configurations.

PCIe riser card assemblies 1 and 2 each support three standard PCIe cards, while PCIe riser card assembly 3 supports two low profile PCIe cards.

Figure 1-3 Veritas 5360 Appliance rear panel

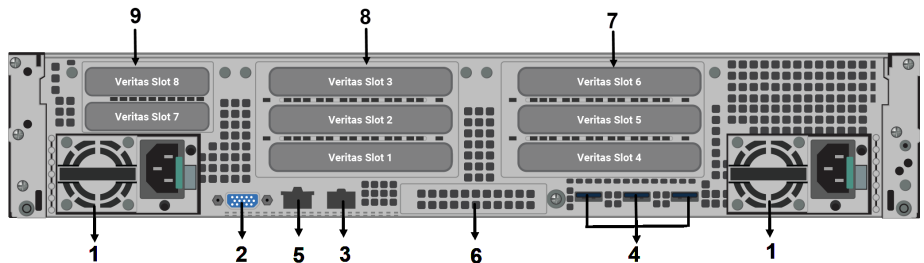

Back panel layout of the Veritas 5360 Appliance

1. Redundant 1300 W power modules
2. VGA port
3. Serial port (not used)
4. USB 3.0 ports
5. IPMI port
6. OCP 1-10 GbE ports
7. PCIe Riser # 1
8. PCIe Riser # 2
9. PCIe Riser # 3

5U84 storage shelf drawers and disk drives

Each storage shelf includes 2 drawers with 42 disk drive slots each for a total of 84 slots. The following diagrams describe the disk layout for the top drawer and the bottom drawer. The slot numbers start at the front, left of the drawer. Slot numbers end in the last row at the right rear of the drawer.

The following diagrams show all of the slots in each drawer. The photographs show the number of the first slot in each drawer.

The top drawer contains slots 0 through 41.

Figure 1-4 Half-populated storage shelf

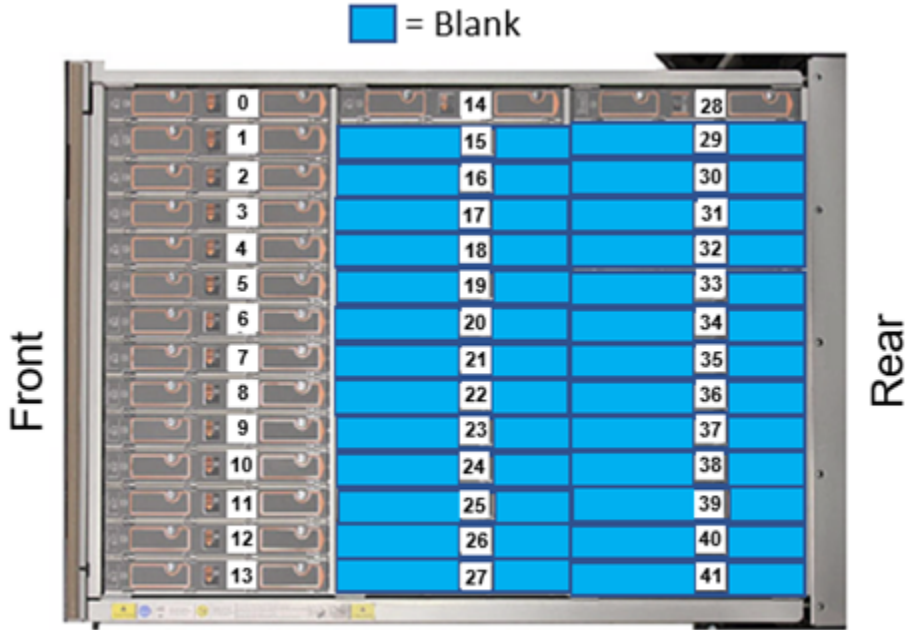

Top Drawer (drawer 0)

Figure 1-5 Fully-populated storage shelf

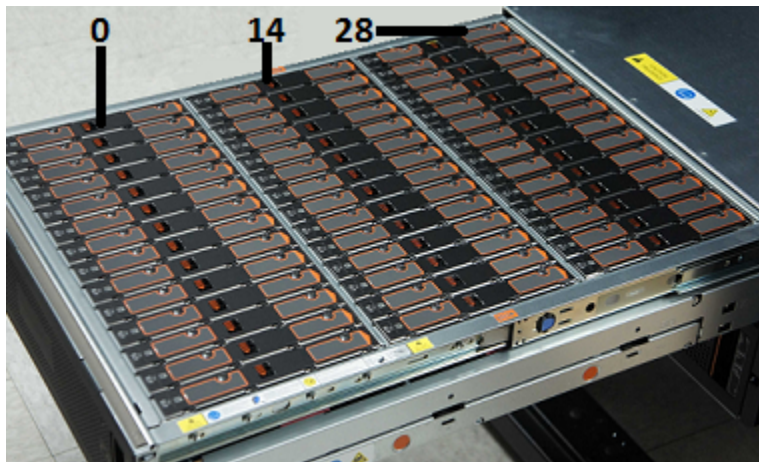

The bottom drawer contains slots 42 through 83.

Figure 1-6 Half-populated storage shelf

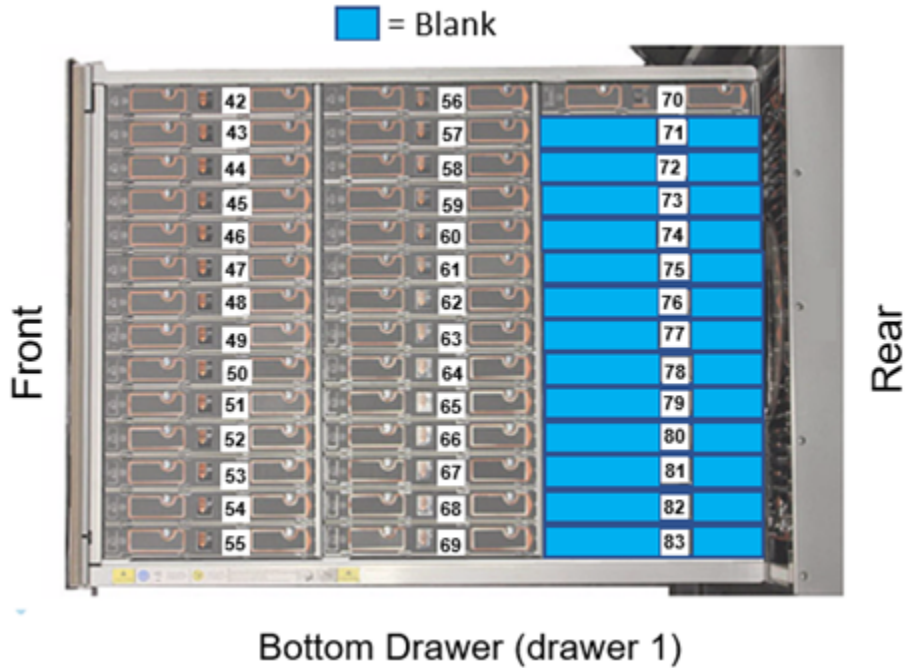

Disk drives are not preconfigured before they ship from the factory. During the initial installation any drive can be placed into any slot for a full storage shelf. After the compute nodes and storage shelves are configured and operational, you cannot rearrange the drives.

The compute nodes support storage shelves with half of the total usable capacity. This configuration includes 45 disk drives and 39 blank carriers. You receive one

container of 42 disk drives and another container of 3 drives and 39 blanks. Install these disk drives into the storage shelf drawers.

Refer to the following link for the disk drive layout for a half capacity storage shelf.

See [“Installing disk drives and blanks into a half-capacity storage shelf”](#) on page 47.

Each disk drive is encased in a carrier. A label on the top of the carrier identifies the storage capacity of the disk that is inside the carrier.



A blank carrier is very similar to a disk drive carrier. The upper latch assembly is the same. A label identifies the carrier as a blank instead of storage capacity.



5U84 storage shelf control panel

The following table explains the components in the storage shelf control panel.



Number	Component	Description
1	Unit identification (ID) display	A numerical enclosure display that helps when setting up and maintaining multiple storage shelves. The Primary shelf has a default value of 00. The first Expansion shelf has a value of 01. Subsequent Expansion shelves have a value of 02 and 03.
2	Input switch	Used to set the unit identification display.
3	Power LED	Amber when the system is in standby mode. Green when the system is on.
4	Module fault LED	Amber when there is a system hardware fault. An LED may be lit on a power supply, drawer, disk carrier, cooling module, or I/O module to identify which component is at fault.
5	Logical status LED	Shows a change of status or a fault. Typically these changes of status or faults are associated with the shelf's disk drives. However, the Logical Status LED can also indicate an issue with an internal RAID controller or external RAID controller, or with a host bus adapter.
6	Drawer 1 fault LED	Indicates a drive, cable, or sideplane fault in Drawer 1, the top drawer.
7	Drawer 2 fault LED	Indicates a drive, cable, or sideplane fault in Drawer 2, the bottom drawer.

5U84 storage shelf rear panel

The rear panel of a 5U84 storage shelf contains the following components:

- Two I/O module slots, which contain either redundant RAID controllers or Expansion modules. (Item 1)
- Five cooling modules (Item 2)
- Two power supply units (PSUs) (Item 3)

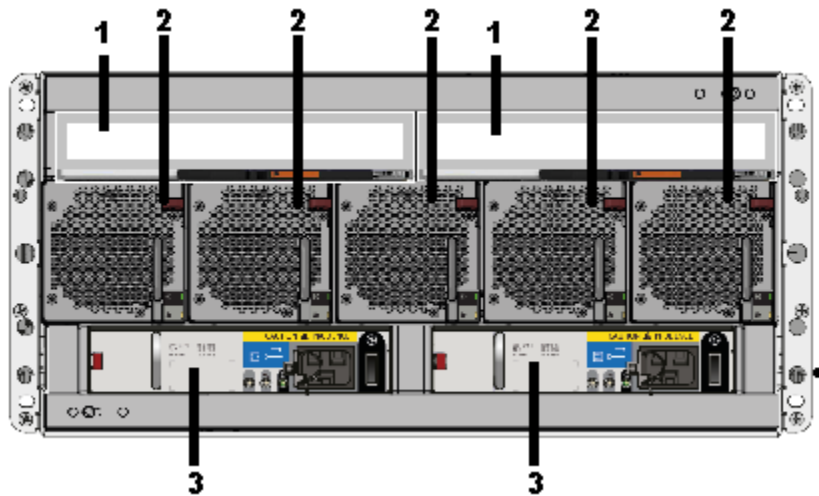

Each cooling module contains two fans. Cooling modules can be individually replaced but cannot be taken apart to replace only one fan.

Refer to the following sections for information about the I/O modules.

See [“5U84 storage shelf RAID controller”](#) on page 21.

See [“5U84 storage shelf Expansion module”](#) on page 22.

5U84 storage shelf RAID controller

The Primary Storage Shelf contains two RAID controllers in I/O module slots. The controllers are labeled A and B, from left to right as you look at the rear panel of a shelf. Each controller has two sets of SAS-3 ports. From left to right the SAS-3 ports for each controller are labeled 3, 2, 1, and 0. The single SAS-3 port on the left side of each RAID controller connects to a SAS-3 port on the Expansion shelf.



5U84 storage shelf Expansion module

Each Expansion storage shelf contains two I/O modules. The modules are labeled A and B, from left to right as you look at the rear panel of a shelf. Each module has three SAS-3 ports that are labeled A, B, and C from left to right.

A yellow label states that port B is for attachment to a server only. You cannot use this port without permission and assistance from Veritas Technical Support.

The SAS-3 ports connect to the SAS port on each RAID controller on the Primary shelf and to other Expansion shelves.

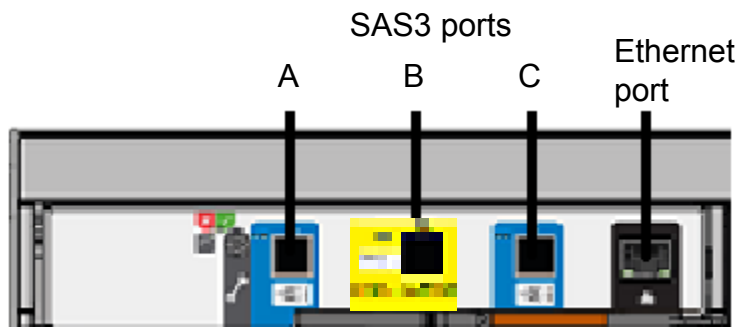

Cables and connectors

Compute nodes connect to each other with 1G Ethernet cables.

The compute nodes connect to the Primary Storage Shelf with SAS-3 cables.

The Primary Storage Shelf connects to Expansion Storage Shelf I/O modules with SAS-3 cables.

Expansion Storage Shelves connect to each other with SAS-3 cables.

The power connector that attaches to a storage shelf has a right-angled form factor.



A security tie assures continued connection between the power cable and the storage shelf.

About IPMI configuration

The Intelligent Platform Management Interface (or IPMI) provides management and monitoring capabilities independently of the host system's CPU, firmware, and operating system. You can configure the IPMI sub-system for your appliances. You can use the remote management port, located on the rear panel of the appliance, to connect to the IPMI sub-system.

The following figure shows the remote management port (or the IPMI port) on the rear panel of a 5360 Appliance:



The IPMI is beneficial after an unexpected power outage shuts down the connected system. In case the appliance is not accessible after the power is restored, you can use a laptop or desktop computer to access the appliance remotely by using a network connection to the hardware rather than to an operating system or login shell. This enables you to control and monitor the appliance even if it is powered down, unresponsive, or without any operating system.

The following diagram illustrates how IPMI works:

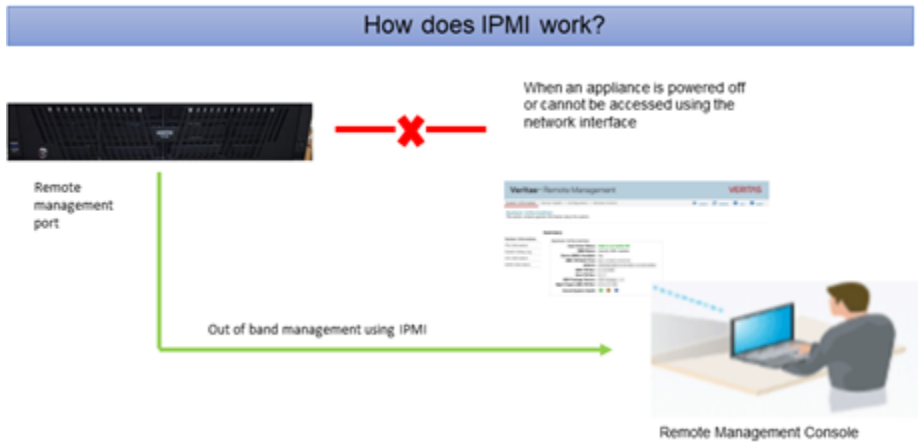

The following are some of the main uses of IPMI:

- Manage an appliance that is powered off or unresponsive. Using the IPMI, you can power on, power off, or restart the appliance from a remote location.
- Provide out-of-band management and help manage situations where local physical access to the appliance is not possible or preferred like branch offices and remote data centers.
- Access the Appliance Shell Menu remotely using IPMI if regular network interface is not possible.
- Reimage the appliance from the IPMI interface by using ISO redirection.
- Monitor hardware health of the appliance from a remote location.
- Avoid messy cabling and hardware like keyboard, monitor, and mouse (KVM) solutions to access the appliance.
- Required to elevate to an unrestricted shell for support when in lockdown mode.

Preinstallation requirements

This chapter includes the following topics:

- [Customer-provided environment and supplies](#)
- [Appliance shipping container contents](#)
- [Storage shelf shipping container contents](#)
- [Dimensions and determining rack locations](#)
- [Best practices for rack installation](#)
- [Storage shelf rack requirements](#)
- [Heat dissipation](#)
- [Cable length verification](#)
- [Prerequisites for IPMI configuration](#)

Customer-provided environment and supplies

For best ventilation, the rack cabinet:

- Should be at least 100 cm (4 feet) from walls
- Should have at least 100 cm (4 feet) from other cabinets on the front and back of the appliance and the storage shelves

Data centers with two-foot spaces in the front and in the back of the appliances are acceptable with proper cooling and ventilation.

Refer to the following section for more details.

See “[Heat dissipation](#)” on page 30.

The following describes the necessary personnel and equipment that are needed at the installation site:

- At least three people or a mechanical lift to move the appliance and the storage shelves.
- Cables to connect the appliance to your corporate network.
- A USB-keyboard and a monitor to connect to the appliance.
- A 19-inch rack with dual Power Distribution Units (PDUs) with 120VAC or 220VAC power supplies for the compute node.
- A magnetic Philips-head screw driver to install the storage shelf rails into the rack.
- A screwdriver with a 2mm Hex bit to secure the bezels to the front of each storage shelf drawer.
- A 19-inch rack with dual Power Distribution Units (PDUs) with 220VAC power input for the storage shelves.

See “[Best practices for rack installation](#)” on page 29.

Appliance shipping container contents

The appliance and each storage shelf are shipped in separate containers. Each container includes other boxes and contents. The disk drives are installed into the appliance and the storage shelf at the factory.

The following items ship within the appliance box.

- Cables to connect the appliance to the Primary external storage.
 - Four SAS-3 cables for a non-HA compute node.
 - Four additional (total of eight) SAS-3 cables for an HA compute node.
- Cables to connect the HA compute nodes.
 - Two CAT-6 Ethernet cables for interconnection between HA compute nodes. Included in Accessory Package.
- QR code card that includes links to the following items:
 - Veritas Appliance Getting Started documents (https://www.veritas.com/content/support/en_US/article.100053037) such as deployment plans and cabling posters

- Appliances Support page (https://www.veritas.com/content/support/en_US/dpp.Appliances) that links to the appliance documentation and other resources
- Envelope containing the following:
 - Warranty and license information
- Accessory box containing rack rails
- Two power cables
- Bezel

Storage shelf shipping container contents

The appliance and each storage shelf are shipped in separate containers. Each container includes other boxes and contents.

The following items ship within the storage shelf box.

- Rack rails
- Two SAS-3 cables
- Two power cords

Dimensions and determining rack locations

Physical specifications for the compute node include the following.

- Each node is two rack units (2RU) high.
- Node measurements are listed below.
 - Height: 8.7cm (3.43") (approximately 2U)
 - Width: 44.6cm (17.56")
 - Length/depth: 77.0cm (30.31")
- The compute node rails are extensible to 820mm (32in). The minimum distance or depth allowed between the rack posts is 623mm (24.6"). The maximum distance or depth allowed between the rack posts is 942mm (37").

Physical specifications for the 5U84 storage shelves include the following.

- Each storage shelf is 5RU high.
- Storage shelf measurements are listed below.
 - Height: 22.3 cm (8.75") (approximately 5U - shelf, overall)

- Width: 48.3 cm (19.0") (across the mounting flange)
- Length/depth: 93.3cm (36.75") (from rear of the front flanges to the rear extremity of the chassis)

Note: The 5U84 storage shelf is longer than a standard IEC-compliant rack. Be sure that your rack cabinet and Power Distribution Units accommodate the length of the storage shelves.

- The storage shelf rails measure 71.3cm to 88.4cm (28" to 34.8") in length. Be sure that your rack accommodates this distance from the inside of the front post to the inside of the rear post. Plan for additional space to accommodate power strips, power cords, and other cables.

When you plan the installation be sure to allocate enough space for all of the hardware.

A typical installation has the storage shelves on the bottom and the compute node(s) at the top.

To help you identify RU spacing, many rack manufacturers use a system of lines and sequential numbers starting at the bottom of the rack. The front and the rear of the rack are marked the same to ensure that the rails are installed straight and level. One RU has three holes. The holes for one RU are typically marked with a line below the bottom hole and another line at the top hole.

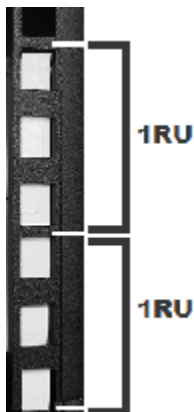

Use the rack templates to determine the mounting locations for all devices.

To determine rack locations for the hardware

- 1 Determine the total number of rack units (RUs) that you need as follows:
- 2 Use the rack templates to determine RU locations.
- 3 Fold the compute node templates at the horizontal yellow lines.
- 4 Use the following graphics to determine where pins and screws for the storage shelves fit into the rack.
 - The front of each rail includes four pins that insert into the rear of the front rack post. One screw fits into the middle hole of the middle RU.
 - The rear of each rail includes four pins that insert into the inside of the rear rack post. Two screws insert into the front of the rear rack post. The screws install into the middle hole in the first and the fifth RU.
- 5 Record the rack positions to help you locate them easily when mounting the hardware.

Best practices for rack installation

Prepare for the hardware installation by following these recommendations.

- The appliance requires two RUs of space. Install the appliance in the space that is directly above the storage shelves.
- Two people should install the rails; one person at the back of the rack and one at the front.
- Two people should lift and place the appliance into the mounted rails.
- The storage shelves are heavier than the appliance and should be installed as close to the bottom of the rack as possible.
- Always install the heavier storage shelves at the bottom of the rack. Best practices recommend that you install hardware at the bottom of a rack first. Then work your way up the rack.
- Determine device order and cabling limits.
- Be aware of the depth of the guide rails and the devices. Ensure that the distance between cabinet posts accommodates the rails, devices, cables, and extending ears.
- Physically hold a SAS-3 cable between the intended locations for the appliance and the last storage shelf. Visually confirm that the cable is long enough.

Storage shelf rack requirements

For best ventilation, the rack cabinet:

- Should be at least 100 cm (4 feet) from walls.
- Should have at least 100 cm (4 feet) from other cabinets on the front and back of the appliance and the storage shelves.
- Data centers with two-foot spaces in the front and in the back of the appliances are acceptable with proper cooling and ventilation
- There must be a minimum depth of 76 cm (30 in.) between the front of the rack and the rear of the rack.
- The compute node rails are extensible to 820mm (32in). The minimum distance or depth allowed between the rack posts is 623mm (24.6"). The maximum distance or depth allowed between the rack posts is 942mm (37").
- Storage shelves should be installed lower in the rack than the appliance.

The following list describes the necessary personnel and equipment that customers must supply at the installation site:

- At least two people or a mechanical lift to move the appliance and the storage shelves.
- Two people to install the rails; one person at the back of the rack and one at the front
- Two people to lift and place the storage shelf into the mounted rails
- Cables to connect the appliance to your corporate network.
- A USB-keyboard and a monitor to connect to the appliance.
- A 19-inch rack with dual Power Distribution Units (PDUs) with 220VAC power supplies.

Heat dissipation

Air flows from the front of each unit and exits from the rear of each unit. You can install the optional bezel without disruption to the airflow.

For best ventilation, the rack cabinet should:

- Be at least 100 cm (4 feet) from walls.
- Be at least 100 cm (4 feet) from other cabinets on the front and back of the appliance and the storage shelves.

Note: Data centers with two-foot spaces in the front and in the back of the appliances are acceptable with proper cooling and ventilation.

Veritas provides the following requirements to ensure sufficient cooling.

- Veritas requires that you install the system in a National Engineering Manufacturer's Association (NEMA)-certified or equivalent rack.
- A minimum of 3 inches (7.6 cm) of space must be between the front of an appliance and the cabinet door or other air block.
- A minimum of 6 inches (15.2 cm) of space must be between the rear of an appliance and the cabinet rear or other air block.
- A minimum of 1 inch (2.5 cm) of space must be between the front of a storage shelf and the cabinet door or other air block.
- A minimum of 2 inches (5.0 cm) of space must be between the rear of a storage shelf and the cabinet rear or other air block.

Refer to the *Veritas Appliance Product Description Guide* for specifications about temperature and cooling.

[Appliance documentation](#)

Cable length verification

Before you install and connect the hardware, be sure to verify that you have the correct length of cables for your setup.

Each rack unit (RU) is 44.50 mm (1.752 inches) in height. The compute node is 2RU high.

The 5U84 Storage Shelves are 5RU high.

Two SAS-3 cables ship with each Expansion Storage Shelf. Each SAS-3 cable is 1-meter (3.28 feet) long.

Note: If you must have Expansion shelves in different racks be sure that the SAS-3 cables are long enough. Do not stretch the cables too tightly or try to use adapters or extensions.

Prerequisites for IPMI configuration

Verify the following configuration prerequisites:

- The remote management port auto-negotiates its link speed to 1 Gbps.

Note: If the IPMI port is connected to a managed switch port, it is recommended that you configure the switch port to auto-negotiation

- If a firewall exists between the appliance and the remote devices that manage an appliance (like a laptop computer), open the following ports:

66	SOL SSH
80	HTTP
162	SNMP
443	HTTPS
623	Floppy/USB media
627	Secured Floppy/USB media
5120	CD
5124	Secured CD
5900	KVM
5902	Secured KVM

Note: If you have a private internal network, remember to configure the settings accordingly in your network address translation (NAT).

- The remote management port must be configured as a DHCP or static address.

Hardware installation procedures

This chapter includes the following topics:

- [Overview](#)
- [Installing a storage shelf](#)
- [Installing disk drives into a full-capacity storage shelf](#)
- [Installing disk drives and blanks into a half-capacity storage shelf](#)
- [Installing the compute node rack rails](#)
- [Installing the compute node into a rack](#)
- [Connecting the hardware to one compute node](#)
- [Connecting the hardware to two compute nodes](#)
- [Connecting Flex nodes to the network](#)
- [Connecting the power cords](#)
- [Turning on the hardware and verifying operation](#)
- [Configuring the Veritas Remote Management Interface from a Flex Appliance](#)
- [Accessing and using the Veritas Remote Management interface](#)

Overview

This chapter describes the procedures to install one or two compute nodes, one Primary Storage Shelf, and up to three Expansion Storage Shelves.

Installing a storage shelf

You can use this installation procedure for a Primary Storage Shelf and up to three Expansion Storage Shelves. For the systems that include one or more Expansion Shelves, install those units first followed by the Primary Shelf. Always load hardware into a rack from the bottom to ensure personal safety and proper weight distribution of equipment.

From the inside of the front post to the inside of the rear post the rails measure 713mm to 884mm (28in to 34.8in). Be sure that your rack accommodates this distance. Allow extra space to accommodate power strips, power cords, and other cables.

Warning: A storage shelf without disk drives weighs up to 61.65kg (135.72lbs). To avoid potential equipment damage and personal injury, do not install disk drives into the storage shelves before mounting them into the rack. The added weight of the disk drives hinders the ability to safely install the storage shelves. Use the lifting straps that are provided with the shelf to remove the shelf from the shipping container. Use a mechanical lift or have three people raise the shelf into position. The rear of the shelf is heavier than the front of the shelf.

To install the storage shelf rails

Veritas recommends that two people install the rails. One person works at the back of the rack and one person is at the front of the rack.

A magnetic Philips-head screwdriver is required to install screws into the storage shelf rails.

- 1 The storage shelf rails are extended to full length in the shipping container. It is easier to install the rails when they are at their shortest length.
- 2 Use the four adjuster screws on the inside of the rail to increase or decrease the rail length.

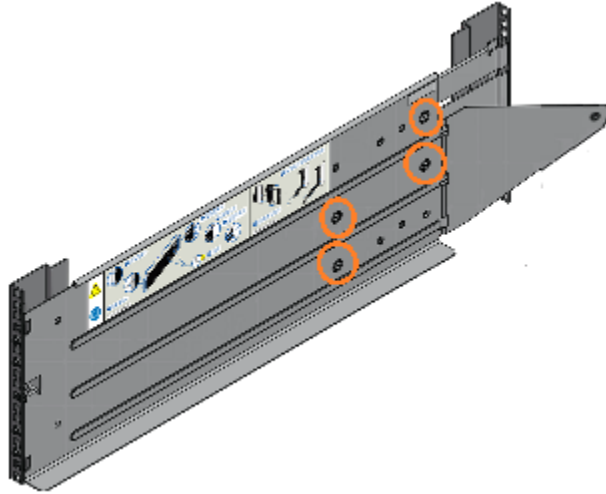

- 3 Identify the left and the right rails which are labeled LH (left-hand) or RH (right-hand) on the front inside of the rail.



Note the ledge at the bottom of each rail. The storage shelf sits on the ledges which must be positioned on the inside of the rack. The ledges must not be located between the rail and the rack wall.

- 4 Locate the pins on the front and the rear of the rails.

- 5 Use the printed rack templates that are provided with the hardware. One side of the template shows the front of the rail. The other side of the template shows the rear of the rail. The template shows the five rack units (RUs) to scale.

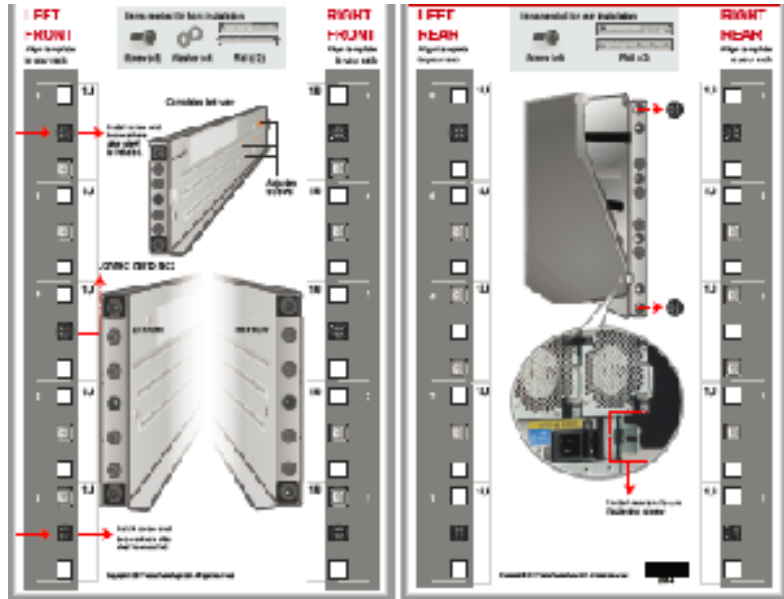

- 6 Start with the left rail. Place the rail pins inside the front of the rack.

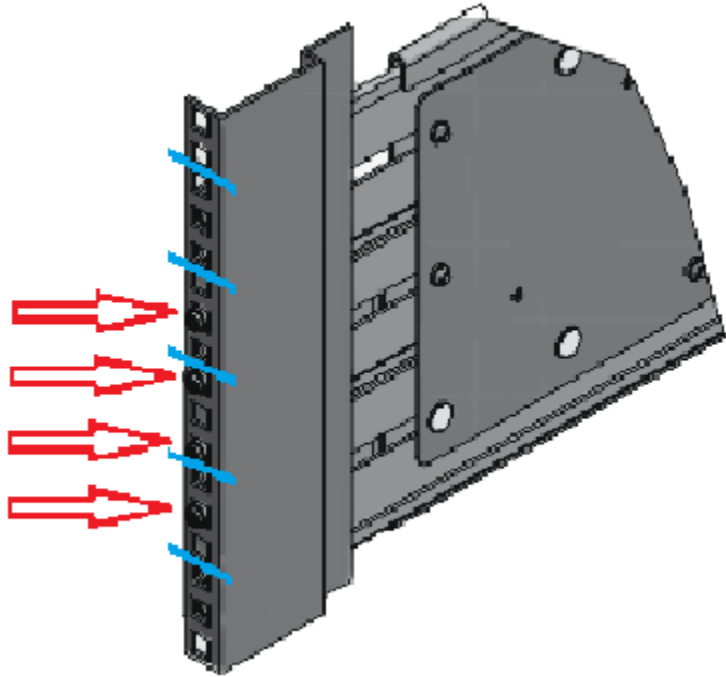

- 7 Extend the rail assembly to enable the rear rail pins to engage.

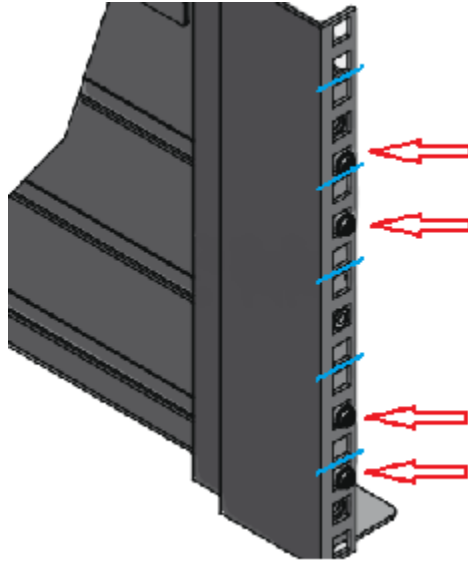

- 8 Verify that the pins are fully seated in the holes in the rack posts.
- 9 Secure the four adjuster screws as needed. Do not over-torque.
- 10 Repeat the process for the right rail.
- 11 Verify that the left rails and the right rails use the same rack holes and are parallel.

12 Identify the three different types of screws.

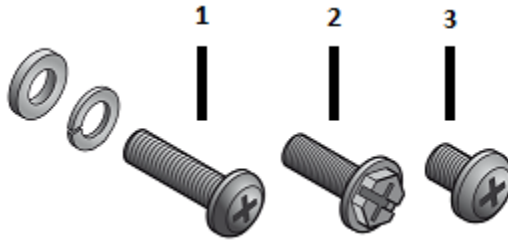

Descriptions of the screws are provided in the following table.

Number	Description	Rack location(s)	Rail location(s)
1	Long fastening screw with two washers - for use after shelf is installed in rails. Install the washer with the gap first.	Front: Center holes in first and fifth rack units (RUs). Rear: N/A	Front: Top and bottom holes. Rear: N/A
2	Medium-sized clamping screw	Front: Center hole of third rack unit (RU). Rear: Center holes in first and fifth rack units (RUs).	Front: Center hole. Rear: Top and bottom holes.
3	Small rear fastening screw	Front: N/A Rear: N/A	Front: N/A Rear: Connects from chassis lock tab to hole in triangular end of rail.

- 13** Install the medium-sized clamping screws from the outside of the rack posts so that they engage the rails and the rack.

The front of the rail requires one clamping screw in the center hole of the center RU.

The rear of the rail requires two clamping screws. Insert these screws in the middle hole in the first and the fifth RU.

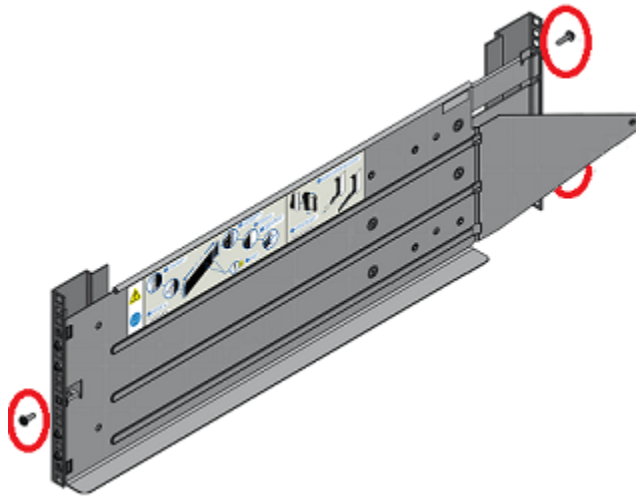

- 14** Remove any plastic film from the front and sides of the shelf.
- 15** Remove the caps from both sides of the front of the storage shelf.



The caps snap off without any tools.

- 16 Warning:** The shelf weighs 61.56kg (135.72lbs) without disk drives. Use a mechanical lift or have at least three people hold the lifting straps. Do not discard the straps in case you need to move the shelf later.

Warning: The back end of the storage shelf is heavier than the front end.

From the front of the rack, carefully lower the storage shelf onto the rail ledges in the rack. You can use the three lifting straps that are shipped with the storage shelf to lift and place the shelf onto the rails.

- 17** Push the shelf into the back of the rack.
- 18** On the front of the rack, use a long screw and two washers in the top and the bottom holes.

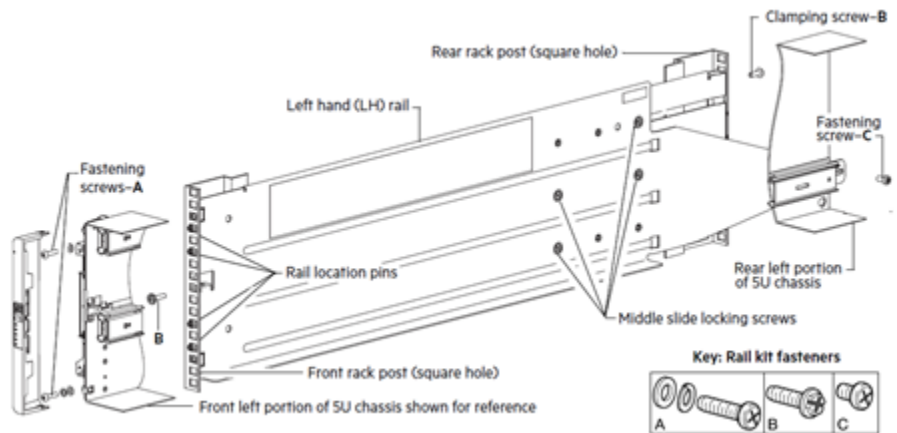

Place the washer with a gap onto the screw first.



- 19 Locate the lock tabs on the left and right rear corners of the storage shelf chassis.



- 20** Insert a small screw through the lock tab into the hole in the triangular end of the rail. Secure the screw.

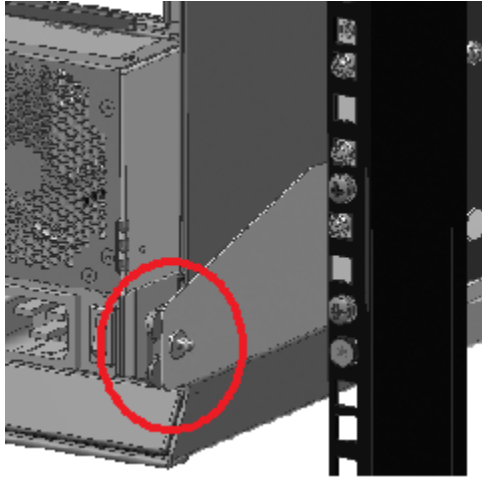

- 21** On the front of the storage shelf reattach the left and the right caps. The left cap contains the control panel. The right cap contains spaces for two latches which connect to the storage shelf.



Installing disk drives into a full-capacity storage shelf

The 5U84 Primary Storage Shelf and the Expansion Storage Shelf use 4-TB or 8-TB disk drives. You cannot mix the two disk storage capacities in one shelf. You can have different capacities in separate shelves.

You can purchase a storage shelf that provides half of the total possible storage capacity.

See [“Installing disk drives and blanks into a half-capacity storage shelf”](#) on page 47.

Note: It is helpful to have two people install the disks. Both people can move the latches to unlock the carriers. One person can remove the disks from the shipping box and hand them to the other person. The first person should orient the disk drives in the direction of installation. The second person installs the disks. Both people can press the carriers down and lock them forward. Less than 5 minutes are required to fill an entire drawer.

To install the disk drives into the storage shelf slots

- 1 Examine the two anti-tamper locks on the front of each drawer.



The red arrows in the locks point to the center of the drawer if the locks are not engaged.

- 2 If the locks are engaged, use a Torx T20 screwdriver to rotate the locks counterclockwise.

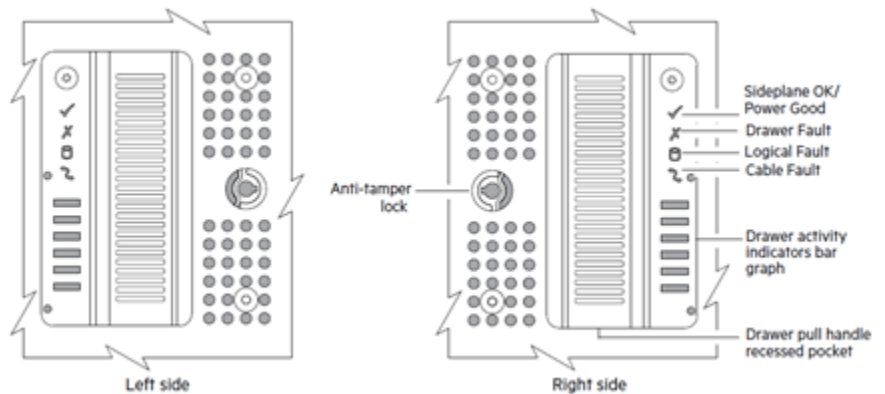

- 3 Pull the bottom drawer forward as far as possible without damaging the hardware. Press the drawer latches (both sides of the drawer) in towards the middle of the drawer in order to open the drawer.
- 4 Locate and open the box or boxes that contain the storage shelf hard disk drives in their Disk Drive In Carrier (DDIC) units.

Note: Each disk drive is preinstalled in a carrier.

- 5** Before removing the disk drives from a shipping box, prepare each disk drive carrier for drawer installation.

Do the following for each carrier:

- Identify the release latch in the middle of the top of a carrier.
- Push the release latch to the right in the direction of the arrow. A yellow line appears to the left of the latch when the carrier is unlocked.

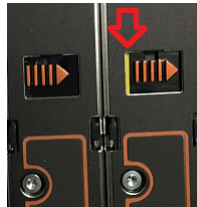

- 6** After unlocking all of the carriers, install each carrier into the bottom drawer.

Do the following for each of the carriers that you want to install:

- Insert the carrier into one slot and push it down until it stops.
- Place one thumb on each of the two pads that are shown by the red arrows.

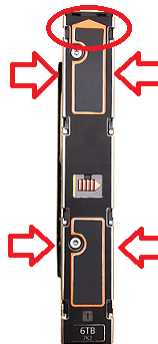

- Push the carrier forward towards the rear of the slot, towards the back of the drawer.

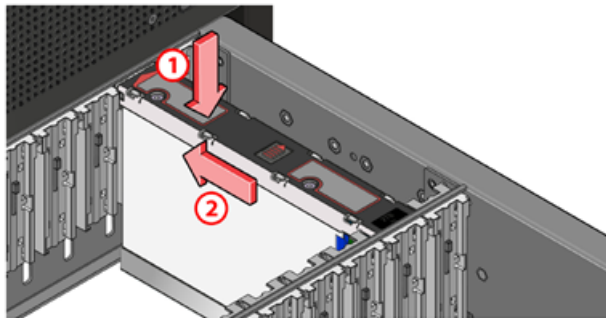

- The release latch clicks into place.
 - Repeat the process for each carrier in the bottom drawer of the shelf.
- 7 Verify that all disks are properly seated in the slots.
 - 8 Slide the bottom drawer into the storage shelf. Press the two drawer release buttons located (one per side) on the side of the drawer to close the drawer until the latches click.
 - 9 Engage the anti-tamper locks on the top drawer as needed.
 - 10 Pull the top drawer forward as far as possible without damaging the hardware.
 - 11 Install the disk drive carriers into the top storage shelf drawer.
 - 12 Slide the top drawer into the shelf by pressing the two drawer release buttons located (one per side) on the side of the drawer to close the drawer until the latches click.
 - 13 Engage the anti-tamper locks as needed.

Installing disk drives and blanks into a half-capacity storage shelf

The Primary Storage Shelf and the Expansion Storage Shelf use 4-TB or 8-TB disk drives. You cannot mix the two disk storage capacities in one shelf. You can have different capacities in separate shelves.

This section provides instructions for installing disk drives into a storage shelf that has one half of the total usable storage capacity. Blank carriers are installed into the slots that are not filled with disks.

Detailed maps of the slots are provided for the blanks and the disks.

Fill the bottom drawer with disks and blanks. Then install disks and blanks into the top drawer.

To install disk drives and blanks into the bottom drawer of the storage shelf

- 1 Examine the two anti-tamper locks on the front of each drawer.



The red arrows in the locks point to the center of the drawer if the locks are not engaged.

- 2 If the locks are engaged, use a Torx T20 screwdriver to rotate the locks counterclockwise.

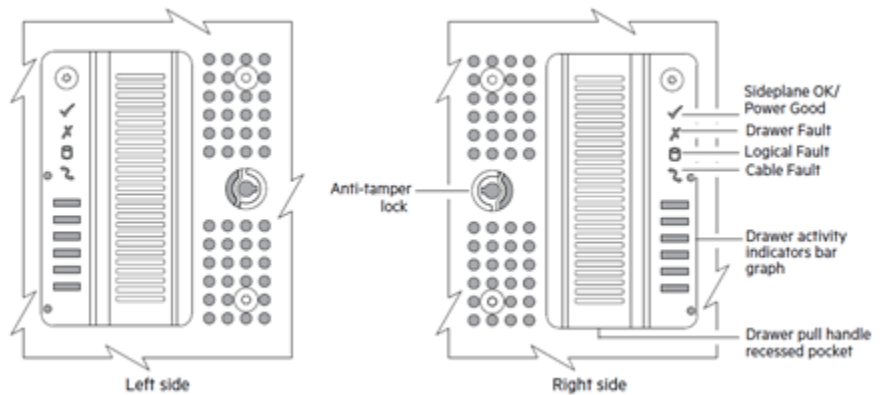

- 3 Pull the bottom drawer forward as far as possible without damaging the hardware. Press the drawer latches (both sides of the drawer) in towards the middle of the drawer in order to open the drawer.

Caution: To provide sufficient airflow for storage shelf cooling, install blank carriers in the empty drive slots of a half-populated drawer.

- 4 Note the numbered slots in each of the three rows. Blank disk carriers are shown in blue. Slots with the carriers that include disk drives are shown in gray.

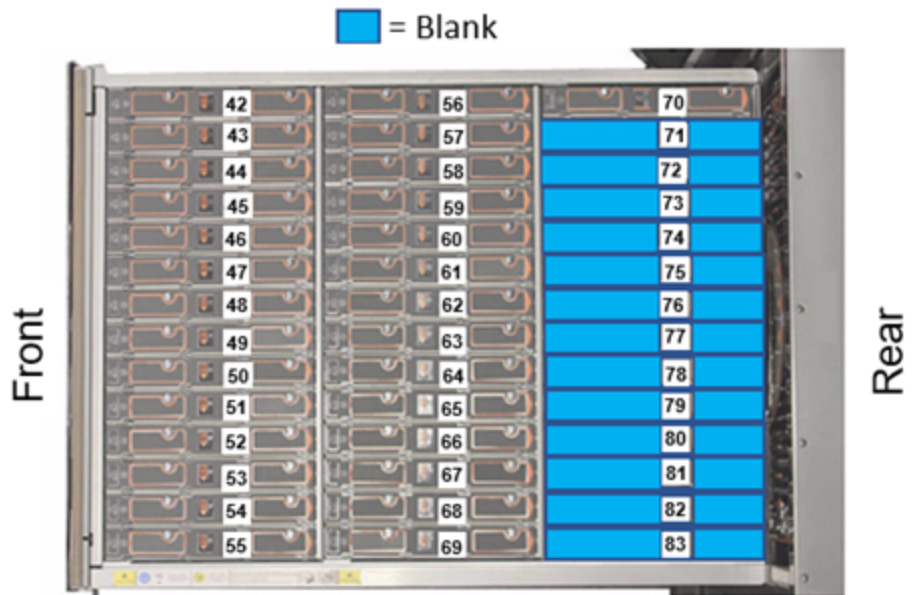

Bottom Drawer (drawer 1)

- 5 Identify the release latch in the middle of the top of a blank carrier.



- 6 Push the release latch to the right. A yellow line appears to the left of the latch when the disk is unlocked.



- 7 Start at the front row of the bottom drawer.
- 8 Locate slot 42 at the front left corner of the drawer.
- 9 Insert one disk drive into slot 42 and into each slot in the first row.
- 10 Insert the carrier into the slot and push it down until it stops.
- 11 Place one thumb on each of the two pads that are shown by the red arrows.

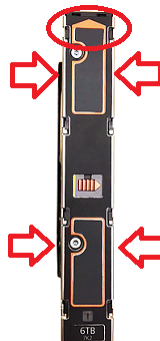

- 12** Push the carrier forward towards the rear of the slot, in the direction of the circled end of the carrier. The latch clicks into place. The yellow line is no longer visible.
- 13** Press all carriers down into the slots and lock them forward.
- 14** Insert one disk drive into slot 56 and into all slots in the second row.
- 15** Press all carriers down into the slots and lock them forward.
- 16** Insert one disk drive into slot 70.
- 17** Insert blank carriers into slots 71 to 83.
- 18** Press all carriers down into the slots and lock them forward.
- 19** Verify that all carriers in the three rows are seated down in the slots. A carrier that is not inserted correctly may hinder securing the drawer.
- 20** If you need to remove a disk drive, slide the release latch to the right. The disk pops up.
- 21** Slide the drawer carefully into the shelf by pressing the two drawer release buttons located (one per side) on the side of the drawer to close the drawer until the latches click.
- 22** Engage the anti-tamper locks as needed.

To install disk drives and blanks into the top drawer of the storage shelf

- 1 Pull the top drawer forward as far as possible without damaging the hardware.
- 2 Install disk drive carriers into slots 0 to 13.

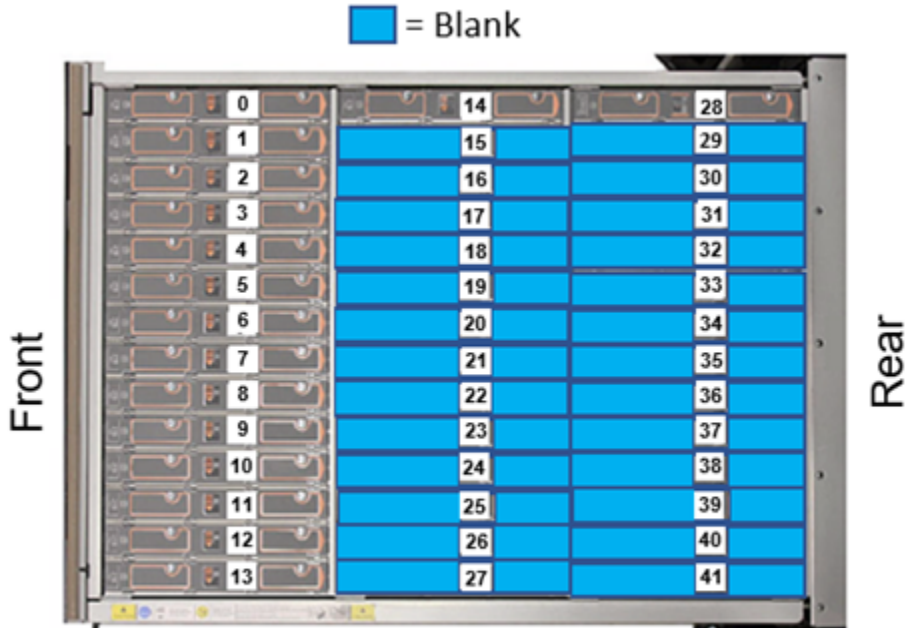

Top Drawer (drawer 0)

- 3 Install disk drive carriers into slots 14 and 28.
- 4 Push the release latch to the right. A yellow line appears to the left of the latch when the disk is unlocked.
- 5 Insert the carrier into one slot and push it down until it stops.

- 6 Place one thumb on each of the two pads that are shown by the red arrows.

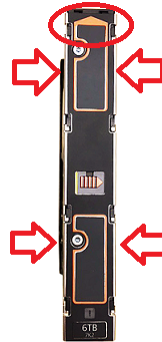

- 7 Push the carrier forward towards the rear of the slot, in the direction of the circled end of the carrier.
The release latch clicks into place.
- 8 Locate slot 15 on the left side of the second row. Slot 15 is to the right of slot 14. Install blanks into slots 15 through 27.
- 9 Locate slot 29, to the right of slot 28.
- 10 Install blanks into slots 29 to 41.
- 11 If you need to remove a blank, slide the release latch to the right. The blank pops up.
- 12 Verify that all slots are filled.
- 13 Push the drawer into the shelf by pressing the two drawer release buttons located (one per side) on the side of the drawer to close the drawer until the latches click.
- 14 Engage the anti-tamper locks as needed.

Installing the compute node rack rails

Veritas recommends the following.

- The compute node requires two RUs of space
- Two people should install the rails; one person at the back of the rack and one at the front.
- Two people should lift and place the compute node into the mounted rails.

To install the compute node rails

- 1 Identify the front and the rear of each rail. The following illustration shows the front of the left-hand and the right-hand rails. The front of the left rail is labeled A. The front of the right rail is labeled B. The labeled sides face the rack wall when the rails are installed.

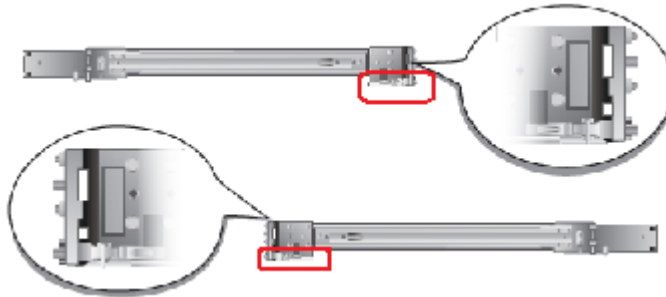

The small metal extensions that are outlined in the illustration must point down, towards the floor of the rack.

Note: The information in this document supersedes any of the information in the printed installation materials.

- 2 Use the printed rack templates to align the rails with the rack holes.
Fold the template along the yellow dotted lines to create an exact, physical match to the rack.



Be sure to use the same holes on each side of the rack.

- 3** Place one rail inside the rack.
 - The rack holes and the rail pins should match the template.
 - Use the same 1RU space and holes in the front and the rear of the rack.
 - Align the pins in the top holes and the bottom holes of the top RU.
 - Move the rail front and back to fit into the rack.
 - Slide the rail forward until the pins click into the rack holes.

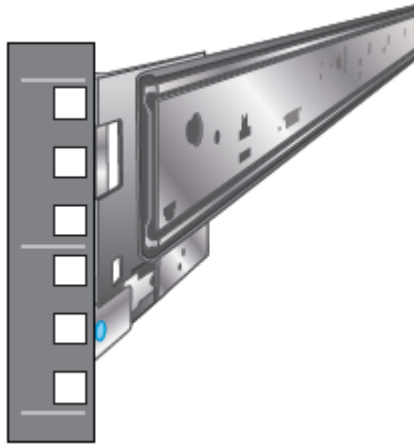

- 4** Secure the rear of the rail.
 - Push the blue lock toward the rack wall and toward the back of the rail.
 - The lock must be behind the rack post.
 - Ensure that the lock clicks into place.

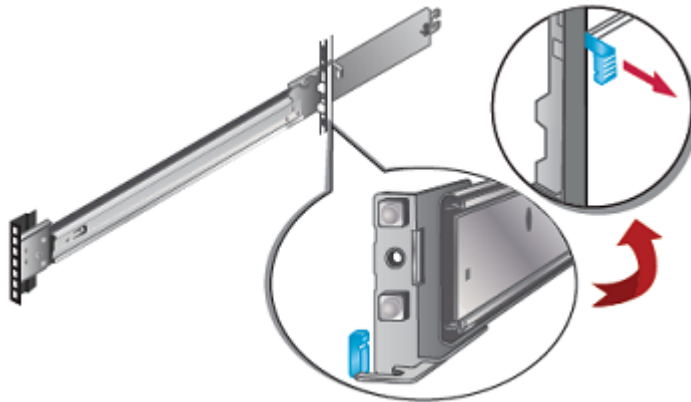

- 5** Insert a washer and a screw into the middle hole of the top RU in the rear of the rack.



- 6** Repeat steps 3 through 5 for the other rail.
- 7** Identify the three different rails in each rail assembly.
- Components in this illustration are as follows.
- 1 - Outer rail
 - 2 - Intermediate rail

- 3 - Inner rail

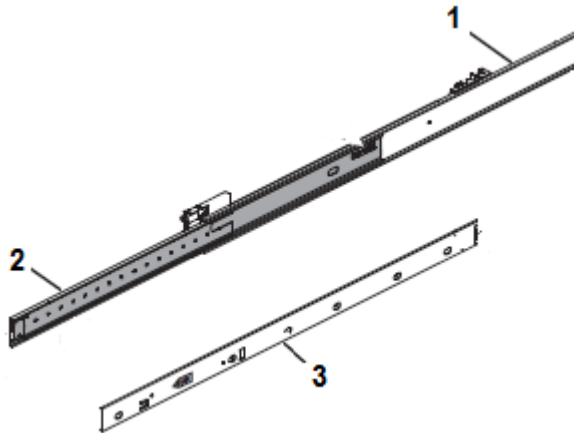

- 8 Pull the white tab forward to release the inner rail from the outer and the intermediate rail.

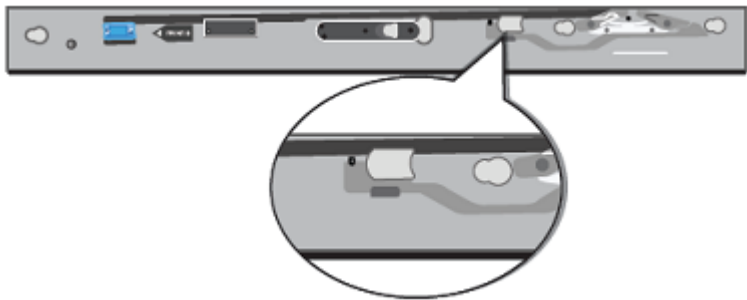

- 9 Separate the inner rail from the other rail components in the rack.
- 10 Attach the inner rail to the left and the right sides of the chassis at the four attachment locations.

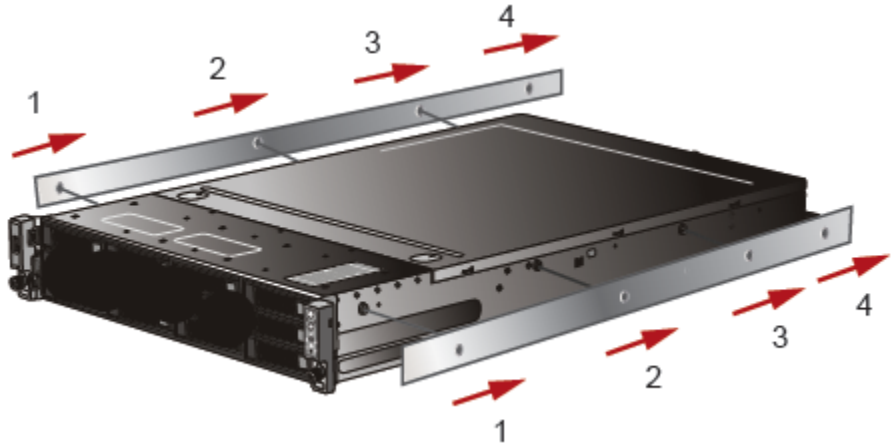

The rails click into place when properly installed.

Installing the compute node into a rack

After the appliance rails have been installed, you can install the appliance into the rack.

After the storage shelves and the compute node rails have been installed, you can install the compute node into the rack. These instructions apply to a one-node system and to a multi-node system.

- 1 Verify that the rails are securely attached.
 - Verify that the outer rail is securely attached to the rack.
 - Verify that the inner rail is securely attached to the compute node.
- 2 Place the hardware in the front of the rack.

- 3 Slide the blue tab forward to unlock the intermediate rail.

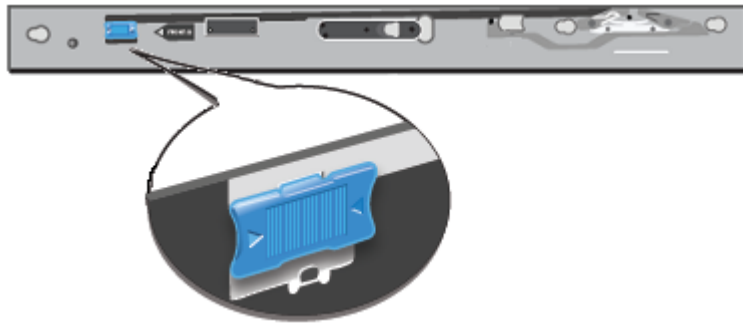

- 4 Pull the intermediate portion of rail the rail forward. Ensure that the ball bearing retainer on the intermediate rail is locked forward.

Note: You do not need to extend the rails as far as they can possibly extend. You only need sufficient space to place the hardware into the rails.



- 5 Align the compute node inner rail to the intermediate rail in the rack. Slide the inner rail that is attached to compute node forward into the intermediate rail until a hard stop is encountered.

The rail has a lock mechanism that prevents the hardware from being fully pushed into the rack.

- 6 Slide the blue tab to unlock the rails and continue the sliding of the compute node into the rack.

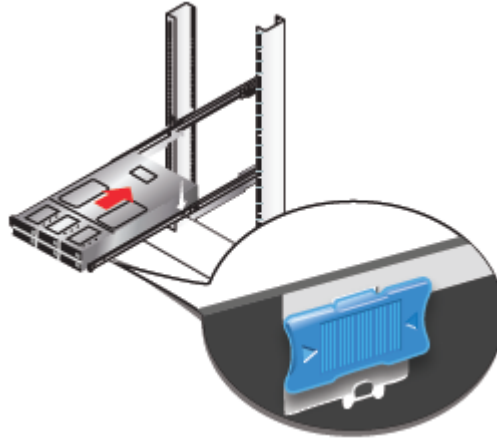

- 7 Secure the captive screws on the compute node ears.

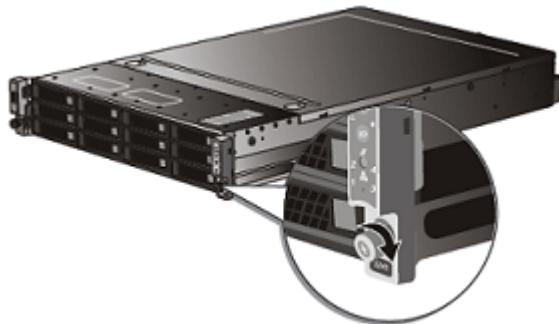

Connecting the hardware to one compute node

This section provides cabling information for a Veritas 5360 Appliance that includes one compute node, one Primary Storage Shelf, and up to three Expansion Storage Shelves.

Each compute node is connected to the Primary Storage Shelf with four SAS-3 cables.

The compute nodes connect to each other with two Ethernet cables.

Expansion Storage Shelves connect to the Primary Shelf and to other Expansion shelves with two SAS-3 cables.

The Primary Shelf has a single SAS-3 port on the left side of each RAID controller I/O module. This port connects to SAS-3 port A in the Expansion I/O modules.

Note: The orientation of the blue tabs on the ends of the SAS-3 cables is important. In the appliance, the blue tabs on each SAS-3 connector must face as shown in the diagram.

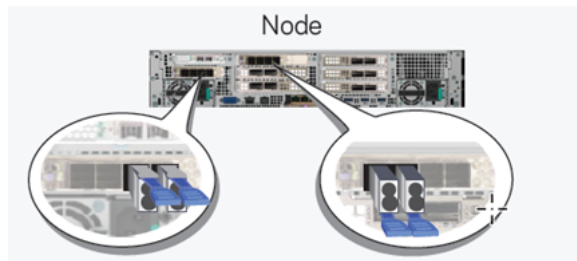

In the storage shelves, the blue tabs in the SAS-3 connectors should point to the 12 Gb/s SAS label near each port.



To connect a compute node to a Primary Shelf

- 1 Obtain four SAS-3 cables for each compute node.
- 2 Identify the SAS-3 ports in slot 3 and slot 7 of the compute node that is closest to the Primary Shelf.



The ports in slot 7 are labeled 3, 2, 1, and 0 from left to right. The ports in slot 3 are labeled 0, 1, 2, and 3 from left to right.

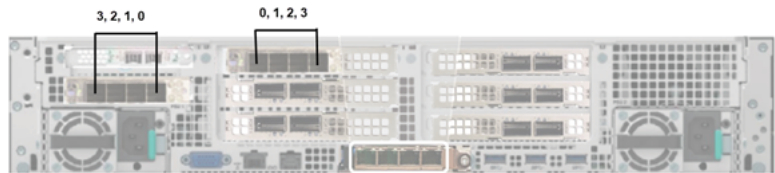

- 3 Identify the four SAS-3 ports in each Primary Shelf controller.

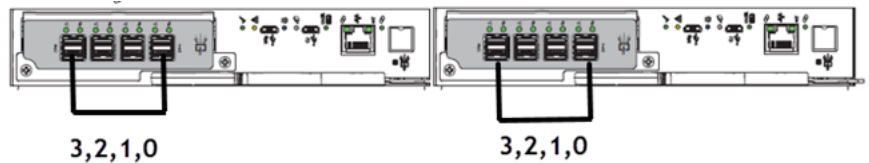

The left-hand controller is labeled A and the right-hand controller is labeled B. The ports in each controller are labeled 3, 2, 1, and 0 from left to right.

Note: The colors of the cables in the following diagrams are for demonstration purposes only.

- 4 Connect the cables as follows:
 - Connect slot 3, Port 0 of the compute node to controller B, Port 1 on the Primary Shelf.

- Connect slot 3, Port 1 of the compute node to controller A, Port 1 on the Primary Shelf.
- Connect slot 7, Port 0 of the compute node to controller B, Port 0 on the Primary Shelf.
- Connect slot 7, Port 1 of the compute node to controller A, Port 0 on the Primary Shelf.

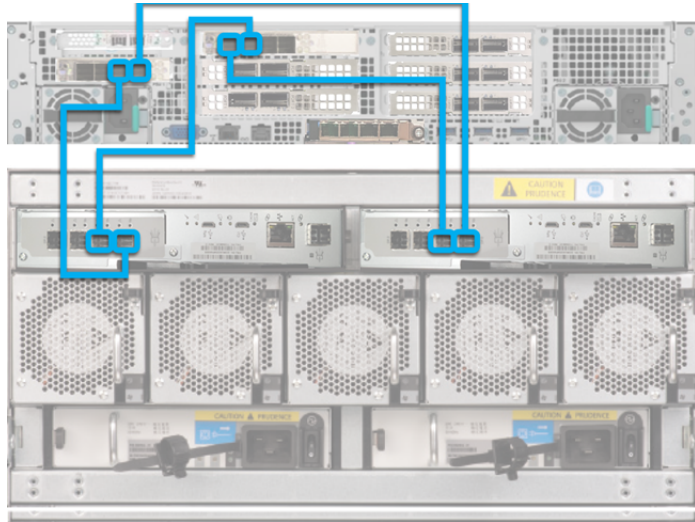

Use the following procedure to connect Expansion Storage Shelves to the Primary Shelf.

If you do not have any Expansion shelves at this time, proceed to the following section to connect power cords to the hardware.

See [“Connecting the power cords”](#) on page 76.

To connect Expansion Storage Shelves to a Primary Shelf

- 1 Do the following if you have one Expansion Shelf.
 - Connect one end of two SAS-3 cables to the SAS-3 port on the left hand side of each RAID controller in the Primary Shelf.
 - Connect the other end of the SAS-3 cables to port A in each of the I/O modules in the Expansion Shelf.

Note: The blue tab on the cable must face down in the Expansion Shelf.

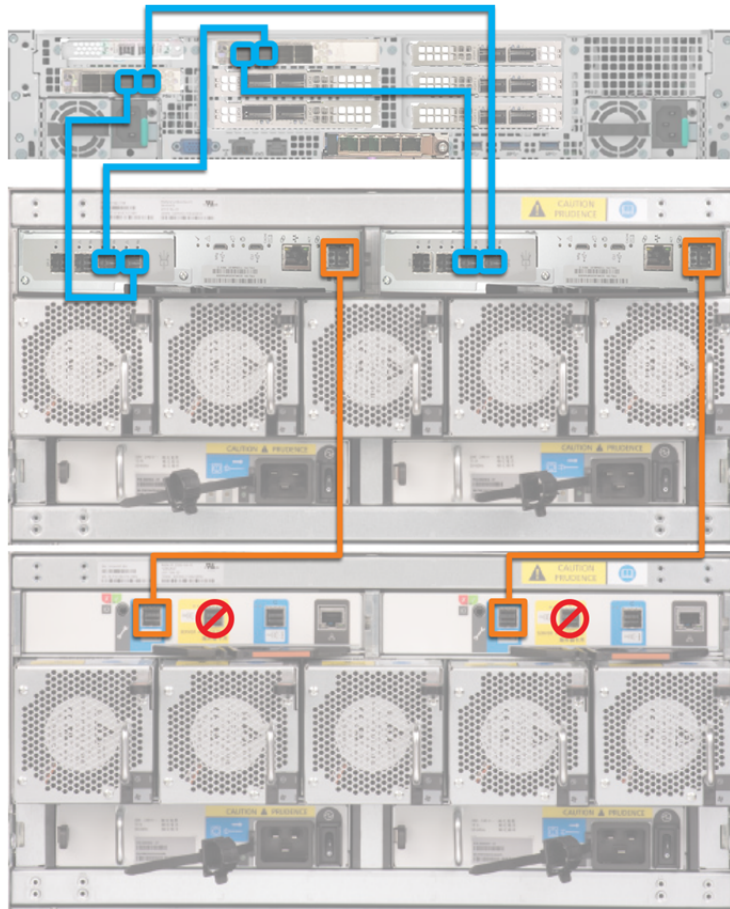

- 2 Do the following if you have two Expansion shelves.
 - Connect one end of the two SAS-3 cables to the SAS-3 port on the left hand side of each RAID controller in the Primary Shelf.
 - Connect the other end of the SAS-3 cable in RAID controller A to port A in the nearest Expansion Shelf I/O module on the left side of the shelf.
 - Connect the other end of the SAS-3 cable in RAID controller B to port A in the right-hand I/O module in the lower Expansion Shelf.
 - Connect port C in I/O module A of the upper Expansion Shelf to port A in I/O module A of the lower Expansion Shelf.
 - Connect port A in I/O module B of the upper Expansion Shelf to port C in I/O module B of the lower Expansion Shelf.

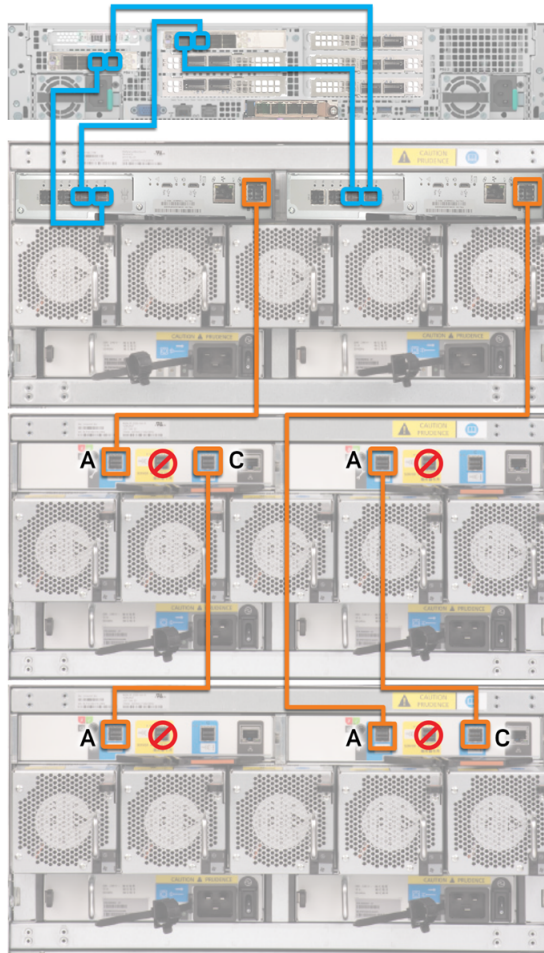

- 3 Do the following if you have three Expansion shelves.
 - Connect one end of the two SAS-3 cables to the SAS-3 port on the left hand side of each RAID controller in the Primary Shelf.
 - Connect the other end of the SAS-3 cable in RAID controller A to port A in the nearest Expansion Shelf I/O module on the left side of the shelf.
 - Connect the other end of the SAS-3 cable in RAID controller B to port A in the right-hand I/O module in the lowest Expansion Shelf.
 - Connect port C in I/O module A of the upper Expansion Shelf to port A in I/O module A of the middle Expansion Shelf.

- Connect port A in I/O module B of the upper Expansion Shelf to port C in I/O module B of the middle Expansion Shelf.
- Connect port C in I/O module A of the middle Expansion Shelf to port A in I/O module A of the lowest Expansion Shelf.
- Connect port A in I/O module B of the middle Expansion Shelf to port C in I/O module B of the lowest Expansion Shelf.

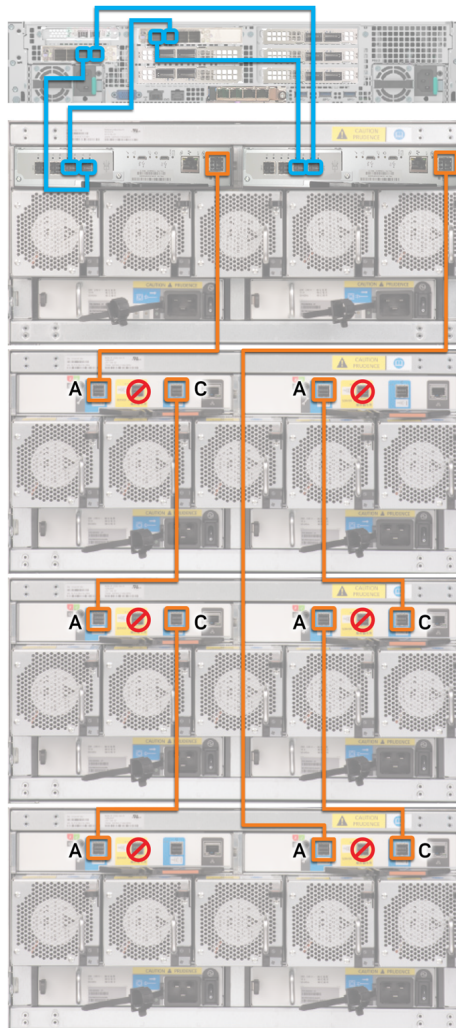

Connecting the hardware to two compute nodes

Installation procedures for a two-node or multi-node system is the same as for a single-node system except for the following:

- The two nodes are connected to each other through the two far-right 1Gb Ethernet ports on the rear of the nodes.
- Both nodes connect to the Primary Storage Shelf.

Note: The colored cables are for demonstration purposes only. There is only one type of SAS-3 cable.

Note: The orientation of the blue tabs on the ends of the SAS-3 cables is important. In the appliance, the blue tabs on each SAS-3 connector must face as shown in the diagram.

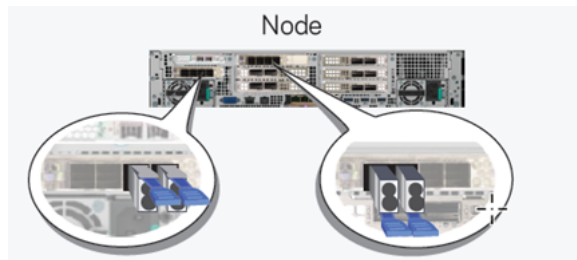

In the storage shelves, the blue tabs in the SAS-3 connectors should point to the 12 Gb/s SAS label near each port.



To connect a two-node appliance

- 1 Identify the two ports on the lower right corner of both nodes.

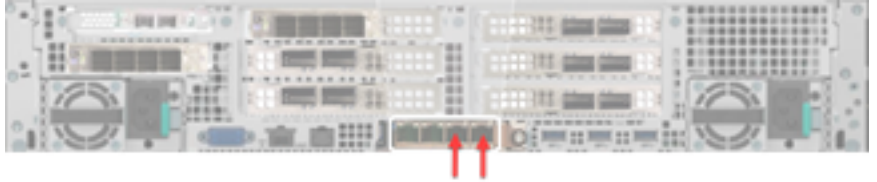

- 2 Connect Ethernet cables between the ports.

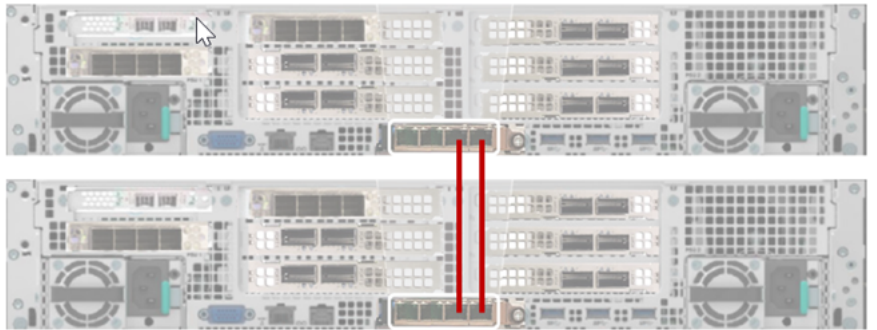

- 3 Identify the SAS ports on the compute nodes.

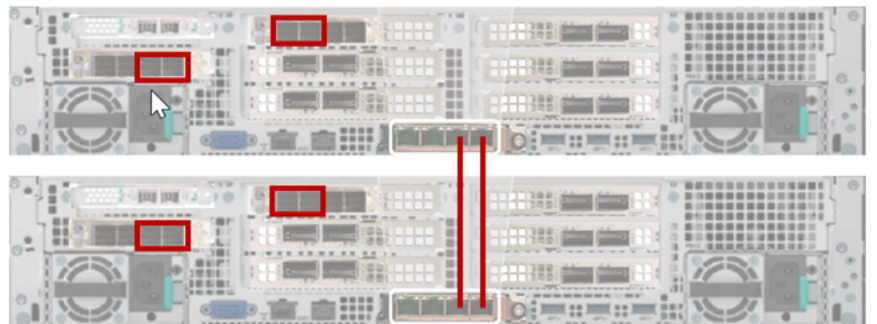

4 Identify the SAS ports on the Primary Storage Shelf.

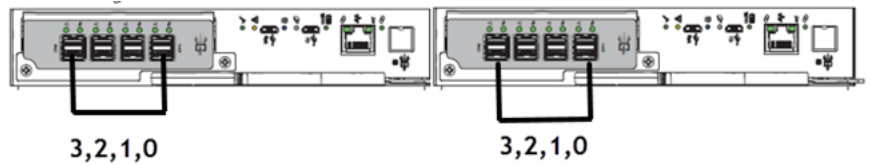

5 Connect the cables as follows:

- On the compute node that is located closest to the Primary Storage Shelf, connect two SAS cables.
- On the compute node that is located closest to the Primary Storage Shelf, connect two more SAS cables.
- On the compute node that is located farthest from the Primary Storage Shelf, connect two SAS cables.
- On the compute node that is located farthest from the Primary Storage Shelf connect two more SAS cables .

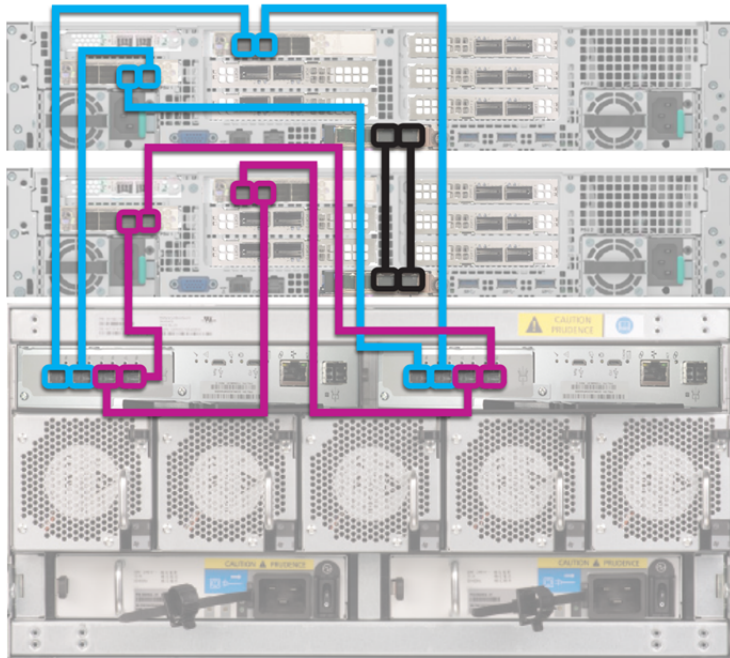

- 6** If you have Expansion Storage Shelves, proceed to the following instructions. See [“To connect Expansion Storage Shelves to a Primary shelf”](#) on page 70. If you do not have Expansion shelves proceed to connect the power cords. See [“Connecting the power cords”](#) on page 76.

To connect Expansion Storage Shelves to a Primary shelf

- 1** Obtain two SAS-3 cables.
- 2** Locate the SAS-3 ports in the left-hand side of each controller in the Primary shelf.



- 3 Locate SAS-3 ports A and C in both I/O modules of the Expansion shelves.



Port B is not used.

- 4 If you have one Expansion shelf, connect it to the Primary shelf .

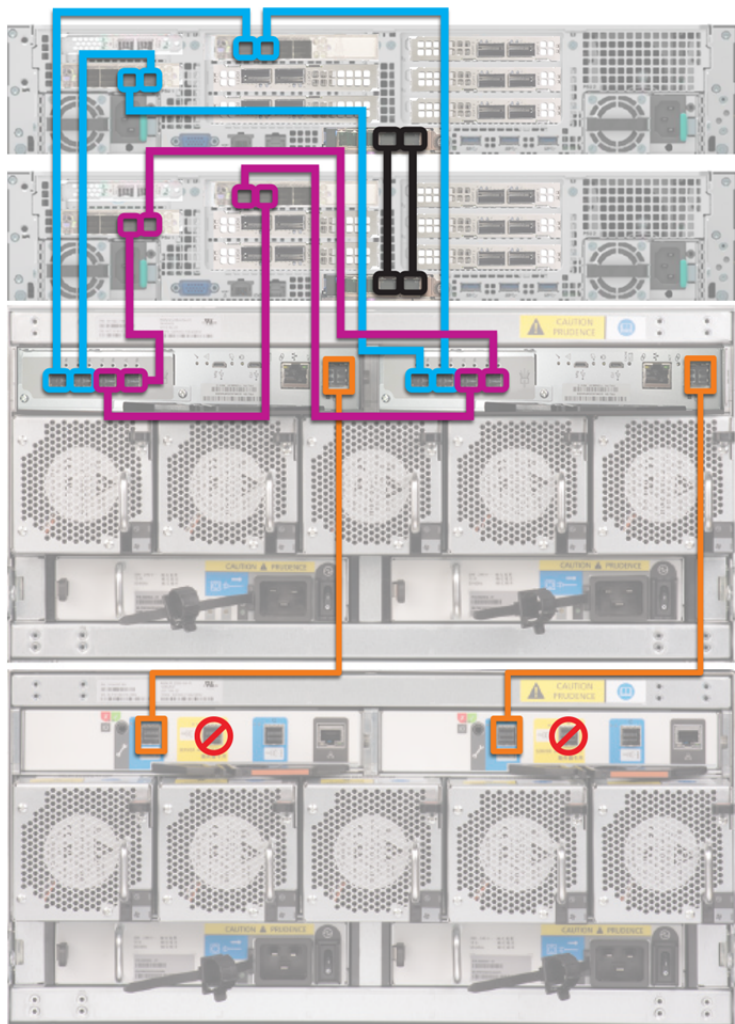

- 5 If you have two Expansion shelves, connect them as shown.

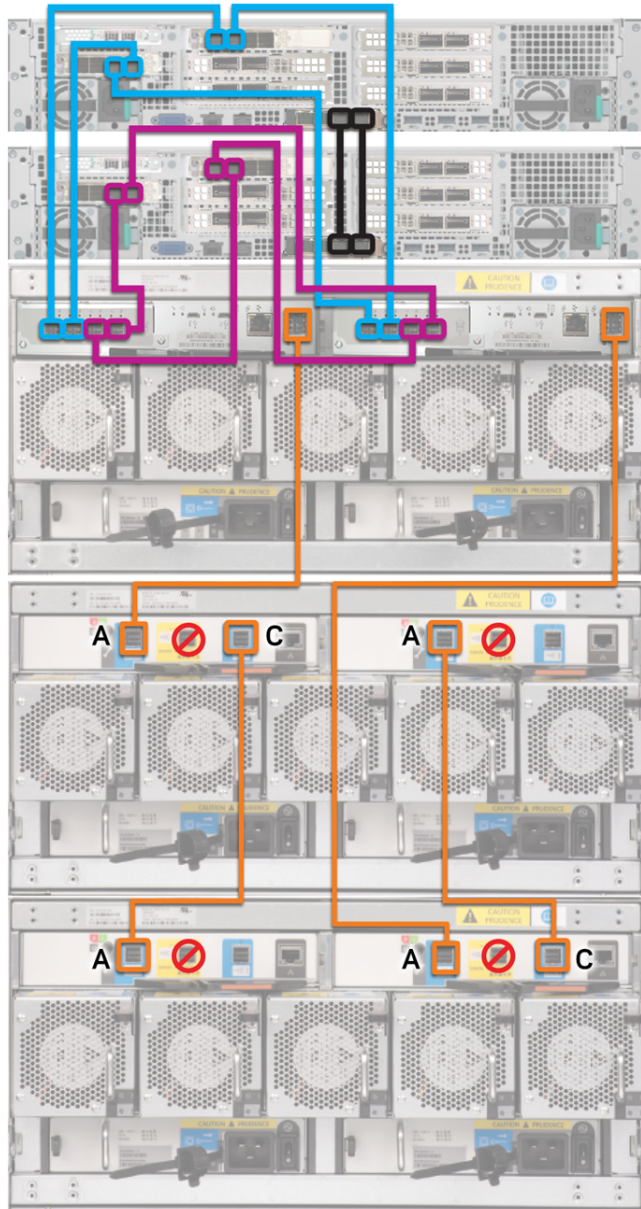

- 6 If you have three Expansion shelves connect them as shown.

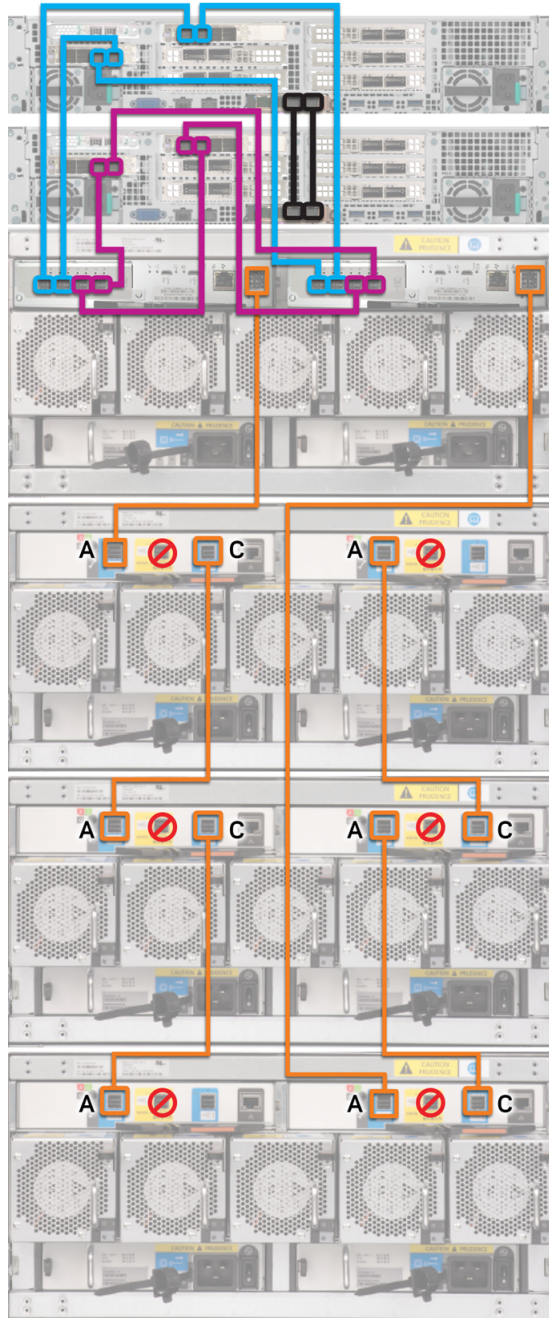

- 7 Proceed to the following section to connect power cords to the hardware.
See [“Connecting the power cords”](#) on page 76.

Connecting Flex nodes to the network

Network ports on the rear panel of the compute node are shown in the following diagram.



The following table provides information about connecting the network ports on both Flex nodes.

Port	Function
host1 (mgmt0 bond) - copper/RJ45 connector	Best practices recommend that you use this port and the host0 port to access the Flex Appliance Console to perform the initial configuration. Labeled ETH0 on the node.
host0 (mgmt0 bond) - copper/RJ45 connector	Best practices recommend that you use this port and the host1 port to access the Flex Appliance Console to perform the initial configuration. Labeled ETH1 on the node.
privnic1 (eth2/NIC3) - copper/RJ45 connector	You must use this port <i>and</i> the privnic0 port to connect the nodes to each other. Labeled ETH2 on the node.
privnic0 (eth3/NIC4) - copper/RJ45 connector	You must use this port <i>and</i> the privnic1 port to connect the nodes to each other. Labeled ETH3 on the node.
IPMI port - copper/RJ45 connector	A 1-GbE port that is used to connect to the Veritas Remote Management Interface.

The 25-10GbE ports come populated with the 10GbE optical modules. For more details, see the *Veritas 5360 Appliance I/O configuration options* section in the *Veritas 5360 Appliance Product Description Guide* on SORT.

Connecting the power cords

Connect all of the storage shelves and the compute node to the Power Distribution Unit in the rack. Typically a rack has one PDU on each side at the rear of the hardware. Two PDU strips provide redundant power.

To connect the power cords

- 1 Obtain two power cords for each unit.
- 2 Note that the storage shelf cords have a right-angled connector on the end that connects to the shelf.



- 3 Connect the right-angled ends to the Expansion shelf. Connect the strain relief bale to each power cord.



- 4 Connect two power cords between the Expansion shelf and the PDU.

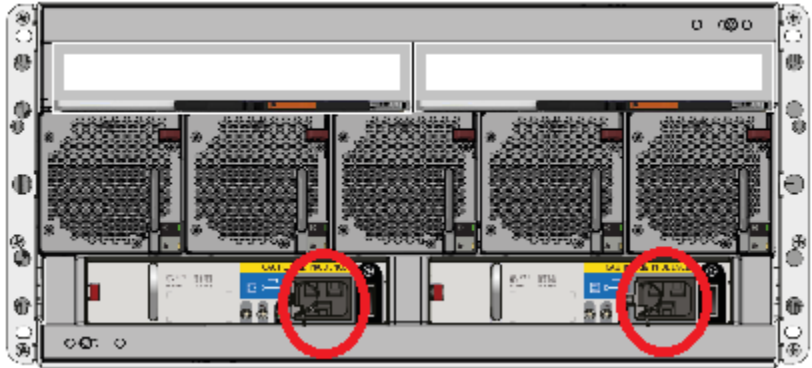

- 5 Rewrap the plastic ties to secure each power cord.
- 6 Connect two power cords between the Primary shelf and the PDU.

- 7 Connect two power cords between the compute node and the PDU.



- 8 Verify that the final power cord cabling is consistent with the following diagram.

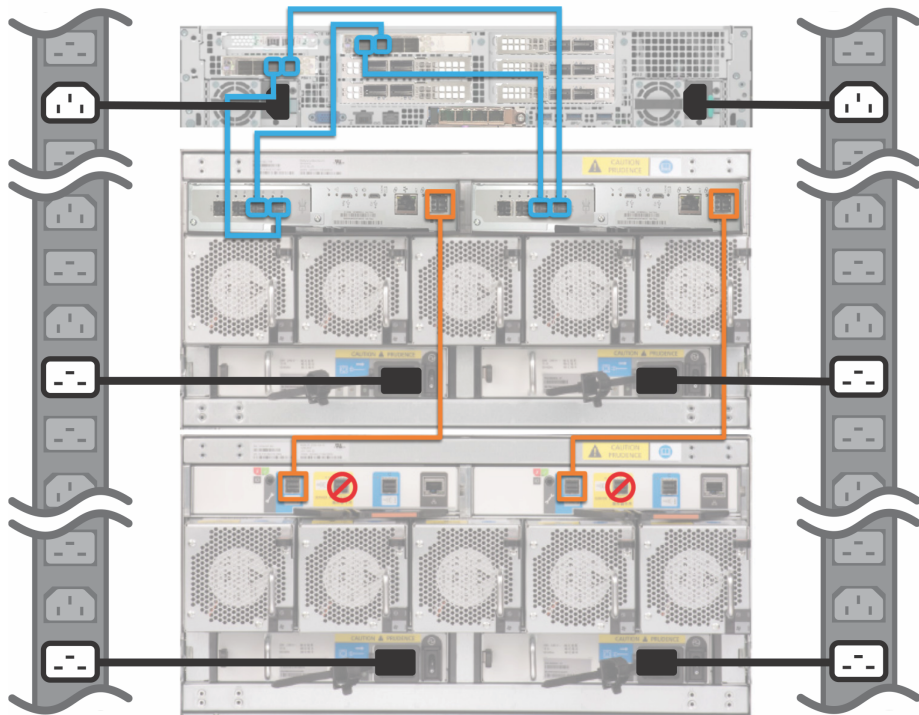

Turning on the hardware and verifying operation

You must turn on the hardware in the following order:

- Expansion shelf
- Primary shelf
- Compute node or nodes

To turn on the hardware

- 1 Verify that the following cables are connected properly and securely:
 - SAS cables between the Primary Shelf and the Expansion Shelf
 - SAS-3 cables between the compute nodes and the Primary Shelf
 - Power cords from each component to the appropriate Power Distribution Unit (PDU) sockets in the rack.
- 2 On the rear panel of the Expansion shelf turn on both power supplies.

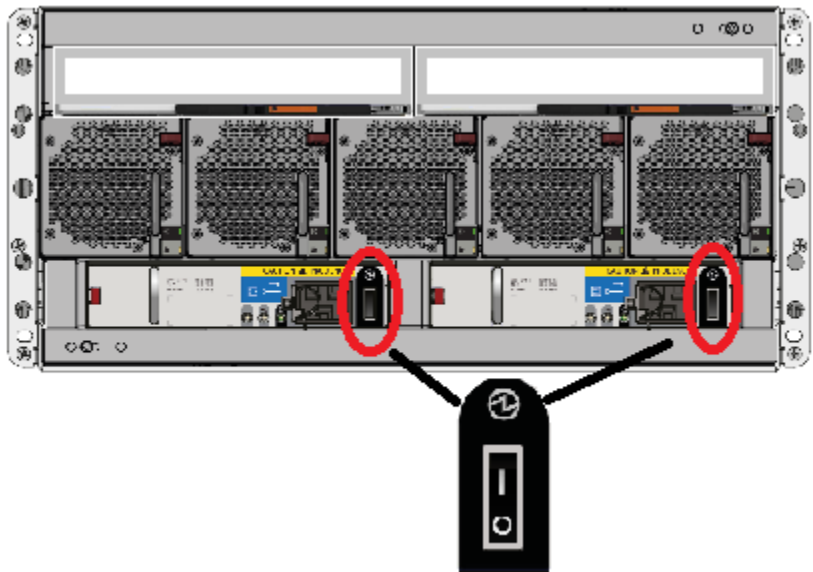

- 3 Wait 2 or 3 minutes for the shelf to initialize. The shelf is more quiet when it has initialized.

- 4 Verify that the Power OK LEDs on both power supplies are green.

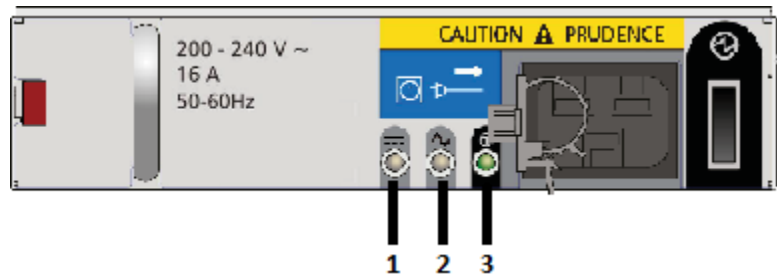

Number	Description
1	Power supply failure
2	AC failure
3	Power ok

- 5 Verify that the Power on (standby) LED on the front, left, of the shelf is green.

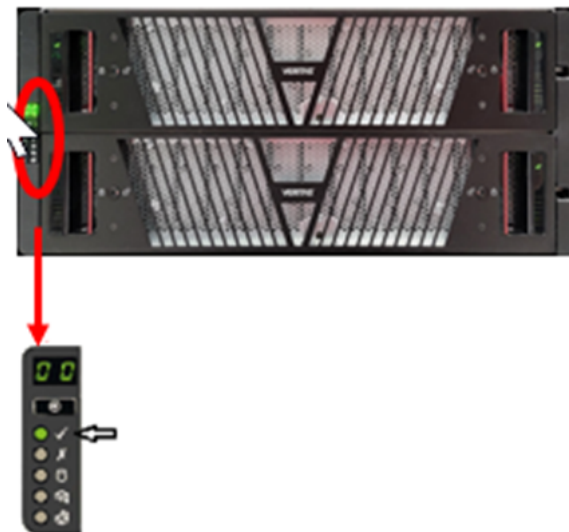

- 6 Turn on the Primary Storage Shelf.
- Let the shelf initialize for 2 or 3 minutes.
 - Verify that the Power OK LEDs on the power supply modules are green.

- Verify that the Power On LED on the control panel on the front of the shelf is green.

Configuring the Veritas Remote Management Interface from a Flex Appliance

Veritas Flex Appliance release does not support configuring the IPMI port through the Flex Appliance Shell.

To configure the dedicated Veritas Remote Management Interface (IPMI) LAN settings in the BIOS

- 1 Connect a standard video cable between the VGA (Video Graphics Array) port and the computer monitor
- 2 Connect a keyboard to a USB port at the rear of the Flex 5360 appliance.
- 3 Ensure that the power cords are connected.
- 4 Turn on the compute node or nodes with the power button on the control panel on the right front side of the unit or units.

High availability (HA) appliance compute node and storage shelf service considerations

Attention: When you turn on the storage shelves and compute nodes after completing the service, turn on the primary compute node first before you turn on the secondary compute node.

Important: Check to determine which compute node is configured as the primary compute node, and which is configured as the secondary compute node. Do this before turning on the compute nodes and storage shelves.



- 5 Verify that the LED under the button is green.

- 6 The prompt about accessing the BIOS at the beginning of the startup cycle appears. Wait until the Veritas logo shows up and press **F2** to enter the initial BIOS setup screen. The initial setup dialog box appears and prompts you.



Warning: When you are in the BIOS, do not perform any other steps other than the ones mentioned in this section.

Note: If you miss the initial setup dialog box prompt in step 6, the appliance shell appears. Shut down and restart the appliance and try accessing the BIOS menu again.

The **Setup Menu** page appears and the **Main** menu option should be highlighted.

Configuring the Veritas Remote Management Interface from a Flex Appliance

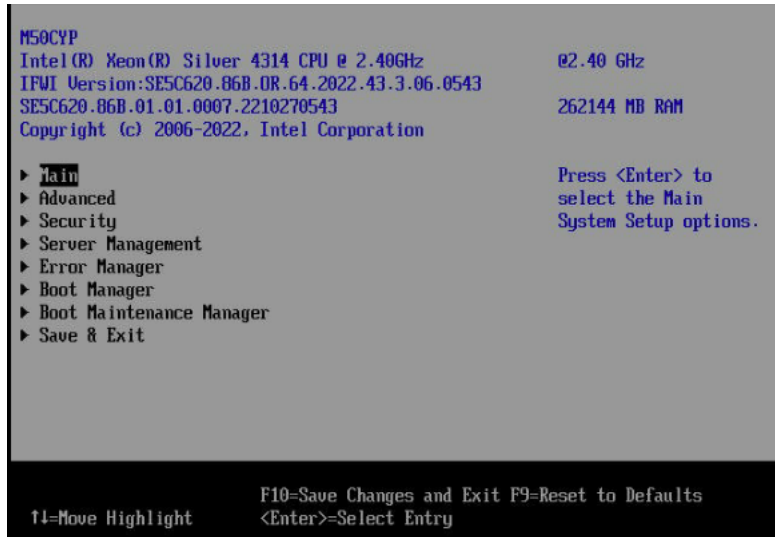

- 7 Use the down key on the keyboard and navigate to the **Server Management** menu option. Press **Enter**.
- 8 Press the up or down key on the keyboard to navigate to **BMC LAN Configuration**. Press **Enter**.

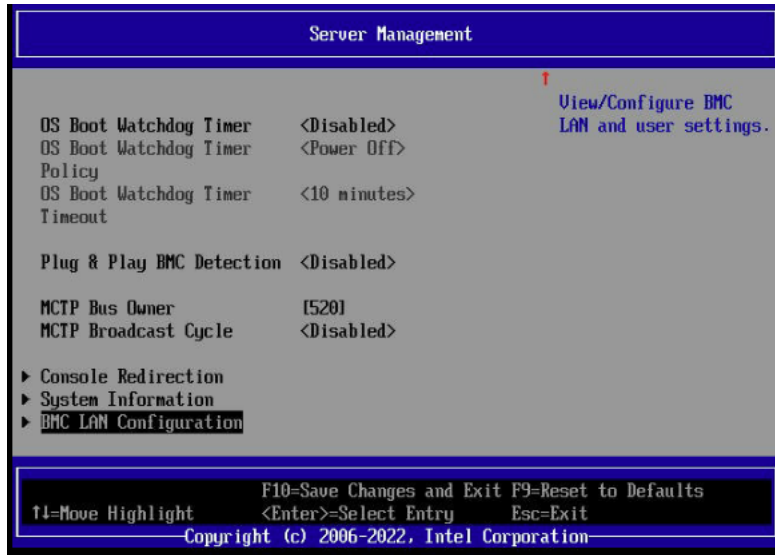

- 9 The **BMC LAN Configuration** options screen appears.

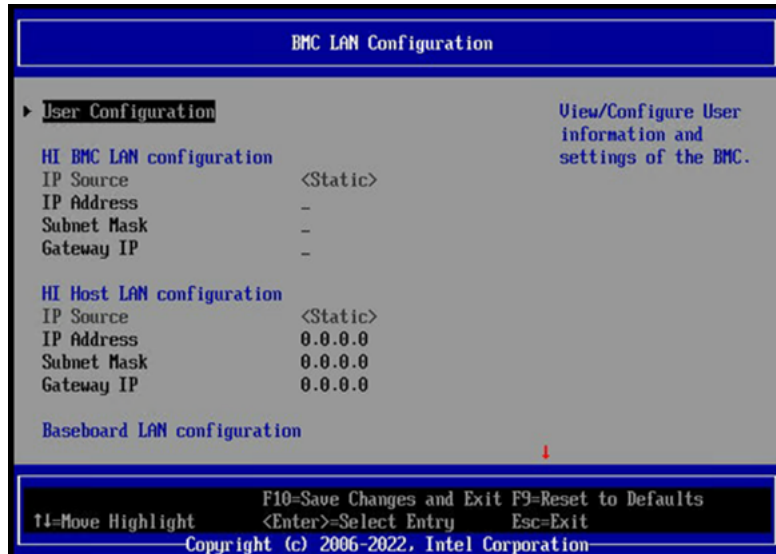

- 10 Press the down arrow key on the keyboard to navigate to the **Dedicated Management LAN Configuration** option. Use the information supplied by the customer to fill in the following fields: IP Source, IP address, Subnet mask, Gateway IP.

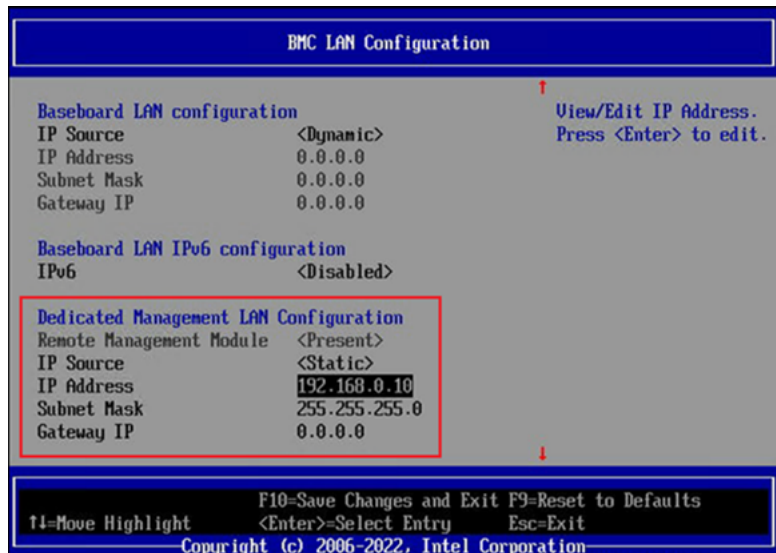

- 11 To save your BIOS changes, press **F10**.

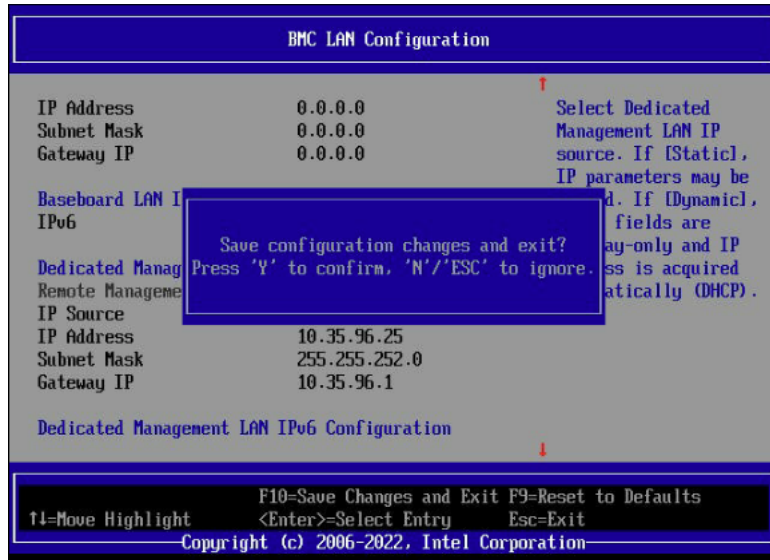

- 12 Press **Y** to save and exit. The appliance restarts itself.

Accessing and using the Veritas Remote Management interface

The IPMI web interface is known as Veritas Remote Management interface. You can use Veritas Remote Management interface to log on to the Flex Appliance Shell.

Before you use the Remote Management interface, the following prerequisites must be met:

- The Remote Management interface (IPMI port) must first be configured.
- At least one power cable must be connected to a functioning power source.
- At least one user must be enabled to use the LAN channel(s).

To access and use the IPMI web interface from a remote computer

- 1 Log on to a remote computer in the network and open a supported Windows browser.
- 2 Enter the remote management port IP address that is assigned to the remote management port. The following page appears:



- 3 Enter your login information. The default user name is **sysadmin**. The default password is **P@ssw0rd**, where **0** is the number zero.

Click **Login**.

- 4 Click the **Remote Control** section located at the top of the page. The **Remote Control** section lets you remotely monitor and control the server.

Do **one** of the following to launch the Appliance Shell:

- Navigate to **Remote Control > iKVM over HTML5**.

Click **Launch iKVM over HTML5** to launch the Appliance shell. A new window opens that enables you to remotely monitor and control the appliance.

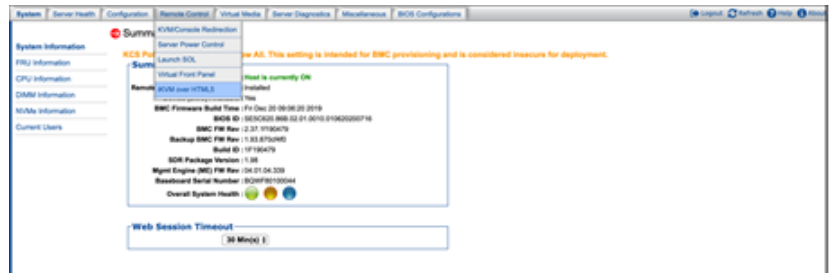

- Click **Remote Control > KVM/Console Redirection**. Click **Launch Console** to launch the appliance shell menu.



A JViewer application opens that enables you to remotely monitor and control the appliance. This application requires Java Runtime Environment (JRE) version 6.0 or later. Install Java. You can login to the JViewer application using the same user name and password from step 3

Caution: Starting with Java 7 update 45, you may receive a security warning when you launch the KVM remote console from the appliance IPMI port. The warning states that you do not have proper permissions and prevents appliance access from the IPMI port. For information about how to resolve this issue, refer to the following document:

https://www.veritas.com/support/en_US/article.100011121.html

5 You can now access and log on to the Flex Appliance Shell.

Enter the user name and password for the appliance.

By default, the user name `hostadmin` has the password, `P@ssw0rd` where 0 is the number zero.

Type "?" and then enter the "system" command to actually see the list of available commands.

Adding Expansion Storage Shelves to an operating appliance that does not have any Expansion shelves

This appendix includes the following topics:

- [Overview](#)
- [Turning off the existing hardware](#)
- [Installation instructions](#)
- [Connecting one Expansion Shelf to the Primary Shelf](#)
- [Connecting two Expansion Shelves to the Primary Shelf](#)
- [Connecting three Expansion Shelves to the Primary Shelf](#)

Overview

This appendix applies to an operating appliance that has one or two compute nodes and a Primary Storage Shelf. It is possible to already have one or more Expansion Storage Shelves, up to three units.

The hardware must be turned off before you add any storage shelves.

Turning off the existing hardware

You must turn off the existing system before you turn on any Expansion Shelves. Be sure to perform these steps in the order that they are presented.

To turn off the existing hardware

- 1 Perform a soft shutdown of any compute nodes.

If you have two compute nodes you must shut them down separately.

- From the Flex Appliance Shell, enter `system shutdown`.
- Verify that the compute node is completely turned off. All LEDs are off. Fans are not running.
- Repeat these steps for the second compute node if applicable.

- 2 After the compute nodes are turned off you must manually turn off the Primary Shelf.

- Locate the on/off switches on the two power supplies on the rear of the Primary Shelf.
- Press the switches to off.

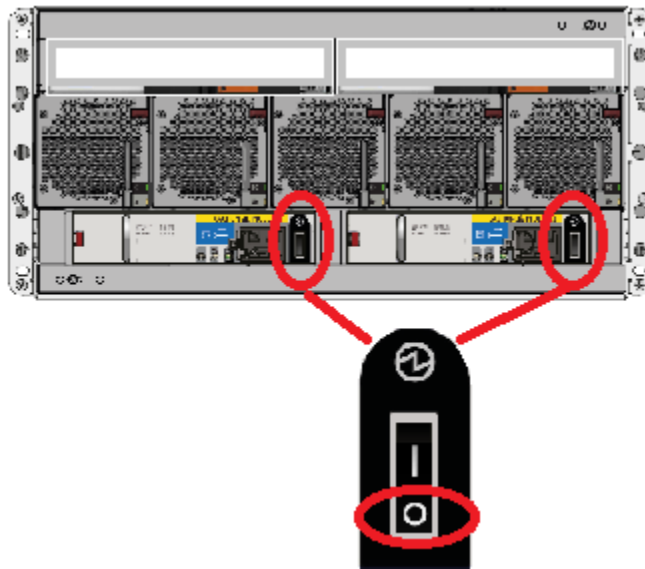

Installation instructions

The procedures for installing an Expansion shelf and inserting the disk drive carriers are the same as for a Primary shelf.

Refer to the following sections for details.

See [“Dimensions and determining rack locations”](#) on page 27.

See [“Installing a storage shelf”](#) on page 34.

See [“Installing disk drives and blanks into a half-capacity storage shelf”](#) on page 47.

See [“Installing disk drives into a full-capacity storage shelf”](#) on page 44.

Connecting one Expansion Shelf to the Primary Shelf

The Expansion Shelf connects to the Primary Shelf but it does not connect directly to the compute node.

Note: The orientation of the blue tabs on the ends of the SAS-3 cables is important. In the appliance, the blue tabs on each SAS-3 connector must face as shown in the diagram.

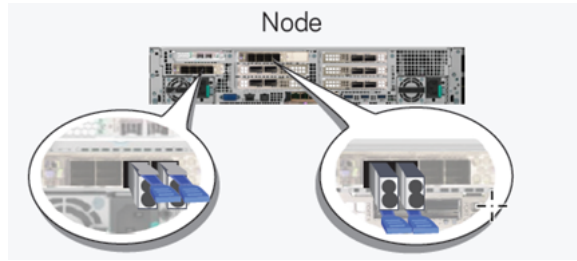

In the storage shelves, the blue tabs in the SAS-3 connectors should point to the 12 Gb/s SAS label near each port.



To connect one Expansion Shelf to the Primary Shelf

- 1 Verify that all compute nodes and the Primary Shelf are off and that the power cords are unplugged.
Do not remove the cables between the compute nodes and the Primary Shelf.
- 2 Obtain the two SAS-3 cables that ship with the Expansion Shelf.

- 3 Identify the single SAS-3 port on the right side of each controller module in the Primary Shelf.



- 4 Identify ports A and C in each I/O module in the Expansion Shelf. Port B is not available for use.

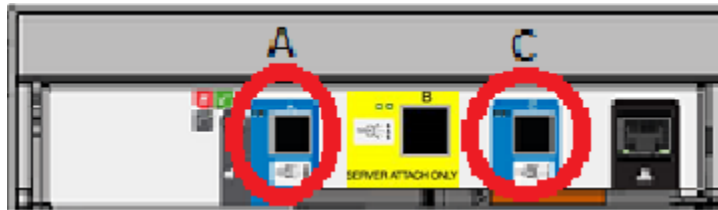

- 5 Connect the cables as follows:
 - Connect one cable to each of the SAS-3 ports on the right of each controller module on the Primary Shelf.
 - Connect the other end of each cable to port A in each I/O module in the Expansion Shelf.

- 6 Verify the final cable configuration.

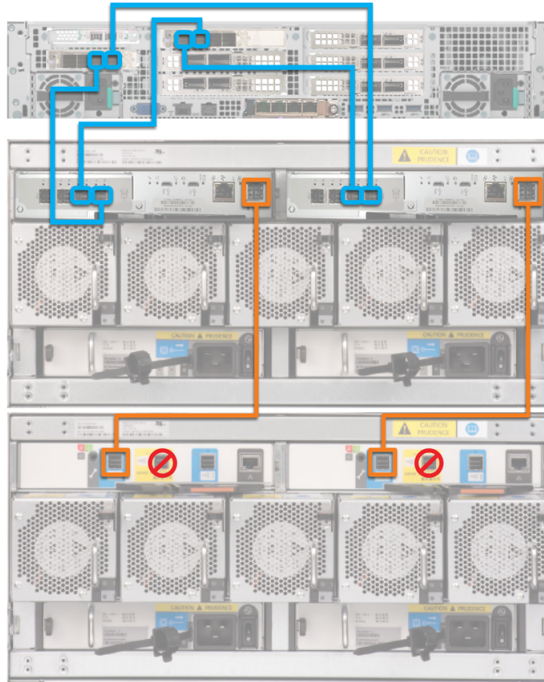

- 7 Connect the power cords of all devices as described in this section.
See [“Connecting the power cords”](#) on page 76.
- 8 Turn on the devices in the proper sequence as described in this section.
See [“Turning on the hardware and verifying operation”](#) on page 78.
- 9 Add the new disk space with the instructions in one of these sections.
See [“Adding the disk space of an Expansion Storage Shelf from the Flex Appliance Console”](#) on page 116.

Connecting two Expansion Shelves to the Primary Shelf

Both Expansion Shelves connect to the Primary Shelf but not directly to the compute node.

Note: The orientation of the blue tabs on the ends of the SAS-3 cables is important. In the appliance, the blue tabs on each SAS-3 connector must face as shown in the diagram.

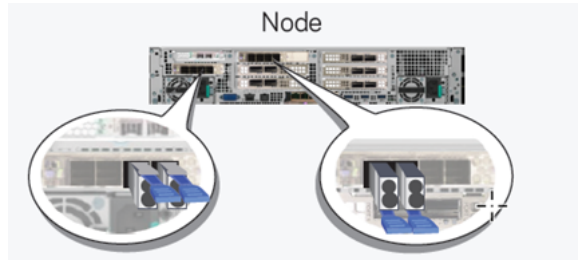

In the storage shelves, the blue tabs in the SAS-3 connectors should point to the 12 Gb/s SAS label near each port.



To connect two Expansion Shelves to the Primary Shelf

- 1 Verify that all compute nodes and the Primary Shelf are off and that the power cords are unplugged.
Do not remove the cables between the compute nodes and the Primary Shelf.
- 2 Obtain the two SAS-3 cables that ship with each Expansion Shelf.

- 3 Identify the single SAS-3 port on the right side of each controller module in the Primary Shelf.



- 4 Identify ports A and C in each I/O module in the Expansion Shelf. Port B is not available for use.

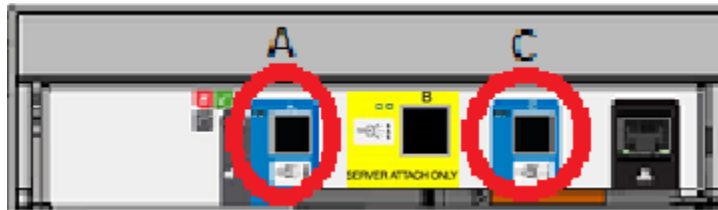

- 5 Connect the cables as follows:
- Connect one cable to each of the SAS-3 ports on the right of each controller module on the Primary Shelf.
 - Connect the left cable to port A in the left I/O module on the closest Expansion Shelf.
 - Connect the right cable from the Primary Shelf to port A in the right I/O module in the farthest Expansion Shelf.
 - Connect one end of a new cable to port C in the left module of the first Expansion Shelf.
 - Connect the other end of the cable to port A in the left module of the second Expansion Shelf.
 - Connect one end of the final cable to port A on the right I/O module of the first Expansion Shelf.
 - Connect the other end of that cable to port C in the right I/O module of the second Expansion Shelf.

- 6 Verify the final cable configuration.

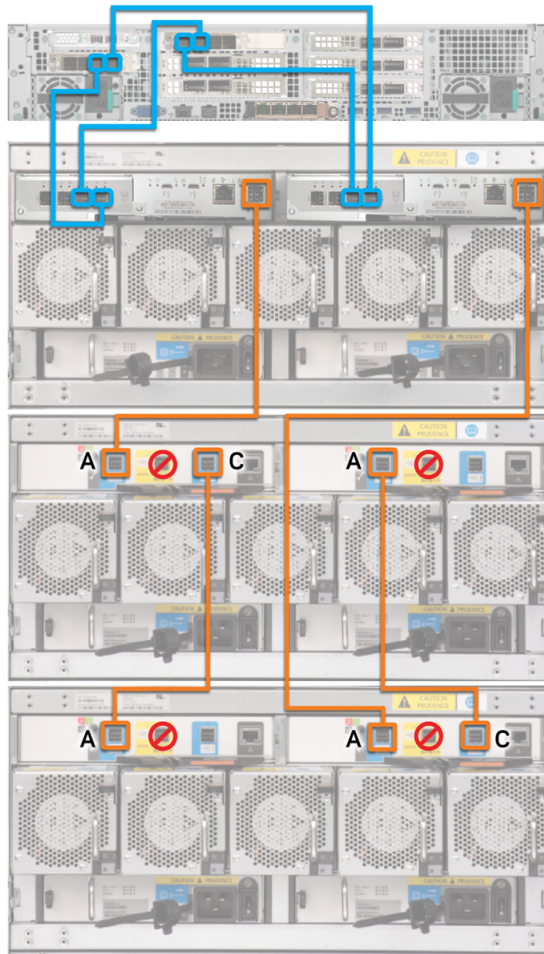

- 7 Connect the power cords of all devices as described in this section.
See [“Connecting the power cords”](#) on page 76.
- 8 Turn on the devices in the proper sequence as described in this section.
See [“Turning on the hardware and verifying operation”](#) on page 78.
- 9 Add the new disk space with the instructions in one of these sections.
See [“Adding the disk space of an Expansion Storage Shelf from the Flex Appliance Console”](#) on page 116.

Connecting three Expansion Shelves to the Primary Shelf

Two of the three Expansion Shelves connect to the Primary Shelf but not directly to the compute node.

Note: The orientation of the blue tabs on the ends of the SAS-3 cables is important. In the appliance, the blue tabs on each SAS-3 connector must face as shown in the diagram.

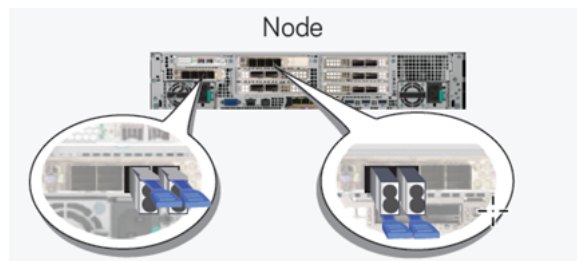

In the storage shelves, the blue tabs in the SAS-3 connectors should point to the 12 Gb/s SAS label near each port.



To connect three Expansion Shelves

- 1 Verify that all compute nodes and the Primary Shelf are off and that the power cords are unplugged.

Do not remove the cables between the compute nodes and the Primary Shelf.

- 2 Obtain the two SAS-3 cables that ship with each Expansion Shelf.

- 3 Identify the single SAS-3 port on the right side of each controller module in the Primary Shelf.



- 4 Identify ports A and C in each I/O module in the Expansion Shelf. Port B is not available for use.

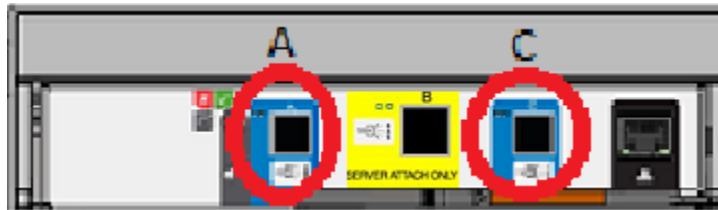

- 5 Connect the cables as follows:
 - Connect one cable to each of the SAS-3 ports on the right of each controller module on the Primary Shelf.
 - Connect the left cable to port A in the left I/O module on the closest Expansion Shelf.
 - Connect the right cable from the Primary Shelf to port A in the right I/O module in the farthest Expansion Shelf.
 - Connect one end of a new cable to port C in the left module of the first Expansion Shelf.
 - Connect one end of another cable to port A on the right I/O module of the first Expansion Shelf.
 - Connect the other end of that cable to port C in the right I/O module of the second Expansion Shelf.
 - Connect one end of another cable to port C on the left I/O module of the second Expansion Shelf.
 - Connect the other end of that cable to port A in the left I/O module of the third Expansion Shelf.
 - Connect one end of another cable to port A on the right I/O module of the second Expansion Shelf.

- Connect the other end of that cable to port C in the right I/O module of the third Expansion Shelf.
- 6 Verify the final cable configuration.

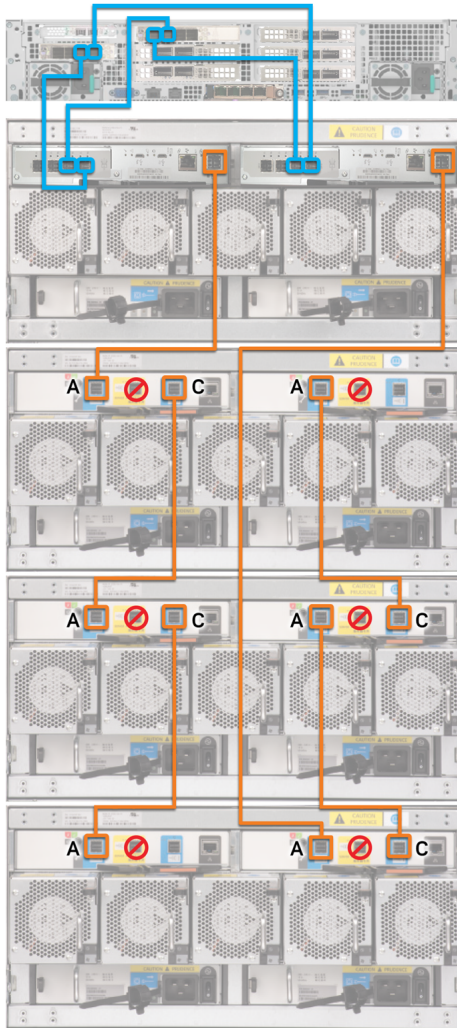

- 7 Connect the power cords of all devices as described in this section.
See [“Connecting the power cords”](#) on page 76.

- 8** Turn on the devices in the proper sequence as described in this section.
See [“Turning on the hardware and verifying operation”](#) on page 78.
- 9** Add the new disk space with the instructions in one of these sections.
See [“Adding the disk space of an Expansion Storage Shelf from the Flex Appliance Console”](#) on page 116.

Adding Expansion Storage Shelves to an operating appliance that has at least one operating Expansion shelf

This appendix includes the following topics:

- [Overview](#)
- [Turning off the existing hardware](#)
- [Installation instructions](#)
- [Connecting one Expansion Shelf to a system that has one existing Expansion Shelf](#)
- [Connecting two Expansion Shelves to a system that has one existing Expansion Shelf](#)
- [Connecting one Expansion Shelf to a system that has two existing Expansion Shelves](#)

Overview

This appendix applies to an operating appliance that has one or two compute nodes and a Primary Storage Shelf.

It is possible to already have one or more Expansion Storage Shelves, up to three units. The hardware must be turned off before you add any storage shelves.

Turning off the existing hardware

You must turn off the existing system before you turn on any new Expansion shelves. Be sure to perform these steps in the order that they are presented.

To turn off the existing hardware

- 1 Perform a soft shutdown of the compute nodes.

If you have two compute nodes you must shut them down separately.

- From the Flex Appliance Shell, enter `system shutdown`.
- Verify that the compute node is completely turned off. All LEDs are off. Fans are not running.
- Repeat these steps for a second compute node if applicable.

- 2 After the compute nodes are turned off you must manually turn off the storage shelves.

- Turn off the Primary shelf first.
- Then turn off the Expansion shelf.
- If you have a second Expansion shelf turn it off last.

- 3 Locate the on/off switches on the two power supplies on the rear of the storage shelves. The switches are in the same location for the Primary shelf and for the Expansion shelves.

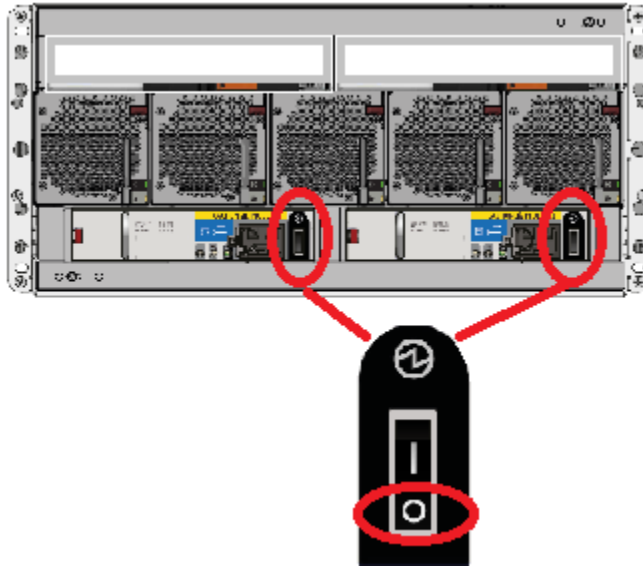

- 4 Press the switches on the Primary shelf to off.
- 5 Press the switches on the Expansion shelf that is closest to the Primary shelf to off.
- 6 If you have a second Expansion shelf press the switches to off.

Installation instructions

The procedures for installing an Expansion shelf and inserting the disk drive carriers are the same as for a Primary shelf. Refer to the following sections for details.

See [“Dimensions and determining rack locations”](#) on page 27.

See [“Installing a storage shelf”](#) on page 34.

See [“Installing disk drives and blanks into a half-capacity storage shelf”](#) on page 47.

See [“Installing disk drives into a full-capacity storage shelf”](#) on page 44.

Connecting one Expansion Shelf to a system that has one existing Expansion Shelf

Expansion Shelves connect to the Primary Shelf and to other Expansion Shelves but they do not connect directly to the compute node.

Note: The orientation of the blue tabs on the ends of the SAS-3 cables is important. In the appliance, the blue tabs on each SAS-3 connector must face as shown in the diagram.

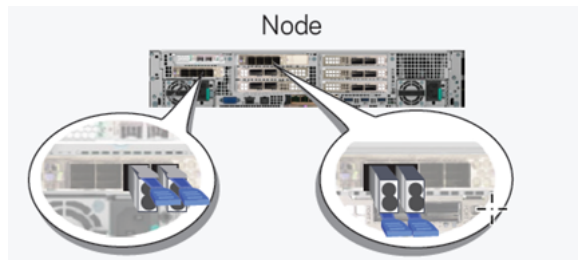

In the storage shelves, the blue tabs in the SAS-3 connectors should point to the 12 Gb/s SAS label near each port.



To connect a new Expansion Shelf to a Primary Shelf and an existing Expansion Shelf

- 1 Verify that all compute nodes and the Primary Shelf are off and that the power cords are unplugged.
Do not remove the cables between the compute nodes and the Primary Shelf.
- 2 Obtain the two SAS-3 cables that ship with each Expansion Shelf.

- 3 Identify the single SAS-3 port on the right side of each controller module in the Primary Shelf.



- 4 Identify ports A and C in each I/O module in the Expansion Shelf. Port B is not available for use.

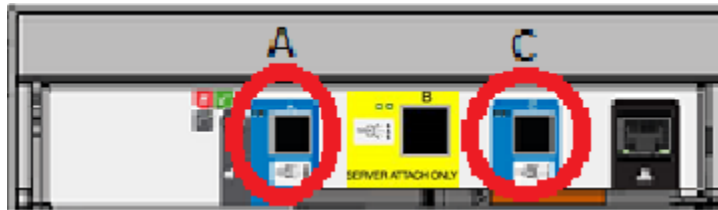

- 5 Connect the cables as follows:
- On the existing Expansion Shelf unplug the SAS-3 connector in port A of the right I/O module.
 - Identify port A in the right I/O module in the second Expansion Shelf. Plug the SAS-3 connector into this port.
 - Connect one end of a new SAS-3 cable to port C on the left I/O module of the existing shelf.
 - Connect one end of a new SAS-3 cable to port C on the left I/O module of the existing shelf.
 - Connect the other end of the cable to port A on the left I/O module on the new shelf.
 - Connect one end of a new SAS-3 cable to port A in the right I/O module of the existing shelf.
 - Connect the other end of the cable to port C in the right I/O module of the new shelf.

- 6 Verify the final cable configuration.

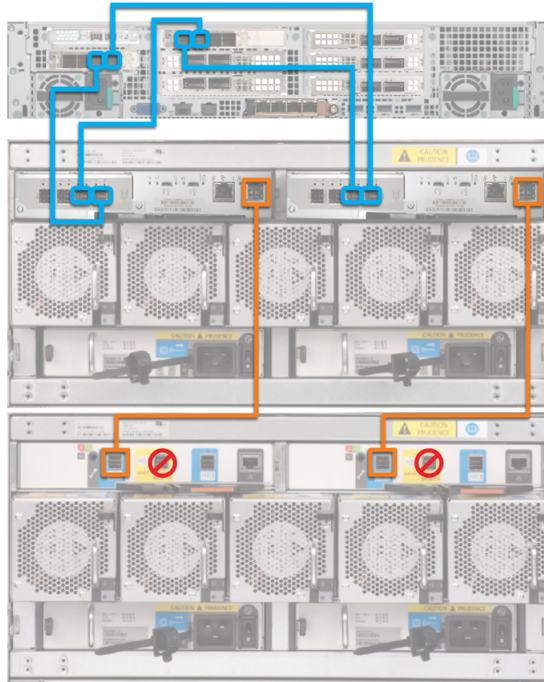

- 7 Connect the power cords of all devices as described in this section.
See [“Connecting the power cords”](#) on page 76.
- 8 Turn on the devices in the proper sequence as described in this section.
See [“Turning on the hardware and verifying operation”](#) on page 78.
- 9 Add the new disk space with the instructions in one of these sections.
See [“Adding the disk space of an Expansion Storage Shelf from the Flex Appliance Console”](#) on page 116.

Connecting two Expansion Shelves to a system that has one existing Expansion Shelf

Expansion Shelves connect to the Primary Shelf and to other Expansion Shelves but they do not connect directly to the compute node.

Note: The orientation of the blue tabs on the ends of the SAS-3 cables is important. In the appliance, the blue tabs on each SAS-3 connector must face as shown in the diagram.

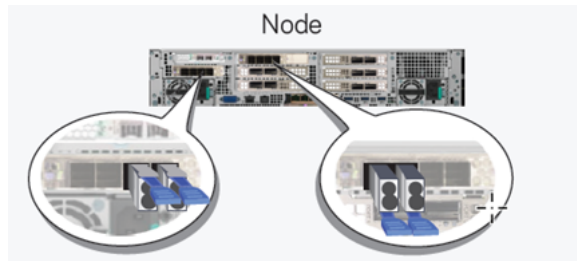

In the storage shelves, the blue tabs in the SAS-3 connectors should point to the 12 Gb/s SAS label near each port.



To connect two new Expansion Shelves to a Primary Shelf and an existing Expansion Shelf

- 1 Verify that all compute nodes and the Primary Shelf are off and that the power cords are unplugged.
Do not remove the cables between the compute nodes and the Primary Shelf.
- 2 Obtain the two SAS-3 cables that ship with each Expansion Shelf.

- 3 Identify the single SAS-3 port on the right side of each controller module in the Primary Shelf.



- 4 Identify ports A and C in each I/O module in the Expansion Shelf. Port B is not available for use.

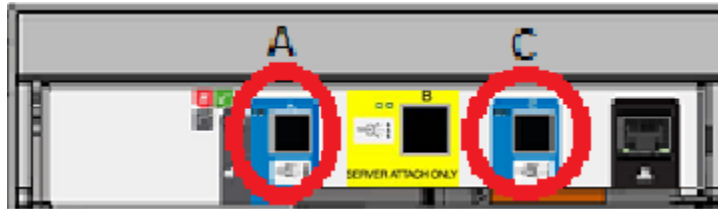

- 5 Connect the cables as follows:
 - On the existing Expansion Shelf unplug the SAS-3 connector in port A of the right I/O module.
 - Connect the end of the cable to port A in the right I/O module in the third Expansion Shelf.
 - Connect one end of a new SAS-3 cable to port C on the left I/O module of the existing shelf.
 - Connect the other end of the cable to port A on the left I/O module on the second shelf.
 - Connect one end of a new SAS-3 cable to port A on the right I/O module of the existing shelf.
 - Connect the other end of the cable to port C on the right I/O module on the second shelf.
 - Connect one end of a new SAS-3 cable to port C on the left I/O module of the second shelf.
 - Connect the other end of the cable to port A on the left I/O module on the third shelf.
 - Connect one end of a new SAS-3 cable to port A on the right I/O module of the second shelf.

- Connect the other end of the cable to port C on the right I/O module on the third shelf.

6 Verify the cabling configuration.

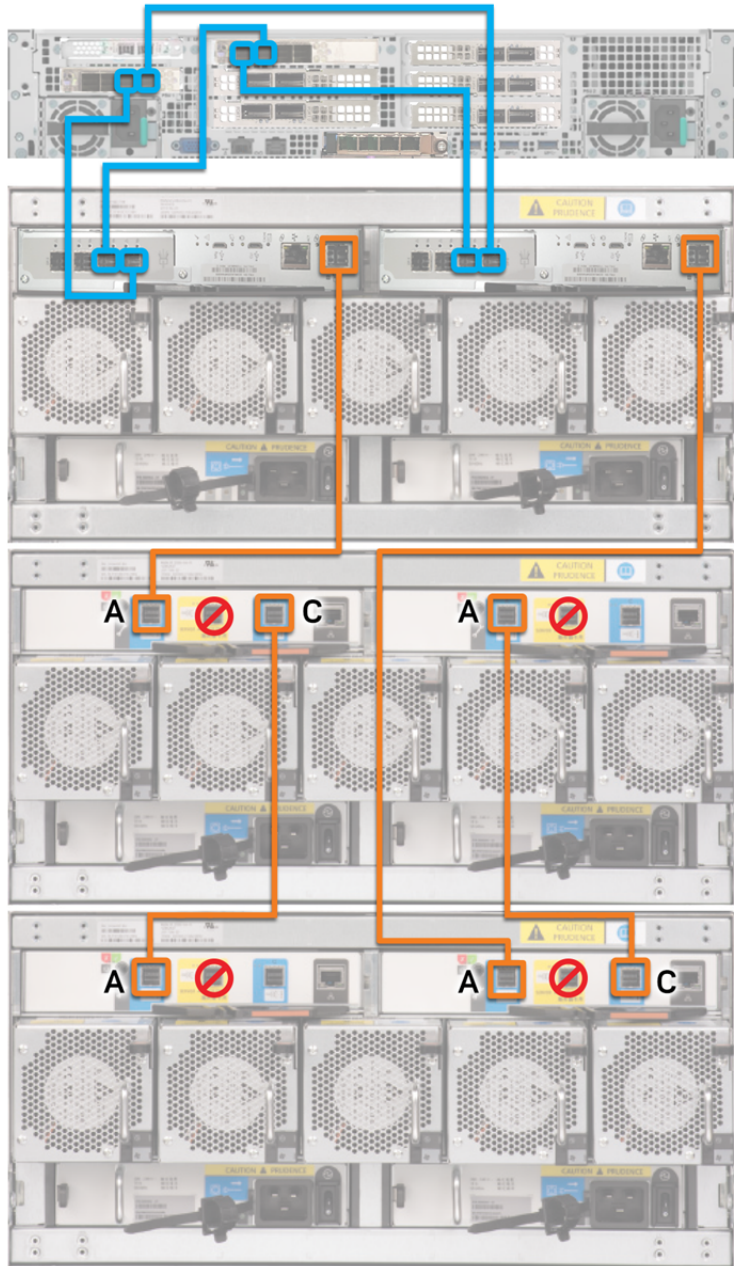

- 7 Connect the power cords of all devices as described in this section.
See [“Connecting the power cords”](#) on page 76.
- 8 Turn on the devices in the proper sequence as described in this section.
See [“Turning on the hardware and verifying operation”](#) on page 78.
- 9 Add the new disk space with the instructions in one of these sections.
See [“Adding the disk space of an Expansion Storage Shelf from the Flex Appliance Console”](#) on page 116.

Connecting one Expansion Shelf to a system that has two existing Expansion Shelves

Expansion Shelves connect to the Primary Shelf and to other Expansion Shelves but they do not connect directly to the compute node.

Note: The orientation of the blue tabs on the ends of the SAS-3 cables is important. In the appliance, the blue tabs on each SAS-3 connector must face as shown in the diagram.

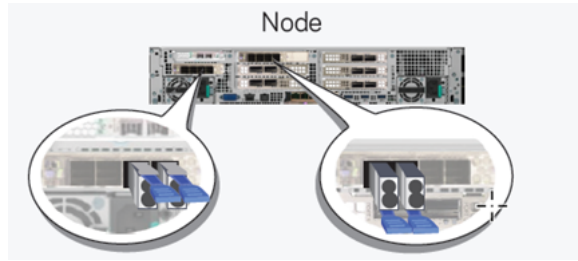

In the storage shelves, the blue tabs in the SAS-3 connectors should point to the 12 Gb/s SAS label near each port.



To connect a new Expansion Shelf to a Primary Shelf and to two existing Expansion Shelves

- 1 Verify that all compute nodes and the Primary Shelf are off and that the power cords are unplugged. Do not remove the cables between the compute nodes and the Primary Shelf.

Do not remove the cables between the compute nodes and the Primary Shelf.

- 2 Obtain the two SAS-3 cables that ship with each Expansion Shelf.

- 3 Identify the single SAS-3 port on the right side of each controller module in the Primary Shelf.



- 4 Identify ports A and C in each I/O module in the Expansion Shelf. Port B is not available for use.

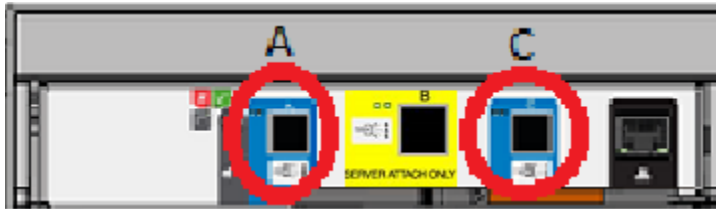

- 5 Connect the cables as follows:
 - On the second existing Expansion Shelf unplug the SAS-3 connector in port A of the right I/O module.
 - Connect the end of the cable to port A in the right I/O module of the third Expansion Shelf.
 - Connect one end of a new cable to port C in the left I/O module of the second shelf.
 - Connect the other end of the cable to port A in the left I/O module of the third shelf.
 - Connect one end of a new cable to port A on the right I/O module of the second shelf.
 - Connect the other end of the cable to port C on the right I/O module of the third shelf.

6 Verify the cabling configuration.

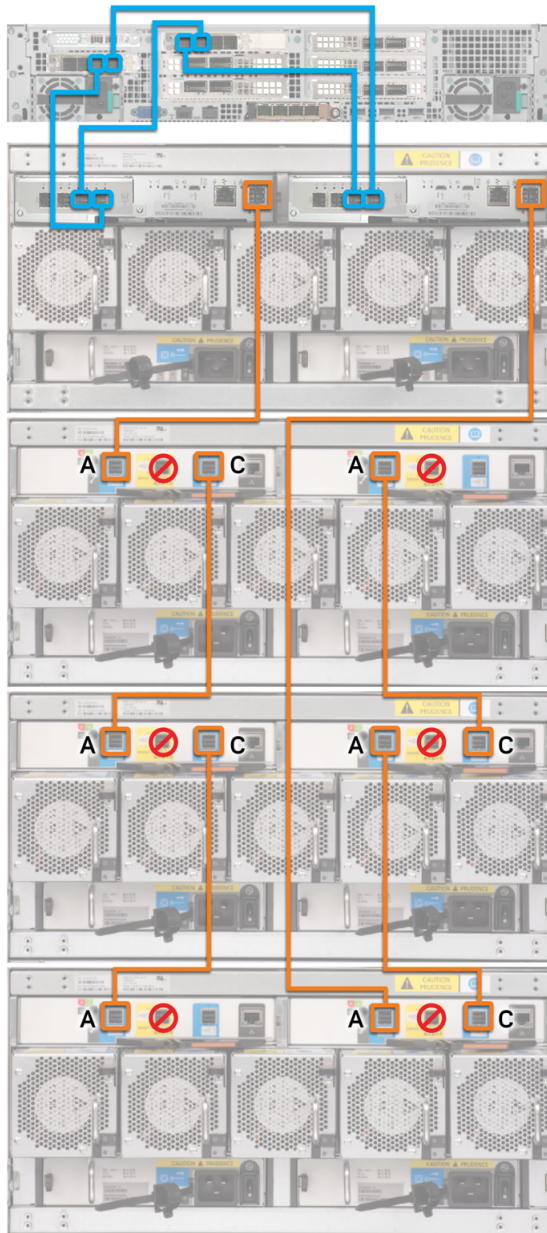

- 7** Connect the power cords of all devices as described in this section.
See [“Connecting the power cords”](#) on page 76.
- 8** Turn on the devices in the proper sequence as described in this section.
See [“Turning on the hardware and verifying operation”](#) on page 78.
- 9** Add the new disk space with the instructions in one of these sections.
See [“Adding the disk space of an Expansion Storage Shelf from the Flex Appliance Console”](#) on page 116.

Configuring the disk space for new Flex Expansion Storage Shelves

This appendix includes the following topics:

- [Adding the disk space of an Expansion Storage Shelf from the Flex Appliance Console](#)

Adding the disk space of an Expansion Storage Shelf from the Flex Appliance Console

Follow the steps in this section to add storage disk space to an appliance after physically adding one or more Expansion Shelves.

Note: When you configure additional disk space, any current backup operations are stopped until the process is complete. Veritas recommends that you do not start any backup operations before starting this procedure.

To configure additional disk space

- 1 Turn on the new shelf or shelves.
- 2 Turn on the appliance node.
See [“Turning on the hardware and verifying operation”](#) on page 78.
- 3 Sign in to the Flex Appliance Console.
- 4 Go to the **System topology** page.

- 5** Click on **Add storage**.
- 6** A confirmation window appears. Click **Yes**.
You can monitor the progress from the Activity Monitor.

Note: In a multi-node appliance, two tasks are shown in the Activity Monitor. A task to add new storage displays for the first node, and a task to scan new storage displays for the second node. The task for the second node runs after the first node's tasks are complete.

If you want to resize instances, refer to the *Resizing instance storage* section in the *Flex Appliance Getting Started and Administration Guide*.