

Veritas™ 5260 Appliance Hardware Installation Guide

VERITAS™

Veritas 5260 Appliance Hardware Installation Guide

Last updated: 2024-05-20

Legal Notice

Copyright © 2024 Veritas Technologies LLC. All rights reserved.

Veritas, the Veritas Logo, and NetBackup are trademarks or registered trademarks of Veritas Technologies LLC or its affiliates in the U.S. and other countries. Other names may be trademarks of their respective owners.

This product may contain third-party software for which Veritas is required to provide attribution to the third party ("Third-party Programs"). Some of the Third-party Programs are available under open source or free software licenses. The License Agreement accompanying the Software does not alter any rights or obligations you may have under those open source or free software licenses. Refer to the Third-party Legal Notices document accompanying this Veritas product or available at:

<https://www.veritas.com/about/legal/license-agreements>

The product described in this document is distributed under licenses restricting its use, copying, distribution, and decompilation/reverse engineering. No part of this document may be reproduced in any form by any means without prior written authorization of Veritas Technologies LLC and its licensors, if any.

THE DOCUMENTATION IS PROVIDED "AS IS" AND ALL EXPRESS OR IMPLIED CONDITIONS, REPRESENTATIONS AND WARRANTIES, INCLUDING ANY IMPLIED WARRANTY OF MERCHANTABILITY, FITNESS FOR A PARTICULAR PURPOSE OR NON-INFRINGEMENT, ARE DISCLAIMED, EXCEPT TO THE EXTENT THAT SUCH DISCLAIMERS ARE HELD TO BE LEGALLY INVALID. VERITAS TECHNOLOGIES LLC SHALL NOT BE LIABLE FOR INCIDENTAL OR CONSEQUENTIAL DAMAGES IN CONNECTION WITH THE FURNISHING, PERFORMANCE, OR USE OF THIS DOCUMENTATION. THE INFORMATION CONTAINED IN THIS DOCUMENTATION IS SUBJECT TO CHANGE WITHOUT NOTICE.

The Licensed Software and Documentation are deemed to be commercial computer software as defined in FAR 12.212 and subject to restricted rights as defined in FAR Section 52.227-19 "Commercial Computer Software - Restricted Rights" and DFARS 227.7202, et seq. "Commercial Computer Software and Commercial Computer Software Documentation," as applicable, and any successor regulations, whether delivered by Veritas as on premises or hosted services. Any use, modification, reproduction release, performance, display or disclosure of the Licensed Software and Documentation by the U.S. Government shall be solely in accordance with the terms of this Agreement.

Veritas Technologies LLC
2625 Augustine Drive
Santa Clara, CA 95054

<https://www.veritas.com>

Technical Support

Technical Support maintains support centers globally. All support services will be delivered in accordance with your support agreement and the then-current enterprise technical support policies. For information about our support offerings and how to contact Technical Support, visit our website:

<https://www.veritas.com/support>

You can manage your Veritas account information at the following URL:

<https://my.veritas.com>

If you have questions regarding an existing support agreement, please email the support agreement administration team for your region as follows:

Worldwide (except Japan)

CustomerCare@veritas.com

Japan

CustomerCare_Japan@veritas.com

Documentation

Make sure that you have the current version of the documentation. Each document displays the date of the last update on page 2. The latest documentation is available on the Veritas website:

https://www.veritas.com/content/support/en_US/dpp.Appliances.html

Documentation feedback

Your feedback is important to us. Suggest improvements or report errors or omissions to the documentation. Include the document title, document version, chapter title, and section title of the text on which you are reporting. Send feedback to:

APPL.docs@veritas.com

You can also see documentation information or ask a question on the Veritas community site:

<https://www.veritas.com/community/>

Veritas Services and Operations Readiness Tools (SORT)

Veritas Services and Operations Readiness Tools (SORT) is a website that provides information and tools to automate and simplify certain time-consuming administrative tasks. Depending on the product, SORT helps you prepare for installations and upgrades, identify risks in your datacenters, and improve operational efficiency. To see what services and tools SORT provides for your product, see the data sheet:

https://sort.veritas.com/data/support/SORT_Data_Sheet.pdf

Contents

Chapter 1	Hardware overview	7
	About the appliance and the storage shelves	7
	Appliance drives	8
	About the 5260 Appliance control panel	9
	About the System Status LED states	11
	About the Power button LED states	14
	About the integrated BMC beep codes	15
	Appliance rear panel	16
	Storage shelf disk drives	16
	Storage shelf control panel	17
	Storage shelf rear panel	18
	Cables	19
	About IPMI configuration	19
	Product documentation	21
Chapter 2	Preinstallation requirements	22
	Customer-provided environment and supplies	22
	Appliance shipping container contents	23
	Storage shelf shipping container contents	24
	Best practices for rack installation	24
	Determining rack locations	25
	Storage shelf rack requirements	26
	Heat dissipation	27
	Verifying SAS-3 cable length	28
	Prerequisites for IPMI configuration	28
Chapter 3	Installation procedures	30
	Installing the storage shelf rack rails	30
	Installing the storage shelf into a rack	32
	Installing the appliance rack rails	33
	Installing the appliance into a rack	37
	Understanding appliance and storage shelf connections	38
	Connecting an appliance to one storage shelf	40
	Connecting an appliance to more than one storage shelf	42

Chapter 4	Next steps after installation	48
	Connecting the network cables	48
	Connecting the power cords	49
	Turning on the hardware and verifying operation	50
	Configuring the Veritas Remote Management Interface from a Flex Appliance	59
	Accessing and using the Veritas Remote Management interface	63
Appendix A	Adding one or more storage shelves to an operating appliance that does not have any storage shelves	66
	Overview	66
	Preparing the appliance	68
	Removing the appliance cover	69
	Installing the Expansion Storage Kit components	70
	Replacing the appliance cover	79
	Connecting the storage shelves to the appliance	80
	Connecting one storage shelf to an appliance	80
	Connecting two storage shelves to an appliance	82
	Connecting three storage shelves to an appliance	84
	Connecting four storage shelves to an appliance	87
	Connecting the fifth storage shelf to an appliance	90
	Connecting the sixth storage shelf to an appliance	93
Appendix B	Adding storage shelves to an operating appliance that has at least one storage shelf attached	98
	Overview	98
	Additional storage shelf scenarios	98
	Recabling to connect additional storage shelves	99
	Connecting additional shelves to an appliance that already has one operating shelf	100
	Connecting additional shelves to an appliance that already has two operating shelf	102
	Connecting additional shelves to an appliance that already has three operating shelf	104

Appendix C	Configuring the disk space for new Flex Expansion Storage Shelves	106
	Adding the disk space of an Expansion Storage Shelf from the Flex Appliance Console	106
Index		108

Hardware overview

This chapter includes the following topics:

- [About the appliance and the storage shelves](#)
- [Appliance drives](#)
- [About the 5260 Appliance control panel](#)
- [Appliance rear panel](#)
- [Storage shelf disk drives](#)
- [Storage shelf control panel](#)
- [Storage shelf rear panel](#)
- [Cables](#)
- [About IPMI configuration](#)
- [Product documentation](#)

About the appliance and the storage shelves

The Veritas 5260 Appliance is a hardware and software storage system that can scale to 429.4TiB of available backup capacity. It consists of a Veritas 5260 Appliance and up to six optional Veritas 2U12 65.5TiB/72TB storage shelves.

Figure 1-1 Veritas 5260 Appliance

The 5260 appliance and storage shelves provide storage capacity in several configurations. You can use the appliance by itself to achieve 9.1TiB to 36.4TiB of usable capacity. You can add storage shelves to any appliance to further increase the storage capacity.

You can add up to six Veritas 2U12 65.5TiB/72TB Storage Shelves to an existing 5260 Appliance.

Refer to the *Veritas 5260 Appliance Product Description Guide* on [SORT](#) for details about usable storage options.

Appliance drives

The front panel of the appliance contains 12 drives.



Slot designations are as follows. Do not rearrange the drives from the factory configuration.

Table 1-1 5260 Appliance disk drive slots

Slot	RAID configuration	Drive size	Appliance storage capacity	Drive role
0-3 8-10	RAID 6	2TB, 8TB	9.1TiB, 36.4 TiB	User storage data
4, 5	RAID 1	1.92 TB	N/A	OS and log files
6	RAID 1	1.92 TB	N/A	Hot spare for OS and log drives
11	RAID 6	2TB, 8TB	N/A	Hot spare for user storage data

About the 5260 Appliance control panel

The front control panel provides push button system controls and LED indicators for several system features.

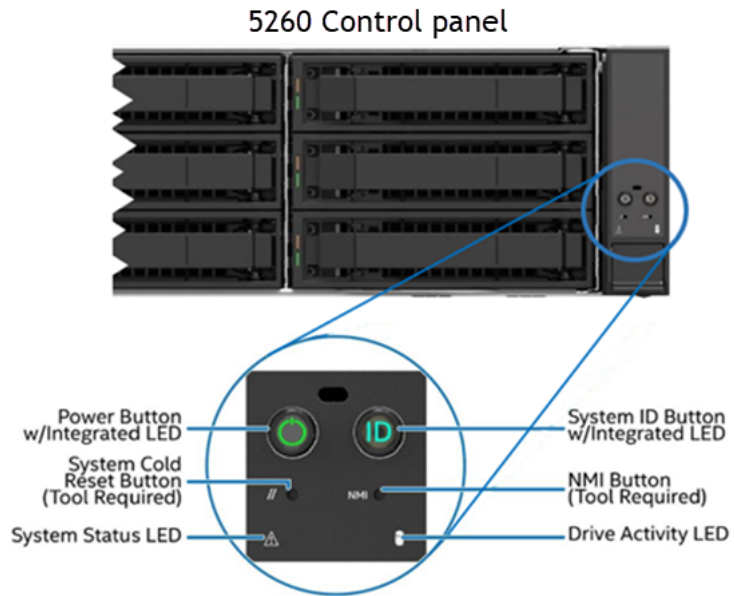

Table 1-2 Control panel system LED descriptions

LED	System information
Power button with integrated LED	<p>The Power button toggles the system on and off. This button also functions as a sleep button if enabled by an ACPI compliant operating system. Pressing this button sends a signal to the integrated BMC that either powers on or powers off the system. Holding the power button for 10 seconds or more leads to a hard shutdown.</p> <p>The integrated LED is a single color (green) and supports different indicator states as defined in the following table. See “About the Power button LED states” on page 14.</p>
Drive Activity LED	<p>The drive activity LED on the front panel indicates drive activity from the server board SATA and SATA storage controllers. The server board also has an I2C header labeled “SAS_MODULE_MISC” to provide access to this LED for add-in SATA or SATA storage controllers.</p>
System ID button with integrated LED	<p>Toggles the integrated ID LED and the blue server board system ID LED on and off. Both LEDs are tied together and show the same state. The onboard system ID LED is on the back edge of the server board, viewable from the back of the system. The system ID LEDs are used to identify the system for maintenance when installed in a rack of similar server systems. Two options available for illuminating the system ID LEDs are:</p> <ul style="list-style-type: none"> ■ The front panel system ID LED button is pushed, which causes the LEDs to illuminate to a solid On state until the button is pushed again. ■ An IPMI <code>Chassis Identify</code> command is remotely entered that causes the LEDs to blink for 15 seconds.
NMI button (recessed, tool required for use)	<p>When the NMI button is pressed, it puts the system in a halt state and issues a non-maskable interrupt (NMI). This situation can be useful when performing diagnostics for a given issue where a memory download is necessary to help determine the cause of the problem. To prevent an inadvertent system halt, the actual NMI button is behind the front control panel faceplate where it is only accessible with the use of a small tipped tool like a pin or paper clip.</p>

Table 1-2 Control panel system LED descriptions (*continued*)

LED	System information
System Cold Reset Button	When pressed, this button reboots and re-initializes the system. Unlike the power button, the reset button does not disconnect the power to the system. It just starts the system's Power-On Self-Test (POST) sequence over again.
System Status LED	<p>The system status LED is a bi-color (green/amber) indicator that shows the current health of the server system.</p> <p>The system provides two locations for this feature; one is on the front control panel and the other is on the back edge of the server board, viewable from the back of the system. Both LEDs are tied together and show the same state. The system status LED states are driven by the server board platform management subsystem. When the server is powered down (transitions to the DC-Off state or S5), the BMC is still on standby power and retains the sensor and front panel status LED state established before the power-down event.</p> <p>Two locations are provided for you to monitor the health of the system. You can find the first location on the front control panel, while the second location is located on the back edge of the server board. It is viewable from the rear of the appliance. Both LEDs show the same state of health.</p> <p>See "About the System Status LED states" on page 11.</p>

About the System Status LED states

The following table provides a description of each LED state.

Table 1-3 System Status LED states

Color	State	Criticality	Description
No color	Off - The system is not operating.	Not ready	<ul style="list-style-type: none"> ■ System power is off (AC and/or DC) ■ System is in EuP Lot6 Off Mode

Table 1-3 System Status LED states (*continued*)

Color	State	Criticality	Description
Green	Solid on (SO)	Healthy	<ul style="list-style-type: none"> ■ System is in S5 Soft-Off State ■ Indicates that the system is running (in S0 State) and its status is “Healthy”. The system is not exhibiting any errors. AC power is present and BMC has booted and manageability functionality is up and running. ■ After a BMC reset, and with the chassis ID solid on, the BMC is booting Linux*. Control has been passed from BMC uBoot to BMC Linux*. The BMC is in this state for roughly 10–20 seconds.
Green	~1 Hz blink	<p>Degraded</p> <p>The system is operating in a degraded state although still functional.</p> <p>or</p> <p>The system is operating in a redundant state but with an impending failure warning.</p>	<p>System degraded:</p> <ul style="list-style-type: none"> ■ Redundant loss, such as power supply or fan. Applies only if the associated platform sub-system has redundancy capabilities. ■ Fan warning or failure when the number of fully operational fans is more than minimum number needed to cool the system. ■ Non-critical threshold crossed: Temperature (including HSBP temp), voltage, input power to power supply, output current for main power rail from power supply and Processor Thermal Control (Therm Ctrl) sensors. ■ Power supply predictive failure occurred while redundant power supply configuration was present. ■ Unable to use all of the installed memory (one or more DIMMs failed/disabled but functional memory remains available). ■ Battery failure ■ BMC executing in uBoot. (Indicated by Chassis ID blinking at 3Hz). System in degraded state (no manageability). BMC uBoot is running but has not transferred control to the BMC Linux. Server will be in this state 6-8 seconds after BMC reset while it pulls the Linux image into flash.

Table 1-3 System Status LED states (*continued*)

Color	State	Criticality	Description
Green	~1 Hz blink	Degraded (continued)	<p>System degraded (continued):</p> <ul style="list-style-type: none"> ■ BMC Watchdog has reset the BMC. ■ Power unit sensor offset for configuration error is asserted. ■ SSD Hot Swap Controller is off-line or degraded.
Green and amber alternately	~1 Hz blink	System is initializing after source power is applied	<ul style="list-style-type: none"> ■ PFR in the process of updating/authenticating/recovering when source power is connected, system firmware being updated. ■ System not ready to take power button event/signal.
Amber	~1 Hz blink	<p>Non-critical</p> <p>The system is operating in a degraded state with an impending failure warning. However, the system is still functioning.</p>	<p>Non-fatal, although the system is likely to fail due to the following issues:</p> <ul style="list-style-type: none"> ■ Critical threshold crossed – Voltage, temperature (including HSBP temp), input power to power supply, output current for main power rail from power supply and PROCHOT (Therm Ctrl) sensors. ■ VRD Hot asserted ■ Minimum number of fans to cool the system not present or failed ■ Hard drive fault ■ Power Unit Redundancy sensor – Insufficient resources offset (indicates not enough power supplies present) ■ In non-sparing and non-mirroring mode, if the threshold of correctable errors is crossed within the window. ■ Invalid firmware image detected during boot up or firmware update.

Table 1-3 System Status LED states (*continued*)

Color	State	Criticality	Description
Amber	Solid on	Critical, non-recoverable – System is halted	<p>Fatal alarm – system has failed or shutdown:</p> <ul style="list-style-type: none"> ■ CPU CATERR signal asserted ■ MSID mismatch detected (CATERR also asserts for this case) ■ CPU0 is missing ■ CPU Thermal Trip ■ No power – power fault ■ DIMM failure when there is only one DIMM present; no other good DIMM memory present ■ Runtime memory uncorrectable error in non-redundant mode. ■ DIMM Thermal Trip or equivalent ■ BMC/Video memory test failed (Chassis ID shows blue/solid-on for this condition) ■ SBB Thermal Trip or equivalent ■ 240VA fault ■ Both uBoot BMC FW images are bad (Chassis ID shows blue/solid-on for this condition) ■ Fatal Error in processor initialization: <ul style="list-style-type: none"> ■ Processor family not identical ■ Processor model not identical ■ Processor core/thread counts not identical ■ Processor cache size not identical ■ Unable to synchronize processor frequency ■ Unable to synchronize QPI link frequency ■ BMC fail authentication with non-recoverable condition, system hang at T-1; boot PCH only, system hang; PIT failed, system lockdown.

About the Power button LED states

The following table provides a description of each power state.

Table 1-4 Power button LED states

State	Power Mode	LED	Description
Power - off	Non-ACPI	Off	The system power is off, and the BIOS has not initialized the chipset.
Power - on	Non-ACPI	On	The system power is on and the green Power button LED is active.
S0	ACPI (Advanced Configuration and Power Interface)	Steady on	The system and the operating system are up and running.
S5	ACPI (Advanced Configuration and Power Interface)	Off	Mechanical is off and the operating system has not saved any context to the hard disk drive.

About the integrated BMC beep codes

The integrated BMC may generate beep codes upon detection of failure conditions. Beep codes are sounded each time the problem is discovered, such as on each power-up attempt, but are not sounded continuously.

Table 1-5 Integrated BMC beep codes

Associated sensors	Reason for beep
CPU missing sensor	No CPUs installed or first CPU socket is empty.
MSID mismatch sensor	MSID mismatch occurs if a processor is installed into a system board that has incompatible power capabilities.
Power fault	DC power unexpectedly lost (power good dropout) – Power unit sensors report power unit failure offset.
Power unit – soft power control failure offset	Power control fault (power good assertion timeout).
VR watchdog timer	VR Watchdog Timer sensor assertion
PS status	The system does not power on or unexpectedly power off and a power supply unit (PSU) is present that is an

Appliance rear panel

The rear panel of the appliance contains several default ports that are embedded. Three PCIe riser assemblies support various configurations.

The three PCIe riser assemblies are numbered, 1, 2, and 3 from right to left. Slots 1 through 8 are shown in the risers.

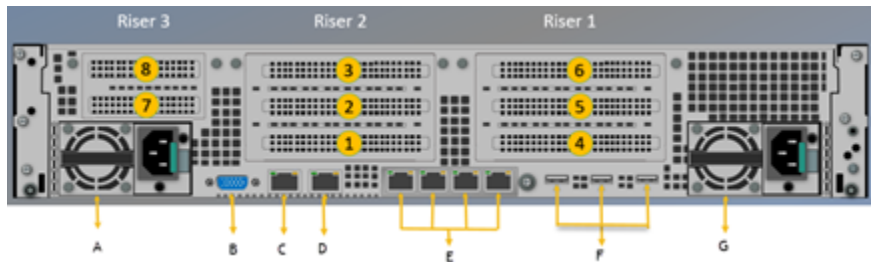

The following ports and connectors are available on the rear panel:

- **A, G:** Power Supply Units
- **B:** VGA port
- **C:** IPMI remote management port
- **D:** Serial port
- **E:** Four copper, RJ45, 10 Gb Ethernet ports, host0, NIC0, NIC1, and NIC2, left to right

Note: The embedded Ethernet ports are copper. PCIe Ethernet ports are optical. You cannot bond the copper ports and the optical ports to each other.

- **F:** Three 3.0 USB ports
- The riser assembly 2, Slot 1 is reserved for the RAID PCIe card

Refer to the *Veritas 5260 Appliance Product Description Guide* on [SORT](#) site for optional port configurations.

Storage shelf disk drives

The 5260 Storage Shelf is a 2U enclosure that contains 12 disk drives.



Disk drive carriers in the storage shelf are locked by default. If you need to replace a locked disk drive use a screwdriver with a T10 bit to unlock each carrier.



The lock is located on the left side of each carrier.

Storage shelf control panel

The left, front, of the storage shelf contains the system control panel.



Components of the control panel include the following.

1. The Input switch enables you to set the Unit Identification display.
2. The Power On/Standby LED is amber when only standby power is available. The LED is green when system power is available.

3. The Module Fault LED is on when there is a system hardware fault. A Power Cooling Module (PCM) or an I/O module may be at fault.
4. The Logical Status LED shows a change of status or a fault, typically associated with the shelf's disk drives. This LED also indicates an issue with an internal RAID controller or external RAID controller, or with a host bus adapter.
5. The Unit Identification Display provides information to assist in the configuration of multiple storage shelves.

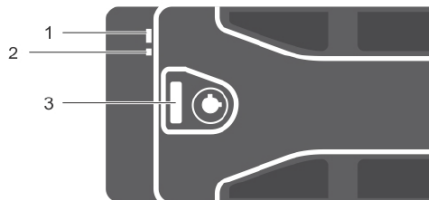

Components of the control panel include the following.

Storage shelf rear panel

The rear panel of the Storage Shelf contains two main components; two Power Cooling Modules (PCMs) and two I/O Module canisters.

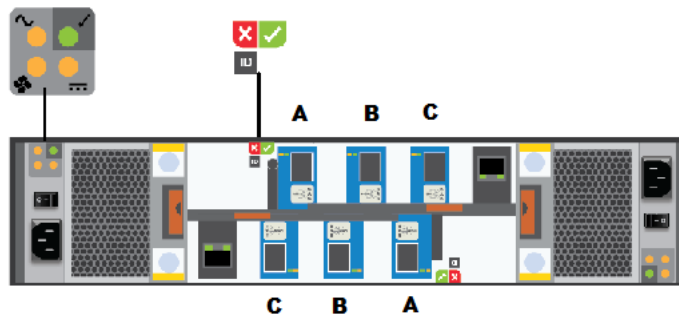

The PCMs, located on the left and the right sides of the storage shelf, contain fans.

The I/O module canisters are located in the center of the rear panel, one on top of the other. Each I/O module contains three mini-SAS HD ports; A, B, and C. The mini-SAS HD ports connect the I/O modules to the appliance and to other storage shelves. Note that the port labels are reversed on the bottom canister. Port C is not used at this time.

The PCMs and the I/O modules include LEDs.

Cables

Two power cables are shipped with each appliance and each storage shelf.

Two one-meter SAS-3 cables are shipped with each storage shelf. The one-meter cables are sufficient when the recommended cabling scheme is followed.

Three-meter SAS-3 cables are available separately in case of need.



Use the top down, bottom up method to connect storage shelves to the appliance. The general scheme follows.

- The appliance is connected to the first storage shelf with one SAS-3 cable.
- One cable connects the first storage shelf to the next shelf.
- Subsequent storage shelves are connected until the last storage shelf is connected.
- The last storage shelf is connected to the appliance with one cable.
- The last storage shelf is also connected to the next, highest, storage shelf.
- The storage shelves are connected until the shelf closest to the appliance is connected.

See [“Connecting the network cables”](#) on page 48.

About IPMI configuration

The Intelligent Platform Management Interface (or IPMI) provides management and monitoring capabilities independently of the host system's CPU, firmware, and operating system. You can configure the IPMI sub-system for your appliances. You can use the remote management port, located on the rear panel of the appliance, to connect to the IPMI sub-system.

The following figure shows the remote management port (or the IPMI port) on the rear panel of a 5260 Appliance:



The IPMI is beneficial after an unexpected power outage shuts down the connected system. In case the appliance is not accessible after the power is restored, you can use a laptop or desktop computer to access the appliance remotely by using a network connection to the hardware rather than to an operating system or login shell. This enables you to control and monitor the appliance even if it is powered down, unresponsive, or without any operating system.

The following diagram illustrates how IPMI works:

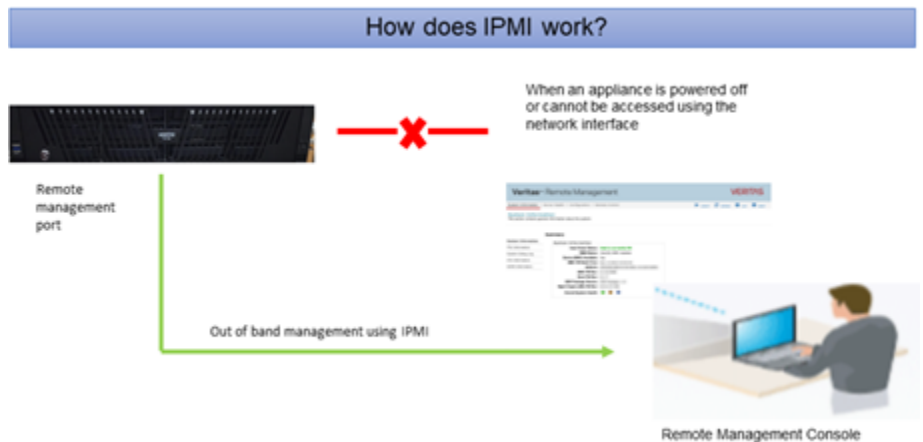

The following are some of the main uses of IPMI:

- Manage an appliance that is powered off or unresponsive. Using the IPMI, you can power on, power off, or restart the appliance from a remote location.
- Provide out-of-band management and help manage situations where local physical access to the appliance is not possible or preferred like branch offices and remote data centers.
- Access the Appliance Shell Menu remotely using IPMI if regular network interface is not possible.

- Reimage the appliance from the IPMI interface by using ISO redirection.
- Monitor hardware health of the appliance from a remote location.
- Avoid messy cabling and hardware like keyboard, monitor, and mouse (KVM) solutions to access the appliance.
- Required to elevate to an unrestricted shell for support when in lockdown mode.

Product documentation

Additional documentation is available at the following site.

[Appliance Documentation](#)

[Veritas Appliance Hardware Get Started Documents](#)

Preinstallation requirements

This chapter includes the following topics:

- [Customer-provided environment and supplies](#)
- [Appliance shipping container contents](#)
- [Storage shelf shipping container contents](#)
- [Best practices for rack installation](#)
- [Determining rack locations](#)
- [Storage shelf rack requirements](#)
- [Heat dissipation](#)
- [Verifying SAS-3 cable length](#)
- [Prerequisites for IPMI configuration](#)

Customer-provided environment and supplies

For best ventilation, the rack cabinet:

- Should be at least 100 cm (4 feet) from walls
- Should have at least 100 cm (4 feet) from other cabinets on the front and back of the appliance and the storage shelves

Data centers with two-foot spaces in the front and in the back of the appliances are acceptable with proper cooling and ventilation.

Refer to the following section for more details.

See “[Heat dissipation](#)” on page 27.

The following describes the necessary personnel and equipment that are needed at the installation site:

- At least three people or a mechanical lift to move the appliance and the storage shelves.
- Cables to connect the appliance to your corporate network.
- Cables to connect the appliance to external storage.
- A USB-keyboard and a monitor to connect to the appliance.
- A 19-inch rack with dual Power Distribution Units (PDUs) with 120VAC or 220VAC power supplies for the compute node.
- A magnetic Philips-head screw driver to install the storage shelf rails into the rack.
- A screwdriver with a 2mm Hex bit to secure the bezels to the front of each storage shelf drawer.
- A 19-inch rack with dual Power Distribution Units (PDUs) with 220VAC power input for the storage shelves.

See “[Best practices for rack installation](#)” on page 24.

Appliance shipping container contents

The appliance and each storage shelf are shipped in separate containers. Each container includes other boxes and contents. The disk drives are installed into the appliance and the storage shelf at the factory.

The following items ship within the appliance box.

- QR code card that includes links to the following items:
 - Veritas Appliance Getting Started documents (https://www.veritas.com/content/support/en_US/article.100053037) such as deployment plans and cabling posters
 - Appliances Support page (https://www.veritas.com/content/support/en_US/dpp.Appliances) that links to the appliance documentation and other resources
- Envelope containing the following:
 - Warranty and license information
- Accessory box containing rack rails

- Two power cables
- Two screws
- Bezel

Storage shelf shipping container contents

The appliance and each storage shelf are shipped in separate containers. Each container includes other boxes and contents.

The following items ship within the storage shelf box.

- Rack rails
- Two SAS-3 cables
- Two power cords

Best practices for rack installation

Prepare for the hardware installation by following these recommendations.

- The appliance requires two RUs of space. Install the appliance in the space that is directly above the storage shelves.
- Two people should install the rails; one person at the back of the rack and one at the front.
- Two people should lift and place the appliance into the mounted rails.
- The storage shelves are heavier than the appliance and should be installed as close to the bottom of the rack as possible.
- Always install the heavier storage shelves at the bottom of the rack. Best practices recommend that you install hardware at the bottom of a rack first. Then work your way up the rack.
- Determine device order and cabling limits.
- Be aware of the depth of the guide rails and the devices. Ensure that the distance between cabinet posts accommodates the rails, devices, cables, and extending ears.
- Physically hold a SAS-3 cable between the intended locations for the appliance and the last storage shelf. Visually confirm that the cable is long enough.

Determining rack locations

The appliance and the storage shelves are both two rack units (2RU) high. To help you identify RU spacing, many rack manufacturers typically use a system of lines and sequential numbers starting at the bottom of the rack. The front and the rear of the rack are marked the same to ensure that the rails are installed straight and level. One RU has three holes. The holes for one RU are typically marked with a line below the bottom hole and another line above the top hole.

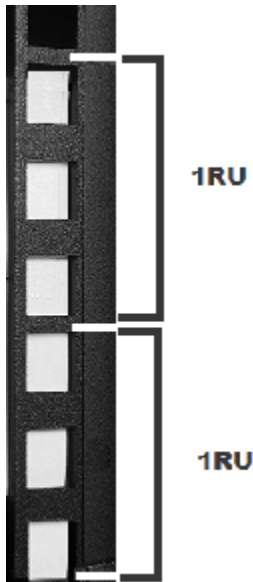

Next, use the rack templates that ship with the storage shelves to determine the mounting locations.

See [“Best practices for rack installation”](#) on page 24.

To determine rack locations for the storage shelves

- 1 A storage shelf is 2RU high. Multiply the number 2 by the number of shelves that you plan to install.

An appliance and six storage shelves require a total of 14 RUs.

- 2 Use the rack templates that are provided with the hardware to determine RU locations. The templates show the front and rear of a storage shelf in a rack.

- 3 Fold the template along the yellow dotted lines to match the rack holes exactly.

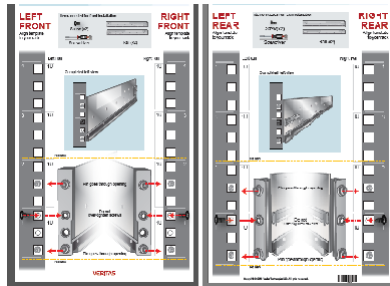

- 4 Record the rack positions to help you locate them easily when mounting the hardware.
- 5 Next, assess the SAS-3 cables to be sure that you have the correct lengths for your installation.

The following procedure provides information to help you verify that you have the correct lengths of SAS-3 cable.

To determine SAS-3 cable requirements

- ◆ Note that each rack unit (RU) is 44.50 mm (1.752 inches) in height. The 5260 Appliance and the 5260 Storage Shelf are both 2RU high.

Storage shelf rack requirements

For best ventilation, the rack cabinet:

- Should be at least 100 cm (4 feet) from walls.
- Should have at least 100 cm (4 feet) from other cabinets on the front and back of the appliance and the storage shelves.
- Data centers with two-foot spaces in the front and in the back of the appliances are acceptable with proper cooling and ventilation
- There must be a minimum depth of 76 cm (30 in.) between the front of the rack and the rear of the rack.
- The compute node rails are extensible to 820mm (32in). The minimum distance or depth allowed between the rack posts is 623mm (24.6"). The maximum distance or depth allowed between the rack posts is 942mm (37").
- Storage shelves should be installed lower in the rack than the appliance.

The following list describes the necessary personnel and equipment that customers must supply at the installation site:

- At least two people or a mechanical lift to move the appliance and the storage shelves.
- Two people to install the rails; one person at the back of the rack and one at the front
- Two people to lift and place the storage shelf into the mounted rails
- Cables to connect the appliance to your corporate network.
- A USB-keyboard and a monitor to connect to the appliance.
- A 19-inch rack with dual Power Distribution Units (PDUs) with 220VAC power supplies.

Heat dissipation

Air flows from the front of each unit and exits from the rear of each unit. You can install the optional bezel without disruption to the airflow.

For best ventilation, the rack cabinet should:

- Be at least 100 cm (4 feet) from walls.
- Be at least 100 cm (4 feet) from other cabinets on the front and back of the appliance and the storage shelves.

Note: Data centers with two-foot spaces in the front and in the back of the appliances are acceptable with proper cooling and ventilation.

Veritas provides the following requirements to ensure sufficient cooling.

- Veritas requires that you install the system in a National Engineering Manufacturer's Association (NEMA)-certified or equivalent rack.
- A minimum of 3 inches (7.6 cm) of space must be between the front of an appliance and the cabinet door or other air block.
- A minimum of 6 inches (15.2 cm) of space must be between the rear of an appliance and the cabinet rear or other air block.
- A minimum of 1 inch (2.5 cm) of space must be between the front of a storage shelf and the cabinet door or other air block.
- A minimum of 2 inches (5.0 cm) of space must be between the rear of a storage shelf and the cabinet rear or other air block.

Refer to the *Veritas 5260 Appliance Product Description Guide* for specifications about temperature and cooling.

[Appliance documentation](#)

Verifying SAS-3 cable length

Before you install and connect the hardware, be sure to verify that you have the correct length of the SAS-3 cables for your setup.

Each rack unit (RU) is 44.50 mm (1.752 inches) in height. The 5260 Appliance and the 5260 Storage Shelf are both 2RU high.

Each SAS-3 cable is 1 meter (3.28 feet) long. The 1-meter cable is long enough to connect an appliance to the fourth storage shelf when the recommended configuration is used.

Longer SAS-3 cables are supported with the 2U12 Storage Shelf if needed for the configuration and are provided by the customer.

Prerequisites for IPMI configuration

Verify the following configuration prerequisites:

- The remote management port auto-negotiates its link speed to 1 Gbps.

Note: If the IPMI port is connected to a managed switch port, it is recommended that you configure the switch port to auto-negotiation

- If a firewall exists between the appliance and the remote devices that manage an appliance (like a laptop computer), open the following ports:

66	SOL SSH
80	HTTP
162	SNMP
443	HTTPS
623	Floppy/USB media
627	Secured Floppy/USB media
5120	CD

5124	Secured CD
5900	KVM
5902	Secured KVM

Note: If you have a private internal network, remember to configure the settings accordingly in your network address translation (NAT).

- The remote management port must be configured as a DHCP or static address.

Installation procedures

This chapter includes the following topics:

- [Installing the storage shelf rack rails](#)
- [Installing the storage shelf into a rack](#)
- [Installing the appliance rack rails](#)
- [Installing the appliance into a rack](#)
- [Understanding appliance and storage shelf connections](#)
- [Connecting an appliance to one storage shelf](#)
- [Connecting an appliance to more than one storage shelf](#)

Installing the storage shelf rack rails

Use the following procedure to install the storage shelf rack rails. Ensure that the best practises for installing the rack rails are followed.

See [“Storage shelf rack requirements”](#) on page 26.

To install storage shelf rails

- 1 Identify the front and the rear of each rail. The following illustration shows the front of the left-hand and the right-hand rails. Red arrows show the pins that fit into the rack.

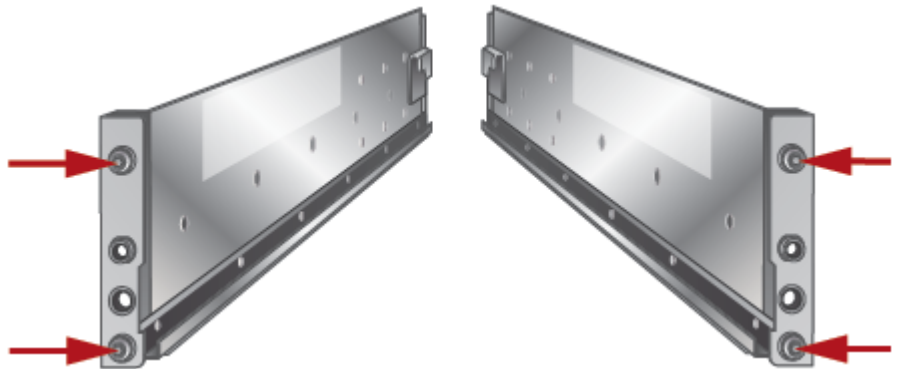

- 2 Use the rack templates to align the rails with the rack holes. Be sure to use the same holes on each side of the rack. Fold the template at the dotted yellow lines to get accurate rail and rack matching.



- 3 Place the left rail inside the rack. The rail holes should match the template. Extend the rail front and back to fit into the rack.

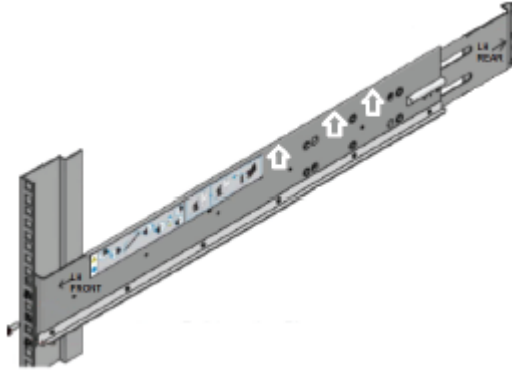

- 4 Insert the screw in the front and in the back of the rail, as shown in the template. Do not over-tighten the screws.
- 5 Repeat for the right rail.

Installing the storage shelf into a rack

The storage shelf should be installed from the front of the rack with the control panel on the left side of the shelf.



To install a storage shelf

- 1 Use two people to lift the storage shelf.
- 2 Slide the rear of the shelf into the front of the rails. Be sure that the shelf is straight and even inside the rack. Do not force the shelf to fit.
- 3 Carefully push the shelf towards the rear of the rails.

- 4 Remove the cap from the left and the right sides of the front of the shelf, if they are attached.

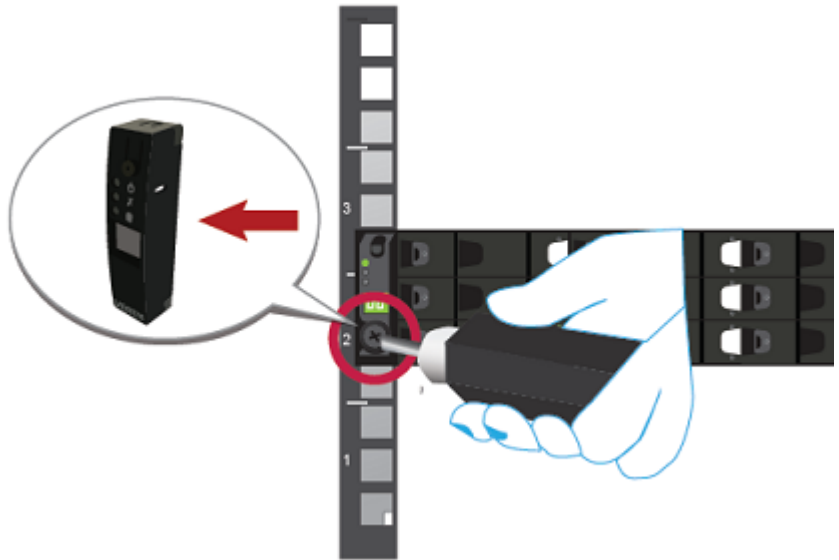

- 5 Insert one screw into the front of the rack, on both sides of the shelf.
- 6 Replace the end caps or attach the bezel to the front of the shelf.

Installing the appliance rack rails

Use the following procedure to install the rack rails. Ensure that the best practises for installing the rack rails are followed.

See [“Best practices for rack installation”](#) on page 24.

To install the rails

- 1 Identify the left and the right rails. The front of the left rail is labeled as "FRONT-A." The front of the right rail is labeled as "FRONT-B." The "FRONT" labels face outward.

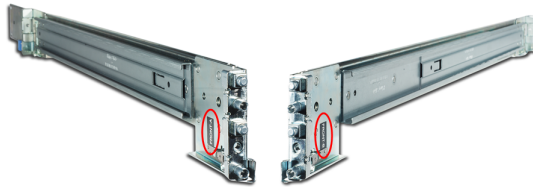

- 2 Extend both rails to expose the white pull tabs on the inner rails.

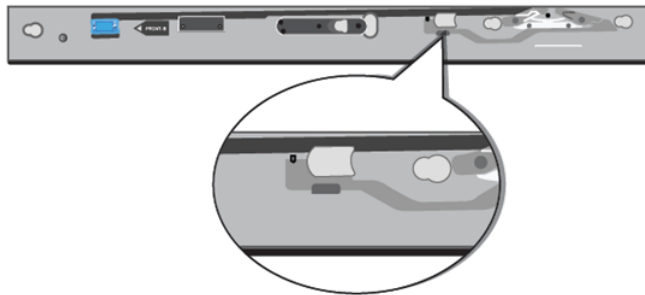

Pull the white tabs forward to release the inner rails from the outer and the intermediate rails.

- 3 Install the inner rails on the appliance by sliding them toward the back of the appliance until they click into place.

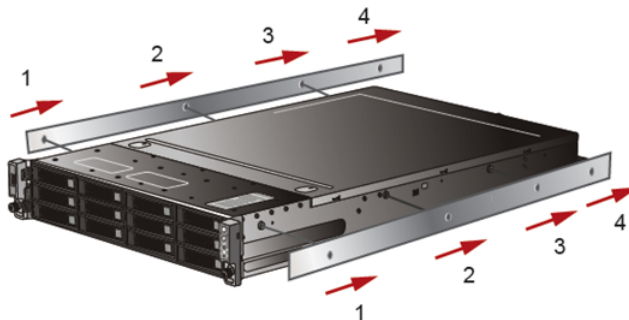

- 4 Starting with one of the rails, align the pins (small circles) on the back of the rail with the rack holes. Slide the rail forward until the lock clicks into place on the rack (large circle).

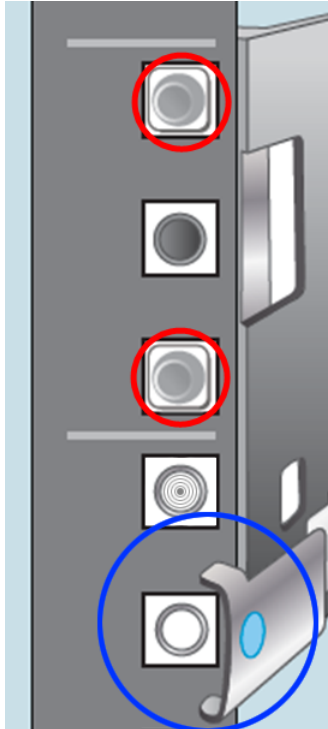

- 5 Fit the pins on the back of the rail in the appropriate rack holes and push until they click into place. Make sure that the lock is behind the rack post.

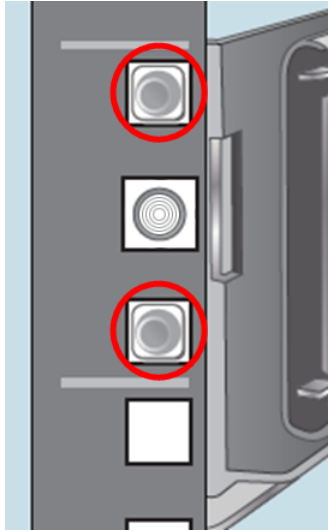

- 6 Push the blue tab toward the center of the rack until it clicks to lock the rail in place.

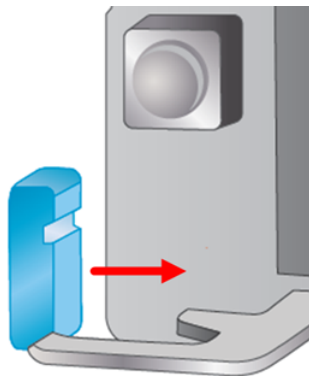

- 7 Repeat the process with the second rail.
- 8 Verify that both rails are parallel and fastened securely and that they can pull out to their full extension.

Installing the appliance into a rack

After the storage shelves and the appliance rails have been installed, you can install the appliance into the rack.

To install the appliance into the rack

- 1 Verify that the rails are securely attached.
 - Verify that the outer rail is securely attached to the rack.
 - Verify that the inner rail is securely attached to the appliance.
- 2 Place the hardware in the front of the rack.
- 3 Pull the intermediate portion of rail the rail forward. Ensure that the ball bearing retainer on the intermediate rail is locked forward.

Note: The rails must be in a locked position so that the inner rail can be inserted into the intermediate rail. If the rails are not locked, they may collapse when the inner rail is inserted and the appliance may be damaged.



- 4 Align the appliance inner rail to the intermediate rail in the rack. Slide the inner rail that is attached to appliance forward into the intermediate rail until a hard stop is encountered.

The rail has a lock mechanism that prevents the hardware from being fully pushed into the rack.

- 5 Slide the blue tab to unlock the rails and continue the sliding of the appliance into the rack.

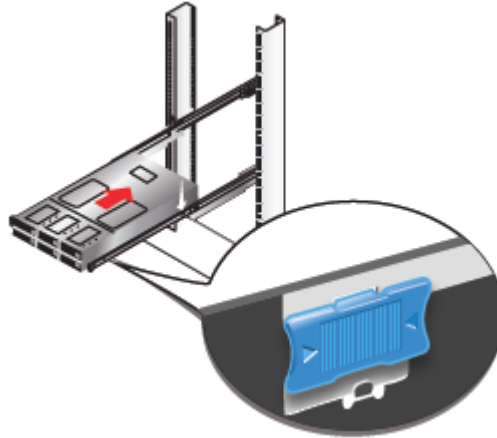

- 6 Secure the captive screws on the appliance ears.

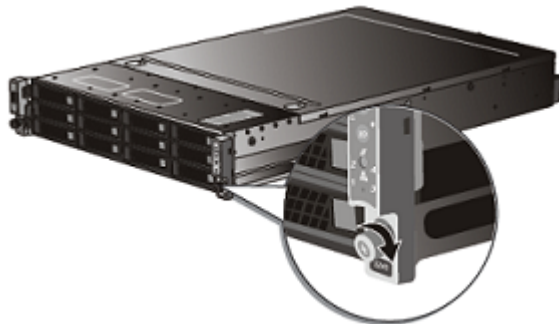

Understanding appliance and storage shelf connections

You cannot use SAS-2 cables with the storage shelf. You must use the SAS-3 cables that are provided with each storage shelf.



Note: The cables in the illustrations in the following sections are shown in different colors for demonstration purposes only. The actual cables are black.

The External RAID PCIe ports on the rear panel of the appliance are in Slot 1 of Riser 2.

There are two I/O module canisters in the middle of the rear panel of the storage shelf. Each I/O module includes three mini-SAS HD ports.

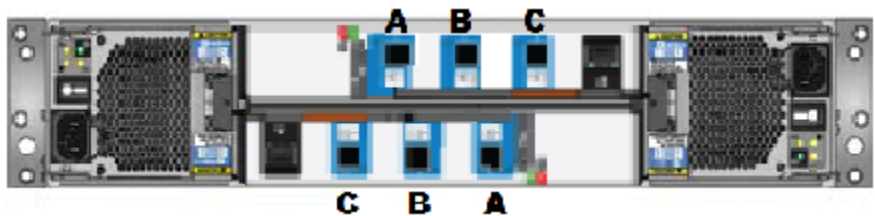

The mini-SAS HD ports on the top I/O module canister are labeled A, B, and C from left to right.

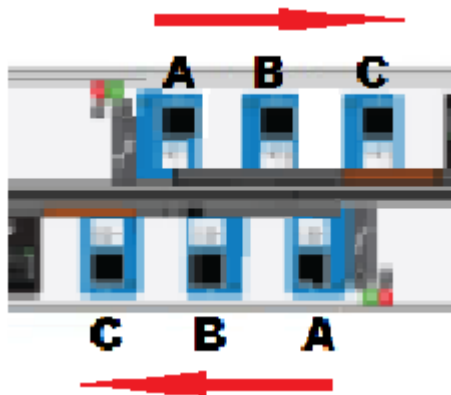

The mini-SAS HD ports on the bottom I/O module canister are labeled in reverse order; C, B, and A from left to right.

The orientation of the blue tab that is attached to the SAS-3 cable connector is very important.

In the appliance, the blue tabs on each SAS-3 connector must face down.

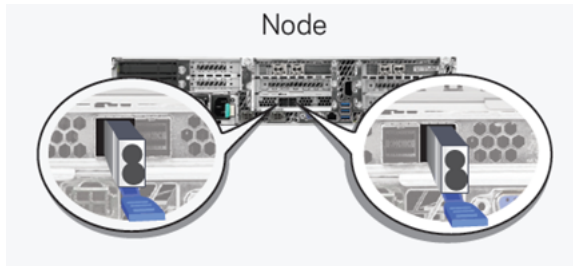

In the storage shelves, the blue tabs in the SAS-3 connectors should point to the 12 Gb/s SAS label near each port. The blue tabs on the SAS-3 connectors inserted into the top row must face down. The blue tabs of the connectors inserted into the bottom row must face up.

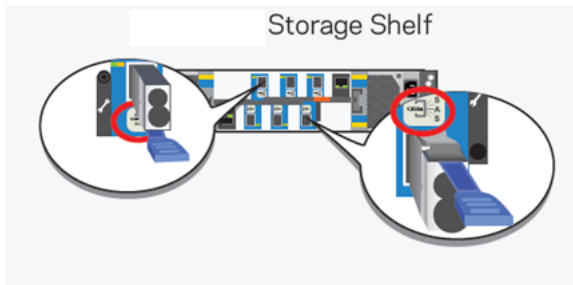

The steps in the following sections assume that the appliance and one or more storage shelves are shipped together and installed at the same time.

Refer to the following sections as needed.

See [“Connecting an appliance to one storage shelf”](#) on page 40.

See [“Connecting an appliance to more than one storage shelf”](#) on page 42.

Connecting an appliance to one storage shelf

The steps in this section assume that the appliance and the storage shelf are shipped together and installed at the same time.

Note: Cables in the following diagrams are shown in different colors for demonstration purposes only. The actual cables are black.

Note: Be sure that you orient the blue tabs on each SAS-3 connector correctly. Refer to the following section for details.

See [“Understanding appliance and storage shelf connections”](#) on page 38.

To connect an appliance to one storage shelf

- 1 Connect one end of the SAS-3 cable to the left-hand port in the External RAID PCIe card on the appliance. The blue tab on the SAS-3 connector should be facing down.
- 2 Connect the other end of the cable to port A in the top canister of the storage shelf.
- 3 Connect one end of the other SAS-3 cable to port A in the bottom canister of the storage shelf. Be sure that you orient the SAS-3 connector in the storage shelf port A so the blue tab faces up, or is on the same side of the cable as the SAS-3 label.
- 4 Connect the other end of this cable to the right-hand port in the External RAID PCIe card on the appliance. The blue tab on the SAS-3 connector should be facing down.

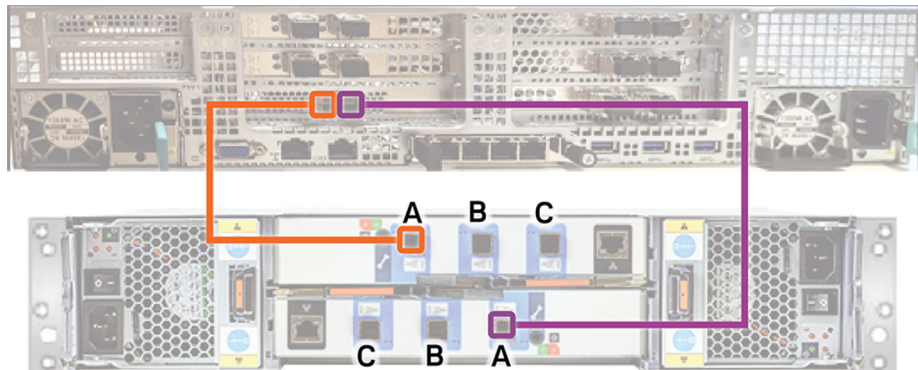

See [“Connecting the network cables”](#) on page 48.

See [“Connecting the power cords”](#) on page 49.

Connecting an appliance to more than one storage shelf

The steps in this section assume that the appliance and the storage shelves are shipped together and installed at the same time. You can install up to six storage shelves with a 5260 appliance.

You can add storage shelves to an operational appliance. Refer to one of the following appendices for instructions.

- Appendix A - Adding one or more storage shelves to an operating appliance that does not have any storage shelves
See [“Overview”](#) on page 66.
- Appendix B - Adding storage shelves to an operating appliance that has at least one storage shelf attached
See [“Overview”](#) on page 98.

Note: Be sure that you orient the blue tabs on each SAS-3 connector correctly. Refer to the following section for details.

See [“Understanding appliance and storage shelf connections”](#) on page 38.

To connect an appliance to storage shelves

Note: This section provides detailed instructions to connect four storage shelves to an appliance. Instructions for connecting six shelves are provided where necessary.

- 1 Connect the cables as follows:
 - Connect the appliance external RAID controller left port to port A on the top canister of the storage shelf.
 - Connect each storage shelf top canister port B to next storage shelf top canister port A.
 - Connect the appliance external RAID card right port to the last storage shelf bottom canister port A.

Note: In a six-shelf configuration you must connect the appliance RAID card right port to port A in the bottom canister of the sixth storage shelf.

- Starting with the last storage shelf, connect the storage shelf bottom canister port B to the next storage shelf bottom canister port A.
 - Connect another cable to the shelf that is second from the bottom. Use port B on the lower canister of that shelf.
 - Connect the other end of the cable to the shelf that is third from the bottom. Use port A on the lower canister of that shelf.
 - Continue until the all storage shelf bottom canisters are connected.
- 2 In a two-shelf configuration, verify that all cables are installed as shown.

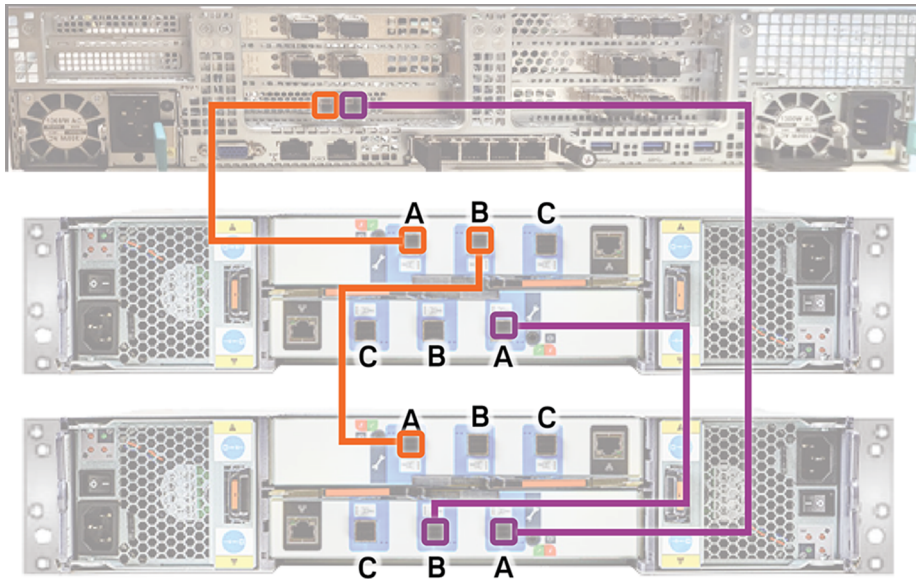

- 3 In a three-shelf configuration, verify that all cables are installed as shown.

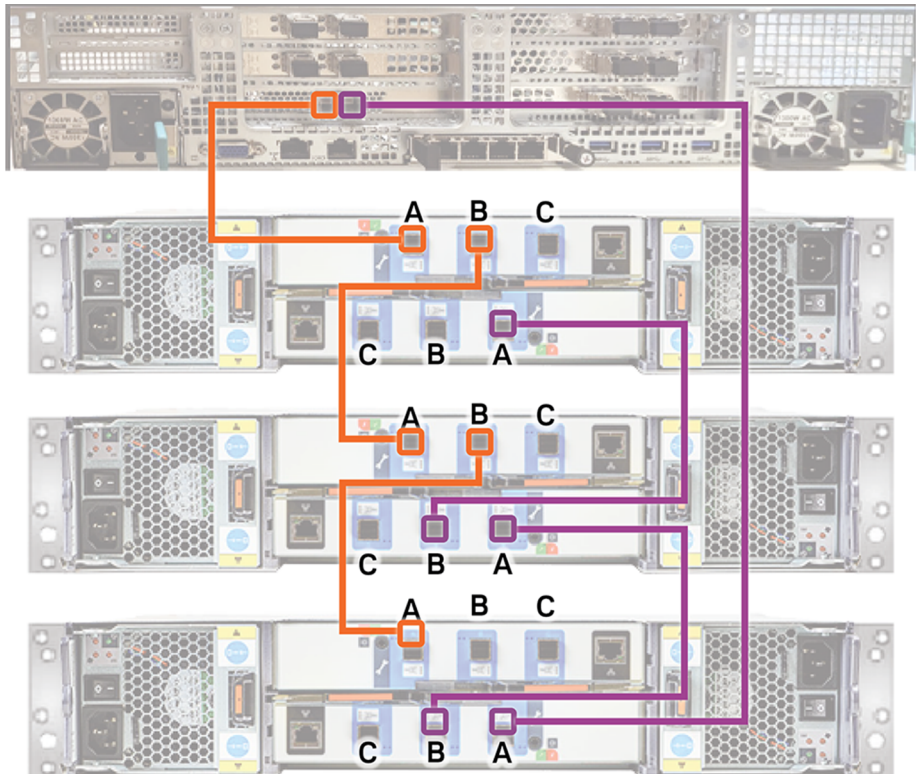

- 4 In a four-shelf configuration, verify that all cables are installed as shown.

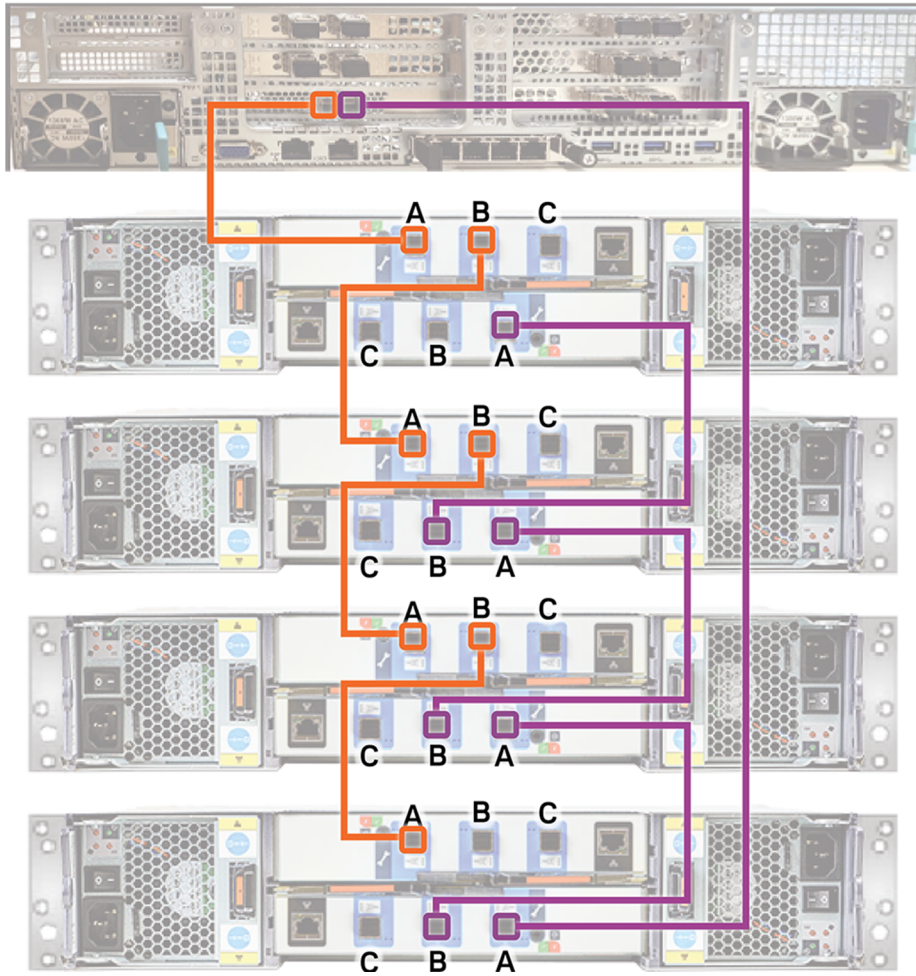

- 5 In a five-shelf configuration, verify that all cables are installed as shown.

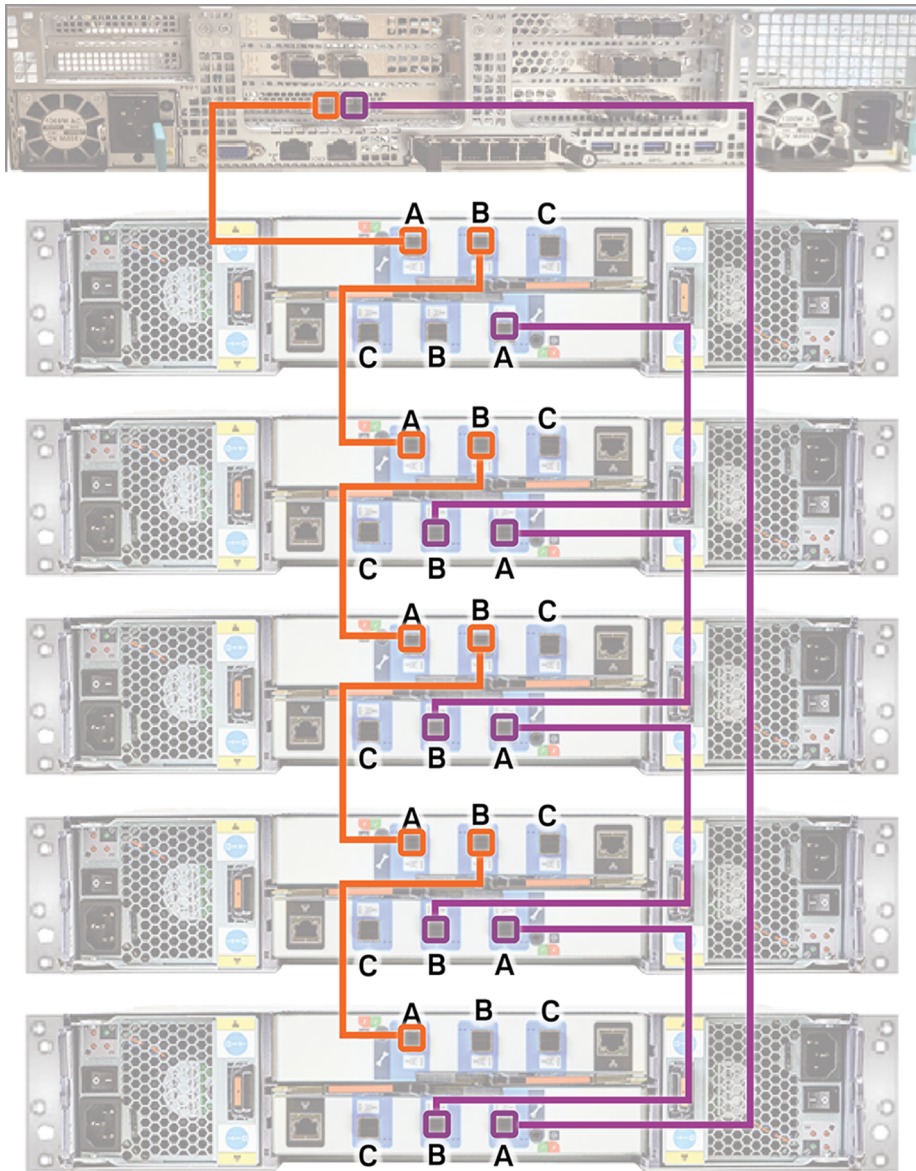

- 6 In a six-shelf configuration verify that all cables are installed as shown.

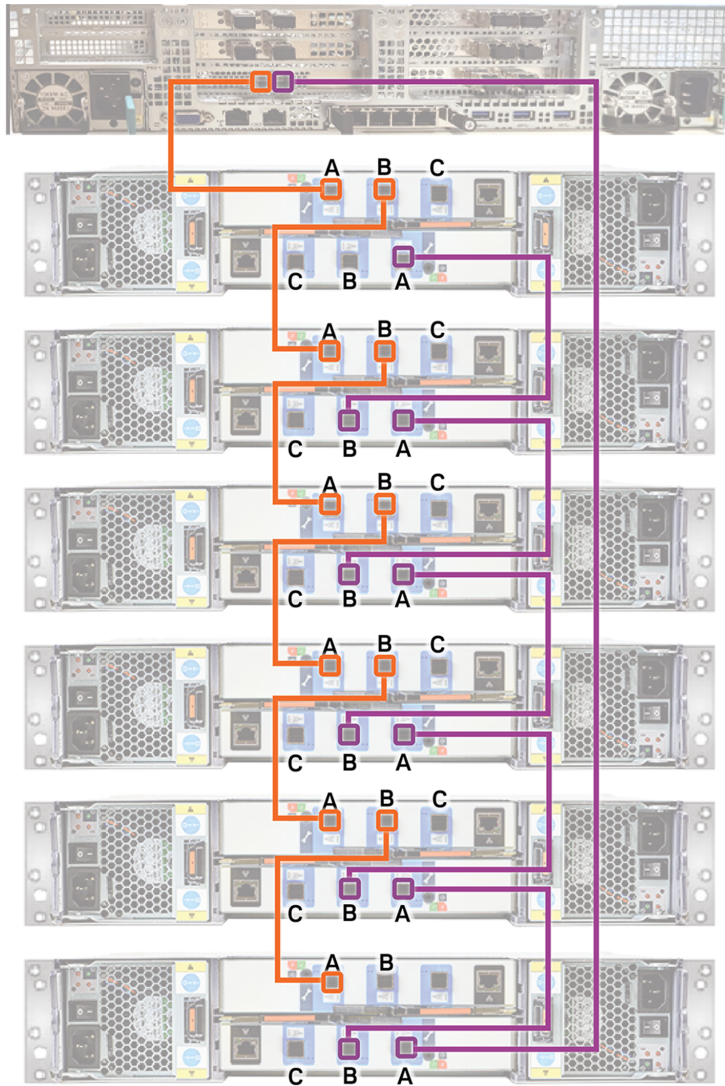

See [“Connecting the network cables”](#) on page 48.

See [“Connecting the power cords”](#) on page 49.

Next steps after installation

This chapter includes the following topics:

- [Connecting the network cables](#)
- [Connecting the power cords](#)
- [Turning on the hardware and verifying operation](#)
- [Configuring the Veritas Remote Management Interface from a Flex Appliance](#)
- [Accessing and using the Veritas Remote Management interface](#)

Connecting the network cables

The networking ports are accessed on the rear panel of the device. The remote management port is for use by Veritas Technical Support staff or by approved field service technicians.

The following picture shows the layout of the network ports. It includes the four 10 Gb Ethernet ports on the right.

The remote management (IPMI) port is located to the left of the 10 Gb Ethernet ports.



In a Flex appliance, by default, host0 is factory set to IP address 192.168.229.233. This private network address is reserved to provide a direct connection from a laptop to perform the initial configuration. host0 is typically not connected to your network environment during initial configuration.

In a Flex appliance, by default, host0 is used to perform all the network management after the configuration is complete.

Once the initial configuration has been completed, you can connect host0 to an administrative network that does not provide any backup data transfer.

Note: You cannot bond the copper 10 GbE ports that are installed in the appliance chassis with optical ports on PCIe 10/25 GbE cards.

See [“Connecting the power cords”](#) on page 49.

Connecting the power cords

Each appliance and each storage shelf contains two AC power supplies. To ensure power redundancy, connect the power supplies on each component to separate AC power sources.

Caution: Do not turn on the power to any components while connecting the power cords. The components must be turned on in a specific sequence to ensure correct communication.

To connect the power cables

- 1 Verify that the AC power supply input for the appliance and for the storage shelf is within one of these ranges.
 - 100 - 127 VAC at 50/60 Hz

- 200 - 240 VAC at 50/60 Hz
- 2 For each device, obtain two power cords that are appropriate for your region and equipment.
 - 3 Connect one cable to one PDU strip.
 - 4 Connect the other cable to the other PDU strip.

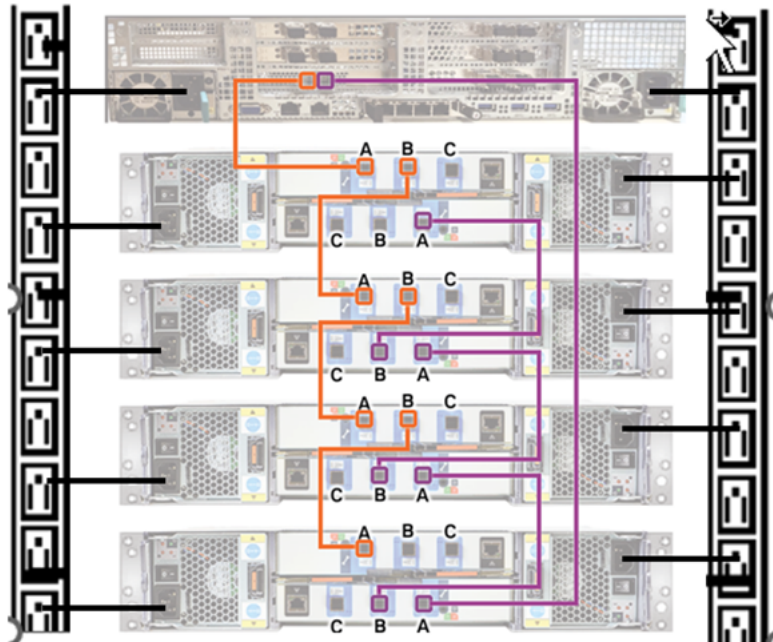

Turning on the hardware and verifying operation

The appliance and the storage shelves must be turned on in a specified order. If the hardware is not turned on correctly the appliance RAID controller may not recognize some storage units.

To turn on the storage shelves



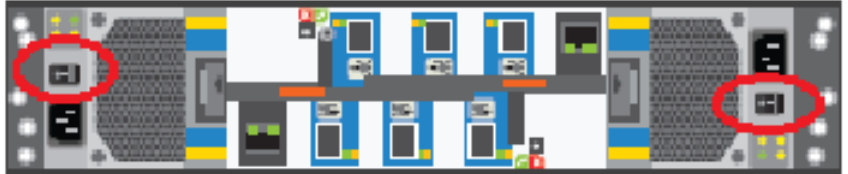

- 1 Start with the storage shelf that is farthest from the appliance.
- 2 Flip on the power switches on each power supply on the rear of the shelf.

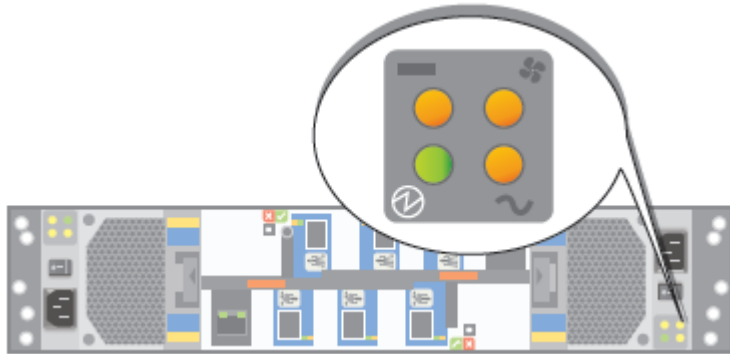

- 3 Verify that the power LED on each power module is green.



The LEDs are explained in the following table.

LED	Description
	Green = power module ok
	Amber = AC power fault
	Amber = Fan fault
	Amber = DC fault

The following table provides LED status details about the fans, AC and DC power, and the power cooling modules (PCMs).

Status	PCM Ok (Green)	Fan fault (Amber)	AC power fault (Amber)	DC power fault (Amber)
No AC power in either PCM	Off	Off	Off	Off
No AC power in a specific PCM	Off	Off	On	On
AC power present in a PCM	On	Off	Off	Off
PCM fan out of tolerance	On	Off	Off	On
PCM fault (over temp., over voltage, over current)	Off	On	On	On
PCM fan has failed	Off	On	On	On
Standby mode	Flashing	Off	Off	Off
PCM firmware download	Off	Flashing	Flashing	Flashing

4 Locate the LEDs on each I/O module canister.

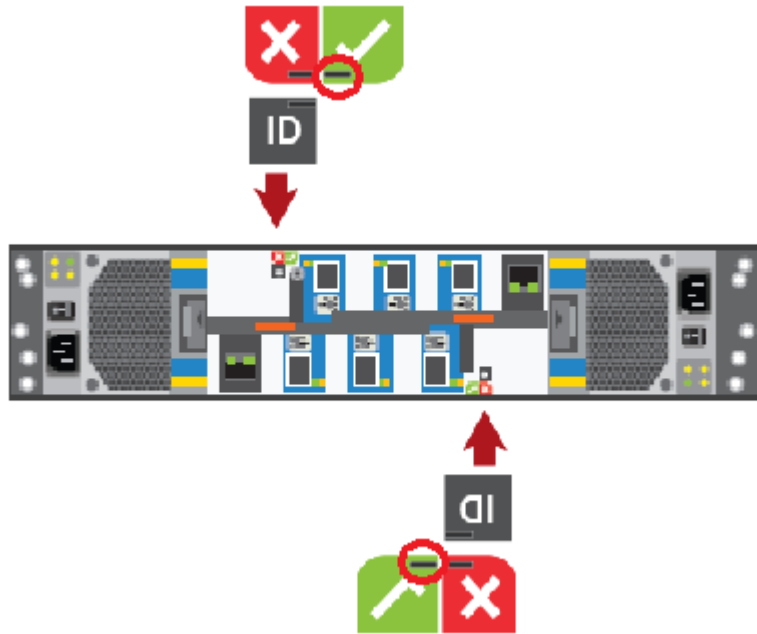

LED indications are as follows.

- The LED in the red area with the white X-mark indicates an I/O module canister fault when the LED is amber.
- The LED in the ID area is blue when each module is identified.
- The LED in the green area with a white checkmark is green when functions are normal.

5 Locate the SAS port LEDs.

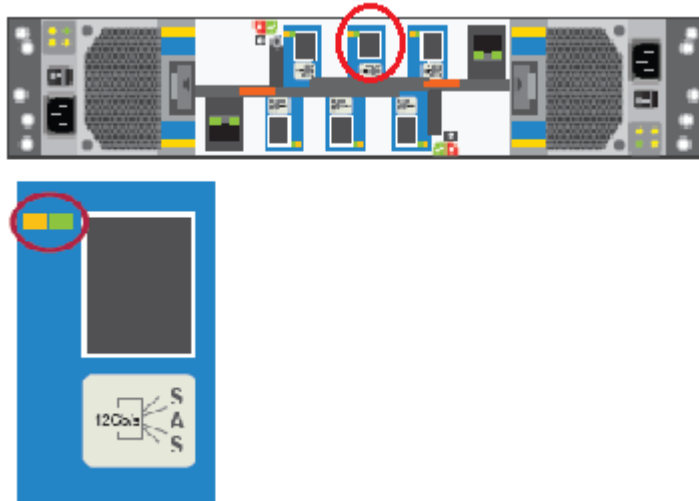

Note: The illustration shows the LEDs for port B in the top I/O module. The LEDs for all six ports are the same.

The Fault LED is farthest from each SAS port.

The Activity LED is closest to each SAS port.

The following table describes the SAS port LEDs. The combination of both LEDs provides the status.

Status	Activity (green) LED	Fault (amber) LED
No cable present	Off	Off
Cable present, no activity	On	Off
Cable present, all links active	Blinking if one or more disk drives are active.	Off
Critical fault	Off	On
Non-critical fault	Blinking if one or more disk drives are active.	Blinking at a rate of one second on, and one second off.

6 Move to the front of the storage shelf.

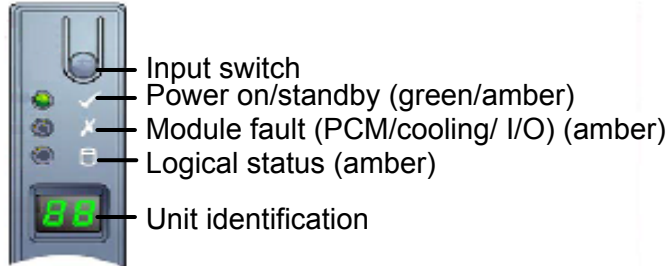

- Verify that the Power on/standby LED is green.
- If the Power LED or the other two LEDs are amber, escalate the issue.
- The input switch is used to set the Unit identification (ID). The display is a seven-segment display. You can reset the ID number. The values “01” to “99” are valid. The value “00” is reserved. “00” is also the default value.
 - Press the input switch and hold it down for five seconds.
 The switch enters a programming mode. The digit on the left side of the display begins to flash first. The flashes appear on for 0.5 seconds and off for 0.5 seconds.
 - Press the input switch once to increment the number by one digit.
 - When your first required number is reached press the switch for five seconds.
 The first number is now locked.
 - Set the second number in the same manner that you set the first number.
 If you do not want to set a second number press and hold the input switch for five seconds.
 The number “0” displays.

- 7 Locate the LEDs on each disk drive carrier.

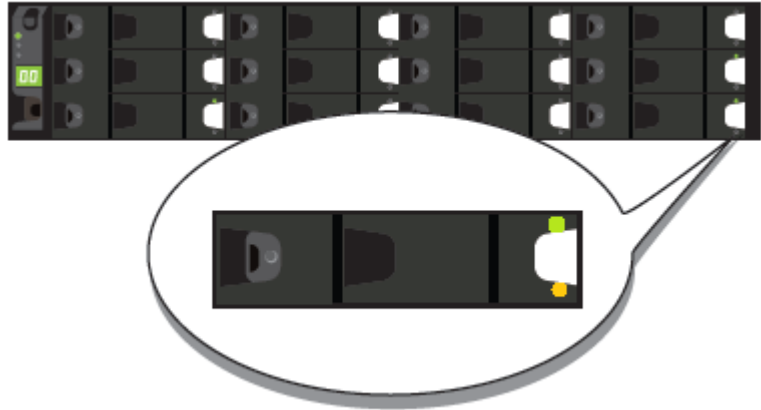

The following table describes the disk drive carrier LEDs. The combination of both LEDs provides the status.

Status	Activity (green) LED	Fault (amber) LED
No disk drive installed.	Off	Off
Drives are installed, turned on, and operational.	Blinks during I/O activity and during startup.	Off
Device identity.	On	Blinks at a rate of one second on and one second off.
Drive slot fault.	Off	On
Drive fault. Power control circuit fault.	On	On
Possible drive fault.	On	Blinks at a rate of one second on and one second off.

- 8 Repeat these steps for each storage shelf. Let each shelf initialize before you turn on the next shelf. Initialization should take 2 minutes to 3 minutes.

- 9 When all of the storage shelves are operational, turn on the appliance.

When all of the storage shelves are operational, turn on the appliance.

To turn on the appliance

Note: Before you turn on the appliance, ensure that you have connected a standard video cable and keyboard to the appliance so that you can configure the remote management interface after the appliance is turned on.

- 1 Verify that all connected storage shelves function correctly. Use the LED information in the procedure that explains how to turn on the storage shelves.
- 2 On the front, right, side of the appliance press the Power button.



- 3 Verify that the bottom LED in all 12 disk drive slots are green.



The following table provides details of the appliance disk drive LEDs.

LED	States	Description
1-Status LED, Top	Off	No disk fault
	Solid amber	Disk fault
	Blinking amber	A RAID rebuild is in progress
2-Activity LED, Bottom	Off	Power is on and the disk has spun down
	Solid green	Power is on but there is no disk activity
	Blinking green	Power is on and the disk is spinning up
	Blinks green occasionally	Commands are processing

Configuring the Veritas Remote Management Interface from a Flex Appliance

- 4 On the bottom, left, rear of the appliance verify that the LED on each power supply is green.



- 5 Proceed to the next section to configure remote management.

Configuring the Veritas Remote Management Interface from a Flex Appliance

Veritas Flex Appliance release does not support configuring the IPMI port through the Flex Appliance Shell.

To configure the dedicated Veritas Remote Management Interface (IPMI) LAN settings in the BIOS

- 1 Connect a standard video cable between the VGA (Video Graphics Array) port and the computer monitor
- 2 Connect a keyboard to a USB port at the rear of the Flex 5260 appliance.
- 3 Ensure that the power cords are connected.

- 4 The prompt about accessing the BIOS at the beginning of the startup cycle appears. Wait until the Veritas logo shows up and press **F2** to enter the initial BIOS setup screen. The initial setup dialog box appears and prompts you.



Warning: When you are in the BIOS, do not perform any other steps other than the ones mentioned in this section.

Note: If you miss the initial setup dialog box prompt in step 4, the appliance shell appears. Shut down and restart the appliance and try accessing the BIOS menu again.

The **Setup Menu** page appears and the **Main** menu option should be highlighted.

Configuring the Veritas Remote Management Interface from a Flex Appliance

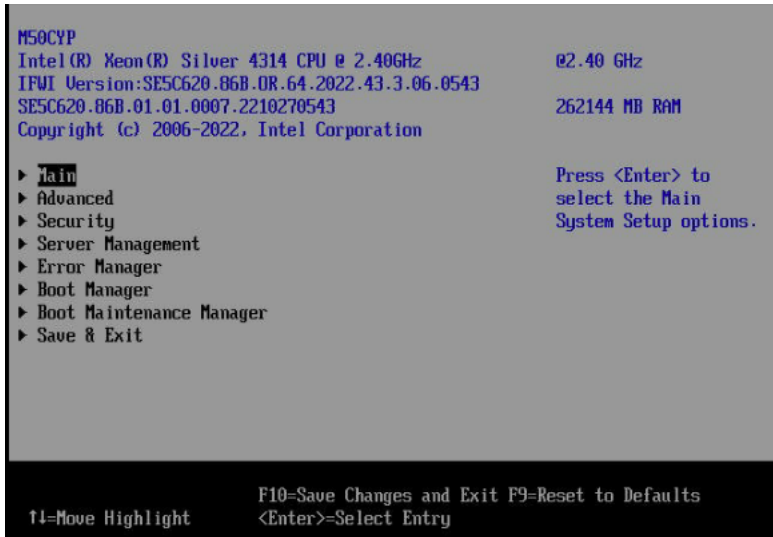

- 5 Use the down key on the keyboard and navigate to the **Server Management** menu option. Press **Enter**.
- 6 Press the up or down key on the keyboard to navigate to **BMC LAN Configuration**. Press **Enter**.

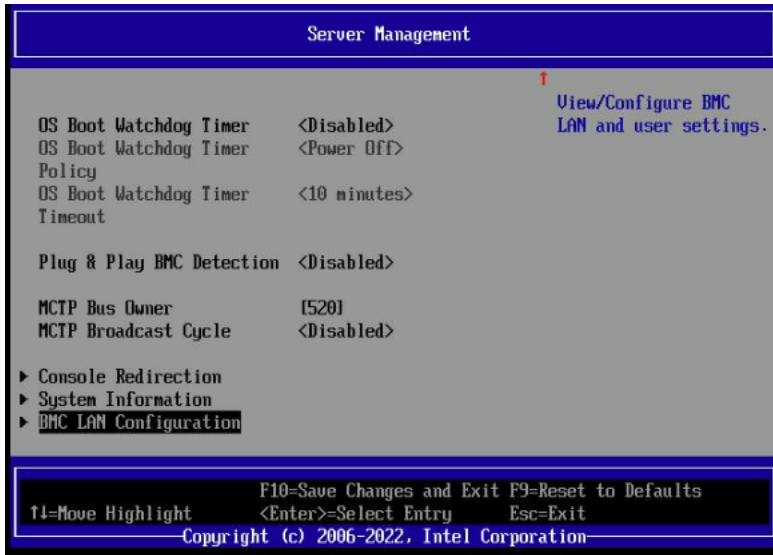

- 7 The **BMC LAN Configuration** options screen appears.

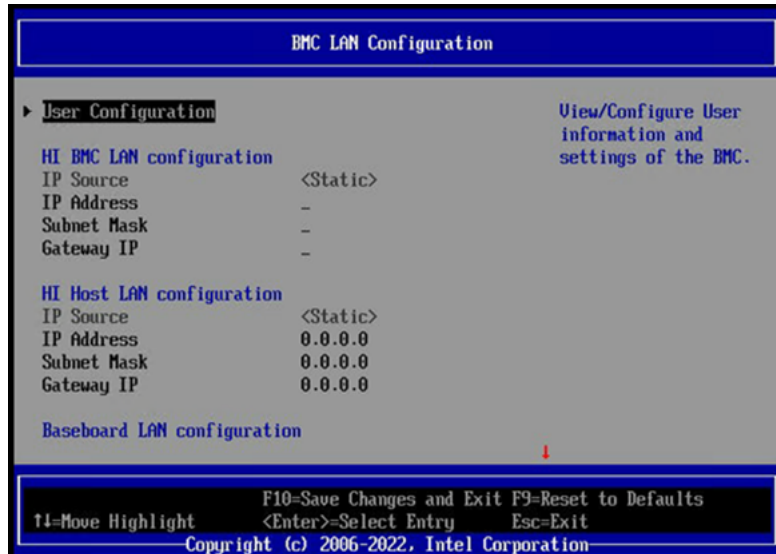

- 8 Press the down arrow key on the keyboard to navigate to the **Dedicated Management LAN Configuration** option. Use the information supplied by the customer to fill in the following fields: IP Source, IP address, Subnet mask, Gateway IP.

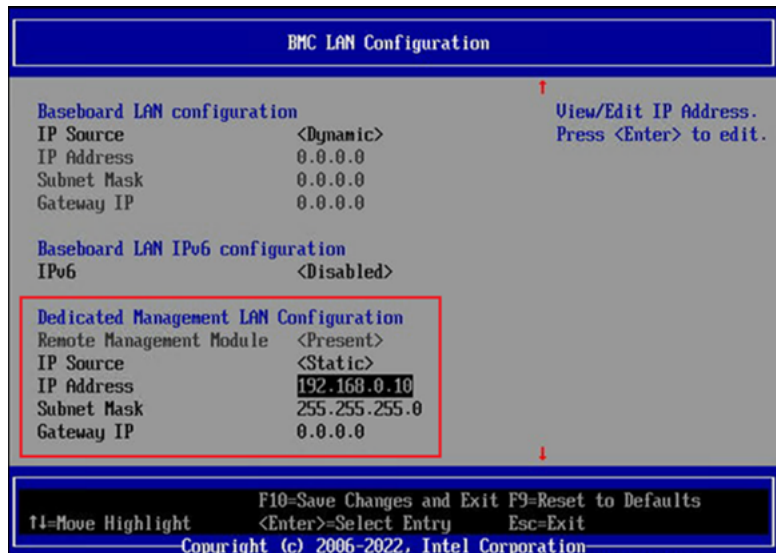

- 9 To save your BIOS changes, press **F10**.

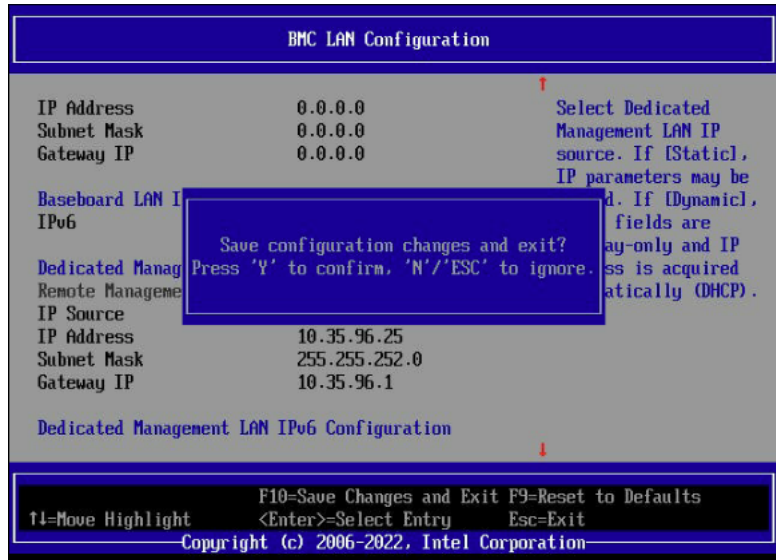

- 10 Press **Y** to save and exit. The appliance restarts itself.

Accessing and using the Veritas Remote Management interface

The IPMI web interface is known as Veritas Remote Management interface. You can use Veritas Remote Management interface to log on to the appliance shell.

Before you use the remote management interface, the following prerequisites must be met:

- The Remote Management interface (IPMI port) must first be configured.
- At least one power cable must be connected to a functioning power source.
- At least one user must be enabled to use the LAN channel(s).

Note: A default user is configured in the system. The default user name is **sysadmin**. The default password is **P@ssw0rd**, where 0 is the number zero.

To access and use the Veritas Remote Management web interface from a remote computer

- 1 Log on to a remote computer in the network and open a supported Windows browser.
- 2 Enter the remote management (IPMI) port IP address (https://) that is assigned to the remote management port. The following page appears:



- 3 Enter your login credentials. The default user name is **sysadmin**. The default password is **P@ssw0rd**, where **0** is the number zero.

Click **Login**.

- 4 Click the **Remote Control** section located at the top of the page. The **Remote Control** section lets you remotely monitor and control the server.

Do **one** of the following to launch the Flex Appliance Shell:

- Click **Launch iKVM over HTML5** to launch the Appliance shell. A new window opens that enables you to remotely monitor and control the appliance.
- Click **Remote Control > KVM/Console Redirection** . Click **Launch Console** to launch the appliance shell menu.

A JViewer application opens that enables you to remotely monitor and control the appliance.

This application requires Java Runtime Environment (JRE) version 8.0 or later. Install Java. You can login to the JViewer application using the same user name and password from step 3

Google Chrome 73.0.3683.86 and Mozilla Firefox 66.0.2 or later versions are supported

- 5** You can now access and log on to the Flex Appliance Shell.

By default, the user name `hostadmin` has the password, `P@ssw0rd` where 0 is the number zero.

Type "?" and then enter the "system" command to actually see the list of available commands.

Adding one or more storage shelves to an operating appliance that does not have any storage shelves

This appendix includes the following topics:

- [Overview](#)
- [Preparing the appliance](#)
- [Removing the appliance cover](#)
- [Installing the Expansion Storage Kit components](#)
- [Replacing the appliance cover](#)
- [Connecting the storage shelves to the appliance](#)

Overview

Several procedures are involved in the process of adding one or more storage shelves to an existing appliance that does not have any storage shelves. New components inside the chassis are required as described in this appendix.

An appliance that does not have storage shelves needs additional components to support the external storage shelves.

The 5260 Expansion Storage Kit contains the following required hardware components:

- Eight, 32Gb, Dual in-line memory modules (DIMMs)

The procedures in this appendix explain the tasks which are required to be performed to add one or more storage shelves.

These tasks must be performed in the order that is provided.

- Preparing the appliance
See [“Preparing the appliance”](#) on page 68.
- Removing the appliance cover
See [“Removing the appliance cover”](#) on page 69.
- Installing the Expansion Storage Kit components into the appliance
See [“Installing the Expansion Storage Kit components”](#) on page 70.
- Replacing the appliance cover
See [“Replacing the appliance cover”](#) on page 79.
- Installing the storage shelves rack rails
See [“Installing the storage shelf rack rails”](#) on page 30.
- Installing one or more storage shelves into a rack
See [“Installing the storage shelf into a rack”](#) on page 32.
- Installing the appliance into the rack
See [“Installing the appliance into a rack”](#) on page 37.
- Understanding appliance and storage shelf connections
See [“Understanding appliance and storage shelf connections”](#) on page 38.
- Connecting the appliance to the storage shelves
See [“Connecting the storage shelves to the appliance”](#) on page 80.
- Connecting the network cables
See [“Connecting the network cables”](#) on page 48.
- Connecting the power cords
See [“Connecting the power cords”](#) on page 49.
- Turning on the appliance and verifying operation
See [“Turning on the hardware and verifying operation”](#) on page 50.

Preparing the appliance

Best practices recommend removing the appliance from the rack to access the inside of the chassis. Alternatively you can either pull out the appliance on its rails. Be sure that the appliance and rack are stable.

Turn off the appliance properly and disconnect it from AC power sources. A soft shutdown informs the appliance operating system to stop and close all active processes. After the operating system stops all of the processes, the appliance turns itself off.

Warning: Never turn off the appliance by using the power button on the control panel. Using the power button to turn off the appliance can cause data loss or corruption.

To perform a soft shutdown of the appliance

- 1 Log on to the Flex Appliance Shell Menu.
- 2 Enter `system shutdown`.
- 3 Verify that the appliance is completely turned off. All LEDs are off. Fans are not running.
- 4 Remove the power cords that connect the appliance to the rack Power Distribution Units (PDUs).

The following procedure explains the process of removing the appliance from the rack.

To remove the appliance from the rack

- 1 Verify that the appliance is off and that the power cords have been disconnected from the power sources.
- 2 Remove the front bezel of the appliance.
- 3 Locate and unscrew the two screws behind the flap on the front panel that secure the appliance to the rack.



- 4 Slide the chassis fully forward out of the rack until the rail guides lock.

- 5 With the rails fully extended and locked, locate the blue tabs at the front of the rail assemblies.
- 6 With a person on each side, place a hand underneath the unit.
- 7 Pull the blue tabs back to release the front studs in the chassis rails.
- 8 Lift the front end to release the front studs from the cutouts in the guide rails.
- 9 Place your free hands under the back of the chassis for support.
- 10 Pull the appliance straight out of the rack.
- 11 Lift the appliance and place it on a secure surface.

Removing the appliance cover

The system ships from the factory with the front system cover and back system cover screwed to the chassis. A total of four screws, one on each side of the front cover and one on each side of the back cover, need to be removed to detach each top cover panel from the chassis.



Note: This service will require the removal of the front panel.

Use the following procedures to remove the cover from the appliance.

To remove the appliance cover panels

- ◆ For each top cover panel:
 - While pushing down on both the left and right buttons of the given top panel (see Letter A), slide the top cover panel towards the front (front panel) or back (back panel) of the chassis (see Letter B).

- Carefully lift the top cover panel up and away from the chassis.

Note: Each top cover panel can slide along the chassis base for 10 mm and then needs to be lifted.

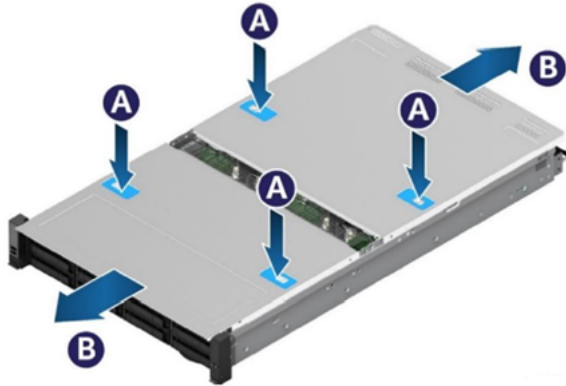

Installing the Expansion Storage Kit components

This section explains the process of installing the components of the Expansion Storage Kit into the appliance.

The expansion storage kit contains eight, 32Gb, Dual in-line memory modules (DIMMs)

Caution: Veritas service personnel must perform all tasks that involve the inside of the appliance chassis.

To replace the DIMMs

- 1 Put on a grounded ESD-compliant wrist strap or take other ESD-preventive measures.

Note: The static discharged by human bodies can damage static-sensitive components on the boards. When installing and maintaining the equipment, you must observe appropriate electrostatic safety precautions to prevent personnel injuries or device damage.

- 2 Remove the air duct that covers the DIMM slots as follows:

- Disconnect the cable from the external maintenance free backup unit (MFBU) holder.

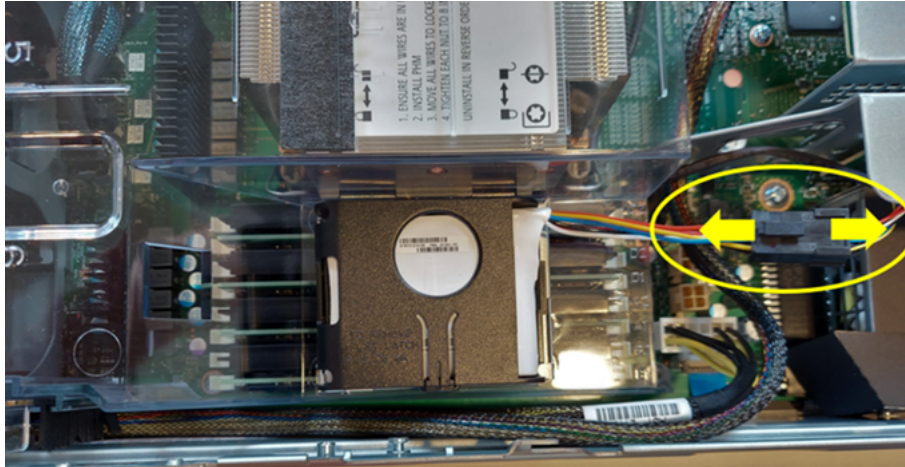

- Ensure that all the cables are clear of the air duct.
- Lift the front edge of the air duct slightly to separate the alignment pins from the fan cage (see Letter A).
- Lift the back edge of the air duct to separate the alignment pins on the chassis from the holes on the back corners of the air duct (see Letter B).
- Lift the air duct straight up and remove it from the system.

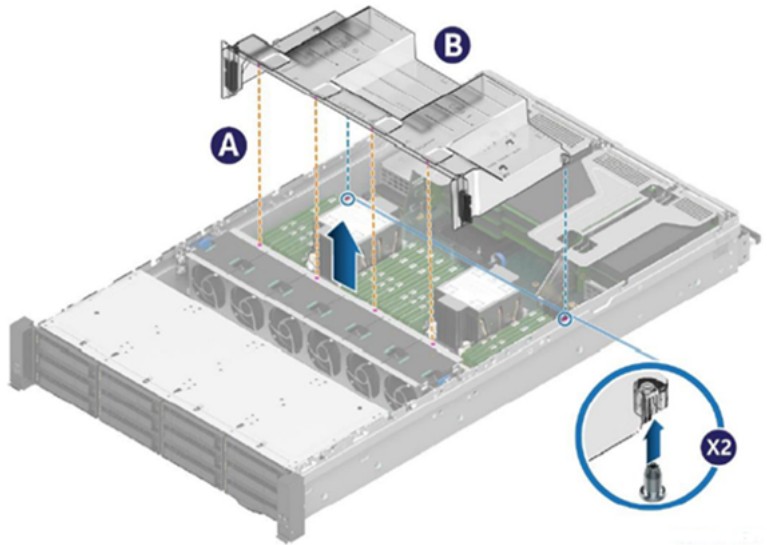

- 3 Locate the DIMM slots next to the CPUs on the server board. The DIMMs on the appliance server board are located near the CPUs.

Each DIMM slot has a silkscreen identifier on the board that consists of a two-digit alphanumeric number. These indicators are also located on the back edge of the air duct.

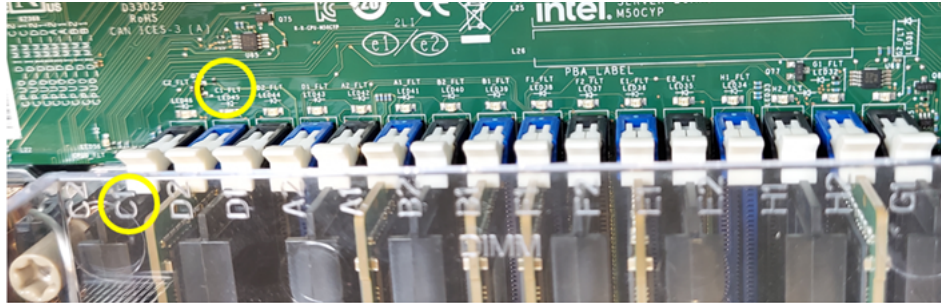

The number indicates the channel and slot for which the DIMM provides support. Slot identifiers have the format A1, A2, B1, B2, C1, C2, etc., where the letter indicates the channel and the number indicates the slot. Look for the identifier on the mainboard near the socket.

The following diagram shows the configuration of the DIMM sockets as viewed from the front of the appliance. The fans are located between the DIMMs and the front of the appliance.

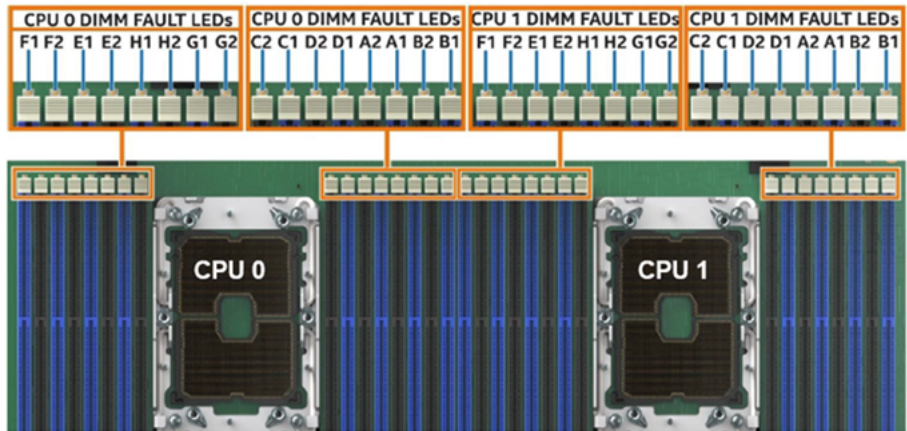

Front of the Appliance

The following table shows the configuration of the DIMMs.

DIMM population for Veritas Appliances																																	
DIMM slots as viewed from front of appliance	CPU 0						CPU 1						Total Memory (GB)																				
	F1	F2	E1	E2	H1	H2	G1	G2	C2	C1	D2	D1		A2	A1	B2	B1	F1	F2	E1	E2	H1	H2	G1	G2	C2	C1	D2	D1	A2	A1	B2	B1
5260 server only			8					8											8					8									64
5260 + storage shelf			32					32						32					32					32						32			256
5260 ≥ 5 shelves	32		32		32		32			32		32		32			32		32		32		32			32		32		32		512	

- 4 Locate the DIMM chip or DIMM chips that you want to remove.

- 5 Open the retaining clips at each end of the socket.

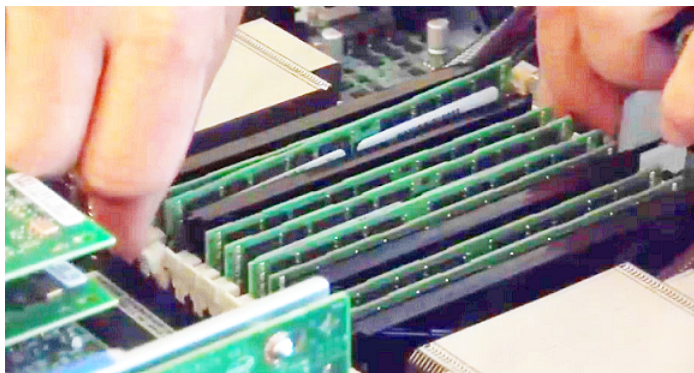
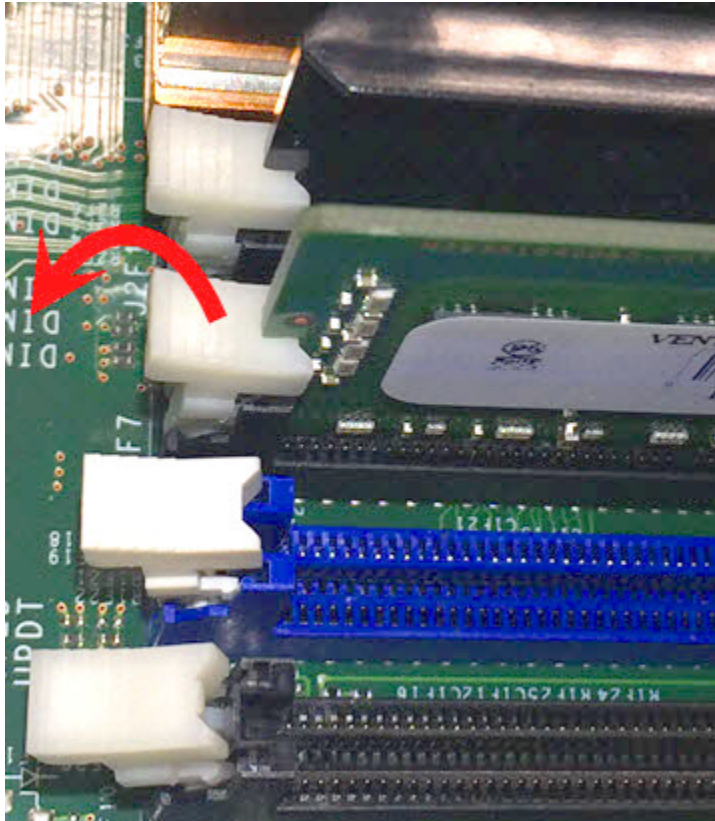

- 6 Hold the DIMM by the edges and lift it from the socket.

Caution: Always hold the edges of the DIMM. Do not touch the front or the back of the DIMMs.

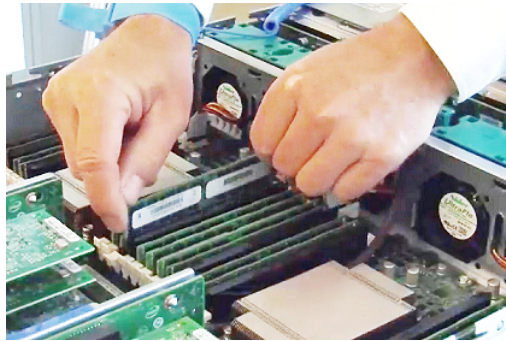

- 7 Place the DIMM in an ESD-protective bag.

Caution: If you must place more than one DIMM in an ESD-protective bag, be sure that the edge connectors do not touch.

- 8 Repeat these steps for each DIMM that you need to remove.
- 9 Install the replacement DIMM as follows:
 - Make sure that the retaining clips on the socket in which you want to install the DIMM are open.
 - Locate the gap in the connector edge of the DIMM as shown in the image below.



- Locate the key in the DIMM socket, and orient the DIMM over the socket so that the notch in the bottom edge of the card and the key in the socket align.

Caution: Always hold the edges of the DIMM. Do not touch the front or the back of the DIMM chips. Do not touch the front or the back of the DIMM chips.

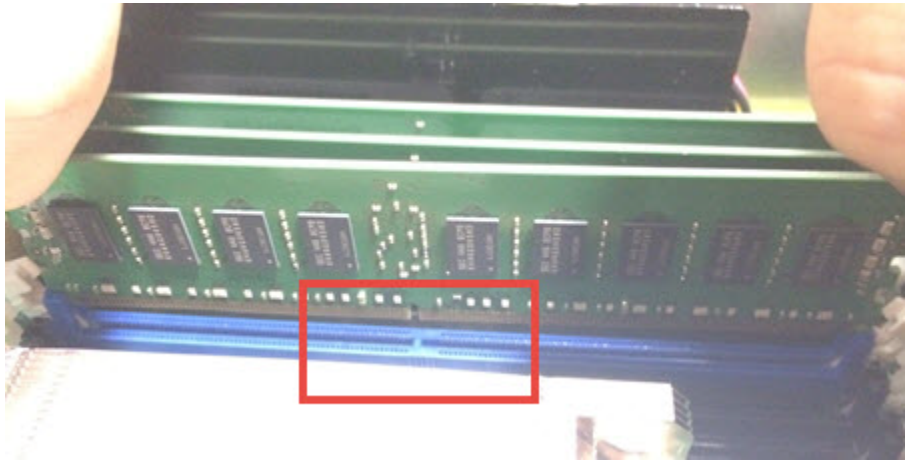

- Align the edges of the DIMM memory module with the grooves in the posts at both ends of the socket.
- Insert the DIMM memory module in the socket grooves and push down evenly and firmly until the retaining clips snap into place. Make sure that the memory module is firmly in place.

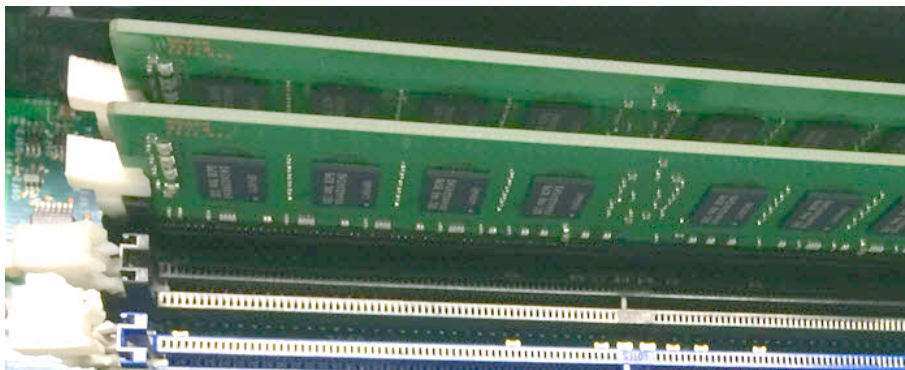

- 10 Repeat step for each DIMM that you need to replace.
- 11 Check each DIMM to make sure that it is seated in the slot properly.
- 12 Replace the air duct as follows:
 - Ensure that all cables are clear of the air duct keep out area on the base of the chassis.
 - Align and latch the two alignment pins to the matching holes on the back corners of the air duct (see Letter A).

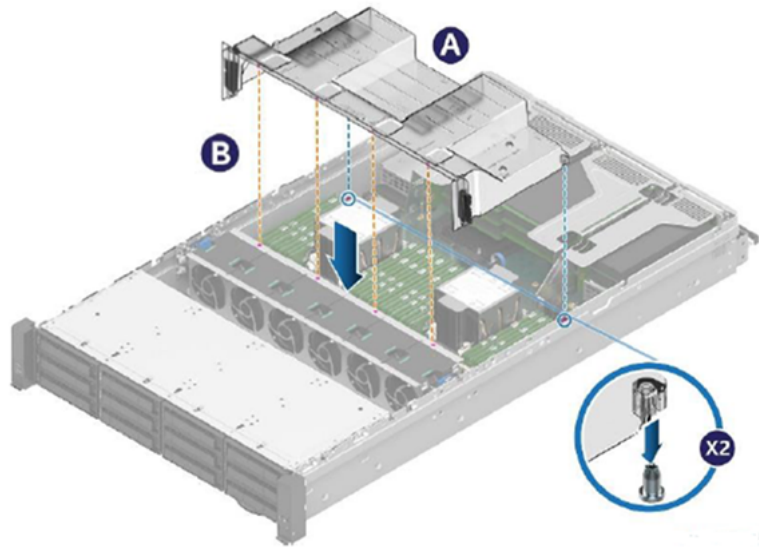

- Lower the front edge of the air duct until it touches the fan cage (see Letter B).
- Ensure that the alignment pins on the front edge of the air duct align and go into the holes on the top of the fan cage.
- Reconnect the cable to the external maintenance free backup unit (MFBU) holder.

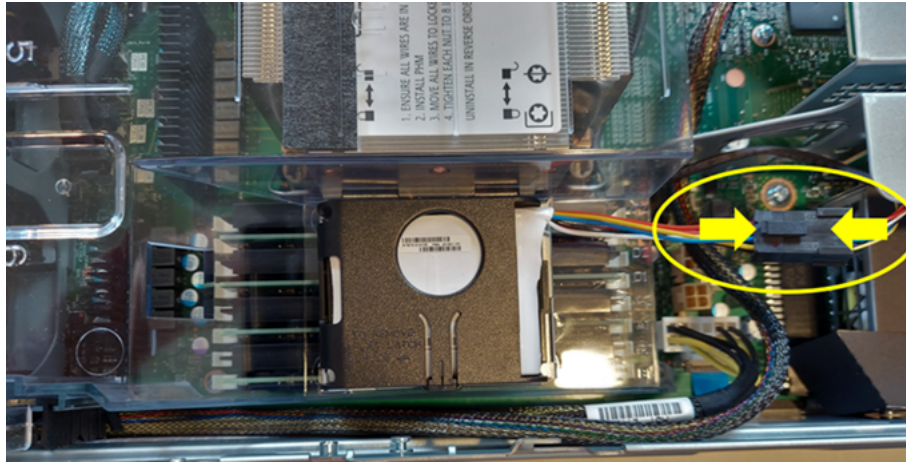

Replacing the appliance cover

Use the following procedure to replace the appliance cover.

To replace the appliance cover panels

- ◆ For each top cover panel:

Carefully align and set the top cover panel on top of the chassis. Then, slide it inwards until it locks into place (see Letter A).

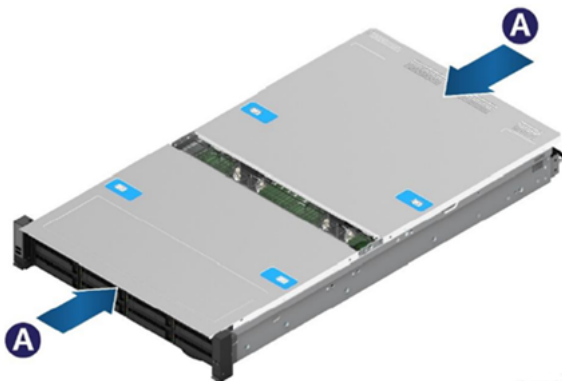

Connecting the storage shelves to the appliance

Select one of the following sections that describe the complete connection of one, two, three, four, five or six shelves.

See [“Connecting one storage shelf to an appliance”](#) on page 80.

See [“Connecting two storage shelves to an appliance”](#) on page 82.

See [“Connecting three storage shelves to an appliance”](#) on page 84.

See [“Connecting four storage shelves to an appliance”](#) on page 87.

See [“Connecting the fifth storage shelf to an appliance”](#) on page 90.

See [“Connecting the sixth storage shelf to an appliance”](#) on page 93.

Note: The appliance server needs to be powered off when adding any storage shelves to an existing appliance installation.

Connecting one storage shelf to an appliance

Note: The cables in the following diagrams are shown in different colors for demonstration purposes only. The actual cables are black.

Note: The orientation of the blue tabs on the ends of the SAS-3 cables is important. In the appliance, the blue tabs on each SAS-3 connector must face down.

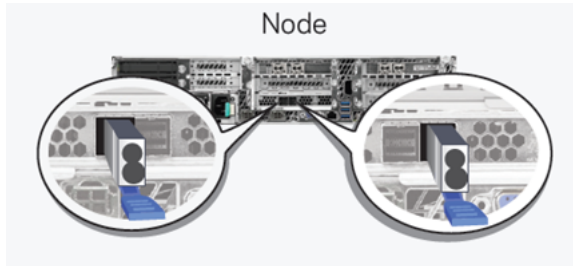

In the storage shelves, the blue tabs in the SAS-3 connectors should point to the 12 Gb/s SAS label near each port. The blue tabs on the SAS-3 connectors inserted into the top row must face down. The blue tabs of the connectors inserted into the bottom row must face up.

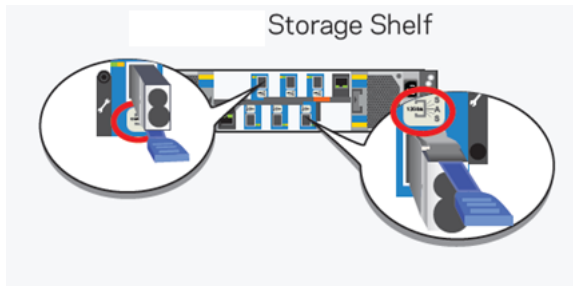

To connect one storage shelf to the appliance

- 1 Connect a SAS-3 cable to the left RAID port in the appliance.
- 2 Connect the other end of the cable to port A in the top I/O module of the storage shelf.
- 3 Attach another SAS-3 cable between port A on the bottom I/O module and the right port on the appliance RAID card.

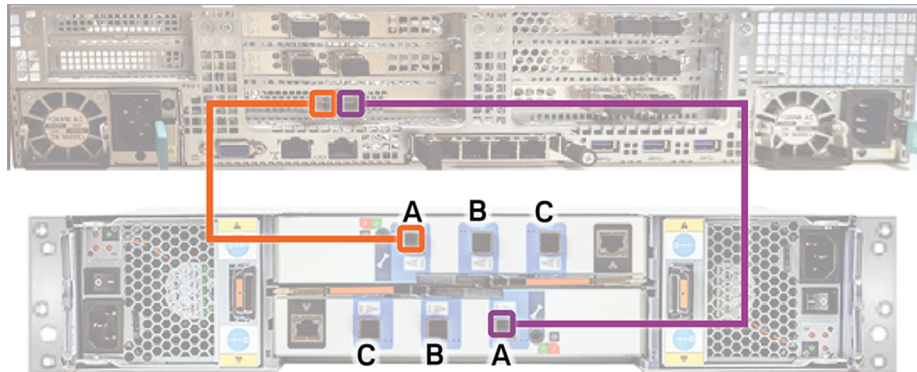

Next, connect network and power cables. Turn on the storage shelves and the appliance per the required sequence. Verify that all units function correctly.

See [“Connecting the network cables”](#) on page 48.

See [“Connecting the power cords”](#) on page 49.

See [“Turning on the hardware and verifying operation”](#) on page 50.

Connecting two storage shelves to an appliance

Note: The cables in the following diagrams are shown in different colors for demonstration purposes only. The actual cables are black.

Note: The orientation of the blue tabs on the ends of the SAS-3 cables is important. In the appliance, the blue tabs on each SAS-3 connector must face down.

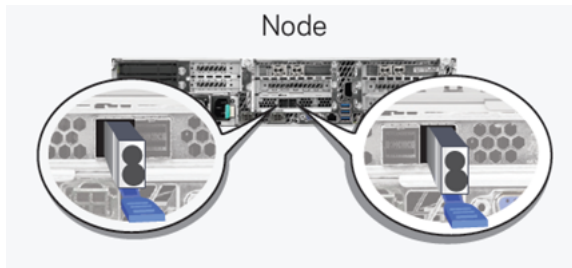

In the storage shelves, the blue tabs in the SAS-3 connectors should point to the 12 Gb/s SAS label near each port. The blue tabs on the SAS-3 connectors inserted into the top row must face down. The blue tabs of the connectors inserted into the bottom row must face up.

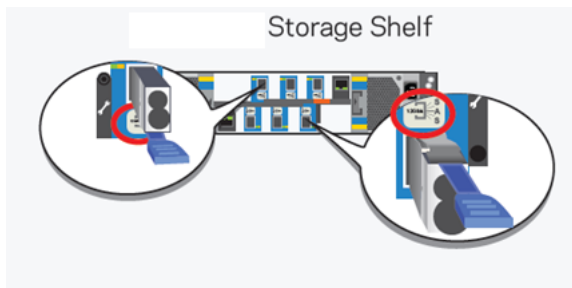

To connect two storage shelves to the appliance

- 1 Connect a SAS-3 cable to the left RAID port in the appliance.
- 2 Connect the other end of this cable to port A in the top I/O module of the storage shelf.
- 3 Connect another SAS-3 cable to port B in the top I/O module of the first storage shelf. Connect the other end of this cable to port A in the top I/O module in the second storage shelf.
- 4 In the bottom I/O module in the second shelf, connect a SAS-3 cable to port B.
- 5 In the bottom I/O module of the first shelf, connect the other end of the cable to port A.

- 6 In the bottom I/O module of the second shelf, connect another SAS-3 cable to port A.
- 7 Connect the other end of this cable to the right port in the RAID card in the appliance.

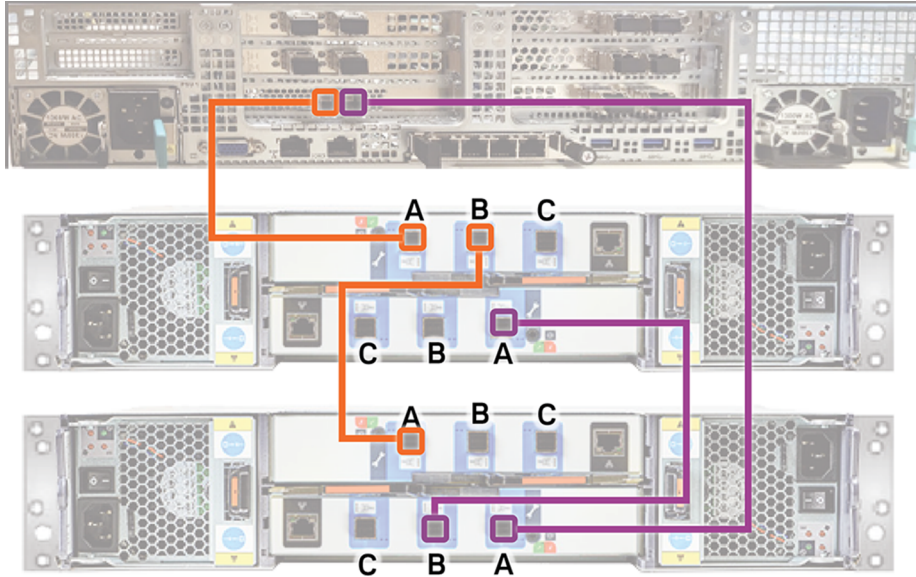

Next, connect network and power cables. Turn on the storage shelves and the appliance per the required sequence. Verify that all units function correctly.

See [“Connecting the network cables”](#) on page 48.

See [“Connecting the power cords”](#) on page 49.

See [“Turning on the hardware and verifying operation”](#) on page 50.

Connecting three storage shelves to an appliance

Note: The cables in the following diagrams are shown in different colors for demonstration purposes only. The actual cables are black.

Note: The orientation of the blue tabs on the ends of the SAS-3 cables is important. In the appliance, the blue tabs on each SAS-3 connector must face down.

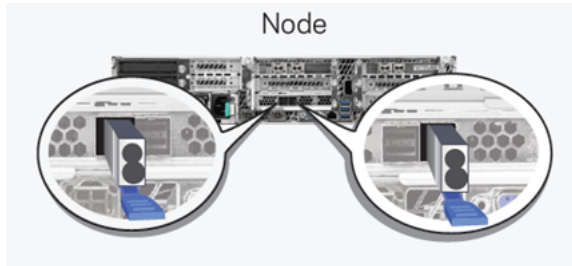

In the storage shelves, the blue tabs in the SAS-3 connectors should point to the 12 Gb/s SAS label near each port. The blue tabs on the SAS-3 connectors inserted into the top row must face down. The blue tabs of the connectors inserted into the bottom row must face up.

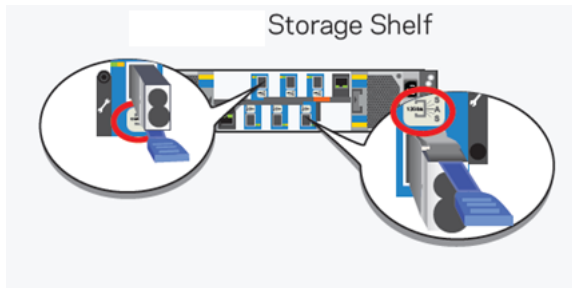

To connect three storage shelves to an appliance

- 1 Connect a SAS-3 cable to the left RAID port in the appliance.
- 2 Connect the other end of this cable to port A in the top I/O module of the storage shelf.
- 3 Connect another SAS-3 cable to port B in the top I/O module of the first storage shelf. Connect the other end of the cable to port A in the top I/O module in the second storage shelf.
- 4 Connect a SAS-3 cable to port B of the top I/O module in the second shelf. Connect the other end of the cable to port A in the top I/O module in the third shelf.
- 5 Connect a SAS-3 cable to port A of the bottom I/O module in the third shelf.

- 6 Connect the other end of the cable to the right port in the appliance RAID PCIe card.
- 7 Connect a SAS-3 cable from port B of the bottom I/O module in the third shelf to port A in the bottom I/O module in the second shelf.
- 8 Connect a SAS-3 cable to port B of the bottom I/O module in the second shelf. Connect the other end of the cable to port A on the bottom I/O module in the first shelf.

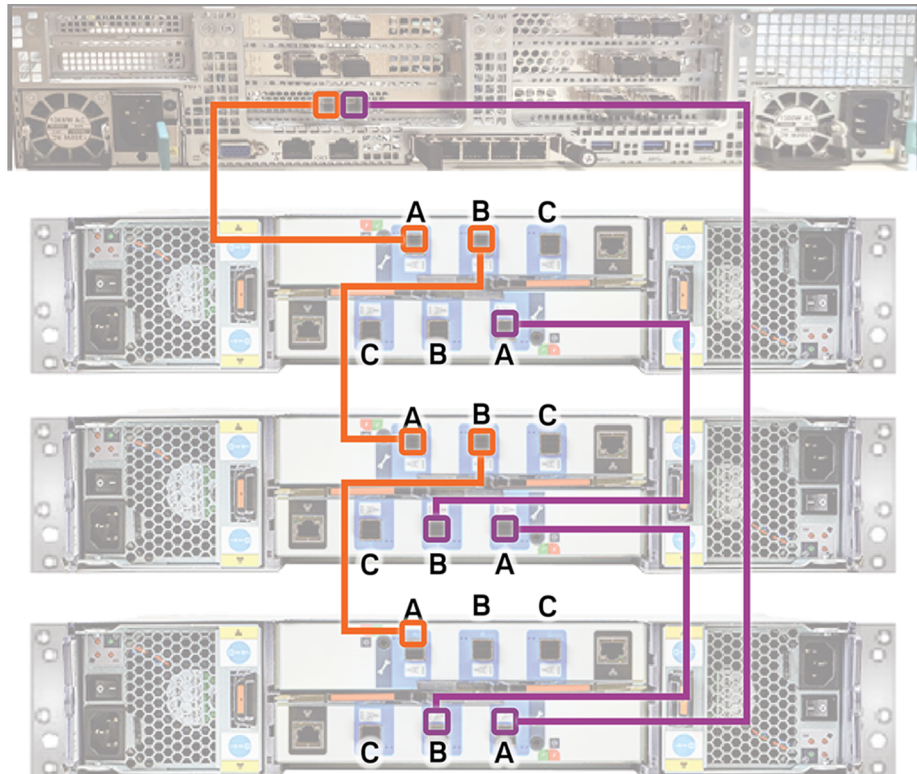

Next, connect network and power cables. Turn on the storage shelves and the appliance per the required sequence. Verify that all units function correctly.

See [“Connecting the network cables”](#) on page 48.

See [“Connecting the power cords”](#) on page 49.

See [“Turning on the hardware and verifying operation”](#) on page 50.

Connecting four storage shelves to an appliance

Note: The cables in the following diagrams are shown in different colors for demonstration purposes only. The actual cables are black.

Note: The orientation of the blue tabs on the ends of the SAS-3 cables is important. In the appliance, the blue tabs on each SAS-3 connector must face down.

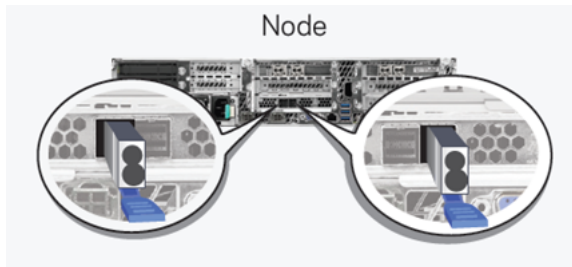

In the storage shelves, the blue tabs in the SAS-3 connectors should point to the 12 Gb/s SAS label near each port. The blue tabs on the SAS-3 connectors inserted into the top row must face down. The blue tabs of the connectors inserted into the bottom row must face up.

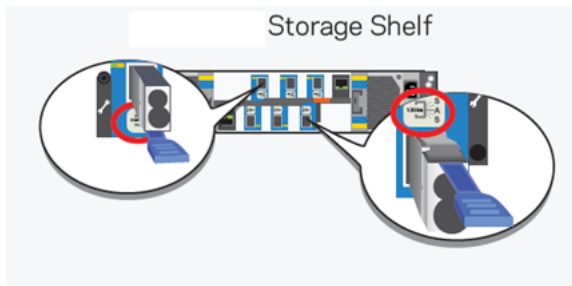

To connect four storage shelves to an appliance

- 1 Connect a SAS-3 cable to the left port in the appliance RAID PCIe card.
- 2 Connect the other end of the SAS-3 cable to port A in the top I/O module of the first storage shelf.
- 3 Connect SAS-3 cables between the remaining four storage shelves.

- 4** Connect a SAS-3 connector to port A in the bottom of the I/O module in the fourth shelf.
- 5** Connect the other end of the cable to the right port in the appliance RAID PCIe card.
- 6** Connect a SAS-3 cable to port B in the bottom I/O module of the fourth shelf. Connect the other end of the cable to port A in the bottom I/O module of the third shelf.

- 7 Connect port B in the bottom I/O module of the third shelf to port A in the bottom I/O module in the second shelf.
- 8 Connect port B in the bottom I/O module of the second shelf to port A in the bottom I/O module in the first shelf.

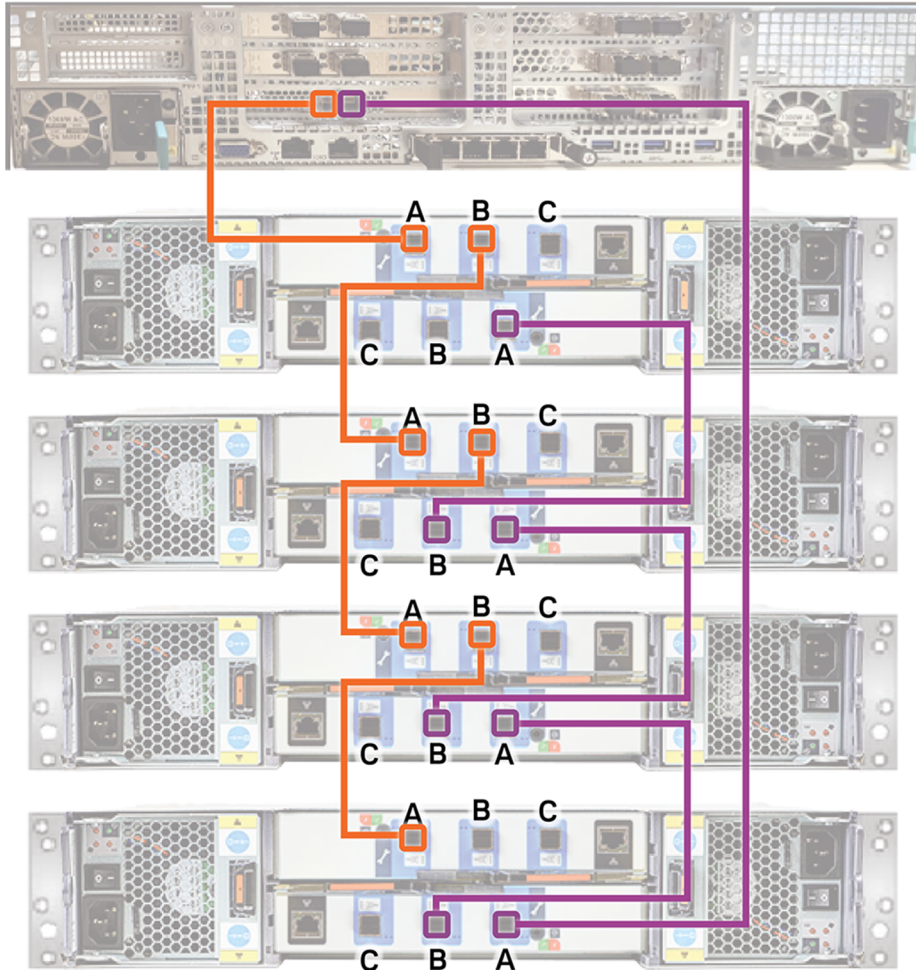

Next, connect network and power cables. Turn on the storage shelves and the appliance per the required sequence. Verify that all units function correctly.

See [“Connecting the network cables”](#) on page 48.

See [“Connecting the power cords”](#) on page 49.

See [“Turning on the hardware and verifying operation”](#) on page 50.

Connecting the fifth storage shelf to an appliance

Note: The cables in the following diagrams are shown in different colors for demonstration purposes only. The actual cables are black.

Note: The orientation of the blue tabs on the ends of the SAS-3 cables is important. In the appliance, the blue tabs on each SAS-3 connector must face down.

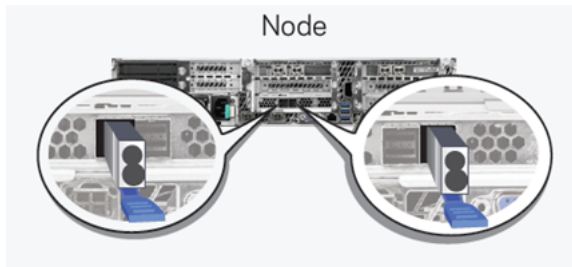

In the storage shelves, the blue tabs in the SAS-3 connectors should point to the 12 Gb/s SAS label near each port. The blue tabs on the SAS-3 connectors inserted into the top row must face down. The blue tabs of the connectors inserted into the bottom row must face up.

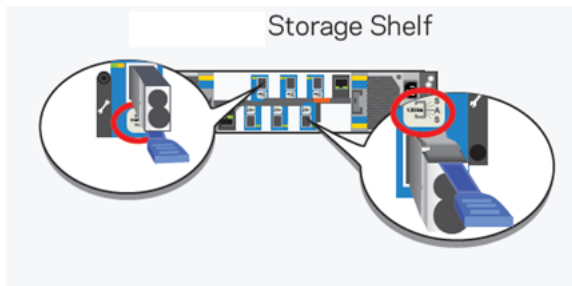

To connect the fifth storage shelves to an appliance

- 1** Disconnect the SAS-3 cable from port A on the bottom I/O module on the fourth storage shelf and connect the cable to port A on the bottom I/O module of the fifth shelf.
- 2** Connect one SAS-3 cable to port B in the top I/O module of the fourth storage shelf. Connect the other end of this cable to port A in the top I/O module in the fifth storage shelf.

- 3 Connect one SAS-3 cable to port A in the bottom I/O module of the fourth storage shelf. Connect the other end of this cable to port B in the bottom I/O module in the fifth storage shelf.

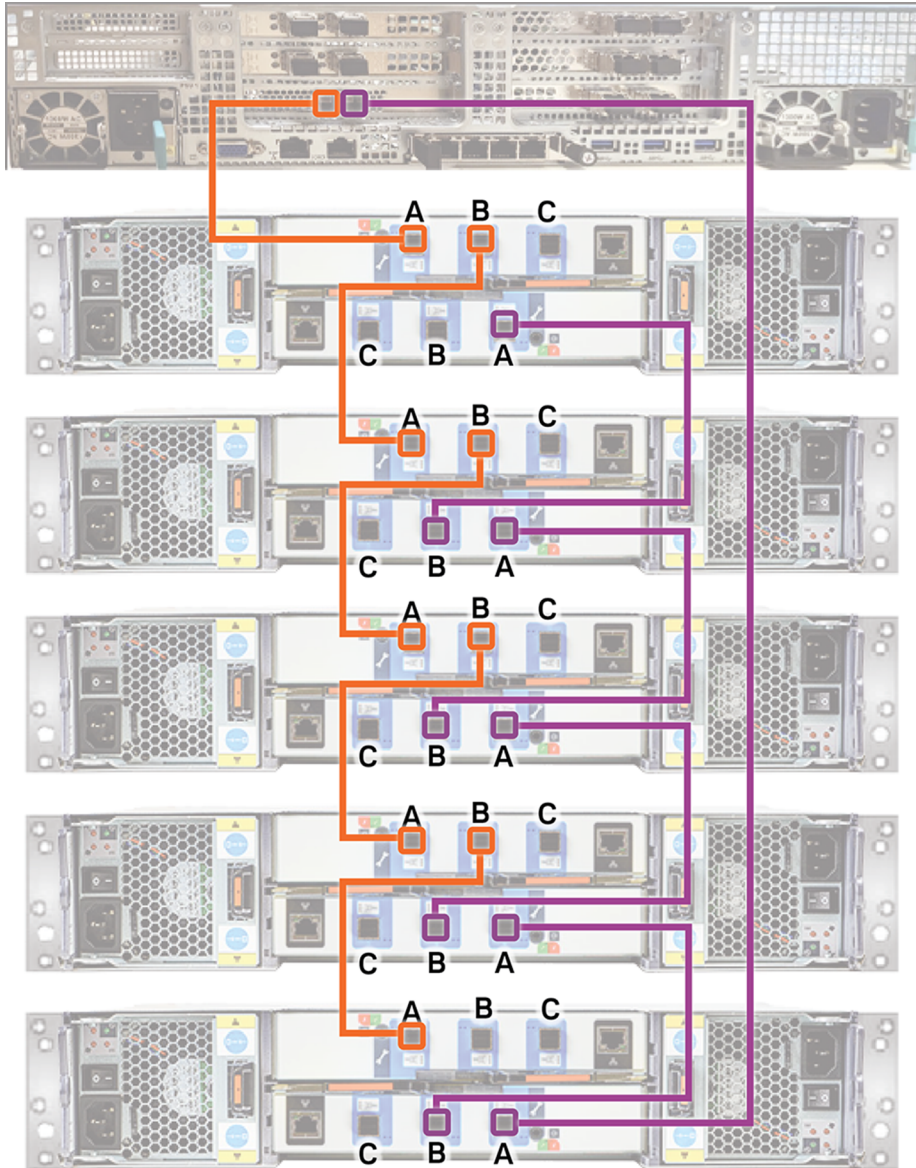

Next, connect network and power cables. Turn on the storage shelves and the appliance per the required sequence. Verify that all units function correctly.

See “[Connecting the network cables](#)” on page 48.

See “[Connecting the power cords](#)” on page 49.

See “[Turning on the hardware and verifying operation](#)” on page 50.

Connecting the sixth storage shelf to an appliance

Note: The cables in the following diagrams are shown in different colors for demonstration purposes only. The actual cables are black.

Note: The orientation of the blue tabs on the ends of the SAS-3 cables is important.

In the appliance, the blue tabs on each SAS-3 connector must face down.

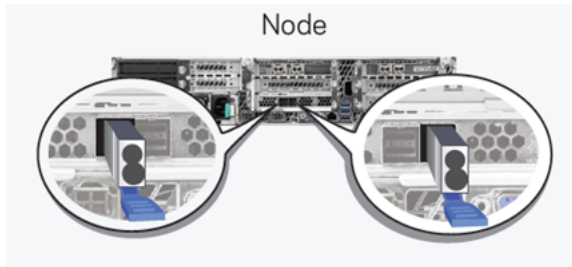

In the storage shelves, the blue tabs in the SAS-3 connectors should point to the 12 Gb/s SAS label near each port. The blue tabs on the SAS-3 connectors inserted into the top row must face down. The blue tabs of the connectors inserted into the bottom row must face up.

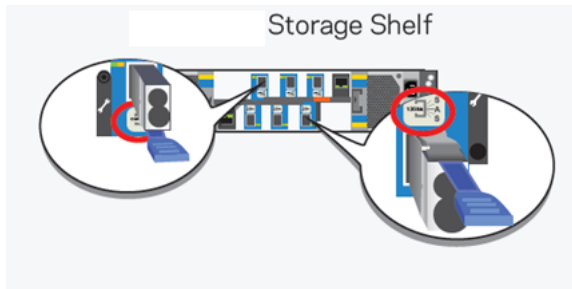

To connect the sixth storage shelves to an appliance

- 1** Disconnect the SAS-3 cable from port A on the bottom I/O module on the fifth storage shelf and connect the cable to port A on the bottom I/O module of the sixth shelf.
- 2** Connect one SAS-3 cable to port B in the top I/O module of the fifth storage shelf. Connect the other end of this cable to port A in the top I/O module in the sixth storage shelf.

- 3** Connect one SAS-3 cable to port A in the bottom I/O module of the fifth storage shelf. Connect the other end of this cable to port B in the bottom I/O module in the sixth storage shelf.

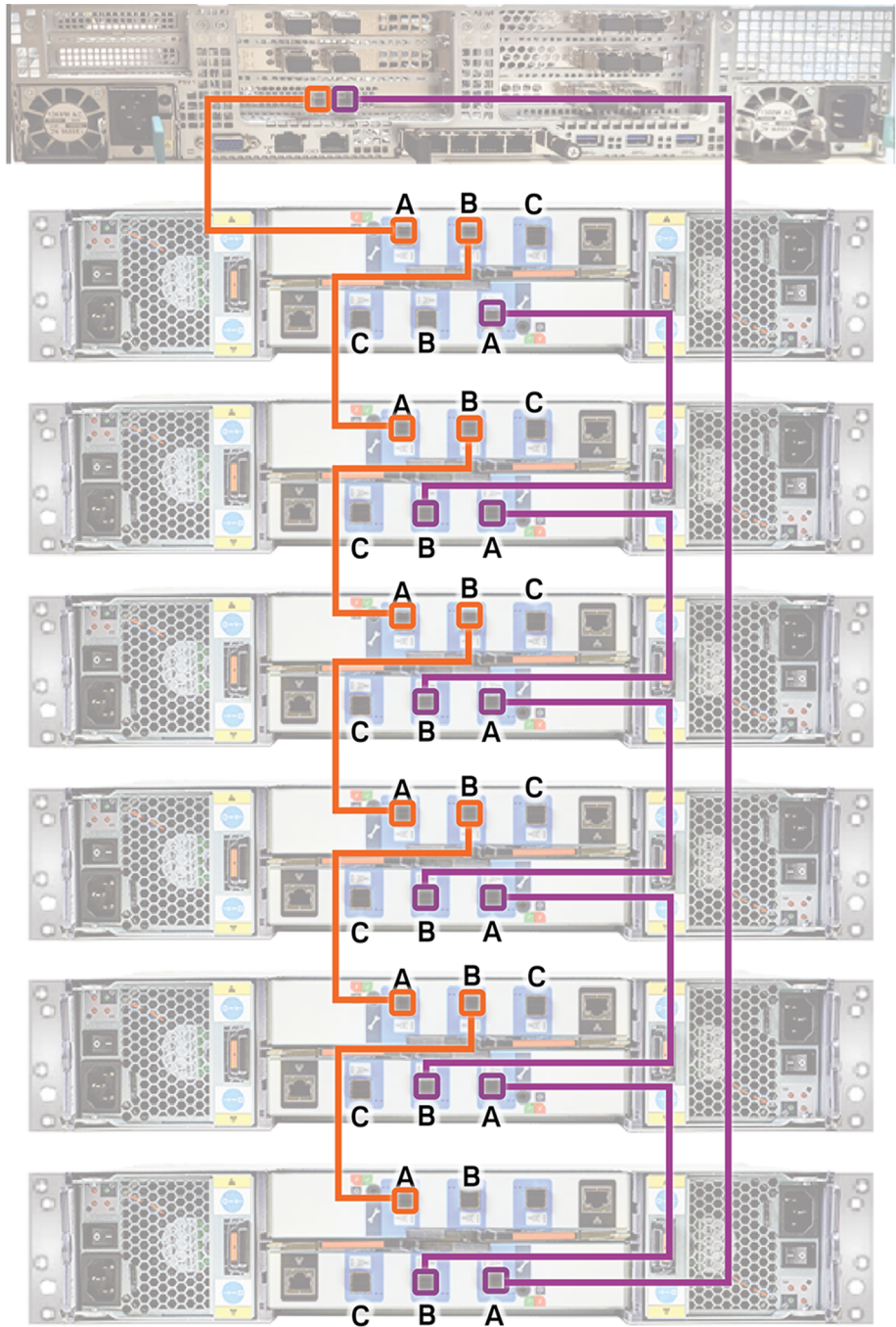

Next, connect network and power cables. Turn on the storage shelves and the appliance per the required sequence. Verify that all units function correctly.

See [“Connecting the network cables”](#) on page 48.

See [“Connecting the power cords”](#) on page 49.

See [“Turning on the hardware and verifying operation”](#) on page 50.

Adding storage shelves to an operating appliance that has at least one storage shelf attached

This appendix includes the following topics:

- [Overview](#)
- [Additional storage shelf scenarios](#)
- [Recabling to connect additional storage shelves](#)

Overview

The 5260 Appliance operates with up to six external storage shelves. If your appliance has at least one storage shelf that is connected and running properly you can add more shelves for a total of six shelves.

Existing 5260 Appliances with internal storage capacities of 9.1TiB and 36.4TiB support up to six Veritas 2U12 65.5TiB/72TB Storage Shelves.

Additional storage shelf scenarios

You can have up to six storage shelves with the 5260 Appliance. You may already have storage shelves connected to your appliance. The following options are available.

Note: When adding a fifth or sixth storage shelf, an additional storage expansion kit is required. This adds up to a total of 512GB memory.

- If you already have one storage shelf you can add one to five shelves.
- If you already have two storage shelves you can add one to four shelves.
- If you already have three storage shelves you can add one to three shelves.
- If you already have four storage shelves you can add one or two shelves.
- If you already have five storage shelves you can add one shelf.

If you already have six storage shelves you cannot add any more shelves at this time.

Note: The appliance server needs to be powered off when adding any storage shelves to an existing appliance installation.

Recabling to connect additional storage shelves

When storage shelves are added to an appliance that already has at least one storage shelf you need to reroute one existing cable connection. You also need to install the new cables that ship with the additional storage shelf or shelves. Each storage shelf ships with two 2-meter SAS-3 cables.

The following sections provide cable instructions for an appliance and a total of four storage shelves. The instructions are the same for five or six storage shelves.

Note: The cables in the following diagrams are shown in different colors for demonstration purposes only. The actual cables are black.

A green box outlines the storage shelves that are added to the existing devices.

See [“Connecting additional shelves to an appliance that already has one operating shelf”](#) on page 100.

See [“Connecting additional shelves to an appliance that already has two operating shelf”](#) on page 102.

See [“Connecting additional shelves to an appliance that already has three operating shelf”](#) on page 104.

Refer to the following section to add the additional disk space.

See [“Adding the disk space of an Expansion Storage Shelf from the Flex Appliance Console”](#) on page 106.

Connecting additional shelves to an appliance that already has one operating shelf

To connect additional shelves to an appliance that already has one operating shelf

- 1 Remove and reconnect the SAS-3 cables to the correct I/O module ports as shown in the figure. Use the two new SAS-3 cables that ship with each storage shelf.

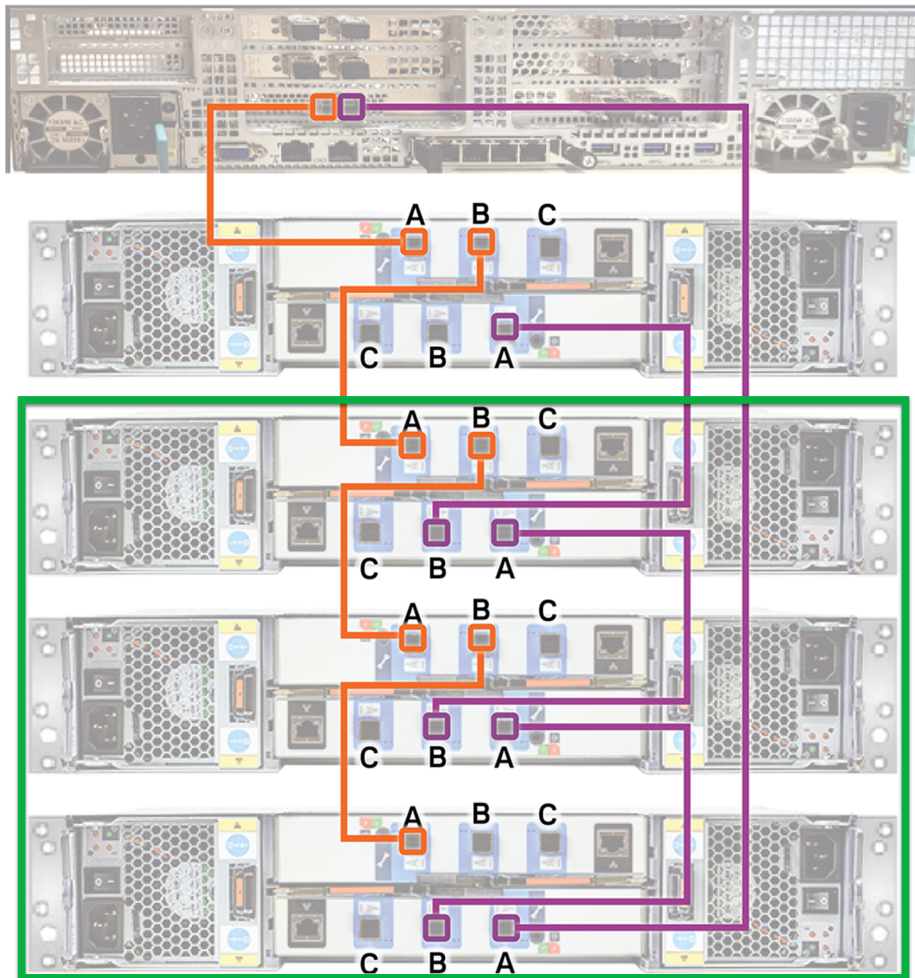

- 2 Connect power cords between the new storage shelves and separate Power Distribution Units (PDUs) in the rack.

- 3** Turn on the storage shelf that is farthest from the appliance. Let the shelf initialize for a few minutes.
- 4** Turn on the other storage shelves, in sequence. Do not turn on all of the shelves at once.
- 5** Verify that the new shelves function correctly.

Refer to the following section for details.

See [“Turning on the hardware and verifying operation”](#) on page 50.

Connecting additional shelves to an appliance that already has two operating shelf

To connect additional shelves to an appliance that already has two operating shelf

- 1 Remove and reconnect the SAS-3 cables to the correct I/O module ports as shown in the figure. Use the two new SAS-3 cables that ship with each storage shelf.

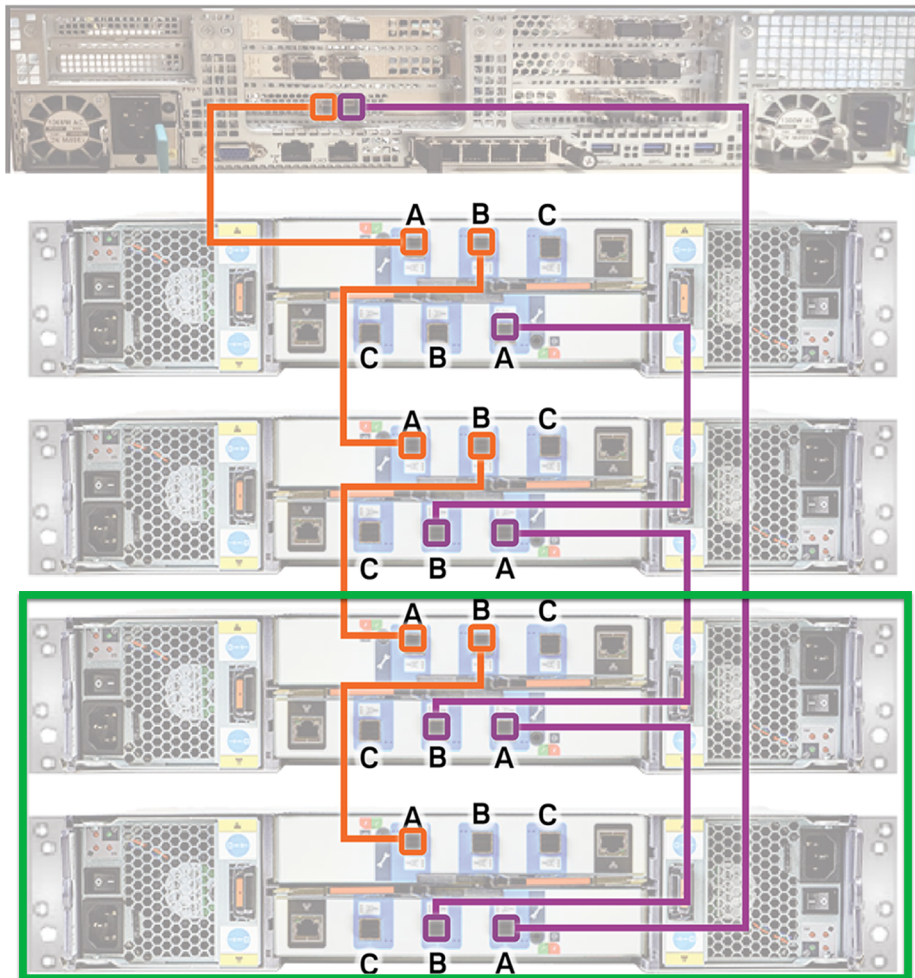

- 2 Connect power cords between the new storage shelves and separate Power Distribution Units (PDUs) in the rack.

- 3** Turn on the storage shelf that is farthest from the appliance. Let the shelf initialize for a few minutes.
- 4** Turn on the other storage shelves, in sequence. Do not turn on all of the shelves at once.
- 5** Verify that the new shelves function correctly.

Refer to the following section for details.

See [“Turning on the hardware and verifying operation”](#) on page 50.

Connecting additional shelves to an appliance that already has three operating shelf

To connect additional shelves to an appliance that already has three operating shelf

- 1 Remove and reconnect the SAS-3 cables to the correct I/O module ports as shown in the figure. Use the two new SAS-3 cables that ship with each storage shelf.

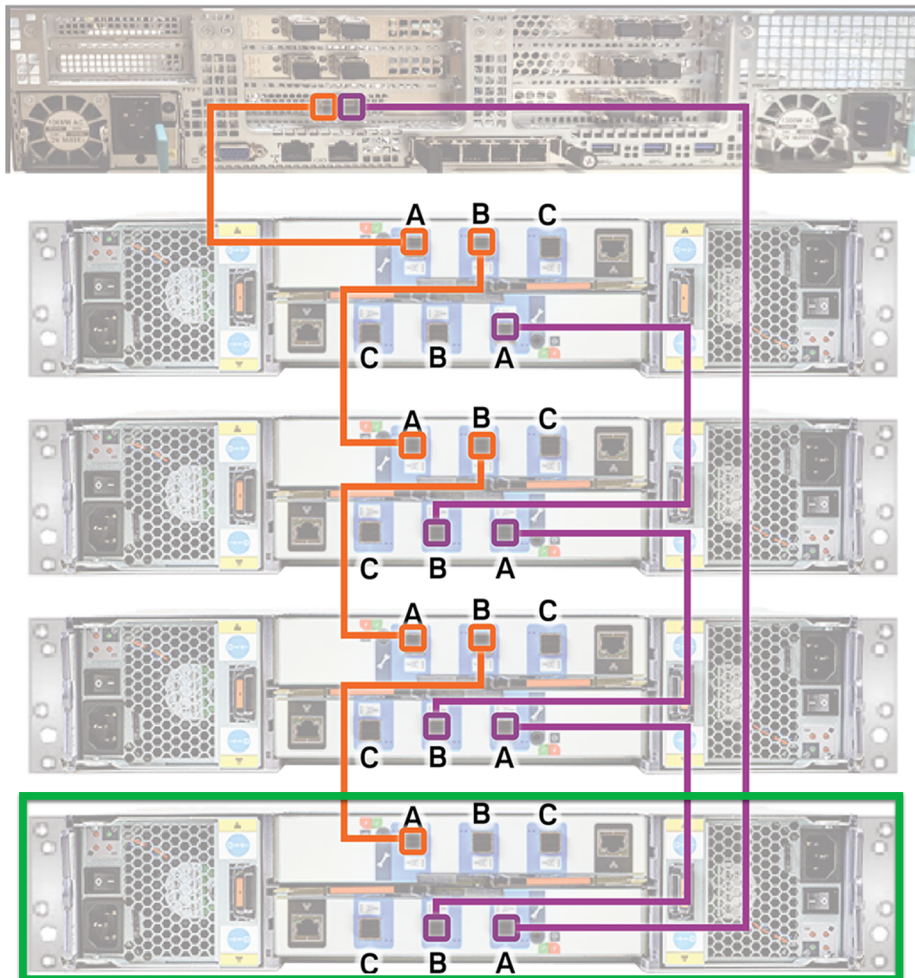

- 2 Connect power cords between the new storage shelves and separate Power Distribution Units (PDUs) in the rack.

- 3** Turn on the storage shelf that is farthest from the appliance. Let the shelf initialize for a few minutes.
- 4** Turn on the other storage shelves, in sequence. Do not turn on all of the shelves at once.
- 5** Verify that the new shelves function correctly.

Refer to the following section for details.

See [“Turning on the hardware and verifying operation”](#) on page 50.

Configuring the disk space for new Flex Expansion Storage Shelves

This appendix includes the following topics:

- [Adding the disk space of an Expansion Storage Shelf from the Flex Appliance Console](#)

Adding the disk space of an Expansion Storage Shelf from the Flex Appliance Console

Follow the steps in this section to add storage disk space to an appliance after physically adding one or more Expansion Shelves.

Note: When you configure additional disk space, any current backup operations are stopped until the process is complete. Veritas recommends that you do not start any backup operations before starting this procedure.

To configure additional disk space

- 1 Turn on the new shelf or shelves.
Wait approximately five minutes for the shelves to completely turn on.
- 2 Turn on the appliance node.
See [“Turning on the hardware and verifying operation”](#) on page 50.
- 3 Sign in to the Flex Appliance Console.

- 4** Go to the **System topology** page.
- 5** Click on **Add storage**.
- 6** A confirmation window appears. Click **Yes**.
You can monitor the progress from the Activity Monitor.

Note: In a multi-node appliance, two tasks are shown in the Activity Monitor.

A task to add new storage displays for the first node, and a task to scan new storage displays for the second node. The task for the second node runs after the first node's tasks are complete.

If you want to resize instances, refer to the *Resizing instance storage* section in the *Flex Appliance Getting Started and Administration Guide*.

Index

A

- about
 - customer-provided environment 22
 - SAS-3 cables 19
- adding storage shelves
 - overview 66, 98
- additional storage shelf
 - connecting 100, 102, 104
- airflow 27
- appliance
 - cables 19
 - cabling
 - power cords 49
 - installing into a rack 37
 - rack locations 25
 - rack rail installation 33
 - rails
 - blue latch 38
 - extending intermediate section 37
 - shipping container contents 23
 - soft shutdown 68
 - storage shelf addition scenarios 98
 - turning on the hardware 50

B

- best practices
 - heat dissipation 27
 - internal chassis access 68
 - rack installation 24

C

- cabling
 - verifying SAS-3 length 28
- control panel
 - storage shelf 17

D

- documentation 21

H

- heat dissipation 27

I

- installing
 - appliance into a rack 37
 - appliance rack rails 33
 - storage shelf into a rack 32
 - storage shelf rack rails 30

R

- rack cabinet requirements 22
- rear panel
 - storage shelf 18

S

- SAS-3 cables
 - using 28
- storage shelf
 - control panel 17
 - installing into a rack 32
 - rails 31
 - rear panel 18
 - shipping container contents 24
- storage shelf rack rail
 - installation 30

V

- Veritas Remote Management interface
 - accessing 63