

USER MANUAL

EMD200DP-T, EMD200DV-T, EMD2000PE-DP-T, EMD2000PE-R, EMD2000PE-R-P, EMD2000PE-T, EMD2000PE-T-P, EMD2000SE-DP-T, EMD2000SE-R, EMD2000SE-T, EMD2002PE-DP-T, EMD2002PE-R, EMD2002PE-R-P, EMD2002PE-T, EMD2002PE-T-P, EMD2002SE-DP-T, EMD2002SE-R, EMD2002SE-T, EMD2000SE-T-R2, EMD2000PE-T-R2, EMD2002PE-T-R2, EMD2000SE-DP-R, EMD2002SE-DP-R, EMD2000PE-DP-R, EMD2002PE-DP-R, EMD4000T, EMD4000R

EMERALD KVM OVER IP TECHNOLOGY

24/7 TECHNICAL SUPPORT AT 1.877.877.2269 OR VISIT BLACKBOX.COM

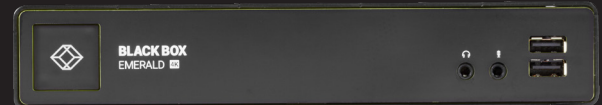
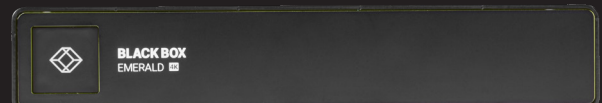

BLACK BOX

TABLE OF CONTENTS

1. SPECIFICATIONS.....	5
1.1 Specifications	5
1.2 Licensing.....	31
2. OVERVIEW.....	32
2.1 Emerald System Features.....	34
2.2 Overview of Emerald Devices.....	35
2.2.1 Video.....	36
2.2.2 Audio.....	36
2.2.3 Support for Keyboards, Mice, and USB Devices.....	36
2.2.4 IP Addressing.....	37
2.2.5 Firmware Upgrade.....	37
2.3 Application Examples.....	37
2.3.1 Video, Audio, and USB Extension.....	37
2.3.2 Video, Audio, and USB Switching.....	38
3. CONFIGURATION	39
3.1 Receiver Configuration	39
3.2 Transmitter Configuration.....	40
3.3 Boxilla Manager Configuration	41
4. MODES OF OPERATION	42
4.1 Auto-Login.....	42
4.2 Auto-Connect	42
4.3 Private Connection.....	42
4.4 Shared Connection	42
4.5 Video Source Optimization.....	42
5. INSTALLATION	43
5.1 Emerald Receiver (EMD2000SE-R, EMD2002SE-R, EMD2000PE-R, EMD2000PE-R-P, EMD2002PE-R, EMD2002PE-R-P) Checklist ..	43
5.2 Emerald Transmitter (EMD2000SE-T, EMD2002SE-T, EMD2000PE-T, EMD2000-PE-T-P, EMD2002PE-T, EMD2002-PE-T-P, EMD2000SE-T-R2, EMD2000PE-T-R2, EMD2002PE-T-R2) Checklist.....	43
5.3 Emerald SE or PE Transmitter Kit (EMD2000SE-T-K, EMD2002SE-T-K, EMD2000PE-K, and EMD2002PE-K) Checklist.....	43
5.4 Emerald ZeroU DVI or DP Transmitter (EMD200V-T or EMD200DP-T) Checklist	44
5.5 Emerald DisplayPort SE and PE Transmitters (EMD2000PE-DP-T, EMD2000SE-DP-T, EMD2002PE-DP-T, EMD2002SE-DP-T) Checklist.....	44
5.6 Emerald DisplayPort SE and PE Receivers (EMD2000SE-DP-R, EMD2002SE-DP-R, EMD2000PE-DP-R, EMD2002PE-DP-R) Checklist.....	44
5.7 Emerald 4K Transmitter (EMD4000T) Checklist	44
5.8 Emerald 4K Receiver (EMD4000R) Checklist	45
5.9 Installation Options.....	45



TABLE OF CONTENTS

5.10 Connect the Emerald Receiver	46
5.10.1 Emerald SE Receiver Connector Information	47
5.10.2 Emerald SE DP Receiver Connector Information	49
5.10.3 Emerald PE or PoE Receiver Connector Information	51
5.10.4 Emerald PE Single-head DisplayPort Receiver Connector Information.....	53
5.10.5 Emerald PE Dual-head DisplayPort Receiver Connector Information.....	54
5.10.6 Emerald 4K Receiver Connector Information	55
5.11 Connect the Emerald Transmitter	57
5.11.1 Emerald ZeroU DVI and DP Connector Information.....	58
5.11.2 Emerald SE Transmitter Connector Information.....	60
5.11.3 Emerald SE R2 DVI Transmitter, Single-head Connector Information.....	62
5.11.4 Emerald SE Single-head DisplayPort Transmitter Connector Information.....	63
5.11.5 Emerald SE Dual-head DisplayPort Transmitter Connector Information.....	64
5.11.6 Emerald PE or PE PoE Transmitter Connector Information.....	65
5.11.7 Emerald PE R2 Single-head Transmitter Connector Information.....	67
5.11.8 Emerald PE R2 Dual-head Transmitter Connector Information	68
5.11.9 Emerald PE Single-head DisplayPort Transmitter Connector Information.....	69
5.11.10 Emerald PE Dual-head DisplayPort Transmitter Connector Information	70
5.11.11 Emerald 4K Transmitter Connector Information	71
5.12 Connect the Emerald ZeroU DVI or DisplayPort Transmitter	73
6. NETWORKED INSTALLATION	74
6.1 Point-to-Point Installation.....	74
6.2 Unmanaged or Managed Matrix Installation	74
7. OPERATION OF EMERALD SYSTEM	75
7.1 LED Identification	75
7.2 Accessing the System.....	75
8. OSD FUNCTIONS	76
8.1 User Types.....	76
8.2 Log On	76
8.3 Default Username and Password	77
8.4 User Views and Capabilities.....	78
8.5 Connections Screen.....	78
8.5.1 Idle Screen.....	79
8.5.2 Creating a New Connection.....	80
8.5.3 Connection Favorites	83
8.5.4 Connecting	84
8.5.5 Edit Connection	84
8.5.6 Remove Connection	84
8.5.7 Bonding.....	84



TABLE OF CONTENTS

NEED HELP?
LEAVE THE TECH TO US
**LIVE 24/7
TECHNICAL
SUPPORT**
1.877.877.2269

8.6 Control Tab.....	85
8.6.1 Preferences	86
8.6.2 Network.....	92
8.6.3 System.....	93
8.7 Managing Users	101
8.7.1 Add a User.....	102
8.7.2 Auto Log-on.....	103
8.7.3 Edit a User.....	104
8.7.4 Remove a User	105
8.8 LACP.....	106
APPENDIX A. EMERALD VIDEO RESOLUTIONS SUPPORTED	107
APPENDIX B. EMERALD 4K MODELS.....	108
B.1 Available Models	108
B.2 Compatible Network Switches	108
B.3 Comparison Chart.....	108
B.4 Compatible SFPS	108
B.5 Compatible Cables.....	109
APPENDIX C. NETWORK REQUIREMENTS AND PORT USAGE.....	110
C.1 Recommended Network Design	110
C.2 Multi-Subnet Support	110
C.3 4K Multicast Support.....	110
C.4 TCP/UDP Port Usage.....	113
C.5 Network Switch Requirements	114
APPENDIX D. CONFIGURING WINDOWS 10 VIRTUAL MACHINES.....	115
APPENDIX E. EMERALD NETWORK PROTOCOLS OVERVIEW.....	116
APPENDIX F. TROUBLESHOOTING	117
APPENDIX G. REGULATORY INFORMATION	119
G.1 FCC Statement	119
G.2 NOM Statement	120
APPENDIX H. DISCLAIMER/TRADEMARKS	121
H.1 Disclaimer.....	121
H.2 Trademarks Used in this Manual.....	121



CHAPTER 1: SPECIFICATIONS

1.1 SPECIFICATIONS

EMERALD ZEROU DVI TRANSMITTER (EMD200DV-T)

TRANSMITTER



NOTE: The Emerald® ZeroU DVI transmitter (EMD200DV-T) supports speakers-only audio on the 3.5-mm connector.

WHAT'S INCLUDED WITH THE TRANSMITTER (EMD200DV-T)

- ♦ (1) EMERALD ZEROU DVI TRANSMITTER

NOTE: The EMD200DV-T does not support USB-redirected connections or devices.

SPECIFICATIONS FOR EMERALD ZEROU DVI TRANSMITTER (EMD200DV-T)

APPROVALS	
UNIT	Directive 2014/30/EU, CE, FCC, UKCA, 2011/65/EU, 2015/863/EU, Reach, TSCA, CB
PHYSICAL	
LED INTERFACE	(1) Power LED (green); (1) RJ-45 Speed LED (green, located on top left of RJ-45 connector): Blinks three times when the network connection is 1000 Mbps, Blinks two times when network connection is 100 Mbps, Blinks once when the network connection is 10 Mbps, Not blinking: No link to network; (1) Activity LED (green, located on top right of RJ-45 connector): Solid green: Link up, Blinking: Activity on the link, OFF: No link
MAXIMUM DISTANCE FROM CPU TO TRANSMITTER	12" (305 mm) via connected cable harness
MAXIMUM DISTANCE BETWEEN TRANSMITTER AND RECEIVER	328 ft. (100 m), use a network switch to get farther distances
OPERATING SYSTEM SUPPORT	Microsoft Windows® 10/11, Server OS, Linux®, and Mac OS
CONNECTORS	(1) DVI input, (2) USB Type A female, (1) RJ-45 network (10/100/1000BASE-T), (1) 2.5-mm barrel for power; NOTE: The ZeroU transmitter can be powered via (2) USB Type A connectors or via an optional DC power adapter.
DIMENSIONS	0.98" H x 2.78" W x 6.12" D (25 x 71 x 155 mm)
WEIGHT	0.4 lb. (181 g)
OPERATION	
DEFAULT IP ADDRESS	192.168.1.22
ENCRYPTION	Secure Sockets Layer (SSL) over TCP/IP, 128-bit between transmitter and receiver
DDC SUPPORT	Built-in/clone of remote
POWER	
POWER SOURCE	Via USB or an optional 5VDC power adapter
INPUT VOLTAGE	5VDC
ENVIRONMENTAL	
OPERATING TEMPERATURE	32 to 104° F (0 to 40° C)
STORAGE TEMPERATURE	-4 to +140° F (-20 to 60° C)
OPERATING HUMIDITY	5 to 95%, noncondensing

CHAPTER 1: SPECIFICATIONS

EMERALD ZEROU DISPLAYPORT TRANSMITTER (EMD200DP-T) TRANSMITTER

The Emerald® system will take audio from your DisplayPort™ connector and transmit it across the network just like it does with the video signal. The receiver will decode this and send it out the receiver's 3.5-mm audio connector with no configuration required in Emerald.

NOTE: The graphics card and OS must support embedded audio over DisplayPort, and it may need to be enabled on your system.



NOTE: The Emerald ZeroU DisplayPort transmitter (EMD200DP-T) supports embedded audio on the DisplayPort connector.

WHAT'S INCLUDED WITH THE TRANSMITTER (EMD200DP-T)

- ♦ (1) EMERALD ZEROU DISPLAYPORT TRANSMITTER

NOTE: The EMD200DP-T cannot support USB-redirected connections.

SPECIFICATIONS FOR EMERALD ZEROU DISPLAYPORT TRANSMITTER (EMD200DP-T)

APPROVALS	
UNIT	Directive 2014/30/EU, CE, FCC, UKCA, 2011/65/EU, 2015/863/EU, Reach, TSCA, CB
PHYSICAL	
LED INTERFACE	(1) Power LED (green); (1) RJ-45 Speed LED (green, located on top left of RJ-45 connector): Blinks three times when the network connection is 1000 Mbps, Blinks two times when network connection is 100 Mbps, Blinks once when the network connection is 10 Mbps, Not blinking: No link to network; (1) Activity LED (green, located on top right of RJ-45 connector): Solid green: Link up, Blinking: Activity on the link, OFF: No link
MAXIMUM DISTANCE FROM CPU TO TRANSMITTER	12" (305 mm) via connected cable harness
MAXIMUM DISTANCE BETWEEN TRANSMITTER AND RECEIVER	328 ft. (100 m), use a network switch to get farther distances
OPERATING SYSTEM SUPPORT	Microsoft Windows® 10/11, Server OS, Linux®, and Mac OS
CONNECTORS	(1) DisplayPort input, (2) USB Type A female, (1) RJ-45 network (10/100/1000BASE-T), (1) 2.5-mm barrel for power; NOTE: The ZeroU transmitter can be powered via (2) USB Type A connectors or via an optional DC power adapter.
DIMENSIONS	0.98" H x 2.78" W x 6.12" D (25 x 71 x 155 mm)
WEIGHT	0.4 lb. (181 g)
OPERATION	
DEFAULT IP ADDRESS	192.168.1.22
ENCRYPTION	Secure Sockets Layer (SSL) over TCP/IP, 128-bit between transmitter and receiver
DDC SUPPORT	Built-in/clone of remote
POWER	
POWER SOURCE	Via USB or an optional 5VDC power adapter
INPUT VOLTAGE	5VDC
ENVIRONMENTAL	
OPERATING TEMPERATURE	32 to 104° F (0 to 40° C)
STORAGE TEMPERATURE	-4 to +140° F (-20 to 60° C)
OPERATING HUMIDITY	5 to 95%, noncondensing

CHAPTER 1: SPECIFICATIONS

NEED HELP?
LEAVE THE TECH TO US

**LIVE 24/7
TECHNICAL
SUPPORT**

1.877.877.2269

EMERALD PE SINGLE-HEAD TRANSMITTER (EMD2000PE-T, EMD2000PE-T-P) AND RECEIVER (EMD2000PE-R, EMD2000PE-R-P)

TRANSMITTER FRONT VIEW



RECEIVER FRONT VIEW



TRANSMITTER BACK VIEW



RECEIVER BACK VIEW



WHAT'S INCLUDED WITH THE TRANSMITTER (EMD2000PE-T* OR EMD2000PE-T-P*)

- (1) EMERALD PE TRANSMITTER, SINGLE-HEAD
- (1) 12VDC POWER SUPPLY WITH POWER CORD
- (1) DVI CABLE
- (1) USB 2.0 TYPE B CABLE

WHAT'S INCLUDED WITH THE RECEIVER (EMD2000PE-R* OR EMD2000PE-R-P)

- (1) EMERALD PE RECEIVER, SINGLE-HEAD
- (1) 12VDC POWER SUPPLY WITH POWER CORD

* EMD2000PE-T IS EOL. IT IS REPLACED BY EMD2000PE-T-R2.

EMD2000PE-T-R IS EOL. IT IS REPLACED BY EMD2000PE-T-R2.

* EMD2000PE-R IS EOL. USE EMD2000PE-R-P.

CHAPTER 1: SPECIFICATIONS

SPECIFICATIONS FOR EMERALD PE TRANSMITTER AND RECEIVER, SINGLE-HEAD
(EMD2000PE-T, EMD2000PE-T-P, EMD2000PE-R, EMD2000PE-R-P)

APPROVALS	
UNIT	Directive 2014/30/EU, CE, FCC, ICES, UKCA, 2011/65/EU, 2015/863/EU, Reach, TSCA, CB
POWER SUPPLY	Directive 2014/35/EU, EN 62368-1:2014, UL, cUL, GS, PSE, BSMI, RCM, BIS, CB
PHYSICAL	
LED INTERFACE	(1) Power LED (lights when power is on); NOTE: Unit automatically powers on when plugged in; must be powered off at the power source. (1) RJ-45 Speed LED (green, located on top left of RJ-45 connector): Blinks three times when the network connection is 1000 Mbps, Blinks two times when network connection is 100 Mbps, Blinks once when the network connection is 10 Mbps, Not blinking: No link to network; (1) Activity LED (green, located on top right of RJ-45 connector): Solid green: Link up, Blinking: Activity on the link, OFF: No link
MAXIMUM DISTANCE FROM CPU TO TRANSMITTER	5 m (16.4 ft.), DVI-D and USB limitations
MAXIMUM DISTANCE BETWEEN TRANSMITTER AND RECEIVER	328 ft. (100 m), use a network switch to get farther distances
OPERATING SYSTEM SUPPORT	Microsoft Windows® 10/11, Server OS, Linux®, and Mac OS
CONNECTORS	EMD2000PE-T: (1) DVI input, (1) USB Type B female, (1) RJ-45 network, (1) SFP network, (2) 3.5-mm audio, (1) 3-pin locking connector for power, (1) Micro USB connector; EMD2000PE-T-P: (1) DVI input, (1) USB Type B female, (1) RJ-45 PoE network, (1) SFP network, (2) 3.5-mm audio, (1) 3-pin locking connector for power, (1) Micro USB connector; EMD2000PE-R: (1) DVI output, (4) USB Type A female, (1) RJ-45 network, (1) SFP network, (2) 3.5-mm audio for SPK and MIC, (1) 3-pin locking connector for power, (1) Micro USB connector; EMD2000PE-R-P: (1) DVI output, (4) USB Type A female, (1) RJ-45 PoE network, (1) SFP network, (2) 3.5-mm audio for SPK and MIC, (1) 3-pin locking connector for power, (1) Micro USB connector
DIMENSIONS	1.32" H x 7.62" W x 5.79" D (34 x 194 x 147 mm)
WEIGHT	1.18 lb. (535 g)
OPERATION	
DEFAULT IP ADDRESS	EMD2000PE-T, EMD2000PE-T-P: 192.168.1.22; EMD2000PE-R, EMD2000PE-R-P: 192.168.1.21
ENCRYPTION	Secure Sockets Layer (SSL) over TCP/IP, 128-bit between transmitter and receiver, user set between receiver and virtual machine
DEFAULT USERNAME	admin
DEFAULT PASSWORD	The password is blank by default.
DDC SUPPORT	Built-in/clone of remote
POWER	
POWER SOURCE	External in-line power supply or PoE IEEE 802.11af (EMD2000PE-T-P, EMD2000PE-R-P only)
INPUT VOLTAGE	100–240 VAC, 50/60 Hz
INPUT CURRENT	1 Amp maximum
POWER CONSUMPTION	Unit: 7.5 W with keyboard and mouse attached; Power supply: 36 W to support USB-based powered devices
HEAT DISSIPATION	122.76 BTW/hr maximum
OUTPUT CONNECTOR	3-pin locking connector (12 VDC, 3 Amp output)
INPUT CONNECTOR	IEC-320, C14
POWER SUPPLY CORD LENGTH	6 ft. (1.8 m)
ENVIRONMENTAL	
OPERATING TEMPERATURE	32 to 104° F (0 to 40° C)
STORAGE TEMPERATURE	-4 to +140° F (-20 to 60° C)
OPERATING HUMIDITY	5 to 95%, noncondensing



CHAPTER 1: SPECIFICATIONS

EMERALD PE DUAL-HEAD TRANSMITTER (EMD2002PE-T, EMD2002PE-T-P)
AND RECEIVER (EMD2002PE-R, EMD2002PE-R-P)

TRANSMITTER FRONT VIEW



RECEIVER FRONT VIEW



TRANSMITTER BACK VIEW



RECEIVER BACK VIEW



WHAT'S INCLUDED WITH THE TRANSMITTER (EMD2002PE-T*, EMD2002PE-T-P)

- ♦ (1) EMERALD PE TRANSMITTER, DUAL-HEAD
- ♦ (1) 12VDC POWER SUPPLY WITH POWER CORD
- ♦ (2) DVI CABLES
- ♦ (1) USB 2.0 TYPE B CABLE

WHAT'S INCLUDED WITH THE RECEIVER (EMD2002PE-R* OR EMD2002PE-R-P)

- ♦ (1) EMERALD PE RECEIVER, DUAL-HEAD
- ♦ (1) 12VDC POWER SUPPLY WITH POWER CORD

* EMD2002PE-R IS EOL. USE EMD2002PE-R-P.

* EMD2002PE-T IS EOL. IT IS REPLACED BY EMD20002PE-T-R2.
EMD2002PE-T-R IS EOL. IT IS REPLACED BY EMD2002PE-T-R2.

CHAPTER 1: SPECIFICATIONS

SPECIFICATIONS FOR EMERALD PE TRANSMITTER AND RECEIVER, DUAL-HEAD

(EMD2002PE-T, EMD2002-PE-T-P, EMD2002PE-R, EMD2002PE-R-P)

APPROVALS	
UNIT	Directive 2014/30/EU, CE, FCC, ICES, UKCA, 2011/65/EU, 2015/863/EU, Reach, TSCA, CB
POWER SUPPLY	Directive 2014/35/EU, EN 62368-1:2014, UL, cUL, GS, PSE, BSMI, RCM, BIS, CB
PHYSICAL	
LED INTERFACE	(1) Power LED (lights when power is on); NOTE: Unit automatically powers on when plugged in; must be powered off at the power source. (1) RJ-45 Speed LED (green, located on top left of RJ-45 connector): Blinks three times when the network connection is 1000 Mbps, Blinks two times when network connection is 100 Mbps, Blinks once when the network connection is 10 Mbps, Not blinking: No link to network; (1) Activity LED (green, located on top right of RJ-45 connector): Solid green: Link up, Blinking: Activity on the link, OFF: No link
MAXIMUM DISTANCE FROM CPU TO TRANSMITTER	5 m (16.4 ft.), DVI-D and USB limitations
MAXIMUM DISTANCE BETWEEN TRANSMITTER AND RECEIVER	328 ft. (100 m), use a network switch to get farther distances
OPERATING SYSTEM SUPPORT	Microsoft Windows® 10/11, Server OS, Linux®, and Mac OS
CONNECTORS	EMD2002PE-T: (2) DVI inputs, (1) USB Type B female, (1) RJ-45 network, (1) SFP network, (2) 3.5-mm audio, (1) 3-pin locking connector for power, (1) Micro USB connector; EMD2002PE-T-P: (2) DVI inputs, (1) USB Type B female, (1) RJ-45 PoE network, (1) SFP network, (2) 3.5-mm audio, (1) 3-pin locking connector for power, (1) Micro USB connector; EMD2002PE-R: (2) DVI outputs, (4) USB Type A female, (1) RJ-45 network, (1) SFP network, (2) 3.5-mm audio for SPK and MIC, (1) 3-pin locking connector for power, (1) Micro USB connector; EMD2002PE-R-P: (2) DVI outputs, (4) USB Type A female, (1) RJ-45 PoE network, (1) SFP network, (2) 3.5-mm audio for SPK and MIC, (1) 3-pin locking connector for power, (1) Micro USB connector
DIMENSIONS	1.32" H x 7.62" W x 5.79" D (34 x 194 x 147 mm)
WEIGHT	EMD2002PE-T: 1.47 lb. (667 g); EMD2002PE-R, EMD2002PE-R-P, EMD2002PE-T-P: 1.36 lb. (617 g)
OPERATION	
DEFAULT IP ADDRESS	EMD2002PE-T, EMD2002PE-T-P: 192.168.1.22; EMD2002PE-R, EMD2002PE-R-P: 192.168.1.21
ENCRYPTION	Secure Sockets Layer (SSL) over TCP/IP, 128-bit between transmitter and receiver, user set between receiver and virtual machine
DEFAULT USERNAME	admin
DEFAULT PASSWORD	The password is blank by default.
DDC SUPPORT	Built-in/clone of remote
POWER	
POWER SOURCE	External in-line power supply or PoE IEEE 802.11af (EMD2000PE-T-P, EMD2000PE-R-P only)
INPUT VOLTAGE	100–240 VAC, 50/60 Hz
INPUT CURRENT	1 Amp maximum
POWER CONSUMPTION	Unit: 7.5 W with keyboard and mouse attached; Power supply: 36 W to support USB-based powered devices
HEAT DISSIPATION	122.76 BTW/hr maximum
OUTPUT CONNECTOR	3-pin locking connector (12 VDC, 3 Amp output)
INPUT CONNECTOR	IEC-320, C14
POWER SUPPLY CORD LENGTH	6 ft. (1.8 m)
ENVIRONMENTAL	
OPERATING TEMPERATURE	32 to 104° F (0 to 40° C)
STORAGE TEMPERATURE	-4 to +140° F (-20 to 60° C)
OPERATING HUMIDITY	5 to 95%, noncondensing



CHAPTER 1: SPECIFICATIONS

NEED HELP?
LEAVE THE TECH TO US

**LIVE 24/7
TECHNICAL
SUPPORT**

1.877.877.2269

EMERALD PE SINGLE-HEAD DISPLAYPORT TRANSMITTER (EMD2000PE-DP-T) AND RECEIVER (EMD2000PE-DP-R)

TRANSMITTER FRONT VIEW



RECEIVER FRONT VIEW



TRANSMITTER BACK VIEW



RECEIVER BACK VIEW



WHAT'S INCLUDED WITH THE TRANSMITTER (EMD2000PE-DP-T)

- (1) EMERALD PE DP TRANSMITTER, SINGLE-HEAD
- (1) 12VDC POWER SUPPLY WITH POWER CORD
- (1) DISPLAYPORT™ CABLE
- (1) USB TYPE A TO B CABLE

WHAT'S INCLUDED WITH THE RECEIVER (EMD2000PE-DP-R)

- (1) EMERALD PE DP RECEIVER, SINGLE-HEAD
- (1) 12VDC POWER SUPPLY WITH POWER CORD

CHAPTER 1: SPECIFICATIONS

SPECIFICATIONS FOR EMERALD PE DISPLAYPORT TRANSMITTER, SINGLE -HEAD (EMD2000PE-DP-T), AND RECEIVER (EMD2000PE-DP-R)

APPROVALS	
UNIT	Directive 2014/30/EU, CE, FCC, UKCA, 2011/65/EU, 2015/863/EU, Reach, TSCA
POWER SUPPLY	Directive 2014/35/EU, EN 62368-1:2014, UL, cUL, GS, PSE, BSMI, RCM, BIS, CB
PHYSICAL	
LED INTERFACE	(1) Power LED; (1) Network LED; (1) Video 1 Status LED; (1) RJ-45 Speed LED (green, located on top left of RJ-45 connector): Blinks three times when the network connection is 1000 Mbps, Blinks two times when network connection is 100 Mbps, Blinks once when the network connection is 10 Mbps, Not blinking: No link to network; (1) Activity LED (green, located on top right of RJ-45 connector): Solid green: Link up, Blinking: Activity on the link, OFF: No link
MAXIMUM DISTANCE FROM CPU TO TRANSMITTER	5 m (16.4 ft.), DisplayPort™ and USB limitations
MAXIMUM DISTANCE BETWEEN TRANSMITTER AND RECEIVER	328 ft. (100m) CATx Fiber: Distance dependent on SFP and Fiber cable used
OPERATING SYSTEM SUPPORT	Microsoft Windows® 10/11, Server OS, Linux®, and Mac OS
CONNECTORS	EMD2000PE-DP-T: (1) DisplayPort female, (1) USB Type B female, (1) 3.5-mm audio, (1) RJ-45 Interconnect, 1Gbps, (1) SFP Interconnect, 1 Gbps (unpopulated), (1) USB Type B micro (Console), (1) 3-pin locking connector for power (12VDC); EMD2000PE-DP-R: (1) DisplayPort female, (4) USB Type A female, (1) 3.5-mm audio, (1) RJ-45 Interconnect, (1) SFP Interconnect 1Gbps (unpopulated), (1) USB Type B Micro (Console), (1) 3-pin locking power connector for power (12VDC)
DIMENSIONS	1.34" H x 5.39" W x 6.1" D (34 x 137 x 155 mm)
WEIGHT	0.85 lb. (385 g)
OPERATION	
DEFAULT IP ADDRESS	EMD2000PE-DP-T: 192.168.1.22; EMD2000PE-DP-R: 192.168.1.21
ENCRYPTION	Secure Sockets Layer (SSL) over TCP/IP, 128-bit between transmitter and receiver, user set between receiver and virtual machine
DDC SUPPORT	Built-in/clone of remote
POWER	
POWER SOURCE	External in-line power supply
INPUT VOLTAGE	100–240 VAC, 50/60 Hz
INPUT CURRENT	1 Amp maximum
POWER CONSUMPTION	36 W maximum (Unit consumes 9 W)
HEAT DISSIPATION	122.76 BTW/hr maximum
OUTPUT CONNECTOR	3-pin locking connector (12 VDC, 3 Amp output)
INPUT CONNECTOR	IEC320, C14
POWER SUPPLY CORD LENGTH	6 ft. (1.8 m)
ENVIRONMENTAL	
OPERATING TEMPERATURE	32 to 104° F (0 to 40° C)
STORAGE TEMPERATURE	-4 to +140° F (-20 to 60° C)
OPERATING HUMIDITY	5 to 95%, noncondensing



CHAPTER 1: SPECIFICATIONS

NEED HELP?
LEAVE THE TECH TO US
**LIVE 24/7
TECHNICAL
SUPPORT**
1.877.877.2269

EMERALD PE DUAL-HEAD DISPLAYPORT TRANSMITTER (EMD2002PE-DP-T) AND RECEIVER (EMD2002PE-DP-R)

TRANSMITTER FRONT VIEW



RECEIVER FRONT VIEW



TRANSMITTER BACK VIEW



RECEIVER BACK VIEW



WHAT'S INCLUDED WITH THE TRANSMITTER (EMD2002PE-DP-T)

- (1) EMERALD PE DP TRANSMITTER, DUAL-HEAD
- (1) 12VDC POWER SUPPLY WITH POWER CORD
- (2) DISPLAYPORT™ CABLES
- (1) USB TYPE A TO B CABLE

WHAT'S INCLUDED WITH THE RECEIVER (EMD2002PE-DP-R)

- (1) EMERALD PE DP RECEIVER, DUAL-HEAD
- (1) 12VDC POWER SUPPLY WITH POWER CORD



CHAPTER 1: SPECIFICATIONS

SPECIFICATIONS FOR EMERALD PE DISPLAYPORT TRANSMITTER, DUAL-HEAD (EMD2002PE-DP-T)	
APPROVALS	
UNIT	Directive 2014/30/EU, CE, FCC, UKCA, 2011/65/EU, 2015/863/EU, Reach, TSCA
POWER SUPPLY	Directive 2014/35/EU, EN 62368-1:2014, UL, cUL, GS, PSE, BSMI, RCM, BIS, CB
PHYSICAL	
LED INTERFACE	(1) Power LED; (1) Network LED; (1) Video 1 Status LED; (1) Video 2 Status LED; (1) RJ-45 Speed LED (green, located on top left of RJ-45 connector): Blinks three times when the network connection is 1000 Mbps, Blinks two times when network connection is 100 Mbps, Blinks once when the network connection is 10 Mbps, Not blinking: No link to network; (1) Activity LED (green, located on top right of RJ-45 connector): Solid green: Link up, Blinking: Activity on the link, OFF: No link
MAXIMUM DISTANCE FROM CPU TO TRANSMITTER	5 m (16.4 ft.), DisplayPort™ and USB limitations
MAXIMUM DISTANCE BETWEEN TRANSMITTER AND RECEIVER	328 ft. (100m) CATx Fiber: Distance dependent on SFP and Fiber cable used
OPERATING SYSTEM SUPPORT	Microsoft Windows® 10/11, Server OS, Linux®, and Mac OS
CONNECTORS	EMD2002PE-DP-T: (2) DisplayPort female, (1) USB Type B female, (1) 3.5-mm audio, (1) RJ-45 Interconnect, 1Gbps, (1) SFP Interconnect, 1 Gbps (unpopulated), (1) USB Type B micro (Console), (1) 3-pin locking connector for power (12VDC); EMD2002PE-DP-R: (2) DisplayPort female, (4) USB Type A female, (1) 3.5-mm audio, (1) RJ-45 Interconnect, 1Gbps, (1) SFP Interconnect, 1 Gbps (unpopulated), (1) USB Type B micro (Console), (1) 3-pin locking connector for power (12VDC)
DIMENSIONS	1.34" H x 5.39" W x 6.1" D (34 x 137 x 155 mm)
WEIGHT	0.85 lb. (385 g)
OPERATION	
DEFAULT IP ADDRESS	EMD2002PE-DP-T: 192.168.1.22; EMD2002PE-DP-R: 192.168.1.21
ENCRYPTION	Secure Sockets Layer (SSL) over TCP/IP, 128-bit between transmitter and receiver, user set between receiver and virtual machines
DDC SUPPORT	Built-in/clone of remote
POWER	
POWER SOURCE	External in-line power supply
INPUT VOLTAGE	100–240 VAC, 50/60 Hz
INPUT CURRENT	1 Amp maximum
POWER CONSUMPTION	36 W maximum (Unit consumes 9.5 W)
HEAT DISSIPATION	122.76 BTW/hr maximum
OUTPUT CONNECTOR	3-pin locking connector (12 VDC, 3 Amp output)
INPUT CONNECTOR	IEC320, C14
POWER SUPPLY CORD LENGTH	6 ft. (1.8 m)
ENVIRONMENTAL	
OPERATING TEMPERATURE	32 to 104° F (0 to 40° C)
STORAGE TEMPERATURE	-4 to +140° F (-20 to 60° C)
OPERATING HUMIDITY	5 to 95%, noncondensing



CHAPTER 1: SPECIFICATIONS

NEED HELP?
LEAVE THE TECH TO US

**LIVE 24/7
TECHNICAL
SUPPORT**

1.877.877.2269

EMERALD SE SINGLE-HEAD TRANSMITTER (EMD2000SE-T) AND RECEIVER (EMD2000SE-R)

TRANSMITTER FRONT VIEW



RECEIVER FRONT VIEW



TRANSMITTER BACK VIEW



RECEIVER BACK VIEW



WHAT'S INCLUDED WITH THE TRANSMITTER (EMD2000SE-T*)

- (1) EMERALD SE TRANSMITTER, SINGLE-HEAD
- (1) 5VDC POWER SUPPLY WITH POWER CORD

WHAT'S INCLUDED WITH THE RECEIVER (EMD2000SE-R)

- (1) EMERALD SE RECEIVER, SINGLE-HEAD
- (1) 5VDC POWER SUPPLY WITH POWER CORD

* EMD2000SE-T IS EOL. IT IS REPLACED BY EMD2000SE-T-R2.

SPECIFICATIONS FOR EMERALD SE TRANSMITTER AND RECEIVER, SINGLE-HEAD (EMD2000SE-T AND EMD2000SE-R)

APPROVALS	
UNIT	Directive 2014/30/EU, CE, FCC, UKCA, 2011/65/EU, 2015/863/EU, Reach, TSCA, CB
POWER SUPPLY	Directive 2014/35/EU, EN 62368-1:2014, UL, cUL, GS, PSE, BSMI, RCM, BIS
PHYSICAL	
LED INTERFACE	(1) Power LED/button; NOTE: Unit automatically powers on when plugged in; must be powered off at the power source. (1) RJ-45 Speed LED (green, located on top left of RJ-45 connector): Blinks three times when the network connection is 1000 Mbps, Blinks two times when network connection is 100 Mbps, Blinks once when the network connection is 10 Mbps, Not blinking: No link to network; (1) Activity LED (green, located on top right of RJ-45 connector): Solid green: Link up, Blinking: Activity on the link, OFF: No link
MAXIMUM DISTANCE FROM CPU TO TRANSMITTER	5 m (16.4 ft.), DVI-D and USB limitations
MAXIMUM DISTANCE BETWEEN TRANSMITTER AND RECEIVER	328 ft. (100 m), use a network switch to get farther distances
OPERATING SYSTEM SUPPORT	Microsoft Windows® 10/11, Server OS, Linux®, and Mac OS
CONNECTORS	EMD2000SE-T: (1) DVI input, (1) USB Type B female, (1) RJ-45 network (10/100/1000BASE-T), (1) RJ-45 serial, (2) 3.5-mm audio, (1) 2.5-mm barrel for power; EMD2000SE-R: (1) DVI output, (4) USB Type A female, (1) RJ-45 network (10/100/1000BASE-T), (1) DB9 serial, (2) 3.5-mm audio for SPK and MIC, (1) 2.5-mm barrel for power
DIMENSIONS	1.15" H x 6.2" W x 4.2" D (29 x 157 x 107 mm)
WEIGHT	1.18 lb. (535 g)
OPERATION	
DEFAULT IP ADDRESS	EMD2000SE-T: 192.168.1.22; EMD2000SE-R: 192.168.1.21
ENCRYPTION	Secure Sockets Layer (SSL) over TCP/IP, 128-bit between transmitter and receiver, user set between receiver and virtual machine
DEFAULT USERNAME	admin
DEFAULT PASSWORD	The password is blank by default.
DDC SUPPORT	Built-in/clone of remote
POWER	
POWER SOURCE	External in-line power supply
INPUT VOLTAGE	100–240 VAC, 50/60 Hz
INPUT CURRENT	0.9 Amps maximum
POWER CONSUMPTION	Unit: 6.5 W with keyboard and mouse attached; Power supply: 20 W to support USB-based powered devices
HEAT DISSIPATION	68.2 BTW/hr maximum
OUTPUT CONNECTOR	2.5-mm barrel (5 VDC, 4 Amp output)
INPUT CONNECTOR	IEC-320, C8
POWER SUPPLY CORD LENGTH	6 ft. (1.8 m)
ENVIRONMENTAL	
OPERATING TEMPERATURE	32 to 104° F (0 to 40° C)
STORAGE TEMPERATURE	-4 to +140° F (-20 to 60° C)
OPERATING HUMIDITY	5 to 95%, noncondensing



CHAPTER 1: SPECIFICATIONS

EMERALD SE SINGLE-HEAD TRANSMITTER (EMD2000SE-T-R2)

EMD2000SE-T-R2 FRONT VIEW



EMD2000SE-T-R2- BACK VIEW



WHAT'S INCLUDED WITH THE SINGLE-HEAD TRANSMITTER (EMD2000SE-T-R2)

- (1) EMERALD SE-R2 TRANSMITTER
- (1) 5VDC POWER SUPPLY WITH POWER CORD

CHAPTER 1: SPECIFICATIONS

SPECIFICATIONS FOR EMERALD SE SINGLE-HEAD TRANSMITTER (EMD2000SE-T-R2)

APPROVALS	
UNIT	Directive 2014/30/EU, CE, FCC, UKCA, 2011/65/EU, 2015/863/EU, Reach, TSCA
POWER SUPPLY	Directive 2014/35/EU, EN 62368-1:2014, UL, cUL, GS, PSE, BSMI, RCM, BIS
PHYSICAL	
LED INTERFACE	(1) Power LED; (1) Network LED; (1) Video 1 Status LED; (1) RJ-45 Speed LED (green, located on top left of RJ-45 connector): Blinks three times when the network connection is 1000 Mbps, Blinks two times when network connection is 100 Mbps, Blinks once when the network connection is 10 Mbps, Not blinking: No link to network; (1) Activity LED (green, located on top right of RJ-45 connector): Solid green: Link up, Blinking: Activity on the link, OFF: No link
MAXIMUM DISTANCE FROM CPU TO TRANSMITTER	5 m (16.4 ft.), DVI-D and USB limitations
MAXIMUM DISTANCE BETWEEN TRANSMITTER AND RECEIVER	328 ft. (100 m), use a network switch to get farther distances
OPERATING SYSTEM SUPPORT	Microsoft Windows® 10/11, Server OS, Linux®, and Mac OS
CONNECTORS	(1) DVI-D female, (1) USB Type B female, (1) 3.5-mm audio; (1) RJ-45 Interconnect, 1Gbps, (1) USB Type B micro (Console), (1) 2.5-mm barrel connector for power
DIMENSIONS	1.34" H x 6.1" W x 6.07" D (34 x 137 x 155 mm)
WEIGHT	0.78 lb. (355 g)
OPERATION	
DEFAULT IP ADDRESS	192.168.1.22
ENCRYPTION	Secure Sockets Layer (SSL) over TCP/IP, 128-bit between transmitter and receiver, user set between receiver and virtual machine
DDC SUPPORT	Built-in/clone of remote
POWER	
POWER SOURCE	External in-line power supply
INPUT VOLTAGE	100–240 VAC, 50/60 Hz
INPUT CURRENT	0.9 Amps maximum
POWER CONSUMPTION	Unit: 6.5 W with keyboard and mouse attached Power supply: 20 W to support USB-based powered devices
HEAT DISSIPATION	68.2 BTW/hr maximum
OUTPUT CONNECTOR	2.5-mm barrel (5 VDC, 4 Amp output)
INPUT CONNECTOR	IEC-320, C8
POWER SUPPLY CORD LENGTH	6 ft. (1.8 m)
ENVIRONMENTAL	
OPERATING TEMPERATURE	32 to 104° F (0 to 40° C)
STORAGE TEMPERATURE	-4 to +140° F (-20 to 60° C)
OPERATING HUMIDITY	5 to 95%, noncondensing



CHAPTER 1: SPECIFICATIONS

EMERALD SE DUAL-HEAD TRANSMITTER (EMD2002SE-T) AND RECEIVER (EMD2002SE-R)

TRANSMITTER FRONT VIEW



RECEIVER FRONT VIEW



TRANSMITTER BACK VIEW



RECEIVER BACK VIEW



WHAT'S INCLUDED WITH THE TRANSMITTER (EMD2002SE-T*)

- ♦ (1) EMERALD SE TRANSMITTER, DUAL-HEAD
- ♦ (1) 5VDC POWER SUPPLY WITH POWER CORD

WHAT'S INCLUDED WITH THE RECEIVER (EMD2002SE-R)

- ♦ (1) EMERALD SE RECEIVER, DUAL-HEAD
- ♦ (1) 5VDC POWER SUPPLY WITH POWER CORD

* EMD2002SE-T IS EOL. IT IS REPLACED BY EMD2002PE-T-R2.

CHAPTER 1: SPECIFICATIONS

SPECIFICATIONS FOR EMERALD SE TRANSMITTER AND RECEIVER, DUAL-HEAD (EMD2002SE-T AND EMD2002SE-R)

APPROVALS	
UNIT	Directive 2014/30/EU, CE, FCC, UKCA, 2011/65/EU, 2015/863/EU, Reach, TSCA, CB
POWER SUPPLY	Directive 2014/35/EU, EN 62368-1:2014, UL, cUL, GS, PSE, BSMI, RCM, BIS
PHYSICAL	
LED INTERFACE	(1) Power LED/button; NOTE: Unit automatically powers on when plugged in; must be powered off at the power source. (1) RJ-45 Speed LED (green, located on top left of RJ-45 connector): Blinks three times when the network connection is 1000 Mbps, Blinks two times when network connection is 100 Mbps, Blinks once when the network connection is 10 Mbps, Not blinking: No link to network; (1) Activity LED (green, located on top right of RJ-45 connector): Solid green: Link up, Blinking: Activity on the link, OFF: No link
MAXIMUM DISTANCE FROM CPU TO TRANSMITTER	5 m (16.4 ft.), DVI-D and USB limitations
MAXIMUM DISTANCE BETWEEN TRANSMITTER AND RECEIVER	328 ft. (100 m), use a network switch to get farther distances
OPERATING SYSTEM SUPPORT	Microsoft Windows® 10/11, Server OS, Linux®, and Mac OS
CONNECTORS	EMD2002SE-T: (2) DVI inputs, (1) USB Type B female, (1) RJ-45 network (10/100/1000BASE-T), (2) 3.5-mm audio, (1) 2.5-mm barrel for power; EMD2002SE-R: (2) DVI outputs, (4) USB Type A female, (1) RJ-45 network (10/100/1000BASE-T), (2) 3.5-mm audio for SPK and MIC, (1) 2.5-mm barrel for power
DIMENSIONS	EMD2002SE-T: 1.43" H x 6.2" W x 4.2" D (36 x 157 x 107 mm); EMD2002SE-R: 1.15" H x 6.2" W x 4.2" D (29 x 157 x 107 mm)
WEIGHT	EMD2002SE-T: 1.47 lb. (667 g); EMD2002SE-R: 1.36 lb. (617 g)
OPERATION	
DEFAULT IP ADDRESS	EMD2002SE-T: 192.168.1.22; EMD2002SE-R: 192.168.1.21
ENCRYPTION	Secure Sockets Layer (SSL) over TCP/IP, 128-bit between transmitter and receiver, user set between receiver and virtual machine
DEFAULT USERNAME	admin
DEFAULT PASSWORD	The password is blank by default.
DDC SUPPORT	Built-in/clone of remote
POWER	
POWER SOURCE	External in-line power supply
INPUT VOLTAGE	100–240 VAC, 50/60 Hz
INPUT CURRENT	0.9 Amps maximum
POWER CONSUMPTION	Unit: 6.5 W with keyboard and mouse attached; Power supply: 20 W to support USB-based powered devices
HEAT DISSIPATION	68.2 BTW/hr maximum
OUTPUT CONNECTOR	2.5-mm barrel (5 VDC, 4 Amp output)
INPUT CONNECTOR	IEC-320, C8
POWER SUPPLY CORD LENGTH	6 ft. (1.8 m)
ENVIRONMENTAL	
OPERATING TEMPERATURE	32 to 104° F (0 to 40° C)
STORAGE TEMPERATURE	-4 to +140° F (-20 to 60° C)
OPERATING HUMIDITY	5 to 95%, noncondensing



CHAPTER 1: SPECIFICATIONS

EMERALD PE SINGLE-HEAD TRANSMITTER (EMD2000PE-T-R2)

EMD2000PE-T-R2 FRONT VIEW



EMD2000PE-T-R2 BACK VIEW



WHAT'S INCLUDED WITH THE TRANSMITTER (EMD2000PE-T-R2)

- (1) EMERALD PE TRANSMITTER, SINGLE-HEAD
- (1) 12VDC POWER SUPPLY WITH POWER CORD
- (1) DVI CABLE
- (1) USB 2.0 TYPE B CABLE

CHAPTER 1: SPECIFICATIONS

SPECIFICATIONS FOR EMERALD PE SINGLE-HEAD TRANSMITTER (EMD2000PE-T-R2)	
APPROVALS	
UNIT	Directive 2014/30/EU, CE, FCC, ICES, UKCA, 2011/65/EU, 2015/863/EU, Reach, TSCA
POWER SUPPLY	Directive 2014/35/EU, EN 62368-1:2014, UL, cUL, GS, PSE, BSMI, RCM, BIS, CB
PHYSICAL	
LED INTERFACE	(1) Power LED; (1) Network LED; (1) Video 1 Status LED; (1) RJ-45 Speed LED (green, located on top left of RJ-45 connector): Blinks three times when the network connection is 1000 Mbps, Blinks two times when network connection is 100 Mbps, Blinks once when the network connection is 10 Mbps, Not blinking: No link to network; (1) Activity LED (green, located on top right of RJ-45 connector): Solid green: Link up, Blinking: Activity on the link, OFF: No link
MAXIMUM DISTANCE FROM CPU TO TRANSMITTER	5 m (16.4 ft.), DVI-D and USB limitations
MAXIMUM DISTANCE BETWEEN TRANSMITTER AND RECEIVER	328 ft. (100 m), use a network switch to get farther distances
OPERATING SYSTEM SUPPORT	Microsoft Windows® 10/11, Server OS, Linux®, and Mac OS
CONNECTORS	(1) DVI input, (1) USB Type B female, (1) RJ-45 network, (1) SFP network, (1) 3.5-mm audio, (1) 3-pin locking connector for power, (1) Micro USB connector;
DIMENSIONS	1.34" H x 7.64" W x 5.83" D (34 x 194 x 148 mm)
WEIGHT	1.03 lb. (468 g)
OPERATION	
DEFAULT IP ADDRESS	192.168.1.22
ENCRYPTION	Secure Sockets Layer (SSL) over TCP/IP, 128-bit between transmitter and receiver, user set between receiver and virtual machine
DDC SUPPORT	Built-in/clone of remote
POWER	
POWER SOURCE	External in-line power supply
INPUT VOLTAGE	100–240 VAC, 50/60 Hz
INPUT CURRENT	1 Amp maximum
POWER CONSUMPTION	Unit: 7.5 W with keyboard and mouse attached; Power supply: 36 W to support USB-based powered devices
HEAT DISSIPATION	122.76 BTW/hr maximum
OUTPUT CONNECTOR	3-pin locking connector (12 VDC, 3 Amp output)
INPUT CONNECTOR	IEC-320, C14
POWER SUPPLY CORD LENGTH	6 ft. (1.8 m)
ENVIRONMENTAL	
OPERATING TEMPERATURE	32 to 104° F (0 to 40° C)
STORAGE TEMPERATURE	-4 to +140° F (-20 to 60° C)
OPERATING HUMIDITY	5 to 95%, noncondensing



EMERALD PE DUAL-HEAD TRANSMITTER (EMD2002PE-T-R2)

EMD2002PE-T-R2 FRONT VIEW



EMD2002PE-T-R2 BACK VIEW



WHAT'S INCLUDED WITH THE TRANSMITTER (EMD2002PE-T-R2)

- (1) EMERALD PE TRANSMITTER, DUAL-HEAD
- (1) 12VDC POWER SUPPLY WITH POWER CORD
- (2) DVI CABLES
- (1) USB 2.0 TYPE B CABLE

CHAPTER 1: SPECIFICATIONS

SPECIFICATIONS FOR EMERALD PE DUAL-HEAD TRANSMITTER (EMD2002PE-T-R2)	
APPROVALS	
UNIT	Directive 2014/30/EU, CE, FCC, ICES, UKCA, 2011/65/EU, 2015/863/EU, Reach, TSCA
POWER SUPPLY	Directive 2014/35/EU, EN 62368-1:2014, UL, cUL, GS, PSE, BSMI, RCM, BIS, CB
PHYSICAL	
LED INTERFACE	(1) Power LED; (1) Network LED; (1) Video 1 Status LED; (1) Video 2 Status LED; (1) RJ-45 Speed LED (green, located on top left of RJ-45 connector): Blinks three times when the network connection is 1000 Mbps, Blinks two times when network connection is 100 Mbps, Blinks once when the network connection is 10 Mbps, Not blinking: No link to network; (1) Activity LED (green, located on top right of RJ-45 connector): Solid green: Link up, Blinking: Activity on the link, OFF: No link
MAXIMUM DISTANCE FROM CPU TO TRANSMITTER	5 m (16.4 ft.), DVI-D and USB limitations
MAXIMUM DISTANCE BETWEEN TRANSMITTER AND RECEIVER	328 ft. (100 m), use a network switch to get farther distances
OPERATING SYSTEM SUPPORT	Microsoft Windows® 10/11, Server OS, Linux®, and Mac OS
CONNECTORS	(2) DVI input, (1) USB Type B female, (1) RJ-45 network, (1) SFP network, (1) 3.5-mm audio, (1) 3-pin locking connector for power, (1) Micro USB connector
DIMENSIONS	1.32" H x 7.62" W x 5.79" D (34 x 194 x 147 mm)
WEIGHT	1.04 lb. (474 g)
OPERATION	
DEFAULT IP ADDRESS	192.168.1.22
ENCRYPTION	Secure Sockets Layer (SSL) over TCP/IP, 128-bit between transmitter and receiver, user set between receiver and virtual machine
DDC SUPPORT	Built-in/clone of remote
POWER	
POWER SOURCE	External in-line power supply
INPUT VOLTAGE	100–240 VAC, 50/60 Hz
INPUT CURRENT	0.9 Amps maximum
POWER CONSUMPTION	Unit: 7.5 W with keyboard and mouse attached; Power supply: 36 W to support USB-based powered devices
HEAT DISSIPATION	122.76 BTW/hr maximum
OUTPUT CONNECTOR	3-pin locking connector (12 VDC, 3 Amp output)
INPUT CONNECTOR	IEC-320, C14
POWER SUPPLY CORD LENGTH	6 ft. (1.8 m)
ENVIRONMENTAL	
OPERATING TEMPERATURE	32 to 104° F (0 to 40° C)
STORAGE TEMPERATURE	-4 to +140° F (-20 to 60° C)
OPERATING HUMIDITY	5 to 95%, noncondensing



CHAPTER 1: SPECIFICATIONS

NEED HELP?
LEAVE THE TECH TO US
**LIVE 24/7
TECHNICAL
SUPPORT**
1.877.877.2269

EMERALD SE SINGLE-HEAD DISPLAYPORT TRANSMITTER (EMD2000SE-DP-T) AND RECEIVER (EMD2000SE-DP-R)

TRANSMITTER FRONT VIEW



RECEIVER FRONT VIEW



TRANSMITTER BACK VIEW



RECEIVER BACK VIEW



WHAT'S INCLUDED WITH THE TRANSMITTER (EMD2000SE-DP-T)

- (1) EMERALD SE DP TRANSMITTER, SINGLE-HEAD
- (1) 5VDC POWER SUPPLY WITH POWER CORD

WHAT'S INCLUDED WITH THE RECEIVER (EMD2000SE-DP-R)

- (1) EMERALD SE DP RECEIVER, SINGLE-HEAD
- (1) 5VDC POWER SUPPLY WITH POWER CORD

CHAPTER 1: SPECIFICATIONS

SPECIFICATIONS FOR EMERALD SE DISPLAYPORT TRANSMITTER, SINGLE-HEAD (EMD2000SE-DP-T) AND RECEIVER (EMD2000SE-DP-R)

APPROVALS	
UNIT	Directive 2014/30/EU, CE, FCC, UKCA, 2011/65/EU, 2015/863/EU, Reach, TSCA
POWER SUPPLY	Directive 2014/35/EU, EN 62368-1:2014, UL, cUL, GS, PSE, BSMI, RCM, BIS
PHYSICAL	
LED INTERFACE	(1) Power LED; NOTE: Unit automatically powers on when plugged in; must be powered off at the power source. (1) RJ-45 Speed LED (green, located on top left of RJ-45 connector): Blinks three times when the network connection is 1000 Mbps, Blinks two times when network connection is 100 Mbps, Blinks once when the network connection is 10 Mbps, Not blinking: No link to network; (1) Activity LED (green, located on top right of RJ-45 connector): Solid green: Link up, Blinking: Activity on the link, OFF: No link
MAXIMUM DISTANCE FROM CPU TO TRANSMITTER	5 m (16.4 feet), DisplayPort™ and USB limitations
MAXIMUM DISTANCE BETWEEN TRANSMITTER AND RECEIVER	328 ft. (100 m), use a network switch to get farther distances
OPERATING SYSTEM SUPPORT	Microsoft Windows® 10/11, Server OS, Linux®, and Mac OS
CONNECTORS	EMD2000SE-DP-T: (1) DisplayPort input, (1) USB Type B, (1) RJ-45 network, (1) 3.5-mm audio, (1) 2.5-mm barrel connector for power, (1) RJ-45 Serial Console Connector; EMD2000SE-DP-R: (1) DisplayPort input, (4) USB Type A, (1) RJ-45 network, (1) 3.5-mm audio, (1) 2.5-mm barrel connector for power, (1) RJ-45 Serial Console Connector
DIMENSIONS	1.34" H x 5.39" W x 6.07" D (34 x 137 x 154 mm)
WEIGHT	0.73 lb. (335 g)
OPERATION	
DEFAULT IP ADDRESS	EMD2000SE-DP-T: 192.168.1.22; EMD2000SE-DP-R: 192.168.1.21
ENCRYPTION	Secure Sockets Layer (SSL) over TCP/IP, 128-bit between transmitter and receiver, user set between receiver and virtual machines
DDC SUPPORT	Built-in/clone of remote
POWER	
POWER SOURCE	External in-line power supply
INPUT VOLTAGE	100–240 VAC, 50/60 Hz
INPUT CURRENT	0.9 Amps maximum
POWER CONSUMPTION	Unit: 6.5 W with keyboard and mouse attached; Power supply: 20 W to support USB-based powered devices
HEAT DISSIPATION	68.2 BTU/hr maximum
OUTPUT CONNECTOR	2.5-mm barrel (5 VDC, 4 Amp output)
INPUT CONNECTOR	IEC-320, C8
POWER SUPPLY CORD LENGTH	6 ft. (1.8 m)
ENVIRONMENTAL	
OPERATING TEMPERATURE	32 to 104° F (0 to 40° C)
STORAGE TEMPERATURE	-4 to +140° F (-20 to 60° C)
OPERATING HUMIDITY	5 to 95%, noncondensing



EMERALD SE DUAL-HEAD DISPLAYPORT TRANSMITTER (EMD2002SE-DP-T) AND RECEIVER (EMD2002SE-DP-R)

TRANSMITTER FRONT VIEW



RECEIVER FRONT VIEW



TRANSMITTER BACK VIEW



RECEIVER BACK VIEW



WHAT'S INCLUDED WITH THE TRANSMITTER (EMD2002SE-DP-T)

- (1) EMERALD SE DP TRANSMITTER, DUAL-HEAD
- (1) 12VDC POWER SUPPLY WITH POWER CORD

WHAT'S INCLUDED WITH THE RECEIVER (EMD2002SE-DP-R)

- (1) EMERALD SE DP RECEIVER, DUAL-HEAD
- (1) 12VDC POWER SUPPLY WITH POWER CORD

CHAPTER 1: SPECIFICATIONS

SPECIFICATIONS FOR EMERALD SE DISPLAYPORT TRANSMITTER, DUAL-HEAD (EMD2002SE-DP-T) AND RECEIVER (EMD2002SE-DP-R)

APPROVALS	
UNIT	Directive 2014/30/EU, CE, FCC, UKCA, 2011/65/EU, 2015/863/EU, Reach, TSCA
POWER SUPPLY	Directive 2014/35/EU, EN 62368-1:2014, UL, cUL, GS, PSE, BSMI, RCM, BIS, CB
PHYSICAL	
LED INTERFACE	(1) Power LED; NOTE: Unit automatically powers on when plugged in; must be powered off at the power source. (1) RJ-45 Speed LED (green, located on top left of RJ-45 connector): Blinks three times when the network connection is 1000 Mbps, Blinks two times when network connection is 100 Mbps, Blinks once when the network connection is 10 Mbps, Not blinking: No link to network; (1) Activity LED (green, located on top right of RJ-45 connector): Solid green: Link up, Blinking: Activity on the link, OFF: No link
MAXIMUM DISTANCE FROM CPU TO TRANSMITTER	5 m (16.4 ft.), DisplayPort™ and USB limitations
MAXIMUM DISTANCE BETWEEN TRANSMITTER AND RECEIVER	328 ft. (100 m), use a network switch to get farther distances
OPERATING SYSTEM SUPPORT	Microsoft Windows® 10/11, Server OS, Linux®, and Mac OS
CONNECTORS	EMD2002SE-DP-T: (2) DisplayPort female, (1) USB Type B female, (1) 3.5-mm audio, (1) RJ-45 Interconnect, 1Gbps, (1) USB Type B micro (Console), (1) 3-pin locking connector for power (12VDC); EMD2002SE-DP-R: (2) DisplayPort female, (4) USB Type A female, (1) 3.5-mm audio, (1) RJ-45 Interconnect, 1Gbps, (1) USB Type B micro (Console), (1) 2.5-mm barrel for power (5VDC)
DIMENSIONS	1.34" H x 5.39" W x 6.07" D (34 x 137 x 154 mm)
WEIGHT	EMD2002SE-DP-T: 0.77 lbs (350 g) EMD2002SE-DP-R: 0.85 lbs (385 g)
OPERATION	
DEFAULT IP ADDRESS	EMD2002SE-DP-T: 192.168.1.22; EMD2002SE-DP-R: 192.168.1.21
ENCRYPTION	Secure Sockets Layer (SSL) over TCP/IP, 128-bit between transmitter and receiver, user set between receiver and virtual machine
DDC SUPPORT	Built-in/clone of remote
POWER	
POWER SOURCE	External in-line power supply
INPUT VOLTAGE	100–240 VAC, 50/60 Hz
INPUT CURRENT	1 Amp maximum
POWER CONSUMPTION	Unit: 9 W with keyboard and mouse attached; Power supply: 36 W to support USB-based powered devices
HEAT DISSIPATION	EMD2002SE-DP-T: 122.76 BTU/h maximum; EMD2002SE-DP-R: 68.2 BTU/h maximum
OUTPUT CONNECTOR	EMD2002SE-DP-T: 3-pin locking connector (12 VDC, 3 Amp output) EMD2002SE-DP-R: 2.5mm barrel (5 VDC, 4 Amp output)
INPUT CONNECTOR	IEC-320, C14
POWER SUPPLY CORD LENGTH	6 ft. (1.8 m)
ENVIRONMENTAL	
OPERATING TEMPERATURE	32 to 104° F (0 to 40° C)
STORAGE TEMPERATURE	-4 to +140° F (-20 to 60° C)
OPERATING HUMIDITY	5 to 95%, noncondensing



4K SINGLE-HEAD TRANSMITTER AND RECEIVER (EMD4000T AND EMD4000R)

FRONT VIEW

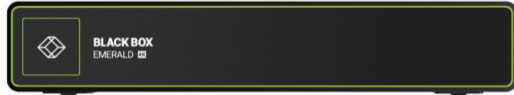

EMD4000T

FRONT VIEW

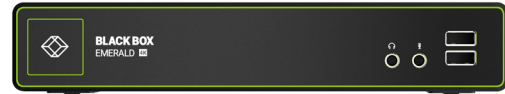

EMD4000R

BACK VIEW



EMD4000T

BACK VIEW



EMD4000R

WHAT'S INCLUDED WITH THE TRANSMITTER

- (1) TRANSMITTER
- (1) 12VDC POWER SUPPLY WITH POWER CORD
- (1) DISPLAYPORT M/M CABLE
- (1) USB TYPE A TO B CABLE

WHAT'S INCLUDED WITH THE RECEIVER

- (1) RECEIVER
- (1) 12VDC POWER SUPPLY WITH POWER CORD

NOTE: SFP+ sold separately.

4K SINGLE-HEAD TRANSMITTER AND RECEIVER (EMD4000T AND EMD4000R)

4K SINGLE-HEAD EXTENDER (EMD4000R AND EMD4000T)	
APPROVALS	Unit: Directive 2014/30/EU, CE, FCC, ICES, UKCA, 2011/65/EU, 2015/863/EU, Reach, TSCA, CB Power Supply: Directive 2014/35/EU, EN 62368-1:2014, UL, cUL, GS, PSE, BSMI, CB, RCM, BIS
CONNECTORS	Transmitter: (1) DisplayPort™, (1) Power, (1) DB9 serial, (1) USB Type B, (1) RJ-45, (2) SFP+ cages (10GBASE-X), (2) 3.5-mm audio; Receiver: (1) DisplayPort, (1) Power, (1) DB9 serial, (4) USB Type A, (1) RJ-45, (2) SFP+ cages, (2) 3.5-mm audio
DISTANCE	Distance between Transmitter and Receiver: in IP mode: Unlimited using IP rules; in Direct Connect mode: CATx: 328 ft. (100 m); Fiber: 984.2 ft. to 6.2 mi. (300 m to 10 km), based on SFP used
INDICATORS	(1) single bi-color LED (red/green)
MAXIMUM RESOLUTION	4096 x 2160 @ 60 Hz
MATERIAL	Aluminum outer case with plastic bezel
OPERATING SYSTEMS SUPPORTED	Microsoft Windows® 10/11, Server OS, Linux®, Mac OS
OPERATION	Default IP Address for Transmitter:192.168.1.22; Default IP Address for Receiver: 192.168.1.21; Default Username: admin; Default Password: Blank password by default, just press the Enter key; EDID Support: Internal EDID table in transmitter (can be updated from a receiver or manager or real monitor EDID can be used if cloned); Encryption: Secure Sockets Layer (SSL) over a TCP/IP up to 128-bit for transmitter to receiver with virtualized targets, depending on configuration
ENVIRONMENTAL	Operating Temperature: 32 to 104° F (0 to 40° C); Storage Temperature: -4°F to 140°F (-20° C to 60° C); Operating Humidity: 5–95%
POWER	External desktop-style adapter, 100–240 VAC input, 12 VDC, 3 A connection to unit
DIMENSIONS	Each unit: 1.5" H x 8.5" W x 7.4" D (38 x 216 x 188 mm)
WEIGHT	EMD4000T: 2.50 lb. (1.1 kg); EMD4000R: 2.55 lb. (1.2 kg)



CHAPTER 1: SPECIFICATIONS

1.2 LICENSING

There are 2 options for managing Emerald® transmitters and receivers:

- ◆ Option 1 (for small unmanaged matrices that have less than 32 connections and users): Using built-in receiver manager
- ◆ Option 2 (for large managed matrices with more than 32 connections and users): Using Boxilla® BXAMGR or BXAMGR-R2

NOTE: For managed installations with more than 32 users, you will need to use Boxilla KVM Manager. The basic Boxilla license (BXAMGR-R2) supports 25 users, 25 devices, and 25 connections.

Other available licenses for Boxilla are listed below:

- ◆ Boxilla Manager with 25 Endpoint Licenses (BXAMGR-R2)
- ◆ Boxilla Manager with 75 Endpoint Licenses (BXAMGR-R2-75)
- ◆ Boxilla Manager with 125 Endpoint Licenses (BXAMGR-R2-125)
- ◆ Boxilla Manager with 225 Endpoint Licenses (BXAMGR-R2-225)
- ◆ Boxilla Manager with 325 Endpoint Licenses (BXAMGR-R2-325)
- ◆ Boxilla Manager with Unlimited Endpoint Licenses (BXAMGR-R2-ULT)

Available upgrade licenses for Boxilla are listed below:

- ◆ Add 25 Users, Devices or Connections (BXAMGR-LIC-25)
- ◆ Add 100 Users, Devices or Connections (BXAMGR-LIC-100)
- ◆ Add 200 Users, Devices or Connections (BXAMGR-LIC-200)
- ◆ Add 300 Users, Devices or Connections (BXAMGR-LIC-300)
- ◆ Add Unlimited Users, Devices or Connections (BXAMGR-LIC-ULT)

License bundles are recommended when the system contains two Boxilla managers in a primary/backup configuration. The bundle will provide the same license to the primary and backup so that they match.

Licenses for active and standby Boxilla are listed below:

- ◆ 25 Devices (BXAMGR-LICBAK25)
- ◆ 100 Devices (BXAMGR-LICBAK100)
- ◆ 200 Devices (BXAMGR-LICBAK200)
- ◆ 300 Devices (BXAMGR-LICBAK300)

CHAPTER 2: OVERVIEW

The Emerald® system provides users with a seamless desktop experience anywhere on a TCP/IP network, while allowing the actual hardware to be securely housed in a corporate data center or in the cloud. Emerald enables the same high-fidelity experience of a desktop PC even for media-rich applications, such as watching videos, photo editing with Photoshop, or 3D design with AutoCAD. The remote desktops may be hosted on a physical PC/workstation, or they may be a virtual desktop hosted on a private server or in the cloud. The Emerald system provides its users with receivers that communicate with target computer nodes (whether physical PC or virtual desktop) over a standard TCP/IP network. Physical PCs/workstations/servers have an Emerald SE or PE transmitter unit or Emerald ZeroU DVI or DisplayPort™ transmitter unit physically connected to provide communication over the TCP/IP network. The performance of Emerald allows them to be deployed on standard corporate networks and even across Wide-Area-Networks (WANs).

Desktop users can access remote keyboard, mouse, video, audio, USB mass storage devices, headsets and other USB devices from the receiver unit to the remote PC/workstations or virtual desktop via the Emerald system.

NOTE: Not all USB 2.0 devices are supported depending on how they negotiate/communicate with the host. If you find your USB 2.0 device isn't working properly, report these devices to Black Box.

NOTE: References to the Emerald 2K system in this document refer to both receivers (EMD2000PE-R, EMD2000SE-R, EMD2002PE-R, EMD2000PE-R-P, EMD2002PE-R-P, EMD2002SE-R, EMD2000SE-DP-R, EMD2002SE-DP-R, EMD2000PE-DP-R, and EMD2002PE-DP-R) and transmitters (EMD200DV-T, EMD2000PE-DP-T, EMD2000PE-T, EMD2000PE-T-P, EMD2000SE-DP-T, EMD2000SE-T, EMD2000SE-T-R2, EMD2002PE-DP-T, EMD2002PE-T, EMD2002PE-T-P, EMD2002SE-DP-T, EMD2002SE-T, EMD2000PE-T-R2, and EMD2002PE-T-R2). The Emerald 2K ZeroU DVI or DisplayPort transmitter (EMD200DP-T, EMD200DV-T) can be used in place of the SE or PE transmitter where rack space is limited, but these devices cannot support USB redirection. The Emerald 4K system in this document refers to the EMD4000T (transmitter) and EMD4000R (receiver).



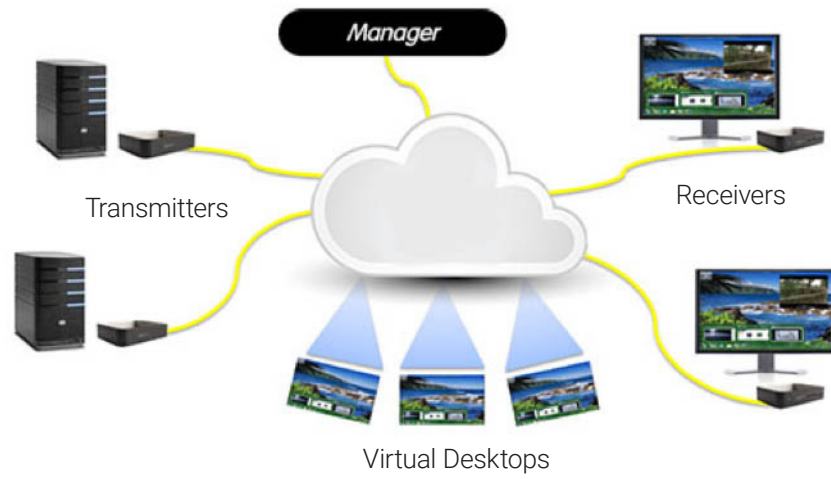

FIGURE 2-1. EMERALD EXAMPLE—INCLUDING PHYSICAL AND VIRTUAL DESKTOPS

CHAPTER 2: OVERVIEW

2.1 EMERALD SYSTEM FEATURES

Emerald® leverages state-of-the-art technologies in compression, networking, and latency management. Some of the key features of Emerald are:

- ♦ **Pixel-Perfect Video Quality:** The Emerald system uses a compound compression algorithm to provide a lossless video experience at a low-network bandwidth. None of the bandwidth variability and noise effects of analog extension schemes exist.
- ♦ **Uses Unicast stream for shared mode** to allow scaling of the number of users that can share a transmitter. Analog audio can now be shared in a shared mode connection.
- ♦ **Seamless integration of Physical and Virtual Desktops:** The Emerald system connects to physical PCs, servers, and video sources as well as virtual desktops hosted on servers or in the cloud. This allows seamless connection to physical resources and virtual resources from the same receiver unit. IT professionals use this capability to optimize their deployments and migrations to cloud services.
- ♦ **High Reliability and Highly Secure:** The Emerald system minimizes maintenance for administrators. The intuitive On-Screen Display (OSD) is simple to learn and understand. The individual units have no moving parts to minimize potential for hardware failures. All media streams transmitted between the Emerald devices are encrypted using 128-bit SSL. Password protection is also provided to control access to all administration functions.
- ♦ **Environmentally Optimized:** The Emerald system is optimized to minimize power requirements and eliminate noise. All receivers and transmitters consume less than 9 watts of power and are completely silent.
- ♦ **Easy Deployment:** The Emerald system is designed to be easily and quickly deployed. No new drivers or software need to be installed on target PCs or virtual desktops (unless RemoteApp and/or DESKVUE is being used and the transmitter HID setting is set for Absolute, which requires ABS Multiscreen drivers). The system uses standard networking protocols and cabling. Users and connections are defined using an intuitive OSD. Connections can be made by clicking on target. Multiple modes of operation, such as private connections, shared connections, auto-login, and auto-connect, enable various workflows and collaborations to be supported. Analog audio can now be shared in a shared mode connection.
- ♦ **The Emerald ZeroU DVI or DisplayPort™ transmitter** features a small form factor to use zero rack space—you save money when rack space is expensive. This transmitter can be powered over USB or via an optional power supply.



CHAPTER 2: OVERVIEW

2.2 OVERVIEW OF EMERALD DEVICES

The Emerald family is composed of 11 receivers, 16 transmitters, and a Boxilla Manager.

TABLE 2-1. EMERALD MODELS

RECEIVER	NUMBER OF VIDEO HEADS	USB PORTS	SERIAL	AUDIO	POE	DVI CPU CABLE	DISPLAYPORT CPU CABLE	USB CPU CABLE
EMD2000SE-R	(1) DVI	(4) USB 2.0 Type A	Yes	Yes	No	Not applicable	Not applicable	Not applicable
EMD2002SE-R	(2) DVI	(4) USB 2.0 Type A	No	Yes	No	Not applicable	Not applicable	Not applicable
EMD2000PE-R	(1) DVI	(4) USB 2.0 Type A	No	Yes	No	Not applicable	Not applicable	Not applicable
EMD2002PE-R	(2) DVI	(4) USB 2.0 Type A	No	Yes	No	Not applicable	Not applicable	Not applicable
EMD2000PE-R-P	(1) DVI	(4) USB 2.0 Type A	No	Yes	Yes	Not applicable	Not applicable	Not applicable
EMD2002PE-R-P	(2) DVI	(4) USB 2.0 Type A	No	Yes	Yes	Not applicable	Not applicable	Not applicable
EMD2000SE-DP-R	(1) DisplayPort™	(4) USB 2.0 Type A	No	Yes	No	Not applicable	Not applicable	Not applicable
EMD2002SE-DP-R	(2) DisplayPort	(4) USB 2.0 Type A	No	Yes	No	Not applicable	Not applicable	Not applicable
EMD2000PE-DP-R	(1) DisplayPort	(4) USB 2.0 Type A	No	Yes	No	Not applicable	Not applicable	Not applicable
EMD2002PE-DP-R	(2) DisplayPort	(4) USB 2.0 Type A	No	Yes	No	Not applicable	Not applicable	Not applicable
EMD4000R	(1) DisplayPort	(4) USB 2.0 Type A	No	Yes	No	Not applicable	Not applicable	Not applicable
TRANSMITTER	NUMBER OF VIDEO HEADS	USB PORTS	SERIAL	AUDIO	POE	DVI CPU CABLE	DISPLAYPORT CPU CABLE	USB CPU CABLE
EMD2000SE-T	(1) DVI	(1) USB 2.0 Type B	Yes	Yes	No	Not included	Not applicable	Not included
EMD2002SE-T	(2) DVI	(1) USB 2.0 Type B	No	Yes	No	Not included	Not applicable	Not included
EMD2000SE-T-R2	(1) DVI	(1) USB 2.0 Type B	No	Yes	No	Not included	Not applicable	Not included
EMD2000PE-T	(1) DVI	(1) USB 2.0 Type B	No	Yes	No	(1) included	Not applicable	Not included
EMD2000PE-T-P	(1) DVI	(1) USB 2.0 Type B	No	Yes	Yes	(1) included	Not applicable	Not included
EMD2000PE-T-R2	(1) DVI	(1) USB 2.0 Type B	No	Yes	No	(1) included	Not applicable	Included
EMD2002PE-T-R2	(2) DVI	(1) USB 2.0 Type B	No	Yes	No	(2) included	Not applicable	Included
EMD2002PE-T	(2) DVI	(1) USB 2.0 Type B	No	Yes	No	(2) included	Not applicable	Not included
EMD2002PE-T-P	(2) DVI	(1) USB 2.0 Type B	No	Yes	Yes	(2) included	Not applicable	Not included
EMD200DV-T	(1) DVI	(1) USB HID, (1) USB HID for power only	No	Yes	No	Not included	Not applicable	Not included
EMD200DP-T	(1) DisplayPort	(1) USB HID Type A, (1) USB HID Type A for power only	No	Yes, Embedded	No	Not included	Not applicable	Not included
EMD2000PE-DP-T	(1) DisplayPort	(1) USB 2.0 Type B	No	Yes	No	Not applicable	Included	Included
EMD2000SE-DP-T	(1) DisplayPort	(1) USB 2.0 Type B	Yes	Yes	No	Not applicable	Not included	Not included
EMD2002PE-DP-T	(2) DisplayPort	(1) USB 2.0 Type B	No	Yes	No	Not applicable	Included	Included
EMD2002SE-DP-T	(2) DisplayPort	(1) USB 2.0 Type B	No	Yes	No	Not applicable	Not included	Not included
EMD4000T	(1) DisplayPort	(1) USB 2.0 Type B	No	Yes	No	Not applicable	Included	Included
MANAGER	NUMBER OF VIDEO HEADS	USB PORTS	SERIAL	AUDIO	POE	DVI CPU CABLE	DISPLAYPORT CPU CABLE	USB CPU CABLE
BXAMGR-R2	(1) VGA	(4) USB 2.0 Type A	Yes	Yes	No	Not applicable	Not applicable	Not applicable

CHAPTER 2: OVERVIEW

NOTE: A serial port is not currently supported to pass RS-232 data between TX and RX. A USB serial converter must be used with USB redirection.

Some of the key capabilities and operation of Emerald® devices are described next. These capabilities are supported across all Emerald devices.

2.2.1 VIDEO

The Emerald system supports 24-bit color depth digital video up to a maximum resolution of 1920x1200 at 60 Hz for Emerald 2K devices (non EMD4000T, non EMD4000R), and up to 3840x2160 at 60Hz for the Emerald 4K devices (EMD4000T, EMD4000R) for any video head on both transmitter and receiver. One or two DVI-I or DisplayPort™ connectors are provided on the receiver or transmitter for video cable compatibility, but only digital video is supported. See “Appendix A - Emerald Video Resolutions Supported” for the list of resolutions Emerald currently supports. VGA or analog video can be supported by using the KVGA-DVID VGA to DVI-D converter, but it should only be used with single-head DVI transmitters because of the dithering options. If used with a dual-head transmitter, the video quality will not be as good as it is with the single-head model.

2.2.2 AUDIO

The Emerald system supports CD-quality stereo audio from the remote workstation (with the transmitter connected) or virtual desktop to peripheral speakers connected to the USB connector on the Emerald receiver. The Emerald transmitter uses its USB interface to capture audio from the remote workstation. This increases audio quality by eliminating analog audio noise issues and removing the need for a sound card in PC/workstation.

The Emerald receiver connects audio from a peripheral microphone connected via the USB connector on the receiver to the remote workstation or a virtual desktop. The Emerald transmitter uses USB to supply the microphone data to the remote workstation. Higher quality audio can be obtained using USB redirection for USB headsets or speakers.

The Emerald ZeroU DVI transmitter has just one audio connector (used to connect speakers). The Emerald ZeroU DisplayPort transmitter has embedded audio over the DisplayPort connector.

NOTE: Some models, such as the SE and PE DisplayPort ones, do not have a 3.5-mm microphone connector and will require a USB microphone to be used.

2.2.3 SUPPORT FOR KEYBOARDS, MICE, AND USB DEVICES

Standard 104/105 keyed keyboards and both USB keyboards and mice are fully supported by the Emerald system. Composite mouse and keyboard devices are supported, along with other types of USB devices, such as flash/thumb Drives, CD and DVD-ROM drives, printers, pen tablets, touch-panels, and isochronous USB devices, such as headsets. Specialized keyboards that support LCD panels, macro keys, card readers, and internal USB hubs typically require additional support.

Support for non-keyboard and mice devices is provided on an Emerald receiver using USB redirection. This capability can be enabled or disabled by the Administrator. In an Emerald receiver, the first two devices that are not keyboard or mouse are assigned to the USB redirection channel automatically and passed to the remote computer when connected via a transmitter. When connecting to a non-transmitter target, such as a virtual desktop, up to eight USB devices can be redirected. The EMD200DV/EMD200DP series does not support USB redirection and only supports keyboard and mouse devices.

NOTE: A hub can be attached externally to an Emerald receiver, but a maximum of two devices can be assigned to USB redirection on connections to transmitters. Multiple keyboard and mice can additionally be supported, although all use the default drivers on the target PC.



CHAPTER 2: OVERVIEW

2.2.4 IP ADDRESSING

The Emerald® devices are IP-addressable, giving you the flexibility to locate workstations anywhere within your enterprise and at any distance from your desktop users. The Emerald devices use standard network protocols to transfer data between the remote workstation/virtual desktop and the peripheral devices located at the user's desk. The Emerald 2K system can operate on a network connection of 100 Mbps or 1 Gbps, but it is highly recommended to use a 1 Gbps link for best performance and experience. The Emerald 4K system (EMD4000T, EMD4000R only) can only operate on a 10 Gbps network connection.

The receiver can be configured using a static or DHCP assigned IP address while the transmitter requires a static IP address only. It is strongly recommended to use static IP addresses for the receivers.

2.2.5 FIRMWARE UPGRADE

Upgrade your firmware using Boxilla® or by using a USB flash-drive in an Emerald receiver unit to ensure that your Emerald system is always running the most current version available. The Emerald devices—receiver and transmitter—are upgradable.

2.3 APPLICATION EXAMPLES

The Emerald system is built to be flexible so that it can be deployed in many different types of applications, such as basic extension, switching applications (sometimes called matrix), cloud-based desktops, control rooms, digital signage, and kiosk applications, and other applications in banking, financial services, broadcast, network operations, industrial, government and enterprise computing sectors. Emerald provides the state-of-the-art performance by:

- ♦ using digital sources for video and audio, hence removing analog noise issues or other potential environmental issues
- ♦ using advanced optimized compression to enable visually lossless video over standard low-bandwidth networks rather than a proprietary connection or dedicated gigabit networks of many systems

2.3.1 VIDEO, AUDIO, AND USB EXTENSION

Many applications require video, audio, or USB extension (or all three together), such as PC back-racking, board-room fit-out, remote monitoring, and digital signage.

The Emerald system is set up to connect the transmitter to the receiver straight out of the box on a point-to-point network. The transmitter and receiver can be attached to standard Ethernet IP networks to increase the distance between units – within a building, between buildings, or across a country. Only standard Ethernet/IP rules and the maximum latency the application can tolerate need to be considered. If video and/or audio extension only is being used, latency rarely is a consideration as the traffic is typically one-way. When USB-based peripheral devices are also required, a network latency of <50 ms is recommended to avoid user issues, such as poor mouse response. For some applications, such as graphic design network latency, <20 ms may be required to ensure user satisfaction. Latency normally is only an issue when extending across a WAN, because latency inside modern buildings or on dedicated networks is much less than 1 ms.

NOTE: Emerald supports latency of <100ms, although <20ms is recommended and anything above 100ms will have undesired results.

In Figure 2-2, a typical deployment is shown in a basic extender application. In this deployment, only one transmitter and receiver are used to allow remote access to a single workstation.

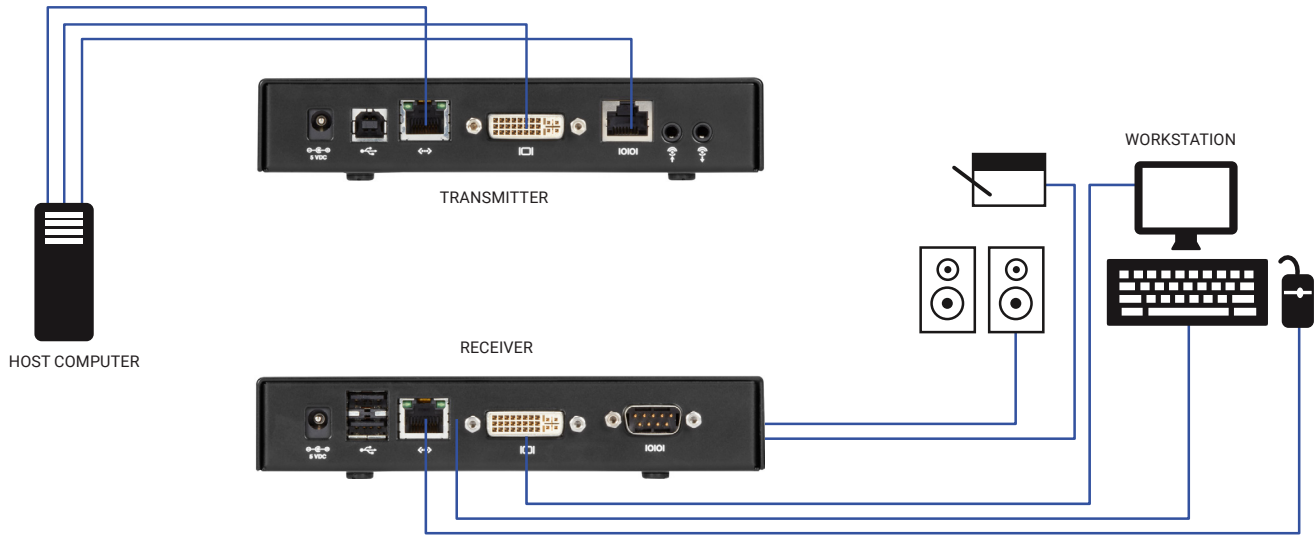

FIGURE 2-2. BASIC EXTENDER APPLICATION

2.3.2 VIDEO, AUDIO, AND USB SWITCHING

Numerous applications require being able to switch between different target PCs or virtual desktops. The user wants to be able to change the source of video, audio, or USB extension (or all three together).

Connections can be made to a target using Emerald’s intuitive OSD, API, Boxilla® Viewer (if using Boxilla), or Favorite Hot-keys. In Figure 2-3, a larger scale system is shown. This is referred to as a switching or matrix type of deployment. In this deployment, there are several receivers and transmitters and a manager, as well as virtual desktops.

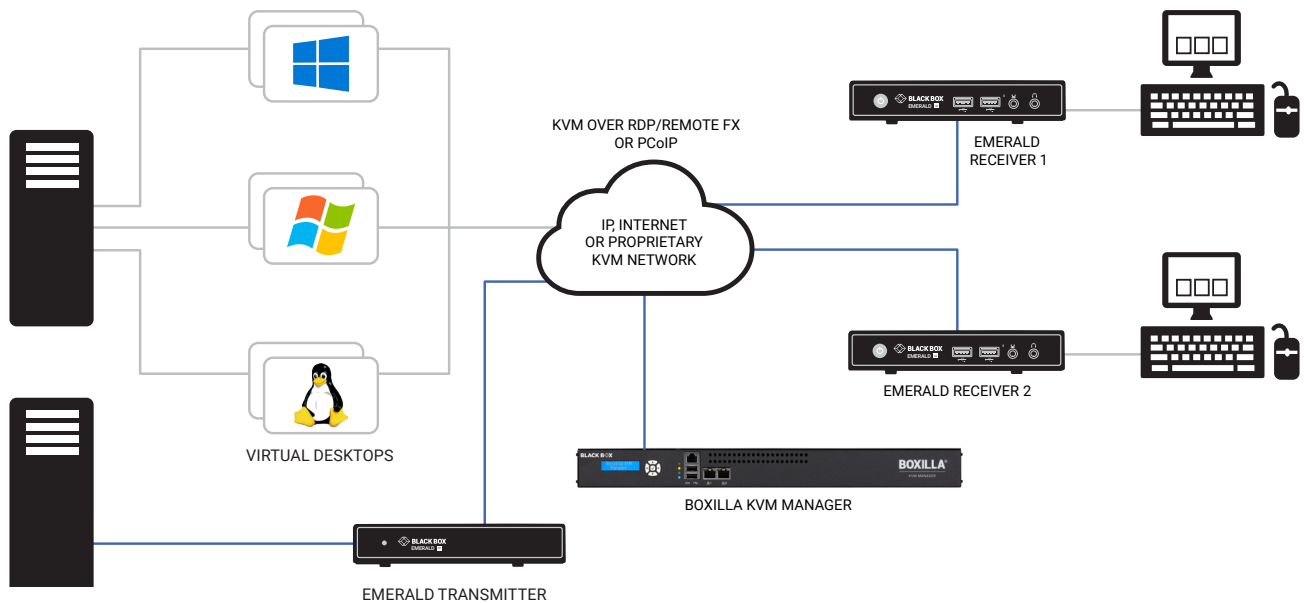

FIGURE 2-3. EMERALD SWITCHING EXAMPLE

CHAPTER 3: CONFIGURATION

3.1 RECEIVER CONFIGURATION

An Emerald® receiver connects to a physical PC using an Emerald transmitter or a virtual desktop over a TCP/IP network and decrypts and decompresses the streams to provide video, audio, and USB connections to a user. The user is presented with typical PC connections—video out (typically DVI or DisplayPort™), USB (typically 4 ports of USB 2.0), line out, and microphone in (see the individual receiver's data sheet for specific ports provided).

The receiver is configured using an On-Screen Display (OSD) built into the receiver or using the Boxilla® Manager. The network settings and unit name are examples of receiver settings. The target connections are defined by their target name or IP address, log-in username/password, and TCP port number to be used. Users can be created and specific connections may be allocated to the different users.

A receiver user profile is protected by username and password to permit different users to access the same unit securely.

Multiplatform support

Emerald is compatible with the following operating systems:

- ◆ Microsoft Windows® desktop operating systems, such as Windows 10 and Windows 11, and Microsoft Server operating systems, such as Server 2008, Server 2016, or Server 2020
- ◆ Linux®
- ◆ Mac OS®

The default keyboard drivers for these operating systems are supported by the Emerald system.

NOTE: For virtual desktops, typically Pro or Enterprise versions of the Windows operating system are required for VDI to support RemoteFX™. See www.microsoft.com for Terminal Services (RDSH) or VDI (RDVH) requirements.

NOTE: Older operating systems and specialized operating systems may be supported even though they are not shown here. If your operating system does not appear in the above list, contact us.

CHAPTER 3: CONFIGURATION

3.2 TRANSMITTER CONFIGURATION

An Emerald® transmitter converts the video, audio, and USB connections of a PC or workstation to a format that can be connected and controlled over a TCP/IP network. The transmitter connects to the DVI or DisplayPort™ and USB ports of a PC or workstation. The transmitter controls the connection to a remote receiver and manages the flow of information to it. It converts and compresses video and audio information for transmission over standard TCP/IP networks, along with USB peripheral communications. All data communication uses 128-bit encryption.

The transmitter is configured from an Emerald receiver or Boxilla® Manager. The network settings, unit name, and video quality are among the parameters that can be configured on a transmitter.

Multiplatform support

The transmitter is connected to the remote workstation via USB and DVI or DisplayPort connectors. This enables the Emerald receiver to interoperate seamlessly with Windows®, Linux®, and Macintosh® workstations/servers.



CHAPTER 3: CONFIGURATION

3.3 BOXILLA MANAGER CONFIGURATION

In a basic installation, you can configure Emerald® via an Emerald receiver's built-in OSD display. For larger installations, a Boxilla® Manager (BXAMGR and BXAMGR-R2) can manage a network of Emerald receivers and transmitters. The BXAMGR can manage 25 transmitters/receivers by default with the included default license. It can manage an unlimited number of Emerald transmitters/receivers when using an upgrade license, up to a total combined maximum of 4096 transmitters and receivers.

A Boxilla user profile is protected by username and password to permit different users to access the same unit securely. It maintains the central database that is distributed to all receivers in the domain of the Boxilla (for example, discovered and added to manager) – called the managed domain. This distribution ensures that there is no single point of failure in the Emerald system – each receiver has a copy of the database. This enables each receiver to continue operation – log users in, make connections as required – even if the Boxilla goes off-line.

Using the intuitive Boxilla web-based interface, one or more Administrators can manage potentially thousands of users who are interacting with an almost unlimited number of devices. Boxilla operates as a self-contained compact server unit that can be located anywhere within your network. Boxilla is supplied pre-loaded and is straightforward to deploy, requiring only a network connection and a power input to begin operation.

The current version of Boxilla provides management of Black Box's Emerald system. For more information on Boxilla, refer to the Boxilla user manual.

CHAPTER 4: MODES OF OPERATION

The Emerald® system has various modes of operation: Auto-Login, Auto-Connect, Private Connection, Shared Connection, and Video Source Optimization modes.

4.1 AUTO-LOGIN

In Auto-Login Mode, turning on the Emerald receiver automatically causes a login as a pre-defined user. The user is presented with the permitted connections that have been predefined.

4.2 AUTO-CONNECT

In Auto-Connect Mode, when a user logs-in to the Emerald receiver, it causes an automatic connection to their pre-allocated workstation or virtual desktop. Auto-Login and Auto-Connect are defined independent of each other, but they can be used together to auto login/auto connect devices that are difficult to reach.

4.3 PRIVATE CONNECTION

In Private Connection Mode, when a user makes a connection to a target workstation/virtual desktop, this connection is only accessible by this user. All other users will receive a busy message if they attempt to connect to the same workstation/virtual machine. This is the default mode for connections.

4.4 SHARED CONNECTION

In Shared Connection Mode, multiple users can connect to the audio and video of the same target computer over the network. They arbitrate for control of the keyboard and mouse of that computer. Non-keyboard and mice devices are not supported on shared connections, such as USB 2.0 devices, due to the timing/OS limitations. Analog audio can now be shared in a shared mode connection.

These various modes can be mixed on a particular receiver and connection. For example, Auto-Login and Auto-Connect can be combined to enable an Emerald receiver to automatically connect to a specific target workstation/virtual desktop when power is applied without any user intervention that might be required for digital signage or kiosk type of deployments. When using the Emerald 4K appliances in shared mode, be sure to configure the 10 Gbps network switch to support IGMP Snooping for multicast network traffic.

4.5 VIDEO SOURCE OPTIMIZATION

Off: In this mode, the transmitter does not perform any additional video functions to manage the video input bandwidth. This mode assumes you are not using any analog-to-digital converters or a Temporal Dithering GPU. If you are using converters or have a GPU that does Temporal Dithering, this setting will not work very well as it will saturate the transmitter and cause severe latency.

DVI Optimized: This mode is designed to be used with GPUs that support Temporal Dithering. When the GPU updates every pixel on every frame to show a more vibrant video output, the transmitter in this mode can now ignore certain pixel updates to reduce the risk of GPU bandwidth saturation that can lead to severe latency.

VGA

A: VGA High Performance: When using an analog-to-digital video converter, these devices can cause video noise to be injected on the signal. The transmitter will view this as a noisy source or a GPU that is using Temporal Dithering. This option is designed more for VGA to DVI/HDMI converters and will perform the function at a low capacity.

B: VGA Optimized: When using an analog-to-digital video converter, these devices can cause video noise to be injected on the signal. The transmitter will view this as a noisy source or a GPU that is using Temporal Dithering. This option is designed more for VGA to DVI/HDMI converters and will perform the function at a medium capacity.

C: VGA Low Bandwidth: When using an analog-to-digital video converter, these devices can cause video noise to be injected on the signal. The transmitter will view this as a noisy source or a GPU that is using Temporal Dithering. This option is designed more for VGA to DVI/HDMI converters and will perform the function at a high capacity, filtering the most pixels. This setting is considered to be the most aggressive mode.

NOTE: Only single-head transmitters support Video Source Optimization; dual-head and Emerald 4K devices do not support it.



CHAPTER 5: INSTALLATION

5.1 EMERALD RECEIVER (EMD2000SE-R, EMD2002SE-R, EMD2000PE-R, EMD2000PE-R-P, EMD2002PE-R, EMD2002PE-R-P) CHECKLIST

Before installing your Emerald® SE or PE receiver, refer to the list below to ensure that you have all the items necessary for installation:

- ◆ Emerald SE or PE receiver
- ◆ External power supply for the receiver
- ◆ Power cord
- ◆ Emerald SE or PE Quick Installation Guide (QIG)

5.2 EMERALD TRANSMITTER (EMD2000SE-T, EMD2002SE-T, EMD2000PE-T, EMD2000-PE-T-P, EMD2002PE-T, EMD2002PE-T-P, EMD2000SE-T-R2, EMD2000PE-T-R2, EMD2002PE-T-R2) CHECKLIST

Before installing your Emerald SE or PE transmitter, refer to the list below to ensure that you have all the items necessary for installation:

- ◆ Emerald SE or PE transmitter
- ◆ External power supply for the transmitter
- ◆ Power cord
- ◆ Emerald SE or PE Quick Installation Guide (QIG)
- ◆ The SE transmitter does not include any video or USB CPU cables. The PE transmitter comes with all of the required CPU cables.

5.3 EMERALD SE OR PE TRANSMITTER KIT (EMD2000SE-T-K, EMD2002SE-T-K, EMD2000PE-K, AND EMD2002PE-K) CHECKLIST

Before installing your Emerald SE or PE transmitter, refer to the list below to ensure that you have all the items necessary for installation:

- ◆ Emerald SE or PE transmitter
- ◆ External power supply for the transmitter
- ◆ Power cord
- ◆ PE Kit only: DVI cable(s) (One DVI-D cable included for single-head, two DVI-D cables included for dual-head)
- ◆ PE Kit only: USB A to USB B device cable
- ◆ Emerald SE or PE Quick Installation Guide (QIG)

NOTE: The Emerald SE kits (EMD2000SE-T-K and EMD2002SE-T-K) do not contain any video or USB CPU cables. These cables must be purchased separately.

CHAPTER 5: INSTALLATION

5.4 EMERALD ZEROU DVI OR DP TRANSMITTER (EMD200DV-T OR EMD200DP-T) CHECKLIST

- ◆ Emerald® ZeroU DVI transmitter (EMD200DV-T) or Emerald ZeroU DisplayPort™ transmitter (EMD200DP-T)

5.5 EMERALD DISPLAYPORT SE AND PE TRANSMITTERS (EMD2000PE-DP-T, EMD2000SE-DP-T, EMD2002PE-DP-T, EMD2002SE-DP-T) CHECKLIST

Before installing your Emerald SE/PE DisplayPort™ transmitter, refer to the list below to ensure that you have all the items necessary for installation:

- ◆ Emerald SE/PE DisplayPort transmitter
- ◆ External power supply for the transmitter
- ◆ Power cord
- ◆ PE transmitters only: DisplayPort cable(s) (One DisplayPort cable included for single-head, two DisplayPort cables included for dual-head)
- ◆ PE transmitters only: USB A to USB B device cable
- ◆ Emerald SE/PE DisplayPort Quick Installation Guide (QIG)

NOTE: The Emerald SE DP transmitters do not include any video or USB CPU cables. These cables must be purchased separately.

5.6 EMERALD DISPLAYPORT SE AND PE RECEIVERS (EMD2000SE-DP-R, EMD2002SE-DP-R, EMD2000PE-DP-R, EMD2002PE-DP-R) CHECKLIST

Before installing your Emerald SE/PE DisplayPort receiver, refer to the list below to ensure that you have all the items necessary for installation:

- ◆ Emerald SE/PE DisplayPort receiver
- ◆ External power supply for the receiver
- ◆ Power cord
- ◆ Emerald SE/PE DisplayPort Quick Installation Guide (QIG)

5.7 EMERALD 4K TRANSMITTER (EMD4000T) CHECKLIST

Before installing your Emerald 4K transmitter, refer to the list below to ensure that you have all the items necessary for installation:

- ◆ Emerald 4K transmitter
- ◆ External power supply for the transmitter
- ◆ Compatible 10 Gbps SFP+
- ◆ Power cord
- ◆ DisplayPort cable
- ◆ USB cable
- ◆ Emerald 4K Quick Installation Guide (QIG)



CHAPTER 5: INSTALLATION

5.8 EMERALD 4K RECEIVER (EMD4000R) CHECKLIST

Before installing your Emerald 4K receiver, refer to the list below to ensure that you have all the items necessary for installation.

- ◆ Emerald 4K receiver
- ◆ External power supply for the receiver
- ◆ Compatible 10 Gbps SFP+
- ◆ Power cord
- ◆ Emerald 4K Quick Installation Guide (QIG)

5.9 INSTALLATION OPTIONS



WARNING: To reduce the risk of electric shock or damage to your equipment, disconnect the power from the Emerald® device by unplugging the power supply from the electrical outlet. To reduce the risk of electric shock or damage to your equipment, turn on the remote workstation and the Emerald transmitter in the order described in the following procedures.

You can install the Emerald system either in a point-to-point or networked configuration.



WARNING: To avoid potentially fatal shock hazard and possible damage to equipment, please observe the following precautions:

- ◆ These devices contain no user-serviceable technology. Do not open the enclosure.
- ◆ Test AC outlets at the workstation and monitor for proper polarity and grounding.
- ◆ Use only with grounded outlets at both the workstation and monitor. When using a backup Uninterruptible Power Supply (UPS), power the workstation and the transmitter from the same supply.

NOTE: The AC outlet is the main disconnect.



LASER WARNING

WARNING: Laser. If using an optical fiber SFP+ adapter when connecting an Emerald to a switch or other device, the user must observe precautions for working with a Class 1 laser product.



The EMD-POE units conform to IEEE802.3af but do not meet the isolation barrier requirements specified in subsection 33.4.1 – Isolation. The units meet the Safety Requirements of IEC 62368.

CHAPTER 5: INSTALLATION

5.10 CONNECT THE EMERALD RECEIVER

The recommended sequence to connect the receiver is:

1. Connect your keyboard, monitor, mouse, and other peripheral cables to the appropriately labeled ports on the Emerald® receiver. On the dual-head model, video output #1 is closest to the USB ports on the receiver.
2. Connect the UTP cable to the RJ-45 port, or the fiber cable to the SFP ports, on the back of the receiver.
3. Plug the external power supply's connector into the DC power jack on the rear of the Emerald receiver.
4. Connect the detachable power cord to the power supply.
5. Plug the power cord into an appropriate wall outlet. The unit automatically powers on.
6. A default connection is available to allow connection to a default Emerald transmitter. You can use the On-Screen Display (OSD) to add a different connection to a remote transmitter or virtual desktop. The default transmitter IP address is 192.168.1.22.
7. Once a Connection has been defined, use the OSD to make connection.

NOTE: VGA or analog video monitors can be connected to the Emerald receiver by using a DVI-D to VGA converter (such as Black Box part number AC1038A).

CAUTION: When using PoE to power the Emerald PE receiver, the appliance will supply up to 1 watt of power to attached USB devices. If the connected USB devices consume more than 1 watt in total, you must use the external power supply that was supplied with that specific appliance. The receiver may not operate reliability if excess power is drawn.



5.10.1 EMERALD SE RECEIVER CONNECTOR INFORMATION

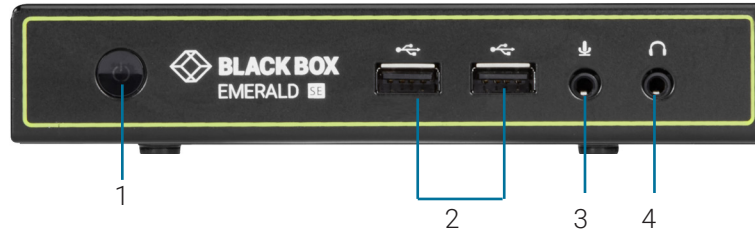

FIGURE 5-1. FRONT VIEW OF EMERALD SE RECEIVER, SINGLE-HEAD (EMD2000SE-R)

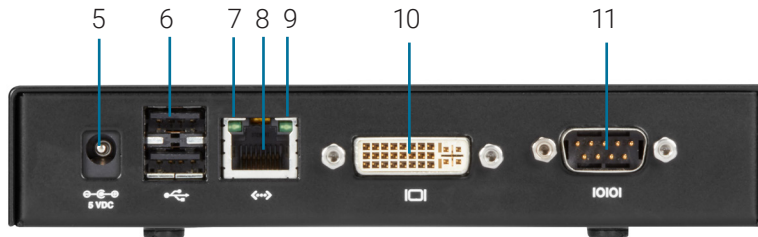

FIGURE 5-2. REAR VIEW OF EMERALD SE RECEIVER, SINGLE-HEAD (EMD2000SE-R)

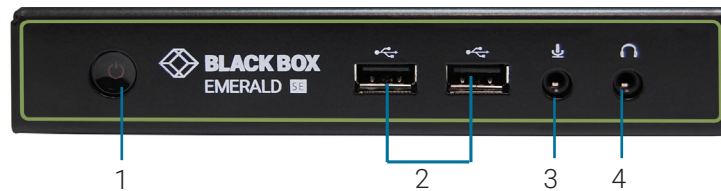

FIGURE 5-3. FRONT VIEW OF EMERALD SE RECEIVER, DUAL-HEAD (EMD2002SE-R)

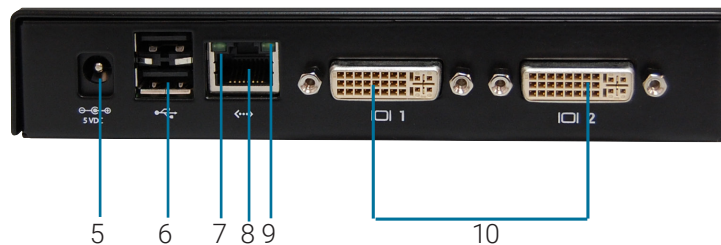

FIGURE 5-4. REAR VIEW OF EMERALD SE RECEIVER, DUAL-HEAD (EMD2002SE-R)

CHAPTER 5: INSTALLATION

TABLE 5-1. EMERALD SE RECEIVER COMPONENTS

NUMBER IN FIGURES 5-1 THROUGH 5-4	COMPONENT	DESCRIPTION
1	(1) Power button	Disabled. The unit automatically powers on; it must be turned off at the power source.
2, 6	(4) USB Type A connectors	Connects to USB peripherals
3	(1) 3.5-mm jack (MIC)	Connects to analog microphone
4	(1) 3.5-mm jack (SPK)	Connects to analog speaker
5	(1) 2.5-mm barrel (PWR)	Connects to the external 5VDC power supply
7	(1) Link/activity LED	Illuminates green when there is activity on the link
8	(1) RJ-45 connector	Connects to 10-/100-/1000-Mbps network
9	(1) Link speed LED	Illuminates to show link speed; blinks once for 10 Mbps, twice for 100 Mbps, and three times for 1Gbps
10	(1) or (2) DVI output connectors	Connects to DVI output(s) up to 1920x1200
11	(1) DB9 connector*	Connects to RS-232 serial interface

*Single-head model only



5.10.2 EMERALD SE DP RECEIVER CONNECTOR INFORMATION

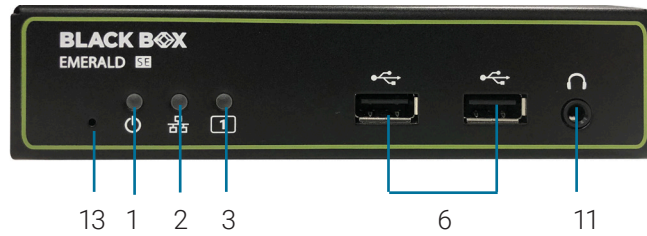

FIGURE 5-5. FRONT VIEW OF EMERALD SE DP RECEIVER, SINGLE-HEAD (EMD2000SE-DP-R)

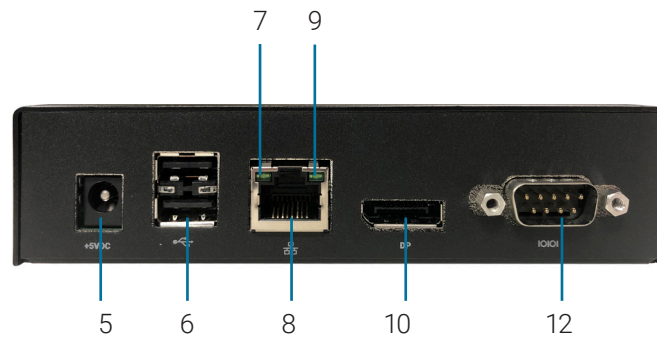

FIGURE 5-6. REAR VIEW OF EMERALD SE DP RECEIVER, SINGLE-HEAD (EMD2000SE-DP-R)

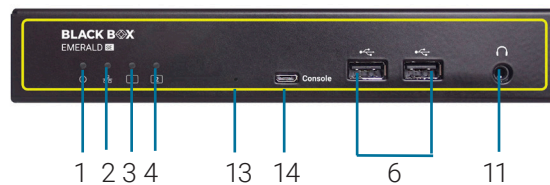

FIGURE 5-7. FRONT VIEW OF EMERALD SE DP RECEIVER, DUAL-HEAD (EMD2002SE-DP-R)

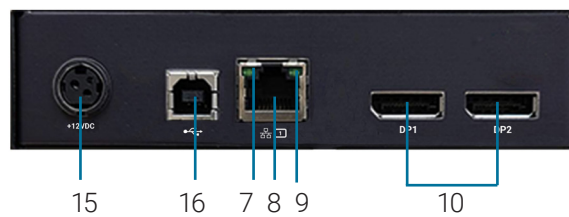

FIGURE 5-8. REAR VIEW OF EMERALD SE DP RECEIVER, DUAL-HEAD (EMD2002SE-DP-R)

CHAPTER 5: INSTALLATION**TABLE 5-2. EMERALD SE DP RECEIVER COMPONENTS**

NUMBER IN FIGURES 5-5 THROUGH 5-8	COMPONENT	DESCRIPTION
1	(1) Power LED	Indicates when the unit is powered up
2	(1) Network LED	Indicates when a network is connected
3	(1) Video 1 Status LED	Indicates when video 1 sync is detected
4	(1) Video 2 Status LED *	Indicates when video 2 sync is detected
5	(1) 2.5-mm barrel (PWR)	Connects to the external 5VDC power supply
6	(2) USB Type A connectors	Connects to USB peripherals
7	(1) Link/activity LED	Illuminates green when there is activity on the link
8	(1) RJ-45 connector	Connects to 10-/100-/1000-Mbps network
9	(1) Link speed LED	Illuminates to show link speed; blinks once for 10 Mbps, twice for 100 Mbps, and three times for 1 Gbps
10	(1) or (2)* DisplayPort™ connectors	Connects to DisplayPort output(s) up to 1920x1200
11	(1) 3.5-mm jack (SPK)	Connects to analog speaker
12	(1) DB9 connector **	Connects to RS-232 serial interface
13	(1) Reset button	Press for 5 seconds to factory reset unit.
14	(1) Micro USB Connector	Reserved for future use
15	(1) 3-pin locking connector (PWR)	Connects to the external 12VDC power supply
16	(1) USB Type B connector	Connects to USB port on target PC for keyboard/mouse data

*Dual-head model only

**Single-head model only



5.10.3 EMERALD PE OR PE POE RECEIVER CONNECTOR INFORMATION

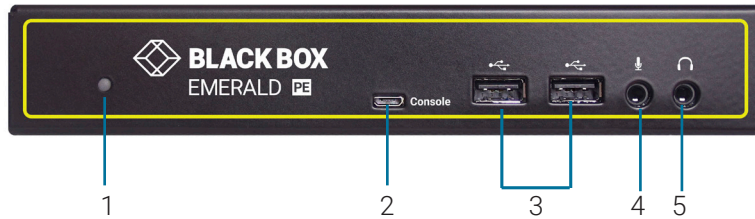

FIGURE 5-9. FRONT VIEW OF EMERALD PE RECEIVER, SINGLE-HEAD (EMD2000PE-R, EMD2000PE-R-P)

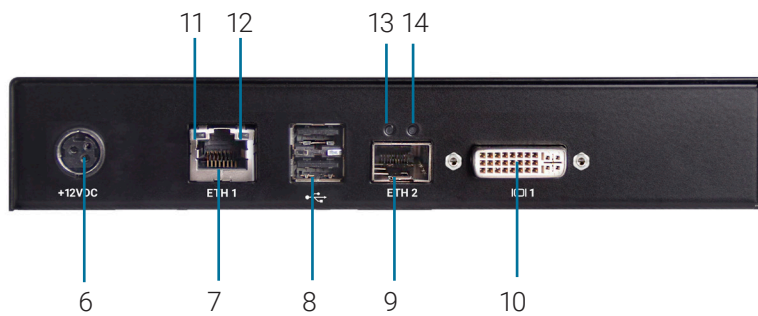

FIGURE 5-10. REAR VIEW OF EMERALD PE RECEIVER, SINGLE-HEAD (EMD2000PE-R, EMD2000PE-R-P)

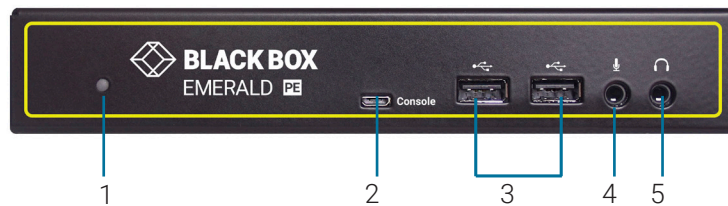

FIGURE 5-11. FRONT VIEW OF EMERALD PE RECEIVER, DUAL-HEAD (EMD2002PE-R, EMD2002PE-R-P)

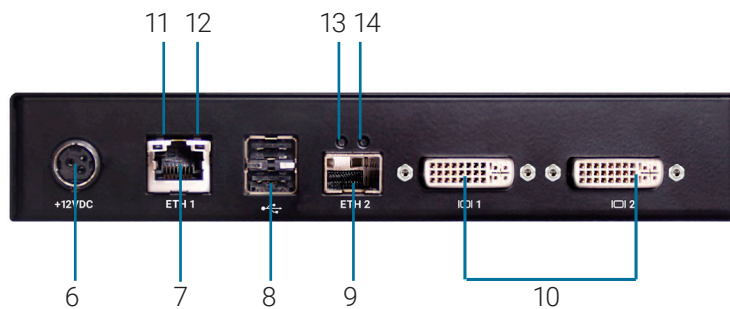

FIGURE 5-12. REAR VIEW OF EMERALD PE RECEIVER, DUAL-HEAD (EMD2002PE-R, EMD2002PE-R-P)

NOTE: EMD2000PE-R and EMD2000PE-R-P look exactly the same from the outside. Similarly, EMD2002PE-R and EMD2002PE-R-P look exactly the same from the outside. The only difference will be the unique device properties, such as part number, serial, and internal PoE component population.

CHAPTER 5: INSTALLATION

TABLE 5-3. EMERALD PE OR PE POE RECEIVER COMPONENTS

NUMBER IN FIGURES 5-9 THROUGH 5-12	COMPONENT	DESCRIPTION
1	(1) Power LED	Indicates when the unit is powered up
2	(1) Micro USB connector	Reserved for future use
3	(2) USB Type A connectors	Connects to USB peripherals
4	(1) 3.5-mm jack (MIC)	Connects to analog microphone
5	(1) 3.5-mm jack (SPK)	Connects to analog speaker
6	(1) 3-pin locking connector (PWR)	Connects to external 12VDC power supply
7	(1) RJ-45 connector	Connects to 10-/100-/1000-Mbps network
8	(2) USB Type A connectors	Connects to USB peripherals
9	(1) SFP cage	Connects network SFP module for 1 Gbps network
10	(1) or (2) DVI video connectors	Connects to DVI output(s) up to 1920x1200
11	(1) Link/activity LED	Illuminates green when there is activity on the link
12	(1) Link speed LED	Illuminates to show link speed; blinks once for 10 Mbps, twice for 100 Mbps, and three times for 1 Gbps
13	(1) SFP activity LED	Illuminates green when there is activity on the link
14	(1) SFP speed LED	Illuminates to show link speed



CHAPTER 5: INSTALLATION

5.10.4 EMERALD PE SINGLE-HEAD DISPLAYPORT RECEIVER CONNECTOR INFORMATION

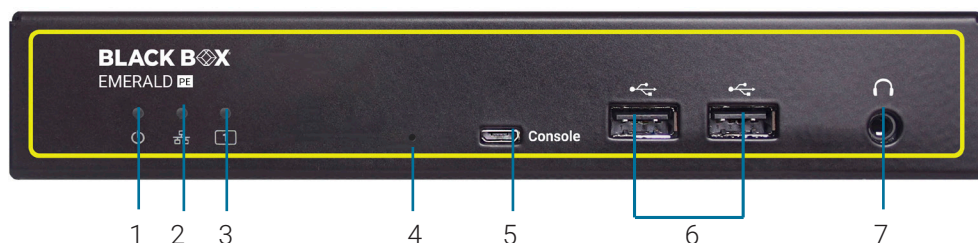

FIGURE 5-13. FRONT VIEW OF THE EMERALD PE TRANSMITTER, SINGLE-HEAD (EMD2000PE-DP-R)

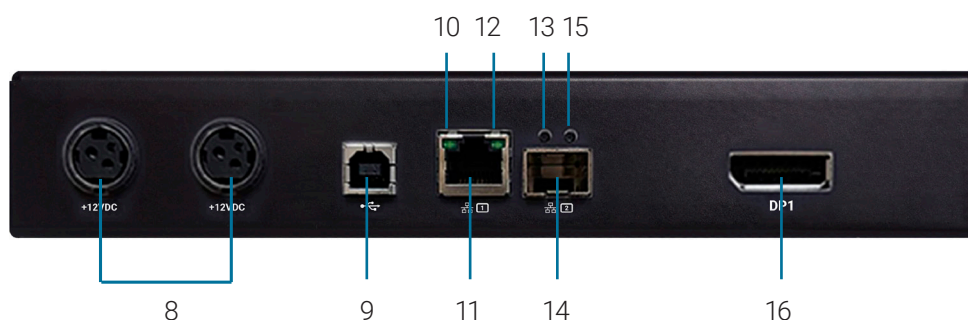

FIGURE 5-14. REAR VIEW OF THE EMERALD PE TRANSMITTER, SINGLE-HEAD (EMD2000PE-DP-R)

TABLE 5-4. EMERALD PE OR PE POE RECEIVER COMPONENTS

NUMBER IN FIGURES 5-13 THROUGH 5-14	COMPONENT	DESCRIPTION
1	(1) Power LED	Indicates when the unit is powered up
2	(1) Network LED	Indicates when a network is connected
3	(1) Video 1 Status LED	Indicates when video 1 sync is detected
4	(1) Reset button	Press for 5 seconds to factory reset unit.
5	(1) Micro USB connector	Reserved for future use
6	(2) USB Type A connectors	Connects to USB peripherals
7	(1) 3.5-mm jack (MIC)	Connects to 10-/100-/1000-Mbps network
8	(2) 3-pin locking connectors (PWR)	Connects to external 12VDC power supplies
9	(1) USB Type B connector	Connects to USB port on target PC for keyboard/mouse data
10	(1) Link/activity LED	Illuminates green when there is activity on the link
11	(1) RJ-45 connector	Connects to 10-/100-/1000-Mbps network
12	(1) Link speed LED	Illuminates to show link speed; blinks once for 10 Mbps, twice for 100 Mbps, and three times for 1 Gbps
13	(1) SFP activity LED	Illuminates green when there is activity on the link
14	(1) SFP cage	Connects network SFP module for 1 Gbps network
15	(1) SFP speed LED	Illuminates to show link speed
16	(1) DisplayPort™ connector	Connects to DisplayPort output(s) up to 1920x1200

CHAPTER 5: INSTALLATION

5.10.5 EMERALD PE DUAL-HEAD DISPLAYPORT RECEIVER CONNECTOR INFORMATION

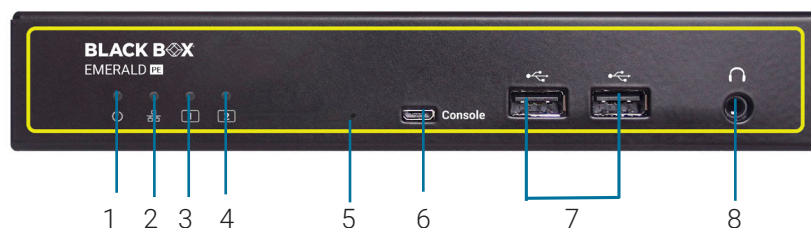

FIGURE 5-15. FRONT VIEW OF THE EMERALD PE TRANSMITTER, DUAL-HEAD (EMD2002PE-DP-R)

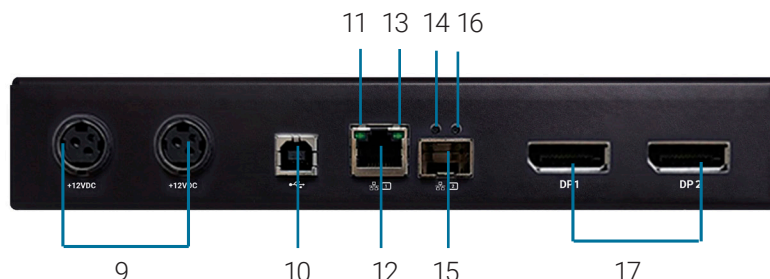

FIGURE 5-16. BACK VIEW OF THE EMERALD PE TRANSMITTER, DUAL-HEAD (EMD2002PE-DP-R)

TABLE 5-5. EMERALD PE OR PE POE TRANSMITTER COMPONENTS

NUMBER IN FIGURES 5-15 THROUGH 5-16	COMPONENT	DESCRIPTION
1	(1) Power LED	Indicates when the unit is powered up
2	(1) Network LED	Indicates when a network is connected
3	(1) Video 1 Status LED	Indicates when video 1 sync is detected
4	(1) Video 2 Status LED	Indicates when video 2 sync is detected
5	(1) Reset button	Press for 5 seconds to factory reset unit.
6	(1) Micro USB connector	Reserved for future use
7	(2) USB Type A connectors	Connects to USB peripherals
8	(1) 3.5-mm jack (MIC)	Connects to 10-/100-/1000-Mbps network
9	(2) 3-pin locking connectors (PWR)	Connects to external 12VDC power supplies
10	(1) USB Type B connector	Connects to USB port on target PC for keyboard/mouse data
11	(1) Link/activity LED	Illuminates green when there is activity on the link
12	(1) RJ-45 connector	Connects to 10-/100-/1000-Mbps network
13	(1) Link speed LED	Illuminates to show link speed; blinks once for 10 Mbps, twice for 100 Mbps, and three times for 1 Gbps
14	(1) SFP activity LED	Illuminates green when there is activity on the link
15	(1) SFP cage	Connects network SFP module for 1 Gbps network
16	(1) SFP speed LED	Illuminates to show link speed
17	(2) DisplayPort™ connectors	Connects to DisplayPort output(s) up to 1920x1200

5.10.6 EMERALD 4K RECEIVER CONNECTOR INFORMATION

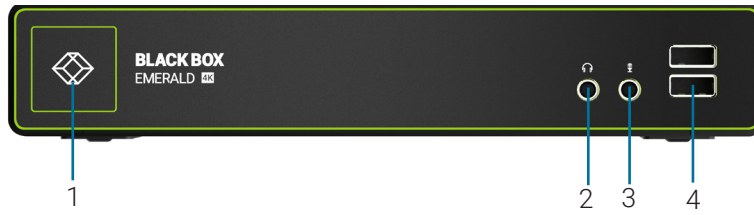

FIGURE 5-17. FRONT VIEW OF EMERALD 4K RECEIVER (EMD4000R)

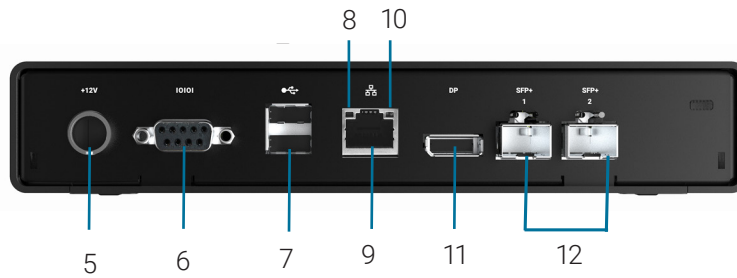

FIGURE 5-18. REAR VIEW OF EMERALD 4K RECEIVER (EMD4000R)

CHAPTER 5: INSTALLATION

TABLE 5-6. EMERALD RECEIVER COMPONENTS

NUMBER IN FIGURES 5-17 AND 5-18	COMPONENT	DESCRIPTION
1	(1) Power LED	Indicates when the unit is powered up
2	(1) 3.5-mm jack (SPK)	Connects to analog speaker
3	(1) 3.5-mm jack (MIC)	Connects to analog microphone
4	(2) USB Type A connectors	Connects to USB peripherals
5	(1) 3-pin locking connector (PWR)	Connects to external 12VDC power supply
6	(1) DB9 connector	Connects to RS-232 serial console interface for management
7	(2) USB Type A connectors	Connects to USB peripherals
8	(1) Link/activity LED	Connects to 10-/100-/1000-Mbps network
9	(1) RJ-45 connector	Illuminates green when there is activity on the link
10	(1) Link speed LED	Illuminates to show link speed; blinks once for 10 Mbps, twice for 100 Mbps, and three times for 1 Gbps
11	(1) DisplayPort™ connector	Connects to DisplayPort output(s) up to 1920x1200
12	(2) SFP+ module slots	Twisted-pair or fiber optic modules install here: (2) SFP+ slots (included for redundancy)



CHAPTER 5: INSTALLATION

5.11 CONNECT THE EMERALD TRANSMITTER

Before connecting the Emerald® transmitter to the remote workstation, ensure that the resolution and the refresh rate of the remote workstation are supported by the Emerald system. Set the screen resolution and refresh rate of the remote workstation or, optionally, you can clone the attached monitors' EDID table under Control -> Transmitter -> Preferences. Unsupported settings will cause blank or distorted video at the receiver.

The recommended sequence to connect the transmitter is:

1. Turn off the remote workstation.
2. The Emerald transmitter has one USB connector. Connect it to a corresponding USB port on the remote workstation.
3. Connect the video connector(s) on the Emerald transmitter to the appropriately labeled port on the workstation(s) using the DVI or DisplayPort™ cable(s).
4. Connect one end of the UTP or fiber cable to the Emerald transmitter's RJ-45 or SFP/SFP+ slot and turn on the workstation.
5. Route the other end of the UTP fiber cable to the location you have chosen for the Emerald receiver. If necessary, you can extend the UTP fiber cable via an Ethernet switch (subject to normal Ethernet cabling practices).
6. Plug the external power supply's connector into the DC power jack on the rear of the Emerald transmitter.
7. Connect the detachable power cord to the power supply.
8. Plug the power cord into an appropriate wall outlet. The transmitter powers on automatically.
9. Turn on power for the remote workstation.

NOTE: Use only the power supply provided by Black Box.

5.11.1 EMERALD ZEROU DVI AND DP CONNECTOR INFORMATION

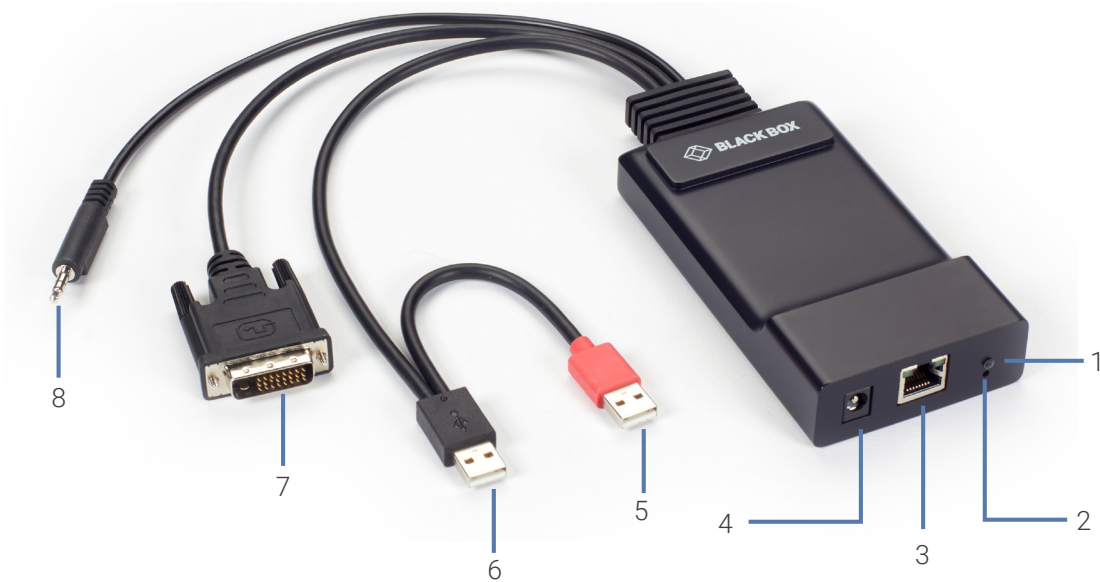

FIGURE 5-19 FRONT VIEW OF THE EMERALD ZEROU DVI TRANSMITTER, SINGLE-HEAD (EMD200DV-T)

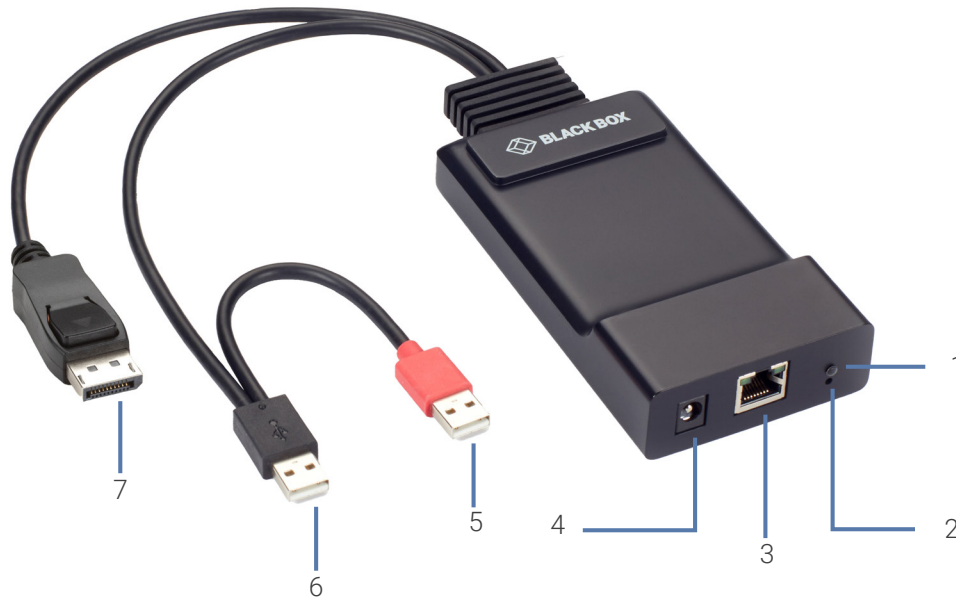

FIGURE 5-20. FRONT VIEW OF THE EMERALD ZERO DP TRANSMITTER, SINGLE-HEAD (EMD200DP-T)

TABLE 5-7. EMERALD ZERO DVI OR DISPLAYPORT TRANSMITTER COMPONENTS

NUMBER IN FIGURES 5-19 THROUGH 5-20	COMPONENT	DESCRIPTION
1	(1) Power LED	Indicates when the unit is powered up
2	(1) Reset button	Press for 5 seconds to factory reset unit.
3	(1) RJ-45 connector	Connects to 10-/100-/1000-Mbps network
4	(1) 2.5-mm barrel (PWR)	Connects to the external 5VDC power supply; transmitter can be powered using the red USB connector
5	(1) USB Type A connector (RED)	Connects to USB port to power up unit; does not pass keyboard/mouse control
6	(1) USB Type A connector (BLACK)	Connect to USB port for keyboard/mouse control
7	(1) DVI or DisplayPort™ connectors	Links to DVI or DisplayPort output(s) up to 1920x1200
8	(1) 3.5-mm jack (SPK)	Connects to analog speaker (DVI model only)

5.11.2 EMERALD SE TRANSMITTER CONNECTOR INFORMATION



FIGURE 5-21. FRONT VIEW OF THE EMERALD SE TRANSMITTER, SINGLE-HEAD (EMD2000SE-T (EOL))

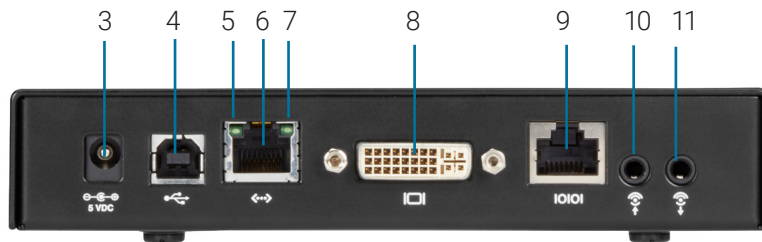

FIGURE 5-22. REAR VIEW OF THE EMERALD SE TRANSMITTER, SINGLE-HEAD (EMD2000SE-T (EOL))



FIGURE 5-23. FRONT VIEW OF THE EMERALD SE TRANSMITTER, DUAL-HEAD (EMD2002SE-T (EOL))

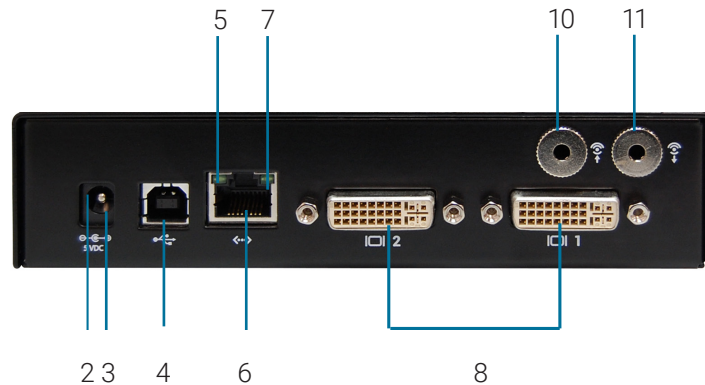

FIGURE 5-24. REAR VIEW OF THE EMERALD SE TRANSMITTER, DUAL-HEAD (EMD2002SE-T (EOL))

TABLE 5-8. EMERALD SE TRANSMITTER COMPONENTS

NUMBER IN FIGURES 5-21 THROUGH 5-24	COMPONENT	DESCRIPTION
1	(1) Power LED	Indicates when the unit is powered up
2	(1) Reset button	Press for 5 seconds to factory reset unit.
3	(1) 2.5-mm barrel (PWR)	Connects to the 5VDC power supply
4	(1) USB Type B connector	Connects to USB port on target PC for keyboard/mouse data
5	(1) Link/activity LED	Illuminates green when there is activity on the link
6	(1) RJ-45 connector	Connects to 10-/100-/1000-Mbps network
7	(1) Link speed LED	Illuminates to show link speed; blinks once for 10 Mbps, twice for 100 Mbps, and three times for 1 Gbps
8	(1) or (2) DVI output connectors	Links to DVI output(s) up to 1920x1200
9	(1) RJ-45 connector*	Connects to RS-232 serial interface
10	(1) 3.5-mm jack (SPK)	Connects to analog speaker
11	(1) 3.5-mm jack (MIC)	Connects to analog microphone

*Single-head model only

CHAPTER 5: INSTALLATION

5.11.3 EMERALD SE R2 DVI TRANSMITTER, SINGLE-HEAD CONNECTOR INFORMATION

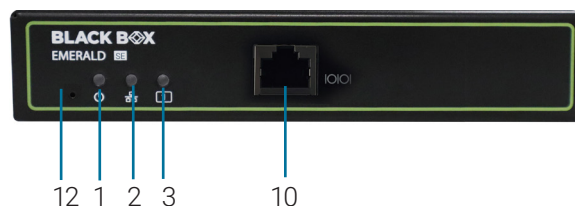

FIGURE 5-25. FRONT VIEW OF THE EMERALD SE R2 DVI TRANSMITTER, DUAL-HEAD (EMD2000SE-T-R2)

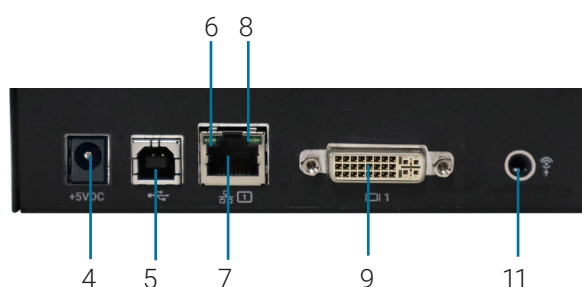

FIGURE 5-26. REAR VIEW OF THE EMERALD SE R2 DVI TRANSMITTER, DUAL-HEAD (EMD2000SE-T-R2)

TABLE 5-9. EMERALD SE TRANSMITTER COMPONENTS

NUMBER IN FIGURES 5-25 THROUGH 5-26	COMPONENT	DESCRIPTION
1	(1) Power LED	Indicates when the unit is powered up
2	(1) Network LED	Indicates when a network is connected
3	(1) Video 1 status LED	Indicates when video 1 sync is detected
4	(1) 2.5-mm barrel (PWR)	Connects to the external 5VDC power supply
5	(1) USB Type B connector	Connects to USB port on target PC for keyboard/mouse data
6	(1) Link/activity LED	Illuminates green when there is activity on the link
7	(1) RJ-45 connector	Connects to 10-/100-/1000-Mbps network
8	(1) Link speed LED	Illuminates to show link speed; blinks once for 10 Mbps, twice for 100 Mbps, and three times for 1 Gbps
9	(1) DVI connector	Connects to DVI output up to 1920x1200
10	(1) RJ-45 connector	Connects to RS-232 serial interface
11	(1) 3.5-mm jack (SPK)	Connects to analog speaker
12	(1) Reset button	Press for 5 seconds to factory reset unit

5.11.4 EMERALD SE SINGLE-HEAD DISPLAYPORT TRANSMITTER CONNECTOR INFORMATION

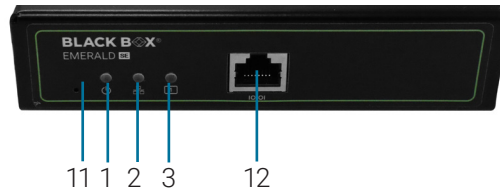

FIGURE 5-27. FRONT VIEW OF THE EMERALD SE TRANSMITTER, SINGLE-HEAD (EMD2000SE-DP-T)

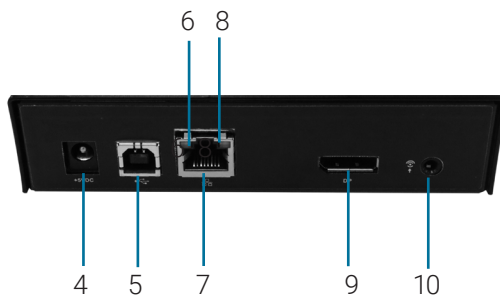

FIGURE 5-28. BACK VIEW OF THE EMERALD SE TRANSMITTER, SINGLE-HEAD (EMD2000SE-DP-T)

TABLE 5-10. EMERALD SE TRANSMITTER COMPONENTS

NUMBER IN FIGURES 5-27 THROUGH 5-28	COMPONENT	DESCRIPTION
1	(1) Power LED	Indicates when the unit is powered up
2	(1) Network LED	Indicates when a network is connected
3	(1) Video 1 status LED	Indicates when video 1 sync is detected
4	(1) 2.5-mm barrel (PWR)	Connects to the external 5VDC power supply
5	(1) USB Type B connector	Connects to USB port on target PC for keyboard/mouse data
6	(1) Link/activity LED	Illuminates green when there is activity on the link
7	(1) RJ-45 connector	Connects to 10-/100-/1000-Mbps network
8	(1) Link speed LED	Illuminates to show link speed; blinks once for 10 Mbps, twice for 100 Mbps, and three times for 1 Gbps
9	(1) DisplayPort™ connector	Connects to DisplayPort output up to 1920x1200
10	(1) 3.5-mm jack (SPK)	Connects to analog speaker
11	(1) Reset button	Press for 5 seconds to factory reset unit
12	(1) RJ-45 connector	Connects to RS-232 serial interface

CHAPTER 5: INSTALLATION

5.11.5 EMERALD SE DUAL-HEAD DISPLAYPORT TRANSMITTER CONNECTOR INFORMATION

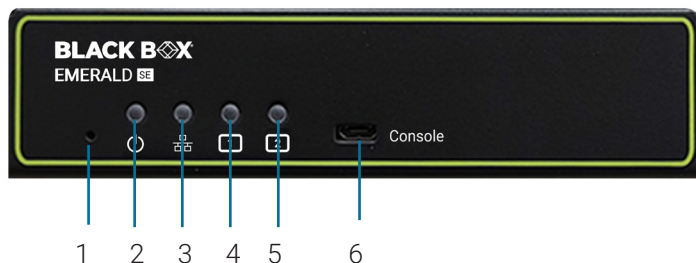

FIGURE 5-29. FRONT VIEW OF THE EMERALD SE TRANSMITTER, DUAL-HEAD (EMD2002SE-DP-T)



FIGURE 5-30. REAR VIEW OF THE EMERALD SE TRANSMITTER, DUAL-HEAD (EMD2002SE-DP-T)

TABLE 5-11. EMERALD SE DUAL-HEAD DisplayPort TRANSMITTER COMPONENTS

NUMBER IN FIGURES 5-29 AND 5-30	COMPONENT	DESCRIPTION
1	(1) Reset button	Press for 5 seconds to factory reset unit
2	(1) Power LED	Indicates when the unit is powered up
3	(1) Network LED	Indicates when a network is connected
4	(1) Video 1 status LED	Indicates when video 1 sync is detected
5	(1) Video 2 status LED	Indicates when video 2 sync is detected
6	(1) Micro USB connector	Reserved for future use
7	(1) 3-pin locking connector (PWR)	Connects to the external 12VDC power supply
8	(1) USB Type B connector	Connects to USB port on target PC for keyboard /mouse data
9	(1) Link/activity LED	Illuminates green when there is activity on the link
10	(1) RJ-45 connector	Connects to 10-/100-/1000-Mbps network
11	(1) Link speed LED	Illuminates to show link speed; blinks once for 10 Mbps, twice for 100 Mbps, and three times for 1 Gbps
12	(2) DisplayPort™ connectors	Connects to DisplayPort outputs up to 1920x1200
13	(1) 3.5-mm jack (SPK)	Connects to analog speaker

5.11.6 EMERALD PE OR PE POE TRANSMITTER CONNECTOR INFORMATION

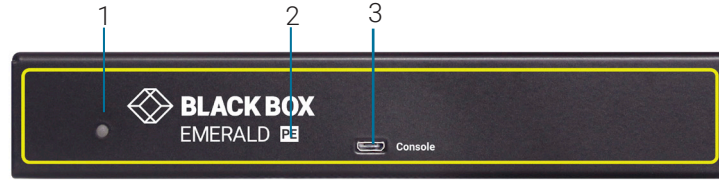

FIGURE 5-31. FRONT VIEW OF THE EMERALD PE TRANSMITTER, SINGLE-HEAD (EMD2000PE-T (EOL), EMD2000PE-T-P (EOL))

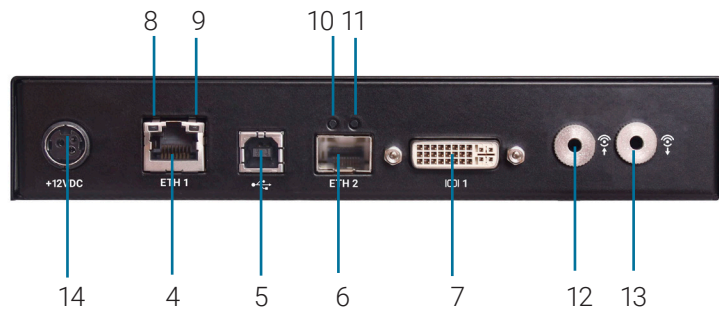

FIGURE 5-32. REAR VIEW OF THE EMERALD PE TRANSMITTER, SINGLE-HEAD (EMD2000PE-T (EOL), EMD2000PE-T-P (EOL))

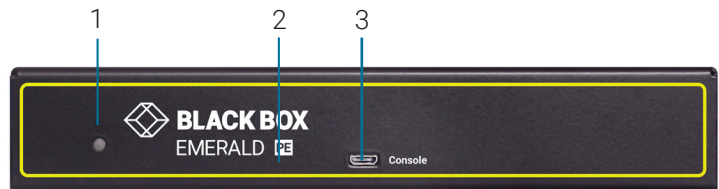

FIGURE 5-33. FRONT VIEW OF THE EMERALD PE TRANSMITTER, DUAL-HEAD (EMD2002PE-T (EOL), EMD2002PE-T-P (EOL))

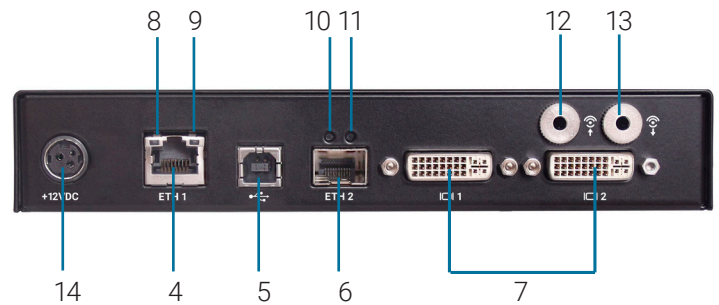

FIGURE 5-34. REAR VIEW OF THE EMERALD PE TRANSMITTER, DUAL-HEAD (EMD2002PE-T (EOL), EMD2002PE-TP (EOL))

TABLE 5-12. EMERALD PE OR PE POE TRANSMITTER COMPONENTS

NUMBER IN FIGURES 5-31 THROUGH 5-34	COMPONENT	DESCRIPTION
1	(1) Power LED	Indicates when the unit is powered up
2	(1) Reset button	Press for 5 seconds to factory reset unit
3	(1) Micro USB connector	Reserved for future use
4	(1) RJ-45 connector	Connects to 10-/100-/1000-Mbps network
5	(1) USB Type B connector	Connects to USB port on target PC for keyboard/mouse data
6	(1) SFP cage	Connects network SFP module for 1 Gbps network
7	(1) or (2) DVI connectors	Links to DVI output up to 1920x1200
8	(1) Link/activity LED	Illuminates green when there is activity on the link
9	(1) Link speed LED	Illuminates to show link speed; blinks once for 10 Mbps, twice for 100 Mbps, and three times for 1 Gbps
10	(1) SFP activity LED	Illuminates green when there is activity on the link
11	(1) SFP speed LED	Illuminates to show link speed
12	(1) 3.5-mm jack (SPK)	Connects to analog speaker
13	(1) 3.5-mm jack (MIC)	Connects to analog microphone
14	(1) 3-pin locking connector (PWR)	Connects to the external 12VDC power supply

5.11.7 EMERALD PE R2 SINGLE-HEAD TRANSMITTER CONNECTOR INFORMATION

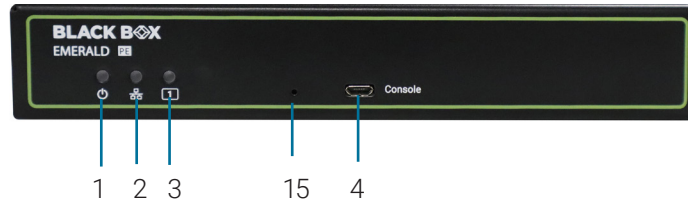

FIGURE 5-35. FRONT VIEW OF EMD2000PE-T-R2

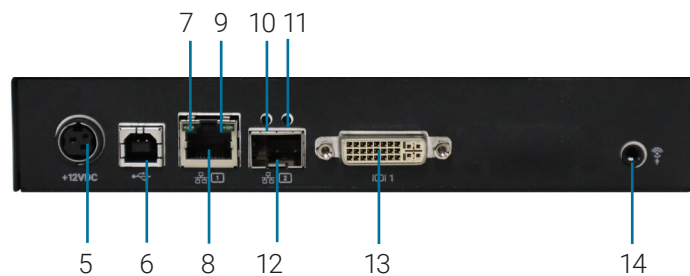

FIGURE 5-36. REAR VIEW OF EMD2000PE-T-R2

TABLE 5-13. EMERALD PE OR PE POE TRANSMITTER COMPONENTS

NUMBER IN FIGURES 5-35 THROUGH 5-36	COMPONENT	DESCRIPTION
1	(1) Power LED	Indicates when the unit is powered up
2	(1) Network LED	Indicates when a network is connected
3	(1) Video 1 status LED	Indicates when video 1 sync is detected
4	(1) Mini USB	Reserved for future use
5	(1) 3-pin locking connector	Connects to the external 12VDC power supply
6	(1) USB Type B connector	Connect to USB port on target PC for keyboard/mouse data
7	(1) Link/activity LED	Illuminates green when there is activity on the link
8	(1) RJ-45 connector	Connects to 10-/100-/1000-Mbps network
9	(1) Link speed LED	Illuminates to show link speed; blinks once for 10 Mbps, twice for 100 Mbps, and three times for 1 Gbps
10	(1) SFP link/activity LED	Illuminates green when there is activity on the link
11	(1) SFP speed LED	Illuminates to show link speed
12	(1) SFP cage	Connects network SFP module for 1 Gbps network
13	(1) DVI connector	Connects to DVI output up to 1920x1200
14	(1) 3.5-mm jack (SPK)	Connects to analog speaker
15	(1) Reset button	Press for 5 seconds to factory reset unit

5.11.8 EMERALD PE R2 DUAL-HEAD TRANSMITTER CONNECTOR INFORMATION

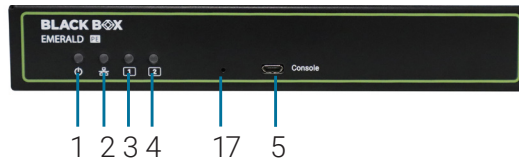

FIGURE 5-37. FRONT VIEW OF EMD2002PE-T-R2

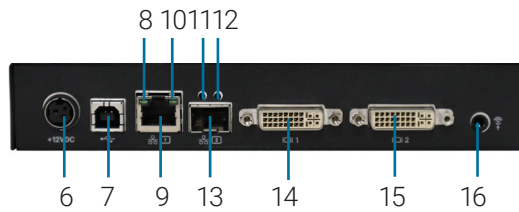

FIGURE 5-38. REAR VIEW OF EMD2002PE-T-R2

TABLE 5-14. EMERALD PE OR PE POE TRANSMITTER COMPONENTS

NUMBER IN FIGURES 5-37 THROUGH 5-38	COMPONENT	DESCRIPTION
1	(1) Power LED	Indicates when the unit is powered up
2	(1) Network LED	Indicates when a network is connected
3	(1) Video 1 status LED	Indicates when video 1 sync is detected
4	(1) Video 2 status LED	Indicates when video 2 sync is detected
5	(1) Mini USB	Reserved for future use
6	(1) 3-pin locking connector (PWR)	Connects to the external 12VDC power supply
7	(1) USB Type B connector	Connects to USB port on target PC for keyboard/mouse data
8	(1) Link/activity LED	Illuminates green when there is activity on the link
9	(1) RJ-45 connector	Connects to 10-/100-/1000-Mbps network
10	(1) Link speed LED	Illuminates to show link speed; blinks once for 10 Mbps, twice for 100 Mbps, and three times for 1 Gbps
11	(1) SFP activity LED	Illuminates green when there is activity on the link
12	(1) SFP speed LED	Illuminates to show link speed
13	(1) SFP cage	Connects network SFP module for 1 Gbps network
14	(1) DVI connector 1	Connects to DVI output 1 up to 1920x1200
15	(1) DVI connector 2	Connects to DVI output 2 up to 1920x1200
16	(1) 3.5-mm jack (SPK)	Connects to analog speaker
17	(1) Reset button	Press for 5 seconds to factory reset unit

5.11.9. EMERALD PE SINGLE-HEAD DISPLAYPORT TRANSMITTER CONNECTOR INFORMATION

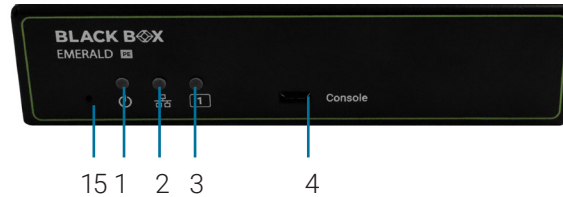

FIGURE 5-39. FRONT VIEW OF THE EMERALD PE TRANSMITTER, SINGLE-HEAD (EMD2000PE-DP-T)

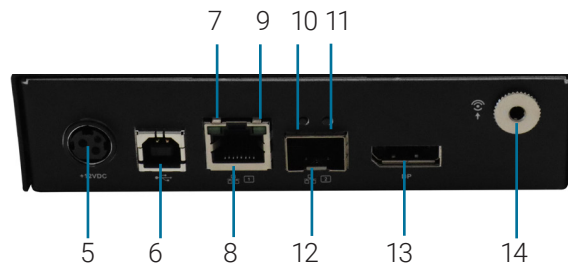

FIGURE 5-40. REAR VIEW OF THE EMERALD PE TRANSMITTER, SINGLE-HEAD (EMD2000PE-DP-T)

TABLE 5-15. EMERALD PE DISPLAYPORT TRANSMITTER COMPONENTS

NUMBER IN FIGURES 5-39 THROUGH 5-40	COMPONENT	DESCRIPTION
1	(1) Power LED	Indicates when the unit is powered up
2	(1) Network LED	Indicates when a network is connected
3	(1) Video 1 status LED	Indicates when video 1 sync is detected
4	(1) Mini USB	Reserved for future use
5	(1) 3-pin locking connector (PWR)	Connects to the external 12VDC power supply
6	(1) USB Type B connector	Connects to USB port on target PC for keyboard/mouse data
7	(1) Link/activity LED	Illuminates green when there is activity on the link
8	(1) RJ-45 connector	Connects to 10-/100-/1000-Mbps network
9	(1) 10-/100-/1000-Mbps LED	Illuminates green when data is being transmitted at 1000 Mbps
10	(1) SFP activity LED	Illuminates green when there is activity on the link
11	(1) SFP speed LED	Illuminates to show link speed
12	(1) SFP cage	Connects network SFP module for 1 Gbps network
13	(1) DisplayPort™	Connects to DisplayPort output up to 1920x1200
14	(1) 3.5-mm jack (SPK)	Connects to analog speaker
15	(1) Reset button	Press and hold for 5 seconds to factory reset unit

CHAPTER 5: INSTALLATION

5.11.10 EMERALD PE DUAL-HEAD DISPLAYPORT TRANSMITTER CONNECTOR INFORMATION

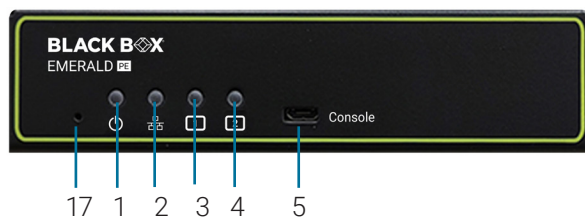

FIGURE 5-41. FRONT VIEW OF THE EMERALD PE TRANSMITTER, DUAL-HEAD (EMD2002PE-DP-T)

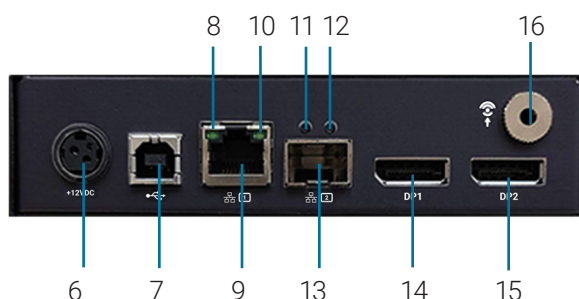

FIGURE 5-42. FRONT VIEW OF THE EMERALD PE TRANSMITTER, DUAL-HEAD (EMD2002PE-DP-T)

TABLE 5-16. EMERALD PE DUAL HEAD DISPLAYPORT TRANSMITTER COMPONENTS

NUMBER IN FIGURES 5-41 THROUGH 5-42	COMPONENT	DESCRIPTION
1	(1) Power LED	Shows the unit's power status
2	(1) Network LED	Indicates when a network is connected
3	(1) Video 1 status LED	Indicates when video 1 sync is detected
4	(1) Video 2 status LED	Indicates when video 2 sync is detected
5	(1) Mini USB	For development use
6	(1) 3-pin locking connector (PWR)	Connects to the external 12VDC power supply
7	(1) USB Type B connector	Connects to USB port on target PC for keyboard/mouse data
8	(1) Link/activity LED	Illuminates green when there is activity on the link
9	(1) RJ-45 connector	Connects to 10-/100-/1000-Mbps network
10	(1) Link speed LED	Illuminates to show link speed; blinks once for 10 Mbps, twice for 100 Mbps, and three times for 1 Gbps
11	(1) SFP activity LED	Illuminates green when there is activity on the link
12	(1) SFP network speed LED	Connects to a 10-/100-/1000-Mbps network using a SFP
13	(1) SFP cage	Connects network SFP module for 1 Gbps network
14	(1) DisplayPort™ connector 1	Connects to DisplayPort output up to 1920x1200
15	(1) DisplayPort connector 2	Connects to DisplayPort output up to 1920x1200
16	(1) 3.5-mm jack (SPK)	Connects to analog speaker
17	(1) Reset button	Press and hold for 5 seconds to factory reset unit

5.11.11 EMERALD 4K TRANSMITTER CONNECTOR INFORMATION

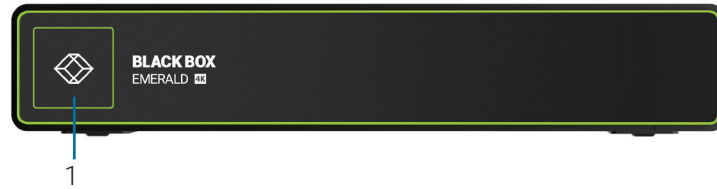

FIGURE 5-43. FRONT VIEW OF THE EMERALD 4K TRANSMITTER (EMD4000T)

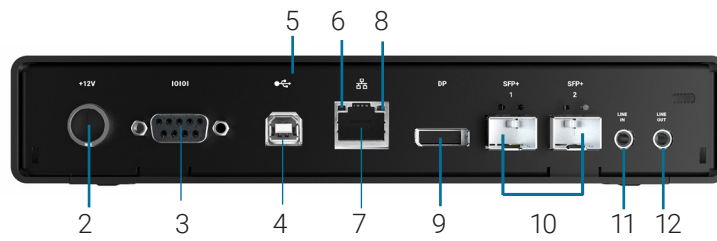

FIGURE 5-44. REAR VIEW OF THE EMERALD 4K TRANSMITTER (EMD4000T)

TABLE 5-17. EMERALD TRANSMITTER COMPONENTS

NUMBER IN FIGURE 5-43 AND 5-44	COMPONENT	DESCRIPTION
1	(1) Power LED	Shows the unit's power status
2	(1) 3-pin locking connector (PWR)	Connects to the external 12VDC power supply
3	(1) DB9 connector	Connects to RS-232 serial console interface for management
4	(1) USB Type B connector	Connects to USB port on target PC for keyboard/mouse data
5	(1) Reset button	Press and hold for 5 seconds to factory reset unit
6	(1) RJ-45 connector	Connects to 10-/100-/1000-Mbps networks
7	(1) Link/activity LED	Illuminates green when there is activity on the link
8	(1) Link speed LED	Illuminates to show link speed; blinks once for 10 Mbps, twice for 100 Mbps, and three times for 1 Gbps
9	(1) DisplayPort™ connector	Connects to DisplayPort output up to 1920x1200
10	(2) SFP module slots	Twisted-pair or fiber optic modules install here: (2) SFP+ slots (included for redundancy)
11	(1) 3.5-mm jack (MIC)	Connects to analog microphone
12	(1) 3.5-mm jack (SPK)	Connects to analog speaker

CHAPTER 5: INSTALLATION

5.12 CONNECT THE EMERALD ZEROU DVI OR DISPLAYPORT TRANSMITTER

Before connecting the Emerald® ZeroU DVI or DisplayPort™ transmitter to the remote workstation, ensure that the resolution and the refresh rate of the remote workstation are supported by the Emerald system. Set the screen resolution and refresh rate of the remote workstation. Unsupported settings will cause blank or distorted video at the receiver.

The recommended sequence to connect the transmitter is:

1. Turn off the remote workstation.
2. The Emerald ZeroU DVI or DisplayPort transmitter has two USB connectors. Connect them to the corresponding USB ports on the remote workstation.
3. Connect the DVI or DisplayPort video connector on the Emerald ZeroU DVI or DisplayPort transmitter to the appropriately labeled port on the workstation using the DVI or DisplayPort cable.
4. Connect one end of the UTP cable to the Emerald ZeroU DVI or DisplayPort transmitter's RJ-45 connector and turn on the workstation.
5. Route the other end of the UTP cable to the location you have chosen for the Emerald SE receiver. If necessary, you can extend the UTP cable via an Ethernet switch (subject to normal Ethernet cabling practices).
6. The Emerald ZeroU DVI or DisplayPort transmitter can be powered via the USB ports. Optionally, plug an external power supply's connector into the DC power jack on the rear of the Emerald SE transmitter.

NOTE: The power supply is not included and must be ordered separately (part number EMD2000-PSU).

7. Optionally, connect the detachable power cord to the power supply.
8. Optionally, plug the power cord into an appropriate wall outlet. The transmitter powers on automatically.
9. Turn on power for the remote workstation.

NOTE: Use only the power supply provided by Black Box.

CHAPTER 6: NETWORKED INSTALLATION

6.1 POINT-TO-POINT INSTALLATION

In a point-to-point configuration, no Administrator setup of the Emerald® transmitter or the Emerald receiver is required. This enables you to install the system quickly, directly out-of-the-box. However, in the point-to-point configuration, you can install only one Emerald transmitter and Emerald receiver pair on a subnet, and both must be on the same subnet unless a router is present in the network to span subnets.

Also if there are other devices with 192.168.1.21 (default receiver IP address) or 192.168.1.22 (default transmitter IP address) on the network, then the IP addresses for receiver and/or transmitter should be changed to unused IP addresses.

6.2 UNMANAGED OR MANAGED MATRIX INSTALLATION

The following instructions will enable you to install your Emerald receiver and Emerald transmitter in a networked configuration. In this installation, multiple Emerald transmitters and Emerald receivers are attached via the same Ethernet network. In this case, it is important for each unit to be configured with a unique IP address.

The Emerald receiver has been preconfigured with factory-default network settings. If you install multiple units on the same network, you will need to assign a unique IP address to each unit or configure the receiver for DHCP. This can be done via the On-Screen Display (OSD) on the Emerald receiver and must be carried out before adding multiple devices on the same network. It is strongly recommended that all device IP addresses be configured using a static IP address.

TABLE 6-1. EMERALD SYSTEM DEFAULT NETWORK SETTINGS

COMPONENT	IP ADDRESS	TYPE	DEFAULT GATEWAY	SUBNET MASK
Emerald SE Receiver (EMD2000SE-R, EMD2002SE-R)	192.168.1.21	Static	192.168.1.1	255.255.255.0
Emerald SE Transmitter (EMD2000SE-T, EMD2002SE-T)	192.168.1.22	Static	192.168.1.1	255.255.255.0
Emerald SE R2 Transmitter (EMD2000SE-T-R2)	192.168.1.22	Static	192.168.1.1	255.255.255.0
Emerald PE & SE DisplayPort™ Transmitters (EMD2000PE-DP-T, EMD2000SE-DP-T, EMD2002PE-DP-T, EMD2002SE-DP-T)	192.168.1.22	Static	192.168.1.1	255.255.255.0
Emerald SE & PE DisplayPort Receivers (EMD2000SE-DP-R, EMD2002SE-DP-R, EMD2000PE-DP-R, EMD2002PE-DP-R)	192.168.1.21	Static	192.168.1.1	255.255.255.0
Emerald PE Receiver (EMD2000PE-R, EMD2002PE-R)	192.168.1.21	Static	192.168.1.1	255.255.255.0
Emerald PE PoE Transmitter (EMD2000PE-T, EMD2002PE-T)	192.168.1.22	Static	192.168.1.1	255.255.255.0
Emerald PE PoE Receiver (EMD2000PE-R-P, EMD2002PE-R-P)	192.168.1.21	Static	192.168.1.1	255.255.255.0
Emerald PE R2 Transmitter (EMD2000PE-T-R2, EMD2002PE-T-R2)	192.168.1.22	Static	192.168.1.1	255.255.255.0
Emerald ZeroU DVI Transmitter (EMD2000DV-T)	192.168.1.22	Static	192.168.1.1	255.255.255.0
Emerald ZeroU DisplayPort Transmitter (EMD2000DP-T)	192.168.1.22	Static	192.168.1.1	255.255.255.0
Emerald 4K Transmitter (EMD4000T)	192.168.1.22	Static	192.168.1.1	255.255.255.0
Emerald 4K Receiver (EMD4000R)	192.168.1.21	Static	192.168.1.1	255.255.255.0
Boxilla Manager (BXAMGR)	192.168.1.24	Static	192.168.1.1	255.255.255.0
Boxilla Manager (BXAMGR-R2)	192.168.1.24	Static	192.168.1.1	255.255.255.0



CHAPTER 7: OPERATION OF EMERALD SYSTEM

Operating a workstation through the Emerald® system is no different than working directly connected to a PC desktop. All peripherals operate as if directly connected, even though the workstation is located at a distance.

7.1 LED IDENTIFICATION

Front panel

There is a power button on the front panel of an Emerald SE unit. This button is disabled. The Emerald PE unit has a power LED, but it does not have a power button.

NOTE: The SE or PE unit powers on automatically when plugged in, and they must be turned off at the power source.

The Emerald ZeroU DVI or DP transmitter unit has a Power LED. It can be powered either via USB or via an optional power supply.

Rear panel

Two LEDs are built into the RJ-45 connectors on the Emerald SE receiver, Emerald SE transmitter, and Emerald ZeroU DVI or DisplayPort™ transmitter. The definition of the operation of these LEDs is shown in Table 7-1.

**TABLE 7-1. RJ-45 CONNECTOR LEDS ON THE REAR PANEL
OF THE EMERALD SE RECEIVER AND TRANSMITTER**

LED	STATUS	DESCRIPTION
Activity	Green ON	Linked OK
	Green Flashing	Transmit/Receive activity
	Green OFF	No link
Link Speed	Blinks green one time	10 Mbps
	Blinks green two times	100 Mbps
	Blinks green three times	1000 Mbps
	No blinking	No valid link

7.2 ACCESSING THE SYSTEM

A connection is established using the On-Screen Display (OSD) on an Emerald receiver or Boxilla® Manager. You will be able to interact with the remote workstation as if it were located at your desk.

NOTE: If the remote workstation is powered OFF, the Emerald system will display a “black” screen for video when a connection is made.

CHAPTER 8: OSD FUNCTIONS

The Emerald® receiver and Boxilla® Manager incorporate an On-Screen Display (OSD) that allows you to view information about the configuration of your system and potentially also allows for setting connections and configuration parameters such as the IP address, depending on the type of user. The following sections describe the operation common on a receiver.

8.1 USER TYPES

The Emerald system supports three classes of users for matrix products:

1. Administrator – users of this class have full rights to configure the system. They can create/modify/delete new users and connections, change network settings, etc.
2. Power User – users of this class can modify resolution for connections to virtual desktops and change his/her local password.
3. Standard User – users of this class can only select from a list of pre-defined connections to access and view system information. They cannot change any configuration settings.

8.2 LOG ON

A user must log-on to the Emerald receiver or Boxilla Manager to configure and manage the Emerald system. The log-on screen is shown in Figure 8-1. The username defines the access rights and configuration available to the user.

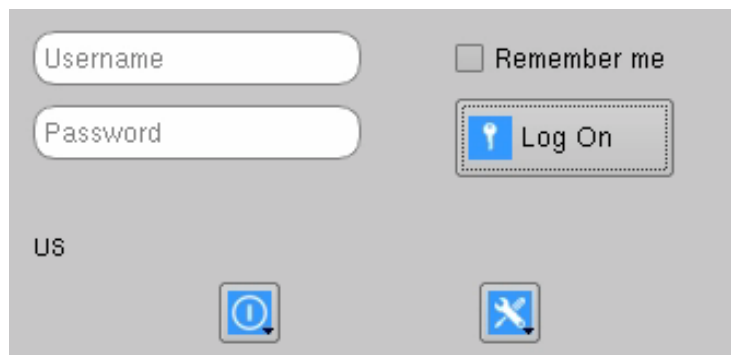

FIGURE 8-1. OSD LOG-ON SCREEN

The fields on this screen are:

- ♦ Username: the username to log-on as defined by the Administrator and/or Active Directory if using the Boxilla manager. Username is case-sensitive. If the username doesn't match an existing Boxilla username, the Active Directory server will be checked afterward.
- ♦ Password: password for the user. Password is case-sensitive.
- ♦ Remember Me: When this box is checked, the unit keeps the username between log-ons and power-cycles. When this box is not checked, the username field is always presented as blank when powered-up and after a log-out. This tick-box only affects the username. The password is never preserved.
- ♦ Log On: When the username and password fields are filled out, pressing this button initiates the login using the entered credentials. Pressing the Enter key when the cursor is positioned in the password field also initiates the log on.
- ♦ Power Button: This button allows the user to reboot the client.

CHAPTER 8: OSD FUNCTIONS



FIGURE 8-2. LOG-ON SCREEN - REBOOT BUTTON

- ◆ System Preferences: This button has a drop down menu that allows the user to define system preferences for the Emerald® receiver. Figure 8-3 shows how the keyboard type can be selected.

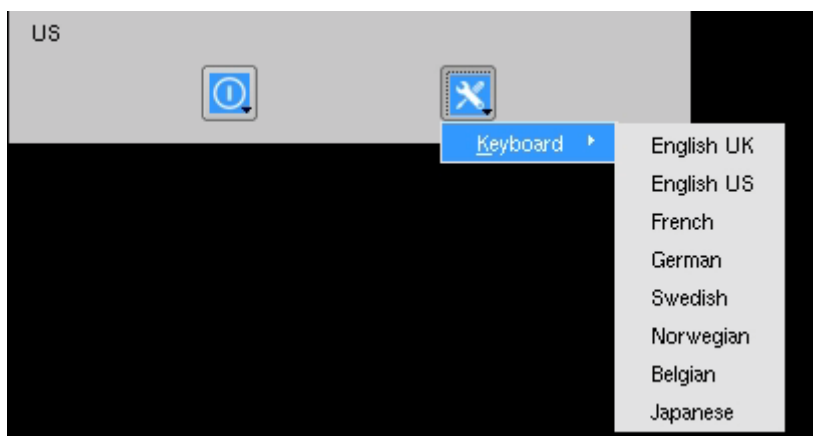

FIGURE 8-3. SETTING SYSTEMS KEYBOARD TYPE

8.3 DEFAULT USERNAME AND PASSWORD

The Emerald receiver ships with a default username of admin with a blank password (no password). This user cannot be deleted, but the password can be changed.

NOTE: If you create a password for the default Admin account and forget it, there is no way to reset/retrieve it unless using a Boxilla® manager. We recommend that the Administrator creates a second Admin account for critical systems in case the main Admin account is locked out. In the event you still cannot gain access, a factory reset may be required.

CHAPTER 8: OSD FUNCTIONS

8.4 USER VIEWS AND CAPABILITIES

There are three different types of users in the Emerald® System. Your user type will determine what exactly you will see on your OSD. For the purpose of this manual, we show the screen of an Administrator. This means that some buttons shown here may not be available to other users.

The Emerald comes as an unmanaged system and as a managed system. There are some differences in the OSD for these systems which you may see here.

8.5 CONNECTIONS SCREEN

When a user successfully logs on to the Emerald receiver, the Connection screen is displayed. This is shown in Figure 8-4. The connections that a user can make are listed in the connection window. The user logged on is shown in the top right corner of the OSD.

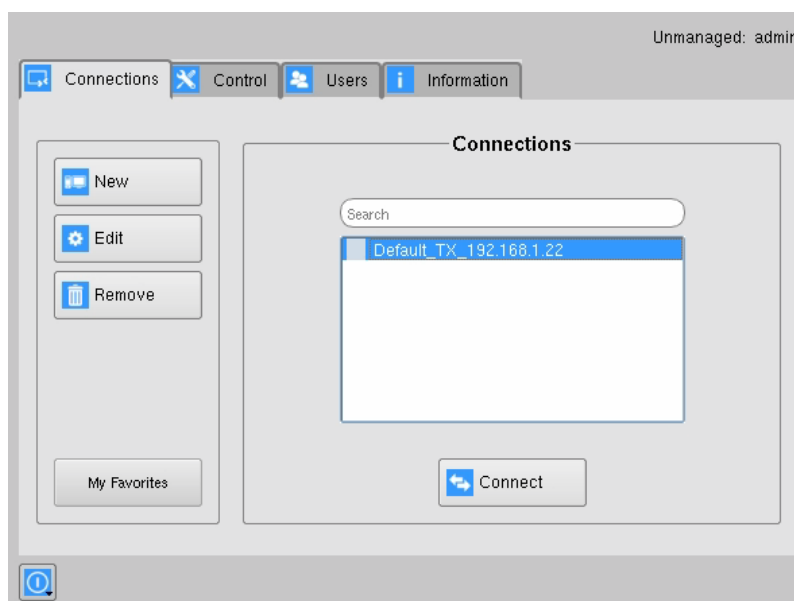

FIGURE 8-4. CONNECTION SCREEN (ADMINISTRATOR)

If the user is an Administrator type, the three buttons on the left (New, Edit, and Remove) will be displayed. These allow the user to create, edit, or remove connections. For standard user types, no connections can be created, edited, or removed, so these buttons are not displayed or are greyed out. The user will also not see the Control, Users, and Information tabs.

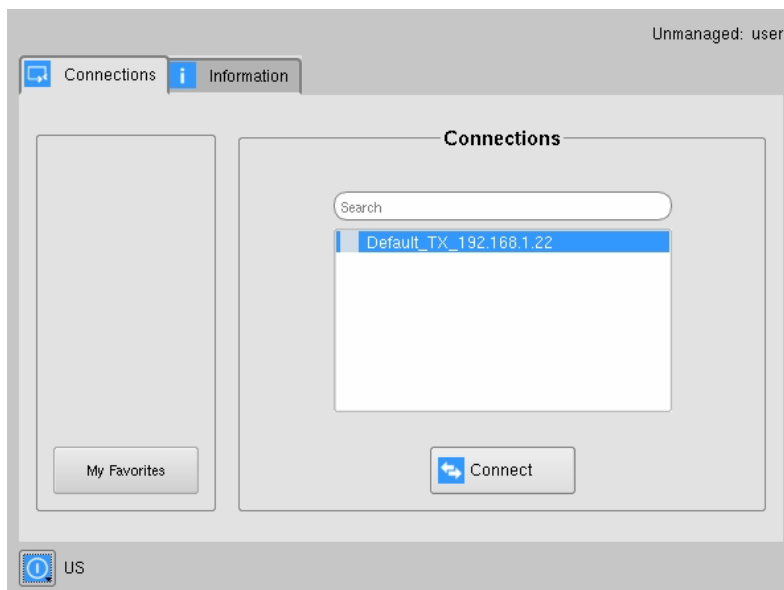

FIGURE 8-5. CONNECTION SCREEN (USERS)

By default, there is one connection called Default TX - 192.168.1.22 that defines a connection to an Emerald® transmitter with its factory defaults. A maximum of 32 connections can be defined for an Emerald receiver by default, and these connections can be shared by users as defined by an Administrator (different users can have the same connection). The number of connections can be increased to unlimited in a managed domain via Boxilla® upgrade licenses. Multiple connections can be created using different parameters for the same physical transmitter. In this example you may have a connection for a 192.168.1.22 transmitter with two connections assigned to it (one with Exclusive, the other Shared).

8.5.1 IDLE SCREEN

The Emerald receivers support a static idle screen which allows the user to activate it when using the HOTKEY + S. The static idle screen can be invoked when at the OSD or on an active connection. When you want to go back to the OSD or connection, use the HOTKEY + O.



FIGURE 8-6. WALLPAPER SCREEN

CHAPTER 8: OSD FUNCTIONS

8.5.2 CREATING A NEW CONNECTION

To allow an Emerald® receiver to connect to a target Emerald transmitter, an Administrator must create a connection. The Administrator clicks on the New button on the Connections screen. This causes the New Connections pop-up window to appear as shown in Figure 8-7.

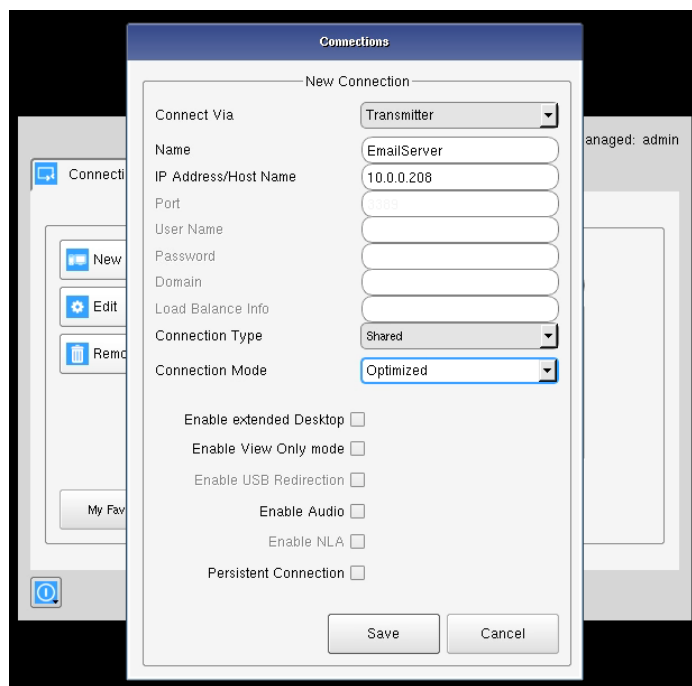

FIGURE 8-7. NEW CONNECTION WINDOW

The fields on this screen are:

- **Connect Via:** This is the connection type that can be set. Options for transmitter or VM Direct are available.
- **Name:** this is a unique name for the new connection. The name can be between 1 and 32 characters. The name can be composed of any alphanumeric characters and special characters except for " " / \ [] | = , + * ? < > `.
- **IP Address/Host Name:** IP Address of Emerald transmitter (if Connection Via set to Transmitter) or VM in IP v4 format. Alternatively it can be the Host Name if this can be resolved in the local DNS server. Note: Using Host Name will increase the switching time by the time needed to resolve the Host Name to an IP address.
- **Port:** defines the port to be used for the RDP connection via VM Direct or Broker. Uses port 3389 by default.
- **Username:** defines username to be used on a VM connection. Only used for connections via VM Direct or Broker. If left blank on VM Direct – user will be presented with Windows Login screen on VM; NLA must be turned off if not entering a username here.
- **Password:** defines the password to be used on a VM connection. Only used for connections via VM Direct or Broker.
- **Domain:** defines domain that a virtual machine is part of (if part of a windows domain). Not used for connections to transmitters.
- **Load Balance Info:** Defines resources on the broker (VM Pool that the receiver will attempt to connect to after user credentials have been validated). Only used on connection via Broker.

CHAPTER 8: OSD FUNCTIONS

- ◆ **Connection Type:** Used to define whether a connection is Private, Shared, or Exclusive. Shared and Exclusive connections can have more than 1 Emerald® receiver connect to it at the same time. Shared and Exclusive connections do not support USB redirection; therefore they do not support USB 2.0 devices except for keyboard, mouse, and select touchscreens. Private connections only allow for a single Emerald receiver connection and blocks any new connections. Private connections support USB redirection for USB 2.0 devices.
- ◆ **Exclusive Connection:** The Boxilla® administrator can define a connection parameter of Exclusive mode for physical transmitters and receivers only. This Exclusive connection (Exclusive Shared connection) allows for a single user to have full keyboard and mouse control while seeing video, and support USB redirection and additional users on the same connection are in view-only mode. This connection can support one user that has full control, and up to 7 view-only-mode users. The view-only-mode users are able to use the keyboard and mouse hot-keys only to go back to the OSD or connect to another target using Favorites without affecting the existing session. If a user connects using “Shared” Exclusive to an existing shared only connection, that user who used the “Shared” Exclusive connection will get keyboard and mouse control, and the other users revert to a view-only mode. Upon terminating a “Shared” Exclusive connection, the remaining active users in that same connection will revert back to shared mode.

Note: Exclusive Connections are supported on every Emerald transmitter and receiver, but not supported on RemoteApp, DESKVUE, or when connecting to a virtual machine.

The image below is only a reference showing all connection options within an unmanaged Emerald OSD.

The screenshot shows a dialog box titled "Connections" with a sub-header "Edit Connection". It contains the following fields and options:

- Connect Via: Transmitter (dropdown)
- Name: Default_TX_192.168.1.22
- IP Address/Host Name: 192.168.1.22
- Port: 3389
- User Name: (empty text box)
- Password: (empty text box)
- Domain: (empty text box)
- Load Balance Info: (empty text box)
- Connection Type: Private (dropdown)
- Connection Mode: Exclusive (dropdown menu is open showing Private, Shared, and Exclusive)
- Enable Extended Desktop:
- Enable View Only mode:
- Enable USB Redirection:
- Enable Audio:
- Enable NLA:
- Persistent Connection:

Buttons: Save, Cancel

FIGURE 8-8. CONNECTION OPTIONS

CHAPTER 8: OSD FUNCTIONS

The image below references the connection parameters when the Emerald device is managed by Boxilla:

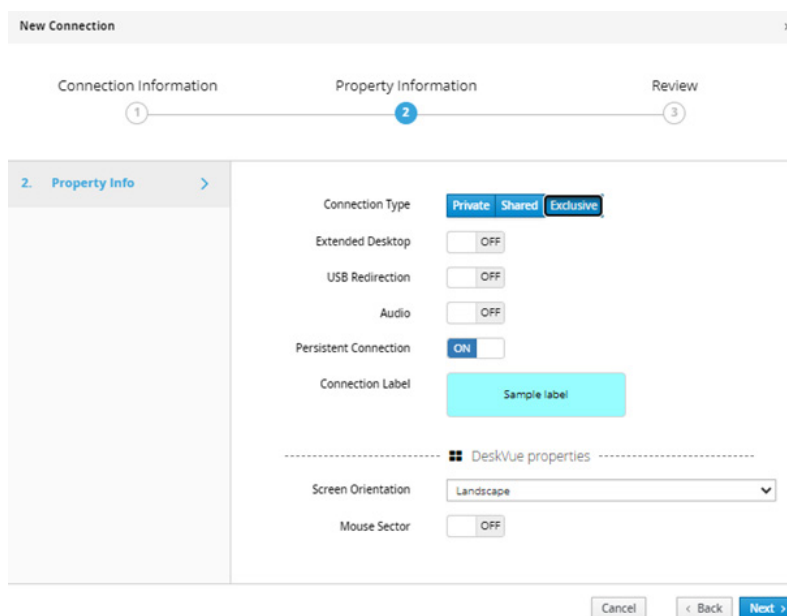

FIGURE 8-9. CONNECTION PARAMETERS

- ◆ **Connection Mode:** There are two options available depending on the device you are using. Optimized connections allows a 2K receiver to connect with a 2K transmitter, or allows a 2K receiver connect with a 4K transmitter. Lossless connections allow a 4K receiver to connect with a 4K transmitter only. 2K receivers and RemoteApp will never show any connections with Lossless configuration.
- ◆ **Enable Extended Desktop:** Remote connections can be extended for dual-head Emerald units by enabling the option Extended Desktop. Enable Extended Desktop setting enables the second video head of a dual-head transmitter. Make sure both the video heads on the transmitter are connected to the source. Video heads on the receiver are connected to respective monitors.
- ◆ **Enable View Only mode:** View only setting for a connection allows user to monitor what is been transmitted from a source without being able to interact with the source. This feature allows a user or Administrator to monitor the actions on the network without accidentally interacting with other users. View only connection is available in both private and shared mode connections with or without analog audio.
- ◆ **Enable USB Redirection:** when set, this enables non-keyboard and non-mice devices (such as tablets and USB headsets) to be redirected for this connection. Shared connection modes do not support USB redirection; therefore they only support keyboard and mouse. Private connection modes support USB redirection. ZeroU transmitters (i.e. EMD200DV-T, EMD200DP-T) do not support USB redirection at all.
- ◆ **Enable Audio:** when set, this enables audio to be supplied to the remote audio connectors.
- ◆ **Enable NLA:** when set, this enables Network Level Authentication requiring that the user be authenticated to the RD Session Host server before the session is created. This is not used for when Connection Via is set to Transmitter.
- ◆ **Persistent Connection:** When turned on, Persistent Connection will constantly try to connect the receiver with the transmitters until successful. This is useful when using Emerald for digital signage or an application that does not need a keyboard/mouse to stay connected to a defined source.

CHAPTER 8: OSD FUNCTIONS

8.5.3 CONNECTION FAVORITES

Connection favorites provide a quick convenient mechanism for users to switch between their pre-defined connections. Favorites are configured by the Administrator where a maximum of 10 favorites can be assigned to users using a combination of hot-key and [0-9].

Assigning Connection Favorites

Prerequisites are that the user exists; the user has connections assigned; and the Functional Hot-key is enabled.

The following screenshot demonstrates the Administrator assigning connections for the user to the available hot-keys. Favorites do not need to be allocated sequentially and hot-keys can be skipped.

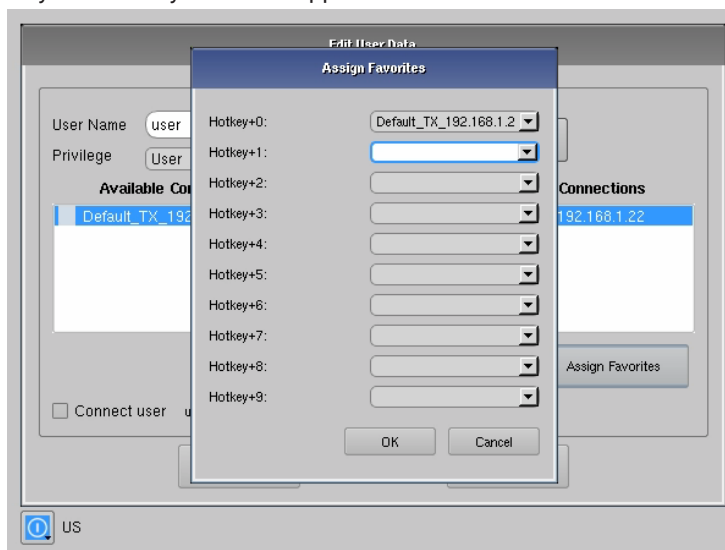

FIGURE 8-10. ASSIGNING CONNECTION FAVORITES

Listing Connection Favorites:

When a user logs in, they can view their assigned favorites.

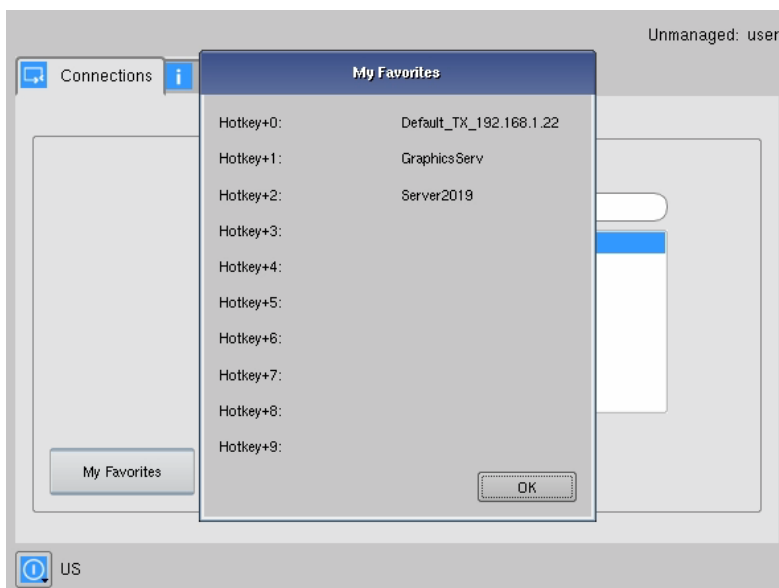

FIGURE 8-11 LISTING CONNECTION FAVORITES

CHAPTER 8: OSD FUNCTIONS

8.5.4 CONNECTING

To make a connection, the user highlights the required “connection” in the window and then clicks on the Connect button. Alternatively, a user can double-click on the connection. This action causes the Emerald® receiver to attempt to connect to the target remote workstation or virtual machine. If the target is available, the connection will be made.

The user can also use the arrow and Enter keys on a keyboard to select a connection.

If another user is already connected to the target using a private connection, the user will receive a pop-up window indicating the target device is already allocated. If connection errors occur, they will be displayed in an error popup window.

8.5.5 EDIT CONNECTION

To edit a connection and change its parameters, an Administrator clicks on the Edit button on the Connections screen. The Edit Connections pop-up window appears.

The Administrator changes required fields and clicks on the Save button to confirm or on the Cancel button to discard any changes.

8.5.6 REMOVE CONNECTION

To remove or delete a connection, an Administrator highlights a connection in the list and then clicks on the Remove button on the Connections screen (shown in Figure 8-8). This causes the Remove Connection pop-up window to appear where a user confirms the removal or cancels the attempt.

8.5.7 BONDING

NOTE: Bonding requires the Boxilla® manager.

This assumes that setup is complete on Boxilla and a user has permission to connect to a Bonded connection. See the setup instructions in the Boxilla user manual.

When the user selects a “bonded connection” from any receiver that is part of a bonded group, Receiver 1 will connect to Connection 1, and Receiver 2 will connect to connection 2, and so on, up to 8 bonded links.

Connections will all be made assuming they are available using the normal rules. For example, if one connection is in a private connection and therefore cannot be connected to, all connections within the bond will fail. The user will get an error message from the user station they requested explaining why connection could not be made and will identify the user in private connection.

Once the user has a successful connection, if they disconnect using the OSD, all connections will be terminated.

While the user is in a bonded connection and if they wish to switch one of the receivers to another connection without dropping the full bonded setup, they shall use favorites, and this receiver will switch to the desired target without calling the OSD and leaving all other connections in the bonded connection up and running. The exception to this is that favorites cannot be used from receivers that launched connections via Boxilla.

CHAPTER 8: OSD FUNCTIONS

8.6 CONTROL TAB

The Control Tab on the OSD enables an Administrator to change the configuration of the Emerald® system. The Control Tab is shown in Figure 8-12.

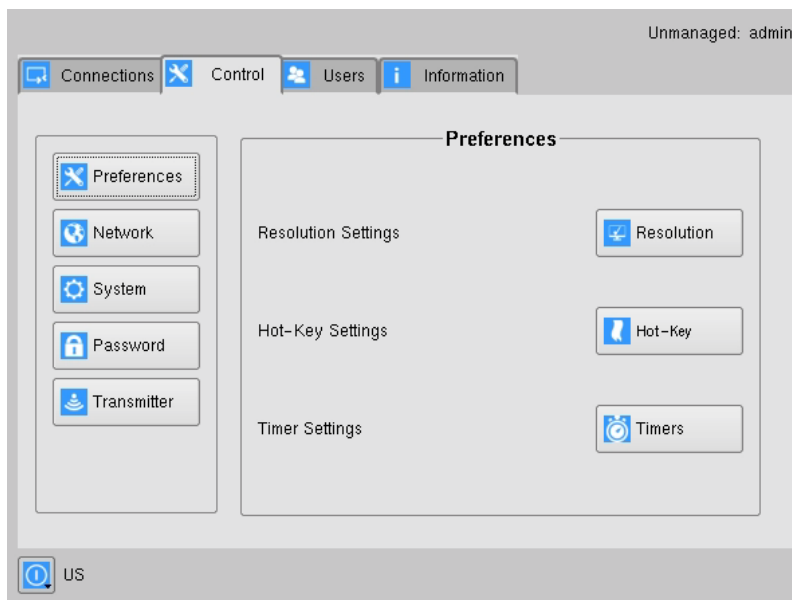

FIGURE 8-12. CONTROL TAB

There are five functions that can be accessed on this tab:

1. Preferences – allows users to change preference settings for:
 - Resolution Settings – allows change of preferred resolution for OSD screens and virtual connections.
 - Hot-Key Settings – allows changing of the active hot-key for keyboard shortcuts.
 - Timer Settings – allows setting of preemption timer and various inactivity timers
 - Connection Label Settings (not applicable to the Emerald® SE Model) – allows activation/deactivation of connection label and set label preferences
2. Network – allows the Administrator to change network parameters for the Emerald receiver or Manager.
3. System – allows upgrading of unit firmware, reset unit to factory defaults, collect diagnostic logs, and to save/restore unit configuration to a USB drive.
4. Password – change the Administrator or user password.
5. Transmitter – allows changing of transmitter parameters.

CHAPTER 8: OSD FUNCTIONS

8.6.1 PREFERENCES

Resolution

The Resolution button allows an Administrator or power user to set the preferred resolution for the RDP Connection and for the OSD. By default, both the RDP Resolution and the OSD Resolution are set to Auto.

The RDP Connection Resolution allows the resolution to be changed for an RDP connection. For example, it defines the resolution that the virtual desktop will be accessed with. If the preferred resolution is not supported, the receiver will use the next highest resolution supported by both monitor and receiver.

The OSD resolution is set to Auto by default, but can be changed to the available OSD resolutions if the user wants to set a specific resolution. This setting has no effect when connecting to an Emerald transmitter.

Click on the Apply button to save the change.

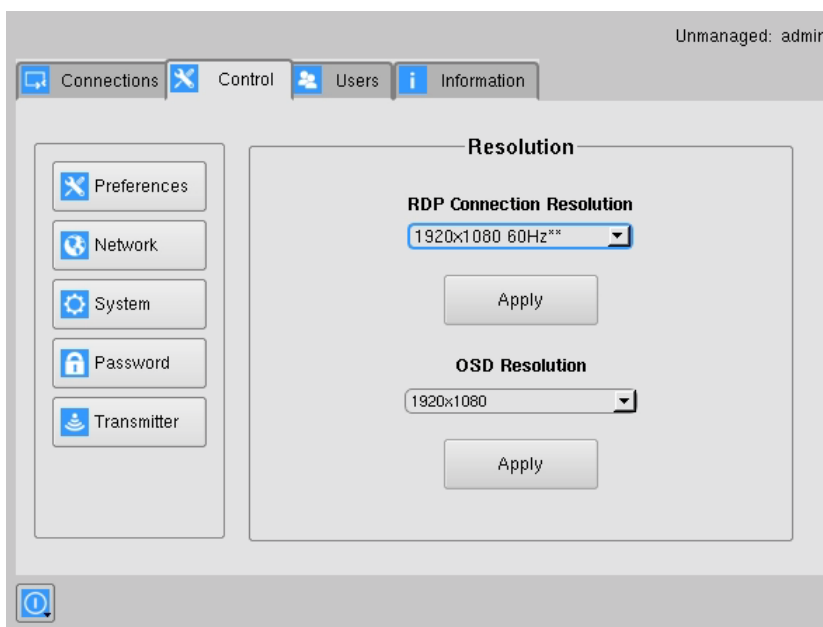

FIGURE 8-13. RESOLUTION SCREEN

Hot-Key

This button allows the Administrator to change the hot-key configuration. The hot-key is used with the o key to terminate the current connection and bring up the OSD. The hot-key with p key is used to switch to the previous connection without loading the OSD. Example: PrtScrn, O (default).

The hot-key can be used to initiate the favorites by using the hot-key, # (where # = 0-9 above the main keys and not NUMPAD). In order to support these features the Enable Functional Key needs to be checked/enabled first; otherwise the hot-key functions will be limited to accessing the OSD only.

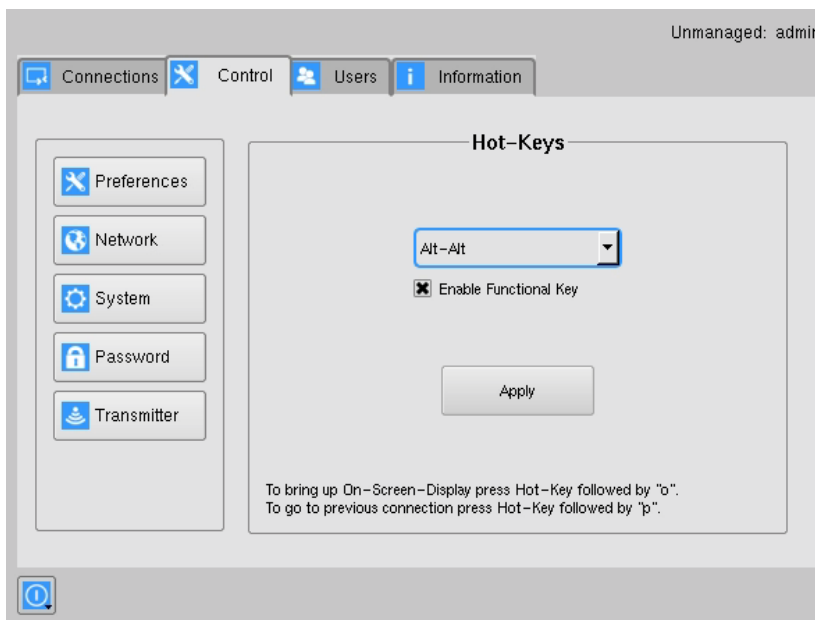

FIGURE 8-14. HOT-KEY DEFINITION

The default hot-key is Print-Screen (PrntScrn). The alternatives are shown in the table. Click the Apply button to confirm a hot-key change.

NOTE: Hot-keys are in sequence, so if your hot-key was set up for Print-Screen and you had Enable Functional Key enabled, you would press PrintScrn, release PrintScrn, Press O, release O, to get to the OSD.

TABLE 8-1. HOT-KEY OPTIONS

HOTKEY OPTION	NOTES
Print Screen	Default
Alt - Alt	
Ctrl - Ctrl	
Shift - Shift	
Mouse Left + Right	

TABLE 8-2. HOT-KEYS (ENABLE FUNCTIONAL KEY <RED>DISABLED</RED>)

SEQUENCE	ACTION
Hot-key only	Nothing
Hot-key, 0	The receiver will close the current connection and bring up the OSD.
Hot-key, P	Connect to the previous target (TIP: This hot-key is good for toggling between two different systems).
Hot-key, # (# = 0-9)	The receiver will connect to the Favorite assigned to the number.

The Enable Functional Key tick-box is used to disable the use of the function keys after the hot-key. So only the Hot-Key is required to bring up the OSD. The Enable Functional Key is enabled by default. If using Favorites, the Enable Functional Key must be enabled.

CHAPTER 8: OSD FUNCTIONS

Timer Settings

There are two timer settings available to users as shown in Figure 8-12. By default, they are turned OFF. If you wish to turn them ON, you have to select the desired timer, set the time you wish, and click on the Apply button. The two timer settings are:

1. OSD Inactivity Timer – This sets a limit on how long a user can be logged on to the OSD without any keyboard or mouse activity. Once the user reaches the inactivity timer, he/she will be logged out of the OSD. The timer value can be set to a number from 2 to 60 minutes.
2. Connection Inactivity Timer – This sets a limit on how long a user can be connected to a source, such as a virtual machine or transmitter, without any keyboard or mouse activity. Once the session reaches the inactivity timer, he/she will be logged out of their connection and return to the OSD. The timer value can be set to a number from 2 to 60 minutes.

NOTE: Inactivity occurs when the mouse or keyboard is not pressed or moved for a set period of time. The OSD Inactivity Timer and Connection Inactivity Timer can be used together to disconnect a session and log out of the user session.

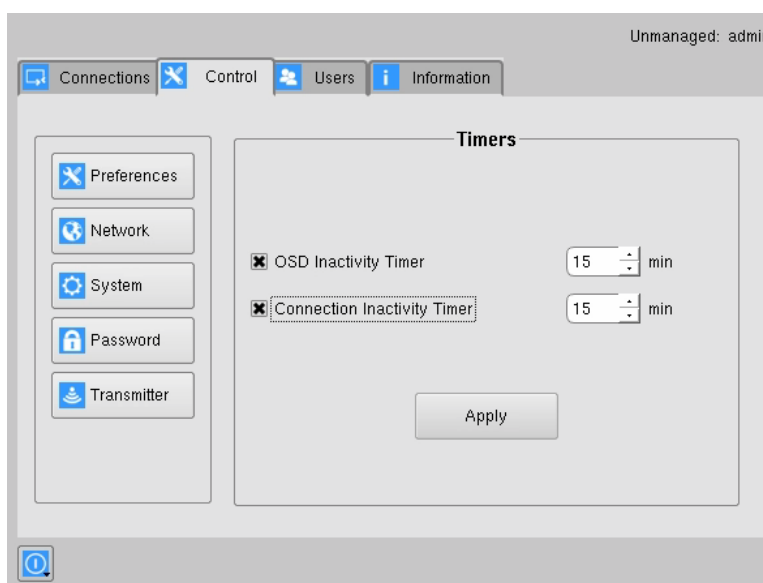

FIGURE 8-15. TIMER SETTINGS

NOTE: The Timers page on the receiver will show additional Local and Global radio buttons when the receiver is managed. Using Local will use the unique receiver settings instead of the global Boxilla settings. Using Global will use the settings defined in Boxilla.

CHAPTER 8: OSD FUNCTIONS

Connection Label Settings

The connection label can be enabled to help the user identify what connection is currently being used. This feature can only be enabled per receiver station by a power user or an Administrator user. By default, the feature is OFF, and the user can enable it and set the label to stay for 5 seconds after a connection or stay on screen permanently.

Note: This feature is available on all Emerald® receivers with the exception of the EMD2002SE.

The Connection Label is enabled through the Control Tab. The Control Tab's Preferences options are shown in Figure 8-16.

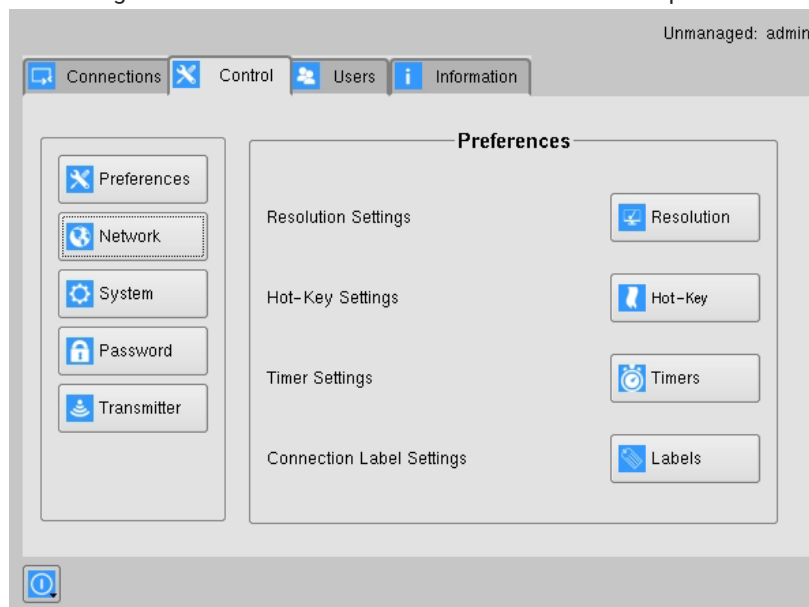

FIGURE 8-16. CONNECTION LABEL SETTINGS OPTION IN PREFERENCES SECTION

By using their hot-key and pressing L, the user can toggle the label ON or OFF. In Figure 8-17, the Connection Label is enabled.

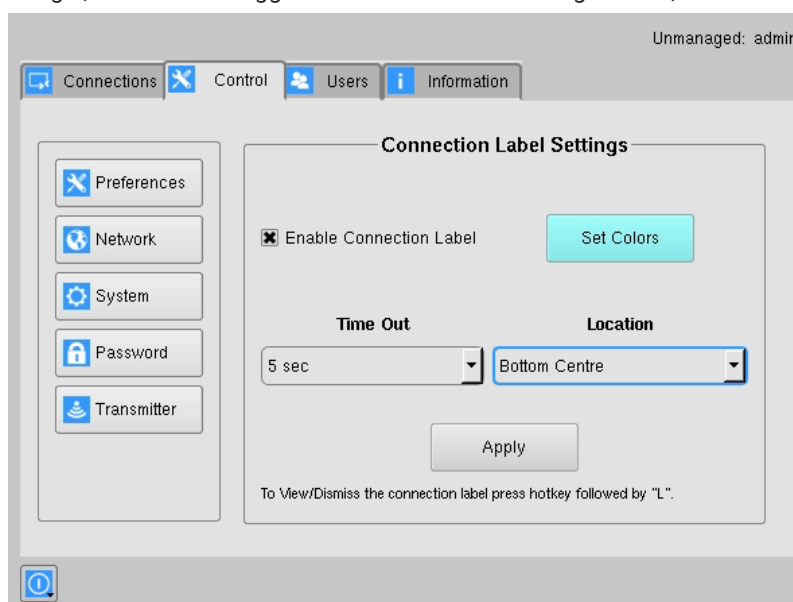

FIGURE 8-17. CONNECTION LABEL OPTION ENABLED

CHAPTER 8: OSD FUNCTIONS

The user can select to always display the connect label or to display it for 5 seconds. In Figure 8-18, a 5-second time out is selected.

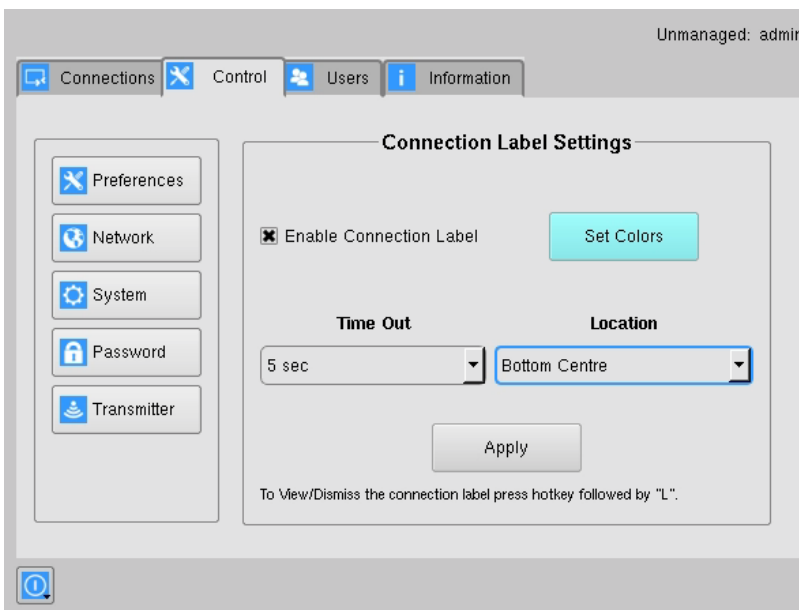

FIGURE 8-18. CONNECTION LABEL TIME OUT OPTIONS

The user can also select where the label will appear on the screen. In Figure 8-19, Bottom Centre is selected for the location.

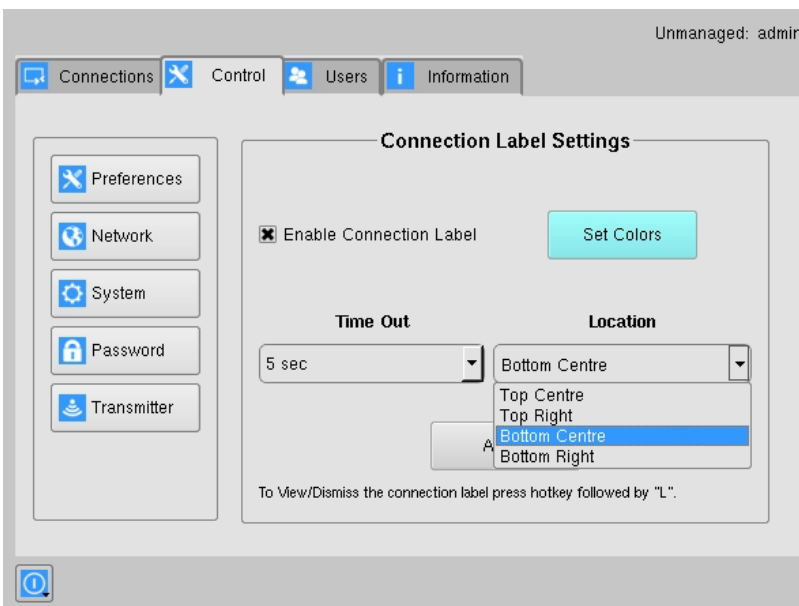

FIGURE 8-19. CONNECTION LABEL LOCATION OPTIONS

Figure 8-20 shows the connection label located in the bottom center of the screen, based upon the location selected in Figure 8-19.



FIGURE 8-20. CONNECTION LABEL SHOWN IN BOTTOM CENTER OF SCREEN

CHAPTER 8: OSD FUNCTIONS

8.6.2 NETWORK

The network screen shown in Figure 8-18 allows an Administrator to change the settings for the Emerald® receiver. The default network setting for the receiver is a static IP address of 192.168.1.21. It has a network mask of 255.255.255.0 and a Gateway 192.168.1.1. If DHCP is selected, the receiver gets its IP address from the DHCP server. Click on the Apply button to confirm any changes to network settings.

NOTE: We strongly recommend using Static IP addresses on the receivers. Also, only IPv4 addressing is supported in the current firmware version.

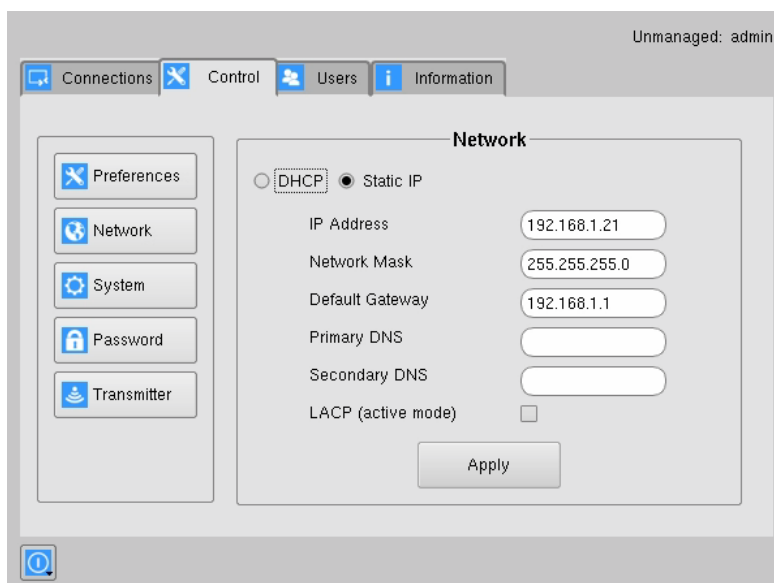

FIGURE 8-21. NETWORK SETTINGS

CHAPTER 8: OSD FUNCTIONS

8.6.3 SYSTEM

The System screen shown in Figure 8-22 allows an Administrator to upgrade the firmware in the Emerald® receiver, reset it to factory defaults, import/export the configuration to an external USB drive, and compile/export system diagnostic information.

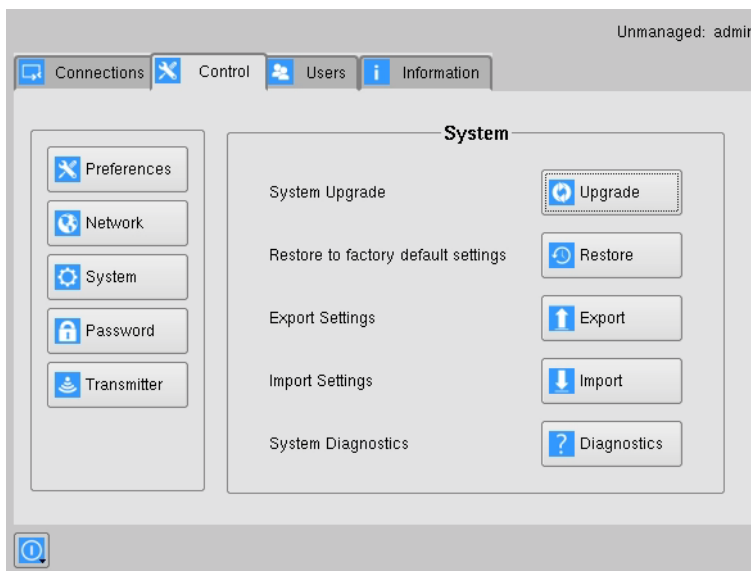

FIGURE 8-22. SYSTEM SCREEN

System Upgrade

The Emerald receiver can be upgraded using a FAT32-formatted USB flash drive. Simply take the firmware file and place it in the root directory of the flash drive. When you click the Upgrade button, the valid upgrade files on the USB drive are displayed. A valid file has the extension .clu – an example is shown in Figure 8-23. NOTE: There can only be one USB key/flash drive inserted in the receiver, and that key must contain the upgrade files. If the user has two keys inserted, and the second key has the upgrade files, the system will not locate the required files.

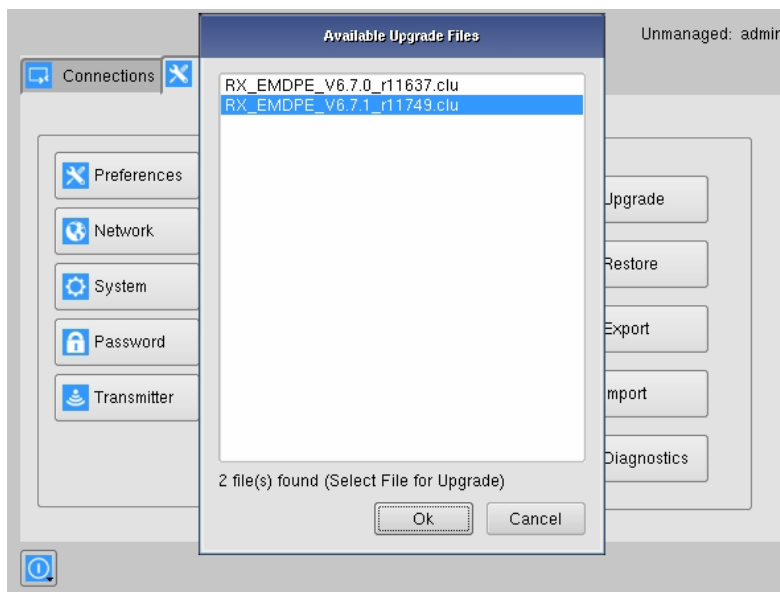

FIGURE 8-22. UPGRADE FILES

CHAPTER 8: OSD FUNCTIONS

If there is only one upgrade file on the flash drive, you will be not be presented with a prompt confirming the firmware since there is only one choice.

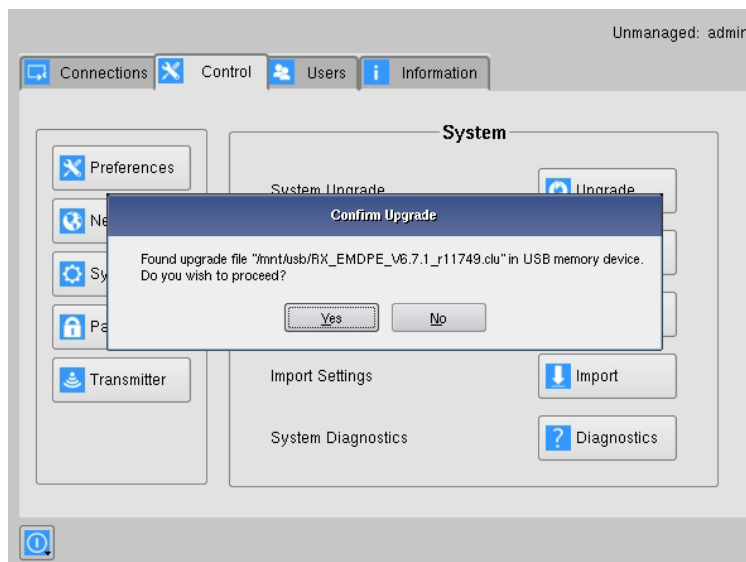

FIGURE 8-24. CONFIRMATION SCREEN

Once the Administrator has selected the file and confirmed the upgrade by clicking on the Yes button, the system checks that the selected file has no errors before upgrading the Emerald® receiver. The configuration of the unit is preserved through the upgrade.

When upgrading unmanaged Emerald devices from versions older than 6.x, the upgrade process requires multiple step up upgrades to get to the latest version. If using Boxilla® to perform the upgrades, the process can usually be done in one step.

NOTE: Always update the transmitter first before the receiver. Failure to upgrade the transmitter first can result in problems, including not being able to re-establish the connection in rare cases. The receiver cannot be downgraded. For example, once you upgrade to 6.2 on SE receivers, you can no longer downgrade to an earlier version.

Restore Factory Defaults

The Administrator can click the Restore button to reset the receiver back to factory defaults.

System Diagnostics

The diagnostics provides information for Black Box to debug customer encountered issues. When this button is clicked, the user is asked to save the diagnostics onto a memory stick in the receiver unit. Send this file to Black Box for analysis.

There is a similar diagnostic that can be run on a transmitter. Depending on the firmware version of the transmitter and receiver, the Diagnostics button may not be available if the device is managed by Boxilla. To get the logs from a managed system, go to the Boxilla dashboard under Devices --> Manage and click the ellipsis (...) next to the device. Then click on Retrieve Logs and follow the on-screen instructions.

TIP: When issues occur, compile and diagnostics as soon as possible and report the problem to Black Box so we can investigate. The longer you wait to collect the logs, the higher the risk is that they will be overwritten. Normal logs can be overwritten after 3-4 days of operation.

The logs are encrypted for your protection so that nobody can collect any system data if the log file was obtained by an unauthorized person. Only Black Box specialists can decrypt and review the log files.

Password

When clicked, the Password button allows the current user's password to be changed. This button is only visible to Administrators.

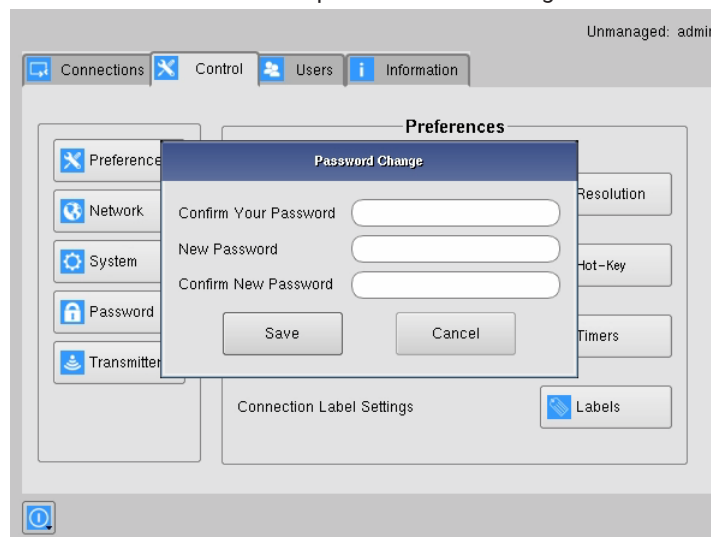

FIGURE 8-25. PASSWORD CHANGE

Transmitter Button

The Transmitter button on the Control Tab allows Administrators to change the configuration of an Emerald® transmitter. This button is only visible to Administrators.

The following options are available when the Transmitter button has been activated:

1. Transmitter Information
2. Transmitter Firmware Upgrade
3. Transmitter restore factory defaults
4. Transmitter reboot
5. Network Settings
6. Discover Transmitter IP Address
7. Transmitter Preferences
8. Transmitter Diagnostics

CHAPTER 8: OSD FUNCTIONS

Configuring a Transmitter

To configure a transmitter, the IP address must be defined for the target transmitter. When there is no active IP address defined, the Transmitter Setting window has all the buttons grayed out except for the Apply and Discover buttons.

Enter the IP address for the transmitter into the field at the top of window and click on the Apply button to activate. If a valid IP address is entered, the Transmitter Settings window makes all the options available for the Administrator shown in Figure 8-23.

Alternatively the Discover button can be used to find the IP address of a transmitter. First click on the Discover button and follow the instructions. Basically, once in discovery mode, the receiver (or Boxilla® Manager) can capture the IP address from a transmitter once it has been power-cycled.

NOTE: The default network setting for the transmitter is a static IP address of 192.168.1.22. It has a network mask of 255.255.255.0 and a Gateway 192.168.1.1.

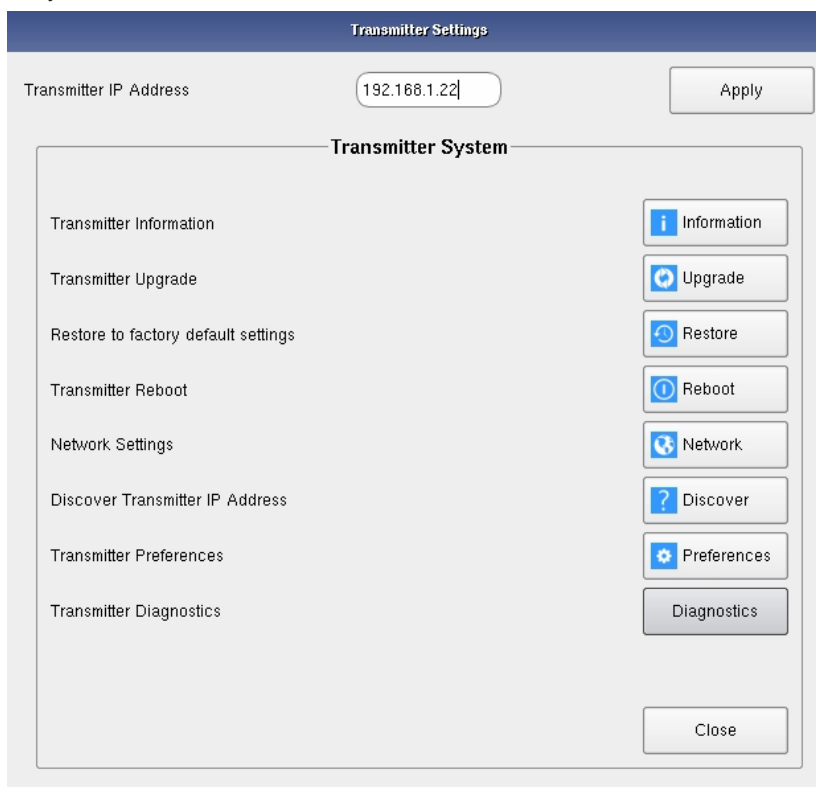

FIGURE 8-26. TRANSMITTER SETTINGS CONFIGURATION WINDOW - ACTIVE IP ADDRESS

CHAPTER 8: OSD FUNCTIONS

If the IP address of the receiver and transmitter are not on the same subnet, a router is required to allow them to communicate. This is true even when the receiver discovers the transmitter's IP address. One way to avoid this is to change the receiver address to be on the same subnet as the transmitter, make the required configuration changes to the transmitter, and then change the receiver back to its required IP address.

Transmitter Information

The Information button provides transmitter related information, such as device model, serial number, MAC address, and current firmware version, to the Administrator.

If the active IP address is not the address of a valid Emerald® transmitter or this address is unreachable, an error message is returned.

Transmitter Upgrade

The Administrator can click on the Upgrade button to change the firmware on a transmitter. The upgrade file is selected from the set of files on an attached USB drive. These files will have the extension .clu . The selected file is checked to be a valid transmitter upgrade file before starting the upgrade. The OSD provides a series of screens to walk the user through the process.

The upgrade can take a few minutes to complete and the power to the transmitter, and the receiver must not be disconnected during the upgrade. During the upgrade process, the transmitter may reboot.

If the active IP address is not the address of a valid Emerald transmitter or this address is unreachable, an error message is returned.

Restore to Factory Default Settings

The Administrator can click the Restore button to reset the transmitter back to factory defaults. If the active IP address is not the address of a valid Emerald transmitter or this address is unreachable, an error message is returned. Depending upon the firmware version and if the device is managed, this button may not be available on the receiver menu. In managed systems, access this option through the Boxilla dashboard.

Transmitter Reboot

The Administrator can click on the Reboot button to power-cycle the transmitter. If the active IP address is not the address of a valid Emerald transmitter or this address is unreachable, an error message is returned.

Network Settings

The Administrator can click the Network Settings button to edit the Transmitter Network Settings.

To change the IP address settings for a transmitter, the Administrator can enter the new IP address, subnet mask, and gateway, and then click on the Apply button.

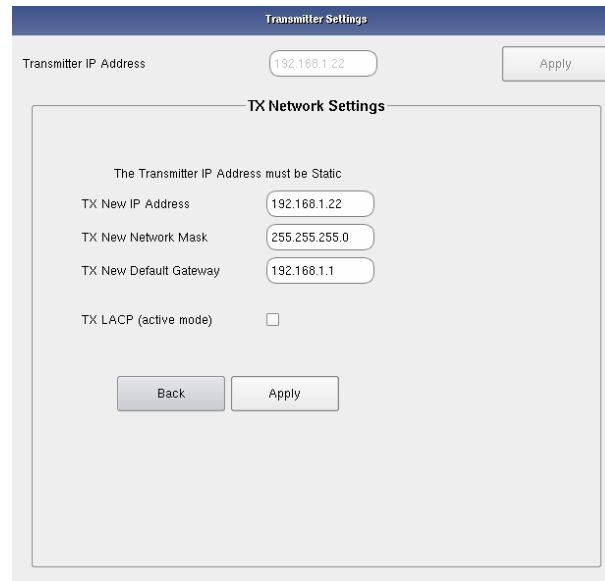

FIGURE 8-27. TRANSMITTER NETWORK SETTINGS WINDOW

If the new IP address for the Emerald® transmitter is on a different subnet than the receiver, the receiver or Manager will not be able to communicate with it without going through a router. This is the case even on a point-to-point link between devices.

If the entered IP address is not the address of a valid Emerald transmitter or this address is unreachable, an error message is returned.

Discover Transmitter IP Address

This requires the transmitter to be connected to the receiver on a point-to-point link or be the only transmitter on the attached network. In this case, the Administrator can click on the Discover button and follow the wizard to discover the IP address of the attached transmitter. This is required in the case when an Administrator does not know the transmitter's IP address.

CHAPTER 8: OSD FUNCTIONS

Transmitter Preferences

The Administrator can use the Transmitter Preference options to display the EDID stored on the KVM equipment and to change video quality settings, video optimization (for single-head systems only), and HID configuration. When the Transmitter Preferences button is clicked, the window shown in Figure 8-28 appears.

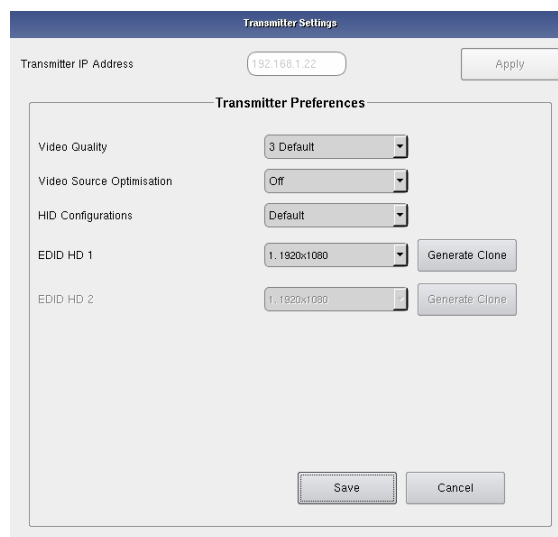

FIGURE 8-28. TRANSMITTER PREFERENCES

Transmitter Diagnostics

The transmitter provides diagnostics information for Black Box to debug customer encountered issues. When this button is clicked the user is asked to save the diagnostics onto a memory stick in the receiver unit. Send this file to Black Box for analysis. If the transmitter is in a system managed by Boxilla, the log files can be retrieved through the Boxilla dashboard under Devices --> Manage.

Transmitter Video Quality Settings

The transmitter uses a progressive compression algorithm with 5 stages to reduce the bandwidth and increase the frame rate while sacrificing quality. At stage 5, which uses the best compression, you may achieve a higher frame rate and lower bandwidth, but the video output may show blocks of pixilation or screen artifacts as those parts of the screen are not being repainted because they didn't update. At the highest setting of stage 1, which is best quality, you will not see these screen artifacts as much, but you will be using a higher bandwidth with reduced frames potentially based upon your application. Frames are not always reduced; it just depends on the source and network.

Options:

1. Best Quality – lossless compression, pixel-perfect mode of operation. Generally needs dedicated network to ensure no frame loss.
2. Visually Lossless Compression – high-quality, visual image. Some compression on stream to reduce bandwidth to allow operation on standard corporate networks. Compression does not vary based on available network bandwidth, so may lead to some dropped frames during network congestion periods.
3. Optimized Quality (default) – system tuned to maintain visually lossless compression while increasing compression level during periods of network congestion to reduce frame loss. This balances visual quality with frame loss in periods of congestion, such as attempts to reduce/eliminate frame loss.

CHAPTER 8: OSD FUNCTIONS

4. Optimized Bandwidth – system tuned to maintain visually lossless compression but increased levels of compression level during periods of network congestion to reduce frame loss. Optimized towards lower bandwidth during congestion periods compared to level 3.
5. Lowest Bandwidth – high level of compression to minimize average network bandwidth. No dynamic change to compression levels – always seeking to reduce bandwidth.

If the active IP address is not the address of a valid Emerald® transmitter or this address is unreachable, an error message is returned.

Video Source Optimization (Applies to Single-Head Transmitters Only)

This is a progressive algorithm which helps to reduce unwanted noise coming from a GPU or video converters. The transmitter can be configured to handle different applications by changing the way it handles the video signal if it natively has embedded noise, such as from a VGA to DVI converter). You can choose to use DVI optimized, VGA high performance, VGA optimized, or VGA low bandwidth settings. You may change these options to get the best performance out of the transmitter. When the option is OFF, no dithering/noise techniques are enabled. DVI optimized, which is the least aggressive technique, uses a digital anti-dithering/anti-noise technique to reduce the extra noise which will allow the transmitter to operate at a normal pace and have better network performance. High performance is best used when there is an analog-to-digital video converter between the GPU and transmitter. It uses a low level technique. VGA optimized is best used when there is an analog-to-digital video converter between the GPU and transmitter. It uses a medium level technique. VGA low bandwidth is best used when there is an analog-to-digital video converter between the GPU and transmitter. It uses a high level technique. This would be considered the most aggressive technique to handle video dithering/noise.

NOTE: VGA Optimization is only supported on single-head transmitters; the dual-head transmitters and Emerald 4K do not support it. The dual-head Emerald SE/PE may not be the best option for sources that use Video Dithering technology.

HID Configurations

This setting applies to all transmitters. It changes the USB communication between the Emerald transmitter and the target computer/device. Default will pass all available signals including audio, USB-R, USB HID as well as keyboard and mouse connections. Basic will pass USB HID only. It provides compatibility with DKM, DCX and older servers that require a keyboard and mouse HID only. Basic HID is also required to access any computer's BIOS menus. MAC supports MacOS® users. Absolute will be used with Windows®/Linux when RemoteApp or Freedom are being used in the setup. For normal usage, where mouse is directly connected to the receiver, then the Default or Basic options should be used. Absolute MAC will be used with MacOS® when used with Remote App or Freedom. Absolute Basic allows you to set the mouse to absolute while disabling the emulated audio device. This setting will typically be used where you wish to use the remote app and integrate the Emerald system with DKM and other systems that may be disrupted with audio enabled.

Absolute, Absolute MAC, and Absolute Basic can be used when the RemoteApp, DESKVUE, or Freedom II are used to enable the mouse.



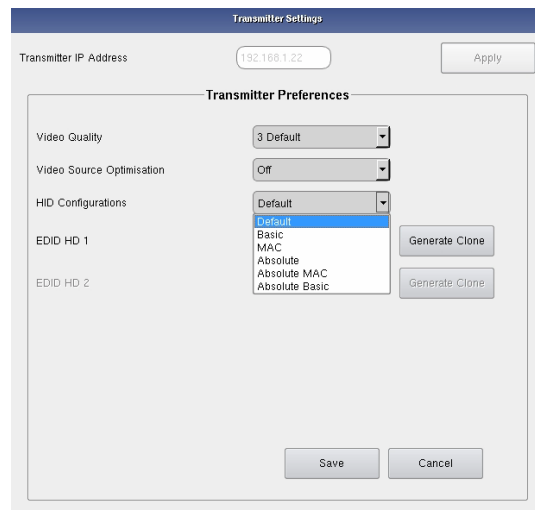

FIGURE 8-29. HID CONFIGURATION OSD OPTIONS

EDID Settings

The transmitter can support native EDID options such as 1920x1080, 1920x1200, 1680x1050, 1280x1024, 1024x768, or you can choose to use the remote monitor EDID by clicking on the Generate Clone button, which will copy the desired video resolution to display at the receiver. The new EDID option will be added to the drop-down list, and it must be selected and saved before it is applied. This information is then shared with the computer's GPU so it sends the correct resolution and refresh rate. The Clone EDID 2 option applies to all dual-head transmitters and allows the Administrator to choose the desired video resolution to display at the receiver's second output.

NOTE: The computer may need to be restarted in order for the settings to work. If you find that changing the EDID settings makes the remote monitor blank out, you may need to select a different option to make it work. Once the Generate Clone EDID process is finished, it needs to be selected in the drop-down list and is not automatically applied until then.

8.7 MANAGING USERS

Users are defined in the Emerald® system to provide rights to manage the system, rights to connect to different target devices and set parameters for connections. There are three types of users that can be created in an Emerald system.

1. Administrator – users of the class have full rights to configure the system, such as creating/modifying/deleting new users and connections, and changing network settings.
2. Power User – users of this class can modify resolutions for connections to virtual desktops and change his/her local password.
3. Standard Users – users of this class can only select from a list of pre-defined connections to access and view system information. They cannot change any configuration settings.

The Emerald receiver has one default user – admin, which is a member of the Administrator group. This user is defined by default and cannot be deleted. An Emerald receiver can have a maximum of 32 users defined.

To manage users, an Administrator selects the Users tab. This tab is only visible to Administrator class users.

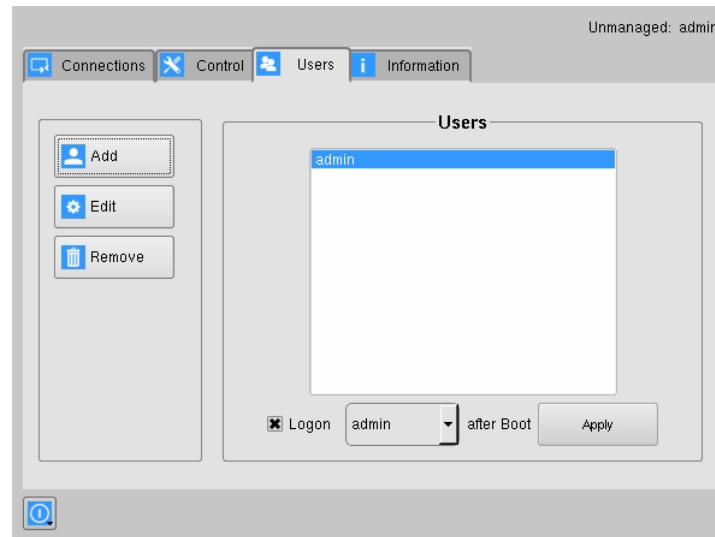

FIGURE 8-30. USER SCREENS

8.7.1 ADD A USER

To add a user, click on the Add button. This causes the New-User window to be displayed.

CHAPTER 8: OSD FUNCTIONS

8.7.2 AUTO LOG ON

When the Log-on button is selected and a user is chosen, this user will be automatically logged on after power is applied to unit or after a reboot.

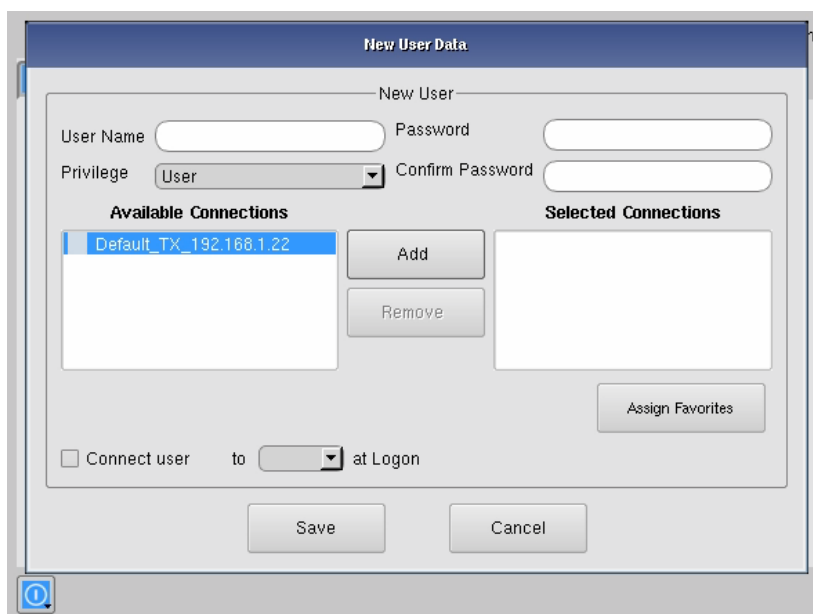

FIGURE 8-31. NEW USER WINDOW

When adding a new user, the following fields are used to define the user:

- **User Name:** This is a unique name that uses 1–32 characters. The username can be any valid username for a Microsoft O/S. This means the username MAY NOT contain “/ \ [] ; | = , + * ? < > `”.
- **Password:** This field can be a minimum of 0 characters (i.e. blank) and a maximum of 32 characters. The password can be any valid password for a Microsoft O/S. The user password MAY contain the following special characters , ~ : ! @ # \$ % ^ & ' { } which means the password cannot contain “/ \ [] ; | = , + * ? < > `”.
- **Confirm Password:** This field must match the Password field. If there is a mismatch, a message is presented to the user in a pop-up screen.
- **Privilege:** This field, which is a drop-down list, defines the type of user the new user will be—Administrator or User.
- **Selected Connections:** The new user must be allocated connections that he/she can access. These are selected from the Available Connections window by the user selecting a set of connections (click on the connection in the Available Connection window and then click on the “Add” button). This causes the selected connections to be “added” to a user’s selected connection window.
- **Connect to at login:** This tick box defines whether the Emerald® receiver or Manager attempts to connect immediately to the selected connection after a logon by the user. This automatic connection only occurs after a logon. If a user exits the connection, the connection tab is displayed to the user for selection of a connection. This Connect to at Login is only saved when the Save button is clicked. If not clicked and another tab is selected, the changes are ignored. If not ticked, no automatic connection is made on log-in.

Once the new user fields have been filled out, the Save button must be clicked to create the new user. Clicking on the Save button causes the validation of the new username, checking that it is unique and that the two password entries match. If this validation fails, a pop-up window displays the reason for the failure – and the new user is not created. After dismissing the pop-up window, the user can fix the error and click on the Save button again.

Click on the Cancel button if the new user should not be created.

8.7.3 EDIT A USER

To edit a user, click on the Edit button. This causes the Edit User Data window (shown in Figure 8-32) to be displayed.

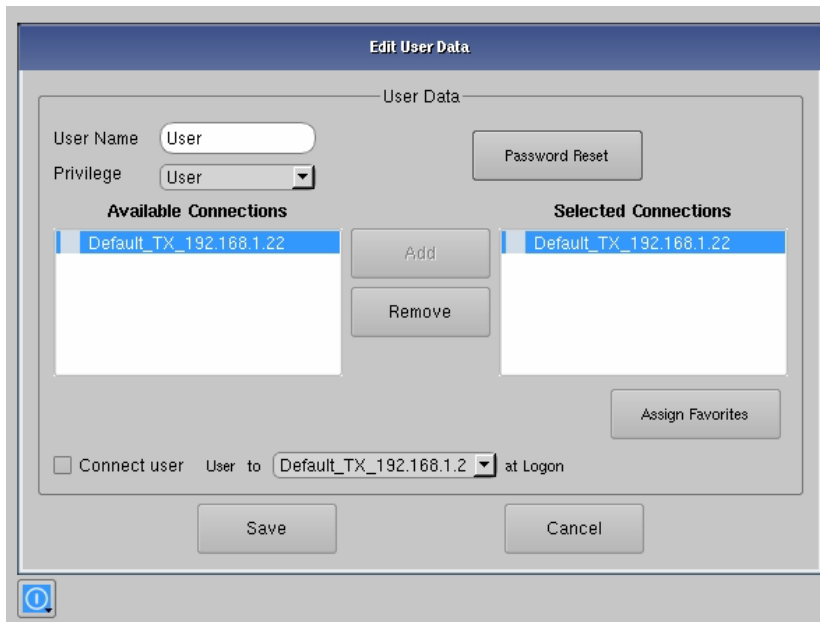

FIGURE 8-32. EDIT USER WINDOW

This window allows the user privilege type, the permitted connections available, the password, and the auto-connect option to be changed.

The default admin account gets access to all connections; this list cannot be modified. Other Administrator-type users can have their connection list modified.

Once the changes have been made for a user, they only become active once the Save button has been clicked. The changes can be abandoned by clicking on the Cancel button.

8.7.4 REMOVE A USER

To remove a user, highlight the user's name and then click on the Remove button.

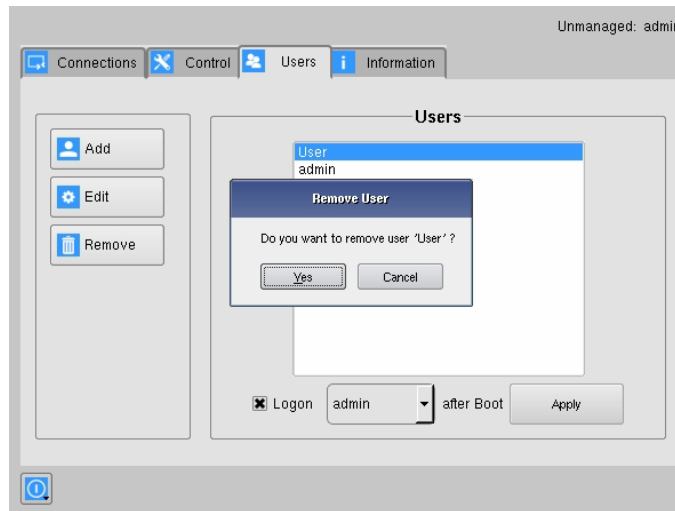

FIGURE 8-33. REMOVE USER

When the Remove button is clicked, a pop-up window is displayed to prompt confirmation that this user is to be deleted. Click on the Yes button to remove the user. Clicking on the No button causes this action to be aborted, and the user is not removed.

NOTE: There must always be a user of the name admin in the Emerald® system so the system can always be administrated. When attempting to remove the user, the system checks if the username is admin before it will allow the user to be removed.

CHAPTER 8: OSD FUNCTIONS

8.8 LACP

NOTE: LACP requires the Boxilla® manager.

To find out more information about the status of the Emerald® network interface(s), the Boxilla administrator can navigate to Devices>>Settings, and click on the LACP info panel. This will give a summary of the status of each Emerald NIC interface. Some of the information that can be found on this page is:

Active: Is the Ethernet port currently active

- ♦ Status: If the link is up or down
- ♦ Link Speed: The negotiated speed of the NIC
- ♦ Media: The type of network cable being used
- ♦ LACP: If the data is using LACP traffic

The Emerald LACP features do not support aggregation of the network ports to support two active ports. Only one network port is active at the same time, and both network ports will use the same IP settings. This protocol enables a network device to automatically bundle links by sending LACP packets to a directly-connected device that also uses LACP.



APPENDIX A: EMERALD VIDEO RESOLUTIONS SUPPORTED

Emerald® 2K supports the resolutions listed below:

- ◆ 640 x 480 @ 60 Hz
- ◆ 640 x 480 @ 75 Hz
- ◆ 800 x 600 @ 60 Hz
- ◆ 800 x 600 @ 70 Hz
- ◆ 800 x 600 @ 72 Hz
- ◆ 800 x 600 @ 75 Hz
- ◆ 800 x 600 @ 85 Hz
- ◆ 1024 x 768 @ 60 Hz
- ◆ 1024 x 768 @ 75 Hz
- ◆ 1024 x 768 @ 85 Hz
- ◆ 1280 x 800 @ 60 Hz
- ◆ 1280 x 960 @ 60 Hz
- ◆ 1280 x 960 @ 85 Hz
- ◆ 1280 x 1024 @ 60 Hz
- ◆ 1280 x 1024 @ 75 Hz
- ◆ 1280 x 1024 @ 85 Hz
- ◆ 1366 x 768 @ 60 Hz
- ◆ 1400 x 1050 @ 60 Hz
- ◆ 1440 x 900 @ 60 Hz
- ◆ 1600 x 900 @ 60 Hz
- ◆ 1680 x 1050 @ 60 Hz
- ◆ 1600 x 1200 @ 60 Hz
- ◆ 1680 x 1050 @ 60 Hz
- ◆ 1280 x 720 @ 60 Hz
- ◆ 1920 x 1080 @ 60Hz
- ◆ 1920 x 1200 @ 60 Hz

Emerald 4K supports the resolutions above and the resolutions listed below:

- ◆ 3840 x 2160 @ 30 Hz
- ◆ 4096 x 2160 @ 60 Hz
- ◆ 3440 x 1440 @ 60 Hz

Emerald also will pass all the above resolutions at refresh frequencies from 15 Hz to 60 Hz. Those with non-defined VESA resolutions will be displayed at 60 Hz even if the incoming resolution is not 60 Hz.

APPENDIX B: EMERALD 4K MODELS

B.1 AVAILABLE MODELS

The following models are available:

- EMD4000T 4K DisplayPort™, USB, and Audio Transmitter, 10Gbps
- EMD4000R 4K DisplayPort, USB, and Audio Receiver, 10Gbps

B.2 COMPATIBLE NETWORK SWITCHES

The following network switches have been validated and are recommended when using Emerald® 4K transmitters and receivers:

COMPATIBLE NETWORK SWITCHES	
PART NUMBER	DESCRIPTION
EMS10G12	12-Port, 10Gbps SFP+ (unpopulated) Network Switch
EMS10G28	28-Port, 10Gbps SFP+ (unpopulated) Network Switch
EMS100G32-R2	32-Port, 100Gbps (unpopulated) Network Switch

B.3 COMPARISON CHART

SPECIFICATION COMPARISON CHART: TRANSMITTERS AND RECEIVERS							
	NUMBER OF VIDEO HEADS	USB PORTS	NETWORK	SERIAL	AUDIO	SFP	RESOLUTION
RECEIVERS							
4K RECEIVER (EMD4000R)	(1) DISPLAYPORT	(4) USB TYPE A	(2) SFP+	(1) DB9	(2) 3.5-MM	(2)	4096 x 2160
TRANSMITTERS							
4K TRANSMITTER (EMD4000T)	(1) DISPLAYPORT	(1) USB TYPE B	(2) SFP+	(1) DB9	(2) 3.5-MM	(2)	4096 x 2160

B.4 COMPATIBLE SFPS

The following SFP+ were verified to be fully operational with Emerald 4K transmitters and receivers (EMD4000T, EMD4000R):

COMPATIBLE SFPS	
PART NUMBER	DESCRIPTION
LSP421	SFP+ - 10-Gb, Extended Diagnostics, 850-nm Multimode Fiber, 300-m, LC
LSP422	SFP+, 10GBASE-R, 1310-nm single-mode, 10 km
LSP443	SFP+, 10GBASE-T, RJ-45
LSP441	SFP+ - 10-Gb, Extended Diagnostics, 850-nm Multimode Fiber, LC
LSP442	SFP+ - 10-Gb, Extended Diagnostics, 1310-nm Single-mode Fiber, LC

NOTE: When picking an SFP+ above, verify you get a matching SFP for proper communication (for example, one SFP is on the unit, and the other SFP is on the network switch).



APPENDIX B: EMERALD 4K MODELS

B.5 COMPATIBLE CABLES

The following Active Optical Cables and Direct Attach Cables are available for use with the Emerald 4K (EMD4000T, EMD4000R). They can be used instead of SFP+, and these are an all-in-one interconnect cable.

COMPATIBLE 10G ACTIVE OPTICAL CABLES FOR NETWORKING

PRODUCT CODE	LENGTH
SFP-10G-AOC1M-BB	1-m
SFP-10G-AOC2M-BB	2-m
SFP-10G-AOC3M-BB	3-m
SFP-10G-AOC5M-BB	5-m
SFP-10G-AOC7M-BB	7-m
SFP-10G-AOC10M-BB	10-m

COMPATIBLE 10G DIRECT ATTACH CABLES FOR NETWORKING

PRODUCT CODE	LENGTH
SFP-H10GB-CU50CM-BB	50-cm
SFP-H10GB-CU1M-BB	1-m
SFP-H10GB-CU1M5-BB	1.5-m
SFP-H10GB-CU2M-BB	2-m
SFP-H10GB-CU3M-BB	3-m
SFP-H10GB-CU5M-BB	5-m

APPENDIX C: NETWORK REQUIREMENTS AND PORT USAGE

Emerald® transmitters and receivers will require specific network requirements to ensure high-quality video and low latency. The technology can utilize unicast and multicast packets, so having a good, properly configured network backbone is required. Unicast is a protocol designed to send network packets from a single transmitter to a single receiver (about 200 Mbps for 2K video and about 10 Gbps of bandwidth for 4K video). Multicast is a protocol designed to send network packets from a single transmitter to more than 1 receiver, but the method of sending this data is extremely efficient.

In Unicast mode, every receiver will use up to around 200 Mbps for 2K video and around 10 Gbps for 4K video. This means that with four receivers, you are sending 200 Mbps for 2K x 4 = 800 Mbps, and 10 Gbps x 4 = 40 Gbps from the transmitter.

When using Emerald 4K devices (EMD4000T, EMD4000R) in Multicast mode, every receiver can get up to 10 Gbps of data. However, the transmitter will send the data once via Multicast, and the network switch will then determine who is part of the IGMP group and properly distribute that data to those selected receivers (or passing through network switches if using more than one network switch). This is more network switch intensive, but allows for a lot of multimedia data to be transposed across a network of a single switch or multiple switches.

Using Multicasting technology on a network switch that cannot handle it will result in the network switch taking in the 10 Gbps from a transmitter and broadcasting it out to every port whether that device wants the info or not; therefore, selecting the proper network switch that can support Multicasting is extremely important to avoid network saturation or bringing the network down. The network switch that isn't capable of handling this Multicasting traffic will typically begin to make every status LED on the switch blink in synchrony, indicating something is wrong.

Emerald 2K and Emerald 4K devices can be on the same network if designed properly. The Emerald 2K devices can connect to 1 Gbps network switches and have an uplink/LACP connection to a 10 Gbps network switch, which would interface with the Emerald 4K devices directly. When using the proper connection codecs, an Emerald 2K receiver can connect to a 4K Transmitter when the connection mode is set to Optimized.

C.1 RECOMMENDED NETWORK DESIGN

It is best practice to put transmitters on the same switch as the receivers who are accessing those most frequently to reduce overhead on the network switch trunks. Placing transmitters and receivers on different switches, however, is completely acceptable and it happens frequently; just validate that the switch uplink/LACP can handle all the bandwidth.

NOTE: Verify that you do not have any device using 192.168.1.1; otherwise Endpoint Discovery using Boxilla will not work.

C.2 MULTI-SUBNET SUPPORT

Emerald 2K and Emerald 4K are capable of going over multi-subnets and the internet if properly configured and if the service line is capable of handling the bandwidth. To go from one subnet to another, you will need to utilize a Layer 3 switch to accommodate the connection (or you may want to consider using VLANs to separate corporate network with KVM network). If going over the internet, you must assign an external IP address to an internal one, and then configure the device to use the internal IP, or configure port forwarding on the router. The router will know how to handle it if properly configured. VPNs are often used, but not all are supported. For Emerald 4K, it is not recommended to use over the internet/VPN due to the amount of bandwidth it can consume; these applications typically have dedicated lines that can support high-bandwidth connections.

C.3 4K MULTICAST SUPPORT

Emerald 4K will use Multicast IP traffic when at firmware version 1.4 or higher. If you connect more than one Emerald 4K transmitter to an unconfigured network, you will begin to have problems since all of the transmitters use the same default Multicast IP.

APPENDIX C: NETWORK REQUIREMENTS AND PORT USAGE

Since these all need to be unique, follow these steps:

Unmanaged Transmitters:

1. In the OSD of the Emerald® 4K Receiver, go to Control-->Transmitter, type in the transmitter's IP address, and press okay. After a few moments, if the transmitter is online, several buttons are now available to click on.
3. Click on the Network button and configure the Multicast IP address to 239.0.0.5 and larger (for example, 239.0.0.5 TX1, 239.0.0.6 TX2, 239.0.0.7 TX3) using port 8001. Also be sure your network switch IGMP range covers this IP.
4. Apply your settings and close.

Managed Transmitters:

1. Go to Boxilla under Devices-->Settings.

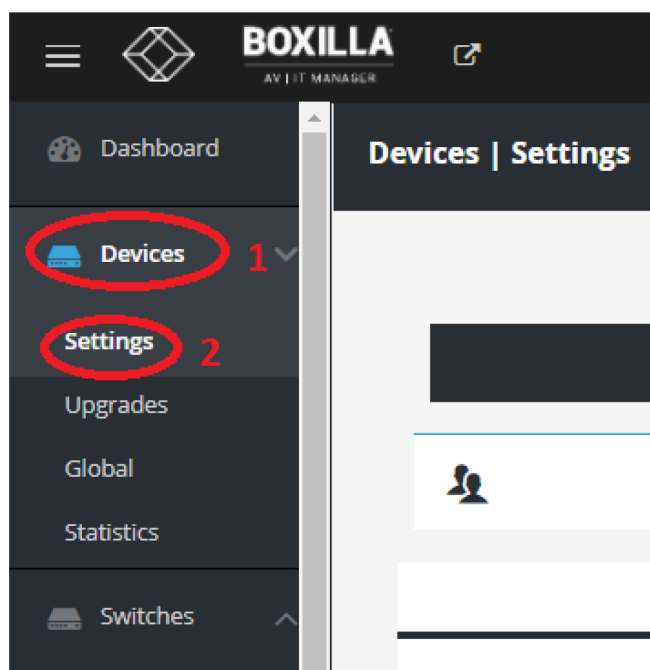

FIGURE C-1. SETTINGS SCREEN

APPENDIX C: NETWORK REQUIREMENTS AND PORT USAGE

2. Find the Emerald 4K transmitter, click on the ellipsis, and go to Edit Network.

EMD2000PE-T (A)	-	Unique	10.0.0.215	EMD2000PE-T	OnLine	Configured	Best Quality	Off	1920x1080	-	-	-	-	-
EMD4000T (A)	1	Unique	10.0.0.220	EMD4000T	OnLine	Configured	-	-	Default	-	-	-	-	-
EMD4000R (A)	-	Unique	10.0.0.221	EMD4000R	OnLine	Configured	-	-	-	-	-	-	-	-
EMD4000R (B)	-	Unique	10.0.0.222	EMD4000R	OnLine	Configured	-	-	-	-	-	-	-	-
EMD2000PE-R (A)	-	Unique	10.0.0.211	EMD2000PE-R	OnLine	Configured	-	-	-	-	-	-	-	-
EMD2000PE-R (A)	-	Unique	10.0.0.210	EMD2000PE-R	OnLine	Configured	-	-	-	-	-	-	-	-
DTX1000SA-R (A)	-	Unique	10.0.0.213	DTX1000SA-R	OnLine	Configured	-	-	-	-	-	-	-	-
EMD2002SE-R RX1	-	Unique	10.0.0.212	EMD2002SE-R	OnLine	Configured	-	-	-	-	-	-	-	-

FIGURE C-2. EDIT NETWORK OPTION

3. Verify that Multicast Master Port is set to 8001, and verify that each Emerald 4K transmitter's Multicast IP has a unique value starting at 239.0.0.2. Once done, press apply. Do this for every transmitter and verify that the Multicast IP is unique.

NOTE: On your network switch with IGMP Snooping is enabled for Multicasting Traffic, verify that your Multicasting IP scope is well within limits for the Emerald 4K transmitter range 239.0.0.x.

Model	EMD4000T
MAC	1C:37:BF:00:11:70
IP Address	<input type="text" value="10.0.0.220"/>
Gateway	<input type="text" value="10.0.0.1"/>
Netmask	<input type="text" value="255.255.0.0"/>
Primary DNS	<input type="text"/>
Secondary DNS	<input type="text"/>
Multicast IP	<input type="text" value="239.0.0.5"/>
Multicast Master Port	<input type="text" value="8001"/>
State	OnLine

FIGURE C-3. MULTICAST IP SETTING

APPENDIX C: NETWORK REQUIREMENTS AND PORT USAGE

C.4 TCP/UDP PORT USAGE

TCP/UDP PORT USAGE				
	APPLICATION	PORT	EMERALD 4K	EMERALD SE/PE/ZU
APPLIANCE	Appliance REST HTTP	TCP: 7778	Yes	Yes
	Appliance REST HTTPS	TCP: 8888	Yes	Yes
	Stats Gathering Internal Port	TCP: 9998 (internal use only; might show on scan)	Yes	Yes
	Communications	TCP: 22	Yes	Yes
	Manager Discovery (to Appliance): Multicast 224.0.1.249. Appliance Listens on UDP Port	UDP: 39150	Yes	Yes
	(4K Only) Default Slave Multicast IP Port (IP: 239.0.0.1)	UDP: 8000	Yes	No
	(4K only) Default Master Multicast IP Port (IP: 239.0.0.1)	UDP: 8001	Yes	No
	Audio (Private/Multi Unicast)	TCP: 9000	Yes (1.2 onwards)	Yes (5.0.x onwards)
	Video EMDSE & 4K	TCP: 16384	Yes	Yes (5.3.x onwards)
	Video, 2nd channel, (Paired only)	TCP: 16385	No	Yes (5.4.x only)
	Reserved – Future	TCP: 16387		
	Reserved – Future	TCP: 16388		
	Multicast 225.0.0.37 (Appliance – recovery)	UDP: 12345	Yes	Yes
	RDP VM & RDP Broker	TCP: 3389 (default)	Yes (Default)	Yes (Default)
	Horizon Client	TBD		
Transmitter Connections	TCP: 3389	Yes	Yes	
BOXILLA	Boxilla REST HTTPS	TCP: 443		
	Boxilla Smart Proxy HTTP	TCP: 8000 (Boxilla internal only)		
	Communications	TCP: 22		
	Discovery: Multicast 224.0.1.249 (Send)	UDP: 39150		

RemoteApp requires TCP/UDP Port 443, 3389, and 16384 to be open.

NOTE: Firewalls on the WAN may cause audio to fail due to a protocol issue that prevents it traversing some firewalls. The audio channel does not perform the SYN/SYNACK sequence which leads to some of these streams being blocked.

APPENDIX C: NETWORK REQUIREMENTS AND PORT USAGE

C.5 NETWORK SWITCH REQUIREMENTS

NETWORK SWITCH REQUIREMENTS		
WHEN REQUIRED	SWITCH SETTING	DESCRIPTION
4K ONLY	IGMP Capable	Must support IGMP V1, V2, or V3
4K ONLY	10 Gig Ports	Each port on the switch needs to support 10 G for best operation.
2K AND 4K	Backplane Support	If you have a 1Gbps 28-Port switch, the backplane should be capable of handling 28 Gbps or more. Some switches will have 28 ports but the backplane supports 24 Gbps or less. Be sure to calculate the bandwidth across the network to eliminate any bottlenecks.
4K ONLY	Switch CPU	The network switch should have a heavy duty CPU that can handle the constant processing on the IGMP groups.
ONLY WHEN EXPERIENCING VIDEO ISSUES	Check Jumbo Frames MTU	Jumbo frames or MTU should be above 9000 bytes. However, using a smaller setting may not cause many issues unless you begin seeing horizontal screen tearing or poor video quality. If MTU is set too small, you will notice issues.
NOT REQUIRED BUT RECOMMENDED FOR 2K AND 4K	VLAN Configuration	It is advised to setup a VLAN for the Emerald® 2K and Emerald 4K system to keep it separate from other devices on the network. This is not required; it is a suggestion to keep things easy to manage. If using the EMS10G28, you are REQUIRED to make a secondary VLAN since you cannot configure Multicasting on the default VLAN1.
UPLINKS (2K AND 4K)	Switch Trunks / LACP	Review switch trunks and LACP configuration to verify that the link can handle the required bandwidth between switches.



APPENDIX D. CONFIGURING WINDOWS 10 VIRTUAL MACHINES

A few properties must be configured on a target Windows® virtual machine for Emerald® to connect with it.

On the Windows virtual machine click on the Start button and launch a command window. Then launch group policy editor – gpedit.msc.

Start >> Run >> “cmd” >> “gpedit.msc”

Once the Local group Policy editor is open follow this path:

Computer Configuration >> Administrative Templates >> Windows Components >> Remote Desktop Services >> Remote Desktop Session Host >> Remote Session Environment

Ensure the following three policies are set as follows:

1. Optimize visual experience when using RemoteFX.

- ◆ For this policy set both the Screen Capture Rate and Screen Image Quality to Highest.

2. Configure RemoteFX.

- ◆ Set this policy to Enabled.

3. Limit maximum color depth.

- ◆ Set this policy to Client Compatible.

Once the above policies have been applied, reboot the virtual machine. It is now enabled for Emerald connections.

There are different settings to optimize the performance of Emerald with different Windows operating systems. These are defined in the application note – “Emerald Group Policies for Optimal Performance for Windows Targets.”

It is not possible to connect to a transmitter from a computer/laptop running RDP. A receiver is always required.

APPENDIX E. EMERALD NETWORK PROTOCOLS OVERVIEW

Emerald® uses standard IP protocols for communication between receivers and transmitters. Port 3389 is used for unicast communications.

For management purposes some other ports are used. The Black Box discovery protocol used UDP Multicast Group 224.0.1.249 (port 39150). This is sent by the Boxilla® Manager to discover Emerald devices in the network. The router must allow UDP Multicast forwarding to allow devices on subnet different to where Manager is located to be discovered.

Emerald devices respond to the discovery multicast by sending a UDP unicast back to Manager IP address on the same port (Port 39150).

Once an Emerald device is part of the managed domain, the Manager periodically audits the device to determine information such as if the device on-line, who is logged into devices, device statistics, etc. These audit requests and responses are unicast UDP to specific IP addresses (responses are sent back to Manager's IP address) on port 39150.

On power-up, a transmitter sends out a "here I am" multicast message on multicast group 225.0.0.37 on port 12345.

As part of management configuration, the Manager may communicate to a specific device on port 22 (TCP unicast communications).

Emerald can operate across multiple VLANs or subnets. Basic IP networking rules need to be followed; there should be a router in the network to enable the various devices on different subnets to communicate with each other.

To allow Black Box's Emerald discovery protocol to operate, Multicast routing should be enabled. Black Box's Emerald discovery protocol is not required for Emerald systems to operate, but it is recommended to enable an Emerald Manager to search for devices across the network. If the Emerald SE discovery protocol is not enabled, such as when the router does not have multicast routing enabled, the Administrator will have to manually add in all devices not on its subnet. For example, each device needs to be added individually by its IP address.



APPENDIX F. TROUBLESHOOTING

This page covers some basic notes & troubleshooting when using the Emerald®.

Operating Modes: Connecting to an Emerald transmitter from an RDP client that is from a laptop/computer is not possible; you must use an Emerald receiver for this. An Emerald receiver can connect to an Emerald transmitter and RDP server.

TABLE D-1. OPERATING MODES CONFIGURATIONS

USER SIDE	COMPUTER SIDE	OPERATION
Laptop/Computer w/RDP Client	Emerald SE or PE Transmitter or Emerald ZeroU Transmitter	This is not supported and will not work.
Emerald SE Receiver	Emerald SE or PE Transmitter or Emerald ZeroU Transmitter	Fully supported
Emerald SE Receiver	RDP Server on VM or OS	Fully supported

Sluggish Mouse: When using the Emerald, you may find that the mouse is not being very responsive, or has a noticeable delay. This can typically occur if the video card is using dithering technology. You can contact Black Box to get a small utility to disable video card dithering on AMD graphics cards or use video optimization, which is set on the Transmitter -> Preferences page for single-head transmitters only.

Error Codes: The following error codes expanded.

1 GENERAL_ERROR

Connection protocol failure. Are the unit(s) at the correct and compatible software version?

2 INIT_FAIL

Can't start protocol. Is the receiver at the correct software version?

3 GET_SOCKET

Protocol Start Failure. Are the unit(s) at the correct and compatible software version?

4 CREATE_SESSION_FAIL

Can't create session. Is the transmitter connected and powered on?

5 CONNECT_FAIL

Can't create session. Is the transmitter connected and powered on? Is port 22 open between units?

6 TX_CHECK_FAIL

Target device is not a transmitter. Is the transmitter's IP address correct?

7 VER_CHECK_FAIL

Can't read device Version. Is the transmitter connected and powered on?

8 LED_FLASH_FAIL

Start LED Flash command failed on remote device. Is the transmitter connected and powered on?

9 FILE_SEND_FAIL

Can't send upgrade file to transmitter. Is the transmitter connected and powered on?

10 PERMISSION_CHANGE_FAIL

Update to change settings on transmitter. Is the transmitter connected and powered on?

11 EXTRACT_UPGRADE_FAIL

Failed to extract upgrade file. Is the upgrade file correct or damaged?

APPENDIX F. TROUBLESHOOTING

12 RUN_UPGRADE_FAIL

Upgrade failed. Is the upgrade file correct or damaged?

13 REBOOT_FAIL

Failed to reboot remote device unit. Is the remote device connected and powered on?

14 FILE_SEARCH_FAIL

Upgrade file format failed. Is the upgrade file correct or damaged?

15 LISTEN_ERROR

Connection protocol failure. Are units at the correct and compatible software version? Is the transmitter connected and powered on?

16 SOCKET_OPTION_ERROR

Connection protocol failure. Are units at the correct and compatible software version? Is the transmitter connected and powered on?

17 SOCKET_BIND_ERROR

Connection protocol failure. Are units at the correct and compatible software version? Is the transmitter connected and powered on?

18 RECVFROM_ERROR

Connection protocol failure. Are units at the correct and compatible software version? Is the transmitter connected and powered on?

19 GET_INFO_FAIL

Failed to retrieve Info tab from remote device. Are units at the correct and compatible software version? Is the transmitter connected and powered on?

20 COMPATIBILITY_FAIL

Upgrade file is incompatible with version on unit. Please check release notes for correct version and compatibility information.

21 BRAND_CHECK_FAIL

This is not a correct upgrade file for Emerald®. Please check release notes for correct version and compatibility information.

22 CLASS_CHECK_FAIL

Can't upgrade transmitter with receiver file or visa versa. Please check release notes for correct version and compatibility information.

23 PACKAGE_CHECK_FAIL

Incorrect upgrade file for this model. Please check release notes for correct version and compatibility information.

24 NO_UPGRADE_REQUIRED

No upgrade required. This version of code is already on the device. No upgrade is required.



APPENDIX G. REGULATORY INFORMATION

G.1 FCC STATEMENT

This equipment has been tested and found to comply with the limits for a Class A digital device, pursuant to part 15 of the FCC Rules. These limits are designed to provide reasonable protection against harmful interference when the equipment is operated in a commercial environment. This equipment generates, uses, and can radiate radio frequency energy and, if not installed and used in accordance with the instruction manual, may cause harmful interference to radio communications. Operation of this equipment in a residential area is likely to cause harmful interference in which case the user will be required to correct the interference at his own expense.

This Class A digital apparatus complies with Canadian ICES-003.

Cet appareil numérique de la Classe A est conforme à la norme NMB-003 du Canada

APPENDIX G. REGULATORY INFORMATION

G.2 NOM STATEMENT

1. Todas las instrucciones de seguridad y operación deberán ser leídas antes de que el aparato eléctrico sea operado.
2. Las instrucciones de seguridad y operación deberán ser guardadas para referencia futura.
3. Todas las advertencias en el aparato eléctrico y en sus instrucciones de operación deben ser respetadas.
4. Todas las instrucciones de operación y uso deben ser seguidas.
5. El aparato eléctrico no deberá ser usado cerca del agua—por ejemplo, cerca de la tina de baño, lavabo, sótano mojado o cerca de una alberca, etc.
6. El aparato eléctrico debe ser usado únicamente con carritos o pedestales que sean recomendados por el fabricante.
7. El aparato eléctrico debe ser montado a la pared o al techo sólo como sea recomendado por el fabricante.
8. Servicio—El usuario no debe intentar dar servicio al equipo eléctrico más allá a lo descrito en las instrucciones de operación. Todo otro servicio deberá ser referido a personal de servicio calificado.
9. El aparato eléctrico debe ser situado de tal manera que su posición no interfiera su uso. La colocación del aparato eléctrico sobre una cama, sofá, alfombra o superficie similar puede bloquea la ventilación, no se debe colocar en librerías o gabinetes que impidan el flujo de aire por los orificios de ventilación.
10. El equipo eléctrico debe ser situado fuera del alcance de fuentes de calor como radiadores, registros de calor, estufas u otros aparatos (incluyendo amplificadores) que producen calor.
11. El aparato eléctrico deberá ser conectado a una fuente de poder sólo del tipo descrito en el instructivo de operación, o como se indique en el aparato.
12. Precaución debe ser tomada de tal manera que la tierra física y la polarización del equipo no sea eliminada.
13. Los cables de la fuente de poder deben ser guiados de tal manera que no sean pisados ni pellizcados por objetos colocados sobre o contra ellos, poniendo particular atención a los contactos y receptáculos donde salen del aparato.
14. El equipo eléctrico debe ser limpiado únicamente de acuerdo a las recomendaciones del fabricante.
15. En caso de existir, una antena externa deberá ser localizada lejos de las líneas de energía.
16. El cable de corriente deberá ser desconectado del cuando el equipo no sea usado por un largo periodo de tiempo.
17. Cuidado debe ser tomado de tal manera que objetos líquidos no sean derramados sobre la cubierta u orificios de ventilación.
18. Servicio por personal calificado deberá ser provisto cuando:
 - A: El cable de poder o el contacto ha sido dañado; u
 - B: Objetos han caído o líquido ha sido derramado dentro del aparato; o
 - C: El aparato ha sido expuesto a la lluvia; o
 - D: El aparato parece no operar normalmente o muestra un cambio en su desempeño; o
 - E: El aparato ha sido tirado o su cubierta ha sido dañada.



APPENDIX H. DISCLAIMER/TRADEMARKS

H.1 DISCLAIMER

Black Box Network Services shall not be liable for damages of any kind, including, but not limited to, punitive, consequential or cost of cover damages, resulting from any errors in the product information or specifications set forth in this document and Black Box Network Services may revise this document at any time without notice.

H.2 TRADEMARKS USED IN THIS MANUAL

Black Box and the Double Diamond logo are registered trademarks of BB Technologies, Inc.

Any other trademarks mentioned in this manual are acknowledged to be the property of the trademark owners.



**NEED HELP?
LEAVE THE TECH TO US**

**LIVE 24/7
TECHNICAL
SUPPORT**

1.877.877.2269

BLACK BOX  **®**

© COPYRIGHT 2023, 2024. BLACK BOX CORPORATION. ALL RIGHTS RESERVED.
EN_KVM_MANUAL_EMD2000SE_REV6.9.0_2407.PDF