

DJI GOGGLES INTEGRAL MOTION COMBO

User Manual

v1.2 2023.04



Searching for Keywords

Search for keywords such as “battery” and “install” to find a topic. If you are using Adobe Acrobat Reader to read this document, press Ctrl+F on Windows or Command+F on Mac to begin a search.

Navigating to a Topic

View a complete list of topics in the table of contents. Click on a topic to navigate to that section.

Printing this Document

This document supports high resolution printing.

Revision Log

Version	Date	Revisions
v1.2	2023.04	<ol style="list-style-type: none">1. Updated the FN dial functions.2. Updated the Goggles FPV view.3. Updated the firmware update methods.4. Updated the supported aircraft model list.

Using this Manual

Legend

 Important

 Hints and Tips

Before Flight

It is recommended to watch all tutorial videos and read the safety guidelines before using for the first time. Prepare for your first flight by reviewing the quick start guide and referring to this user manual for more information.

-  • 5.8 GHz is not supported in some regions. This frequency band will automatically be disabled when the aircraft is activated or connected to the DJI™ Fly app in these regions. Observe local laws and regulations.
- Using the goggles does not satisfy the requirement of visual line of sight (VLOS). Some countries or regions require a visual observer to assist during flight. Make sure to comply with local regulations when using the goggles.

Video Tutorials

<https://www.dji.com/goggles-integra/video>

Download the DJI Fly App

<https://www.dji.com/goggles-integra/downloads>

Download DJI Assistant 2 (Consumer Drones Series)

<https://www.dji.com/goggles-integra/downloads>

Table of Content

Using this Manual	3
Legend	3
Before Flight	3
Video Tutorials	3
Download the DJI Fly App	3
Download DJI Assistant 2 (Consumer Drones Series)	3
Overview	6
DJI Goggles Integra	6
DJI RC Motion 2	7
Getting Started	9
Preparing the Goggles	9
Preparing the Motion Controller	13
Activation	14
Linking	15
Wearing the Goggles	17
DJI Goggles Integra	18
Operating the Goggles	18
Goggles FPV View	18
Shortcut Menu	20
Camera Settings	21
Goggles Menu	22
Sleep Mode	25
Footage Storage and Export	25
Formatting the microSD Card	26
Screen Masking	26
Using the Head Tracking Function	26
Switching Aircraft	26
DJI RC Motion 2	27
Controlling the Aircraft	27
Controlling the Camera	29
Motion Control	30
Motion Controller Alert	31
Motion Controller Calibration	31

Firmware Update and Device Maintenance	32
Firmware Update	32
Storing the Goggles	33
Cleaning and Maintenance	34
Replacing the Foam Padding	34
After-sales Information	35
Appendix	36
Specifications	36
Low Blue Light Statement	37

Overview

DJI Goggles Integra (hereinafter referred to as goggles) is equipped with two high-performance screens and ultra-low latency image transmission for use with DJI aircraft, giving a real-time aerial FPV (First Person View) experience. When used with the DJI RC Motion 2 (hereinafter referred to as motion controller), users can easily and intuitively control the aircraft.

DJI Goggles Integra

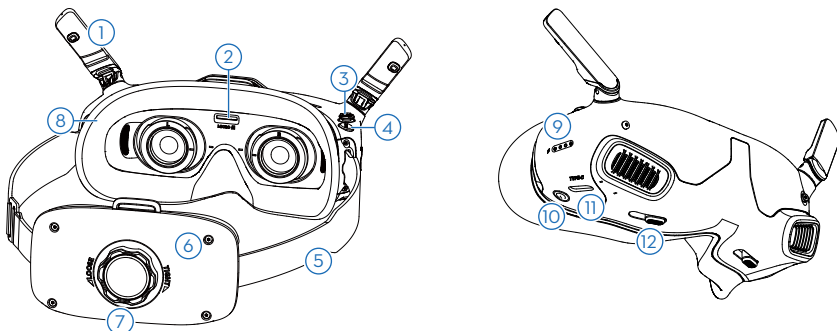

1. Antennas

2. microSD Card Slot

3. 5D Button

Press down or toggle to the right to open the menu from the FPV view of the goggles. Toggle the button forward to open the camera settings panel and toggle backward to open the shortcut menu.

After the settings panel is opened, toggle the button to navigate the menu or adjust the parameter value. Press the button to confirm the selection.

4. Back Button

Press to return to the previous menu or exit the current view.

5. Headband

-
- ⚠ • The battery wires are embedded in the headband. DO NOT pull the headband with force to avoid damaging the wires.
-

6. Battery Compartment

7. Headband Adjustment Knob

Rotate the knob to adjust the length of the headband.

8. Foam Padding

9. Battery Level LEDs

10. Power Button/Link Button

Press once to check the current battery level.

Press, and then press and hold to power the goggles on or off.

When powered on, press and hold the button to initiate linking.

11. USB-C Port

For charging, connecting headphones, or connecting the goggles to a computer.

- ☀️ • Only supports Type-C headphones and headphone adapters with built-in DAC (digital-to-analog converter).
- It is recommended to use the USB-C OTG cable provided and a USB-A to USB-C cable to connect the goggles to a mobile device.
- The goggles do not support computer connection using a USB-C to USB-C cable.

12. IPD (Interpupillary Distance) Slider

Slide left and right to adjust the distance between the lenses until the image is properly aligned.

DJI RC Motion 2

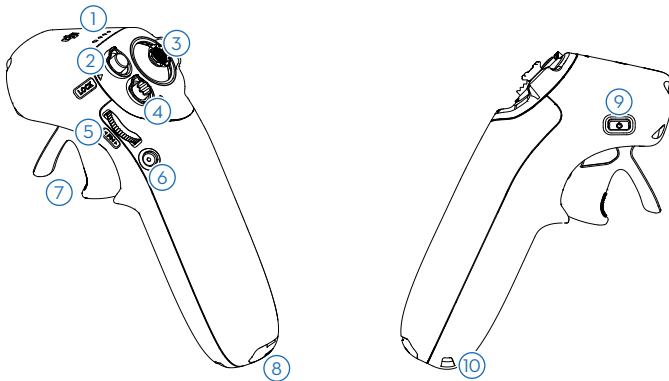

1. Battery Level LEDs

2. Lock Button

Start/stop motors: press the lock button twice to start or stop the aircraft motors.

Takeoff: press twice to start the aircraft motors, then press and hold to make the aircraft take off. The aircraft will ascend to approximately 1.2 m and hover.

Landing: while the aircraft is hovering, press and hold to land the aircraft and stop the motors.

Brake: press once to make the aircraft brake and hover in place. Press again to unlock the attitude.

When the aircraft is performing RTH or auto landing, press the button once to cancel RTH or landing.

3. Joystick

Toggle up or down to make the aircraft ascend or descend. Toggle left or right to make the aircraft move horizontally left or right.

4. Mode Button

Press to switch between Normal and Sport mode. Press and hold to initiate RTH. Press again to cancel RTH.

5. FN Dial

Press the dial to open the camera settings panel in the FPV view. Scroll the dial to navigate the settings menu or adjust the parameter value, then press the dial to confirm the selection. Press and hold the dial to exit the current menu.

The FN dial can also be used to control the camera tilt before takeoff or during RTH and landing. Press and hold the FN dial from the FPV view and then scroll up or down to tilt the camera. Release the dial to stop the camera tilt.

If the aircraft supports Explore Mode and Explore Mode is turned on, scroll the dial on the goggles FPV view to adjust the camera zoom.

6. Shutter/Record Button

Press once: take a photo or start/stop recording.

Press and hold: switch between the photo and video modes.

7. Accelerator

Press to fly the aircraft in the direction of the circle in the goggles. Push forward to fly the aircraft backward. Apply more pressure to accelerate. Release to stop and hover.

8. USB-C Port

9. Power Button/Link Button

Press once to check the current battery level.

Press, and then press and hold to power the motion controller on or off.

When powered on, press and hold the button to initiate linking.

10. Lanyard Hole

Getting Started

This chapter helps users with first time use.

Preparing the Goggles

Installing the Corrective Lenses

The goggles are equipped with a pair of eyeglass frames and come with 10 pairs of vision corrective lenses (from -8.0 diopter to +2.0 diopter, without astigmatism correction) and one pair of plain lenses (0 diopter). Users can install suitable lenses according to their actual eyesight.

- Even if vision correction is not necessary, it is strongly recommended to install the plain lenses to protect the goggles screen glasses from being scratched.
- If astigmatism correction is needed or the provided lenses are not suitable, users can purchase additional lenses. When purchasing lenses, take the eyeglass frames (a pair) and a pair of lenses to a professional optician to ensure that the shape, size, astigmatism axis, and edge thickness (< 2.8 mm) of the lenses meet the installation requirements of the eyeglass frames.

1. Detach the eyeglass frames from the goggles (no need to rotate the frames). Turn over the frames and identify the shortest line mark (a), the longest line mark (b), and the side line mark (c), as shown in the diagram below.

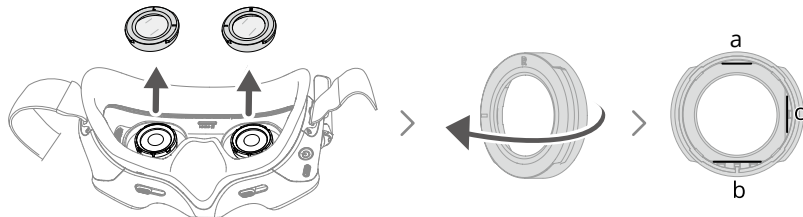

2. Take out the suitable lenses from the package. The diopter of the lenses is printed on the inside of the lens box lid and also marked on the edge of each lens. Identify the shortest cut edge (a), the longest cut edge (b), and the side cut edge (c), as shown in the diagram below.

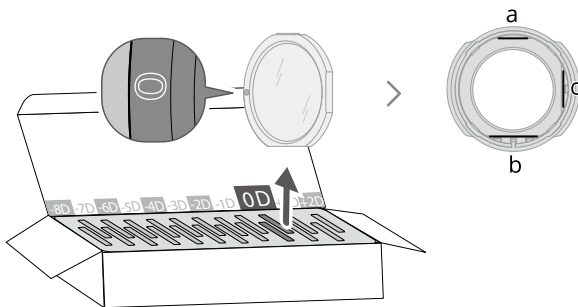

3. Distinguish the left and right frames and the corresponding lens, then install the lenses into the frames. Make sure that the shortest cut edge (a), the longest cut edge (b), and the side cut edge (c) of the lens are aligned with the corresponding line marks on the frame respectively. For easier installation, align and insert the longest edge (b) first. Make sure the lens is installed in place and not tilted. If the cut edges of the lens are not properly aligned with the frame line marks, the lens will not fit into the frame. Clean the lens with the provided cleaning cloth to wipe off the fingerprints and dust after installation.

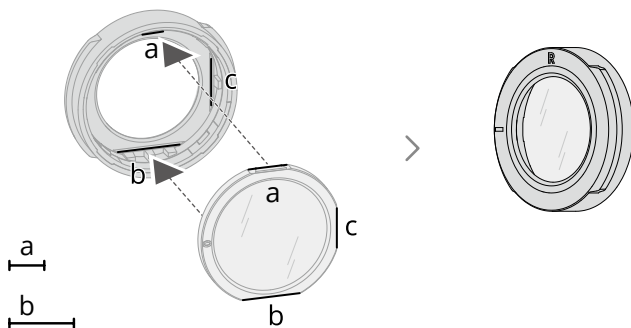

4. Mount the lens-installed frames onto the goggles (no need to rotate the frames). When installing, make sure that the letter L/R on the top of the frame is facing upwards and that the positioning mark on the frame is aligned with the positioning mark on the goggles.

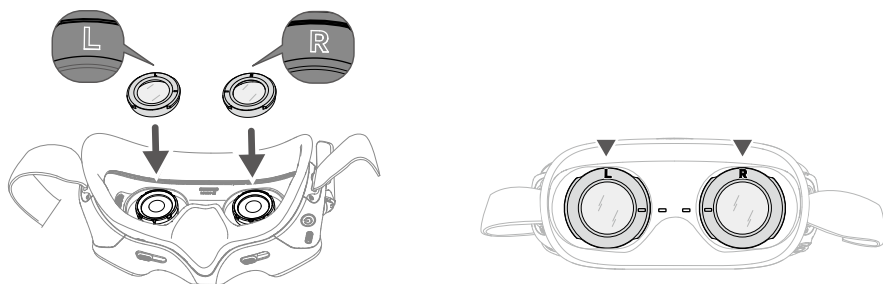

Installing the Headband and Unfolding the Antennas

- ⚠ • The battery wires are embedded in the headband. DO NOT pull the headband with force to avoid damaging the wires.
- Fold the antennas to avoid damage when the goggles are not in use.
 - DO NOT tear or scratch the foam padding and the soft side of the battery compartment with sharp objects.

Hook the headband and unfold the antennas.

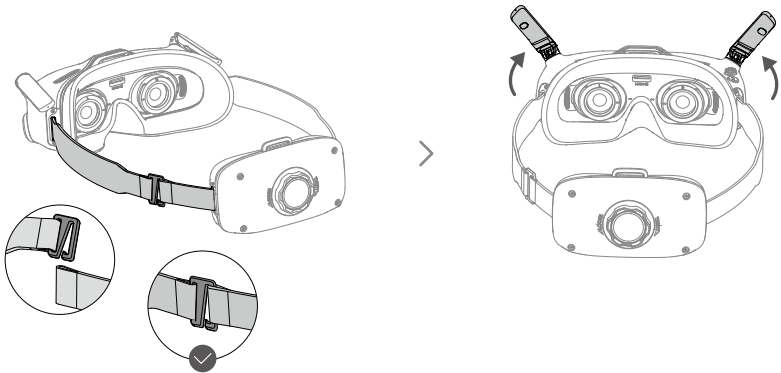

Install the provided top headband to improve stability if necessary. Attach one end of the headband to the headband fixing hole on the top of the goggles and the other end to the hole on the top of the battery compartment. Adjust the headband to the appropriate length.

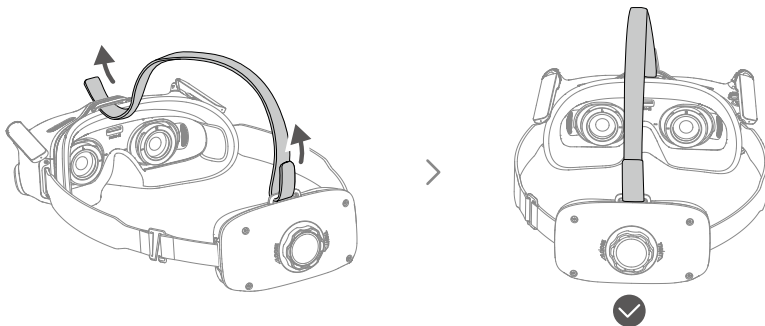

Powering on

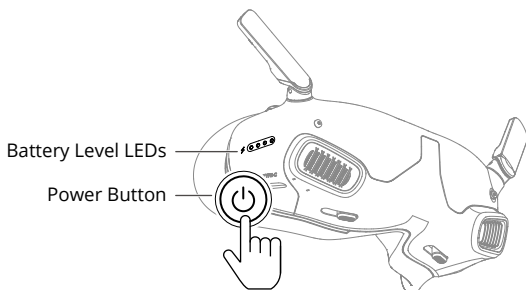

Press the power button once to check the current battery level.
Press, and then press and hold the power button to power on the goggles.

The battery level LEDs display the power level of the battery during charging and discharging. The statuses of the LEDs are defined below:

- LED is on.
- ⦿ LED is flashing.
- LED is off.

LEDs				Battery Level
○	○	○	○	89%-100%
○	○	○	⦿	76%-88%
○	○	○	○	64%-75%
○	○	⦿	○	51%-63%
○	○	○	○	39%-50%
○	⦿	○	○	26%-38%
○	○	○	○	14%-25%
⦿	○	○	○	1%-13%

If the battery level is low, it is recommended to use a USB Power Delivery charger that supports 9 V, ≥ 2 A output to charge the device.

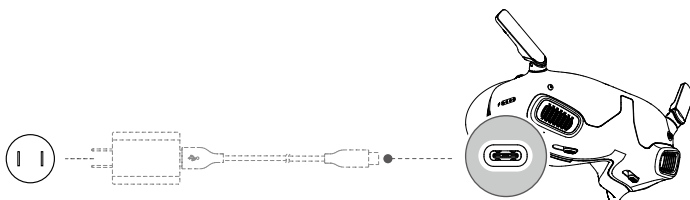

The table below shows the battery level LED status during charging.

LEDs				Battery Level
☀	☀	○	○	1%-50%
☀	☀	☀	○	51%-75%
☀	☀	☀	☀	76%-99%
○	○	○	○	100%

Preparing the Motion Controller

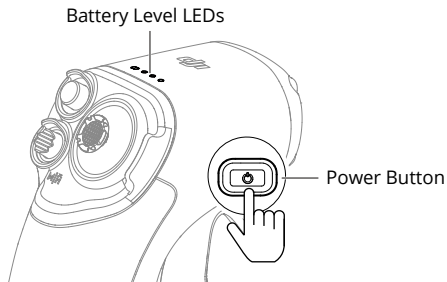

Press the power button once to check the current battery level.

Press, and then press and hold the power button to power on the motion controller.

The battery level LEDs display the power level of the battery during charging and discharging. The statuses of the LEDs are defined below:

- LED is on.
- ☀ LED is flashing.
- LED is off.

LEDs				Battery Level
▬	○	○	○	81%-100%
▬	○	○	☀	76%-80%
▬	○	☀	○	64%-75%
▬	○	☀	○	51%-63%
▬	○	○	○	26%-50%
▬	☀	○	○	16%-25%
▬	○	○	○	9%-15%
☀	○	○	○	1%-8%

If the battery level is low, it is recommended to use a charger that supports 5 V, 2 A output to charge the device.

- ⚠ • Make sure that the default output voltage of the charger is 5 V. Excessive voltage will damage the device.

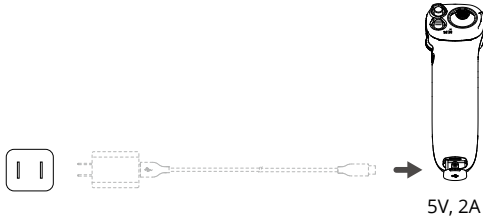

The table below shows the battery level LED status during charging.

LEDs				Battery Level
				1%-50%
				51%-75%
				76%-99%
				100%

Activation

Activate and update the firmware before using the device for the first time.

Connect the USB-C port of the goggles to the mobile device, and run the DJI Fly app. Follow the on-screen instructions to activate the device and update the firmware. Make sure the mobile device is connected to the internet during activation.

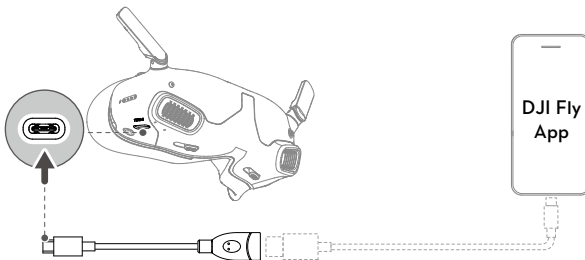

- Use the USB-C OTG cable provided to connect if you are using a USB-A to USB-C cable.
- The goggles only support standard USB-C protocols and MFI-certified Lightning cables. Non-standard cables are not supported. If the devices do not respond after connecting, use a different data cable and try again.

Linking

Preparation before linking:

1. Power on the aircraft, goggles, and motion controller.
2. Press the 5D button on the goggles to open the menu. Select **Status** and make sure that the aircraft model displayed at the top of the menu is correct. Otherwise, select **Switch** from the upper right corner of the menu and then select the correct aircraft.

Linking via DJI Fly App (recommended)

Keep the goggles connected to the mobile device after activation. Tap **Connection Guide** on DJI Fly from the mobile device and follow the on-screen instructions to connect the aircraft.

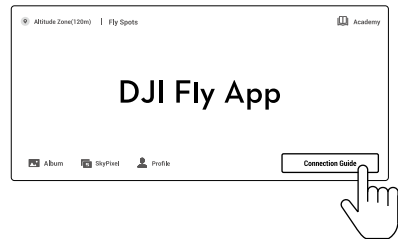

Linking via Button

1. Link the aircraft with the goggles:



- a) Press and hold the power button on the aircraft until the battery level LEDs start to blink in sequence.
- b) Press and hold the power button on the goggles until the goggles start to beep continually.
- c) Once linking is completed, the battery level LEDs of the aircraft turn solid and display the battery level, the goggles stop beeping, and image transmission can be displayed normally.

 • Press the power button on the goggles to stop the process if the goggles fail to link with the aircraft. Connect the goggles to a mobile device, run the DJI Fly app, tap **Connection Guide**, and then follow the on-screen instructions to link.

2. Link the aircraft with the motion controller:

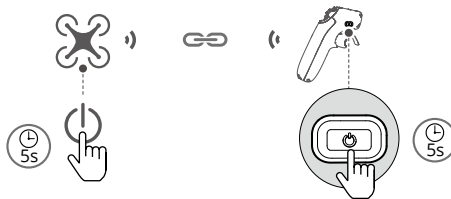

- a) Press and hold the power button on the aircraft until the battery level LEDs start to blink in sequence.
- b) Press and hold the power button on the motion controller until the controller beeps continually and the battery level LEDs blink in sequence.
- c) The motion controller stops beeping once linking is successful, and both the aircraft and motion controller battery level LEDs turn solid and display the battery level.

 • The aircraft can be controlled with only one remote control device during flight. If your aircraft has been linked with multiple remote control devices, turn off other control devices before flight.

Wearing the Goggles

1. Wear the goggles after the devices are powered on and the image transmission is displayed.

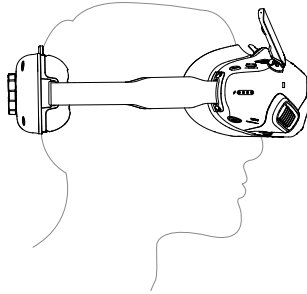

2. Slide the IPD sliders left and right to adjust the distance between the lenses until the images are properly aligned.

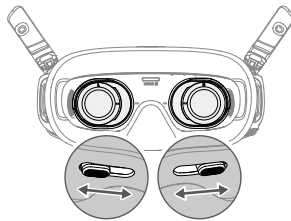

3. Rotate the headband adjustment knob on the battery compartment to adjust the length of the headband. Rotate clockwise to tighten the headband and counterclockwise to loosen the headband.

 • The battery wires are embedded in the headband. DO NOT pull the headband with force to avoid damaging the wires.

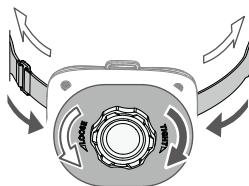

DJI Goggles Integra

Operating the Goggles

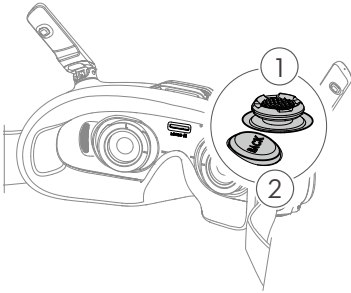

1. 5D Button

Press down or toggle to the right to open the menu from the FPV view of the goggles. Toggle the button forward to open the camera settings panel and toggle backward to open the shortcut menu.

After a settings panel is opened, toggle the button to navigate the menu or adjust the parameter value. Press the button to confirm the selection.

2. Back Button

Press to return to the previous menu or exit the current view.

Goggles FPV View

- ☀️ • The actual screen interface may differ from the descriptions in this manual and vary depending on the aircraft used and the firmware version of the goggles.

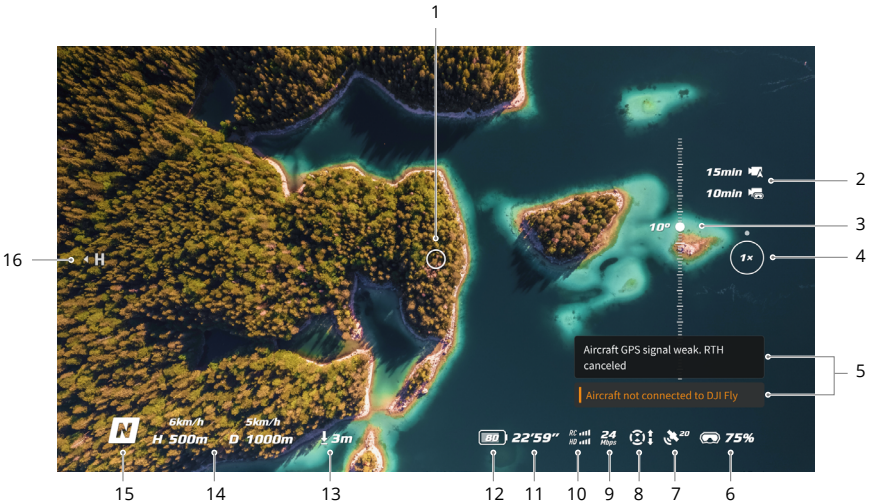

1. Flight Direction Indicator

When controlling the aircraft with the motion controller, it indicates the direction in which the aircraft is heading.

2. Storage Information

Displays the remaining capacity of the aircraft or goggles storage. A flashing icon will appear when recording to display the recording time.

3. Gimbal Slider

Displays the gimbal tilt angle.

4. Zoom Ratio

If the aircraft supports Explore Mode, and Explore Mode is turned on in the Shooting mode, the current zoom ratio will be displayed. Scroll the dial on the goggles FPV view to adjust the camera zoom.

5. Prompts

Displays notifications and information such as when a new mode is applied or battery level is low.

6. Goggles Battery Level

Displays the battery level of the goggles.

7. GNSS Signal Strength

Displays the current strength of the aircraft GNSS signal.

If the device is not used for an extended period, it may take longer than usual to search for the GNSS signal. If repeatedly powering on and off within a short period, it takes approximately 20 seconds to search for the GNSS signal when the signal is unobstructed.

8. Vision System Status

Displays the vision system status of the linked aircraft, this icon varies according to the aircraft model. The icon is white when the vision system is working normally and turns red when the vision system is unavailable.

9. Video Bitrate

Displays the current video bitrate of the live view.

10. Remote Controller and Image Transmission Signal Strength

Displays the signal strength between the aircraft and the remote controller, and the image transmission signal strength between the aircraft and the goggles.

11. Remaining Flight Time

Displays the remaining flight time of the aircraft after starting the motors.

12. Aircraft Battery Level

13. Distance to the Ground

Displays the current altitude information of the aircraft from the ground when the aircraft is less than 10 m above the ground.

14. Flight Telemetry

Displays the horizontal distance (D) and speed as well as the vertical distance (H) and speed between the aircraft and the Home Point.

15. Flight Modes

Displays the current flight mode.

16. Home Point

Indicates the relative position of the Home Point.

Shortcut Menu

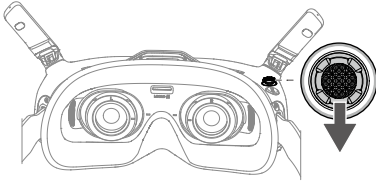

Toggle the 5D button backward to open the shortcut menu from the FPV view and access the quick control of the following functions:

- Take a photo, or start/stop recording
- Enable/disable Enhanced Display
- Enable/disable Head Tracking
- Adjust brightness

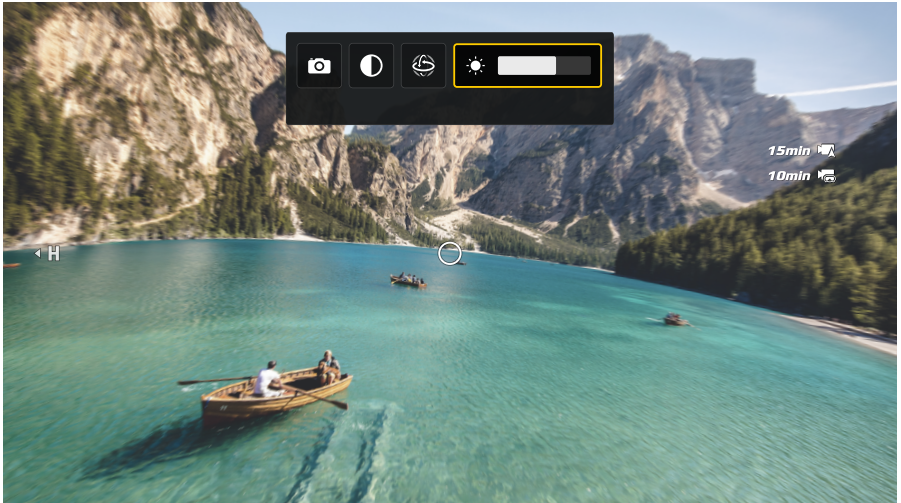

Camera Settings

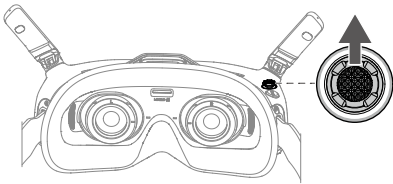

Toggle the 5D button forward to open the camera settings panel from the FPV view and change camera-related parameters.

-
-  • The camera settings may vary depending on the aircraft used.
-

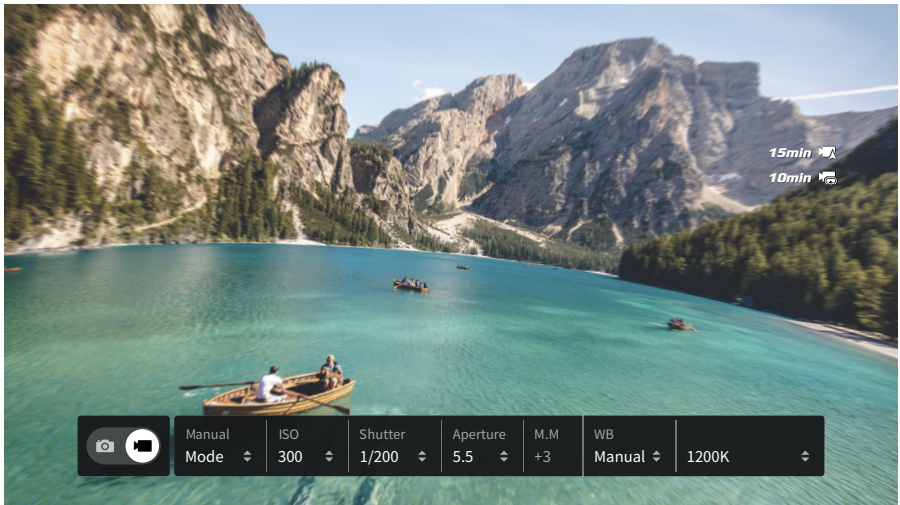

Goggles Menu

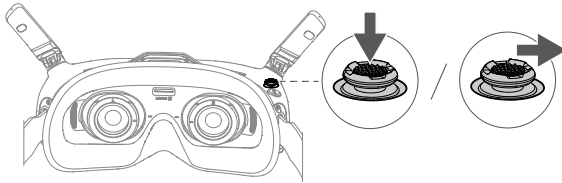

Press down the 5D button or toggle it to the right to open the menu from the FPV view.

- ☀️ • The actual menu options may differ from the descriptions in this manual and vary depending on the aircraft used and the firmware version of the goggles.

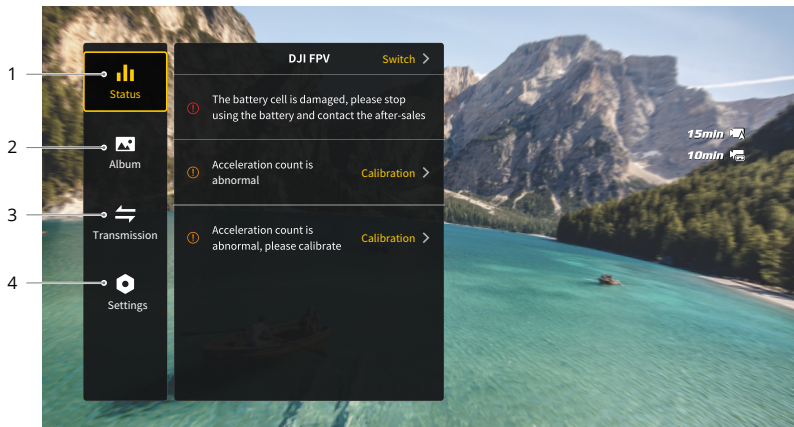

1. Status

- Displays the in-use aircraft model and detailed information of prompt alerts.
- Use the switch function in the upper right corner to change aircraft.

2. Album

Shows the photos or videos stored on the microSD card. Select any file to preview.

3. Transmission

The Transmission menu has a pilot sub-menu and audience sub-menu:

- The video transmission mode for the current device can be set under the pilot sub-menu, including but not limited to the following:

- a) Enable or disable the broadcast mode (only supported by certain aircraft). The device number will be displayed when broadcast mode is enabled so that other devices can find the device and enter the channel to see the camera view.
 - b) Enable or disable the focus mode, or set to auto.
 - c) Set the channel mode to auto or manual. It is recommended to select auto so that the video transmission will automatically switch between the 2.4 and 5.8 GHz frequency bands and select the channel with the best signal.
 - d) Set the frequency band. If the channel mode is set to manual, either 2.4 or 5.8 GHz can be selected (some aircraft only support the single frequency band).
 - e) Set the bandwidth of the video transmission. The number of channels available varies according to the bandwidth. The channel with the best signal strength can be manually selected. The higher the bandwidth, the more data can be transferred to provide a higher video transmission rate and clearer image quality. However, there will be a higher chance of wireless interference when using a higher bandwidth and the amount of equipment that can be accommodated will be limited. To avoid interference in a multiplayer competition, manually select a fixed bandwidth and channel.
- If any nearby video transmission device turns on the broadcast mode, the device and its signal strength can be viewed in the audience sub-menu. Select a channel to see the camera view.

4. Settings

- Safety
 - a) Set the safety configurations such as max flight altitude, max flight distance, and RTH altitude. Users can also update the Home Point, set obstacle avoidance behavior (if the aircraft supports obstacle avoidance), and view the IMU and compass status and calibrate them if necessary.
 - b) Camera View Before Loss helps to find the location of the aircraft on the ground by using the cached video in the goggles. If the aircraft still has battery power, turn on the ESC beeping to locate the aircraft using sound.
 - c) Advanced Safety Settings include the following:
 - Aircraft Signal Lost Action: The aircraft behavior can be set to hover, land, or RTH when the remote controller signal is lost.
 - AirSense: The goggles will notify users if there is a civil airplane approaching in nearby airspace. This function is enabled by default. DO NOT disable it.
 - Emergency Propeller Stop (disabled by default): When enabled, the motors of the aircraft can be stopped mid-flight anytime once the user presses the motion controller lock button four times. If the switch is disabled, the motors can only be stopped with this action in an emergency, such as if a collision occurs, a motor stalls, the aircraft rolls in the air, or the aircraft is out of control and is ascending or descending quickly.



- Stopping motors mid-flight will cause the aircraft to crash. Operate with caution.
-

- Control
 - a) Configure remote controller-related functions, such as setting the stick mode, customizable buttons, and calibrating the IMU and compass.
 - b) Calibrate the motion controller, or view the tutorial video.
 - c) Calibrate the gimbal, adjust the gimbal tilt speed, set the unit, or use the turtle mode to flip the overturned aircraft upright (only certain aircraft support the turtle mode).
 - d) View the goggles tutorial.
- Camera
 - a) Set the aspect ratio, video quality, video format, gridlines, storage device, or format the microSD card.



• Data cannot be recovered after formatting. Operate with caution.

- b) Advanced Camera Settings:
 - Set the recording device, color, and anti-flicker, enable or disable auto record at takeoff, as well as enable or disable video subtitles.
 - Camera View Recording (enabled by default): if disabled, the recording of the goggles screen will not include the OSD elements.
 - c) Select **Reset Camera Parameters** to restore all camera settings to default.
- Display
Adjust screen brightness, zoom, display or hide the Home Point, and disable the screen masking function.
 - About
 - a) View device information, such as the serial number, the firmware of the goggles, and linked devices.
 - b) Set the system language.
 - c) View the compliance information.
 - d) Reset the goggles and the linked devices to their default settings.

Sleep Mode

If the goggles are idle for over 40 seconds of inactivity after being powered on, the goggles will enter sleep mode and the screen will power off. Shaking the goggles within 5 minutes will power on the screen. Otherwise, the goggles will automatically power off.

If you are wearing or holding the goggles for 40 seconds without any operation, the goggles will sound an alert and display a prompt asking whether to shut down. If the user does not take any action, the goggles will automatically power off after 60 seconds.

Footage Storage and Export

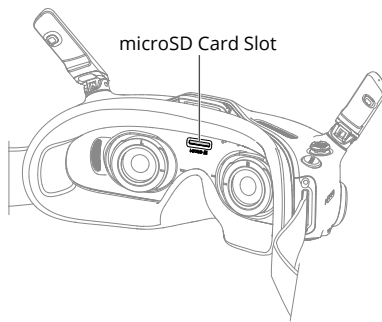

The goggles support the installation of a microSD card. After a microSD card is inserted, while the aircraft is recording video, the goggles will simultaneously record the image transmission displayed on the screen and store it on the microSD card of the goggles.

To export the recorded footage, do the following:

1. Power on the goggles.
2. Connect the USB-C port of the goggles to a computer using a USB-A to USB-C cable, and follow the on-screen prompts to export the footage.



• The goggles do not support computer connection using a USB-C to USB-C cable.

The screen recording includes the OSD elements by default. To record the screen without OSD elements, change the settings as shown below:

1. Press down the 5D button to open the menu from the FPV view.
2. Select **Settings > Camera > Advanced Camera Settings** and disable **Camera View Recording**.

Formatting the microSD Card

To format the microSD card, do the following:

1. Press down the 5D button to open the menu from the FPV view.
2. Select **Settings** > **Camera** > **Format**.
3. Select the storage device to format and follow the on-screen instructions to complete the operation.

 • Data cannot be recovered after formatting. Operate with caution.

Screen Masking

The edges of the image transmission and screen recording may be distorted. The screen masking function can add a black border to the image to cover the obvious distortion. The function is enabled by default and the recorded footage will include the black border.

Users can disable the screen masking function in the following way:

1. Press down the 5D button to open the menu from the FPV view.
2. Select **Settings** > **Display** and disable **Screen Masking**.

Using the Head Tracking Function

The head tracking function is only supported by certain aircraft and can be enabled by selecting  from the shortcut menu. To open the shortcut menu, toggle the 5D button backward from the FPV view.

With the head tracking function enabled, the horizontal orientation of the aircraft and the gimbal tilt can be controlled through head movements. The remote control device will only control the flight path of the aircraft.

Switching Aircraft

To change aircraft, press down the 5D button to open the menu from the FPV view and select **Status**. Select **Switch** from the upper right corner and then choose the aircraft to be used. Follow the on-screen instructions to complete the change.

DJI RC Motion 2

-
- ⚠️ • To ensure flight safety when controlling the aircraft with the motion controller, press the lock button once to make the aircraft brake and hover before operating the goggles. Failure to do so is a safety risk and may lead to the aircraft losing control.
-

Controlling the Aircraft

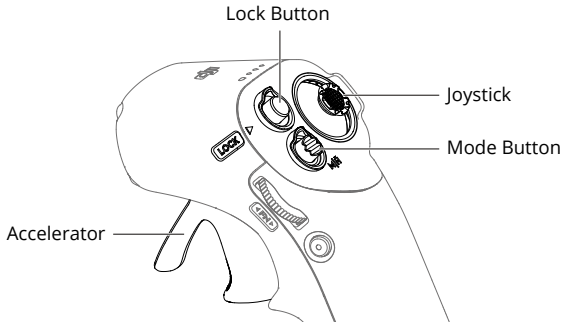

Mode Button

The motion controller has two modes: Normal mode and Sport mode. Normal mode is selected by default. Press the mode button to switch between Normal and Sport mode. Press and hold to initiate RTH. Press again to cancel RTH.

Lock Button

Use the lock button to control the takeoff, landing, and brake of the aircraft:

Start/stop motors: press the lock button twice to start or stop the aircraft motors.

Takeoff: press twice to start the aircraft motors, then press and hold to make the aircraft take off. The aircraft will ascend to approximately 1.2 m and hover.

Landing: press and hold the lock button while the aircraft is hovering to land and stop the motors automatically.

Brake: during flight, press once to brake the aircraft and make it hover in place with the attitude locked. Press again to unlock the attitude and resume the flight control.

When the aircraft is performing RTH or auto landing, press the button once to cancel RTH or landing.

-
- ⚠️ • Critical Low Battery landing cannot be canceled.
-

Stopping Aircraft Motors Mid-flight: if an emergency occurs (such as a collision or the aircraft is out of control) during flight, pressing the lock button four times can stop the aircraft motors immediately.

-
- ⚠️ • Stopping motors mid-flight will cause the aircraft to crash. Operate with caution.
-

Joystick

Toggle up or down to make the aircraft ascend or descend. Toggle left or right to make the aircraft horizontally move left or right.

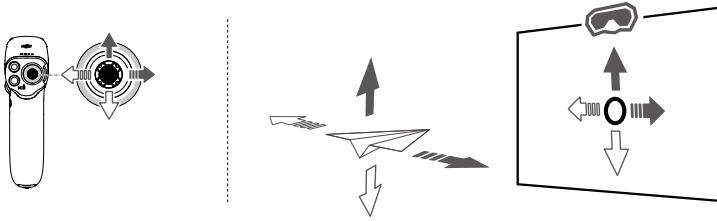

- After the aircraft motors are started by double-pressing the lock button, slowly push the joystick up to make the aircraft take off.
- Once the aircraft flies to the landing position, pull down the joystick to land the aircraft. After landing, pull down the joystick and hold in position until the motors stop.

Accelerator

Press the accelerator to fly in the direction of the circle in the goggles. Push forward to fly the aircraft backward. Apply more pressure to accelerate. Release to stop and hover.

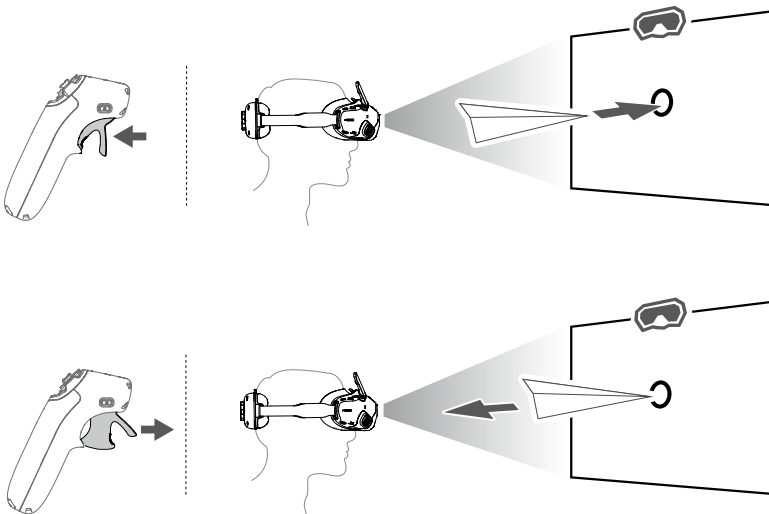

- ☛ The flying speed controlled by the joystick and the accelerator can be configured as below:
1. Press down the 5D button to open the menu from the FPV view
 2. Select **Settings > Control > Motion Controller > Gain Tuning**, then set the maximum speed in each direction.

Controlling the Camera

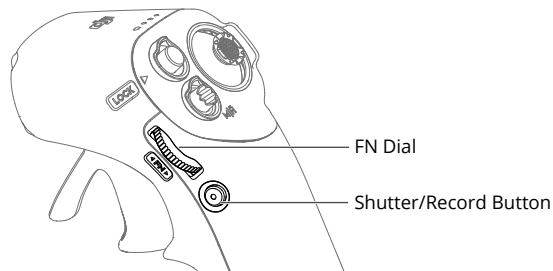

FN Dial

Adjusting the camera parameters: press the dial to open the camera settings panel from the FPV view of the goggles. Scroll the dial to navigate the settings menu or adjust the parameter value, then press the dial to confirm the selection. Press and hold the dial to exit the current menu.

Controlling the camera tilt: before takeoff or during RTH and landing, press and hold the dial from the FPV view and then scroll up or down to tilt the camera. Release the dial to stop the camera tilt.

Adjusting the zoom in Explore Mode: if the aircraft supports Explore Mode and Explore Mode is turned on, scroll the dial on the goggles FPV view to adjust the camera zoom.

Shutter/Record Button

Press and hold to switch between the photo and video modes. Press once to take a photo or to start or stop recording.

Motion Control

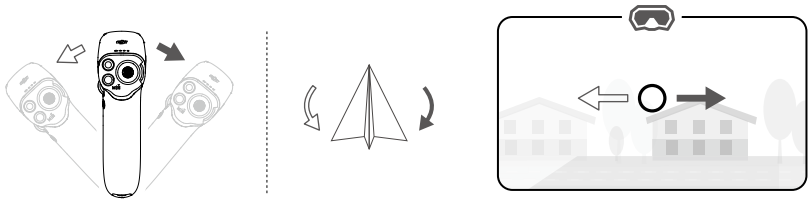

The orientation of the aircraft can be controlled by tilting the motion controller left and right. Tilt left to rotate the aircraft counterclockwise and tilt right to rotate clockwise. The circle in the goggles screen will move left and right and the image transmission will change accordingly.

The greater the tilt angle of the motion controller, the faster the aircraft will rotate.

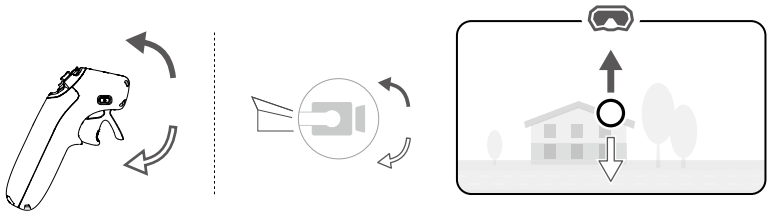

Tilt the motion controller up and down to control the tilt of the gimbal during flight. The circle in the goggles screen will move up and down and the image transmission will change accordingly.

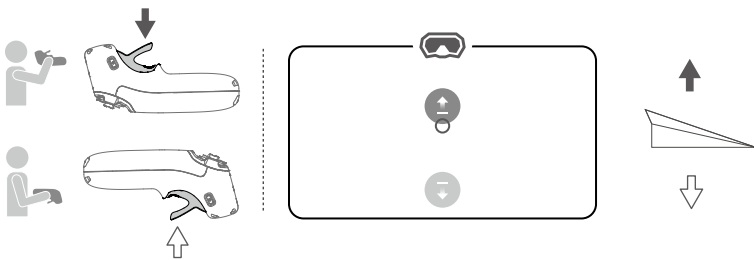

To control the ascent or descent of the aircraft, first tilt the motion controller 90° up or down. Once the circle in the goggles goes into the ascend (↑) or descend (↓) icon, press the accelerator to make the aircraft ascend or descend.

Motion Controller Alert

The remote controller sounds an alert when the battery level is between 6% and 15%. A low battery level alert can be canceled by pressing the power button. A critical battery level alert will sound when the battery level is less than 5% and cannot be canceled.

The remote controller sounds an alert during RTH. The alert cannot be canceled.

Motion Controller Calibration

The compass, IMU, accelerator, and joystick of the motion controller can be calibrated.

Immediately calibrate any of the modules when prompted to do so:

1. Press down the 5D button in the FPV view to open the menu.
2. Select **Settings > Control > Motion Controller > RC Calibration**.
3. Select the module and follow the prompts to complete calibration.



- DO NOT calibrate the device in locations with strong magnetic interference, such as near magnets, parking lots, or construction sites with underground reinforced concrete structures.
 - DO NOT carry ferromagnetic materials such as mobile phones during calibration.
-

Firmware Update and Device Maintenance

Firmware Update

Use one of the following methods to update the firmware:

Using DJI Fly App

When used with DJI Avata:

Power on the aircraft, goggles, and motion controller. Make sure all the devices are linked. Connect the USB-C port of the goggles to the mobile device, run DJI Fly, and follow the prompts to update the firmware. Make sure the mobile device is connected to the internet during the firmware update.

When used with other DJI aircraft:

Power off the aircraft. Power on the goggles and the motion controller. Connect the USB-C port of the goggles to the mobile device and run DJI Fly. Select **Profile > Device Management**. Locate the corresponding goggles. Select **Firmware Update** and follow the on-screen instructions to update the firmware. Make sure the mobile device is connected to the internet during the firmware update.

-
-  Use the USB-C OTG cable provided to connect if you are using a USB-A to USB-C cable.
 - The goggles only support standard USB-C protocols and MFI-certified Lightning cables. Non-standard cables are not supported. If the devices do not respond after connecting, use a different data cable and try again.
-

Using DJI Assistant 2 (Consumer Drones Series)

1. Power on the device. Connect the USB-C port of the goggles to the computer using a USB-C to USB-A cable.

-
-  The goggles do not support computer connection using a USB-C to USB-C cable.
-

2. Launch DJI ASSISTANT™ 2 and log in with a DJI account.

3. Select the device and click **Firmware Update** on the left side of the screen.

4. Select the firmware version.

5. The firmware will be downloaded and updated automatically.

6. The device will restart automatically after the firmware update is complete.

-
-  Make sure to follow all the steps to update the firmware, otherwise the update may fail.
 - The firmware update will take several minutes. It is normal if the screen turns off or the goggles restart automatically during the update. Please wait patiently for the firmware upgrade to complete.
 - Make sure the computer is connected to the internet during the update.
 - Make sure the device has sufficient power before updating the firmware.
 - Do not unplug the USB-C cable during the update.
 - Note that the update may reset the parameters. Before updating, take note of your preferred settings and reconfigure them after the update.
-

Storing the Goggles

When the goggles are not in use, store it in the following way:

1. Fold the antennas and unhook the headband.

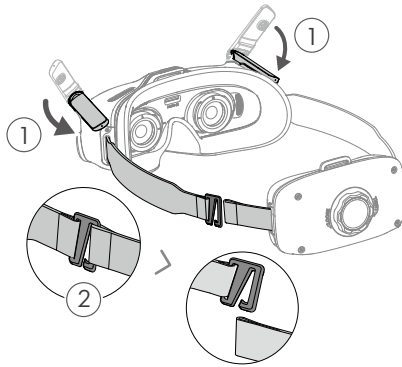

2. Rotate the headband adjustment knob counterclockwise to loosen the headband to the longest position.

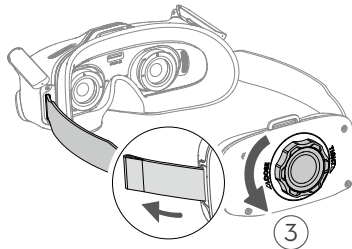

3. Fold the battery compartment and hook the headband as shown below, the goggles are now ready to be stored in a box.

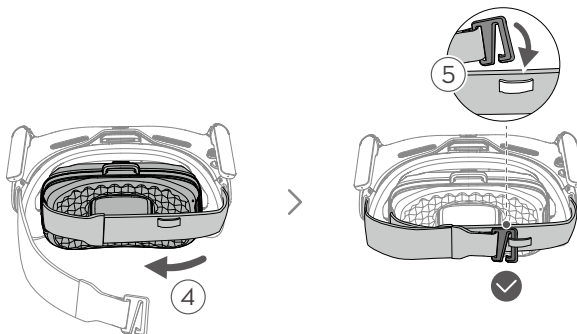

Cleaning and Maintenance

Wipe and clean the surface of the goggles with a dry and soft cloth. Use the provided lens cleaning cloth to clean the lenses in a circular motion from the center to the outer edges.

- ⚠ • DO NOT use alcohol to clean the screen glasses of the goggles. The additionally installed vision corrective lenses can be cleaned with disposable alcohol pads.
 - The lenses are delicate. Clean them gently. DO NOT scratch them as this will affect viewing quality.
 - DO NOT use alcohol or other cleanser to wipe the foam padding and the soft side of the battery compartment.
 - DO NOT tear or scratch the foam padding and the soft side of the battery compartment with sharp objects.
 - Store the goggles in a dry place at room temperature to avoid damage to the lenses and other optical components from high temperatures and humid environments.
 - Keep the lenses away from direct sunlight to avoid screen damage.
-

Replacing the Foam Padding

1. Hold the bottom of the foam padding and remove it gently as shown below.

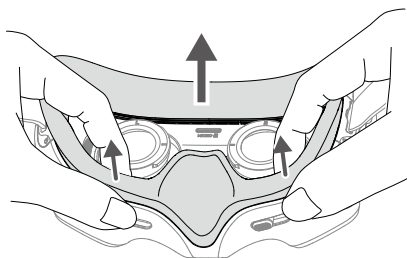

- ⚠ • DO NOT pull the sides when removing the foam padding. Otherwise, the padding may be damaged.

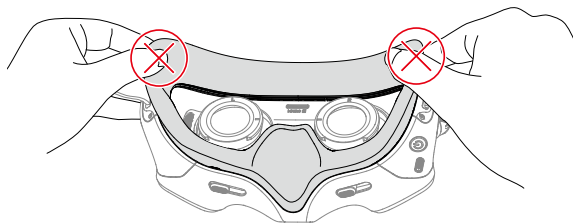

2. Align the positioning columns of the new foam padding with the positioning holes on the goggles, install it and press along the contour. After hearing a "click," check and make sure that there is no gap between the foam padding and the goggles.

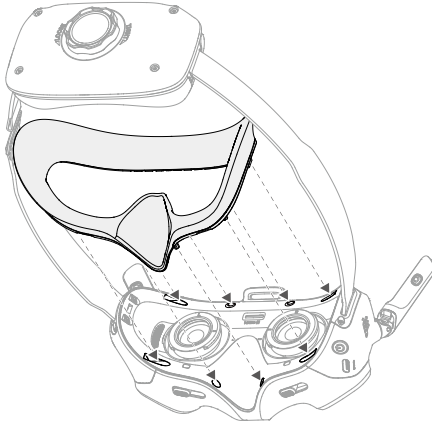

After-sales Information

Visit <https://www.dji.com/support> to learn more about after-sales service policies, repair services, and support.

Appendix

Specifications

DJI Goggles Integra

Model Number	RCDS13
Weight	Approx. 410 g (battery included)
Dimensions	With antennas folded: 170×104×75 mm With antennas unfolded: 205×104×104 mm
Screen Size (single screen)	0.49 in
Resolution (single screen)	1920×1080p
Refresh Rate	Up to 100 Hz
IPD Range	56-72 mm
FOV (single screen)	44°
Transmission	When used with different aircraft, the goggles will automatically select the corresponding firmware to match the transmission specification of the aircraft.
Operating Frequency	2.4000-2.4835 GHz 5.725-5.850 GHz ^[1]
Transmitter Power (EIRP)	2.4 GHz: <30 dBm (FCC), <20 dBm (CE/SRRC/MIC/KC) 5.8 GHz: <30 dBm (FCC), <23 dBm (SRRC), <14 dBm (CE/KC)
Transmission Latency ^[2]	1080p@100fps: as low as 30 ms 1080p@60fps: as low as 40 ms
Max Video Bitrate ^[3]	50 Mbps
Supported Video Recording Format	MOV
Supported Video Playback Format	MP4, MOV Video format: H.264, H.265 Audio format: AAC, PCM
Operating Temperature	-10° to 40° C (14° to 104° F)
Supported SD Cards	microSD Card, max 512 GB
Recommended microSD Cards	SanDisk Extreme® U3 V30 A1 32GB microSDXC™ SanDisk Extreme PRO U3 V30 A1 32GB microSDXC Lexar® Professional 1066x U3 V30 A2 64GB microSDXC Lexar Professional 1066x U3 V30 A2 128GB microSDXC Lexar Professional 1066x U3 V30 A2 256GB microSDXC Lexar Professional 1066x U3 V30 A2 512GB microSDXC Kingston® Canvas Go! Plus U3 V30 A2 64GB microSDXC Kingston Canvas Go! Plus U3 V30 A2 128GB microSDXC Kingston Canvas React Plus U3 V90 A1 64GB microSDXC Kingston Canvas React Plus U3 V90 A1 128GB microSDXC Kingston Canvas React Plus U3 V90 A1 256GB microSDXC Samsung® EVO Plus U3 V30 A2 512GB microSDXC
Integrated Battery Capacity	2450 mAh
Battery Voltage	5.6-8.4 V
Battery Type	Li-ion
Battery Chemical System	LiNiMnCoO2
Energy	17.64 Wh

Charging Temperature	5° to 45° C (41° to 113° F)
Operating Time	Approx. 2 hours (in flight)

DJI RC Motion 2

Model Number	RM220
Weight	Approx. 170 g
Operating Frequency	2.4000-2.4835 GHz 5.725-5.850 GHz ^[1]
Transmitter Power (EIRP)	2.4 GHz: <30 dBm (FCC), <20 dBm (CE/SRRC/MIC) 5.8 GHz: <30 dBm (FCC), <23 dBm (SRRC), <14 dBm (CE)
Operating Temperature	-10° to 40° C (14° to 104° F)
Operating Time	Approx 5 hours
Integrated Battery Type	Li-ion
Battery Chemical System	LiNiMnCoO2

[1] The 5.8 GHz frequency band is currently banned in certain countries or regions. For details, refer to local laws and regulations.

[2] Measured in an open outdoor environment without interference. Actual data varies with different aircraft models.

[3] Measured in an open outdoor environment without interference. Actual data varies with operating environment.

Supported Aircraft Models:

DJI Avata
 DJI Mavic 3 Pro / DJI Mavic 3 Pro Cine
 DJI Mavic 3 / DJI Mavic 3 Cine
 DJI Mavic 3 Classic
 DJI Mini 3 Pro

Low Blue Light Statement

Light from displays can cause eyestrain and retina damage which can affect vision over time. DJI Goggles Integra adopts micro-OLED eye-protection screens, which can effectively reduce the high-energy shortwave blue light and its emission range, therefore protecting users from exposure to harmful blue light. DJI Goggles Integra has obtained the Low Blue Light certification.

It is highly recommended to follow the instructions below to protect your eyes against prolonged display use:

- Look away from the screen and then at a distant place for 20 seconds every 20 minutes.
- Rest your eyes for 10 minutes after 2 hours of continuous use.
- Roll your eyes upward and then in a large circle every few hours.
- When your eyes get tired, try to blink at a normal rate, then close your eyes and rest for a minute.

WE ARE HERE FOR YOU



Contact
DJI SUPPORT

<https://www.dji.com/support>

This content is subject to change without notice.
Download the latest version from DJI website.



<https://www.dji.com/goggles-integra/downloads>

If you have any questions about this document, please contact DJI by sending a message to:
DocSupport@dji.com

DJI is a trademark of DJI.

Copyright © 2023 DJI All Rights Reserved.