

Latitude 3445 Chromebook

Owner's Manual

Notes, cautions, and warnings

 **NOTE:** A NOTE indicates important information that helps you make better use of your product.

 **CAUTION:** A CAUTION indicates either potential damage to hardware or loss of data and tells you how to avoid the problem.

 **WARNING:** A WARNING indicates a potential for property damage, personal injury, or death.

Chapter 1: Views of Latitude 3445 Chromebook.....	6
Right.....	6
Left.....	6
Top.....	7
Front.....	8
Bottom.....	9
Service Tag.....	9
Battery charge and status light	10
Chapter 2: Set up your Latitude 3445 Chromebook.....	11
Chapter 3: Specifications of Latitude 3445 Chromebook.....	12
Dimensions and weight.....	12
Processor.....	12
Chipset.....	13
Operating system.....	13
Memory.....	13
External ports.....	14
Internal slots.....	14
Wireless module.....	14
Audio.....	15
Storage.....	15
Media-card reader.....	16
Keyboard.....	16
Keyboard special keys.....	17
Camera.....	17
Touchpad.....	18
Power adapter.....	18
Battery.....	19
Display.....	20
Fingerprint reader (optional).....	21
GPU—Integrated.....	21
External display support.....	21
Hardware security.....	21
Operating and storage environment.....	22
Dell Support policy.....	22
Chapter 4: Working inside your computer.....	23
Safety instructions.....	23
Before working inside your computer.....	23
Safety precautions.....	24
Electrostatic discharge—ESD protection.....	24
ESD field service kit	25
Transporting sensitive components.....	26

After working inside your computer.....	26
Recommended tools.....	26
Screw list.....	26
Major components of Latitude 3445 Chromebook.....	27

Chapter 5: Removing and installing Customer Replaceable Units (CRUs)..... 30

Base cover.....	30
Removing the base cover.....	30
Installing the base cover.....	34
Solid-state drive.....	35
Removing the M.2 2230 solid-state drive.....	35
Installing the M.2 2230 solid-state drive.....	36
Wireless card.....	38
Removing the wireless card.....	38
Installing the wireless card.....	39
Fan.....	40
Removing the fan.....	40
Installing the fan.....	41

Chapter 6: Removing and installing Field Replaceable Units (FRUs)..... 42

Battery.....	42
Rechargeable Li-ion battery precautions.....	42
Removing the battery.....	42
Installing the battery.....	43
Battery cable.....	44
Removing the battery cable.....	44
Installing the battery cable.....	46
Heat sink.....	47
Removing the heat sink.....	47
Installing the heat sink.....	48
Display assembly.....	49
Removing the display assembly.....	49
Installing the display assembly.....	51
Speakers.....	52
Removing the speakers.....	52
Installing the speakers.....	53
Display bezel.....	55
Removing the display bezel.....	55
Installing the display bezel.....	58
Display hinges.....	61
Removing the display hinges.....	61
Installing the display hinges.....	62
Display panel.....	63
Removing the display panel.....	63
Installing the display panel.....	65
System board.....	66
Removing the system board.....	66
Installing the system board.....	69
Camera module.....	71

Removing the camera module.....	71
Installing the camera module.....	72
Display cable.....	74
Removing the display cable.....	74
Installing the display cable.....	75
Display back cover and antenna assembly.....	76
Removing the display back cover and antenna assembly.....	76
Installing the display back cover and antenna assembly.....	77
Palm-rest and keyboard assembly.....	78
Removing the palm-rest and keyboard assembly.....	78
Installing the palm-rest and keyboard assembly.....	79
Chapter 7: Software.....	81
Operating system.....	81
Operating system.....	81
ChromeOS.....	81
Verified Boot.....	82
Disk Partition Map.....	83
Developer and Recovery mode.....	84
Coreboot and U-boot Custom Firmware.....	84
Chrome vs Chromium operating system.....	84
View system information.....	85
Chapter 8: Troubleshooting.....	88
Handling swollen rechargeable Li-ion batteries.....	88
Chrome Shell (CROSH).....	88
Recovering the operating system.....	89
Wi-Fi power cycle.....	89
Drain residual flea power (perform hard reset).....	89
Chrome OS Pre-Boot Diagnostics	90
Chapter 9: Getting help and contacting Dell.....	92

Views of Latitude 3445 Chromebook

Right



1. microSD-card slot

Reads from and writes to the microSD-card. The computer supports the following card types:

- Micro Secure Digital (mSD)
- Micro Secure Digital High Capacity (mSDHC)
- Micro Secure Digital Extended Capacity (mSDXC)

2. USB 3.2 Gen 1 (Type-C) port with Power Delivery/DisplayPort

Connect devices such as external storage devices, printers, and external displays.

Supports Power Delivery that enables two-way power supply between devices. Provides up to 15 W power output that enables faster charging.

NOTE: A USB Type-C to DisplayPort adapter (sold separately) is required to connect a DisplayPort device.

3. Universal audio jack

Connect headphones or a headset (headphone and microphone combo).

4. Security-cable slot

Connect a security cable to prevent unauthorized movement of your computer.

Left



1. HDMI 2.0 port

Connect to a TV, external display, or another HDMI-in enabled device. Provides video and audio output.

2. USB 3.2 Gen 1 port with PowerShare

Connect devices such as external storage devices and printers.

Provides data transfer speeds up to 5 Gbps. PowerShare enables you to charge your USB devices even when your computer is turned off.

- NOTE:** If the charge on your computer's battery is less than 10 percent, you must connect the power adapter to charge your computer, and USB devices connected to the PowerShare port.
- NOTE:** If a USB device is connected to the PowerShare port before the computer is turned off or in hibernate state, you must disconnect and connect it again to enable charging.
- NOTE:** Certain USB devices may not charge when the computer is turned off or in sleep state. In such cases, turn on the computer to charge the device.

3. USB 3.2 Gen 1 (Type-C) port with Power Delivery/DisplayPort

Connect devices such as external storage devices, printers, and external displays.

Supports Power Delivery that enables two-way power supply between devices. Provides up to 15 W power output that enables faster charging.

- NOTE:** A USB Type-C to DisplayPort adapter (sold separately) is required to connect a DisplayPort device.

4. Power and battery-status light

Indicates the power state and battery state of the computer.

AC mode:

- Fully charged: Off
- Charging: White

DC mode:

- S0-S5: Off
- Battery low (S0/S3): Amber
- Battery low (S5): Off
- Battery error (S0-S5): Blinking Amber, 1 second on/1 second off

- NOTE:** On certain computer models, the power and battery-status light are also used for diagnostics. For more information, see the *Troubleshooting* section.

Top

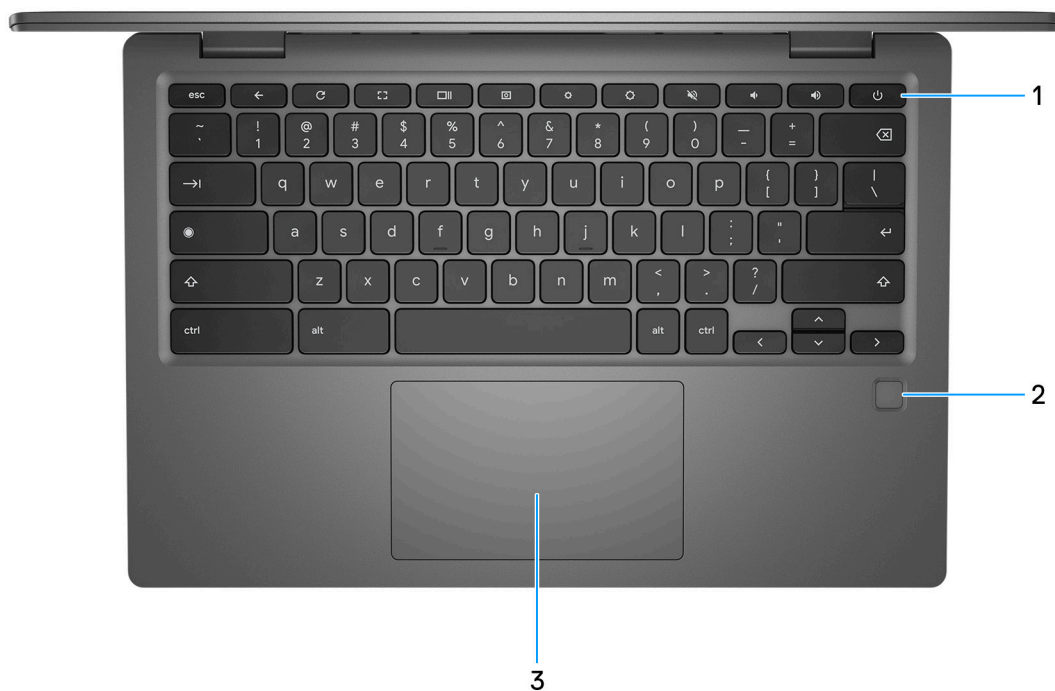

1. Power button

Press to turn on the computer if it is turned off, in sleep state, or in hibernate state.

When the computer is turned on, press the power button to put the computer into sleep state; press and hold the power button for 10 seconds to force shut-down the computer.

2. Fingerprint reader (optional)

Press your finger on the fingerprint reader to log in to your computer. The fingerprint reader enables your computer to recognize your fingerprints as a password.

NOTE: Configure the fingerprint reader to register your fingerprint and enable access.

3. Touchpad

Move your finger on the touchpad to move the mouse pointer. Tap to left-click and two fingers tap to right-click.

Front



1. Microphones (2)

Provide digital sound input for audio recording, voice calls, and so on.

2. Camera

Enables you to video chat, capture photos, and record videos.

3. Camera-status light

Turns on when the camera is in use.

Bottom

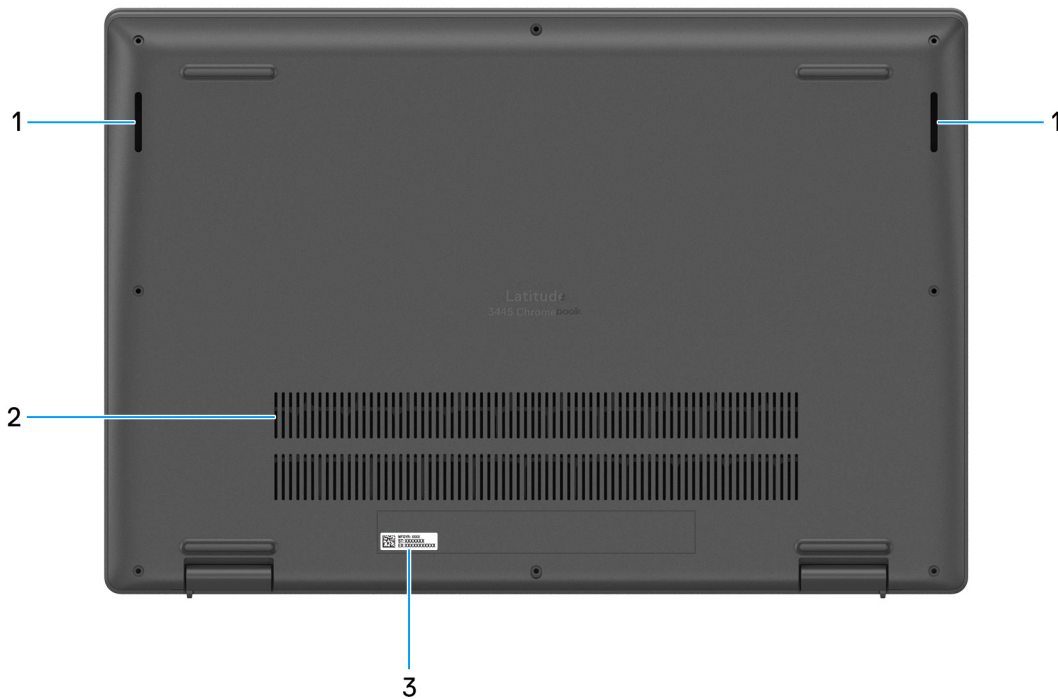

1. Speakers

Provide audio output.

2. Air vents

Air vents provide ventilation for your computer. Clogged air vents can cause overheating and can affect your computer's performance and potentially cause hardware issues. Keep the air vents clear of obstructions and clean them regularly to prevent build-up of dust and dirt. For more information about cleaning air vents, search for articles in Knowledge Base Resource at www.dell.com/support.

3. Service Tag label

The Service Tag is a unique alphanumeric identifier that enables Dell service technicians to identify the hardware components in your computer and access warranty information.

Service Tag

The service tag is a unique alphanumeric identifier that allows Dell service technicians to identify the hardware components in your computer and access warranty information.

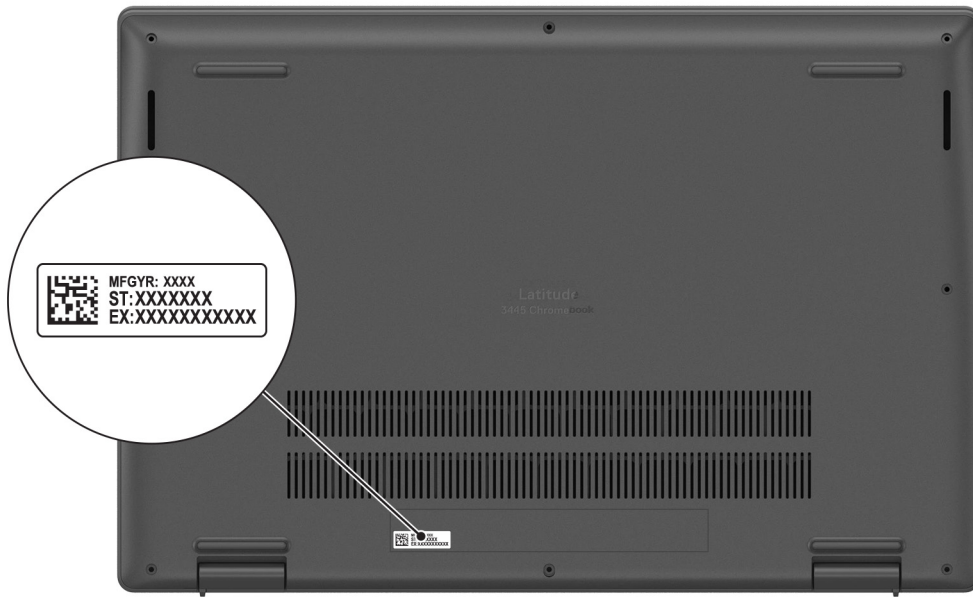

Battery charge and status light

The following table lists the battery charge and status light behavior of your Latitude 3445 Chromebook.

Table 1. Battery charge and status light behavior

Power Source	LED Behavior	System Power State	Battery Charge Level
AC Adapter	Off	S0 - S5	Fully Charged
AC Adapter	Solid White	S0 - S5	< Fully Charged
Battery	Off	S4, S5	< 10%
Battery	Off	S0 - S5	> 10%
Battery	Solid Amber (590+/-3 nm)	S0 - S3	< 10%

- S0 (ON) - System is turned on.
- S4 (Hibernate) - The system consumes the least power compared to all other sleep states. The system is almost at an OFF state, expect for a trickle power. The context data is written to hard drive.
- S5 (OFF) - The system is in a shutdown state.

Set up your Latitude 3445 Chromebook

About this task

NOTE: The images in this document may differ from your computer depending on the configuration you ordered.

Steps

1. Connect the power adapter and press the power button.



NOTE: To conserve battery power, the battery might enter power saving mode. Connect the power adapter and press the power button to turn on the computer.

2. Finish Chromebook operating system setup.
Follow the on-screen instructions to complete the setup. For more information about installing and configuring Chromebook, go to [Chrome OS Support](#).
3. Locate and install the required apps from the Google Chrome Web Store. For more information on downloading and installing apps on your Chromebook, search in the Knowledge Base Resource at www.dell.com/support.

Specifications of Latitude 3445 Chromebook

Dimensions and weight

The following table lists the height, width, depth, and weight of your Latitude 3445 Chromebook.

Table 2. Dimensions and weight

Description	Values
Height:	
Front height	18.62 mm (0.74 in.)
Rear height	20.20 mm (0.80 in.)
Width	323.67 mm (12.74 in.)
Depth	220.26 mm (8.68 in.)
Weight	1.53 kg (3.37 lb)
 NOTE: The weight of your computer depends on the configuration ordered and manufacturing variability.	

Processor

The following table lists the details of the processors supported by your Latitude 3445 Chromebook.

Table 3. Processor

Description	Option one	Option two	Option three	Option four
Processor type	AMD Ryzen 5 7520C	AMD Ryzen 3 7320C	AMD Athlon Gold 7220C	AMD Athlon Silver 7120C
Processor wattage	15 W	15 W	15 W	15 W
Processor core count	4	4	2	2
Processor thread count	8	8	4	2
Processor speed	Up to 4.30 GHz	Up to 4.10 GHz	Up to 3.70 GHz	Up to 3.50 GHz
Processor cache	6 MB	6 MB	5 MB	3 MB
Integrated graphics	AMD Radeon 610M Graphics	AMD Radeon 610M Graphics	AMD Radeon 610M Graphics	AMD Radeon 610M Graphics

Chipset

The following table lists the details of the chipset supported by your Latitude 3445 Chromebook.

Table 4. Chipset

Description	Values
Chipset	AMD Mendocino 15 W
Processor	<ul style="list-style-type: none">• AMD Ryzen 5 7520C• AMD Ryzen 3 7320C• AMD Athlon Gold 7220C• AMD Athlon Silver 7120C
DRAM bus width	64-bit
Flash EPROM	16 MB
PCIe bus	Up to Gen 4

Operating system

Your Latitude 3445 Chromebook supports the following operating systems:

- ChromeOS R112 and above

Memory

The following table lists the memory specifications of your Latitude 3445 Chromebook.

Table 5. Memory specifications

Description	Values
Memory slots	Integrated on system board  NOTE: Memory cannot be upgraded as it is integrated on the system board.
Memory type	<ul style="list-style-type: none">• Dual-channel LPDDR5• Dual-channel LPDDR5x
Memory speed	5200 MT/s
Maximum memory configuration	16 GB
Minimum memory configuration	4 GB
Memory configurations supported	<ul style="list-style-type: none">• 4 GB LPDDR5 at 5200 MT/s• 8 GB LPDDR5 at 5200 MT/s• 16 GB LPDDR5 at 5200 MT/s• 4 GB LPDDR5x at 5200 MT/s• 8 GB LPDDR5x at 5200 MT/s• 16 GB LPDDR5x at 5200 MT/s

External ports

The following table lists the external ports on your Latitude 3445 Chromebook.

Table 6. External ports

Description	Values
USB ports	<ul style="list-style-type: none">Two USB 3.2 Gen 1 (Type-C) ports with (Power Delivery and DisplayPort Alt Mode) <p>NOTE: You can connect a Dell Docking Station to this port. For more information, search in the Knowledge Base Resource at www.dell.com/support.</p> <ul style="list-style-type: none">One USB 3.2 Gen 1 port with PowerShare
Audio port	One Universal audio jack
Video port/ports	One HDMI 2.0 port
Media-card reader	One microSD-card slot
Power-adaptor port	Supported through USB-C
Security-cable slot	One security-cable slot (wedge-shaped)

Internal slots

The following table lists the internal slots of your Latitude 3445 Chromebook.

Table 7. Internal slots

Description	Values
M.2	<ul style="list-style-type: none">One M.2 2230 slot for WiFi and Bluetooth combo cardOne M.2 2230 slot for solid-state drive <p>NOTE: M.2 2230 slot for SSD is not available for models shipped with Intel Pentium and eMMC configuration.</p> <p>NOTE: To learn more about the features of different types of M.2 cards, search in the Knowledge Base Resource at www.dell.com/support.</p>

Wireless module

The following table lists the Wireless Local Area Network (WLAN) module that is supported on your Latitude 3445 Chromebook.

Table 8. Wireless module specifications

Description	Values
Model number	MediaTek MT7921
Transfer rate	Up to 1200 Mbps
Frequency bands supported	2.4 GHz/5 GHz
Wireless standards	<ul style="list-style-type: none">Wi-Fi 802.11a/b/g

Table 8. Wireless module specifications (continued)

Description	Values
	<ul style="list-style-type: none"> • Wi-Fi 4 (WiFi 802.11n) • Wi-Fi 5 (WiFi 802.11ac) • Wi-Fi 6 (WiFi 802.11ax)
Encryption	<ul style="list-style-type: none"> • 64-bit/128-bit WEP • AES-CCMP • TKIP
Bluetooth wireless card	Bluetooth 5.3
	 NOTE: The version of the Bluetooth wireless card may vary depending on the operating system that is installed on your computer.

Audio

The following table lists the audio specifications of your Latitude 3445 Chromebook.

Table 9. Audio specifications

Description	Values	
Audio controller	ALC5682I	
Stereo conversion	Not supported	
Internal audio interface	High definition audio interface	
External audio interface	Universal headset jack	
Number of speakers	2	
Internal-speaker amplifier	Supported	
External volume controls	Keyboard shortcut controls	
Speaker output:		
	Average speaker output	2 W
	Peak speaker output	2 W
Subwoofer output	Not supported	
Microphone	Digital-array microphones in camera assembly	

Storage

This section lists the storage options on your Latitude 3445 Chromebook.

Your Latitude 3445 Chromebook supports one of the following storage configurations:

- M.2 2230 solid-state drive
- eMMC onboard

Table 10. Storage specifications

Storage type	Interface type	Capacity
M.2 2230 solid-state drive	PCIe NVMe Gen3 x2	256 GB
eMMC onboard	eMMC 5.1	Up to 128 GB

Media-card reader

The following table lists the media cards supported by your Latitude 3445 Chromebook.

Table 11. Media-card reader specifications

Description	Values
Media-card type	microSD-card slot
Media-cards supported	<ul style="list-style-type: none">• Micro Secure Digital (mSD)• Micro Secure Digital High Capacity (mSDHC)• Micro Secure Digital Extended Capacity (mSDXC)
 NOTE: The maximum capacity supported by the media-card reader varies depending on the standard of the media card installed in your computer.	

Keyboard

The following table lists the keyboard specifications of your Latitude 3445 Chromebook.

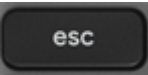

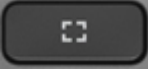







Table 12. Keyboard specifications

Description	Values
Keyboard type	<ul style="list-style-type: none">• Standard backlit keyboard• Standard non-backlit keyboard
Keyboard layout	QWERTY
Number of keys	Non-backlit keyboard: <ul style="list-style-type: none">• English International and English US: 74 keys• English UK and Canada Bilingual (MUI): 75 keys Backlit keyboard: <ul style="list-style-type: none">• English International, English US, Korean, and Thai: 74 keys• English UK, Canada Bilingual (MUI), Belgium-Azerty, French European, German, Italian, Nordic (MUI), Spanish (Castilian), and Spanish (Latin America): 75 keys• Japanese: 78 keys
Keyboard size	X=19 mm key pitch Y=19 mm key pitch
Keyboard shortcuts	The Chrome device keyboard is designed to help you get to the things you need the most.

Keyboard special keys

The Chrome device keyboard is designed to help you get to the things you need the most. The following table is an overview of the special keys on the top row of the keyboard.

Table 13. Keyboard special keys

Special keys	
	Close the pop-up window or dialog box
	Go to the previous page in browser history
	Reload current page
	View the full screen
	Enter Overview mode to show all windows
	Take screenshot
	Decrease screen brightness
	Increase screen brightness
	Mute the speaker
	Decrease the speaker volume
	Increase the speaker volume
	Turn on your Chromebook

Camera

The following table lists the camera specifications of your Latitude 3445 Chromebook.

Table 14. Camera specifications

Description	Values
Number of cameras	One

Table 14. Camera specifications (continued)

Description		Values
Camera type		<ul style="list-style-type: none"> • HD RGB camera • FHD RGB camera
Camera location		Front camera
Camera sensor type		CMOS sensor technology
Camera resolution:		
	Still image	<ul style="list-style-type: none"> • HD RGB camera: 0.92 megapixels • FHD RGB camera: 2.07 megapixels
	Video	<ul style="list-style-type: none"> • HD RGB camera: 1280 x 720 at 30 fps • FHD RGB camera: 1920 x 1080 at 30 fps
Diagonal viewing angle:		<ul style="list-style-type: none"> • HD RGB camera: 78.60 degrees • FHD RGB camera: 82 degrees

Touchpad

The following table lists the touchpad specifications of your Latitude 3445 Chromebook.

Table 15. Touchpad specifications

Description		Values
Touchpad resolution:		>300 DPI
Touchpad dimensions:		
	Horizontal	115 mm (4.53 in.)
	Vertical	70 mm (2.76 in.)
Touchpad gestures		For more information about touchpad gestures available on Chromebook, see support.google.com/chromebook .

Power adapter

The following table lists the power adapter specifications of your Latitude 3445 Chromebook.

Table 16. Power adapter specifications

Description		Values
Type		65 W adapter USB-C
Power-adapter dimensions:		
	Height	28 mm (1.10 in.)
	Width	51 mm (2.01 in.)
	Depth	112 mm (4.41 in.)
Input voltage		100 VAC to 240 VAC

Table 16. Power adapter specifications (continued)

Description		Values
Input frequency		50 Hz to 60 Hz
Input current (maximum)		1.70 A
Output current (continuous)		<ul style="list-style-type: none"> • 20 V/3.25 A (continuous) • 15 V/3 A (continuous) • 9 V/3 A (continuous) • 5 V/3 A (continuous)
Rated output voltage		<ul style="list-style-type: none"> • 20 VDC • 15 VDC • 9 VDC • 5 VDC
Temperature range:		
	Operating	0°C to 40°C (32°F to 104°F)
	Storage	-40°C to 70°C (-40°F to 158°F)
 CAUTION: Operating and storage temperature ranges may differ among components, so operating or storing the device outside these ranges may impact the performance of specific components.		

Battery

The following table lists the battery specifications of your Latitude 3445 Chromebook.

Table 17. Battery specifications

Description		Values
Battery type		54 Wh 4-cell polymer battery
Battery voltage		15 VDC
Battery weight (maximum)		0.24 kg (0.52 lb)
Battery dimensions:		
	Height	5.75 mm (0.23 in.)
	Width	271.90 mm (10.70 in.)
	Depth	82 mm (3.23 in.)
Temperature range:		
	Operating	0°C to 60°C (32°F to 140°F)
	Storage	-20°C to 60°C (-4°F to 140°F)
Battery operating time		Varies depending on operating conditions and can significantly reduce under certain power-intensive conditions.
Battery charging time (approximate)		<ul style="list-style-type: none"> • 0°C to 15°C—4 hours (when the computer is off) • 16°C to 45°C—2 hours (when the computer is off) • 46°C to 50°C—3 hours (when the computer is off)

Table 17. Battery specifications (continued)

Description	Values
Coin-cell battery	Not applicable
<p>⚠ CAUTION: Operating and storage temperature ranges may differ among components, so operating or storing the device outside these ranges may impact the performance of specific components.</p> <p>⚠ CAUTION: Dell recommends that you charge the battery regularly for optimal power consumption. If your battery charge is completely depleted, connect the power adapter, turn on your computer, and then restart your computer to reduce the power consumption.</p>	

Display

The following table lists the display specifications of your Latitude 3445 Chromebook.

Table 18. Display specifications

Description	Option one	Option two	Option three
Display type	14-inch, High Definition (HD+)	14-inch, Full High Definition (FHD+)	14-inch, Full High Definition (FHD+)
Touch options	Yes	Yes	No
Display-panel technology	Twisted Nematic	In-Plane Switching (IPS)	Wide Viewing Angle (WVA)
Display-panel dimensions (active area):			
Height	309.39 mm	309.37 mm	3097 mm
Width	173.95 mm	174.02 mm	174.02 mm
Diagonal	354.95 mm	354.95 mm	354.95 mm
Display-panel native resolution	1366 x 768	1920 x 1200	1920 x 1200
Luminance (typical)	220 nits	220 nits	250 nits
Megapixels	1.049	2.304	2.304
Color gamut	45% (NTSC)	45% (NTSC)	72% (NTSC)
Pixels Per Inch (PPI)	112	157	157
Contrast ratio (typical)	400:1	700:1	700:1
Response time (max)	35 ms	35 ms	35 ms
Refresh rate	60 Hz	60 Hz	60 Hz
Horizontal view angle	+/- 85 degrees	+/- 85 degrees	+/- 85 degrees
Vertical view angle	+/- 85 degrees	+/- 85 degrees	+/- 85 degrees
Pixel pitch	0.2331 x 0.2331 mm	0.161 x 0.161 mm	0.161 x 0.161 mm
Power consumption (maximum)	108.78 W	3.10 W	4.30 W

Table 18. Display specifications (continued)

Description	Option one	Option two	Option three
Anti-glare vs glossy finish	Anti-glare	Anti-glare	Anti-glare

Fingerprint reader (optional)

The following table lists the specifications of the optional fingerprint-reader of your Latitude 3445 Chromebook.

Table 19. Fingerprint reader specifications

Description	Values
Fingerprint-reader sensor technology	Capacitive
Fingerprint-reader sensor resolution	508 dpi
Fingerprint-reader sensor pixel size	160 x 160 pixels

GPU—Integrated

The following table lists the specifications of the integrated Graphics Processing Unit (GPU) supported by your Latitude 3445 Chromebook.

Table 20. GPU—Integrated

Controller	Memory size	Processor
AMD Radeon 610M Graphics	Shared system memory	<ul style="list-style-type: none">• AMD Ryzen 5 7520C• AMD Ryzen 3 7320C• AMD Athlon Gold 7220C• AMD Athlon Silver 7120C

External display support

The following table lists the external display support for your Latitude 3445 Chromebook.

Table 21. External display support

Graphics card	Supported external displays with laptop display enabled	Supported external displays with laptop display disabled
AMD Radeon 610M Graphics	3	4

Hardware security

The following table lists the hardware security of your Latitude 3445 Chromebook.

Table 22. Hardware security

Hardware security
Hardware security IC (H1B3C)
One wedge-shaped lock slot
Fingerprint reader (optional)

Table 22. Hardware security (continued)

Hardware security
Statement of Non-Volatility

Operating and storage environment

This table lists the operating and storage specifications of your Latitude 3445 Chromebook.

Airborne contaminant level: G1 as defined by ISA-S71.04-1985

Table 23. Computer environment

Description	Operating	Storage
Temperature range	-29°C to 63°C (-20.20°F to 145.40°F)	-51°C to 71°C (-59.80°F to 159.80°F)
Relative humidity (maximum)	10% to 90% (non-condensing)	5% to 95% (non-condensing)
Vibration (maximum)*	0.20 GRMS	1.37 GRMS
Shock (maximum)	40 G†	30 G†
Altitude range	-15.2 m to 3048 m (-49.87 ft to 10000 ft)	-15.2 m to 10668 m (-49.87 ft to 35000 ft)

CAUTION: Operating and storage temperature ranges may differ among components, so operating or storing the device outside these ranges may impact the performance of specific components.

* Measured using a random vibration spectrum that simulates user environment.

† Measured using a 2 ms half-sine pulse.











Dell Support policy

For information on Dell support policy, search in the Knowledge Base Resource at www.dell.com/support.

Working inside your computer

Safety instructions

Use the following safety guidelines to protect your computer from potential damage and to ensure your personal safety. Unless otherwise noted, each procedure included in this document assumes that you have read the safety information that shipped with your computer.

-  **WARNING:** Before working inside your computer, read the safety information that is shipped with your computer. For more safety best practices, see the Regulatory Compliance home page at www.dell.com/regulatory_compliance.
-  **WARNING:** Disconnect your computer from all power sources before opening the computer cover or panels. After you finish working inside the computer, replace all covers, panels, and screws before connecting your computer to an electrical outlet.
-  **CAUTION:** To avoid damaging the computer, ensure that the work surface is flat, dry, and clean.
-  **CAUTION:** To avoid damaging the components and cards, handle them by their edges, and avoid touching the pins and the contacts.
-  **CAUTION:** You should only perform troubleshooting and repairs as authorized or directed by the Dell technical assistance team. Damage due to servicing that is not authorized by Dell is not covered by your warranty. See the safety instructions that is shipped with the product or at www.dell.com/regulatory_compliance.
-  **CAUTION:** Before touching anything inside your computer, ground yourself by touching an unpainted metal surface, such as the metal at the back of the computer. While you work, periodically touch an unpainted metal surface to dissipate static electricity which could harm internal components.
-  **CAUTION:** When you disconnect a cable, pull it by its connector or its pull tab, not the cable itself. Some cables have connectors with locking tabs or thumbscrews that you must disengage before disconnecting the cable. When disconnecting cables, keep them evenly aligned to avoid bending the connector pins. When connecting cables, ensure that the ports and the connectors are correctly oriented and aligned.
-  **CAUTION:** Press and eject any installed card from the media-card reader.
-  **CAUTION:** Exercise caution when handling rechargeable Li-ion batteries in laptops. Swollen batteries should not be used and should be replaced and disposed properly.
-  **NOTE:** The color of your computer and certain components may appear differently than shown in this document.

Before working inside your computer

About this task

-  **NOTE:** The images in this document may differ from your computer depending on the configuration you ordered.

Steps

1. Save and close all open files and exit all open applications.
2. Shut down your computer. For Windows operating system, click **Start** >  **Power** > **Shut down**.

 **NOTE:** If you are using a different operating system, see the documentation of your operating system for shut-down instructions.

3. Disconnect your computer and all attached devices from their electrical outlets.
4. Disconnect all attached network devices and peripherals, such as keyboard, mouse, and monitor from your computer.

 **CAUTION:** To disconnect a network cable, first unplug the cable from your computer and then unplug the cable from the network device.

5. Remove any media card and optical disc from your computer, if applicable.

Safety precautions

The safety precautions chapter details the primary steps to be taken before performing any disassembly instructions.

Observe the following safety precautions before you perform any installation or break/fix procedures involving disassembly or reassembly:

- Turn off the system and all attached peripherals.
- Disconnect the system and all attached peripherals from AC power.
- Disconnect all network cables, telephone, and telecommunications lines from the system.
- Use an ESD field service kit when working inside any to avoid electrostatic discharge (ESD) damage.
- After removing any system component, carefully place the removed component on an anti-static mat.
- Wear shoes with non-conductive rubber soles to reduce the chance of getting electrocuted.

Standby power

Dell products with standby power must be unplugged before you open the case. Systems that incorporate standby power are essentially powered while turned off. The internal power enables the system to be remotely turned on (wake on LAN) and suspended into a sleep mode and has other advanced power management features.

Unplugging, pressing, and holding the power button for 15 seconds should discharge residual power in the system board.

Bonding

Bonding is a method for connecting two or more grounding conductors to the same electrical potential. This is done through the use of a field service electrostatic discharge (ESD) kit. When connecting a bonding wire, ensure that it is connected to bare metal and never to a painted or non-metal surface. The wrist strap should be secure and in full contact with your skin, and ensure that you remove all jewelry such as watches, bracelets, or rings prior to bonding yourself and the equipment.

Electrostatic discharge—ESD protection

ESD is a major concern when you handle electronic components, especially sensitive components such as expansion cards, processors, memory DIMMs, and system boards. Very slight charges can damage circuits in ways that may not be obvious, such as intermittent problems or a shortened product life span. As the industry pushes for lower power requirements and increased density, ESD protection is an increasing concern.

Due to the increased density of semiconductors used in recent Dell products, the sensitivity to static damage is now higher than in previous Dell products. For this reason, some previously approved methods of handling parts are no longer applicable.

Two recognized types of ESD damage are catastrophic and intermittent failures.

- **Catastrophic** – Catastrophic failures represent approximately 20 percent of ESD-related failures. The damage causes an immediate and complete loss of device functionality. An example of catastrophic failure is a memory DIMM that has received a static shock and immediately generates a "No POST/No Video" symptom with a beep code emitted for missing or nonfunctional memory.
- **Intermittent** – Intermittent failures represent approximately 80 percent of ESD-related failures. The high rate of intermittent failures means that most of the time when damage occurs, it is not immediately recognizable. The DIMM receives a static shock, but the tracing is merely weakened and does not immediately produce outward symptoms related to the damage. The weakened trace may take weeks or months to melt, and in the meantime may cause degradation of memory integrity, intermittent memory errors, etc.

The more difficult type of damage to recognize and troubleshoot is the intermittent (also called latent or "walking wounded") failure.

Perform the following steps to prevent ESD damage:

- Use a wired ESD wrist strap that is properly grounded. The use of wireless anti-static straps is no longer allowed; they do not provide adequate protection. Touching the chassis before handling parts does not ensure adequate ESD protection on parts with increased sensitivity to ESD damage.
- Handle all static-sensitive components in a static-safe area. If possible, use anti-static floor pads and workbench pads.
- When unpacking a static-sensitive component from its shipping carton, do not remove the component from the anti-static packing material until you are ready to install the component. Before unwrapping the anti-static packaging, ensure that you discharge static electricity from your body.
- Before transporting a static-sensitive component, place it in an anti-static container or packaging.

ESD field service kit

The unmonitored Field Service kit is the most commonly used service kit. Each Field Service kit includes three main components: anti-static mat, wrist strap, and bonding wire.

Components of an ESD field service kit

The components of an ESD field service kit are:

- **Anti-Static Mat** – The anti-static mat is dissipative and parts can be placed on it during service procedures. When using an anti-static mat, your wrist strap should be snug and the bonding wire should be connected to the mat and to any bare metal on the system being worked on. Once deployed properly, service parts can be removed from the ESD bag and placed directly on the mat. ESD-sensitive items are safe in your hand, on the ESD mat, in the system, or inside a bag.
- **Wrist Strap and Bonding Wire** – The wrist strap and bonding wire can be either directly connected between your wrist and bare metal on the hardware if the ESD mat is not required, or connected to the anti-static mat to protect hardware that is temporarily placed on the mat. The physical connection of the wrist strap and bonding wire between your skin, the ESD mat, and the hardware is known as bonding. Use only Field Service kits with a wrist strap, mat, and bonding wire. Never use wireless wrist straps. Always be aware that the internal wires of a wrist strap are prone to damage from normal wear and tear, and must be checked regularly with a wrist strap tester in order to avoid accidental ESD hardware damage. It is recommended to test the wrist strap and bonding wire at least once per week.
- **ESD Wrist Strap Tester** – The wires inside of an ESD strap are prone to damage over time. When using an unmonitored kit, it is a best practice to regularly test the strap prior to each service call, and at a minimum, test once per week. A wrist strap tester is the best method for doing this test. If you do not have your own wrist strap tester, check with your regional office to find out if they have one. To perform the test, plug the wrist-strap's bonding-wire into the tester while it is strapped to your wrist and push the button to test. A green LED is lit if the test is successful; a red LED is lit and an alarm sounds if the test fails.
- **Insulator Elements** – It is critical to keep ESD sensitive devices, such as plastic heat sink casings, away from internal parts that are insulators and often highly charged.
- **Working Environment** – Before deploying the ESD Field Service kit, assess the situation at the customer location. For example, deploying the kit for a server environment is different than for a desktop or portable environment. Servers are typically installed in a rack within a data center; desktops or portables are typically placed on office desks or cubicles. Always look for a large open flat work area that is free of clutter and large enough to deploy the ESD kit with additional space to accommodate the type of system that is being repaired. The workspace should also be free of insulators that can cause an ESD event. On the work area, insulators such as Styrofoam and other plastics should always be moved at least 12 inches or 30 centimeters away from sensitive parts before physically handling any hardware components.
- **ESD Packaging** – All ESD-sensitive devices must be shipped and received in static-safe packaging. Metal, static-shielded bags are preferred. However, you should always return the damaged part using the same ESD bag and packaging that the new part arrived in. The ESD bag should be folded over and taped shut and all the same foam packing material should be used in the original box that the new part arrived in. ESD-sensitive devices should be removed from packaging only at an ESD-protected work surface, and parts should never be placed on top of the ESD bag because only the inside of the bag is shielded. Always place parts in your hand, on the ESD mat, in the system, or inside an anti-static bag.
- **Transporting Sensitive Components** – When transporting ESD sensitive components such as replacement parts or parts to be returned to Dell, it is critical to place these parts in anti-static bags for safe transport.

ESD protection summary

It is recommended to use the traditional wired ESD grounding wrist strap and protective anti-static mat at all times when servicing Dell products. In addition, it is critical to keep sensitive parts separate from all insulator parts while performing service and that they use anti-static bags for transporting sensitive components.

Transporting sensitive components

When transporting ESD sensitive components such as replacement parts or parts to be returned to Dell, it is critical to place these parts in anti-static bags for safe transport.

After working inside your computer

About this task

NOTE: Leaving stray or loose screws inside your computer may severely damage your computer.

Steps

1. Replace all screws and ensure that no stray screws remain inside your computer.
2. Connect any external devices, peripherals, or cables you removed before working on your computer.
3. Replace any media cards, discs, or any other parts that you removed before working on your computer.
4. Connect your computer and all attached devices to their electrical outlets.
5. Turn on your computer.

Recommended tools

The procedures in this document may require the following tools:

- Phillips screwdriver #0
- Phillips screwdriver #1
- Plastic scribe

Screw list

NOTE: When removing screws from a component, it is recommended to note the screw type, the quantity of screws, and then place them in a screw storage box. This is to ensure that the correct number of screws and correct screw type is restored when the component is replaced.

NOTE: Some computers have magnetic surfaces. Ensure that the screws are not left attached to such surfaces when replacing a component.

NOTE: Screw color may vary with the configuration ordered.

Table 24. Screw list











Component	Screw type	Quantity	Screw image
Battery	M2x3	5	
M.2 2230 solid-state drive thermal shield	M2x3	1	
Wireless-card bracket	M2x3	1	

Table 24. Screw list (continued)

Component	Screw type	Quantity	Screw image
Fan	M2x3	2	
Display assembly	M2.5x3.8	6	
Left-display hinge	M2.5x3.8	3	
Right-display hinge	M2.5x3.8	3	
Display panel	M2x2	2	
System board	M2x3	3	
	M2x1.7	1	
	M2x3.5	2	

Major components of Latitude 3445 Chromebook

The following image shows the major components of Latitude 3445 Chromebook.

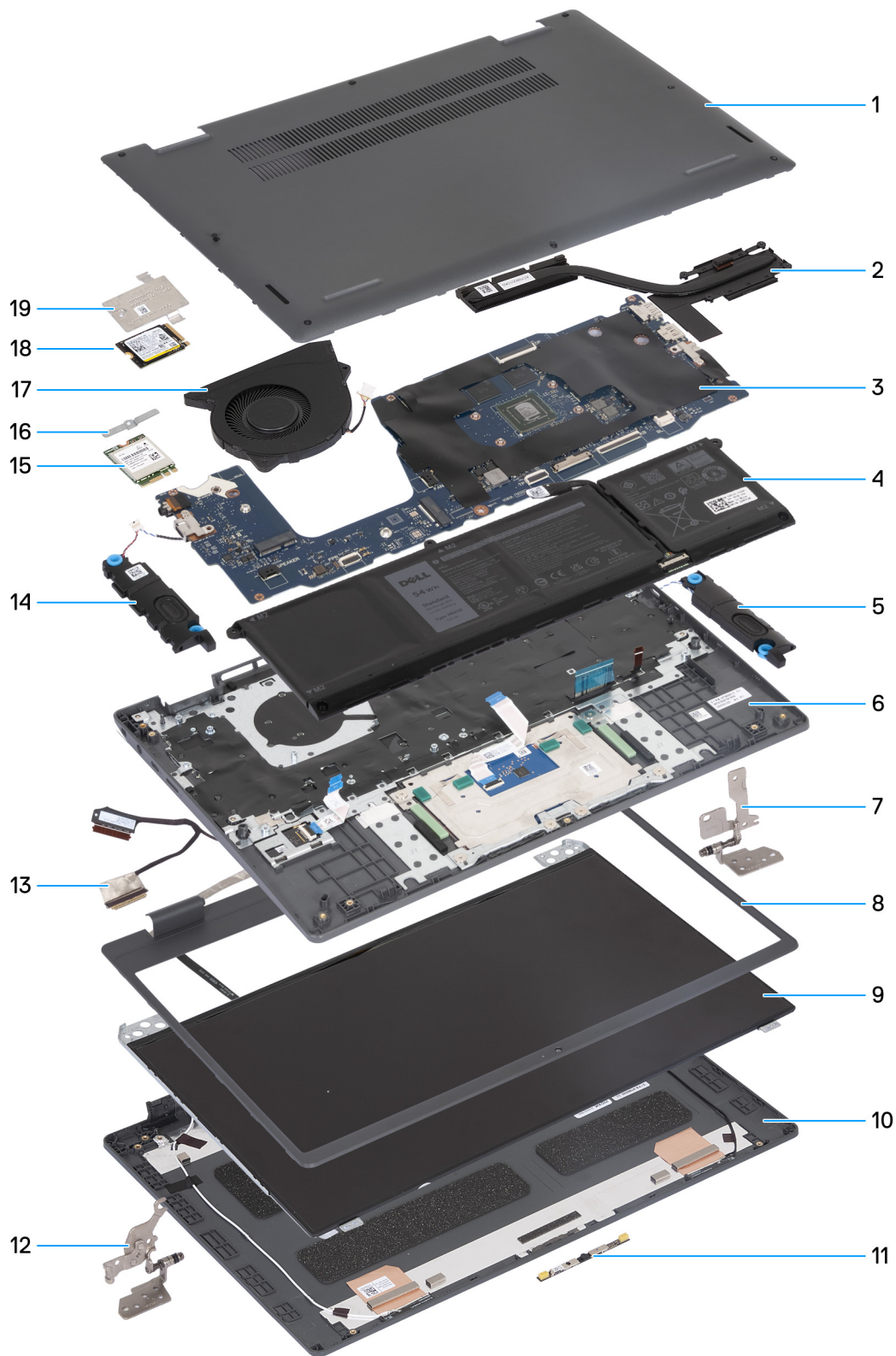

- | | |
|-------------------|---|
| 1. Base cover | 2. Heat sink |
| 3. System board | 4. Battery |
| 5. Left speaker | 6. Palm-rest and keyboard assembly |
| 7. Left hinge | 8. Display bezel |
| 9. Display panel | 10. Display back cover and antenna assembly |
| 11. Camera module | 12. Right hinge |

- 13. Display cable
- 15. Wireless card
- 17. Fan
- 19. Solid-state drive shield

- 14. Right speaker
- 16. Wireless-card bracket
- 18. M.2 2230 solid-state drive

 **NOTE:** Dell provides a list of components and their part numbers for the original system configuration purchased. These parts are available according to warranty coverages purchased by the customer. Contact your Dell sales representative for purchase options.

Removing and installing Customer Replaceable Units (CRUs)

The replaceable components in this chapter are Customer Replaceable Units (CRUs).

 **CAUTION:** Customers can replace only the Customer Replaceable Units (CRUs) following the safety precautions and replacement procedures.

 **NOTE:** The images in this document may differ from your computer depending on the configuration you ordered.

Base cover

Removing the base cover

Prerequisites

1. Follow the procedure in [Before working inside your computer](#).

About this task

The following images indicate the location of the base cover and provide a visual representation of the removal procedure.



8x



Figure 1. Removing the base cover

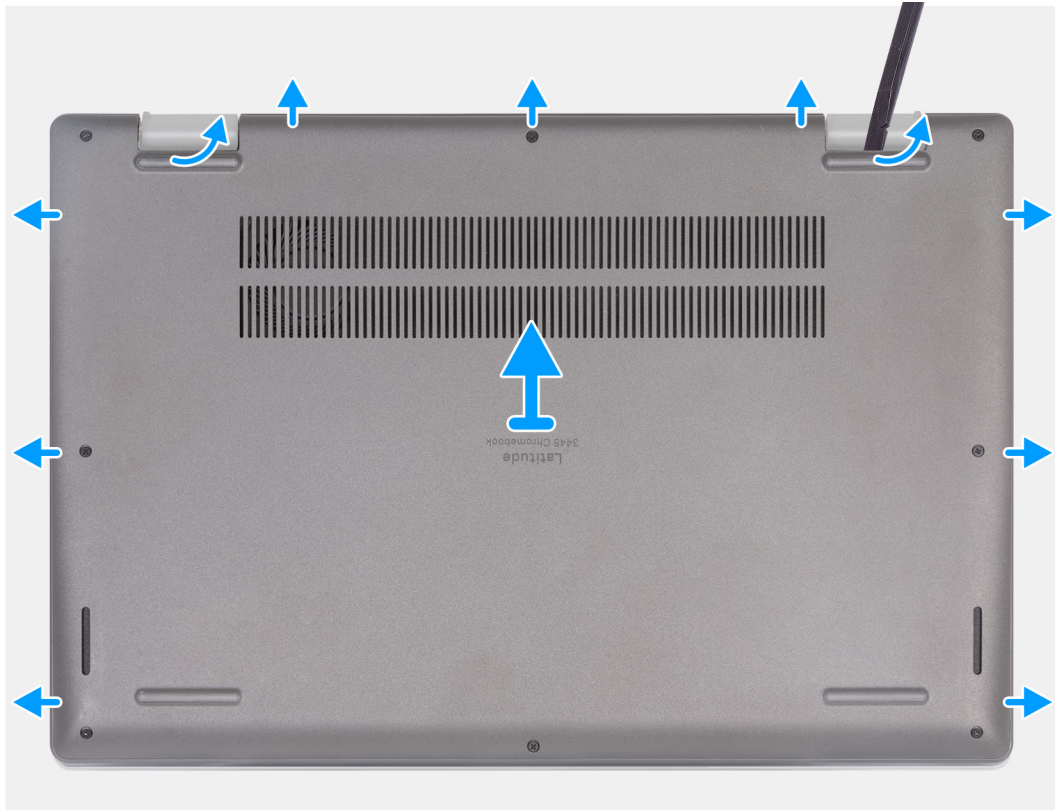

Figure 2. Removing the base cover

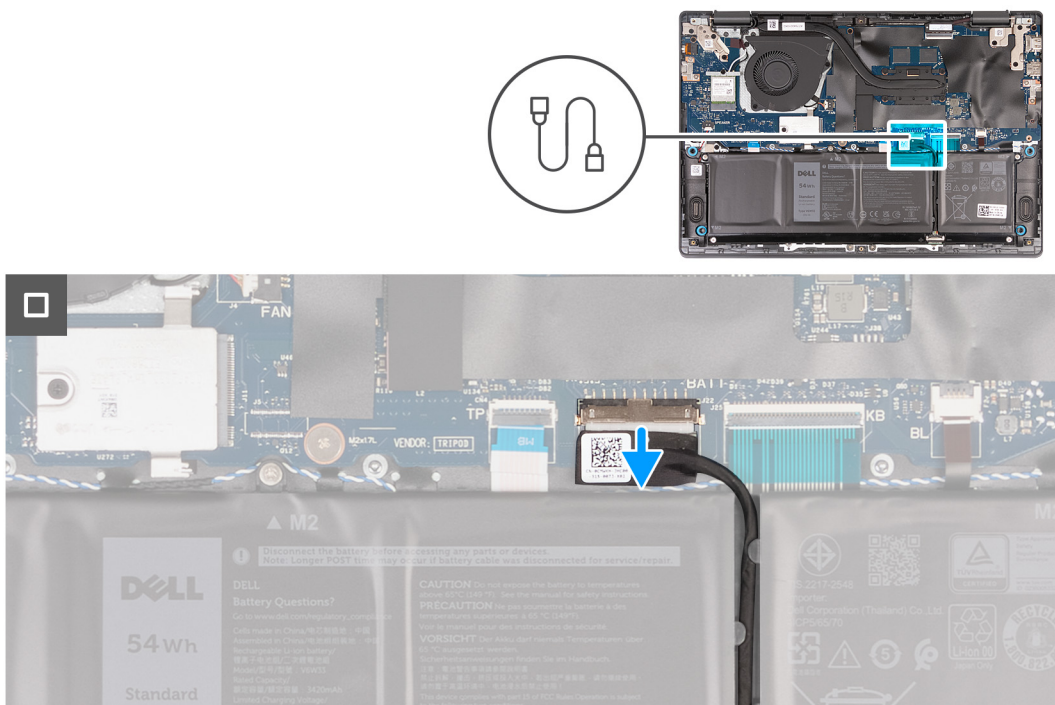

Figure 3. Removing the base cover

Steps

1. Loosen the eight captive screws that secure the base cover to the palm-rest and keyboard assembly.
2. Using a plastic scribe, pry the base cover from the U-shaped indents at the top and continue working on the sides to open the base cover.



Figure 4. Removing the base cover

Then continue on by prying the top side and then the left and right sides of the base cover in order to remove it from the computer.



Figure 5. Removing the base cover

3. Lift and remove the base cover off the palm-rest and keyboard assembly.
4. Disconnect the battery cable from the system board.
5. Press and hold the power button for five seconds to ground the computer and drain the flea power.

Installing the base cover

About this task

The following images indicate the location of the base cover and provide a visual representation of the installation procedure.

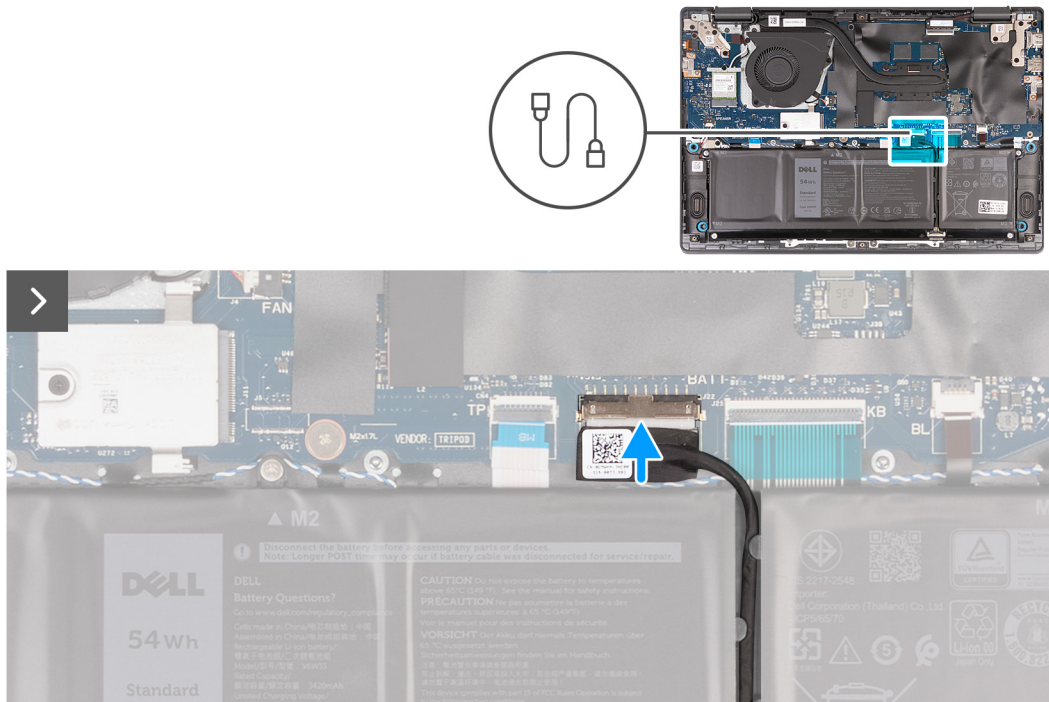

Figure 6. Installing the base cover

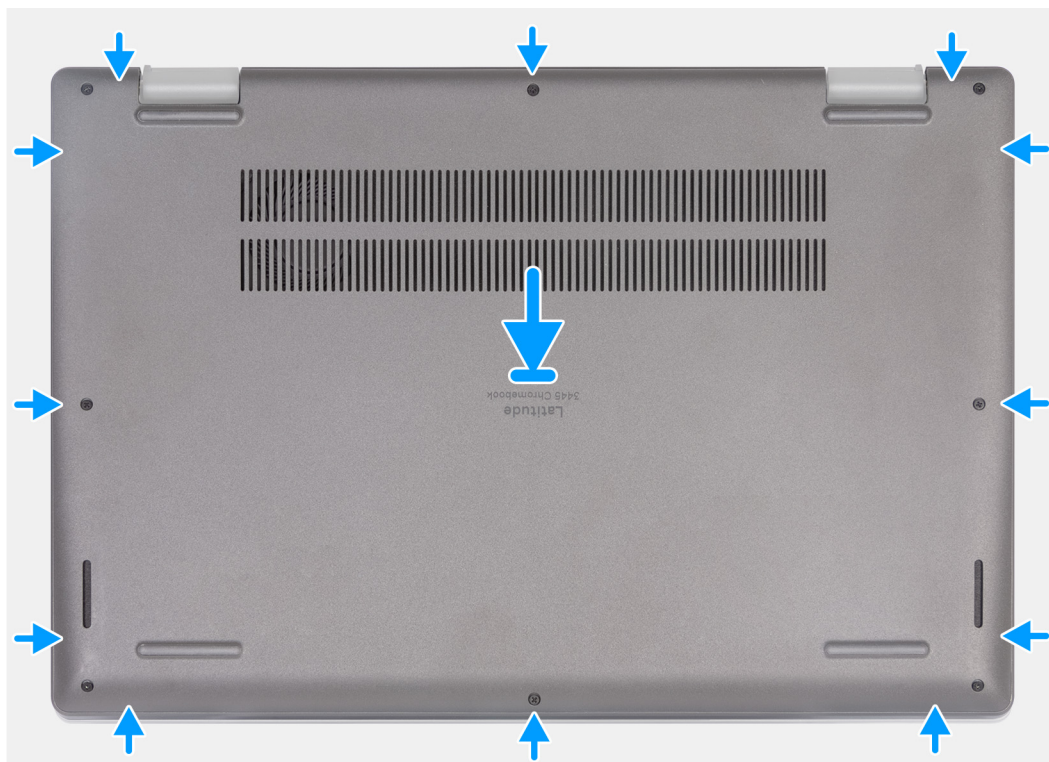

Figure 7. Installing the base cover



Figure 8. Installing the base cover

Steps

1. Connect the battery cable to the system board.
2. Place the base cover on top of the palm-rest and keyboard assembly.
3. Align the screw holes on the base cover with the screw holes on the palm-rest and keyboard assembly. Snap the base cover till it latches into place.
4. Tighten the eight captive screws to secure the base cover to the palm-rest and keyboard assembly.

Next steps

1. Follow the procedure in [After working inside your computer](#).

Solid-state drive

Removing the M.2 2230 solid-state drive

Prerequisites

1. Follow the procedure in [Before working inside your computer](#).
 - NOTE:** Solid-state drives are fragile. Exercise care when handling the solid-state drive.
 - NOTE:** To avoid data loss, do not remove the solid-state drive while the computer is in sleep or on state.

2. Remove the [base cover](#).

About this task

The following image indicates the location of the M.2 2230 solid-state drive and provides a visual representation of the removal procedure.

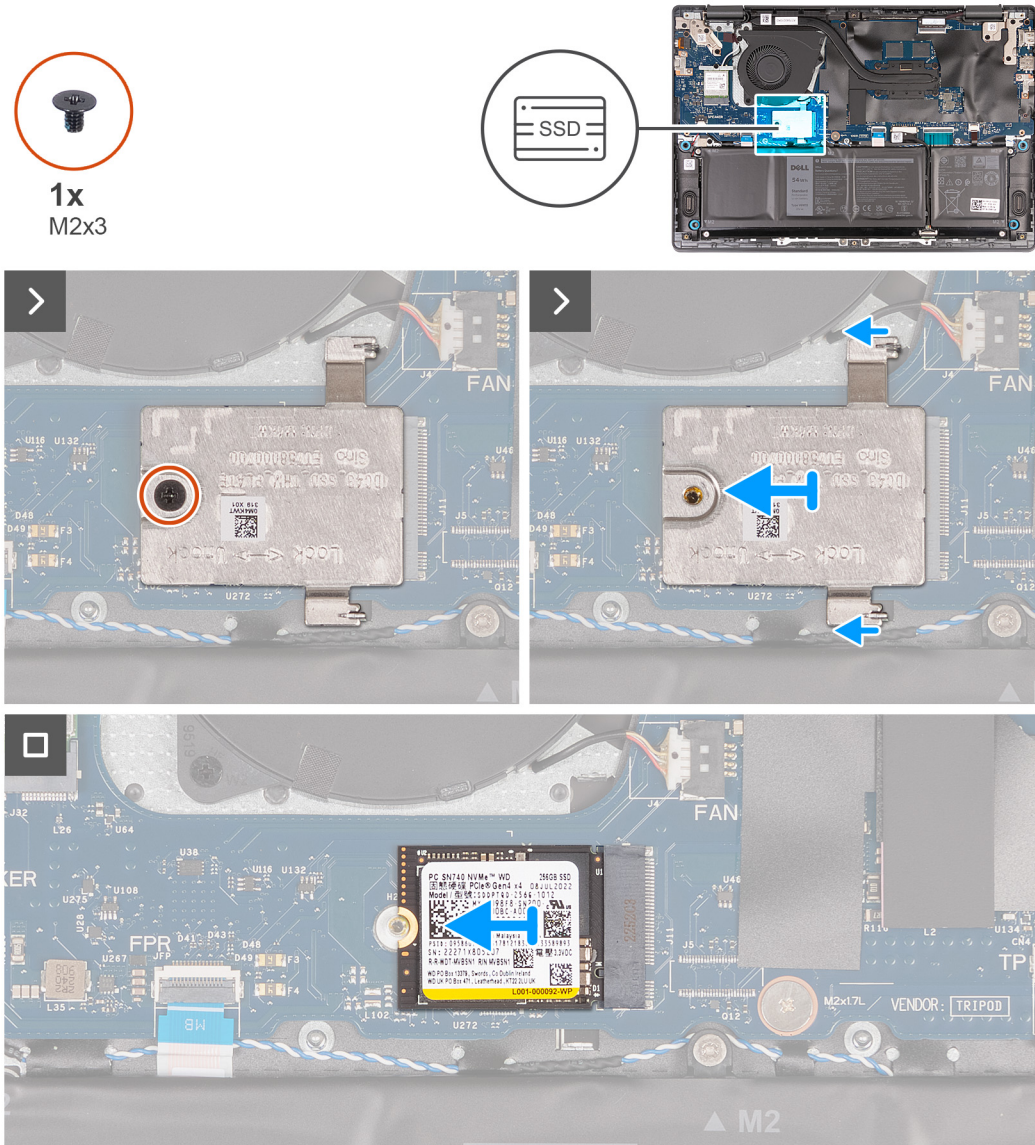

Figure 9. Removing the M.2 2230 solid-state drive

Steps

1. Remove the screw (M2x3) that secures the solid-state drive thermal shield to the system board.
2. Slide and lift the solid-state drive thermal shield off the system board.
3. Slide and lift the M.2 2230 solid-state drive off the solid-state drive slot.

Installing the M.2 2230 solid-state drive

Prerequisites

If you are replacing a component, remove the existing component before performing the installation procedure.

About this task

NOTE: Solid-state drives are fragile. Exercise care when handling the solid-state drive.

The following images indicate the location of the M.2 2230 solid-state drive and provides a visual representation of the installation procedure.

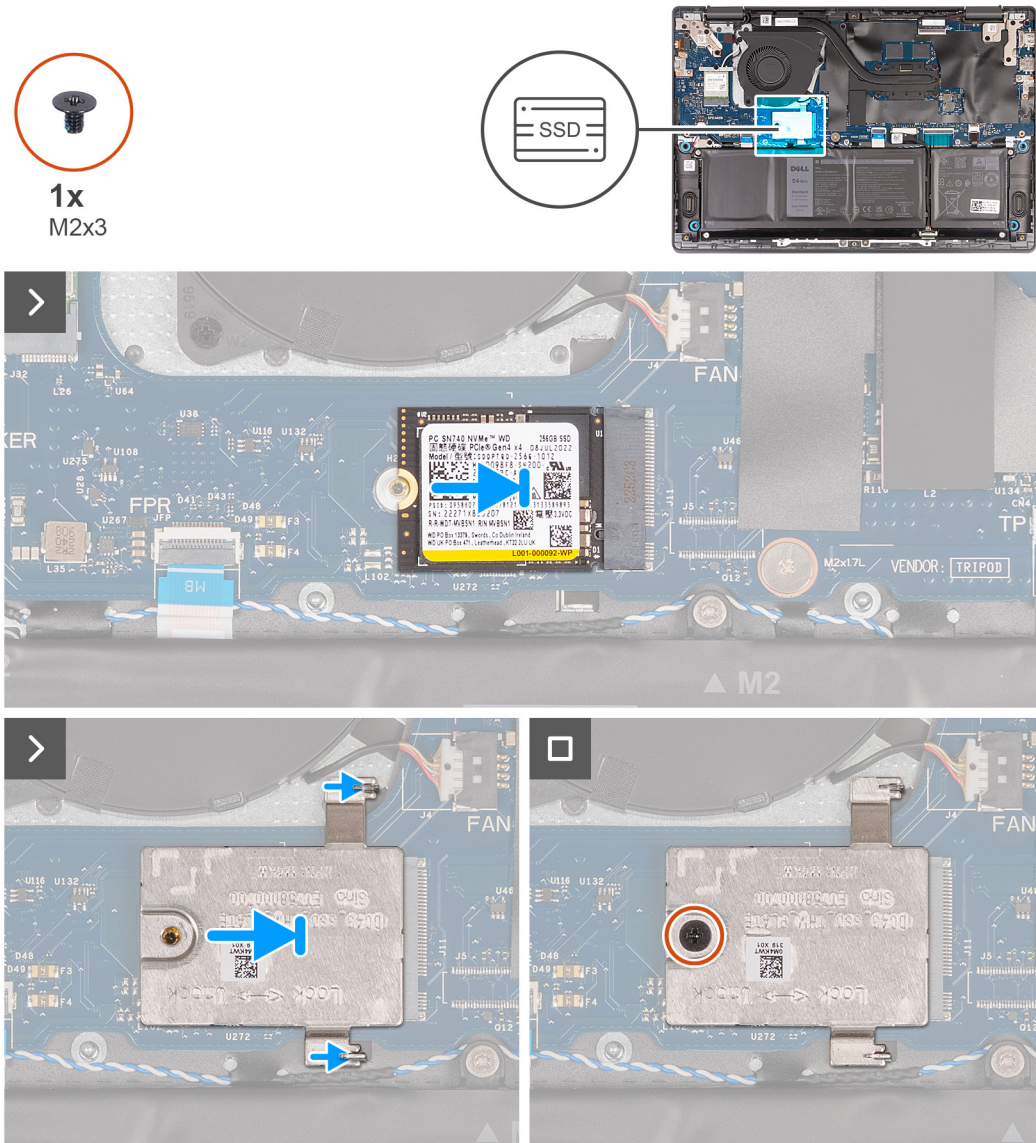

Figure 10. Installing the M.2 2230 solid-state drive

Steps

1. Align the notch on the M.2 2230 solid-state drive with the tab on the solid-state drive slot.
2. Slide the M.2 2230 solid-state drive into the M.2 2230 solid-state drive slot on the system board.
3. Align the tab on the thermal shield with the recess on the system board.
4. Replace the screw (M2x3) that secures the solid-state drive thermal shield to the solid-state drive.

Next steps

1. Install the [base cover](#).
2. Follow the procedure in [After working inside your computer](#).

Wireless card

Removing the wireless card

Prerequisites

1. Follow the procedure in [Before working inside your computer](#).
2. Remove the [base cover](#).

About this task

The following images indicate the location of the wireless card and provide a visual representation of the removal procedure.

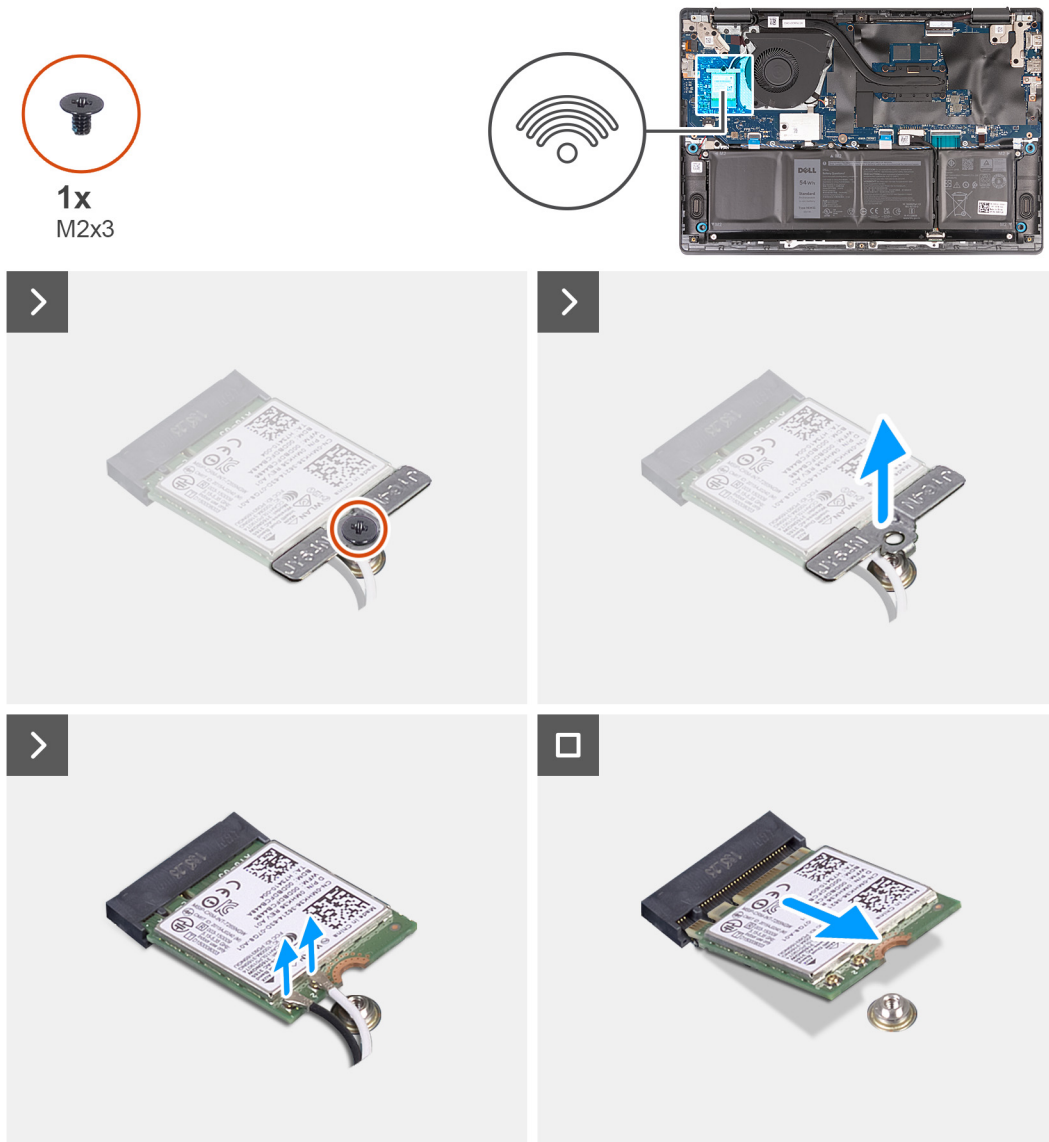

Figure 11. Removing the wireless card

Steps

1. Remove the screw (M2x3) that secures the wireless-card bracket to the wireless card and system board.
2. Lift the wireless-card bracket off the wireless card.
3. Disconnect the antenna cables from the wireless card.
4. Slide and lift the wireless card from the wireless-card slot.

Installing the wireless card

Prerequisites

If you are replacing a component, remove the existing component before performing the installation procedure.

About this task

The following images indicate the location of the wireless card and provide a visual representation of the installation procedure.

Figure 12. Installing the wireless card

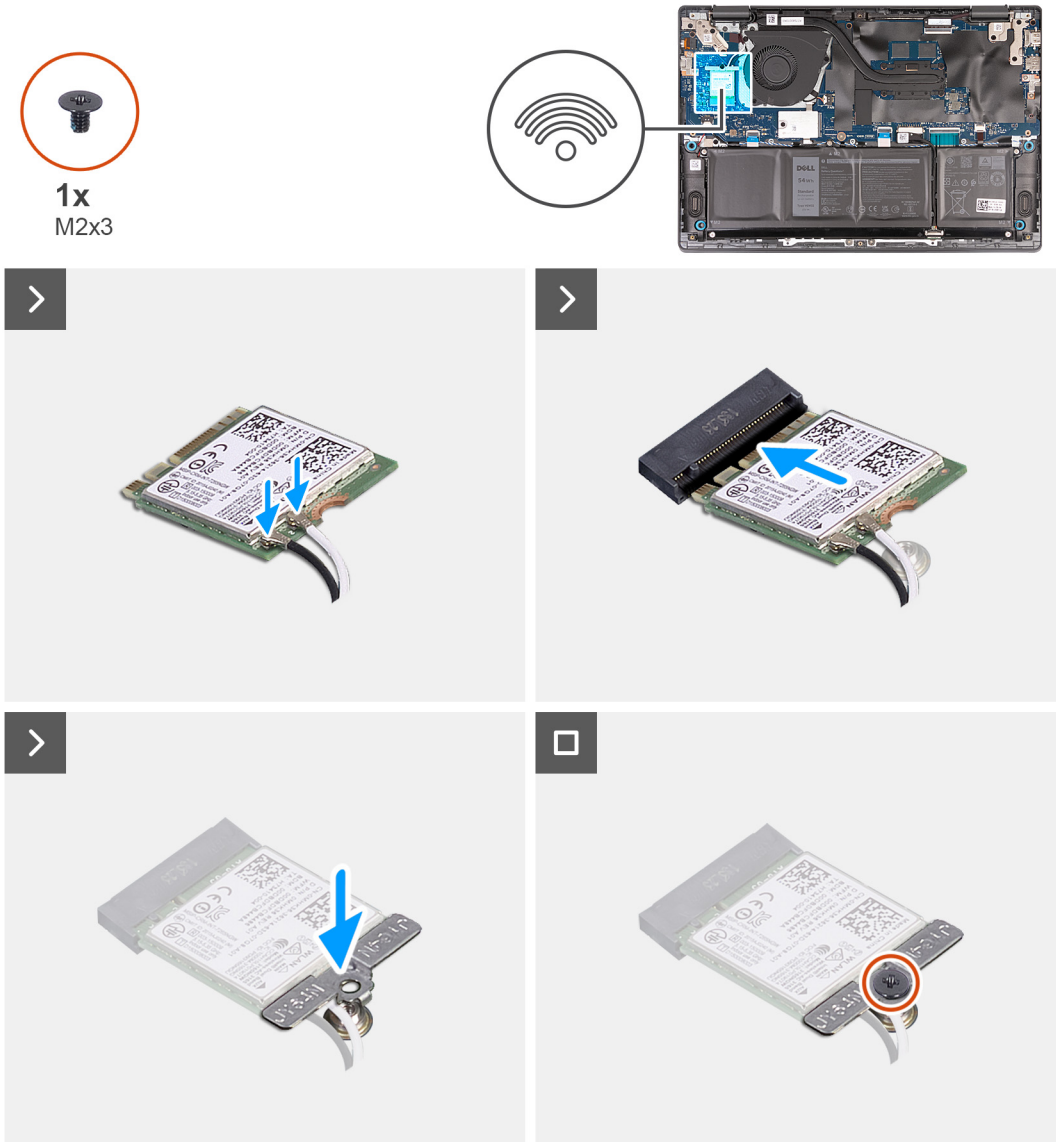

Steps

1. Connect the antenna cables to the wireless card.

Table 25. Antenna-cable color scheme

Connectors on the wireless card	Antenna-cable color	Silkscreen marking
Main	White	MAIN △ (white triangle)

Table 25. Antenna-cable color scheme (continued)

Connectors on the wireless card	Antenna-cable color	Silkscreen marking	
Auxiliary	Black	AUX	▲ (black triangle)

2. Align the notch on the wireless card with the tab on the wireless-card slot on the system board.
3. Slide and insert the wireless card at an angle into the wireless-card slot on the system board.
4. Place the wireless-card bracket on the wireless card.
5. Replace the screw (M2x3) that secures the wireless card and wireless-card bracket to the system board.

Next steps

1. Install the [base cover](#).
2. Follow the procedure in [After working inside your computer](#).

Fan

Removing the fan

Prerequisites

1. Follow the procedure in [Before working inside your computer](#).
2. Remove the [base cover](#).

About this task

The following image(s) indicate the location of the fan and provides a visual representation of the removal procedure.

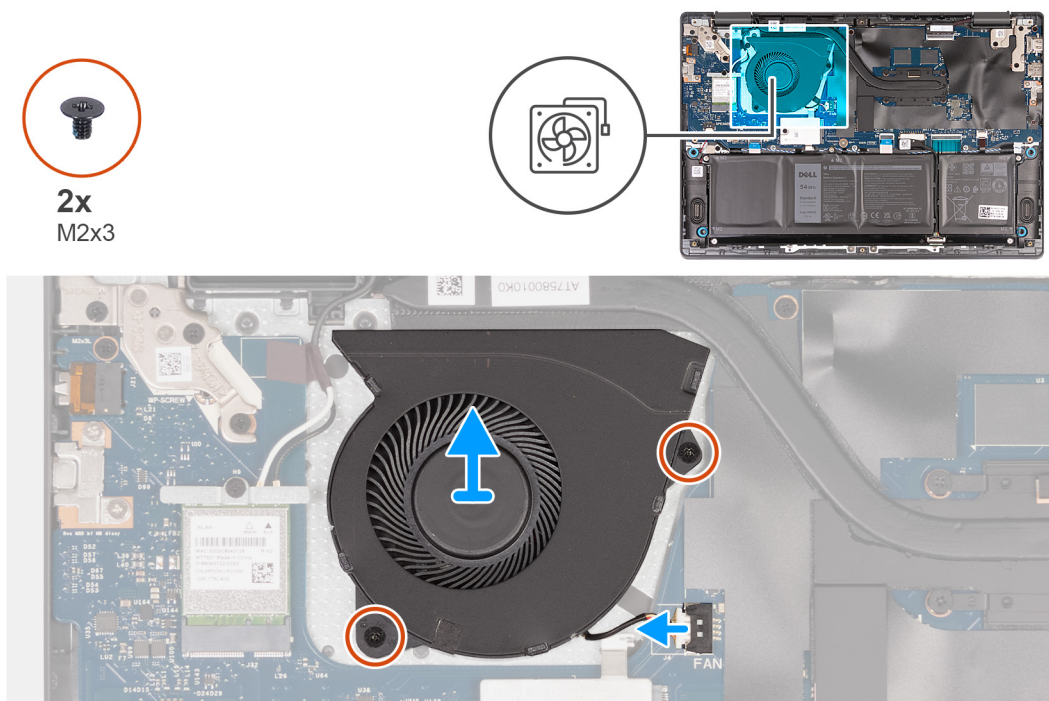

Figure 13. Removing the fan

Steps

1. Disconnect the fan cable from the connector on the system board.
2. Remove the two screws (M2x3) that secure the fan to the palm-rest and keyboard assembly.

3. Lift the fan off the palm-rest and keyboard assembly.

Installing the fan

Prerequisites

If you are replacing a component, remove the existing component before performing the installation process.

About this task

The following image(s) indicate the location of the fan and provides a visual representation of the installation procedure.

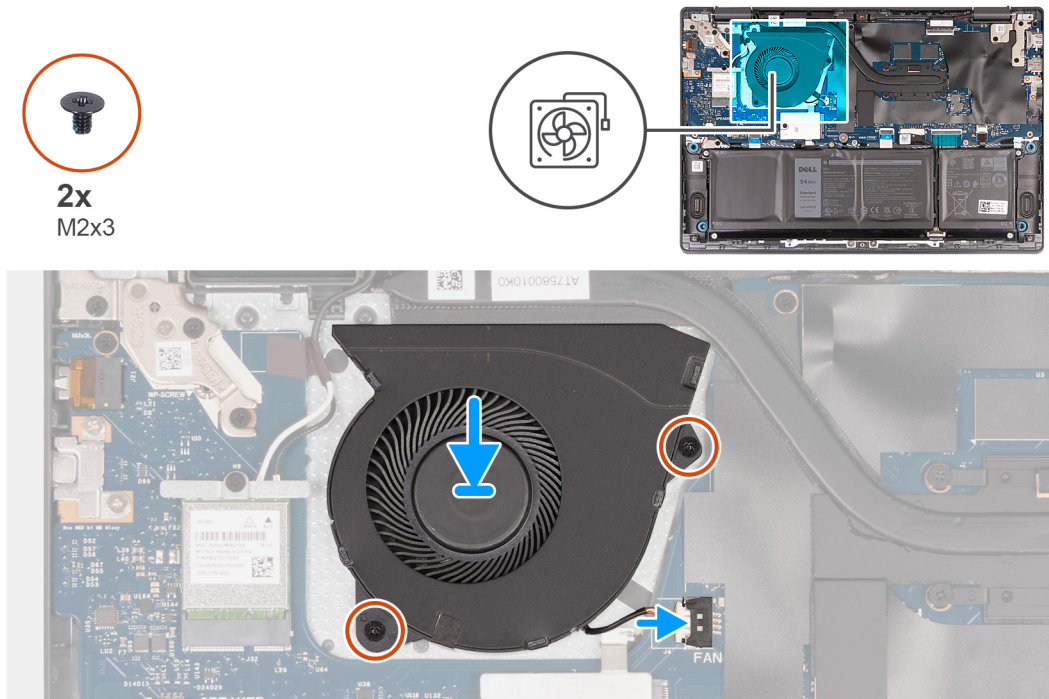

Figure 14. Installing the fan

Steps

1. Align the screw holes on the fan with the screw holes on the palm-rest and keyboard assembly.
2. Replace the two screws (M2x3) that secure the fan to the palm-rest and keyboard assembly.
3. Connect the fan cable to the connector to the system board.

Next steps

1. Install the [base cover](#).
2. Follow the procedure in [After working inside your computer](#).

Removing and installing Field Replaceable Units (FRUs)

The replaceable components in this chapter are Field Replaceable Units (FRUs).

CAUTION: The information in this section is intended for authorized service technicians only.

CAUTION: To avoid any potential damage to the component or loss of data, ensure that an authorized service technician replaces the Field Replaceable Units (FRUs).

CAUTION: Dell Technologies recommends that this set of repairs, if needed, to be conducted by trained technical repair specialists.

CAUTION: As a reminder, your warranty does not cover damages that may occur during the courses of FRU repairs that are not authorized by Dell Technologies.

NOTE: The images in this document may differ from your computer depending on the configuration you ordered.

Battery

Rechargeable Li-ion battery precautions

CAUTION:

- Exercise caution when handling rechargeable Li-ion batteries.
- Discharge the battery completely before removing it. Disconnect the AC power adapter from the system and operate the computer solely on battery power—the battery is fully discharged when the computer no longer turns on when the power button is pressed.
- Do not crush, drop, mutilate, or penetrate the battery with foreign objects.
- Do not expose the battery to high temperatures, or disassemble battery packs and cells.
- Do not apply pressure to the surface of the battery.
- Do not bend the battery.
- Do not use tools of any kind to pry on or against the battery.
- Ensure any screws during the servicing of this product are not lost or misplaced, to prevent accidental puncture or damage to the battery and other system components.
- If the battery gets stuck inside your computer as a result of swelling, do not try to release it as puncturing, bending, or crushing a rechargeable Li-ion battery can be dangerous. In such an instance, contact Dell technical support for assistance. See www.dell.com/contactdell.
- Always purchase genuine batteries from www.dell.com or authorized Dell partners and resellers.
- Swollen batteries should not be used and should be replaced and disposed properly. For guidelines on how to handle and replace swollen rechargeable Li-ion batteries, see [Handling swollen rechargeable Li-ion batteries](#).

Removing the battery

CAUTION: The information in this removal section is intended for authorized service technicians only.

Prerequisites

1. Follow the procedure in [Before working inside your computer](#).
2. Remove the [base cover](#).

About this task

The following images indicate the location of the battery and provide a visual representation of the removal procedure.

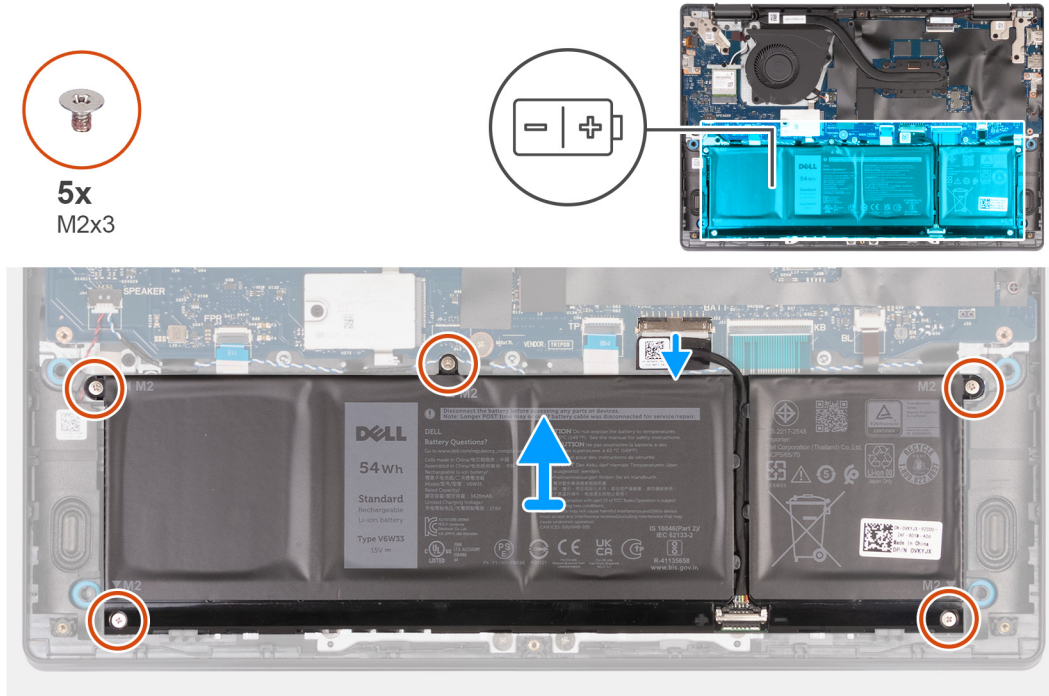

Figure 15. Removing the battery

Steps

1. Disconnect the battery cable from the connector on the system board (if not disconnected earlier).
2. Remove the five screws (M2x3) that secure the battery to the palm-rest and keyboard assembly.
3. Lift the battery off the palm-rest and keyboard assembly.

Installing the battery

CAUTION: The information in this removal section is intended for authorized service technicians only.

Prerequisites

If you are replacing a component, remove the existing component before performing the installation procedure.

About this task

The following images indicate the location of the battery and provide a visual representation of the installation procedure.

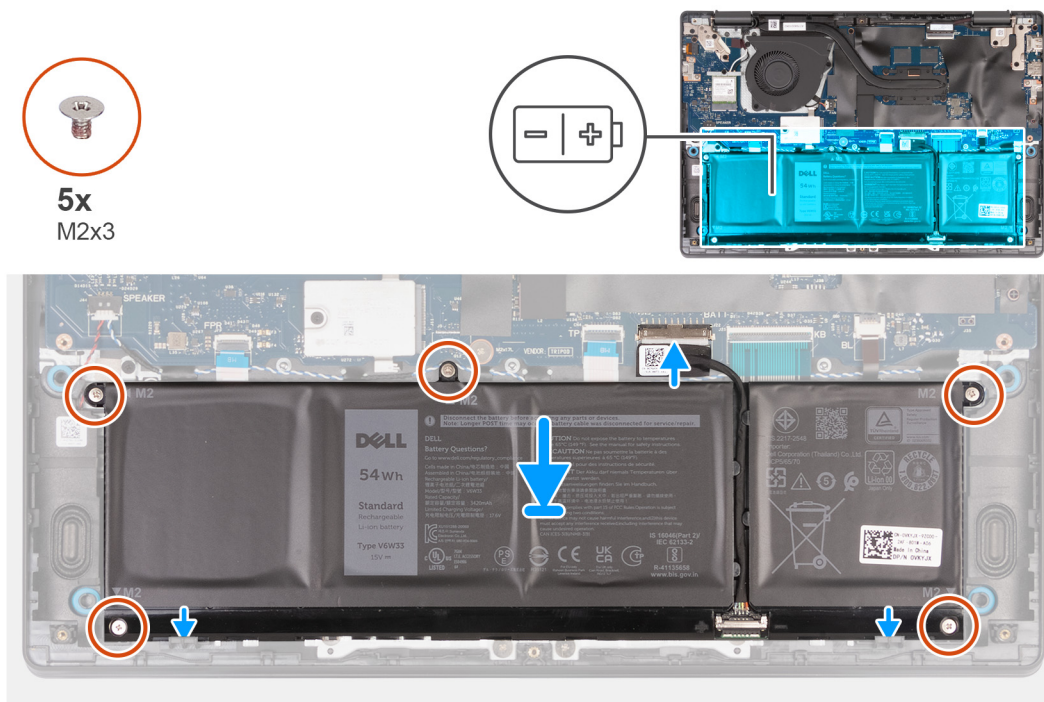

Figure 16. Installing the battery

Steps

1. Align the screw holes on the battery with the screw holes on the palm-rest and keyboard assembly.
2. Replace the five screws (M2x3) that secure the battery to the palm-rest and keyboard assembly.
3. Connect the battery cable to the connector on the system board.

Next steps

1. Install the [base cover](#).
2. Follow the procedure in [After working inside your computer](#).

Battery cable

Removing the battery cable

Prerequisites

CAUTION: The information in this section is intended for authorized service technicians only.

1. Follow the procedure in [Before working inside your computer](#).
2. Remove the [base cover](#).

About this task

The following images indicate the location of the battery cable and provide a visual representation of the removal procedure.

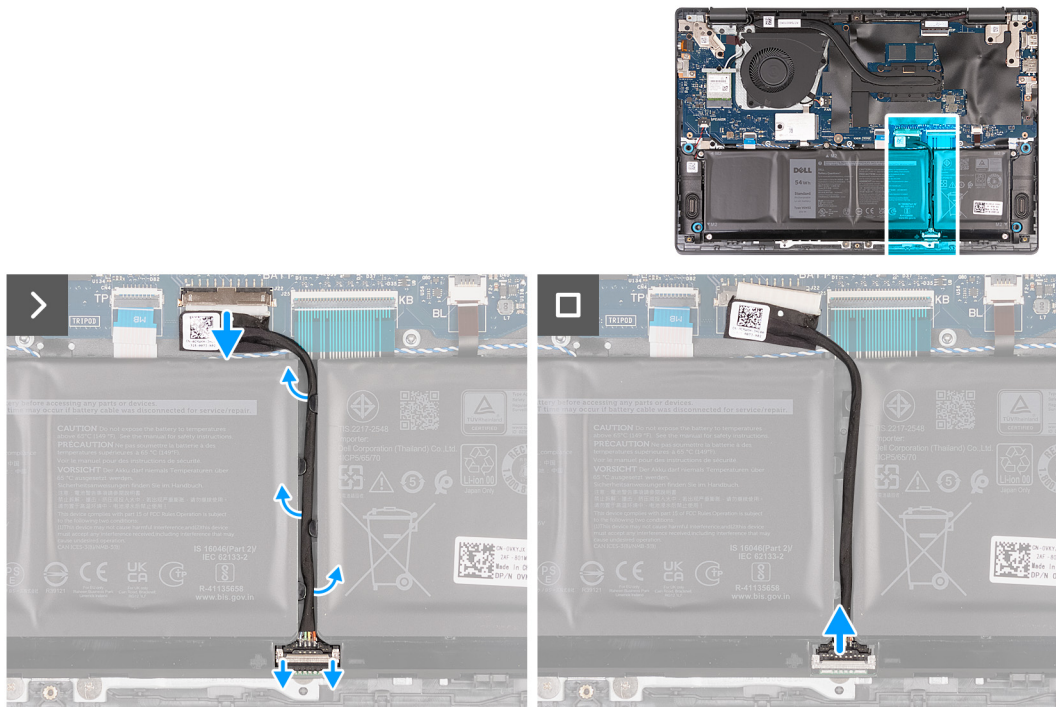

Figure 17. Removing the battery cable

Steps

1. Disconnect the battery cable from the connector on the system board (if not disconnected earlier).
2. Remove the battery cable from the routing guides on the battery.
3. When disconnecting the battery cable from the battery, you must first unlock the connector on the battery by sliding the latch on the connector outwards.

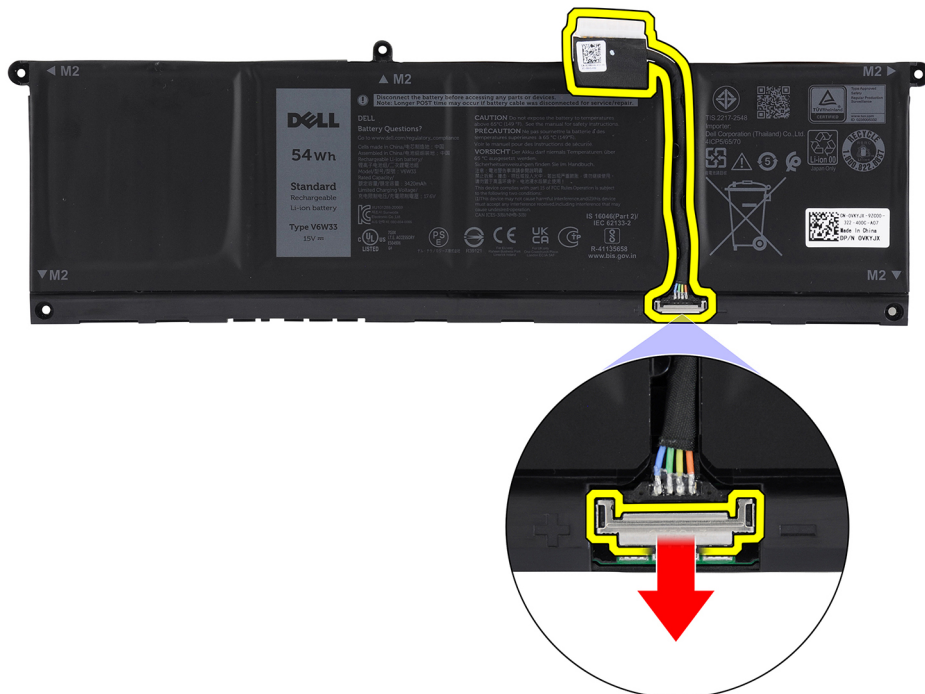

Figure 18. Disconnecting the battery cable

After unlocking the latch, unthread the battery cable and then pull the battery cable connector at a diagonal angle to remove it from the battery.

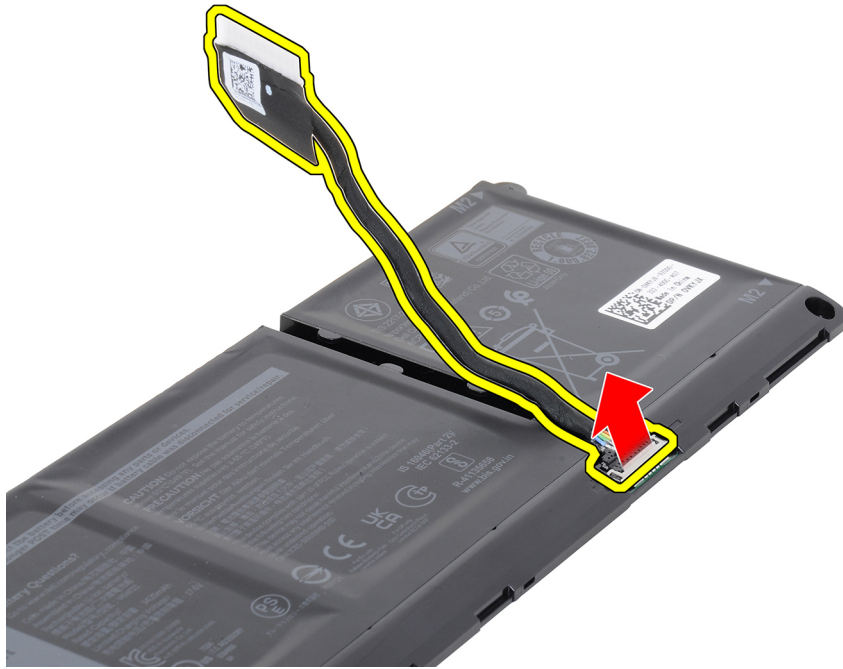

Figure 19. Disconnecting the battery cable

4. Lift the battery cable from the connector on the battery.
5. Remove the battery cable from the battery.

Installing the battery cable

Prerequisites

CAUTION: The information in this section is intended for authorized service technicians only.

If you are replacing a component, remove the existing component before performing the installation procedure.

About this task

The following image indicates the location of the battery cable and provides a visual representation of the installation procedure.

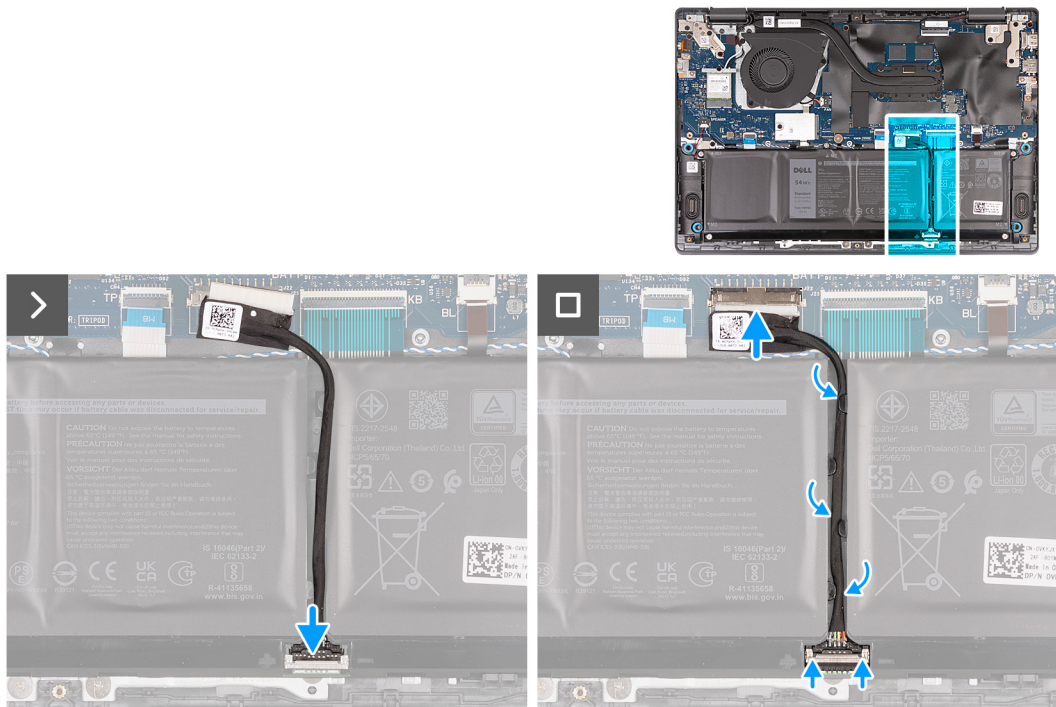

Figure 20. Installing the battery cable

Steps

1. Connect the battery cable to the connector on the battery.
2. Align and route the battery cable through the routing guides on the battery.
3. When connecting the battery cable to the battery, you must first lock the connector on the battery by sliding the latch on the connector.
4. Connect the battery cable to the connector on the system board.

Next steps

1. Install the [base cover](#).
2. Follow the procedure in [After working inside your computer](#).

Heat sink

Removing the heat sink

CAUTION: The information in this removal section is intended for authorized service technicians only.

Prerequisites

1. Follow the procedure in [Before working inside your computer](#).
2. Remove the [base cover](#).

About this task

CAUTION: The heat sink may become hot during normal operation. Allow sufficient time for the heat sink to cool before you touch it.

NOTE: For maximum cooling of the processor, do not touch the heat transfer areas on the heat sink. The oils in your skin can reduce the heat transfer capability of the thermal grease.

The following image(s) indicate the location of the heat sink and provides a visual representation of the removal procedure.

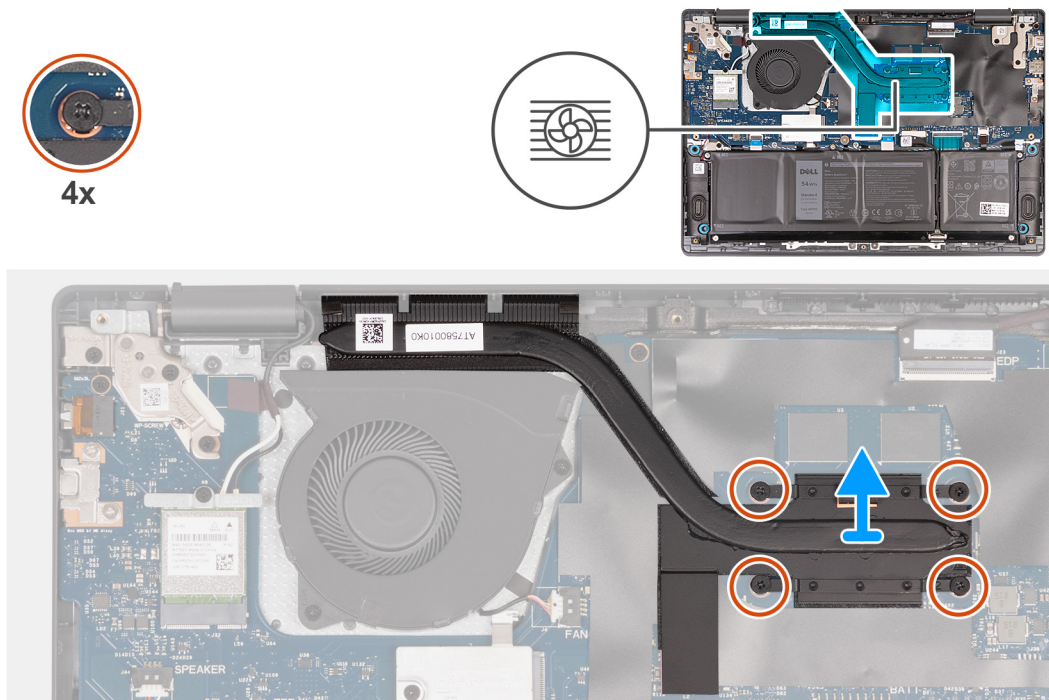

Figure 21. Removing the heat sink

Steps

1. In reverse sequential order (4 > 3 > 2 > 1) loosen the four captive screws that secure the heat sink to the system board.
2. Lift the heat sink off the system board.

Installing the heat sink

CAUTION: The information in this removal section is intended for authorized service technicians only.

Prerequisites

If you are replacing a component, remove the existing component before performing the installation process.

About this task

NOTE: If the system board or heat sink is replaced, use the thermal grease that is provided in the kit to ensure that thermal conductivity is achieved.

The following image(s) indicate the location of the heat sink and provides a visual representation of the removal procedure.

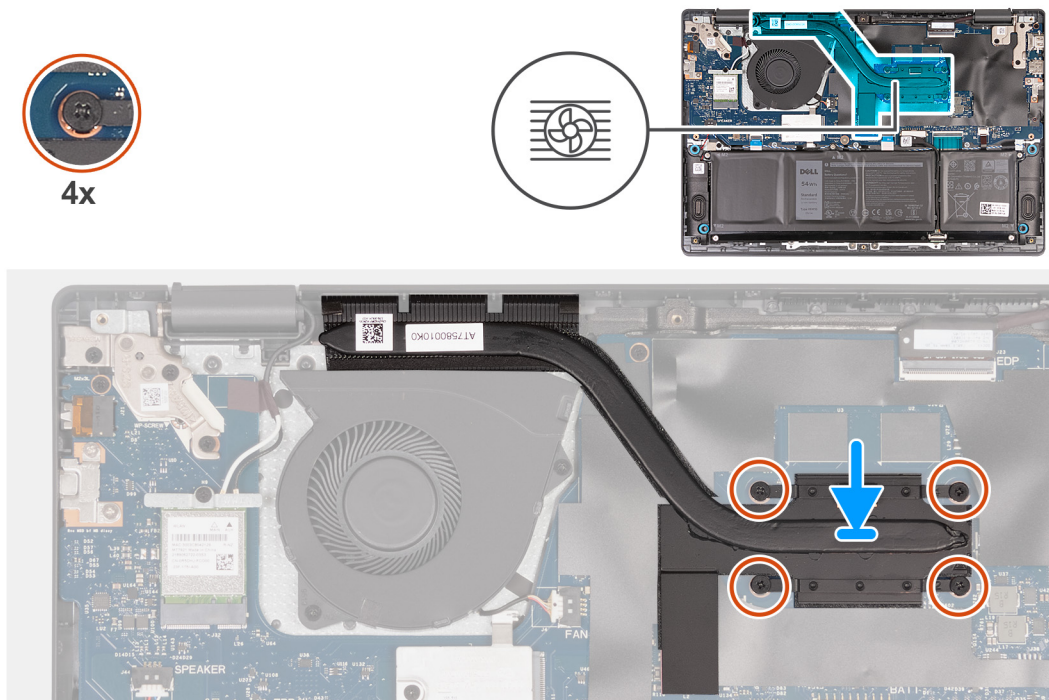

Figure 22. Installing the heat sink

Steps

1. Place the heat sink on the system board.
2. Align the screw holes on the heat sink with the screw holes on the system board.
3. In sequential order (1 > 2 > 3 > 4) tighten the four captive screws that secure the heat sink to the system board.

Next steps

1. Install the [base cover](#).
2. Follow the procedure in [After working inside your computer](#).

Display assembly

Removing the display assembly

CAUTION: The information in this removal section is intended for authorized service technicians only.

Prerequisites

1. Follow the procedure in [Before working inside your computer](#).
2. Remove the [base cover](#).
3. Remove the [wireless card](#).

About this task

The following images indicate the location of the display assembly and provide a visual representation of the removal procedure.



6x
M2.5x3.8

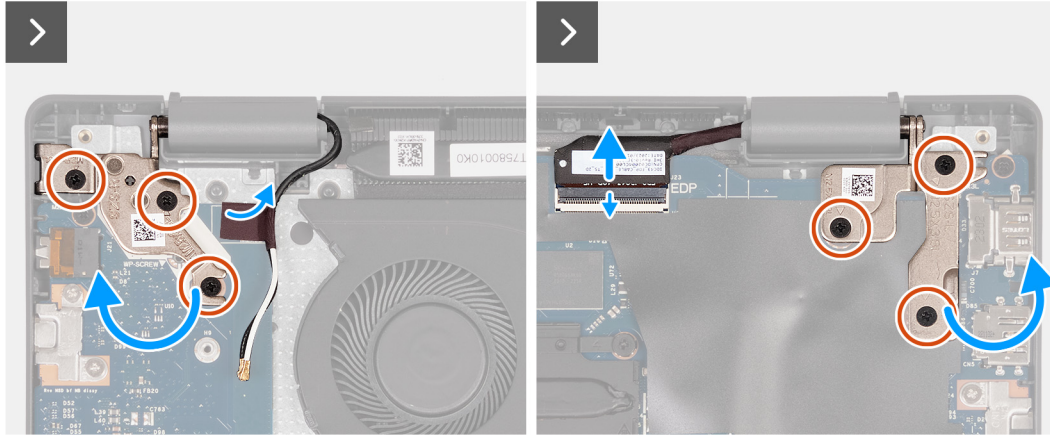
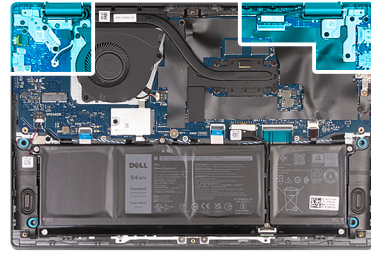

Figure 23. Removing the display assembly

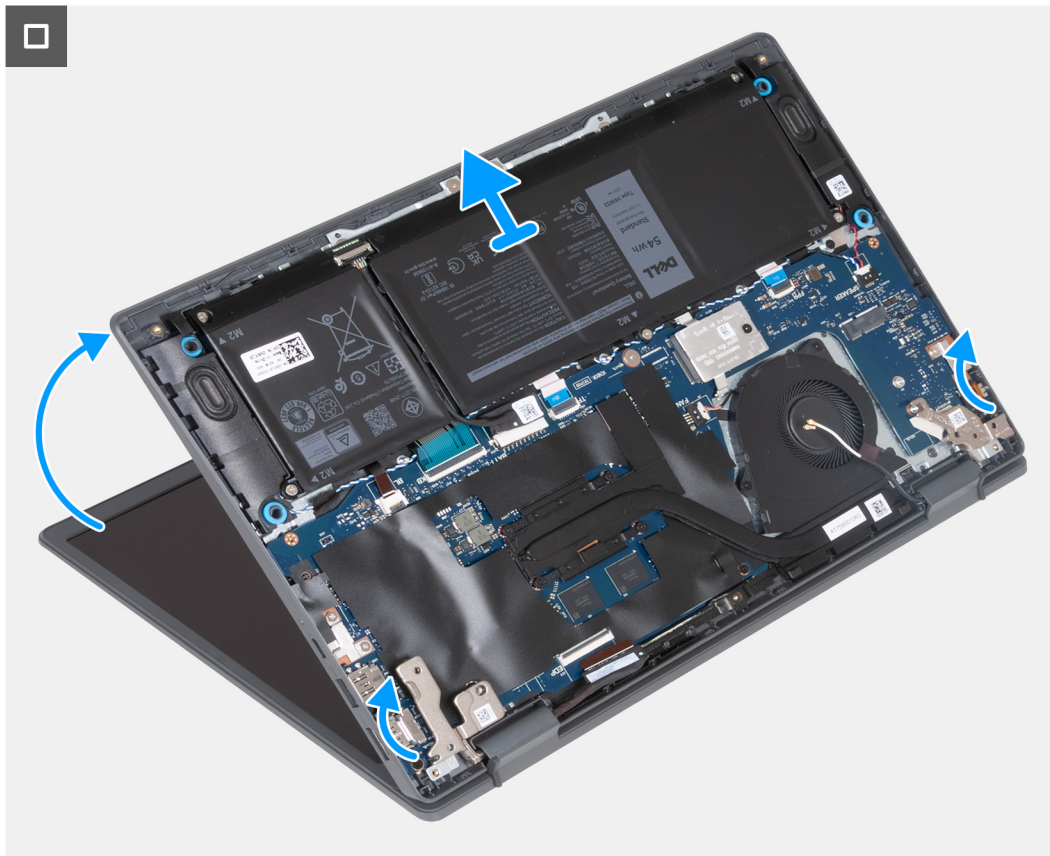

Figure 24. Removing the display assembly

Steps

1. Open the latch and disconnect the display cable from the connector on the system board.
2. Peel the tape that secures the wireless antenna cables to the system board.

3. Remove the antenna cables from the routing guides on the palm-rest and keyboard assembly.
4. Turn the computer over and open the display at an angle of 90 degrees.
5. Rotate the computer and place it in a position that allows access to the screws on the display.
6. Remove the six screws (M2.5x3.8) that secure the left and right display hinges to the palm-rest assembly.
7. Carefully lift the display assembly from the palm-rest assembly.
8. Carefully place the display assembly on a clean, flat surface.

Installing the display assembly

CAUTION: The information in this installation section is intended for authorized service technicians only.

Prerequisites

If you are replacing a component, remove the existing component before performing the installation process.

About this task

The following images indicate the location of the display assembly and provide a visual representation of the installation procedure.

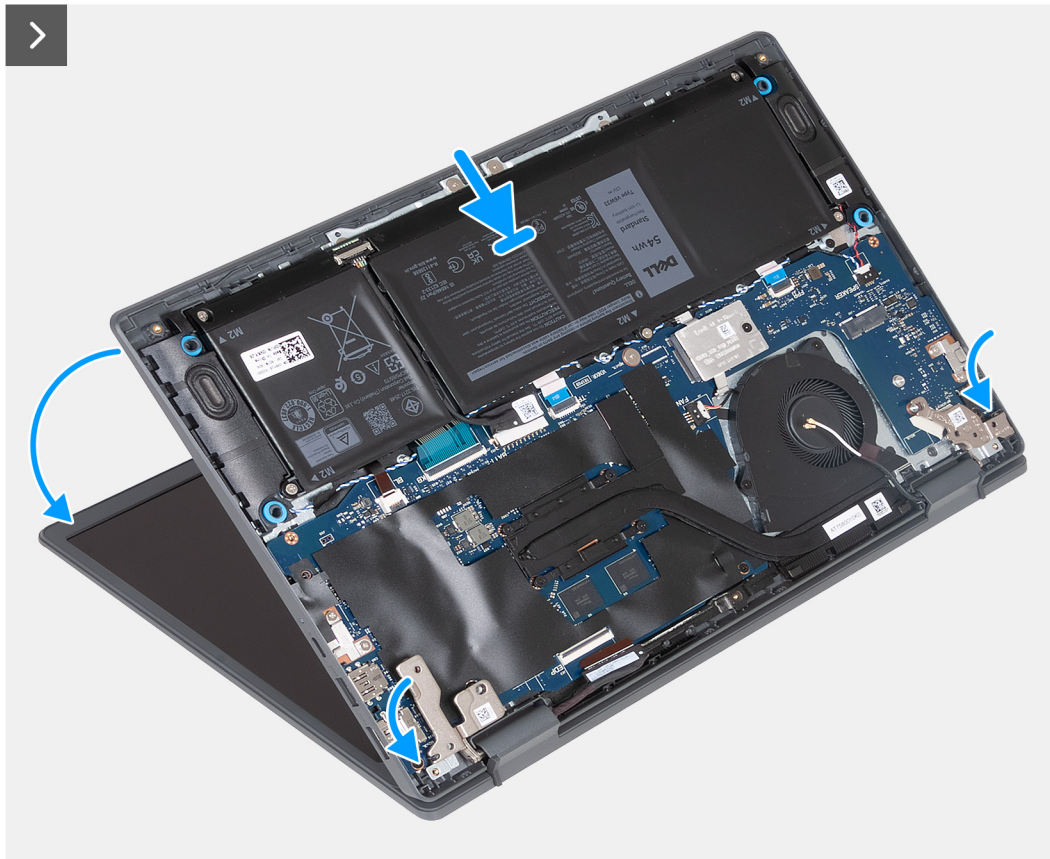

Figure 25. Installing the display assembly



6x
M2.5x3.8

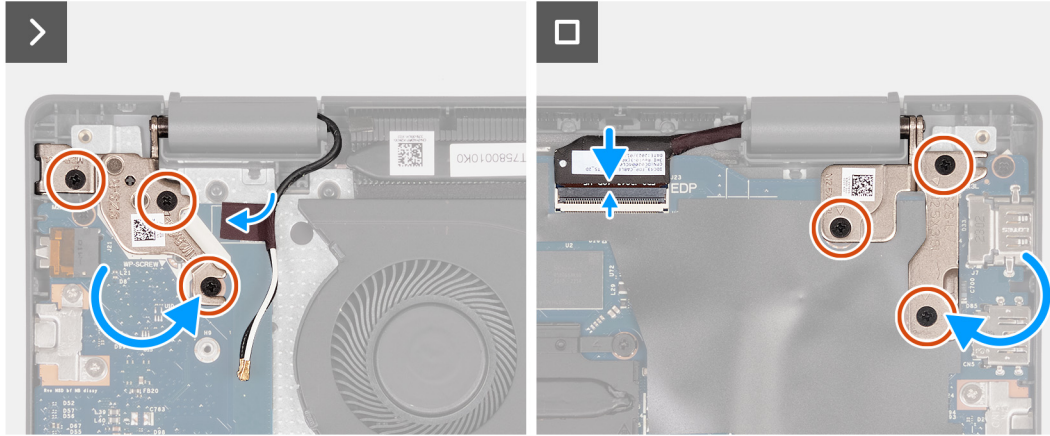
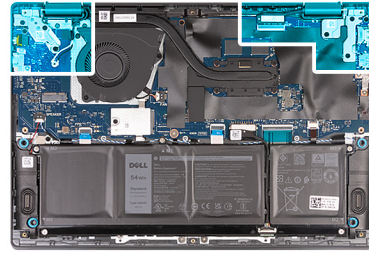

Figure 26. Installing the display assembly

Steps

1. Align the screw holes on the palm-rest assembly with the screw holes on the display hinges.
2. Replace the six screws (M2.5x3.8) that secure the left and right display hinges to the palm-rest assembly.
3. Turn the computer over and open the display at an angle of 90 degrees.
4. Close the display and turn the computer over.
5. Connect the display cable to the system board.
6. Adhere the tape that secures the wireless antenna cable in place on the system board.
7. Route the antenna cables on the routing guides on the palm-rest and keyboard assembly.

Next steps

1. Install the [wireless card](#).
2. Install the [base cover](#).
3. Follow the procedure in [After working inside your computer](#).

Speakers

Removing the speakers

 **CAUTION:** The information in this removal section is intended for authorized service technicians only.

Prerequisites

1. Follow the procedure in [Before working inside your computer](#).
2. Remove the [base cover](#).
3. Remove the [battery](#).

About this task

The following images indicate the location of the speakers and provide a visual representation of the removal procedure.

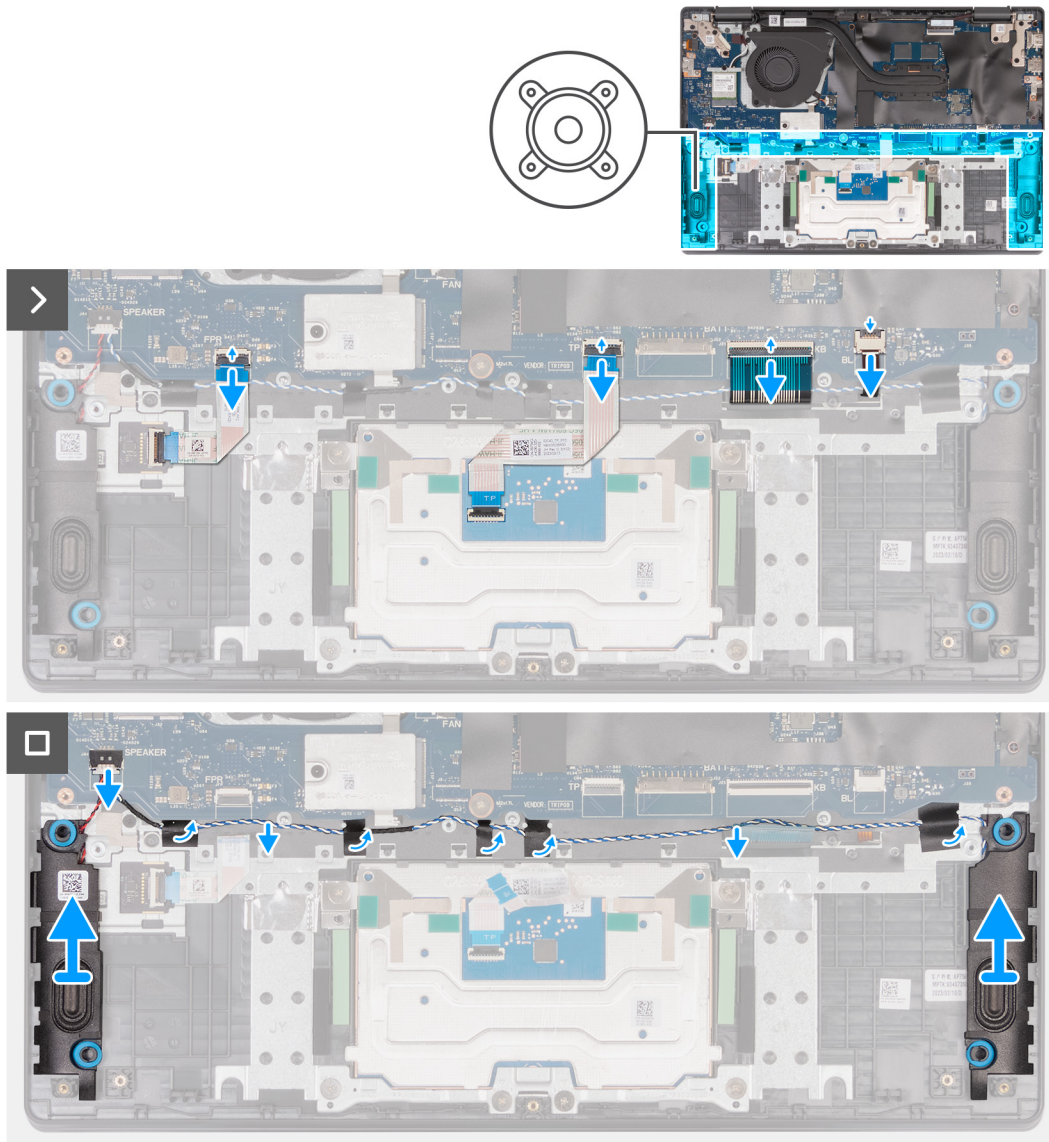

Figure 27. Removing the speakers

Steps

1. Disconnect the fingerprint reader cable (for computers shipped with fingerprint reader), touchpad cable, keyboard cable, and keyboard backlight cable (for computers shipped with keyboard backlight) from the system board.
2. Disconnect the speaker cable from the system board.
3. Peel the tapes that secure the speaker cable to the palm-rest and keyboard assembly.
4. Remove the speaker cable from the routing guides on the palm-rest and keyboard assembly.
5. Lift the right and left speakers, along with its cable, off the palm-rest assembly.

Installing the speakers

CAUTION: The information in this installation section is intended for authorized service technicians only.

Prerequisites

If you are replacing a component, remove the existing component before performing the installation process.

About this task

The following images indicate the location of the speakers and provide a visual representation of the installation procedure.

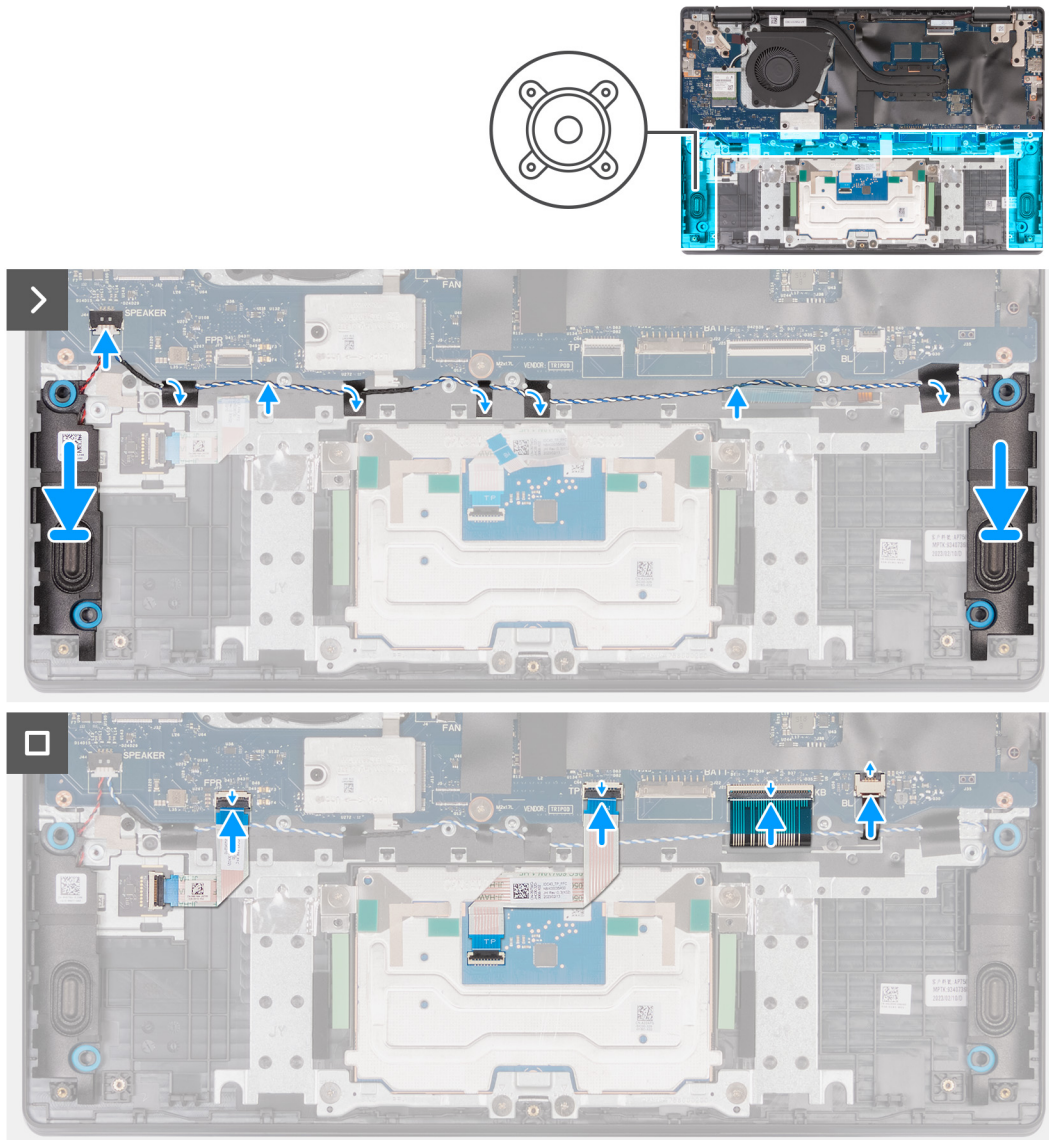

Figure 28. Installing the speakers

Steps

1. Using the alignment posts, place the left and right speakers into their slots on the palm-rest and keyboard assembly.
2. Route the speaker cable through the routing guides on the palm-rest and keyboard assembly.

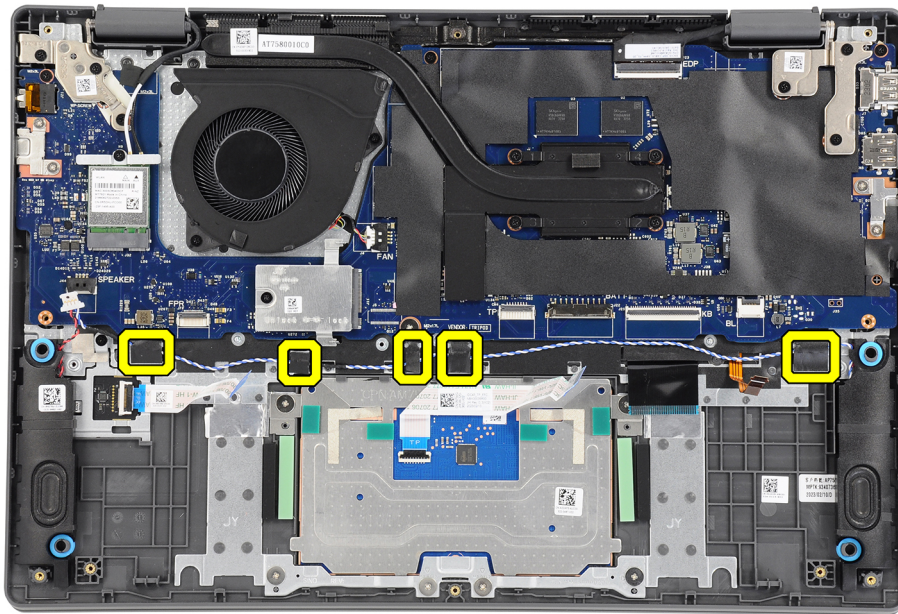

Figure 29. Installing the speakers

3. Adhere the tapes that secure the speaker cable to the palm-rest and keyboard assembly.
4. Connect the speaker cable to the system board.
5. Connect the fingerprint reader cable (for computers shipped with fingerprint reader), touchpad cable, keyboard cable, and backlight cable (for computers shipped with keyboard backlight) to the system board.

Next steps

1. Install the [battery](#).
2. Install the [base cover](#).
3. Follow the procedure in [After working inside your computer](#).

Display bezel

Removing the display bezel

CAUTION: The information in this removal section is intended for authorized service technicians only.

Prerequisites

1. Follow the procedure in [Before working inside your computer](#).
2. Remove the [base cover](#).
3. Remove the [wireless card](#).
4. Remove the [display assembly](#).

About this task

The following images indicate the location of the display bezel and provide a visual representation of the removal procedure.

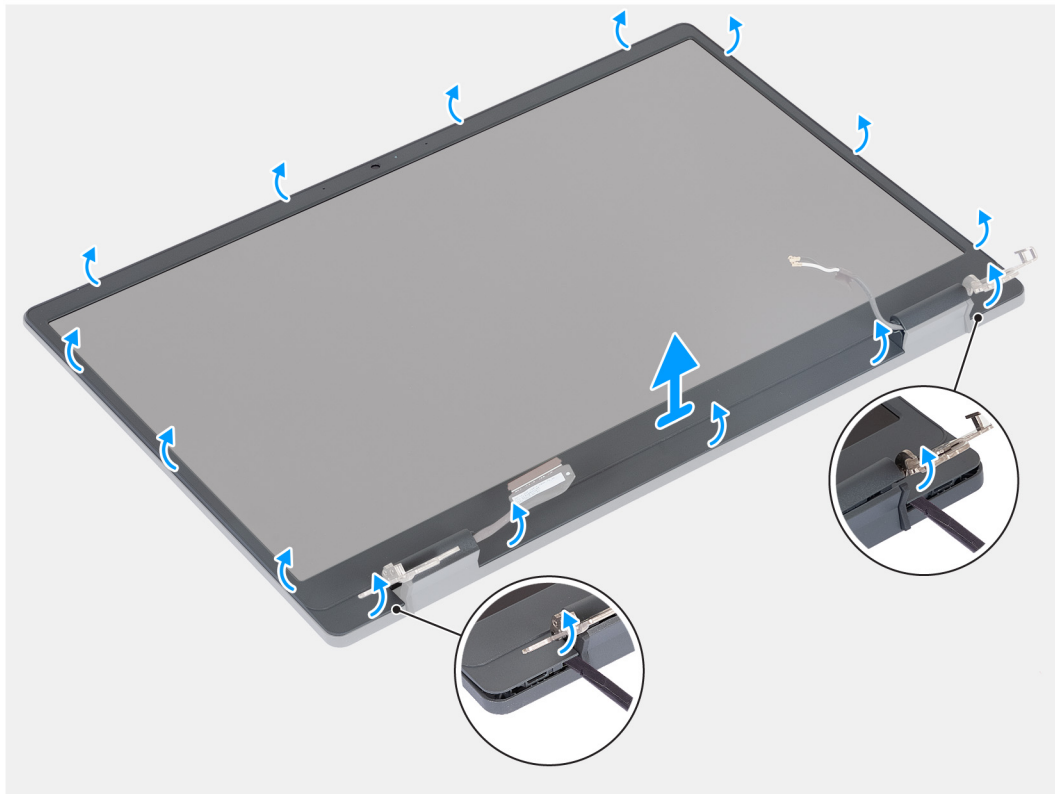

Figure 30. Removing the display bezel

Steps

1. Carefully pry up the display bezel starting from the recesses on the bottom edge of the display near the left and right hinges.
2. Pry along the outer edge of the display bezel. Work your way around the entire display bezel until the display bezel is separated from the display cover.

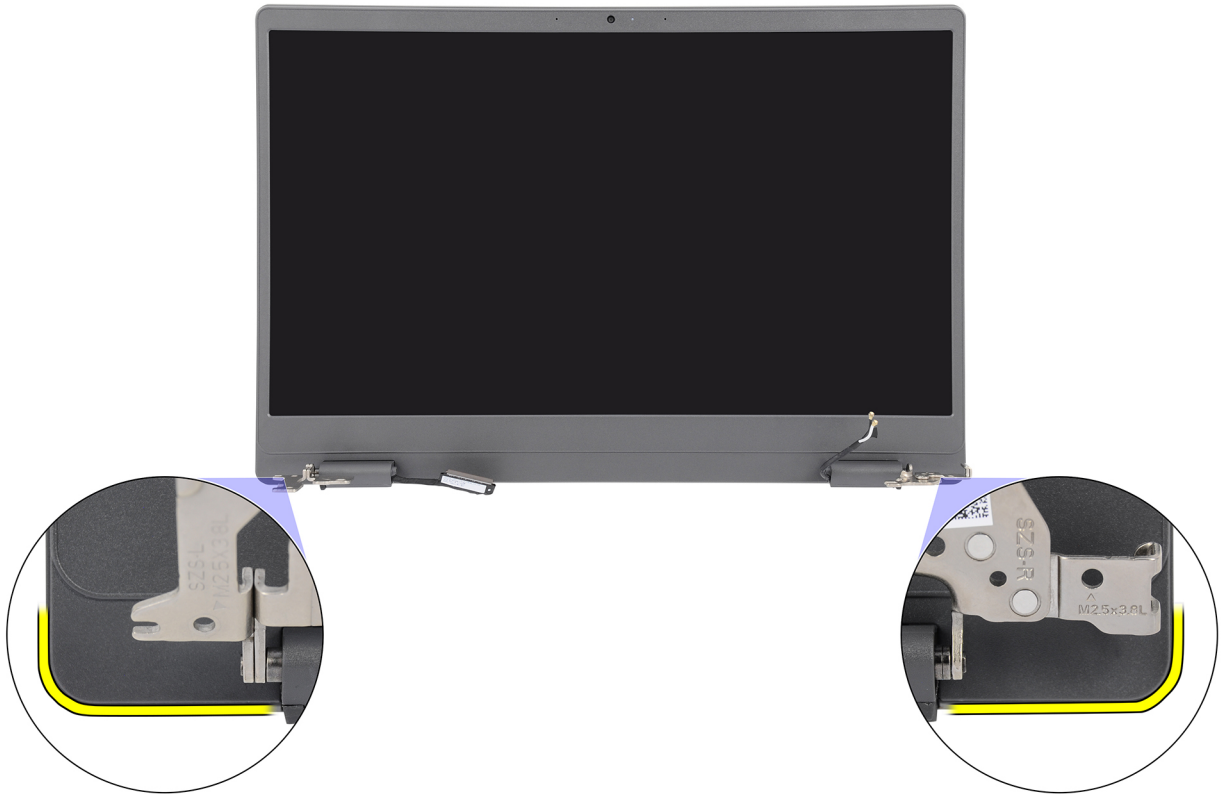

Figure 31. Removing the display bezel

3. After prying the edges open, work your way around the outer edge of the left, right, and top sides of the bezel.

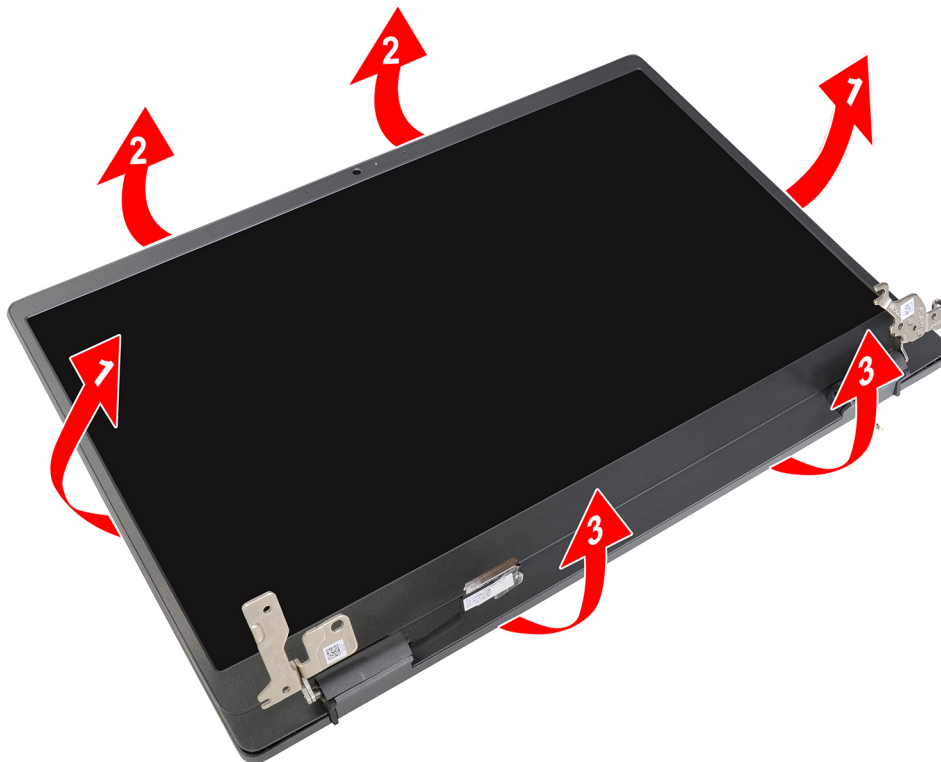

Figure 32. Removing the display bezel

CAUTION: Do not use a scribe or any other objects to pry up the display bezel as indicated in the following image, as the pressure applied on the display panel by the scribe will damage the display panel.



4. Lift the display bezel from the display assembly.

NOTE: The display bezel is not reusable and must be replaced with a new bezel anytime it is removed from the computer.

Installing the display bezel

CAUTION: The information in this installation section is intended for authorized service technicians only.

Prerequisites

If you are replacing a component, remove the existing component before performing the installation process.

About this task

The following images indicate the location of the display bezel and provide a visual representation of the installation procedure.

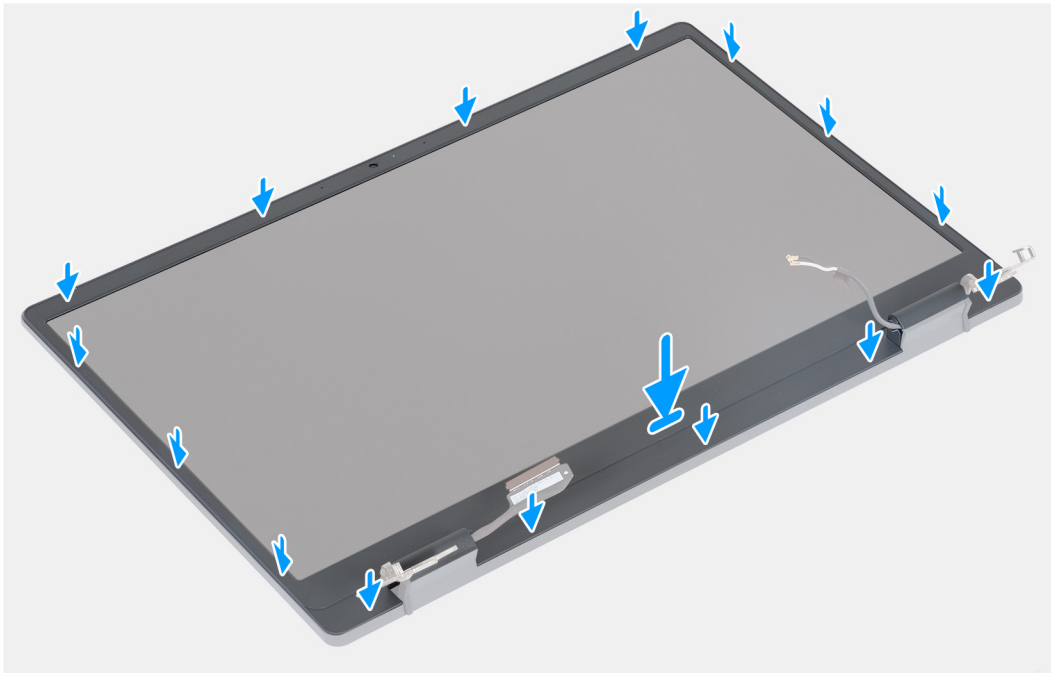

Figure 33. Installing the display bezel

Steps

1. When installing the display bezel, install the bezel from its bottom side first.

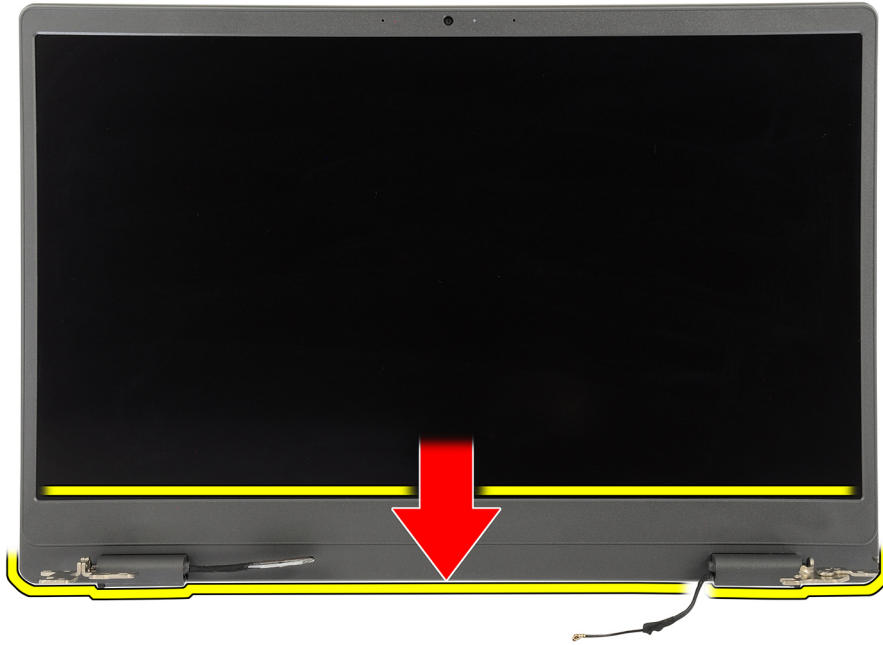

Figure 34. Installing the display bezel

2. Align and place the display bezel on the display assembly.
3. After inserting the bottom side of the bezel on the display back cover, ensure that the display cable and wireless antenna cables are routed through the openings in the corresponding hinge caps.



4. Gently snap the display bezel into place.

Next steps

1. Install the [display assembly](#).
2. Install the [wireless card](#).
3. Install the [base cover](#).
4. Follow the procedure in [After working inside your computer](#).

Display hinges

Removing the display hinges

CAUTION: The information in this removal section is intended for authorized service technicians only.

Prerequisites

1. Follow the procedure in [Before working inside your computer](#).
2. Remove the [base cover](#).
3. Remove the [wireless card](#).
4. Remove the [display assembly](#).
5. Remove the [display bezel](#).

About this task

The following images indicate the location of the display hinges and provide a visual representation of the removal procedure.

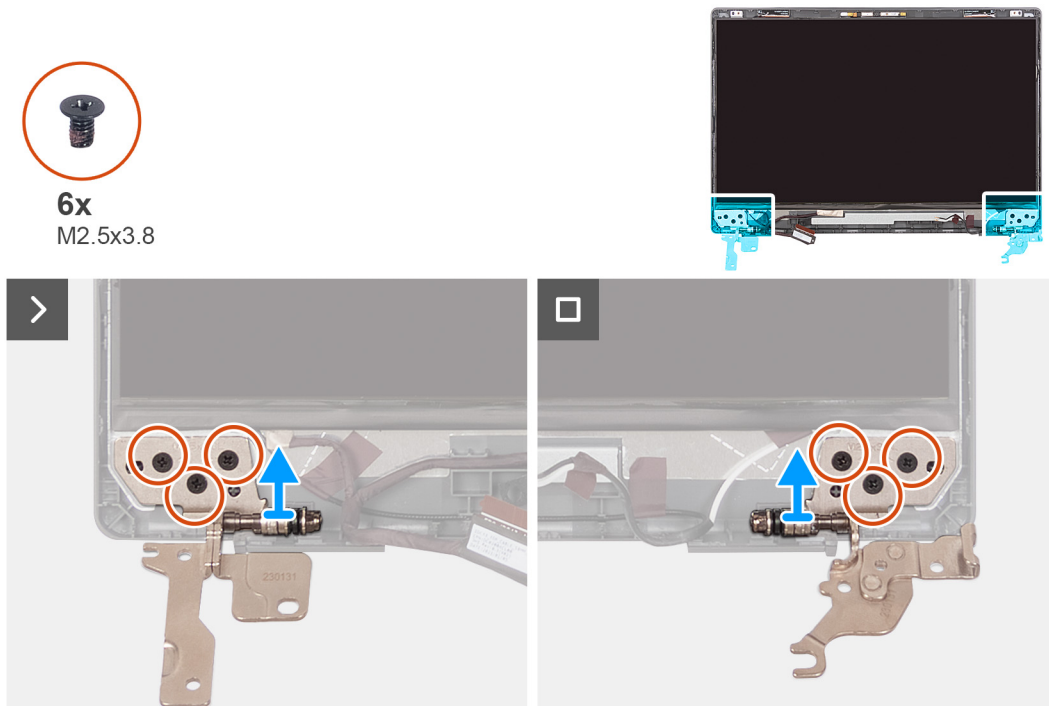

Figure 35. Removing the display hinges

Steps

1. Remove the three (M2.5x3.8) screws that secure the right hinge to the display back cover.
2. Lift and remove the right hinge from the display back cover.
3. Remove the three (M2.5x3.8) screws that secure the left hinge to the display back cover.

4. Lift and remove the left hinge from the display back cover.

Installing the display hinges

CAUTION: The information in this installation section is intended for authorized service technicians only.

Prerequisites

If you are replacing a component, remove the existing component before performing the installation process.

About this task

The following images indicate the location of the display hinges and provide a visual representation of the installation procedure.

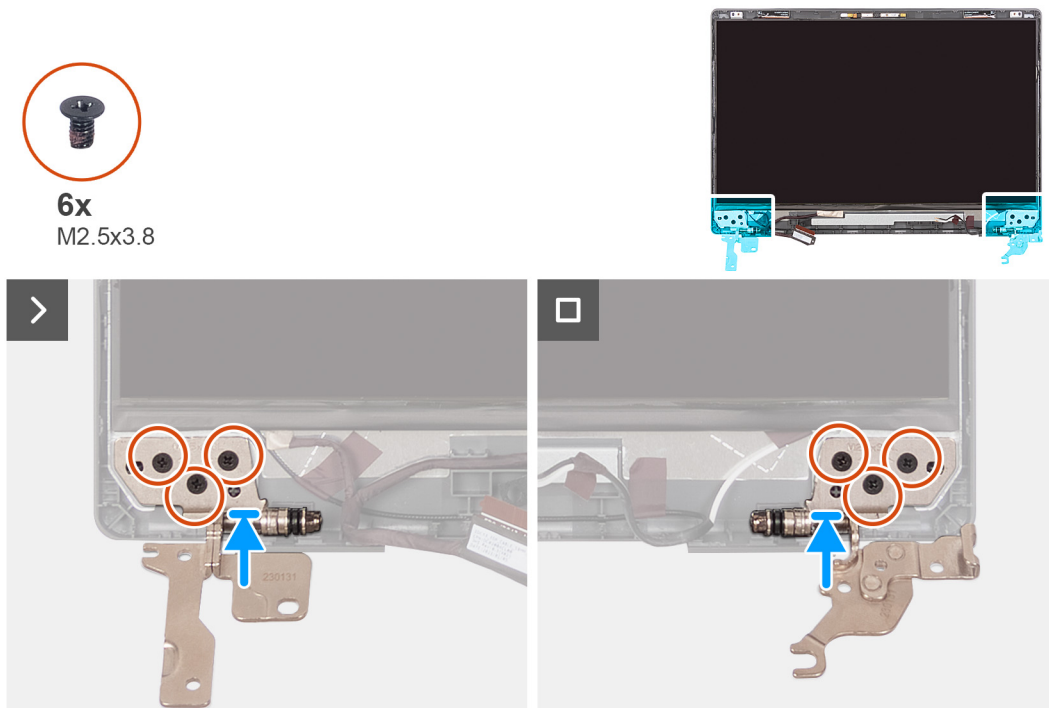

Figure 36. Installing the display hinges

Steps

1. Align the screw hole on the left hinge with the screw hole on the display back cover.
2. Replace the three screws (M2.5x3.8) that secure the left hinge to the display back cover.
3. Align the screw hole on the right hinge with the screw hole on the display back cover.
4. Replace the three screws (M2.5x3.8) that secure the right hinge to the display back cover.

Next steps

1. Install the [display bezel](#).
2. Install the [display assembly](#).
3. Install the [wireless card](#).
4. Install the [base cover](#).
5. Follow the procedure in [After working inside your computer](#).

Display panel

Removing the display panel

CAUTION: The information in this removal section is intended for authorized service technicians only.

Prerequisites

1. Follow the procedure in [Before working inside your computer](#).
2. Remove the [base cover](#).
3. Remove the [wireless card](#).
4. Remove the [display assembly](#).
5. Remove the [display bezel](#).
6. Remove the [display hinges](#).

About this task

The following images indicate the location of the display panel and provide a visual representation of the removal procedure.

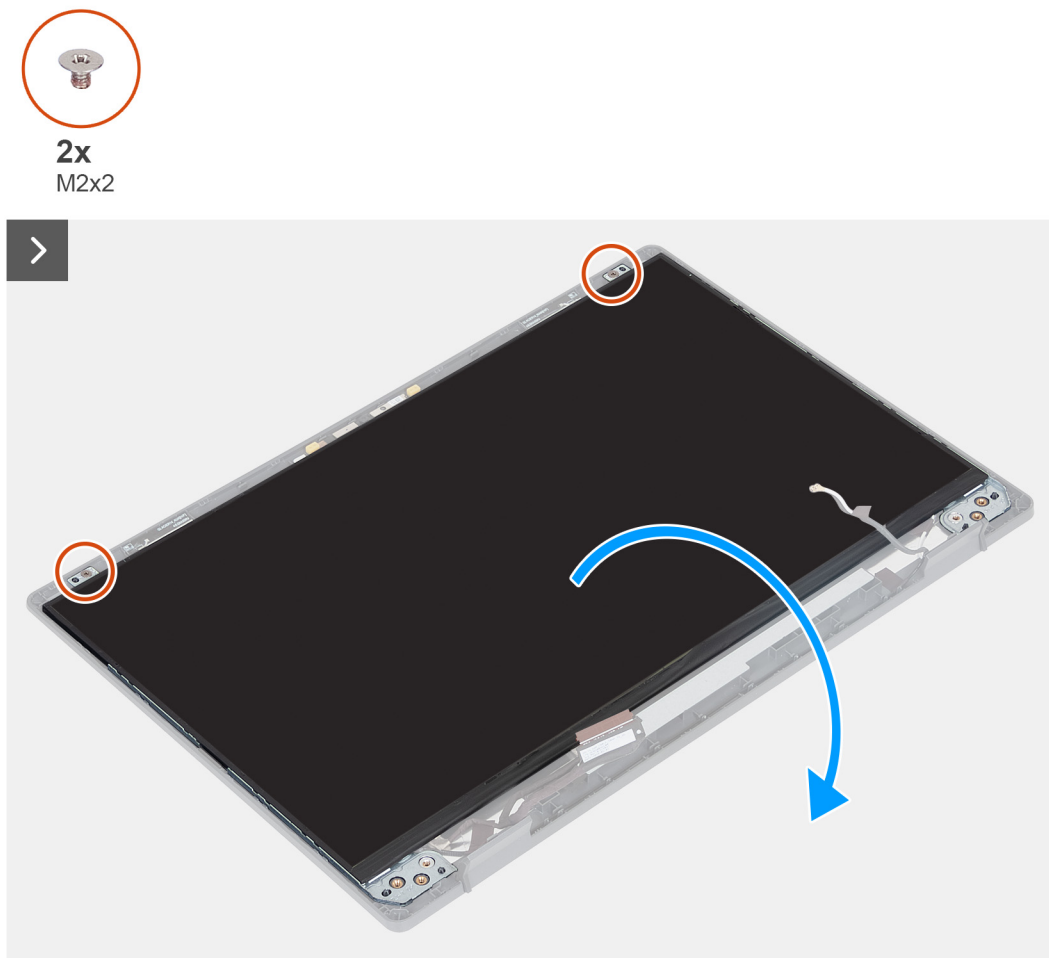

Figure 37. Removing the display panel

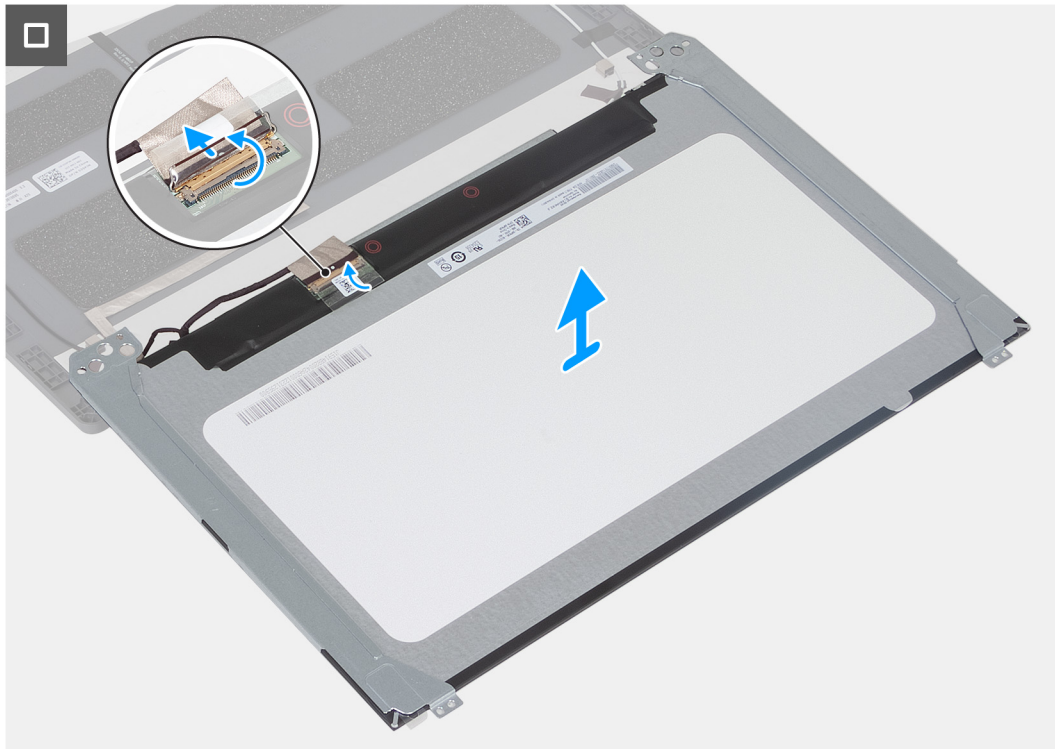

Figure 38. Removing the display panel

Steps

1. Remove the two screws (M2x2) that secure the display panel to the display back cover.
2. Gently flip the top side of the display panel assembly over.

NOTE: The display panel is assembled with the display brackets as a single service part. Do not pull the two pieces of elastic tape and separate the brackets from the panel.



Figure 39. Removing the display panel

3. Peel the tape that secures the display cable to the display panel.

4. Open the latch and disconnect the display cable from the connector on the display panel.
5. Lift the display panel away from the display back cover.

Installing the display panel

CAUTION: The information in this installation section is intended for authorized service technicians only.

Prerequisites

If you are replacing a component, remove the existing component before performing the installation process.

About this task

The following images indicate the location of the display panel and provide a visual representation of the installation procedure.



Figure 40. Installing the display panel

The following images indicate the location of the display panel and provide a visual representation of the installation procedure.



Figure 41. Installing the display panel

Steps

1. Connect the display cable to the connector on the display panel and close the latch to secure the cable.
2. Adhere the tape that secures the display cable to the display panel.
3. Close the display panel and the display back cover to assemble.

NOTE: Ensure that the display panel tabs are inserted into the slots on the display cover.

4. Replace the two screws (M2x2) that secure the display panel to the display back cover.

Next steps

1. Install the [display hinges](#).
2. Install the [display bezel](#).
3. Install the [display assembly](#).
4. Install the [wireless card](#).
5. Install the [base cover](#).
6. Follow the procedure in [After working inside your computer](#).

System board

Removing the system board

CAUTION: The information in this removal section is intended for authorized service technicians only.

Prerequisites

1. Follow the procedure in [Before working inside your computer](#).
2. Remove the [base cover](#).
3. Remove the [M.2 2230 solid-state drive](#).
4. Remove the [wireless card](#).

- 5. Remove the [heat sink](#).
- 6. Remove the [display assembly](#).

About this task

The following images indicate the system board connectors.

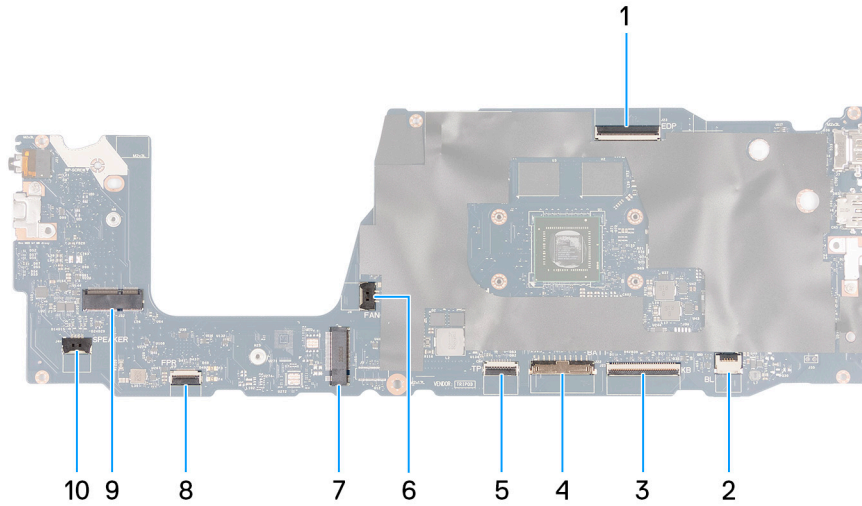

Figure 42. System board connectors

- | | |
|--|---|
| <ul style="list-style-type: none"> 1. Display cable connector 3. Keyboard cable connector 5. Touchpad cable connector 7. Solid-state drive slot 9. Wireless-card slot | <ul style="list-style-type: none"> 2. Keyboard-backlight cable connector (for computers shipped with keyboard backlight) 4. Battery cable connector 6. Fan cable connector 8. Fingerprint-reader cable connector (for computers shipped with a fingerprint reader) 10. Speaker cable connector |
|--|---|

The following images indicate the location of the system board and provide a visual representation of the removal procedure.

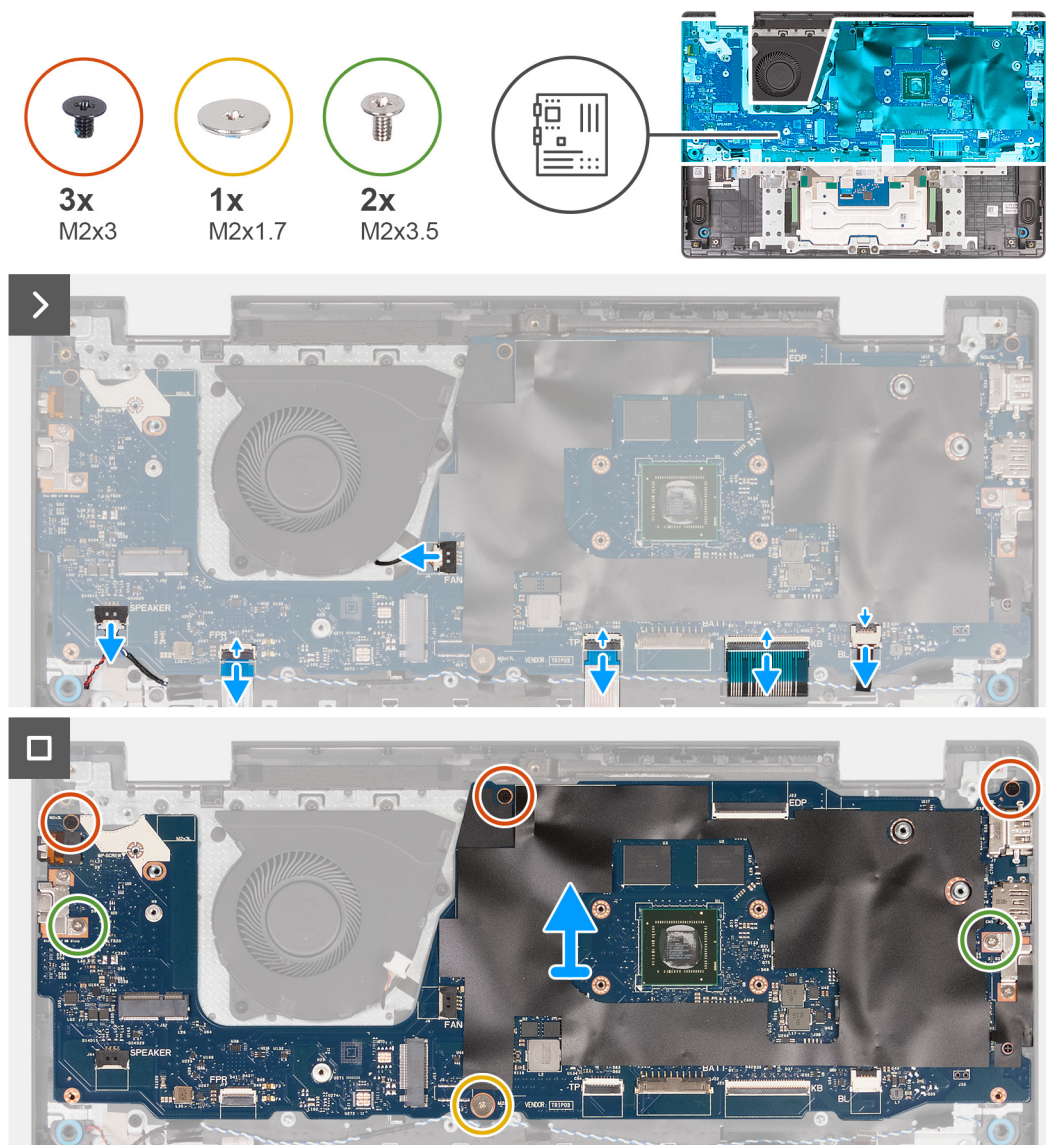
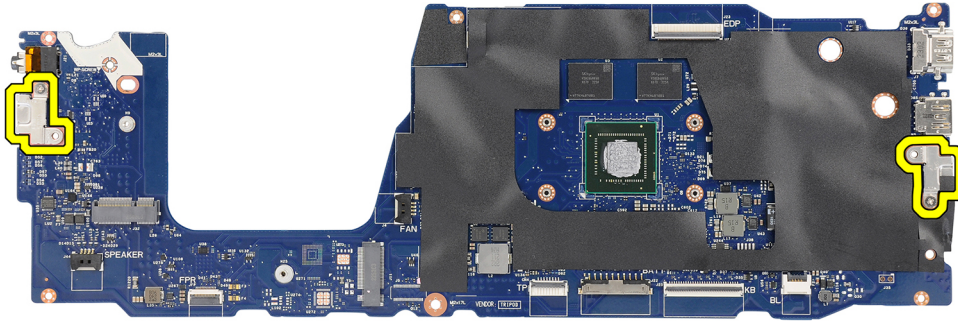

Figure 43. Removing the system board

Steps

1. Disconnect the speaker cable, fingerprint reader cable (for computers shipped with a fingerprint reader), touchpad cable, keyboard cable, keyboard backlight cable (for computers shipped with keyboard backlight), and fan cable from the system board.
2. Remove the screw (M2x1.7), three screws (M2x3), and two screws (M2x3.5) that secure the system board to the palm-rest and keyboard assembly.

i NOTE: The two USB Type-C brackets on the left and right side of the system board are secured in place by a single M2x3.5 screw each. They are bundled with the system board as a service part and must not be removed from the system board.



Installing the system board

CAUTION: The information in this installation section is intended for authorized service technicians only.

Prerequisites

If you are replacing a component, remove the existing component before performing the installation process.

About this task

The following images indicate the system board connectors.

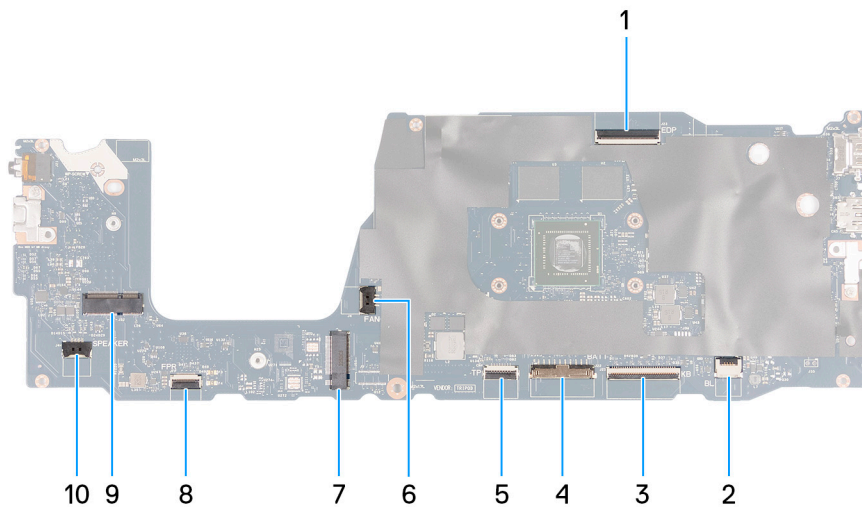

Figure 44. System board connectors

- | | |
|-----------------------------|---|
| 1. Display cable connector | 2. Keyboard-backlight cable connector (for computers shipped with keyboard backlight) |
| 3. Keyboard cable connector | 4. Battery cable connector |
| 5. Touchpad cable connector | 6. Fan cable connector |
| 7. Solid-state drive slot | 8. Fingerprint-reader cable connector (for computers shipped with a fingerprint reader) |
| 9. Wireless-card slot | 10. Speaker cable connector |

The following images indicate the location of the system board and provide a visual representation of the installation procedure.

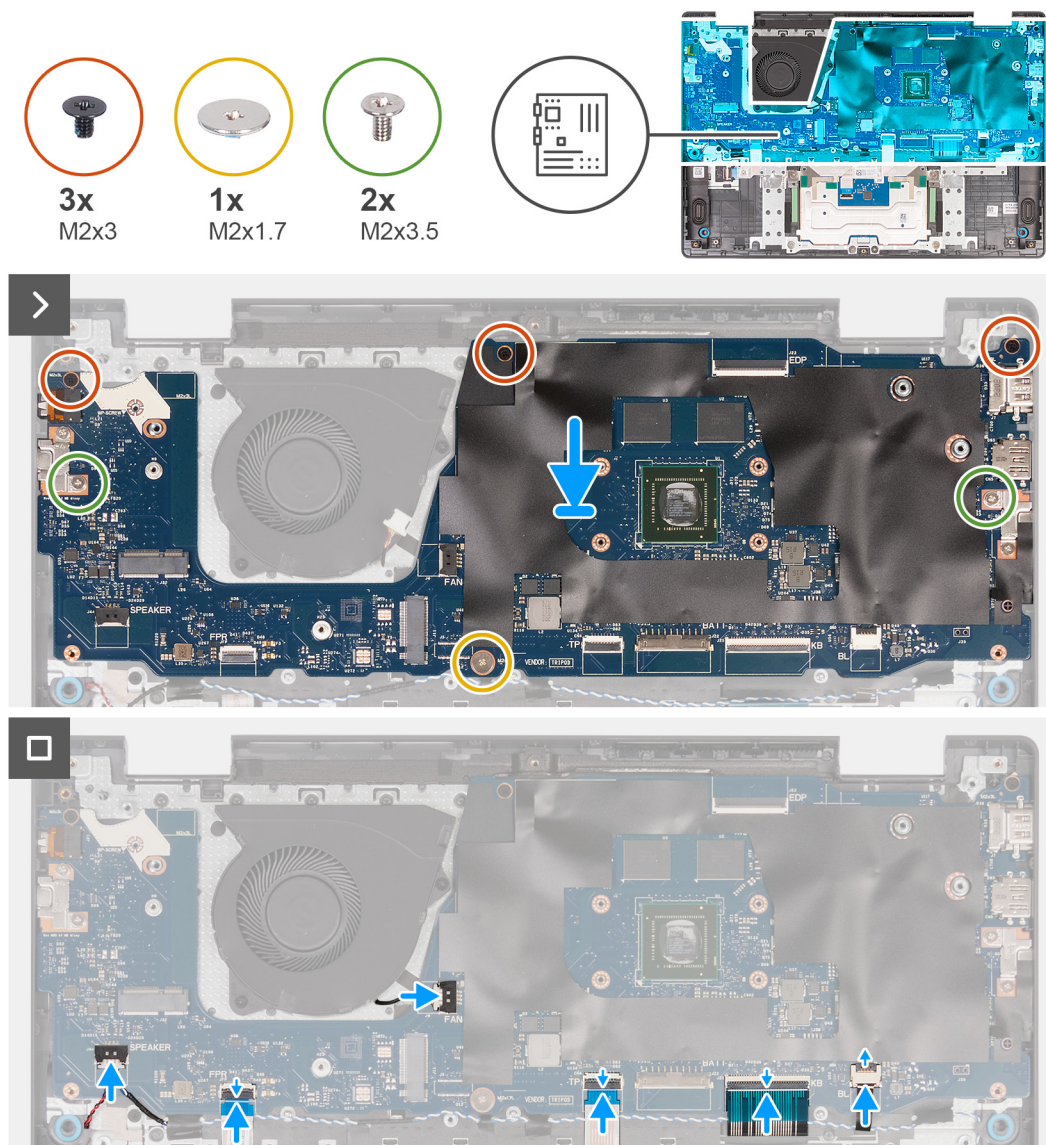

Figure 45. Installing the system board

Steps

1. Align the screw holes on the system board with the screw holes on the palm-rest and keyboard assembly.
2. Replace the screw (M2x1.7), three screws (M2x3), and two screws (M2x3.5) that secure the system board to the palm-rest and keyboard assembly.
3. Connect the speaker cable, fingerprint reader cable (for computers shipped with a fingerprint reader), touchpad cable, keyboard cable, keyboard backlight cable (for computers shipped with keyboard backlight), and fan cable from the system board.

NOTE: After replacing the system board, the service technician must run the RMA Shim. The RMA Shim USB Key including its instructions will be dispatched with the service replacement system board.

Next steps

1. Install the [display assembly](#).
2. Install the [heat sink](#).
3. Install the [wireless card](#).
4. Install the [M.2 2230 solid-state drive](#).
5. Install the [base cover](#).
6. Follow the procedure in [After working inside your computer](#).

Camera module

Removing the camera module

CAUTION: The information in this removal section is intended for authorized service technicians only.

Prerequisites

1. Follow the procedure in [Before working inside your computer](#).
2. Remove the [base cover](#).
3. Remove the [wireless card](#).
4. Remove the [display assembly](#).
5. Remove the [display bezel](#).
6. Remove the [display hinges](#).
7. Remove the [display panel](#).

About this task

The following images indicate the location of the camera module and provide a visual representation of the removal procedure.

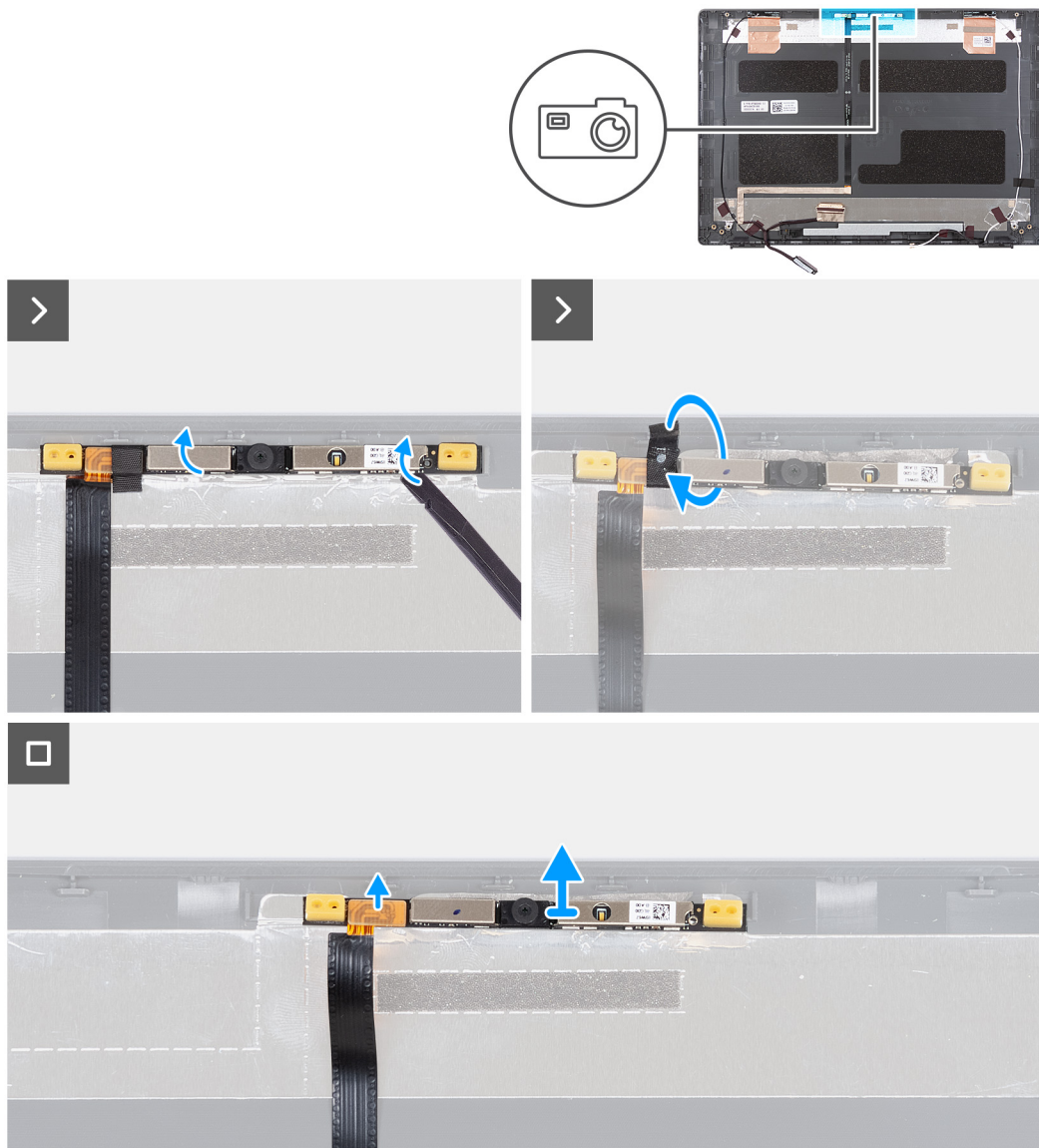

Figure 46. Removing the camera module

Steps

1. Carefully pry up the camera module from the recesses at the bottom edge of the camera module.

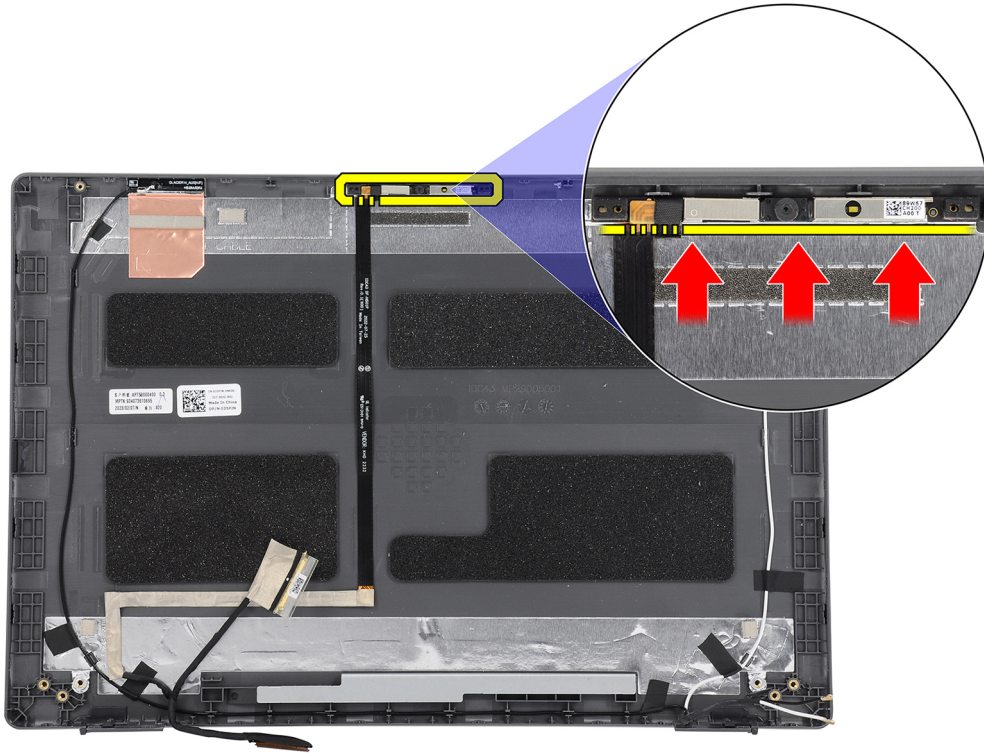

Figure 47. Removing the camera module

2. Peel the tape that is covering the display cable connector.
3. Disconnect the display cable from the camera and lift the camera module from the display back cover.

Installing the camera module

CAUTION: The information in this installation section is intended for authorized service technicians only.

Prerequisites

If you are replacing a component, remove the existing component before performing the installation process.

About this task

The following images indicate the location of the camera module and provide a visual representation of the installation procedure.

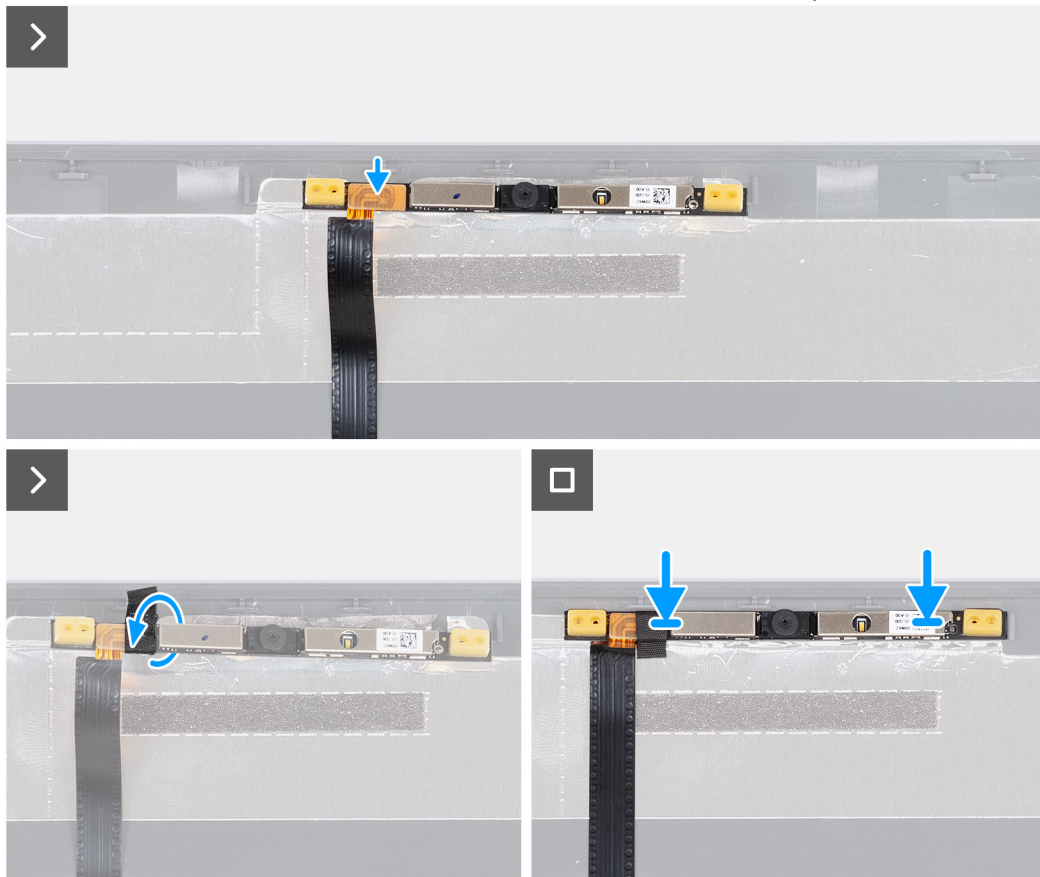
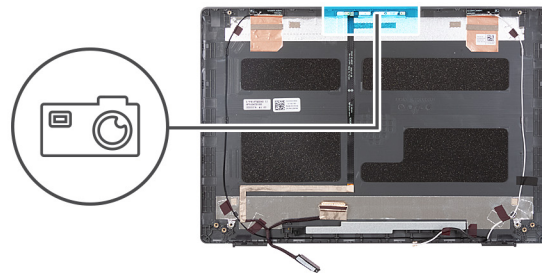

Figure 48. Installing the camera module

Steps

1. Align the camera module with the pins on the display back cover.
2. Connect the camera module cable to the connector on the camera module.
3. Adhere the tape that secures the camera cable to the camera.

Next steps

1. Install the [display panel](#).
2. Install the [display hinges](#).
3. Install the [display bezel](#).
4. Install the [display assembly](#).
5. Install the [wireless card](#).
6. Install the [base cover](#).
7. Follow the procedure in [After working inside your computer](#).

Display cable

Removing the display cable

CAUTION: The information in this removal section is intended for authorized service technicians only.

Prerequisites

1. Follow the procedure in [Before working inside your computer](#).
2. Remove the [base cover](#).
3. Remove the [wireless card](#).
4. Remove the [display assembly](#).
5. Remove the [display bezel](#).
6. Remove the [display hinges](#).
7. Remove the [display panel](#).
8. Remove the [camera module](#).

About this task

The following images indicate the location of the display cable and provide a visual representation of the removal procedure.

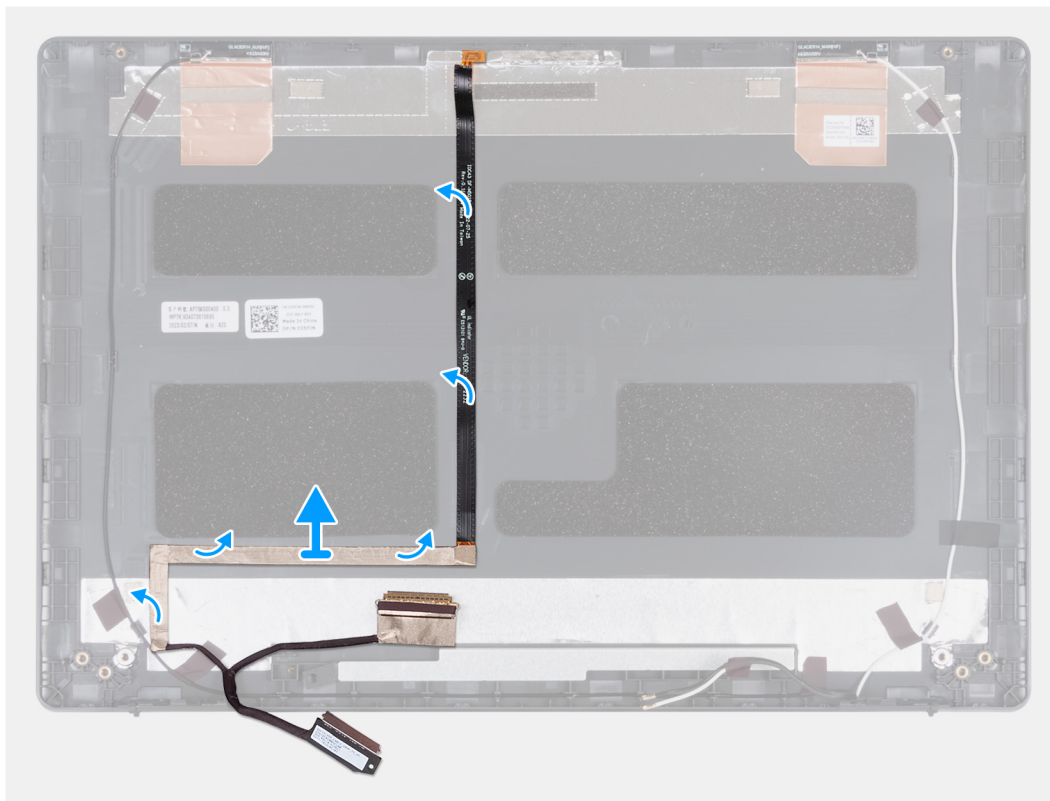

Figure 49. Removing the display cable

Steps

1. Peel the display cable that is adhered to the display back cover.
2. Lift the display cable off the display back cover.

Installing the display cable

CAUTION: The information in this installation section is intended for authorized service technicians only.

Prerequisites

If you are replacing a component, remove the existing component before performing the installation process.

About this task

The following images indicate the location of the display cable and provide a visual representation of the installation procedure.

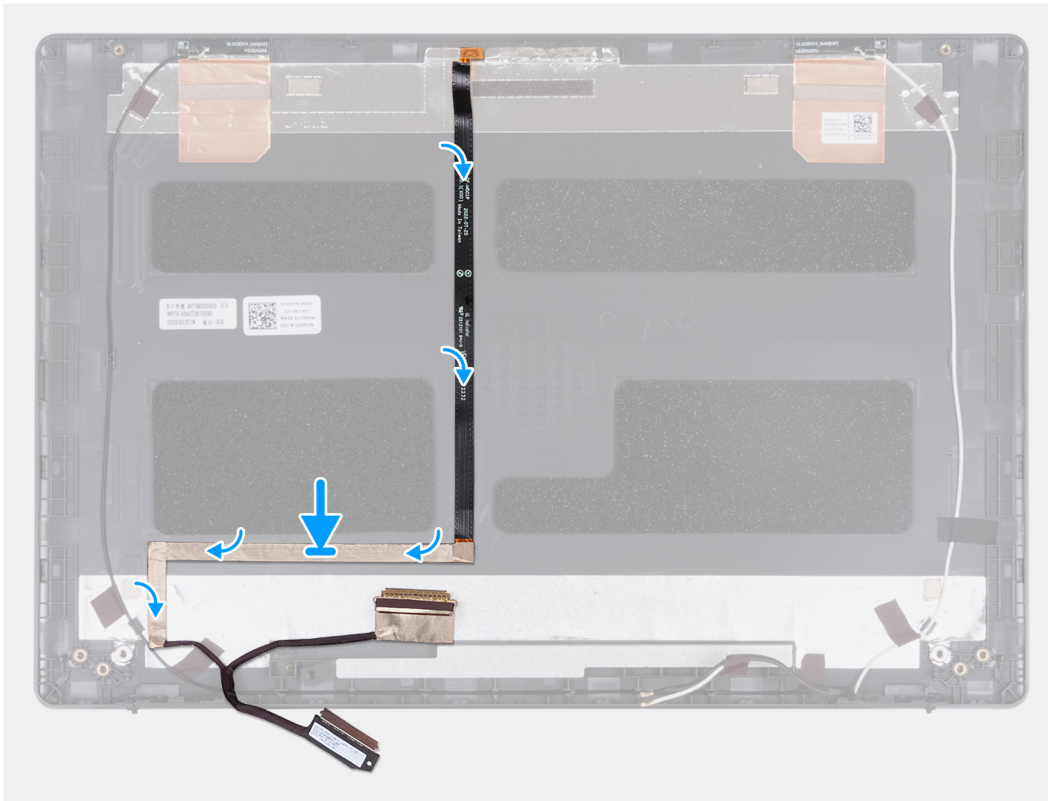

Figure 50. Installing the display cable

Steps

1. Place the display cable on the display back cover.
2. Adhere the display cable to the display back cover.

Next steps

1. Install the [camera module](#).
2. Install the [display panel](#).
3. Install the [display hinges](#).
4. Install the [display bezel](#).
5. Install the [display assembly](#).
6. Install the [wireless card](#).
7. Install the [base cover](#).
8. Follow the procedure in [After working inside your computer](#).

Display back cover and antenna assembly

Removing the display back cover and antenna assembly

CAUTION: The information in this removal section is intended for authorized service technicians only.

Prerequisites

1. Follow the procedure in [Before working inside your computer](#).
2. Remove the [base cover](#).
3. Remove the [wireless card](#).
4. Remove the [display assembly](#).
5. Remove the [display bezel](#).
6. Remove the [display hinges](#).
7. Remove the [display panel](#).
8. Remove the [camera module](#).
9. Remove the [display cable](#).

About this task

The following images indicate the location of the display back cover and antenna assembly and provide a visual representation of the removal procedure.

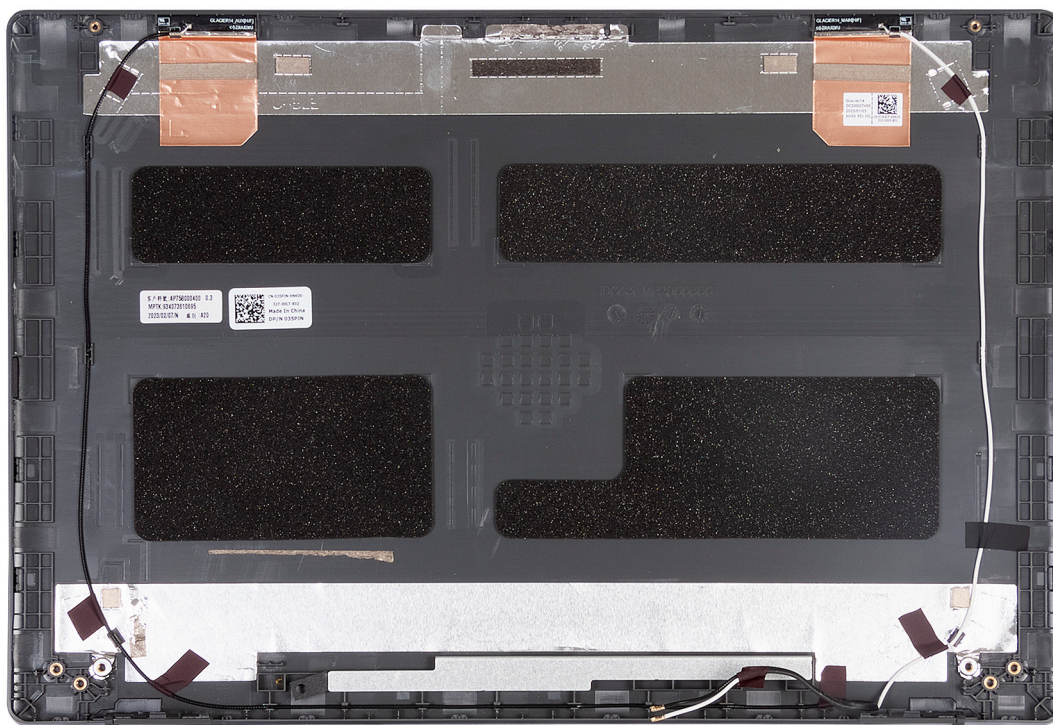

Figure 51. Removing the display back cover and antenna assembly

Steps

After performing the steps in the pre-requisites, we are left with the display back cover and antenna assembly.

NOTE: The display back cover and antenna assembly cannot be further disassembled after performing all the steps in the pre-requisites. If the antenna cables are malfunctioning and must be replaced, replace the entire display back cover and antenna assembly.

Installing the display back cover and antenna assembly

CAUTION: The information in this installation section is intended for authorized service technicians only.

Prerequisites

If you are replacing a component, remove the existing component before performing the installation process.

About this task

The following images indicate the location of the display back cover and antenna assembly and provide a visual representation of the installation procedure.

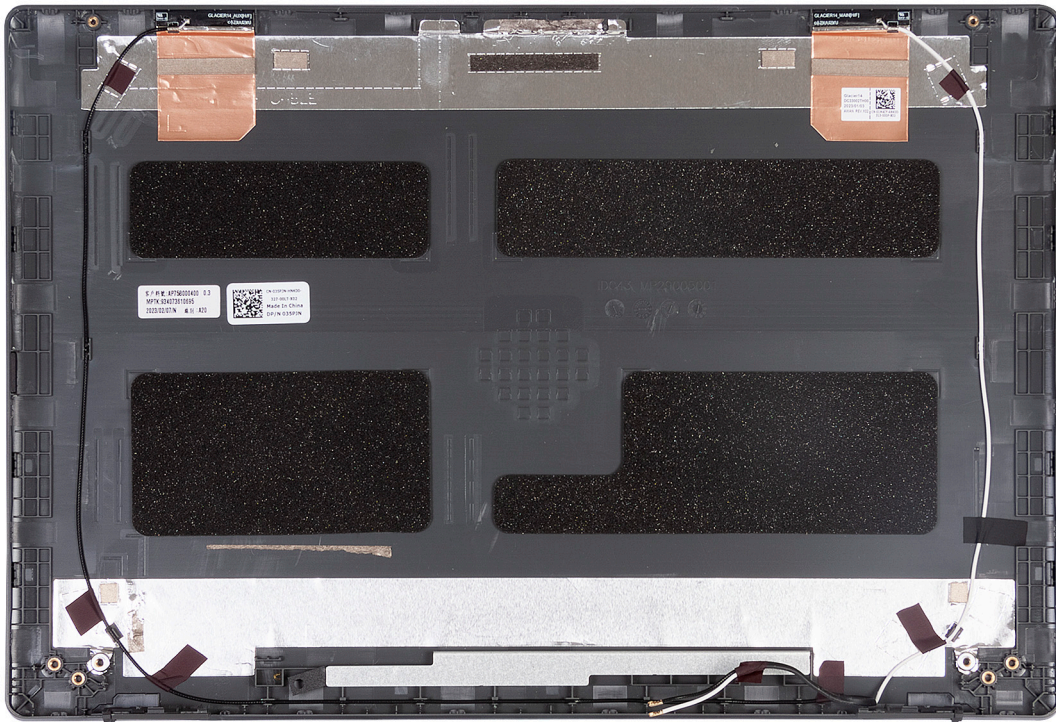

Figure 52. Installing the display back cover and antenna assembly

Steps

Place the display back cover and antenna assembly on a flat surface.

Next steps

1. Install the [display cable](#).
2. Install the [camera module](#).
3. Install the [display panel](#).
4. Install the [display hinges](#).
5. Install the [display bezel](#).
6. Install the [display assembly](#).
7. Install the [wireless card](#).
8. Install the [base cover](#).
9. Follow the procedure in [After working inside your computer](#).

Palm-rest and keyboard assembly

Removing the palm-rest and keyboard assembly

CAUTION: The information in this removal section is intended for authorized service technicians only.

Prerequisites

1. Follow the procedure in [Before working inside your computer](#).
2. Remove the [base cover](#).
3. Remove the [M.2 2230 solid-state drive](#).
4. Remove the [wireless card](#).
5. Remove the [fan](#).
6. Remove the [battery](#).
7. Remove the [heat sink](#).
8. Remove the [display assembly](#).
9. Remove the [speakers](#).
10. Remove the [system board](#).

About this task

- NOTE:** The system board can be removed and installed with the heatsink attached to simplify the procedure and preserve the thermal bond between the system board and heatsink.
- NOTE:** The palm-rest and keyboard assembly cannot be further disassembled once all the pre-removal parts procedures are completed. If the fingerprint-reader (for computers shipped with a fingerprint reader), touchpad frame, touchpad support bracket, touchpad module, or touchpad FFC are malfunctioning and has to be replaced, replace the entire palm-rest and keyboard assembly.

The following image shows the palm-rest and keyboard assembly after performing the pre-removal parts procedures for any palm-rest and keyboard assembly replacement.

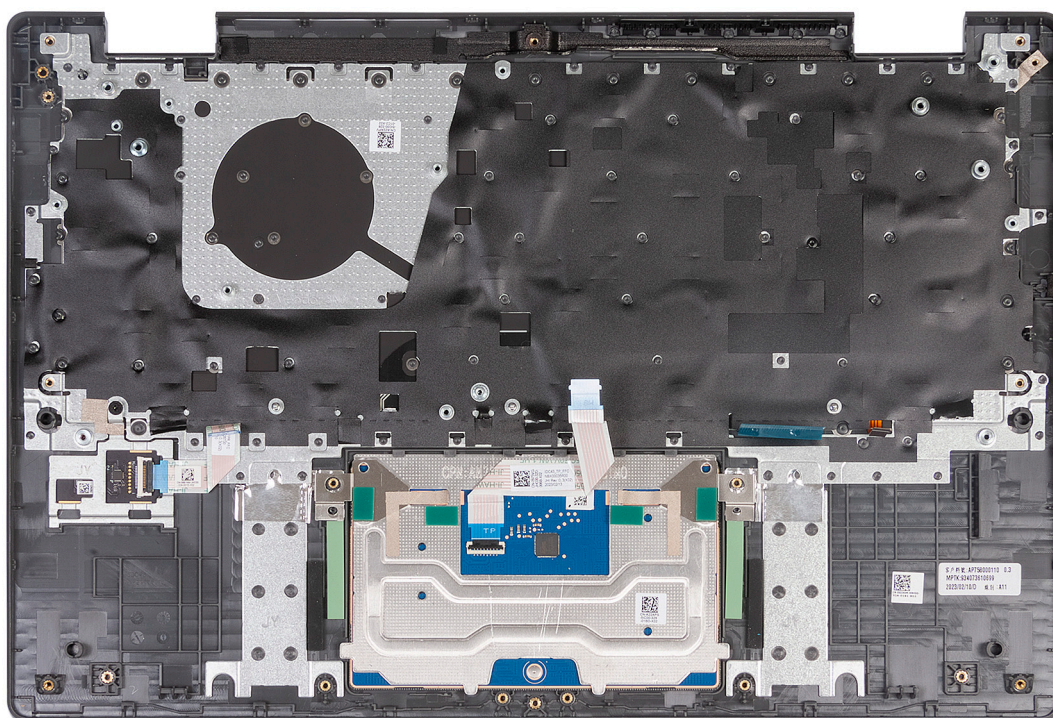

Figure 53. Removing the palm-rest assembly

Steps

After performing the pre-requisites, you are left with the palm-rest and keyboard assembly.

Installing the palm-rest and keyboard assembly

CAUTION: The information in this installation section is intended for authorized service technicians only.

Prerequisites

If you are replacing a component, remove the existing component before performing the installation procedure.

About this task

The following image indicates the location of the palm-rest and keyboard assembly.

Figure 54. Installing the palm-rest and keyboard assembly

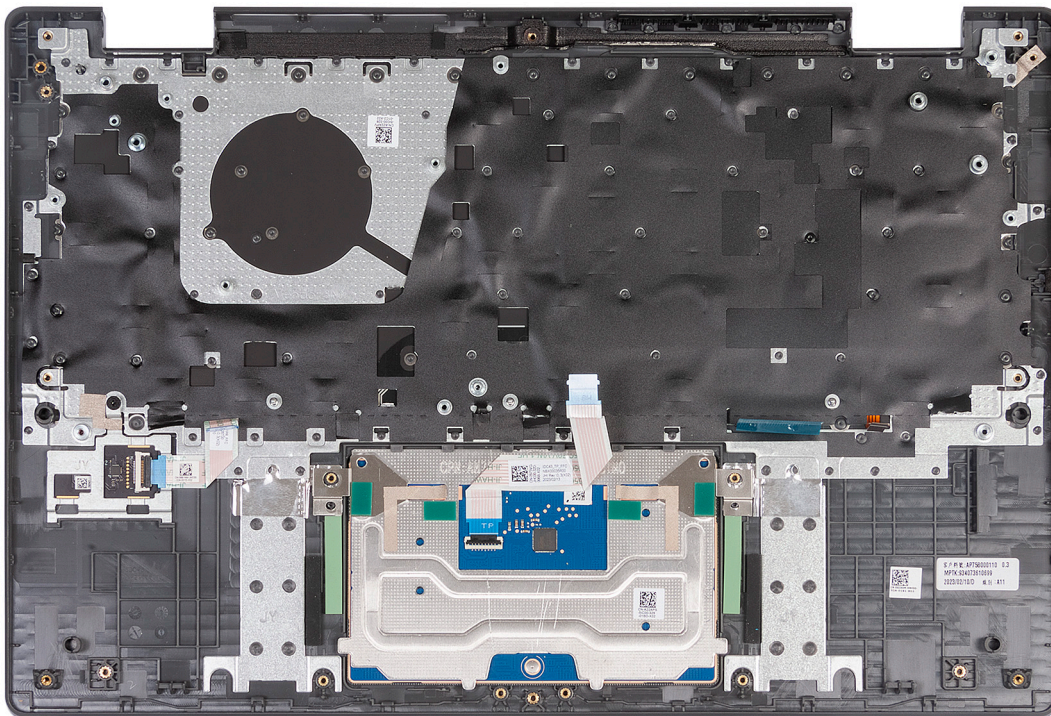

Steps

Place the palm-rest and keyboard assembly on a flat surface and perform the post requisites to install the palm-rest and keyboard assembly.

Next steps

1. Install the [system board](#).
2. Install the [speakers](#).
3. Install the [display assembly](#).
4. Install the [heat sink](#).
5. Install the [battery](#).
6. Install the [fan](#).
7. Install the [wireless card](#).
8. Install the [M.2 2230 solid-state drive](#).
9. Install the [base cover](#).

10. Follow the procedure in [After working inside your computer](#).

Software

This chapter details the supported operating systems along with instructions on how to install the drivers.

Operating system

Your Latitude 3445 Chromebook supports the following operating systems:

- ChromeOS R112 and above

Operating system

This page contains information about the operating system that is used in Latitude 3445 Chromebook.

ChromeOS

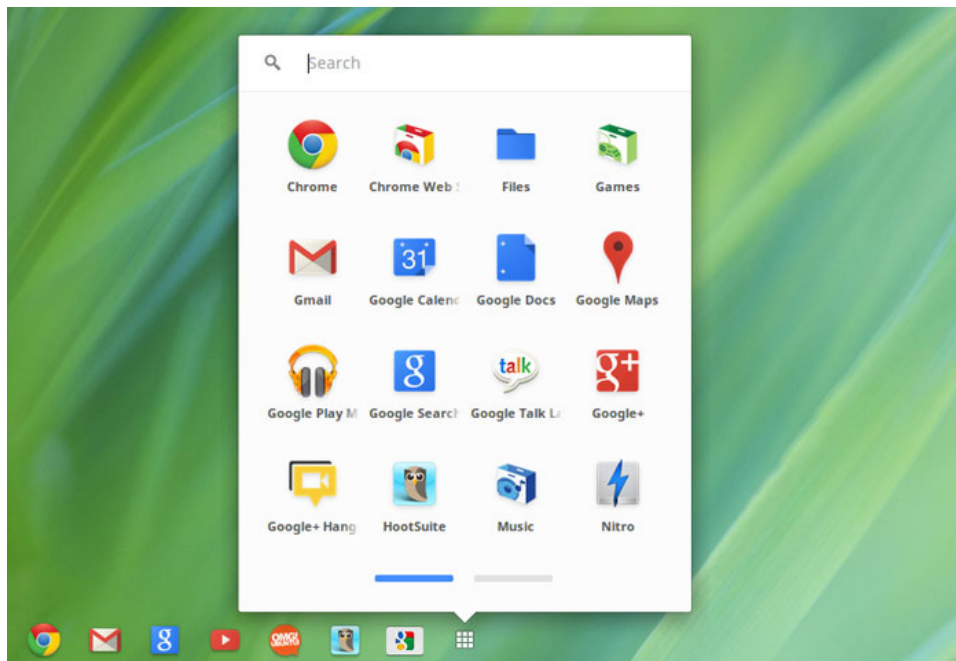

Figure 55. ChromeOS

Chromebooks are powered by the Google Chrome operating system, based on Google's popular Chrome browser. It has been developed to provide a fast, simple, and more secure computing experience for users who spend most of their time online.

Key Benefits

- Speed
- Simplicity
- Security
- Updatability
- Synchronizability
- High power at low cost

- Easy to learn and use
- Documents, calendar, email, contacts, and tasks available online and offline, and all securely backed-up and synchronized in the cloud.
- Access to the Chrome web app store
- Killer web apps
- The latest Intel Core processors
- Fun games
- Built-in support for popular file types and external devices

Verified Boot

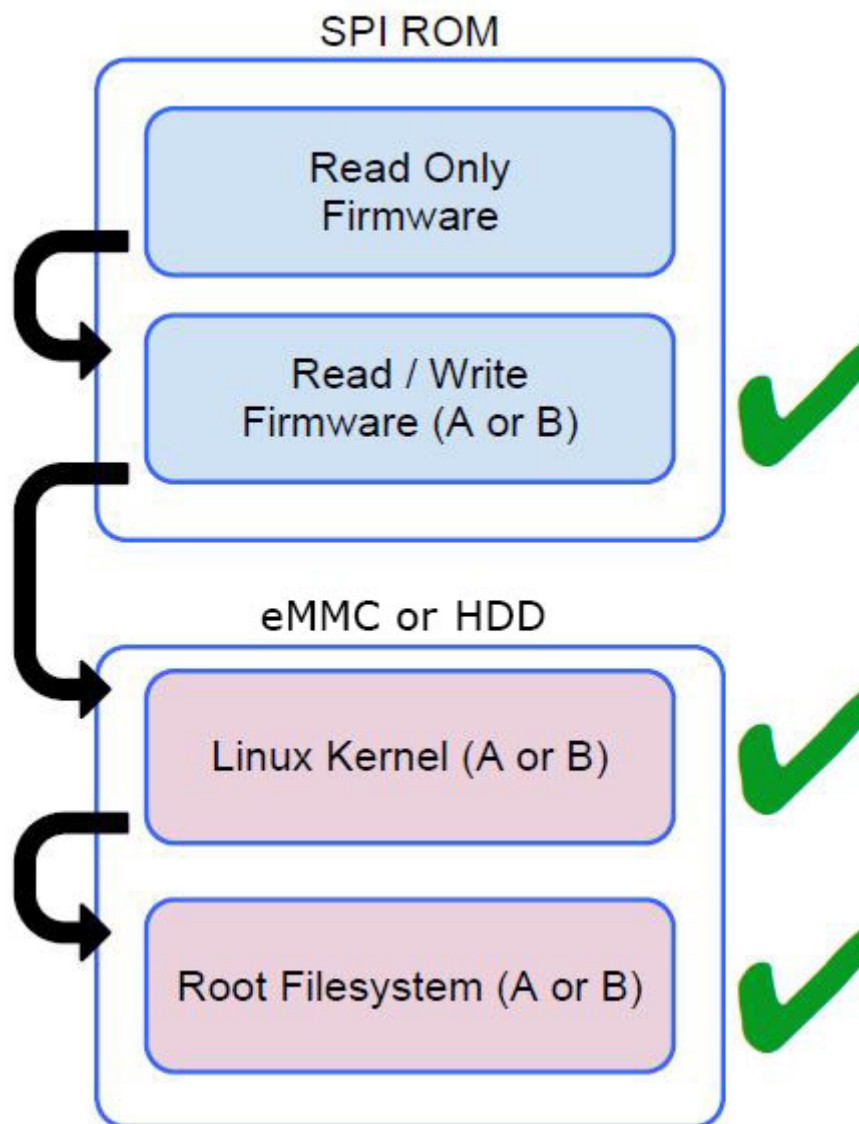

Figure 56. Verified boot

Read Only firmware verifies the integrity of Read/Write (R/W) firmware. R/W firmware verifies the active Linux kernel. During run time, the kernel verifies each block that is read from disk.

If a verification step fails and there is no backup option, the machine enters recovery mode.

The Developer Mode switch turns off verified boot (at the Kernel stage) to enable users to run Chromium operating system (or other operating system). The BIOS is always verified.

Disk Partition Map

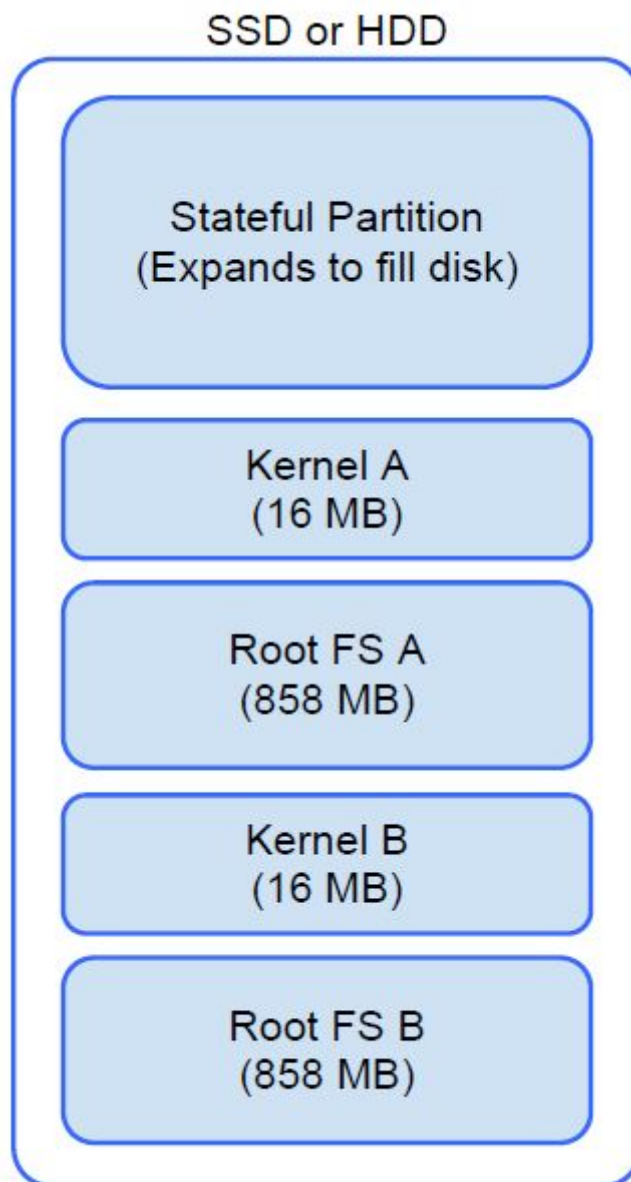



Figure 57. Disk Partition map

There are two copies of ChromeOS on disk: an active copy and a backup copy. Each copy consists of a kernel partition and a root file system. The backup copy is updated automatically in the background. Users have to reboot. The partition contains encrypted user data and is also used in the factory for storing test software.

Developer and Recovery mode

Table 26. Developer and Recovery mode

Developer Mode	Recovery Mode
<p style="text-align: center;">Developer Mode BIOS screen</p> 	<p style="text-align: center;">Recovery Mode BIOS screen</p> 
<ul style="list-style-type: none"> • Used to boot without verification. • Can be turned on using key combination during boot. • Stateful partition is wiped during transitions. • Used in the factory to boot test image. 	<ul style="list-style-type: none"> • Enables you to reinstall the ChromeOS from a USB drive or SD card. • Recovery mode is entered if verified boot fails. • A user can force recovery mode using a key combination during boot.

Coreboot and U-boot Custom Firmware

Coreboot (x86 only)

- Memory and chipset initialization
- Open-source, except for MRC binary from Intel.

U-Boot

- Performs verified boot
- Handles recovery and Developer Mode
- Open source code

Normal boot is very fast, as it takes less than one second to start loading kernel. Chromebook does not boot other operating systems such as Windows or operating system X.

Chrome vs Chromium operating system

Table 27. Difference between Chromium and Chrome OS

Difference between Chromium and ChromeOS	
Chromium operating system	ChromeOS
<ul style="list-style-type: none"> • Is an open source project: http://www.chromium.org/chromium-os • Runs on regular computers and Chrome devices 	<ul style="list-style-type: none"> • Is based on Chromium operating system • Only runs on the Chrome devices with required hardware features (TPM, RO firmware, recovery button, developer switch). • Includes additional licensed features such as the Netflix plug-in, video codecs, and fonts

View system information

This page contains all the information about viewing system information for the Dell Chromebook.

Latitude 3445 Chromebook does not support Dell BIOS. Hence, there are several ways to check system specifications depending on the information you are searching for. The table below lists some of the most commonly used methods to view system information and specifications.

Table 28. View system information

Commands	Action and Purpose	Screenshot
Chrome://help	View basic OS information.	 <p>The screenshot shows the Chrome OS 'About' page in a browser window. The address bar displays 'chrome://help'. The page title is 'Chrome OS About'. On the left, there is a navigation menu with options: History, Extensions, Settings, and Help (which is selected). The main content area displays 'Google Chrome OS' with the tagline 'The faster, simpler, and more secure computer'. Below this, there are two buttons: 'Get help with using Chrome OS' and 'Report an issue'. The system information section lists: 'Version 31.0.1650.43 beta', 'Platform 4731.50.0 (Official Build) beta-channel wolf', and 'Firmware Google_Wolf.4389.24.35'. There is a status indicator 'Checking for updates...' and a 'More info...' link. At the bottom, there is copyright information for Google Chrome (2013) and links to 'Chromium', 'open source software', and 'Terms of Service'.</p>

Table 28. View system information (continued)

Commands	Action and Purpose	Screenshot																																																
<p>Chrome://settings</p>	<p>View information such as screen resolution options (Device>Display settings), touchpad, and other basic hardware information.</p>	 <p>The screenshot shows the Chrome OS Settings application. The left sidebar contains 'History', 'Extensions', 'Settings', and 'Help'. The main content area is titled 'Settings' and includes sections for 'Internet connection' (with Wi-Fi network 'delguest' selected), 'Appearance' (with buttons for 'Set wallpaper...', 'Get themes', and 'Reset to default theme'), 'Device' (with a 'Touchpad speed' slider and buttons for 'Touchpad settings', 'Keyboard settings', and 'Display settings'), and 'Search' (with a dropdown for 'Google' and a 'Manage search engines...' button). A 'Show advanced settings...' link is at the bottom.</p>																																																
<p>Chrome://system</p>	<p>View advanced system information such as the Google Chrome version, BIOS information, CPU information, memory information, network status, power supply information, and so on.</p>	 <p>The screenshot shows the 'About System' page in Chrome OS. It features a blue header with 'About System' and 'System diagnostic data'. Below are 'Expand all...' and 'Collapse all...' buttons. A table lists system details:</p> <table border="1" data-bbox="663 1335 1393 1933"> <thead> <tr> <th>Key</th> <th>Value</th> </tr> </thead> <tbody> <tr><td>CHROME_VERSION</td><td>31.0.1650.43 beta</td></tr> <tr><td>CHROMEOS_AUSERVER</td><td>https://tools.google.com/service/update2</td></tr> <tr><td>CHROMEOS_BOARD_APPID</td><td>{1E454867-ACF6-5F88-091F-14568004A7F5}</td></tr> <tr><td>CHROMEOS_CANARY_APPID</td><td>{90F229CE-83E2-4FAF-8479-E368A34938B1}</td></tr> <tr><td>CHROMEOS_DEVSERVER</td><td><no value></td></tr> <tr><td>CHROMEOS_RELEASE_APPID</td><td>{1E454867-ACF6-5F88-091F-14568004A7F5}</td></tr> <tr><td>CHROMEOS_RELEASE_BOARD</td><td>wolf-signed-preemkeys</td></tr> <tr><td>CHROMEOS_RELEASE_DESCRIPTION</td><td>4731.50.0 (Official Build) beta-channel wolf</td></tr> <tr><td>CHROMEOS_RELEASE_NAME</td><td>Chrome OS</td></tr> <tr><td>CHROMEOS_RELEASE_TRACK</td><td>beta-channel</td></tr> <tr><td>CHROMEOS_RELEASE_VERSION</td><td>4731.50.0</td></tr> <tr><td>CLIENT_ID</td><td>46FEAC026B48470090CF0E6A8655735A</td></tr> <tr><td>GOOGLE_RELEASE</td><td>4731.50.0</td></tr> <tr><td>LOGDATE</td><td>[Expand...]</td></tr> <tr><td>Profile[0] chrome_user_log</td><td>[Expand...]</td></tr> <tr><td>Profile[0] login-times</td><td><not available></td></tr> <tr><td>Profile[0] logout-times</td><td><not available></td></tr> <tr><td>xorg.0.log</td><td>[Expand...]</td></tr> <tr><td>alsa controls</td><td>[Expand...]</td></tr> <tr><td>bios_info</td><td>[Expand...]</td></tr> <tr><td>bios_log</td><td>[Expand...]</td></tr> <tr><td>bios_times</td><td>[Expand...]</td></tr> <tr><td>board-specific</td><td>[Expand...]</td></tr> </tbody> </table>	Key	Value	CHROME_VERSION	31.0.1650.43 beta	CHROMEOS_AUSERVER	https://tools.google.com/service/update2	CHROMEOS_BOARD_APPID	{1E454867-ACF6-5F88-091F-14568004A7F5}	CHROMEOS_CANARY_APPID	{90F229CE-83E2-4FAF-8479-E368A34938B1}	CHROMEOS_DEVSERVER	<no value>	CHROMEOS_RELEASE_APPID	{1E454867-ACF6-5F88-091F-14568004A7F5}	CHROMEOS_RELEASE_BOARD	wolf-signed-preemkeys	CHROMEOS_RELEASE_DESCRIPTION	4731.50.0 (Official Build) beta-channel wolf	CHROMEOS_RELEASE_NAME	Chrome OS	CHROMEOS_RELEASE_TRACK	beta-channel	CHROMEOS_RELEASE_VERSION	4731.50.0	CLIENT_ID	46FEAC026B48470090CF0E6A8655735A	GOOGLE_RELEASE	4731.50.0	LOGDATE	[Expand...]	Profile[0] chrome_user_log	[Expand...]	Profile[0] login-times	<not available>	Profile[0] logout-times	<not available>	xorg.0.log	[Expand...]	alsa controls	[Expand...]	bios_info	[Expand...]	bios_log	[Expand...]	bios_times	[Expand...]	board-specific	[Expand...]
Key	Value																																																	
CHROME_VERSION	31.0.1650.43 beta																																																	
CHROMEOS_AUSERVER	https://tools.google.com/service/update2																																																	
CHROMEOS_BOARD_APPID	{1E454867-ACF6-5F88-091F-14568004A7F5}																																																	
CHROMEOS_CANARY_APPID	{90F229CE-83E2-4FAF-8479-E368A34938B1}																																																	
CHROMEOS_DEVSERVER	<no value>																																																	
CHROMEOS_RELEASE_APPID	{1E454867-ACF6-5F88-091F-14568004A7F5}																																																	
CHROMEOS_RELEASE_BOARD	wolf-signed-preemkeys																																																	
CHROMEOS_RELEASE_DESCRIPTION	4731.50.0 (Official Build) beta-channel wolf																																																	
CHROMEOS_RELEASE_NAME	Chrome OS																																																	
CHROMEOS_RELEASE_TRACK	beta-channel																																																	
CHROMEOS_RELEASE_VERSION	4731.50.0																																																	
CLIENT_ID	46FEAC026B48470090CF0E6A8655735A																																																	
GOOGLE_RELEASE	4731.50.0																																																	
LOGDATE	[Expand...]																																																	
Profile[0] chrome_user_log	[Expand...]																																																	
Profile[0] login-times	<not available>																																																	
Profile[0] logout-times	<not available>																																																	
xorg.0.log	[Expand...]																																																	
alsa controls	[Expand...]																																																	
bios_info	[Expand...]																																																	
bios_log	[Expand...]																																																	
bios_times	[Expand...]																																																	
board-specific	[Expand...]																																																	

Table 28. View system information (continued)

Commands	Action and Purpose	Screenshot
<p>Chrome://net-internals</p>	<p>View advanced networking information.</p>	 <p>The screenshot shows the Chrome://net-internals/#export page. A dropdown menu is open, listing various export options: Export (highlighted), Capture, Import, Proxy, Events, Waterfall, Timeline, DNS, Sockets, SPDY, QUIC, Pipelining, Cache, Modules, Tests, Log Visualizer, HSTS, Logs, Bandwidth, and Prerender. The main content area shows a red header 'capturing events (4)' and a text box with the message 'Information (cookies and credentials) went wrong here. (These notes will be in the dump file. Be sure to mention the error, so investigators know what to look for)'. A blue link 'Provide data for bug reports' is visible at the bottom of the content area.</p>

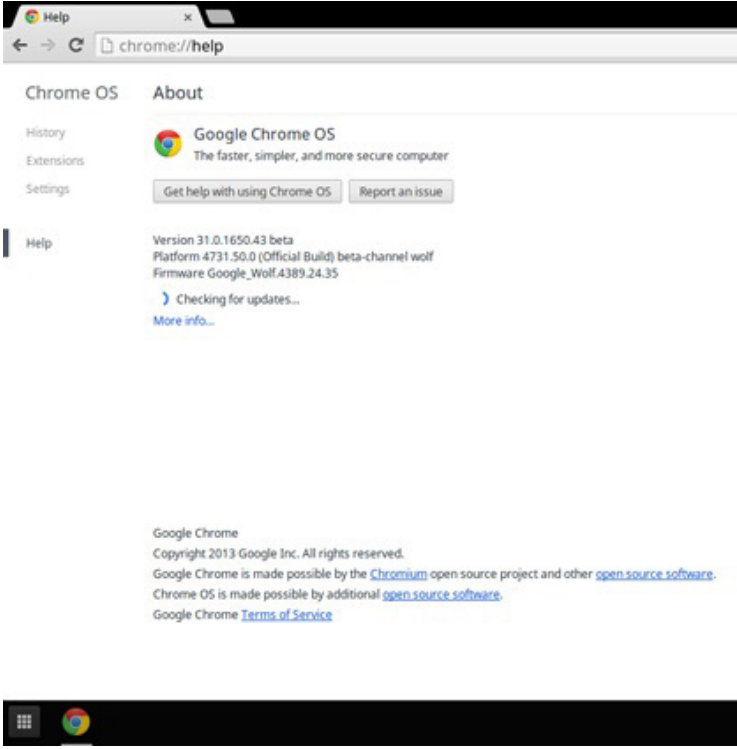
Troubleshooting

Handling swollen rechargeable Li-ion batteries

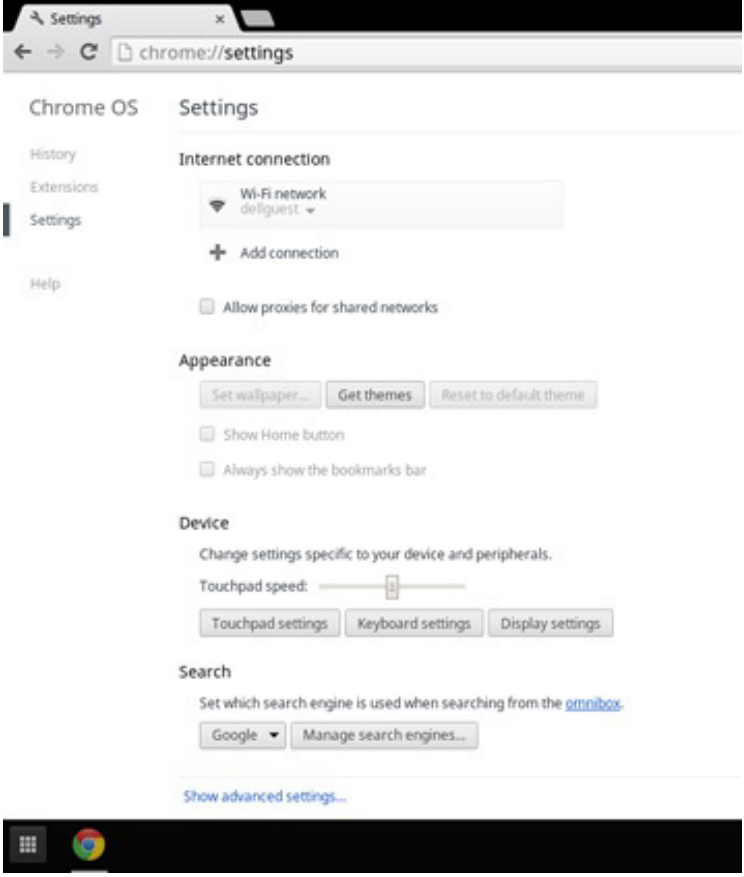
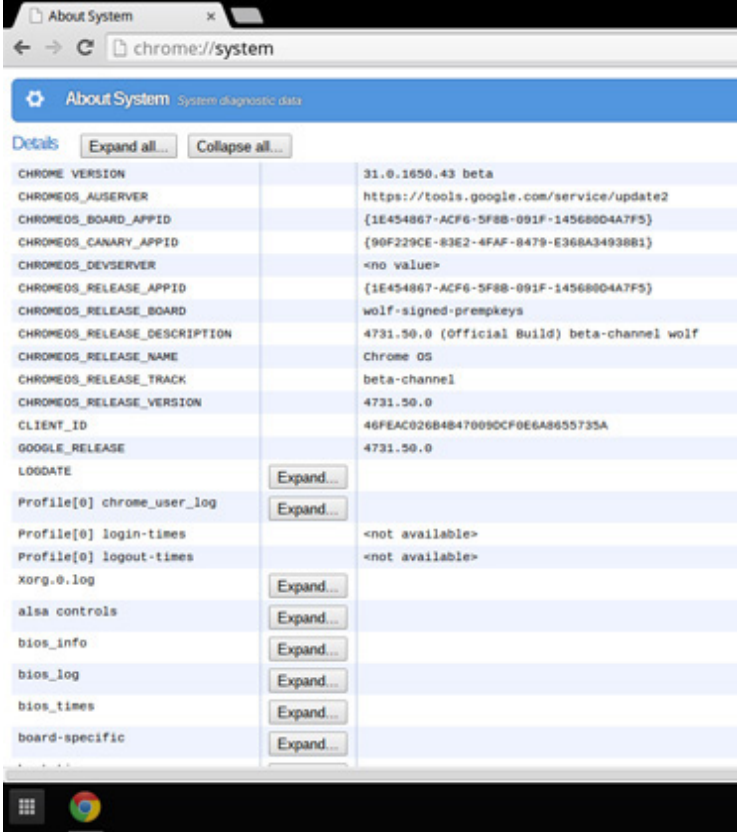
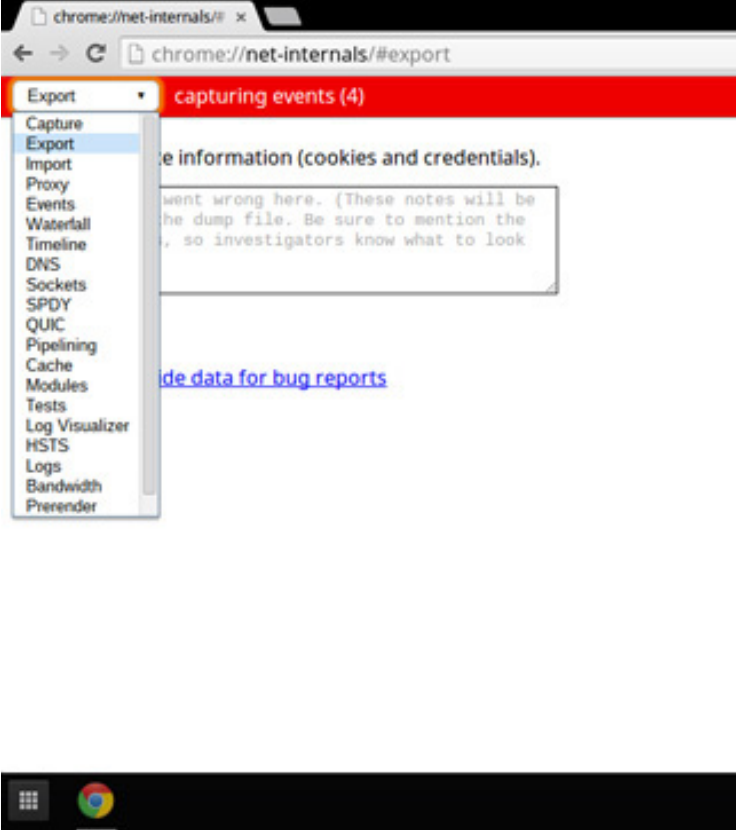
Like most laptops, Dell laptops use Lithium-ion batteries. One type of Lithium-ion battery is the rechargeable Li-ion battery. Rechargeable Li-ion batteries have increased in popularity in recent years and have become standard in the electronics industry due to customer preferences for a slim form factor (especially with newer ultra-thin laptops) and long battery life. Inherent to rechargeable Li-ion battery technology is the potential for swelling of the battery cells.

Swollen battery may impact the performance of the laptop. To prevent possible further damage to the device enclosure or internal components leading to malfunction, discontinue the use of the laptop and discharge it by disconnecting the AC adapter and letting the battery drain.

Swollen batteries should not be used and should be replaced and disposed of properly. We recommend contacting Dell product support for options to replace a swollen battery under the terms of the applicable warranty or service contract, including options for replacement by a Dell authorized service technician.

The guidelines for handling and replacing rechargeable Li-ion batteries are as follows:

- Exercise caution when handling rechargeable Li-ion batteries.
- Discharge the battery before removing it from the system. To discharge the battery, unplug the AC adapter from the system and operate the system only on battery power. When the system will no longer power on when the power button is pressed, the battery is fully discharged.
- Do not crush, drop, mutilate, or penetrate the battery with foreign objects.
- Do not expose the battery to high temperatures, or disassemble battery packs and cells.
- Do not apply pressure to the surface of the battery.
- Do not bend the battery.
- Do not use tools of any type to pry on or against the battery.
- If a battery gets stuck in a device as a result of swelling, do not try to free it as puncturing, bending, or crushing a battery can be dangerous.
- Do not attempt to reassemble a damaged or swollen battery into a laptop.
- Swollen batteries that are covered under warranty should be returned to Dell in an approved shipping container (provided by Dell)—this is to comply with transportation regulations. Swollen batteries that are not covered under warranty should be disposed of at an approved recycling center. Contact Dell product support at <https://www.dell.com/support> for assistance and further instructions.
- Using a non-Dell or incompatible battery may increase the risk of fire or explosion. Replace the battery only with a compatible battery purchased from Dell that is designed to work with your Dell computer. Do not use a battery from other computers with your computer. Always purchase genuine batteries from <https://www.dell.com> or otherwise directly from Dell.

Rechargeable Li-ion batteries can swell for various reasons such as age, number of charge cycles, or exposure to high heat. For more information on how to improve the performance and lifespan of the laptop battery and to minimize the possibility of occurrence of the issue, search Dell Laptop Battery in the Knowledge Base Resource at www.dell.com/support.

Chrome Shell (CROSH)

About this task

The Latitude 3445 Chromebook does not support ePSA, Dell BIOS, the F12 boot menu, or DellConnect. There are no pre-boot diagnostics. All troubleshooting must be done inside the OS. Chrome Shell (CROSH) and the Chrome URL commands provide some troubleshooting tools, information, and advanced settings. CROSH is a command line interface similar to the Linux BASH or Windows command (cmd.exe) terminals. Chrome OS is based on Linux, but CROSH does not recognize most Linux commands. The most useful commands for troubleshooting are memtest, storage_test_1, storage_test_2, ping, and tracepath. Ping works differently than it does in Windows. By default, it repeats until you press **<Ctrl> + <C>**, and it does not show any statistics. The tracepath command is similar to the Windows traceroute command. A detailed explanation of the commands can be viewed below, by typing help, or help_advanced in CROSH.

The following are the steps for running the CROSH diagnostics:

Steps

1. Open the Chrome browser.
2. Press <Ctrl> + <Alt> + <T>.
3. Type in the CROSH command for diagnostics. Type **help** for a list of available commands.

Recovering the operating system

When your Chromebook's operating system (OS) isn't working properly, you can recover it. Recovery is removing and reinstalling the OS.

To know how to recover your Chromebook's operating system, see [Recover your Chromebook](https://support.google.com/chromebook) at <https://support.google.com/chromebook>

Wi-Fi power cycle

About this task

If your computer is unable to access the Internet due to Wi-Fi connectivity issues a Wi-Fi power cycle procedure may be performed. The following procedure provides the instructions on how to conduct a Wi-Fi power cycle:

 **NOTE:** Some ISPs (Internet Service Providers) provide a modem/router combo device.

Steps

1. Turn off your computer.
2. Turn off the modem.
3. Turn off the wireless router.
4. Wait for 30 seconds.
5. Turn on the wireless router.
6. Turn on the modem.
7. Turn on your computer.

Drain residual flea power (perform hard reset)

About this task

Flea power is the residual static electricity that remains in the computer even after it has been powered off and the battery is removed.

For your safety, and to protect the sensitive electronic components in your computer, you are requested to drain residual flea power before removing or replacing any components in your computer.

Draining residual flea power, also known as a performing a "hard reset", is also a common troubleshooting step if your computer does not power on or boot into the operating system.

To drain residual flea power (perform a hard reset)

Steps

1. Turn off your computer.
2. Disconnect the power adapter from your computer.
3. Remove the base cover.
4. Disconnect the battery cable.
5. Press and hold the power button for 20 seconds to drain the flea power.
6. Connect the battery cable.

7. Install the base cover.
8. Connect the power adapter to your computer.
9. Turn on your computer.

NOTE: For more information about performing a hard reset, search in the Knowledge Base Resource at www.dell.com/support.

Chrome OS Pre-Boot Diagnostics

Latitude 3445 Chromebook supports a pre-boot diagnostic feature that enables you to test the memory and/or storage of the Chromebook if it fails to boot into the operating system. To run the diagnostics:

1. Disconnect any devices, such as USB storage devices, from the computer.
2. Press and hold **<Esc> + <Refresh> + <Power>**.



3. Release the button when a message appears on the screen.
4. In the recovery screen that appears select **Launch diagnostics**.

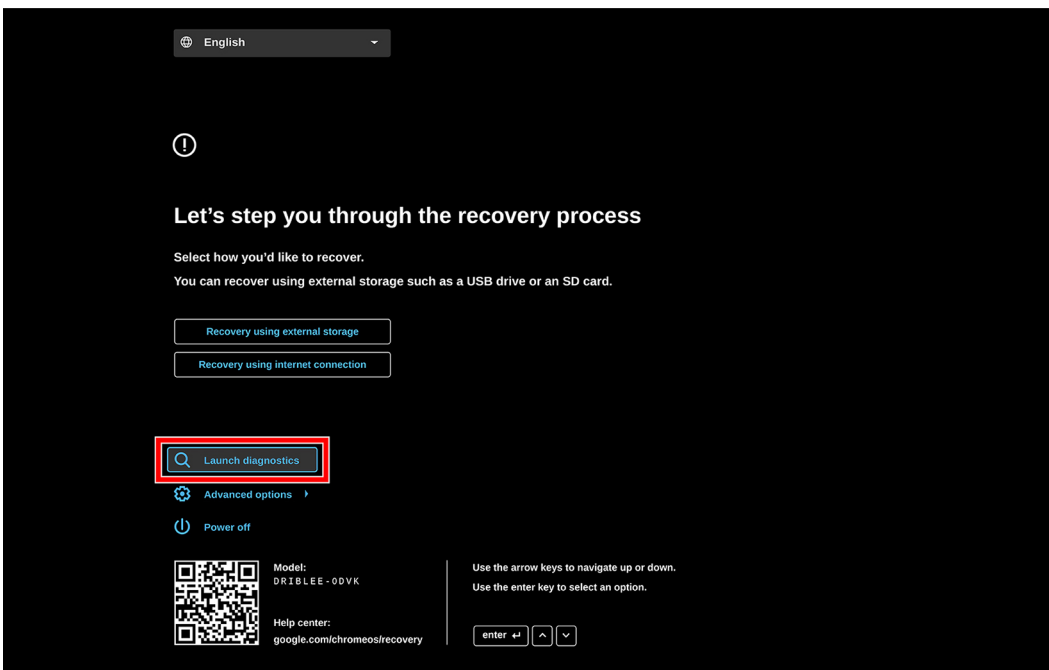

5. In the **Diagnostic tools** screen select the component you want to check:

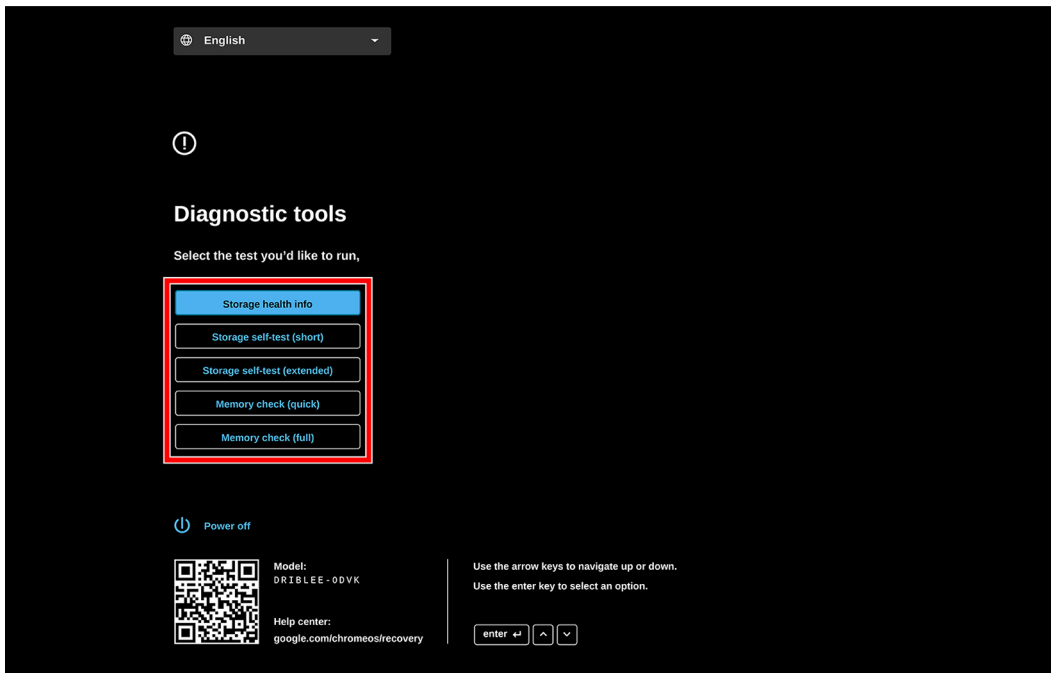

- **Storage health info** - A quick (1 - 2 seconds) way to rule out whether the storage is the cause of the failure. The results will provide a percentage of the lifetime of the storage used.
- **Storage self-test (short)** - This option enables you to run a quick storage test.
- **Storage self-test (extended)** - This option enables you to run an extended storage test.
- **Memory check (quick)** - A quick (less than a minute) single scan of the RAM. Use this option before a full memory test.
- **Memory check (full)** - A lengthier (approximately 3 to 5 minutes) test that runs multiple patterns to detect transient errors. Use this option if you suspect that the quick test did not catch any issues.

Getting help and contacting Dell

Self-help resources

You can get information and help on Dell products and services using these self-help resources:

Table 29. Self-help resources

Self-help resources	Resource location
Information about Dell products and services	www.dell.com
Tips	
Online help for operating system	For support on your Chromebook, refer to ChromeOS Support .
Access top solutions, diagnostics, drivers and downloads, and learn more about your computer through videos, manuals and documents.	Your Dell computer is uniquely identified by a Service Tag or Express Service Code. To view relevant support resources for your Dell computer, enter the Service Tag or Express Service Code at www.dell.com/support . For more information on how to find the Service Tag for your computer, see Locate the Service Tag on your computer .
Dell knowledge base articles for a variety of computer concerns	<ol style="list-style-type: none"> 1. Go to www.dell.com/support. 2. On the menu bar at the top of the Support page, select Support > Knowledge Base. 3. In the Search field on the Knowledge Base page, type the keyword, topic, or model number, and then click or tap the search icon to view the related articles.

Contacting Dell

To contact Dell for sales, technical support, or customer service issues, see www.dell.com/contactdell.

 **NOTE:** Availability varies by country/region and product, and some services may not be available in your country/region.

 **NOTE:** If you do not have an active Internet connection, you can find contact information about your purchase invoice, packing slip, bill, or Dell product catalog.