

SiteWatch™

Perimeter Protection by DW®

DW-SWSP15 IP Speaker



- ※ The picture might differ according to the specification and model.
 - ※ Contents of this user manual are protected under copyrights and computer program laws.
- Before using the system, please read this User Manual and keep it for future reference.

Safety Information

Read this first

Read through this Installation Guide carefully before installing the product. Keep the Installation Guide for future reference.

See the complete user manual for more information on the product's proper installation, use and care.

These instructions ensure users can use the product correctly to avoid danger or property loss. The precaution measure is divided into "Warnings" and "Cautions":

Warnings: Serious injury or death may occur if any warnings are neglected.

Cautions: Injury or equipment damage may occur if any of the cautions are neglected

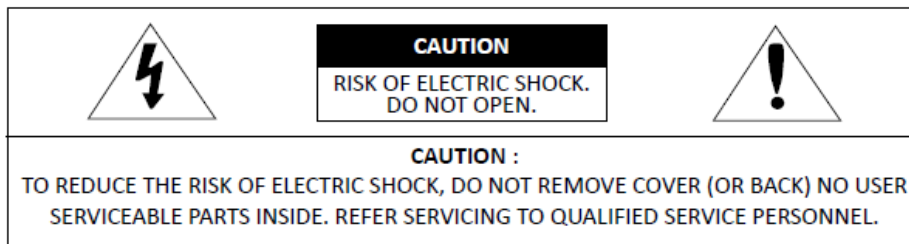

 This symbol indicates that dangerous voltage consisting of a risk of electric shock is present within this unit.

 This exclamation point symbol is intended to alert the user to important operating and maintenance (servicing) instructions in the literature included with the appliance.

WARNING

1. In using the product, you must strictly comply with the electrical safety regulations of the nation and region. The device shall be firmly fixed when the product is mounted on a wall or ceiling.
2. Be sure to use only the standard adapter specified in the specification sheet. Using any other adapter could cause fire, electrical shock, or damage to the product.
3. Make sure the power adapter voltage is correct before using the product.
4. Incorrectly connecting the power adapter may cause an explosion, fire, electric shock, or damage to the product.
5. Do not connect multiple products to a single adapter. Exceeding the capacity may cause excessive heat generation or fire.
6. Securely plug the power into the power source. An insecure connection may cause a fire.
7. When installing the product, fasten it securely and firmly. A falling product may cause personal injury.
8. Do not install in a location subject to elevated temperature, low temperature, or high humidity. Doing so may cause fire or electric shock.
9. Do not place conductive objects (e.g., screwdrivers, coins, metal items, etc.) or containers filled with water on top of the product. Doing so may cause personal injury due to fire, electric shock, or falling objects.
10. Do not install the unit in humid, dusty, or sooty locations. Doing so may cause fire or electric shock.
11. Do not install near any heat sources, such as radiators, heat registers, or other products (including amplifiers) that produce heat.
12. Keep out of direct sunlight and heat radiation sources. It may cause a fire.

13. Stop using the product immediately if any unusual smells or smoke come from the unit. Immediately disconnect the power source and contact the service center. Continued use in such a condition may cause fire or electric shock.
14. If this product does not operate normally, contact the nearest service center. Never disassemble or change this product in any way.
15. When cleaning the product, do not spray water directly onto parts of the product, as doing so may cause fire or electric shock.

Important Safety Instructions

CAUTION

1. Use proper safety gear when installing and wiring the product.
2. Do not drop objects on the product or apply strong shock to it. Keep away from a location subject to excessive vibration or magnetic interference.
3. Do not use this product near water.
4. The product shall not be exposed to dripping or splashing, and no objects filled with liquids, such as vases, shall be placed on the product.
5. The Main plug is used as a disconnect device and shall stay readily operable at any time.
6. Remove the power adapter from the outlet when there is lightning. Neglecting to do so may cause fire or damage to the product.
7. Protect the power cord from being walked on or pinched, particularly at plugs, convenience receptacles, and where they exit from the product.
8. If you want to move the installed product, turn off the power and then move or reinstall it.
9. Proper configuration of all passwords and other security settings is the responsibility of the installer and/or end-user.
10. Use only attachments/accessories specified by the manufacturer.
11. Always use hardware (e.g., screws, anchors, bolts, locking nuts, etc.) compatible with the mounting surface and of sufficient length and construction to ensure a secure mount.
12. Use only with a cart, stand, tripod, bracket, or table specified by the manufacturer or sold with the product.
13. Unplug this product when a cart is used. Use caution when moving the cart/product combination to avoid injury from tip-over.
14. Refer all servicing to qualified service personnel. Servicing is needed when the product has been damaged in any way, such as a power supply cord or plug is damaged, liquid has been spilled, objects have fallen into the product, the product has been exposed to rain or moisture, does not operate normally, or has been dropped.



Legal considerations

Video surveillance can be regulated by laws that vary from country to country. Check the laws in your local region before using this product for surveillance purposes.

Liability

Every care has been taken in the preparation of this document. Digital Watchdog cannot be held responsible for technical or typographical errors and reserves the right to change the product and manuals without notice.

Digital Watchdog makes no warranty of any kind regarding the material contained within this document. Digital Watchdog shall not be liable nor responsible for incidental or consequential damages in connection with this material's furnishing, performance, or use. This product is only to be used for its intended purpose.

Equipment modifications

This equipment must be installed and used strictly per the instructions given in the user documentation. Changes or modifications not expressly approved by the party responsible for compliance could void the user's authority to use the equipment.

Trademark acknowledgments

Digital Watchdog, DW, DW Spectrum are registered trademarks or trademark applications of Digital Watchdog in various jurisdictions.

Apple, Apache, Bonjour, Chrome, Ethernet, Internet Explorer, Linux, Microsoft, Mozilla, Real, SMPTE, QuickTime, UNIX, Windows, and WWW are registered trademarks of the respective holders. Java and all Java-based trademarks and logos are trademarks or registered trademarks of Oracle and/or its affiliates. The UPnP Word Mark and UPnP Logo are Open Connectivity Foundation, Inc. trademarks in the United States or other countries.

Regulatory Information

USA



This device complies with part 15 of the FCC Rules, subject to the following two conditions: (1) this device may not cause harmful interference, and (2) this device must accept any interference received, including interference that may cause undesired operation.

This equipment has been tested and found to comply with the limits for a Class B digital device, according to part 15 of the FCC Rules. These limits are designed to protect reasonably against harmful interference in a residential installation. This equipment generates, uses and can radiate radio frequency energy and, if not installed and used following the instructions, may cause harmful interference to radio communications. However, there is no guarantee that interference will not occur in a particular installation. If this equipment does cause harmful interference to radio or television reception, which can be determined by turning the equipment off and on, the user is encouraged to try to correct the interference by one or more of the following measures:

- Reorient or relocate the receiving antenna.
- Increase the separation between the equipment and the receiver.
- Connect the equipment to an outlet on a circuit different from that to which the receiver is connected.
- Consult the dealer or an experienced radio/TV technician for help.

Disposal and recycling



Digital Watchdog cares for the environment at all product manufacturing stages and is taking measures to provide customers with more environmentally friendly products. When this product has reached the end of its useful life, dispose of it according to local laws and regulations. For information about your nearest designated collection point, contact your local authority responsible for waste disposal. Following local legislation, penalties may be applicable for incorrect disposal of this waste.

Warranty information

For information about Digital Watchdog's product warranty and related information, go to <https://digital-watchdog.com/page/rma-landing-page/>

Regular part replacement: a few parts (e.g., electrolytic capacitor) of the equipment shall be replaced regularly according to their average enduring time. The average time varies because of differences between the operating environment and using history, so regular checking is recommended for all users. Please contact your dealer for more details.

Support

Contact your Digital Watchdog installer or reseller for any questions, help and troubleshooting. If your questions cannot be answered immediately, your installer will forward your questions to ensure a rapid response. If you are connected to the Internet, you can:

- Download user documentation and software updates from Digital Watchdog's website.
- Find answers to resolved problems in the FAQ database
- Visit Digital Watchdog's Support at <https://digital-watchdog.com/DW-Tech-Support/>

Learn more!

Visit Digital Watchdog's learning center <https://digital-watchdog.com/page/dw-university/> for useful training, webinars, tutorials and guides.

Copyright © Digital Watchdog 2023. All rights reserved. Specifications and pricing are subject to change without notice.

Table of Contents



1. Overview	7
1.1. What's in the Box.....	7
1.2. Product Overview.....	7
2. Installation	8
2.1. Mounting the Speaker.....	8
2.2. Adding the Speaker to DW Spectrum.....	9
3. Web Configuration	9
3.1. Status.....	10
3.2. Basic.....	10
3.2.1. Network.....	10
3.2.2. Date/ Time.....	11
3.3. SIP Account.....	12
3.4. Audio.....	14
3.5. Media File.....	15
3.6. HTTP Commands.....	16
3.6.1. HTTP URL.....	16
3.7. Schedule.....	16
3.8. RTP Multicast.....	18
3.9. Firewall.....	18
3.10. System.....	20
3.10.1. Upgrade.....	20
3.10.2. Security.....	21
4. Specifications	22
5. Dimensions	23
6. Warranty Information	24
7. Limits and Exclusions	25

1. Overview

DW-SWSP15 outdoor IP speaker is a robust, IP-enabled audio device that helps to proactively deter crime by enabling the speaker to respond to events in real time with automated and manual voice alerts. The IP67-rated housing is ideal for challenging outdoor environmental conditions with high ambient noise. It can be configured to play music, emit a siren/ringing, voice page, or other notification alerting options. The speaker is fully integrated with DW Spectrum IPVMS, IP cameras and can integrate easily with 3rd party access control, analytics, and VoIP (supporting SIP) via open standards. The DW-SWSP15 is a standalone solution that is an ideal, cost-effective, scalable, and flexible approach to system design and comes with DW's 2-year warranty.

1.1. What's in the Box

Make sure that you have the following items supplied with your speaker. If any items are missing or damaged, notify your vendor immediately. Keep the packing utilities for moving or storage purposes.

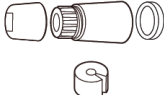
WHAT'S IN THE BOX					
IP horn speaker		1	Quick setup guide		1
Waterproof cap		1			

1.2. Product Overview



2. Installation

2.1. Mounting the Speaker

1. Using the speaker's mounting bracket, mark and drill the necessary holes in the mounting surface.
2. Pass wires through and make all the necessary connections. Connect to the camera's network.

NOTE: The speaker can be powered by either PoE or 12V/24V DC. Both power sources cannot be used at the same time.

3. Use the waterproof cap if installed outdoors. See the diagram below for installation.

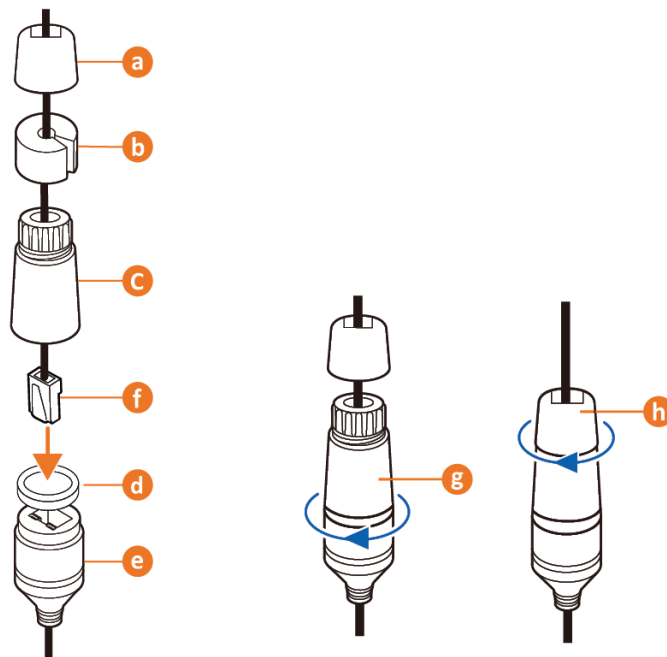

4. Secure the speaker to the mounting surface.
NOTE: Mounting fasteners are not included. Use M8 fasteners or screws with an outer diameter of 5/16" or smaller.
5. Complete the speaker's setup by using the speaker's web interface. Open a web browser and enter the speaker's IP address into the address bar to connect. (See Section 3 - Web Configuration for more info.)
 - Default IP address: The speaker is set to DHCP by default. If no DHCP server is found, the speaker's IP address will revert back to 192.168.1.50.
 - Default username: admin
 - Default password: admin
(password must be changed during the initial installation)
6. Change the IP address to the same subnet range of the cameras.

2.2. Adding the Speaker to DW Spectrum

1. Open the DW Spectrum client
2. DW-SWSP15 should be listed under the resource tree if the auto-discovery is enabled and the DW Spectrum Mediaserver and speaker are in the same network.
 - * Add the speaker manually if the auto-discovery is disabled.
3. Update the credential to the password set on step 5 of 2.1

3. Web Configuration

The speaker's web interface offers users complete control over the speaker's settings. Enter the speaker's IP address into the address bar of a web browser to connect with the speaker's web interface.

NOTE: The speaker's default URL address is: "http://192.168.1.50". If you have changed the speaker's IP address from its default, use the new IP address to connect with the speaker.

- Default username: admin
- Default password: admin (password must be changed during the initial installation)

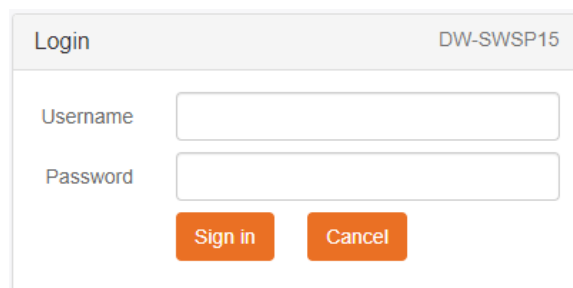

The image shows a login dialog box for the DW-SWSP15 device. The dialog has a title bar with "Login" on the left and "DW-SWSP15" on the right. Below the title bar, there are two input fields: "Username" and "Password". At the bottom of the dialog, there are two buttons: "Sign in" and "Cancel".

3.1. Status

Users can check out the firmware version, free space and status for the two SIP accounts. Users can also locate the current network information, MAC and IP address in the *Status* menu of the web interface.

The screenshot shows the DW web interface. At the top left is the DW logo, and at the top right is a Logout button. A left sidebar contains a menu with items: Status (highlighted), Basic, SIP Account, Audio, Media File, HTTP Commands, Schedule, RTP Multicast, Firewall, and System. The main content area is divided into two sections: 'Status' and 'Network'. The 'Status' section displays the following information:

Device Time	05/04/2023 08:46:57 AM
Serial Number	50344917C098A31C
Model Name	DW-SWSP15
Firmware Ver	SWSP15_V3.3.10-IN1
Free Space	3836KB
SIP1 Status	NONE
SIP2 Status	NONE

The 'Network' section displays the following information:

MAC Address	A8:DC:A4:5A:00:15
IP Address	192.168.40.166
Subnet Mask	255.255.255.0
Gateway	192.168.40.1
Primary DNS	192.168.40.1
Secondary DNS	

A Refresh button is located at the bottom right of the Network section.

3.2. Basic

3.2.1. Network

In the *Network* menu, select the preferred network configuration settings for the IP speaker. Users must use the new IP address on the browser whenever the IP address is updated.

The screenshot shows the DW web interface's Network configuration page. At the top is the Network header. Below it are two radio button options: DHCP (selected) and Static IP Address. Under the Static IP Address option, there are five input fields for network configuration:

IP Address	192.168.1.50
Subnet Mask	255.255.255.0
Gateway	192.168.1.1
Primary DNS	192.168.1.1
Secondary DNS	8.8.8.8

A Save button is located at the bottom right of the configuration area.

- DHCP: When selected, the server automatically updates the speaker's IP address as assigned by the connected DHCP network device (router, smart switch, etc.).
- Static IP address: When selected, users must manually enter the network settings information for the speaker. Enter the speaker's IP address, subnet mask, gateway, and primary and secondary DNS addresses. The IP address will not change unless manually adjusted using *Static IP Address*.

In the *Network Advanced* menu, adjust the network communication port(s) and select the transfer protocol as needed.

- HTTP/HTTPS: Select the preferred transfer protocol that can be used when communicating directly with the speaker using a web browser.
 - HTTP Port: Select the communication port value for the Hypertext Transfer Protocol communication (default: 80)
 - HTTPS Port: Select the communication port value for the Hypertext Transfer Protocol Secure communication (default: 443)
- * The self signed certificate is embedded in the unit and cannot be updated

Press the 'Save' button to save all changes.

3.2.2. Date/ Time

There are two Update Mode options for Date/Time settings:

- NTP: Automatically uses time settings provided by an external server via network time protocol
 - * to sync with any of the Internet time servers, the device must have access to the Internet.
- Current Computer: The speaker will sync with the date and time of the computer used to access the speaker settings.

Choose the preferred Update Mode and set the local time zone. If NTP is selected, configure the following settings:

- TimeZone: Set the local time UTC time zone of the speaker.
- Daylight Savings: Enable the toggle to adjust for daylight saving time.
- NTP Server: Set the preferred network time protocol server (default: time.google.com).
- Sync Interval: Set the time interval in minutes to sync with the NTP server (default is 1440 minutes, 24 hours).

Press the 'Save' button to save all changes.

Date/Time

Device Time 05/04/2023 08:48:59 AM

Sync With

TimeZone

Daylight Savings

NTP Server

Sync Interval Minutes

3.3. SIP Account

The speaker has two SIP (Session Initiation Protocol) accounts that can be set up separately for initiating, maintaining and terminating communication sessions.

To configure, select the SIP 'Account' from the drop-down at the top of the *SIP Account* menu and configure the settings below.

Press the 'Save' button to save all changes.

SIP Set

Account	<input type="text" value="Account 1"/>	NONE	
User Name	<input type="text"/>		
Auth ID	<input type="text"/>		
Password	<input type="text"/>		
Display Name	<input type="text"/>		
Server Host	<input type="text"/>		
Server Port	<input type="text"/>		
Outbound Proxy	<input type="text" value="Disable"/>		
Expire Time	<input type="text" value="3600"/>	Seconds	
Ringing Tone	<input type="text" value="bell1"/>	<input type="button" value="⏮"/>	
Auto Answer	<input type="text" value="Answer Immediately"/>		
Incoming Notify	<input type="checkbox"/>		
Answer Notify	<input type="checkbox"/>		

- Account - Select an account to configure.
- User Name - Enter the username of the SIP account.
- Auth ID - Enter the authentication ID to register.
- Password - Enter the password associated with the SIP username entered above.
- Display Name - Enter the display name of the SIP account.
- Server Host - Enter the SIP server's IP address.
- Server Port - Enter the SIP server's port number.
- Outbound Proxy - Enable or disable the outbound proxy. When enabled, enter the proxy server's IP address and port number.
- Expire Time - Set the expiration time of registered account information.
- Ringing Tone - Set incoming ring tone from the available options.
- Auto Answer - Set the answer mode. Select from 'Answer Immediately' or 'Answer with Delay'. When 'Answer with Delay' is selected, enter the delay time in seconds.
- Incoming Notify - Enable to send HTTP command/request when there is an incoming call.
- Answer Notify - Enable to send HTTP command/request when the call is answered.

Select SIP Protocol.

Options are UDP, TCP and TLS.

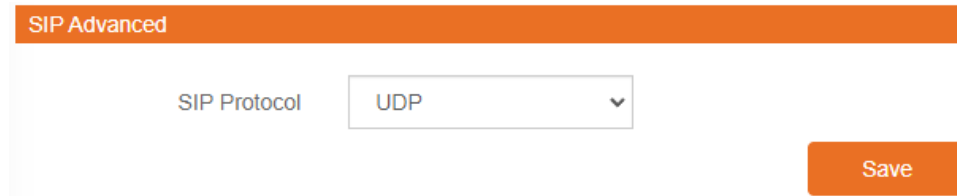

SIP Advanced

SIP Protocol

Save

3.4. Audio

Adjust speaker audio volume and preferred audio settings as needed.

Codec



Codec

Codec Setting

<input checked="" type="checkbox"/>	OPUS
<input checked="" type="checkbox"/>	G.722
<input checked="" type="checkbox"/>	G.711U
<input checked="" type="checkbox"/>	G.711A

- Codec Setting: Select the preferred audio codecs that can be used with the speaker.

Speaker



Speaker

Volume (0-100)

Amp Auto OFF

Jitter Buffer (60 - 2000) ms

HPF

NR

- Volume: Adjust output volume of the speaker between 0-100.
- Amp Auto OFF: Enabled by default. When enabled, the amplifier will automatically deactivate when the speaker is not broadcasting.
- Jitter buffer: Adjust the wait time (ms) between collecting and sending VoIP to stabilize the audio and reduce audio delays and sound distortion while outputting sound.
- HPF: Enable to use a high-pass filter and primarily allow higher audio frequencies.
- NR: Enable to use noise reduction and automatically remove unwanted ambient noise from the audio output.

MIC (Not used on DW-SWSP15)

Press the 'Save' button to save all changes.











3.5. Media File

There are five (5) system audio files. These files cannot be altered.

System File		
#	Name	
1	bell1	 
2	bell2	 
3	bell3	 
4	bell4	 
5	bell5	 

 Play through PC audio output
 Play through speaker

You can upload up to ten (10) custom media files (MP3 or WAV) not to exceed the available storage, such as music, announcement, bells, etc., for additional audio-out options.

User File (3836KB free)		
#	Name	File
1	userfile1	<input type="button" value="Choose File"/>  Upload the file to the speaker
2	userfile2	<input type="button" value="Choose File"/> 
3	userfile3	<input type="button" value="Choose File"/> 
4	userfile4	<input type="button" value="Choose File"/> 
5	userfile5	<input type="button" value="Choose File"/> 
6	userfile6	<input type="button" value="Choose File"/> 
7	userfile7	<input type="button" value="Choose File"/> 
8	userfile8	<input type="button" value="Choose File"/> 
9	userfile9	<input type="button" value="Choose File"/> 
10	userfile10	<input type="button" value="Choose File"/> 

To add files, click "Choose File" and select the audio file then click Upload.

User File (652KB free)					
#	Name	File			
1	userfile1	Starlight.mp3	Choose File	⊕	⊖
2	userfile2		Choose File	⊕	

3.6. HTTP Commands

3.6.1. HTTP Commands

Users can control the sound by using an HTTP command from a web browser, VMS, cameras or network devices to send commands to the speaker.

To use an HTTP command:

1. Open a browser or VMS on your computer.
2. Enter the HTTP URL and include the preferred media file for the alarm command as outlined in the provided HTTP Command examples.

HTTP Commands

Example1: `http://192.168.40.166/api/play?action=start&file=bell1`

Example2: `http://192.168.40.166/api/play?action=start&file=userfile1&mode=once&volume=10`









Example3: `http://192.168.40.166/api/play?action=start&file=userfile1&mode=multiple&count=10&volume=20`

Example4: `http://192.168.40.166/api/play?action=start&file=userfile1&mode=duration&count=10&volume=30`

Example5: `http://192.168.40.166/api/play?action=stop`

3.7. Schedule

Schedule regular bell rings, announcements and alarms in public areas such as schools, factories and office spaces.

Schedule						
#	Name	Time	Action	File		
1	AM Break	10:00	start	bell1		
2						
3						
4						

To add a schedule:

- 1) Click on the Edit icon to edit or add a new audio schedule.
- 2) Check the *Schedule Enable* box to enable the schedule. Uncheck the box to disable the schedule.
- 3) Create a name for the schedule. This name will appear in the *Schedule* list.
- 4) Select the days of the week and time for the scheduled audio. When setting the *Action Time*, either click the hour/minute and manually enter the value or click on the Clock icon to select from a drop-down.
- 5) Configure the following:
 - Action type: select the preferred action type for this schedule (Start/Stop).
 - Play File: select the audio file that will trigger when this schedule activates.
 - Cycle mode:
 - Once only: play sound once
 - Multiple times: play sound multiple times continuously
 - Duration: play sound for the duration of time.

Press the 'Save' button to save all changes.

The screenshot shows the 'Schedule Add/Edit' form with the following fields and annotations:

- Schedule Enable:** An unchecked checkbox.
- Schedule Name:** An empty text input field.
- Start Date:** 01/01/2022 with a calendar icon. A red bracket connects this icon to the **End Date** icon, with the label "Open calendar".
- End Date:** 12/31/2099 with a calendar icon.
- Allowed Days:** A row of checkboxes for Mon, Tue, Wed, Thu, Fri, Sat, and Sun, all of which are checked.
- Action Time:** 08:00 AM with a clock icon. A red line connects this icon to the label "Open time table".
- Action Type:** A dropdown menu with "Start" selected.
- Play File:** A dropdown menu with "bell1" selected. A red line connects the speaker icon to the label "Play thru computer audio out".
- Cycle Mode:** A dropdown menu with "Once only" selected.
- Buttons:** "Save" and "Cancel" buttons at the bottom right.

3.8. RTP Multicast

Each device can receive up to ten (10) RTP addresses.

Do not use continuous port numbers.

For example:

239.255.1.2:8000, 239.255.0.1:8001, 239.255.0.1:8002 (✗)

239.255.0.1:8000, 239.255.0.1:8002, 239.255.0.1:8004 (✓)

- Multicast address range: 224.0.0.0-239.255.255.
- Ports range: 1024-65536

RTP Multicast

Priority	IP Address (e.g. 239.255.0.1:5004)
1	<input type="text"/>
2	<input type="text"/>
3	<input type="text"/>
4	<input type="text"/>
5	<input type="text"/>
6	<input type="text"/>
7	<input type="text"/>
8	<input type="text"/>
9	<input type="text"/>
10	<input type="text"/>











Save

3.9. Firewall

Users can enable settings in the *Firewall* menu to adjust the security settings of the speaker.

Create a Firewall Rule to permit or deny access to devices as needed.

Firewall Rules

#	Name	Type	IP/MAC	Action
1				 
2				 
3				 
4				 
5				 

Firewall Add/Edit

Enable

Name

Rule Type











Protocol

IP Address

Net Mask

Action

Automatic Defense Rules

#	Name	Protocol	Port Range	Rate
1			-	 
2			-	 
3			-	 
4			-	 
5			-	 

Automatic Defense Add/Edit

Enable

Name

Protocol TCP ▼

Port Range -

Rate (1-10000) /s

Save
Cancel

3.10. System

3.10.1. Upgrade

In the Upgrade section of the *System* menu:

- Reboot: Click to power cycle the speaker device. Users must log back into the system once the reboot has been completed.
- Reset: Click to complete a system default and return the speaker to factory settings. Users must log back into the device's default IP address, username and password.
- FW Upgrade: Click to upgrade the firmware of the IP speaker device. See directions below.

How to upgrade the IP Speaker firmware version in the web interface:

- 1) The latest firmware can be found on DW's website at www.digital-watchdog.com/downloads. Search for the device's part number (DW-SWSP15). Locate and download the newest firmware to your computer.
- 2) Press the 'Choose File' button on the speaker's settings and select the firmware files (swsp15_XXXXXXXXXX.bin).
- 3) Click the 'FW Upgrade' button. The upgrade process should take about 30-50 seconds.
- 4) Log back into the web interface to complete the upgrade.

System

Reboot Reboot Device Now

Reset Reset to Factory Setting

FW Upgrade
Choose File No file chosen

3.10.2. Security

You can set a new username and password in the Security section of the *System* menu. To change the login:

- 1) Enter the current User Name and Password of the IP speaker.
 - Default username: admin
 - Password: password set during initial setup
- 2) Assign the New User name and/or New Password to the IP speaker as desired. It is recommend to keep the username as 'admin'.
- 3) Save the configuration and restart the IP speaker device to apply the changes.

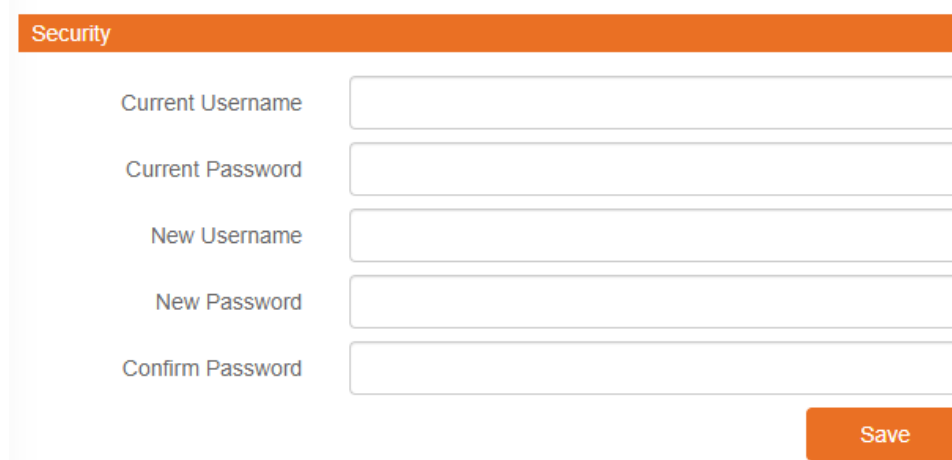

Security

Current Username

Current Password

New Username

New Password

Confirm Password

Save

4. Specifications

Audio	
Codec	OPUS 48 kHz, MP3 44.1 kHz, G.722 ADPCM 16 kHz, G.711 PCMU 8 kHz, G.711 PCMA 8 kHz
Max SPL	113dB
Frequency response	300Hz-8KHz
Frequency range	500-2KHZ +-10dB
	400-12KHZ +-20dB
Harmonic distortion	0.1@1kHz
Signal-to-noise ratio	91dB
Amplifier	Built-in 15W amplifier
Network	
Security	Password protection, IP address filtering, digest authentication, user access log, firewall
Network protocol	SIP, ONVIF, HTTP, IPv4, DHCP, RTSP, RTP, RTCP, TCP, UDP, ARP, FTP, TFTP, NFS, NTP
Network interface	10/100 Base-TX, RJ45
VoIP	Support SIP protocol for VoIP systems integration, integrated with SIP/PBX.
	2 SIP accounts, SIP direct IP call, RTP multicast
	Codec: OPUS, MP3, G.722, PCMU, PCMA
General	
Operating temperature	-22°F ~ 140°F (-30°C ~ 60°C)
Operating humidity	5%-85%
Material	ABS (IP67-rated)
Rate power	15W
Power supply	PoE or 12-24V
Installation	Wall-mounted (wall mount bracket included)
Dimensions	8.74" x 7.04" x 9.13" (222 x 179 x 232mm)
Net weight	2.86 lbs (1.3 kg)
Warranty	2 years

5. Dimensions

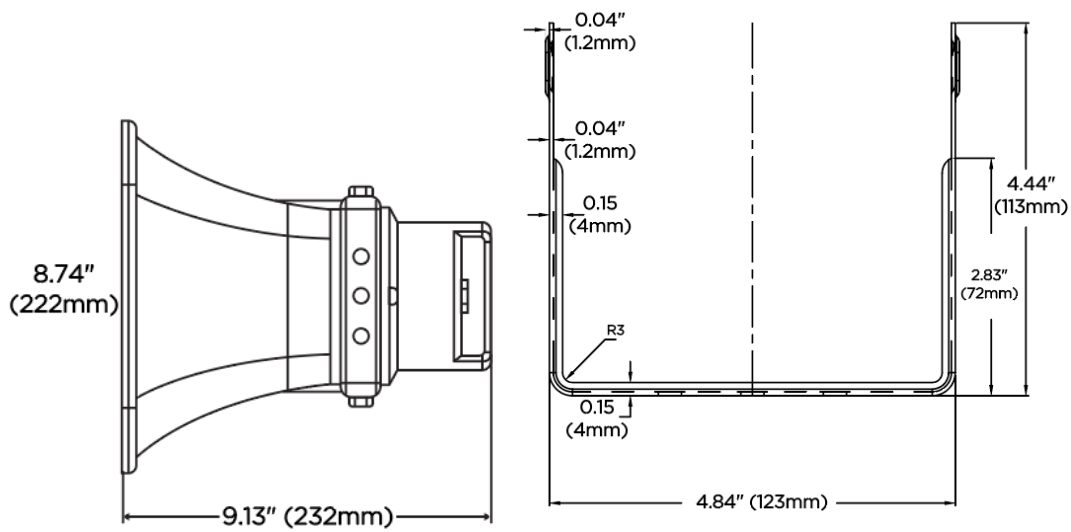
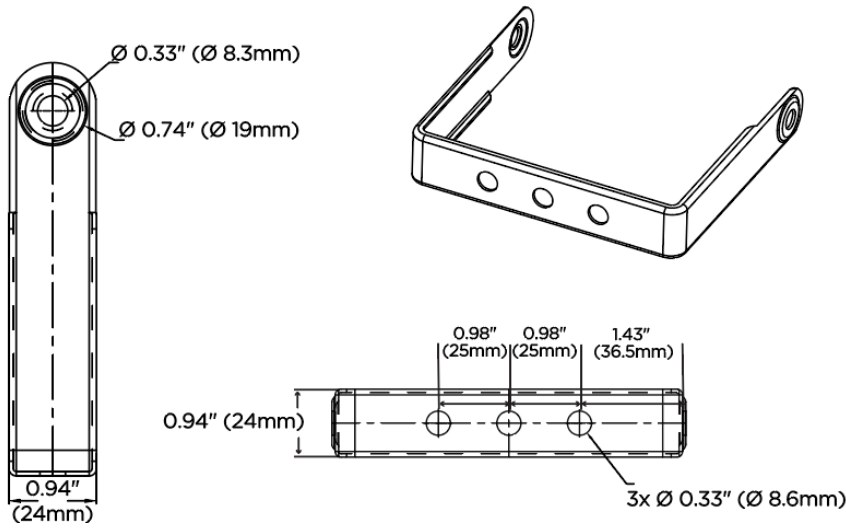
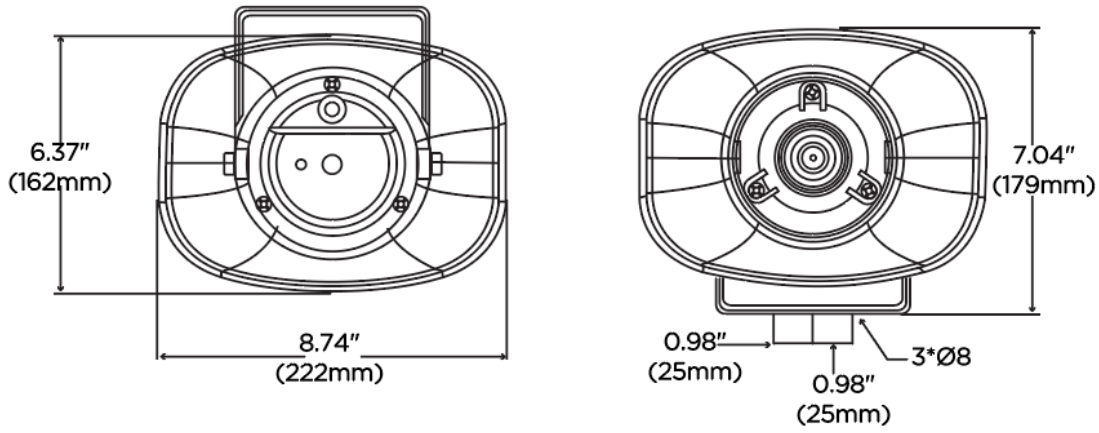

6. Warranty Information

Go to <https://digital-watchdog.com/page/rma-landing-page/> to learn more about Digital Watchdog's warranty and RMA.

To obtain warranty or out-of-warranty service, please contact a technical support representative at:

1+ (866) 446-3595, from 9:00 AM to 8:00 PM EST, Monday through Friday.

A purchase receipt or proof of the original purchase date is needed before the warranty service is rendered. This warranty only covers failures due to materials and workmanship defects during normal use. This warranty does not cover damages that occur in shipment or failures which are caused by products not supplied by the Warrantor or failures which result from accident, misuse, abuse, neglect, mishandling, misapplication, alteration, modification, faulty installation, setup adjustments, improper antenna, inadequate signal pickup, maladjustments of consumer controls, improper operation, power line surge, improper voltage supply, lightning damage, rental use of the product or service by anyone other than an authorized repair facility or damage that is attributable to acts of God.

7. Limits and Exclusions

There are no express warranties except as listed above. The Warrantor will not be liable for incidental or consequential damages (including, without limitation, damage to recording media) resulting from using these products or arising out of any breach of the warranty. All express and implied warranties, including the warranties of merchantability and fitness for a particular purpose, are limited to the applicable warranty period set forth above.

Some states do not allow the exclusion or limitation of incidental or consequential damages or limitations on how long an implied warranty lasts, so the above exclusions or limitations may not apply to you. This warranty gives you specific legal rights; you may also have other rights from state to state. If the problem is not handled to your satisfaction, then write to the following address:

Digital Watchdog, Inc.
ATTN: RMA Department
16220 Bloomfield Ave
Cerritos, CA 90703

Service calls that do not involve defective materials or workmanship, as decided by the Warrantor, in its sole discretion, are not covered. The cost of such service calls is the responsibility of the purchaser.



DW® East Coast office and warehouse: 5436 W Crenshaw St, Tampa, FL USA 33634
DW® West Coast office and warehouse: 16220 Bloomfield Ave, Cerritos, CA USA 90703

PH: 866-446-3595 | FAX: 813-888-9262

www.Digital-Watchdog.com

technicalsupport@digital-watchdog.com

Technical Support PH:

USA & Canada 1+ 866-446-3595

International 1+ 813-888-9555

French Canadian: + 1-904-999-1309

Technical Support Hours: Monday-Friday 9 a.m. to 8 p.m. Eastern Time