

# **Acer LCD Monitor**

## **User Guide**

Copyright © 2022. Acer Incorporated.  
All Rights Reserved.

Acer LCD Monitor User Guide  
Original Issue: 05/2022

Changes may be made periodically to the information in this publication without obligation to notify any person of such revisions or changes. Such changes will be incorporated in new editions of this manual or supplementary documents and publications. This company makes no representations or warranties, either expressed or implied, with respect to the contents hereof and specifically disclaims the implied warranties of merchantability or fitness for a particular purpose.

Record the model number, serial number, purchase date and place of purchase information in the space provided below. The serial number and model number are recorded on the label affixed to your computer. All correspondence concerning your unit should include the serial number, model number and purchase information.

No part of this publication may be reproduced, stored in a retrieval system, or transmitted, in any form or by any means, electronically, mechanically, by photocopy, recording or otherwise, without the prior written permission of Acer Incorporated.

Acer LCD Monitor User Guide

Model number: \_\_\_\_\_

Serial number: \_\_\_\_\_

Date of purchase: \_\_\_\_\_

Place of purchase: \_\_\_\_\_

Acer and the Acer logo are registered trademarks of Acer Incorporated. Other companies' product names or trademarks are used herein for identification purposes only and belong to their respective companies.

# Information for your safety and comfort

## Safety instructions

Read these instructions carefully. Keep this document for future reference. Follow all warnings and instructions marked on the product.

## Special notes on LCD monitors

The following are normal with the LCD monitor and do not indicate a problem.

- Due to the nature of the fluorescent light, the screen may flicker during initial use. Turn off the power switch and then turn it on again to make sure the flicker disappears.
- You may find slightly uneven brightness on the screen depending on the desktop pattern you use.
- The LCD screen has 99.99% or more effective pixels. It may include blemishes of 0.01% or less such as a missing pixel or pixel lit all the time.
- Due to the nature of the LCD screen, an afterimage of the previous screen may remain after switching the image, when the same image is displayed for hours. In this case, the screen is recovered slowly by changing the image or turning off the power switch for a few hours.

## Cleaning your monitor

Please carefully follow these guidelines when cleaning the monitor:

- Always unplug the monitor before cleaning.
- Use a soft cloth to wipe the screen and cabinet front and sides.

## Accessibility

Be sure that the power outlet you plug the power cord into is easily accessible and located as close to the equipment operator as possible. When you need to disconnect power from the equipment, be sure to unplug the power cord from the electrical outlet.

## Safe listening

To protect your hearing, follow these instructions.

- Gradually increase the volume until you can hear it clearly and comfortably and without distortion.
- After setting the volume level, do not increase it after your ears have adjusted.
- Limit the amount of time listening to music at high volume.
- Avoid turning up the volume to block out noisy surroundings.
- Turn the volume down if you can't hear people speaking near you.

## Warnings

- Do not use this product near water.
- Do not place this product on an unstable cart, stand or table. If the product falls, it could be seriously damaged.
- Slots and openings are provided for ventilation to ensure reliable operation of the product and to protect it from overheating. These openings must not be blocked or covered. The openings should never be blocked by placing the product on a bed, sofa, rug or other similar surface. This product should never be placed near or over a radiator or heat register, or in a built-in installation unless proper ventilation is provided.
- Never push objects of any kind into this product through cabinet slots as they may touch dangerous voltage points or short-out parts that could result in a fire or electric shock. Never spill liquid of any kind onto or into the product.
- To avoid damage of internal components and to prevent battery leakage, do not place the product on a vibrating surface.
- Never use it under sporting, exercising, or any vibrating environment which will probably cause unexpected short current or damage internal devices.
- The adapter is only used for this monitor, do not be used for other purposes.

## Using electrical power

- This product should be operated from the type of power indicated on the marking label. If you are not sure of the type of power available, consult your dealer or local power company.
- Do not allow anything to rest on the power cord. Do not locate this product where people will walk on the cord.

- If an extension cord is used with this product, make sure that the total ampere rating of the equipment plugged into the extension cord does not exceed the extension cord ampere rating. Also, make sure that the total rating of all products plugged into the wall outlet does not exceed the fuse rating.
- Do not overload a power outlet, strip or receptacle by plugging in too many devices. The overall system load must not exceed 80% of the branch circuit rating. If power strips are used, the load should not exceed 80% of the power strip's input rating.
- This product's power cord is equipped with a three-wire grounded plug. The plug only fits in a grounded power outlet. Make sure the power outlet is properly grounded before inserting the power cord plug. Do not insert the plug into a non-grounded power outlet. Contact your electrician for details.



.....

**Warning! The grounding pin is a safety feature. Using a power outlet that is not properly grounded may result in electric shock and/or injury.**



.....

**Note:** The grounding pin also provides good protection from unexpected noise produced by other nearby electrical devices that may interfere with the performance of this product.

- Use the product only with the supplied power supply cord set. If you need to replace the power cord set, make sure that the new power cord meets the following requirements: detachable type, UL listed/CSA certified, type SPT-2, rated 7 A 125 V minimum, VDE approved or its equivalent, 4.6 meters (15 feet) maximum length.

## Product servicing

Do not attempt to service this product yourself, as opening or removing covers may expose you to dangerous voltage points or other risks. Refer all servicing to qualified service personnel.

Unplug this product from the wall outlet and refer servicing to qualified service personnel when:

- the power cord or plug is damaged, cut or frayed
- liquid was spilled into the product
- the product was exposed to rain or water
- the product has been dropped or the case has been damaged
- the product exhibits a distinct change in performance, indicating a need for service
- the product does not operate normally after following the operating instructions



**Note:** Adjust only those controls that are covered by the operating instructions, since improper adjustment of other controls may result in damage and will often require extensive work by a qualified technician to restore the product to normal condition.

## Potentially explosive environments

Switch off your device in any area with a potentially explosive atmosphere and obey all signs and instructions. Potentially explosive atmospheres include areas where you would normally be advised to turn off your vehicle engine. Sparks in such areas could cause an explosion or fire resulting in bodily injury or even death. Switch off the device near depots, storage and distribution areas; chemical plants; or where blasting operations are in progress. Areas with a potentially explosive atmosphere are often, but not always, marked. They include below deck on boats, chemical transfer or storage facilities, vehicles using liquefied petroleum gas (such as propane or butane), and areas where the air contains chemicals or particles such as grain, dust or metal powders.

## Additional safety information

Your device and its enhancements may contain small parts. Keep them out of the reach of small children.

## IT Equipment Recycling Information

Acer is strongly committed to environmental protection and views recycling, in the form of salvaging and disposal of used equipment, as one of the company's top priorities in minimizing the burden placed on the environment.

We at Acer are very conscious of the environmental effects of our business and strive to identify and provide the best working procedures to reduce the environmental impact of our products.

For more information and help when recycling, please go to this website:

<http://www.acer-group.com/public/Sustainability/sustainability01.htm>

Visit [www.acer-group.com](http://www.acer-group.com) for further information on the features and benefits of our other products.

## Disposal instructions



Do not throw this electronic device into the trash when discarding. To minimize pollution and ensure utmost protection of the global environment, please recycle. For more information on the Waste from Electrical and Electronics Equipment (WEEE) regulations, visit <http://www.acer-group.com/public/Sustainability/sustainability01.htm>

## LCD pixel statement

The LCD unit is produced with high-precision manufacturing techniques. Nevertheless, some pixels may occasionally misfire or appear as black or red dots. This has no effect on the recorded image and does not constitute a malfunction.

This product has been shipped enabled for power management:

- Activate display's Sleep mode within 5 minutes of user inactivity.
- Wake the monitor when it is in Active Off mode, move the mouse or press any keyboard key.

## Tips and information for comfortable use

Computer users may complain of eyestrain and headaches after prolonged use. Users are also at risk of physical injury after long hours of working in front of a computer. Long work periods, bad posture, poor work habits, stress, inadequate working conditions, personal health and other factors greatly increase the risk of physical injury.

Incorrect computer usage may lead to carpal tunnel syndrome, tendonitis, tenosynovitis or other musculoskeletal disorders. The following symptoms may appear in the hands, wrists, arms, shoulders, neck or back:

- numbness, or a burning or tingling sensation
- aching, soreness or tenderness
- pain, swelling or throbbing
- stiffness or tightness
- coldness or weakness

If you have these symptoms, or any other recurring or persistent discomfort and/or pain related to computer use, consult a physician immediately and inform your company's health and safety department.

The following section provides tips for more comfortable computer use.

## Finding your comfort zone

Find your comfort zone by adjusting the viewing angle of the monitor, using a footrest, or raising your sitting height to achieve maximum comfort. Observe the following tips:

- refrain from staying too long in one fixed posture
- avoid slouching forward and/or leaning backward
- stand up and walk around regularly to remove the strain on your leg muscles

## Taking care of your vision

Long viewing hours, wearing incorrect glasses or contact lenses, glare, excessive room lighting, poorly focused screens, very small typefaces and low-contrast displays could stress your eyes. The following sections provide suggestions on how to reduce eyestrain.

### Eyes

- Rest your eyes frequently.
- Give your eyes regular breaks by looking away from the monitor and focusing on a distant point.
- Blink frequently to keep your eyes from drying out.

### Display

- Keep your display clean.
- Keep your head at a higher level than the top edge of the display so your eyes point downward when looking at the middle of the display.
- Adjust the display brightness and/or contrast to a comfortable level for enhanced text readability and graphics clarity.
- Eliminate glare and reflections by:
  - placing your display in such a way that the side faces the window or any light source
  - minimizing room light by using drapes, shades or blinds
  - using a task light
  - changing the display's viewing angle
  - using a glare-reduction filter
  - using a display visor, such as a piece of cardboard extended from the display's top front edge
- Avoid adjusting your display to an awkward viewing angle.
- Avoid looking at bright light sources, such as open windows, for extended periods of time.

## Developing good work habits

Develop the following work habits to make your computer use more relaxing and productive:

- Take short breaks regularly and often.
- Perform some stretching exercises.
- Breathe fresh air as often as possible.
- Exercise regularly and maintain a healthy body.



### Declaration of Conformity

We, **Acer Incorporated**  
8F, 88, Sec. 1, Xintai 5th Rd., Xizhi, New Taipei City 221

And, **Acer Italy s.r.l.**  
Viale delle Industrie 1/A, 20044 Arese (MI), Italy  
Tel: +39-02-939-921 ,Fax: +39-02 9399-2913  
www.acer.it

<b>Product:</b>	<b>LCD Monitor</b>
<b>Trade Name:</b>	<b>Acer</b>
<b>Model Number:</b>	<b>V227Q</b>
<b>SKU Number:</b>	<b>V227Q_XXXXXX;</b>
	<b>("x" = 0~9, a~z, A~Z, or blank)</b>

We, Acer Incorporated, hereby declare under our sole responsibility that the product described above is in conformity with the relevant Union harmonization legislations as below Directive and following harmonized standards and/or other relevant standards have been applied:

**EMC Directive: 2014/30/EU**

<input checked="" type="checkbox"/> EN 55032:2015+A11:2020 Class B	<input checked="" type="checkbox"/> EN 55035:2017+A11:2020
<input checked="" type="checkbox"/> EN EN IEC 61000-3-2:2019 Class D	<input checked="" type="checkbox"/> EN EN61000-3-3:2013+A1: 2019

**LVD Directive: 2014/35/EU**

<input checked="" type="checkbox"/> EN 62368-1: 2014+A11:2017
---

**RoHS Directive: 2011/65/EU**

<input checked="" type="checkbox"/> EN IEC 63000: 2018
--

**ErP Directive: 2009/125/EC**

<input checked="" type="checkbox"/> (EU) 2019/ 2021; EN 50564:2011
--

Year to begin affixing CE marking: 2022.

---

**RU Jan / Sr. Manager**  
**Acer Incorporated (New Taipei City)**

Jul.15,2022  
**Date**

**acer**

**Acer America Corporation**  
333 West San Carlos St., San Jose  
Suite 1500  
CA 95110, U. S. A.  
Tel : 254-298-4000  
Fax : 254-298-4147  
www.acer.com



## Federal Communications Commission Supplier's Declaration of Conformity

This device complies with Part 15 of the FCC Rules. Operation is subject to the following two conditions: (1) this device may not cause harmful interference, and (2) this device must accept any interference received, including interference that may cause undesired operation.

The following local Manufacturer /Importer is responsible for this declaration:

<b>Product:</b>	LCD Monitor
<b>Model Number:</b>	V227Q
<b>SKU Number:</b>	V227Q xxxxxx ("x" = 0~9, a ~ z, or A ~ Z)
<b>Name of Responsible Party:</b>	Acer America Corporation
<b>Address of Responsible Party:</b>	333 West San Carlos St. Suite 1500 San Jose, CA 95110 U. S. A.
<b>Contact Person:</b>	Acer Representative
<b>Phone No.:</b>	254-298-4000
<b>Fax No.:</b>	254-298-4147

**ENERGY STAR®**

Acer's ENERGY STAR qualified products save you money by reducing energy costs and helps protect the environment without sacrificing features or performance. Acer is proud to offer our customers products with the ENERGY STAR mark.

**What is ENERGY STAR?**

Products that are ENERGY STAR qualified use less energy and prevent greenhouse gas emissions by meeting strict energy efficiency guidelines set by the

U.S. Environmental Protection Agency. Acer is committed to offer products and services worldwide that help customers save money, conserve energy and improve the quality of our environment. The more energy we can save through energy efficiency, the more we reduce greenhouse gases and the risks of climate change. More information refers to <http://www.energystar.gov>.

**Acer ENERGY STAR qualified products:**

- Produce less heat and reduce cooling loads, and warmer climates.
- Automatically go into "display sleep" within 5 minutes of inactivity.
- Wake the monitor when it is in Active Off mode, move the mouse or press any keyboard key.

ENERGY STAR and the ENERGY STAR mark are registered U.S. marks



**Note:** This product qualifies for ENERGY STAR in the factory default settings which can be restored by "Factory Reset" function in the OSD menu.

Changing the factory default settings or enabling other features may increase power consumption that could exceed the ENERGY STAR specified limit.

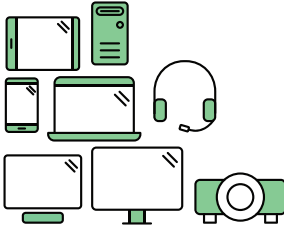

## Say hello to a more sustainable product

IT products are associated with a wide range of sustainability risks throughout their life cycle. Human rights violations are common in the factories. Harmful substances are used both in products and their manufacture. Products can often have a short lifespan because of poor ergonomics, low quality and when they are not able to be repaired or upgraded.

**This product is a better choice.** It meets all the criteria in TCO Certified, the world's most comprehensive sustainability certification for IT products. Thank you for making a responsible product choice, that help drive progress towards a more sustainable future!

Criteria in TCO Certified have a life-cycle perspective and balance environmental and social responsibility. Conformity is verified by independent and approved verifiers that specialize in IT products, social responsibility or other sustainability issues. Verification is done both before and after the certificate is issued, covering the entire validity period. The process also includes ensuring that corrective actions are implemented in all cases of factory non-conformities. And last but not least, to make sure that the certification and independent verification is accurate, both TCO Certified and the verifiers are reviewed regularly.

### Want to know more?

Read information about TCO Certified, full criteria documents, news and updates at [tcocertified.com](https://www.tcocertified.com). On the website you'll also find our Product Finder, which presents a complete, searchable listing of certified products.

# Contents

<b>Information for your safety and comfort</b>	<b>iii</b>
Safety instructions	iii
Special notes on LCD monitors	iii
Cleaning your monitors	iii
Accessibility	iv
Safe listening	iv
Warnings	iv
Using electrical power	iv
Product servicing	v
Potentially explosive environments	vi
Additional safety information	vi
IT Equipment Recycling Information	vi
Disposal instructions	vi
LCD pixel statement	vii
Tips and information for comfortable use	vii
Finding your comfort zone	vii
Taking care of your vision	viii
Developing good work habits	viii
Declaration of Conformity	ix
Federal Communications Commission	
Declaration of Conformity	x
<b>Unpacking</b>	<b>1</b>
Attaching the base (for selected models)	2
Screen position adjustment	3
Connecting the adapter and AC Power cord	3
Power saving	
Display Data Channel (DDC)	
Connector pin assignment	4
19-pin color display signal cable	4
20-pin color display signal cable	5
<b>Standard timing table</b>	<b>6</b>
<b>Installation</b>	<b>7</b>
<b>Users controls</b>	<b>8</b>
Panel controls	8
Using the Shortcut Menu	9
The Function page	10
<b>Troubleshooting</b>	<b>15</b>
VGA IN/HDMI1.4/DP Mode (Optional)	15

# Unpacking

Please check that the following items are present when you unpack the box, and save the packing materials in case you need to ship or transport the monitor in the future.

LCD monitor

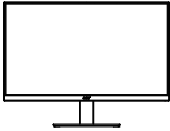

Quick start guide



\*VGA Cable  
(Optional)

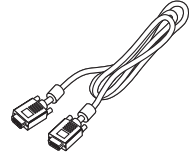

\*DP Cable  
(Optional)

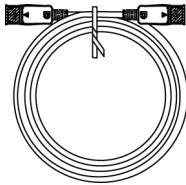

\*HDMI1.4 cable  
(Optional)

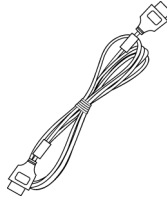

\*AC Power cord

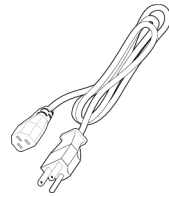

\*Audio Cable  
(Optional)

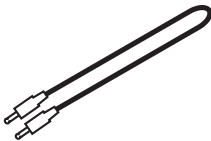

\*Also the Replaceable parts required by the TCO Certified.

- **Attaching the Base**

Note: Remove the monitor and monitor base from its packaging. Carefully place the monitor face-down on a stable surface -- use a cloth to avoid scratching the screen.

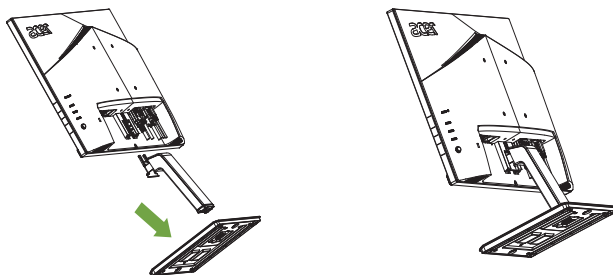

- **Screen position adjustment**

To optimize the viewing position, you can adjust the monitor tilt by using both of your hands to hold the edges of the monitor as shown below. The monitor can be adjusted to 25 degrees up or 5 degrees down.

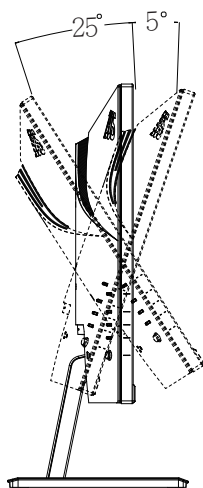

## Connecting the adapter and AC Power cord

- Check first to make sure that the power cord you use is the correct type required for your area.
- The monitor has a universal power supply that allows operation in either 100/120 V AC or 220/240 V AC voltage area. No user-adjustment is required.
- Plug one end of the AC power cord to the Adapter, and plug the other end into an AC outlet.
- For units using 120 V AC:  
Use a UL-listed cord set, type SVT wire and plug rated 10 A/125 V.
- For units using 220/240 V AC:  
Use a cord set consisting of H05VV-F cord and plug rated 10 A/250 V. The cord set should have the appropriate safety approvals for the country in which the equipment will be installed.

## Power saving

The monitor will be driven into "Power Saving" mode by the control signal from the display controller, as indicated by the amber-color power LED.

State	LED Light
ON	Blue
Power Saving Mode	Amber

The power saving states will be kept until a control signal has been detected or the keyboard or mouse is activated. The recovery time from Active OFF state back to ON state is around 3 seconds.

## Display Data Channel (DDC)

To make installation easier, so long as your system supports the DDC protocol, the monitor is able to plug-and-play. The DDC is a communication protocol through which the monitor automatically informs the host system about its capabilities; for example, supported resolutions and corresponding timing. The monitor supports the DDC2B standard.

### 20-pin color display signal cable

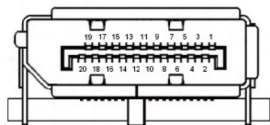

PIN No.	Description	PIN No.	Description
1	ML_Lane 0+	2	GND
3	ML_Lane 0-	4	ML_Lane 1+
5	GND	6	ML_Lane 1-
7	ML_Lane 2+	8	GND
9	ML_Lane 2-	10	ML_Lane 3+
11	GND	12	ML_Lane 3-
13	KONFIG1	14	CONFIG2
15	AUX CH+	16	GND
17	AUX CH-	18	Hot Plug
19	Return	20	DP_PWR

## 19-pin color display signal cable

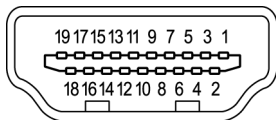

PIN No.	Description	PIN No.	Description
1	TMDS Data2+	2	TMDS Data2 Shield
3	TMDS Data2-	4	TMDS Data1+
5	TMDS Data1 Shield	6	TMDS Data1-
7	TMDS Data0+	8	TMDS Data0 Shield
9	TMDS Data0-	10	TMDS Clock+
11	TMDS Clock Shield	12	TMDS Clock-
13	CEC	14	Reserved (N.C. on device)
15	SCL	16	SDA
17	DDC/CEC Ground	18	+5V Power
19	Hot Plug Detect		

## 15-pin color display signal cable

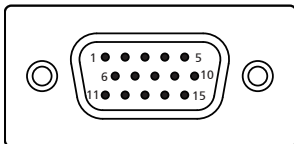

PIN No.	Description	PIN No.	Description
1	Red	9	+5V
2	Green	10	Logic ground
3	Blue	11	Monitor ground
4	Monitor ground	12	DDC-serial data
5	DDC-return	13	H-sync
6	R-ground	14	V-sync
7	G-ground	15	DDC-serial clock
8	B-ground		

## Standard timing table

VESA MODE			
MODE	Resolution		
1	VGA	640x480	60Hz
2	MAC	640x480	66.66Hz
3	VESA	720x400	70Hz
4	SVGA	800x600	56Hz
5	SVGA	800x600	60Hz
6	XGA	1024x768	60Hz
7	XGA	1024x768	70Hz
8	VESA	1152x864	75Hz
9	SXGA	1280x1024	60Hz
10	VESA	1280x720	60Hz
11	WXGA	1280x800	60Hz
12	WXGA+	1440x900	60Hz
13	WSXGA+	1680x1050	60Hz
14	UXGA	1920x1080	60Hz
15	UXGA	1920x1080	75Hz

# Installation

1. Turn off your computer and unplug your computer's power cord.
2. Connect the signal cable to the VGA and /or HDMI1.4 (optional) and /or DP (optional) input socket of the monitor, and the VGA and /or HDMI1.4 (optional) and /or DP (optional) output socket of the graphics card on the computer.
3. Optional: Connect the audio input socket (AUDIO IN) of the LCD monitor and the line-out port on the computer with the audio cable.
4. Insert the monitor power cable into the power port at the back of the monitor.
5. Connect the power adapter and power cord to the monitor, then to a properly grounded AC outlet.

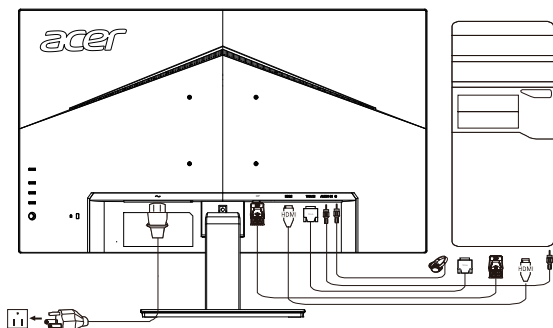

.....

Note: Audio output is only for audio output model. Please check user manual for more instruction.

\*POWER CORD specifications refer to page15

\*For the installation of replaceable parts, please refer to the above installation instructions.



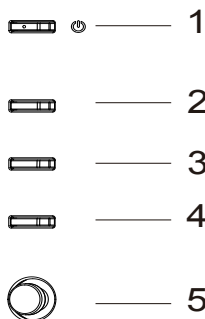

\*Users may go to the local service network to replace /purchase the qualified replaceable parts.

For local service centers and service contacts, please refer to <https://www.acer.com/ac/en/US/content/support>.

## User Controls



## External controls

1	Power button	Turns the monitor on/off. Blue indicates power on. Amber indicates standby/ power saving mode.
2	Function key 	<ol style="list-style-type: none"> <li>Press to view Main page. Press again to enter hotkey1 function.</li> <li>When the Function Menu is active, press this key to view the basic information for your monitor and current input or reset the custom color settings to the factory defaults.</li> </ol>
3	Function key 	<ol style="list-style-type: none"> <li>Press to view Main page. Press again to enter hotkey2 function.</li> <li>When the Function Menu is active, press this button to select select scenario mode or game mode .</li> </ol>
4	Function key 	<ol style="list-style-type: none"> <li>Press to view Main page. Press again to enter Input select function.</li> <li>When the Function Menu is active, this button will quit the OSD.</li> </ol>
5	Function key 	<ol style="list-style-type: none"> <li>Press to view Main page. Press again to enter next function in the Function Menu.</li> <li>The single toggle button on the backside of the Display bezel operates like a joystick. To move the cursor, simply toggle the button in four directions. Press the button to select desired option. Bright gray indicates operable. Dark gray indicates inoperable.</li> </ol>

### **Adaptive SYNC (HDMI1.4/DP):**

It can allow a Adaptive SYNC supported graphics source to dynamically adjust display refresh rate based on typical content frame rates for power efficient, virtually stutter free and low-latency display update.

## Using the Shortcut Menu



**Note:** The following content is for general reference only. Actual product specifications may vary.

The OSD (onscreen display) can be used to adjust the settings of your LCD monitor. Press the MENU key to open the OSD. You can use the OSD to adjust the picture quality, OSD position and general settings. For advanced settings, please refer to following page:

### Main page

	<ol style="list-style-type: none"> <li>1. Hot Key1 Modes, Brightness, Volume, Gamma, Contrast, Low Blue Light, Over Drive</li> <li>2. Hot Key2 Modes, Brightness, Contrast, Volume, Gamma, Low Blue Light, Over Drive</li> <li>3. Hot Key3 Input Switch Hot Key</li> <li>4. Main Menu</li> </ol>
--	--

### Hot key1 (default: Standard mode)

To choose scenario mode(sRGB, Reading, Darkroom, User, Standard, ECO, Graphics, Movie)

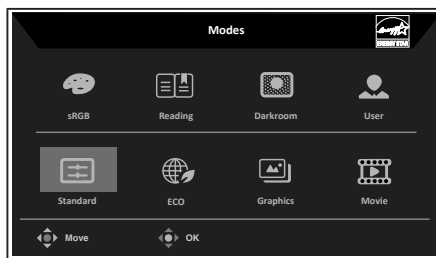

### Hot key2 (default: Brightness)

Open the Brightness control and select your preferred brightness setting . When you are done, press the joystick to quit current page and store.

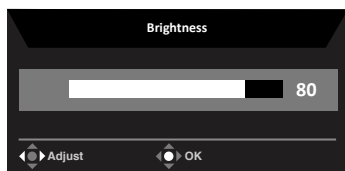

## Selecting the input

Open the Input control and select VGA IN, HDMI 1.4, DP or Auto Source. When you are done, press the joystick to exit current page and store.

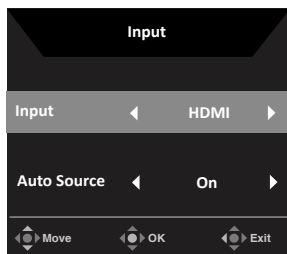

## Main menu

1. Press the MENU key to open the OSD.
2. Toggle the joystick to the up or down to select Picture from the OSD. The toggle to the right to navigate to the element you wish to adjust and press the joystick to enter it.
3. Toggle the joystick to the left or right to adjust the sliding scales.

Information Hot Key : Show Monitor Information and Reset control function.



Modes Hot Key : To change Modes Hot Key menu.

Exit Hot Key : To exit current page and store..

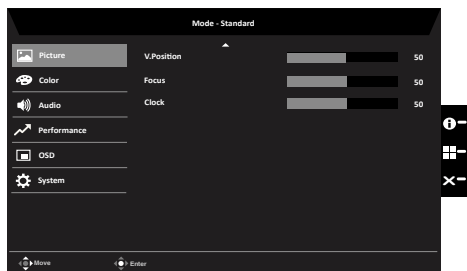
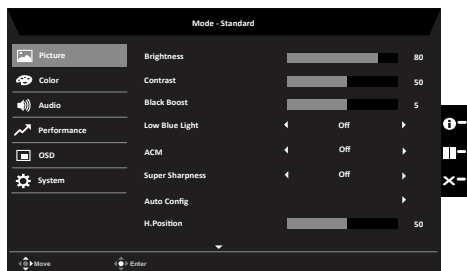
## Picture



1. Press the MENU key to open the OSD.

- Toggle the joystick to the up or down to select Picture from the OSD. Then toggle to the right to navigate to the element you wish to adjust and press the joystick to enter it.
- Toggle to the left or right to adjust the sliding scales.
- The Picture menu can be used to adjust the Brightness, Contrast, Black Boost, Low Blue Light, ACM, Super Sharpness, Auto Config, H. Position, V. Position, Focus and Clock.
- Brightness: Adjust the brightness from 0 to 100.  
 **Note:** Adjusts the balance between light and dark shades.
- Contrast: Adjust the contrast from 0 to 100.  
 **Note:** Sets the degree of difference between light and dark areas.
- Black Boost: Adjust the black level from 0 to 10. Enhances shadows by increasing the brightness without changing lighter shades.
- Low Blue Light: Filters out Low Blue Light to protect your eyes by adjusting how much Low Blue Light is shown -- 80%, 70%, 60%, or 50%.
- ACM: Turn ACM on or off.  
**Note:** Set to "On", will be based on the current screen to dynamic contrast adjustment..
- Super Sharpness: Turn the Super Sharpness On or Off. Super Sharpness technology can simulate high-resolution images by boosting the pixel density of the original source to make images sharper and clearer..

## Color

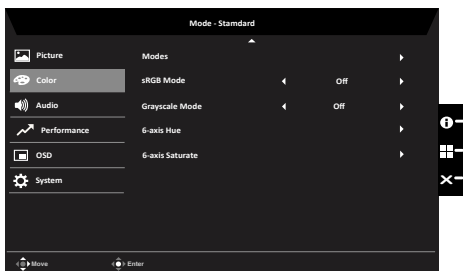
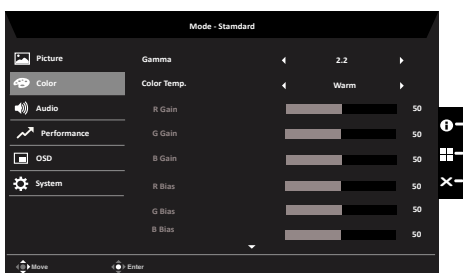

- Press the MENU key to open the OSD.
- Toggle the joystick to the up or down to select Color from the OSD. Then toggle to the right to navigate to the element you wish to adjust and press the joystick to enter it.

3. Toggle to the left or right to adjust the sliding scales.
4. Gamma mode allows you to adjust the luminance tone. The default value is 2.2 (standard value for Windows).
5. Color temperature: Default is warm. You can choose Cool, Normal, Warm, Bluelight or User.
6. Modes: To choose scenario mode.
7. Grayscale Mode: To choose Grayscale mode.
8. sRGB: Default is off. You can turn sRGB on or off to better color match with peripheral devices, such as printers and digital cameras.
9. 6-axis Hue: Adjust the red, green, blue, yellow, magenta and cyan hue.
10. 6-axis Saturate: Adjust the red, green, blue, yellow, magenta and cyan saturation.

## Audio

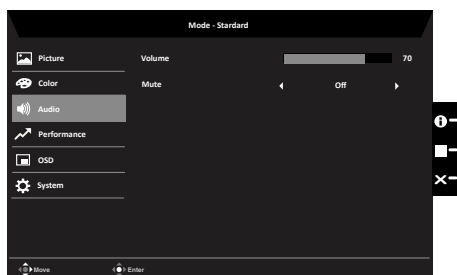

1. Press the MENU key to open the OSD.
2. Toggle the joystick to the up or down to select Audio from the OSD. Then toggle to the right to navigate to the element you wish to adjust and press the joystick to enter it.
3. Toggle to the left or right to adjust the sliding scales.
4. Volume: Adjust the volume
5. Mute: To choose mute on/off.

## Performance

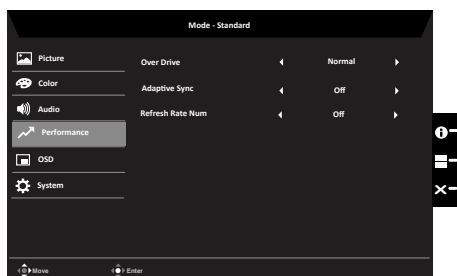

1. Press the MENU key to open the OSD.
2. Toggle the joystick to the up or down to select Gaming from the OSD. Then toggle to the right to navigate to the element you wish to adjust and press the joystick to enter it.

3. Toggle to the left or right to control functions.
4. Over Drive: Select Off, Normal or Extreme.
5. Adaptive Sync: To choose Adaptive Sync on/off.
6. Refresh rate num: Display the panel's current refresh rate on the screen.  
**Note:** If Adaptivesync set "On" you can see the V Frequency to changes in the OSD.

## OSD

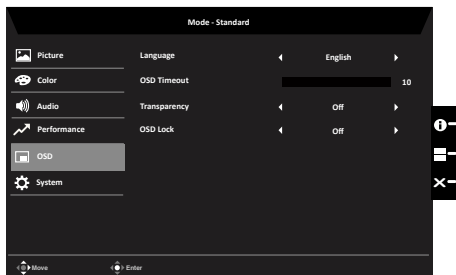

1. Press the MENU key to open the OSD.
2. Toggle the joystick to the up or down to select OSD from the OSD. Then toggle to the right to navigate to the element you wish to adjust and press the joystick to enter it.
3. Toggle to the left or right to adjust the sliding scales.
4. Language: Set the OSD menu language.
5. OSD timeout: Adjust the delay before turning off the OSD menu.
6. Transparency: Select the transparency when using gaming mode. The transparency can be 0% (OFF), 20%, 40%, 60%, or 80%.
7. OSD Lock: To choose OSD lock on/off.
  - In normal display condition to press the "Navi Key" in the middle of more than 3 seconds to trigger "OSD Unlock".
  - The "OSD Unlock" message will be displayed in the middle of the screen.
  - LED lights will be restored to Low Blue Light.

# System

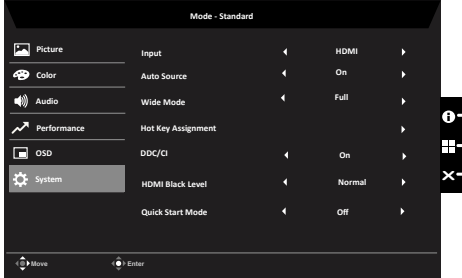

1. Press the MENU key to open the OSD.
2. Toggle the joystick to the up or down to select System from the OSD. Then toggle to the right to navigate to the element you wish to adjust and press the joystick to enter it.
3. Toggle to the left or right to control functions.
4. Input: Select the source from VGA IN, HDMI 1.4, DP.
5. Auto Source: The default is "On", which can support auto search for signal source in order.  
**Note:** Surround application must set Auto Source is "Off".
6. Wide mode: You can select which screen aspect you are using. The options are Aspect and 1:1.
7. Hotkey Assignment: Select the function of shortcut key 1 (Modes, Volume, Brightness, Gamma, Contrast, Low Blue Light, Over Drive) and shortcut keys 2 (Modes, Volume, Brightness, Gamma, Contrast, Low Blue Light, Over Drive).
8. DDC/CI: Allows the monitor settings to be set through the software on the PC.  
 **Note:** DDC/CI, short for Display Data Channel/Command Interface, which allows monitor controls to be sent via software.
9. HDMI Black level: Select to set HDMI 1.4 black level.
10. Quick start mode: Select Off or On. Turn on to speed up boot speed.

## Save Setting to...(User mode only)

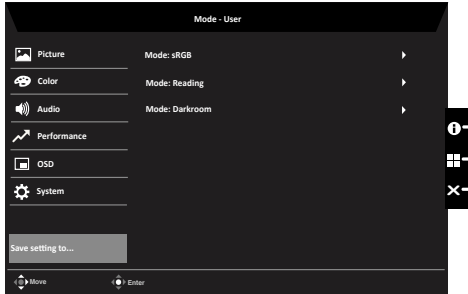

1. Press the MENU key to open the OSD.
2. Toggle the joystick to the up or down to select "Save Setting to..." from the OSD. Then toggle to the right to navigate to the element you wish to adjust and press the joystick to enter it.
3. Save Setting to Game mode: There are three user-defined profiles available. When you have decided what settings suit you, save them and system will be able to recall the settings in the future when you turn on gaming mode .

# Troubleshooting

Before sending your LCD monitor for servicing, please check the troubleshooting list below to see if you can self-diagnose the problem.

## VGA IN/HDMI1.4/DP Mode (Optional)

Problem	LED status	Remedy
No picture visible	Blue	Using the OSD menu, adjust brightness and contrast to maximum or reset to their default setting.
	Off	Check the power switch.  Check if the AC power cord is properly connected to the monitor.
	Amber	Check if the video signal cable is properly connected at the back of monitor.  Check if the computer system is switched on and in power saving/standby mode.  If OSD Lock is On, the LED status set Amber.

**Note:** Acer monitor is purposed for video and visual display of information obtained from electronic devices.

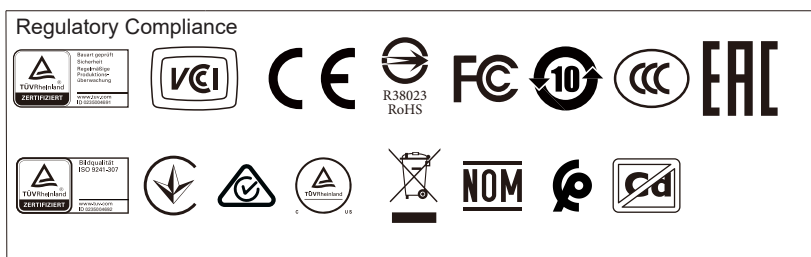

English

The default OSD mode of this monitor is ECO mode. If you wish to adjust Brightness/Contrast of your monitor, please change OSD mode to Standard mode in the Picture menu. Then you can manually adjust Brightness/Contrast level. TCO certifies the Standard mode.

繁體中文

此螢幕的 OSD 預設模式為 ECO 模式。若您想調整螢幕亮度／對比度，請在畫面選單將 OSD 模式變更為標準模式。接下來您可調整亮度／對比度。TCO 認證標準模式。



Suomi	Tämän näytön oletus-OSD-tila on ECO-tila. Jos haluat säätää näytön Kirkkautta/Kontrastia,vaihda OSD-tila Vakiotilaksi Kuva-valikossa. Sen jälkeen voit säätää Kirkkaus-/Kontrastitasoa manuaalisesti. TCO sertifioi Vakiotilan.
Français	Le mode OSD par défaut de ce moniteur est le mode ECO. Si vous souhaitez régler la luminosité/contraste de votre moniteur, veuillez modifier le mode OSD et sélectionner le mode Standard dans le menu Image. Vous pourrez ensuite régler manuellement le niveau de luminosité/contraste. Le mode Standard est certifié TCO.
Hrvatski	Zadani OSD način rada ovog monitora je ECO način rada. Ako želite prilagoditi svjetlinu/kontrast monitora, promijenite OSD način rada u izborniku Slika. Nakon toga ćete moći ručno prilagoditi razinu svjetline/kontrasta. TCO daje certifikat za Standardni način rada.
Magyar	E monitor alapértelmezett OSD módja az ÖKO mód. Amennyiben módosítani szeretné a monitor Fényerő/Kontraszt értékét, kérjük, módosítsa az OSD módját Standard (Szabványos) módra a Picture (Kép) menüben. Ezután lehetővé válik a Fényerő/Kontraszt szintjének kézi módosítása. A Standard (Szabványos) mód TCO által hitelesített.
B a h a s a Indonesia	Mode OSD default monitor ini adalah mode ECO. Jika Anda ingin menyesuaikan Kecerahan/Kontras monitor, ubah mode OSD ke mode Standar di menu Gambar. Anda dapat menyesuaikan tingkat Kecerahan/Kontras secara manual. TCO menjamin mode Standar.
Italiano	La modalità OSD predefinita di questo monitor è la modalità ECO. Se si desidera regolare Luminosità/Contrasto del monitor, cambiare la modalità OSD in modalità Standard nel menu Immagine. Quindi ,è possibile regolare manualmente il livello di Luminosità/Contrasto. TCO certifica la modalità Standard.
日本語	このモニターのデフォルト OSD モードはエコモードです。モニターの輝度 / コントラストを調整する場合は、ピクチャメニューで、OSD モードを標準モードに変更してください。TCO は標準モードを保証します。
Lietuviu	Esant numatytajai OSD režimui nuostatai, šis monitorius veikia ECO (Taupymo) režimu. Jei norite sureguliuoti monitoriaus „Brightness“ (Šviesumo) / „Contrast“ (Kontrasto) nuostatas, pakeiskite OSD režimą „Picture“ (Vaizdo) meniu pasirinkdami „Standard“ (Standartinį) režimą. Tuomet galėsite patys nustatyti „Brightness“ (Šviesumo) / „Contrast“ (Kontrasto) lygį. TCO sertifikuotas režimas yra „Standard“ (Standartinis) režimas.
Latviski	Šī monitora noklusējuma OSD režīms ir EKO režīms. Ja vēlaties pielāgot monitora spilgtumu/kontrastu, mainiet OSD režīmu uz standarta režīmu izvēlnē Picture (Attēls). Pēc tam varat manuāli pielāgot spilgtuma/kontrasta līmeni. TCO sertificē standarta režīmu.

Nederlands	<p>De standaard OSD-modus van deze monitor is ECO-modus. Als u de helderheid/het contrast van uw monitor wilt aanpassen, wijzigt u de OSD-modus naar standaard modus in het menu Foto. Vervolgens kunt u het niveau voor helderheid/contrast handmatig aanpassen. TCO certificeert de standaard modus.</p>
Norsk	<p>Standard skjermmenymodus på denne skjermen er ØKO-modus. Hvis du vil justere lysstyrke/kontrast på skjermen, må du endre skjermmenymodus til standardmodus på Bilde-menyen. Deretter kan du justere lysstyrke og kontrast manuelt. TCO sertifiserer standardmodus.</p>
Polski	<p>Domyślny tryb OSD tego monitora to tryb ECO. Aby wyregulować jasność/kontrast monitora, należy zmienić tryb OSD na tryb Standardowy w menu Obraz. Następnie można ręcznie wyregulować poziom jasności/kontrastu. Tryb Standardowy ma certyfikat TCO.</p>
Português	<p>O modo de OSD predefinido deste monitor é o modo ECO. Se deseja ajustar o Brilho/Contraste do monitor, altere o modo de OSD para o modo Padrão no menu Imagem. Em seguida, poderá ajustar o nível de Brilho/Contraste. O modo Padrão é certificado pela TCO.</p>
Română	<p>Modul OSD prestabilit al acestui monitor este modul ECO. Dacă doriți să ajustați Luminozitatea/Contrastul monitorului dvs., vă rugăm să comutați modul OSD la modul Standard în meniul Imagine. Apoi, puteți ajusta manual nivelul de Luminozitate/Contrast. TCO certifică modul Standard.</p>
Русский	<p>По умолчанию режимом экранного меню данного монитора является режим ECO. Для регулировки параметров «Яркость/Контрастность» монитора переключите режим экранного меню на «Стандартный» в меню «Изображение». Тогда вы сможете вручную отрегулировать уровень «Яркости/Контрастности». Стандартный режим сертифицирован TCO.</p>
Slovensky	<p>Režim ECO je v tomto monitore ako štandardný režim OSD. Ak chcete v monitore nastaviť jas alebo kontrast, v ponuke Obraz zmeňte režim OSD na štandardný režim. Potom môžete ručne upraviť úroveň jasú a kontrastu. Štandardný režim overuje TCO.</p>
Slovenščina	<p>Prizvzeti način zaslonkega vmesnika tega monitorja je način ECO. Če želite prilagoditi svetlost/kontrast monitorja, spremenite način zaslonkega vmesnika v standardni način v meniju »Picture« (Slika). Nato lahko ročno prilagodite raven svetlosti/kontrasta. Potrdilo za standardni način je izdal TCO.</p>
Srpski	<p>Podrazumevani režim prikaza na ekranu ovog monitora je režim ECO. Ako želite da podesite osvetljenost/kontrast monitora, promenite režim prikaza na ekranu na Standard (Standardni) u meniju Picture (Slika). Nakon toga možete ručno da podesite nivo osvetljenosti/kontrasta. TCO sertifikuje standardni režim.</p>
Svenska	<p>Standard OSD-läge för denna skärm är ECO-läge. Om du vill justera skärmens ljusstyrka/kontrast, byt OSD-läge till standardläget i bildmenyn. Då kan du manuellt justera ljusstyrka/kontrastnivå. TCO certifierar standardläget.</p>

ไทย	โหมด OSD เริ่มต้นของจอภาพนี้คือโหมด ECO หากคุณต้องการปรับความสว่าง/ความคมชัดของจอภาพ โปรดเปลี่ยนโหมด OSD เป็นโหมดมาตรฐานในเมนูรูปภาพ จากนั้นคุณสามารถปรับระดับความสว่าง/ความคมชัดได้ด้วยตนเอง TCO รับรองโหมดมาตรฐาน
Türkçe	Bu monitörün varsayılan OSD modu ECO modudur. Monitörünüzün Parlaklığını/ Kontrastını ayarlamak istiyorsanız, lütfen Resim menüsünde OSD modunu Standart moda getiriniz. Ardından, Parlaklık/Kontrast seviyesini manuel olarak ayarlayabilirsiniz. TCO Standart modu onaylar.
Українська	Режим EM за замовчуванням - це ECO. Якщо ви бажаєте регулювати Яскравість/Контраст монітора, змініть режим EM на Стандартний у меню Зображення. Тоді ви зможете вручну регулювати рівень Яскравості/ Контрасту. Стандартний режим сертифіковано TCO.
Português brasileiro	O modo OSD padrão deste monitor é o modo ECO. Se deseja ajustar o Brilho/ Contraste do seu monitor, mude o modo OSD para o modo Padrão no menu Imagem. Em seguida, você pode ajustar manualmente o nível de Brilho/Contraste. O TCO certifica o modo Padrão.





Product Information for EU Energy