



User Guide

SUMMARY

This guide provides information about components, network connection, power management, security, backing up, and more.

Legal information

© Copyright 2023 HP Development Company, L.P.

AMD is a trademark of Advanced Micro Devices, Inc. The terms HDMI, HDMI High-Definition Multimedia Interface, and the HDMI Logo are trademarks or registered trademarks of HDMI Licensing Administrator, Inc. Microsoft and Windows are either registered trademarks or trademarks of Microsoft Corporation in the United States and/or other countries. USB Type-C and USB-C are registered trademarks of USB Implementers Forum. DisplayPort™ and the DisplayPort™ logo are trademarks owned by the Video Electronics Standards Association (VESA) in the United States and other countries.

The information contained herein is subject to change without notice. The only warranties for HP products and services are set forth in the express warranty statements accompanying such products and services. Nothing herein should be construed as constituting an additional warranty. HP shall not be liable for technical or editorial errors or omissions contained herein.

First Edition: June 2023

Document Part Number: N32248-002

Product Notice

This guide describes features that are common to most products. Some features may not be available on your computer.

Not all features are available in all editions or versions of Windows. Systems may require upgraded and/or separately purchased hardware, drivers, software or BIOS update to take full advantage of Windows functionality.

To access the latest user guides, go to <http://www.hp.com/support>, and follow the instructions to find your product. Then select **Manuals**.

Software terms

By installing, copying, downloading, or otherwise using any software product preinstalled on this computer, you agree to be bound by the terms of the HP End User License Agreement (EULA). If you do not accept these license terms, your sole remedy is to return the entire unused product (hardware and software) within 14 days for a full refund subject to the refund policy of your seller.

For any further information or to request a full refund of the price of the computer, please contact your seller.

About this guide

This guide provides basic information for using and upgrading this product.





-
-  **WARNING!** Indicates a hazardous situation that, if not avoided, **could** result in serious injury or death.
 -  **CAUTION:** Indicates a hazardous situation that, if not avoided, **could** result in minor or moderate injury.
 -  **IMPORTANT:** Indicates information considered important but not hazard-related (for example, messages related to property damage). Warns the user that failure to follow a procedure exactly as described could result in loss of data or in damage to hardware or software. Also contains essential information to explain a concept or to complete a task.
 -  **NOTE:** Contains additional information to emphasize or supplement important points of the main text.
 -  **TIP:** Provides helpful hints for completing a task.
-

Table of contents

1 Computer features	1
Product features.....	1
Front components.....	1
Rear components.....	2
Labels.....	2
Setup.....	3
Warnings and cautions.....	3
Mounting and orienting the thin client.....	4
HP Quick Release.....	4
Supported mounting options.....	7
Supported orientation and placement.....	11
Unsupported placement.....	12
Routine thin client care.....	13
Installing the stand.....	13
Securing the thin client.....	15
Connecting the power cord.....	16
Hardware changes.....	16
Removing and replacing the access panel.....	16
Removing the access panel.....	16
Replacing the access panel.....	18
Locating internal components.....	19
Replacing the M.2 storage module.....	20
Replacing an eMMC storage module.....	22
Removing and replacing the battery.....	23
Upgrading system memory.....	24
Installing a memory module.....	25
2 Troubleshooting	27
Computer Setup (F10) Utilities.....	27
Using Computer Setup (F10) Utilities.....	27
Computer Setup—File.....	28
Computer Setup—Storage.....	29
Computer Setup—Security.....	30
Computer Setup—Power.....	32
Computer Setup—Advanced.....	33
Changing BIOS Settings from the HP BIOS Configuration Utility (HPBCU).....	34
Updating or restoring a BIOS.....	36
Updating the firmware for Power-on from Keyboard.....	37
Diagnostics and troubleshooting LEDs.....	37
Startup sequence.....	38

Resetting the setup and power-on passwords	38
Power-on diagnostic tests	39
Interpreting POST diagnostic front panel lights and audible codes.....	39
Basic troubleshooting.....	41
Configuring a PXE server	42
Using HP ThinUpdate to restore the image.....	43
Device management.....	43
Statement of Volatility.....	44
3 Using HP PC Hardware Diagnostics	45
Customizing Remote HP PC Hardware Diagnostics UEFI settings.....	45
4 Power cord set requirements.....	46
General requirements	46
Japanese power cord requirements.....	46
Country-specific requirements	46
5 Computer operating guidelines, routine care, and shipping preparation	48
Operating guidelines and routine care	48
Cleaning your computer	48
Removing dirt and debris from your computer.....	49
Cleaning your computer with a disinfectant.....	49
Shipping preparation	50
6 Specifications.....	51
7 Electrostatic discharge.....	52
8 Accessibility	53
HP and accessibility.....	53
Finding the technology tools you need.....	53
The HP commitment.....	53
International Association of Accessibility Professionals (IAAP).....	54
Finding the best assistive technology.....	54
Assessing your needs	54
Accessibility for HP products.....	54
Standards and legislation	55
Standards.....	55
Mandate 376 - EN 301 549	55
Web Content Accessibility Guidelines (WCAG).....	55
Legislation and regulations.....	56
Useful accessibility resources and links	56
Organizations.....	56
Educational institutions	56
Other disability resources	57
HP links.....	57

Contacting support.....57

Index.....58

1 Computer features

This chapter provides you with an overview of your thin client features.

Product features

To identify a typical computer configuration, read this section. Features vary depending on the model.



For more information about the hardware and software installed on this thin client, go to <http://www.hp.com/go/quickspecs> and search for this thin client.

Various options are available for your thin client. For more information about some of the available options, go to the HP website at <http://www.hp.com> and search for your specific thin client.

Front components

To identify the thin client front components, use this illustration and table.

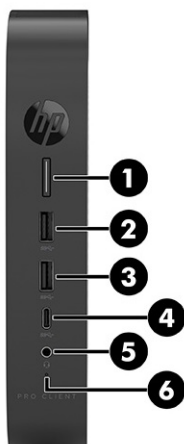

Table 1-1 Identifying the front components

Front components			
1	Power button/Power light. The LED indicates that the system is on (solid light) or is in standby (flashing).	4	USB Type-C® port (data only)
2	USB SuperSpeed port	5	Audio out (headphone)
3	USB SuperSpeed port	6	Activity light

Rear components

To identify the thin client rear components, use this illustration and table.

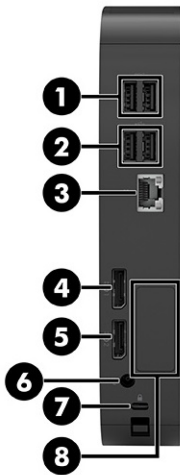

Table 1-2 Identifying the rear components

Rear components			
1	USB SuperSpeed ports (2)	5	DisplayPort connector
2	USB ports (2)	6	Power connector
3	RJ-45 (network) jack - NIC option with or without DASH Manageability support	7	Security cable slot
4	DisplayPort™ connector	8	Optional port. If provided with your unit, supports one of the following choices: single serial port with power, VGA, HDMI®, 2 x USB, USB Type-C dual role/ DisplayPort alternate mode, external WiFi antenna

Labels

The labels affixed to the computer provide information you might need when you troubleshoot system problems or travel internationally with the computer. Labels might be in paper form or imprinted on the product, either on the bottom of the computer or under the service door.

- Service label—Provides important information to identify your computer. When contacting support, you might be asked for the serial number, the product number, or the model number. Locate this information before you contact support.

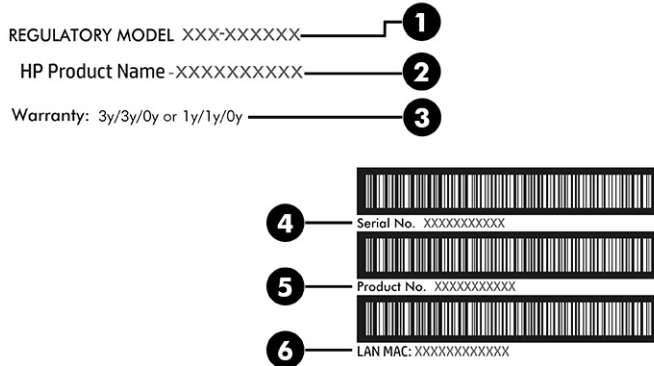

Table 1-3 Service label components

Component	Description
1	Regulatory model number
2	HP product name
3	Warranty period
4	Serial number
5	Product number
6	LAN MAC

- Regulatory labels—Provide regulatory information about the computer.
- Wireless certification labels—Provide information about optional wireless devices and the approval markings for the countries or regions in which the devices have been approved for use.

Setup

Follow the instructions carefully to set up your thin client.

Warnings and cautions

Before performing upgrades be sure to carefully read all of the applicable instructions, cautions, and warnings in this guide.

⚠ WARNING! To reduce the risk of personal injury or equipment damage from electric shock, hot surfaces, or fire:

- Install the thin client in a location where children are unlikely to be present.
- Disconnect power from the thin client and allow the internal system components to cool before you touch them.

- Do not plug telecommunications or telephone connectors into the network interface controller (NIC) receptacles.
- Do not disable the power cord grounding plug. The grounding plug is an important safety feature.
- Plug the power cord into a grounded (earthed) AC outlet that is easily accessible at all times.

To reduce the risk of serious injury, read the Safety & Comfort Guide. It describes proper workstation setup, posture, and health and work habits for thin client users, and provides important electrical and mechanical safety information. The Safety & Comfort Guide is located on the HP website at <http://www.hp.com/ergo>.

 **WARNING!** Energized parts are inside.

- Disconnect power to the equipment before removing the enclosure.
- Replace and secure the enclosure before re-energizing the equipment.

 **IMPORTANT:** Static electricity can damage the electrical components of the thin client or optional equipment. Before beginning the following procedures, be sure that you are discharged of static electricity by briefly touching a grounded metal object. See [Electrostatic discharge on page 52](#) for more information.

When the thin client is plugged into an AC power source, voltage is always applied to the system board. To prevent damage to internal components, you must disconnect the power cord from the power source before opening the thin client.

 **NOTE:** An optional Quick Release mounting bracket is available from HP for mounting the thin client to a wall, desk, or swing arm. When the mounting bracket is used, do not install the thin client with the I/O ports oriented towards the ground.

Mounting and orienting the thin client

You can mount and orient the thin client in several different ways.

 **IMPORTANT:** Use an HP-approved mounting bracket to avoid cracking the thin client.

HP Quick Release

An optional Quick Release mounting bracket is available from HP for mounting the thin client to a wall, desk, or swing arm. When the mounting bracket is used, do not install the thin client with the I/O ports oriented towards the ground.

This thin client incorporates four mounting points on the right side of the unit. These mounting points follow the VESA (Video Electronics Standards Association) standard, which provides industry-standard mounting interfaces for Flat Displays (FDs), such as flat panel monitors, flat displays, and flat TVs. The HP Quick Release connects to the VESA-standard mounting points, allowing you to mount the thin client in a variety of orientations.

 **NOTE:** When mounting to a thin client, use the 10 mm screws supplied with the HP Quick Release.



To use the HP Quick Release:

1. Lay the thin client down with the right side up and the front side with the HP logo facing you.
2. Lift the side cover at the recess (1), and then remove the cover from the thin client using a coin or screwdriver (2).

⚠ CAUTION: If the thin client has been in operation prior to removing the side cover, the metal plate underneath the side cover can reach temperatures that may cause discomfort if directly touched. Turn the thin client off and allow 20 minutes for it to cool down to room temperature before you remove the side cover.

📝 NOTE: Retain the side cover for possible future use.

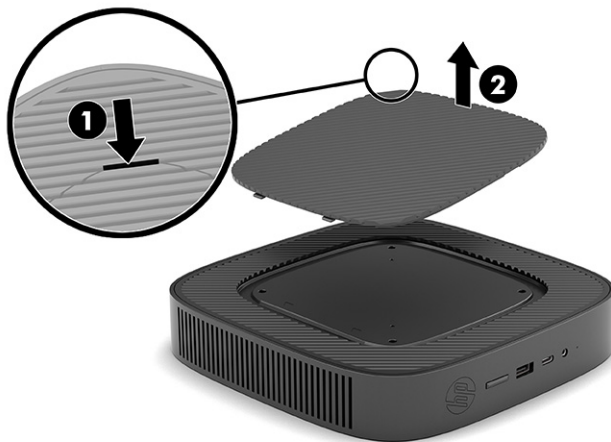

3. Set the thin spacer into the depression on the right side of the thin client.



 **NOTE:** Two spacers are included with the thin client. Use the thinner spacer when mounting the thin client.

4. Using four 10 mm screws included in the mounting device kit, attach one side of the HP Quick Release to the thin client as shown in the following illustration.

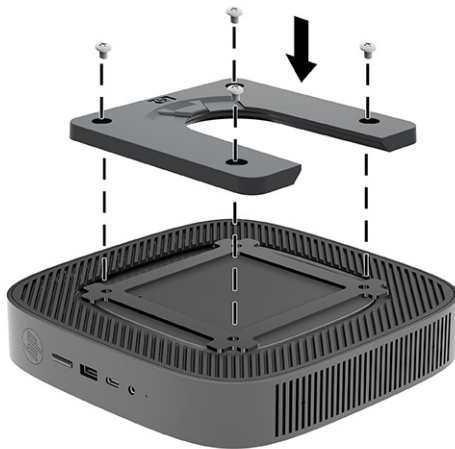

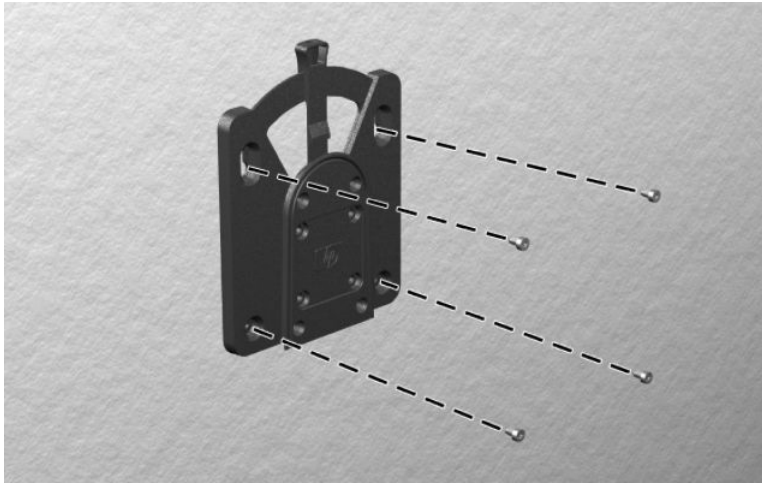

- Using four screws included in the mounting device kit, attach the other side of the HP Quick Release to the device you will mount the thin client to. Be sure that the release lever points upward.

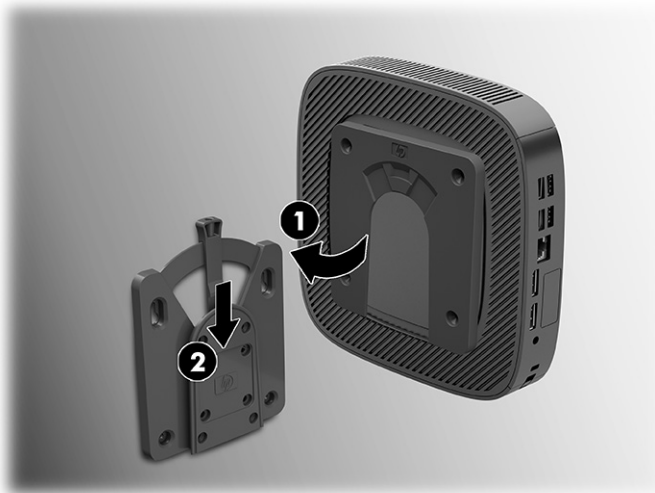

- Slide the side of the mounting device attached to the thin client (1) over the other side of the mounting device (2) on the device where you want to mount the thin client. An audible click indicates a secure connection.



 **IMPORTANT:** To ensure proper function of the HP Quick Release and a secure connection of all components, be sure that both the release lever on one side of the mounting device and the rounded opening on the other side face upward.

 **NOTE:** When attached, the HP Quick Release automatically locks in position. You need to slide the lever only to one side to remove the thin client.

Supported mounting options

The following illustrations demonstrate some of the supported mounting options for the mounting bracket.

On the back of a monitor:



On a wall:



Under a desk:



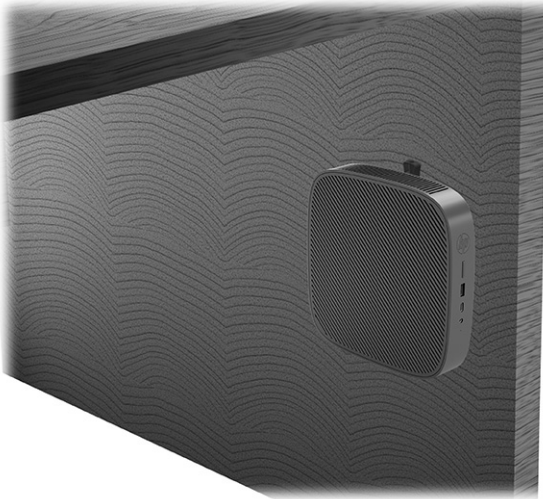

Into a dual VESA® mount:

1. Place the VESA cage on the rear of the monitor (1), and then tighten the screws (2).

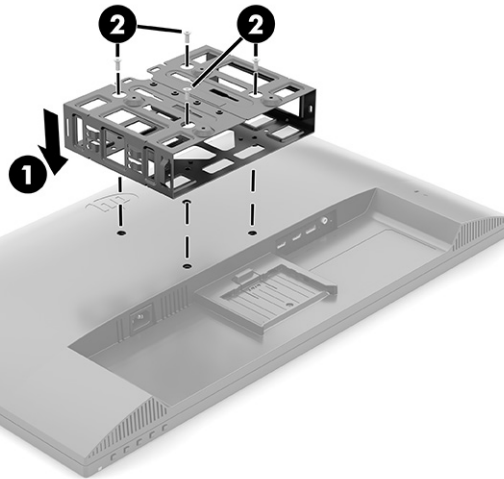

2. Attach the VESA bracket to the thin client (1), and then tighten the screws (2).

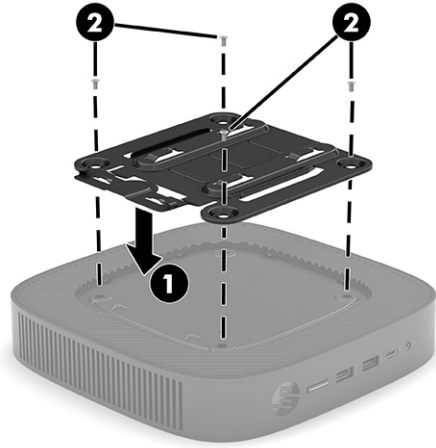

3. Install the thin client into the VESA cage on the rear of the monitor.

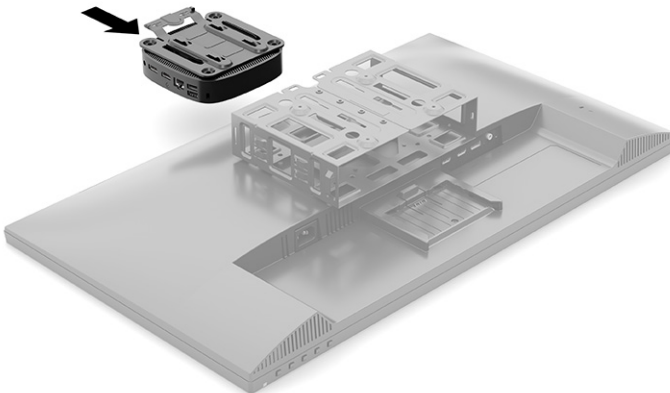

4. Attach the monitor arm to the VESA cage (1) by tightening the screws (2).

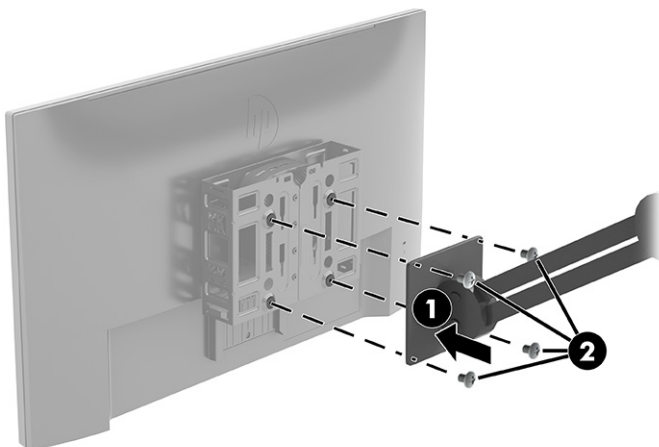

Supported orientation and placement

The following illustrations demonstrate some of the supported orientation and placement options for the thin client.



NOTE: You must adhere to the HP-supported orientation to ensure your thin clients function properly.

Unless the thin client is mounted with the HP Quick Release, you must operate it with the stand attached to ensure proper airflow around the thin client.

- HP supports the horizontal orientation for the thin client:



- HP supports the vertical orientation for the thin client:



- You can place the thin client under a monitor stand with at least 2.54 cm (1 in) clearance:

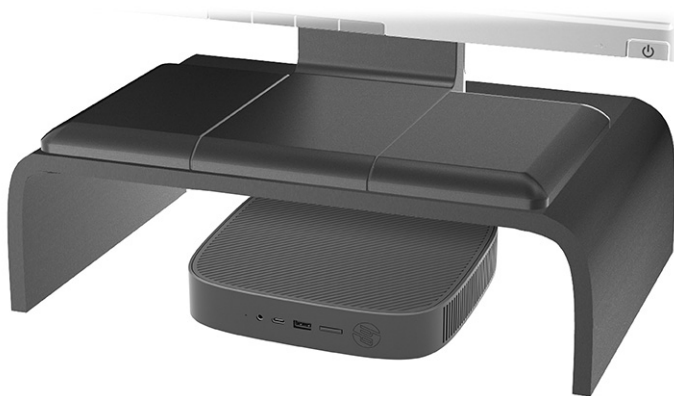

Unsupported placement

HP does not support the following placements for the thin client:

IMPORTANT:

- Unsupported placement of thin clients could result in operation failure, damage to the devices, or both.
 - Thin clients require proper ventilation to maintain operating temperature. Do not block the vents.
 - Do not install the thin client with the I/O ports oriented towards the ground.
-
- In a desk drawer:



- With a monitor on the thin client:



Routine thin client care

Use the following information to properly care for your thin client:

- Never operate the thin client with the outside panel removed.
- Keep the thin client away from excessive moisture, direct sunlight, and extreme heat and cold. For information about the recommended temperature and humidity ranges for the thin client, go to <http://www.hp.com/go/quickspecs>.
- Keep liquids away from the thin client and keyboard.
- Turn off the thin client and wipe the exterior with a soft, damp cloth as needed. Using cleaning products can discolor or damage the finish.

Installing the stand

You can use the thin client in either a tower or horizontal orientation with the stand included with the thin client.

 **IMPORTANT:** Unless the thin client is mounted with the HP Quick Release, it must be operated with the stand attached to ensure proper airflow around the thin client.

1. Remove all removable media, such as USB flash drives, from the thin client.
2. Turn off the thin client properly through the operating system, and then turn off any external devices.
3. Disconnect the thin client's power cord from the AC outlet, and then disconnect any other cables or devices that are connected to the thin client.
4. Remove or disengage any security devices that prohibit opening the thin client.
5. Tower orientation: Attach the stand to the bottom of the thin client.
 - a. Turn the thin client upside down and locate the two screw holes in the grid on the bottom of the thin client.
 - b. Position the stand over the bottom of the thin client **(1)** and line up the captive screws in the stand with the screw holes in the thin client.

- c. Tighten the captive screws securely **(2)**.

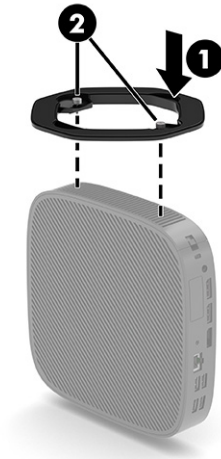

- 6. Horizontal orientation: Attach the stand to the right side of the thin client.
 - a. Lay the thin client down with the right side up and the front side with the HP logo facing you.
 - b. Lift the side cover at the recess **(1)**, and then remove the cover **(2)** from the thin client.

 **NOTE:** Retain the side cover for possible future use.

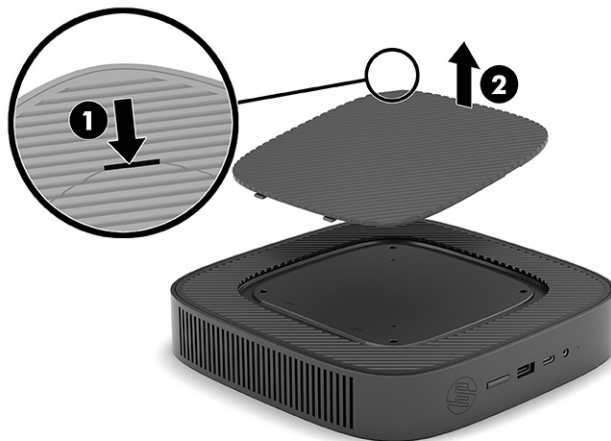

- c. Locate the two screw holes in the grid on the right side of the thin client.
- d. Position the stand over the side of the thin client and then lower it onto the thin client **(1)**.
- e. Line up the captive screws in the stand with the screw holes in the thin client **(2)**.

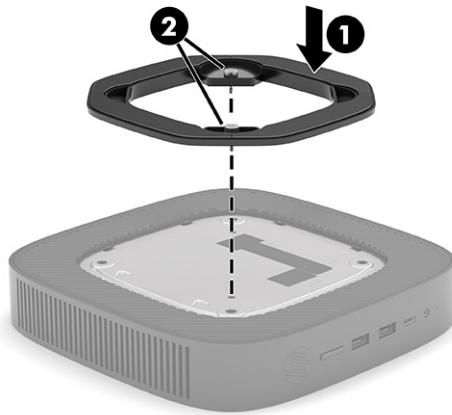

- f. Tighten the captive screws securely.
7. Reconnect the power cord and any other cables or other devices, such as USB flash drives, and then turn the thin client on.

 **NOTE:** Be sure that at least 10.2 centimeters (4 inches) of space on all sides of the thin client remain clear and free of obstructions.

8. Lock any security devices that were disengaged when the thin client cover or access panel was removed.

Securing the thin client

Your thin client is designed to accept a security cable. The security cable prevents unauthorized removal of the thin client and access to the secure compartment.

To order this option, go to the HP website at <http://www.hp.com> and search for your specific thin client.

1. Locate the security cable slot on the back panel.
2. Insert the security cable lock into the slot (1), and then use the key to lock it (2).

 **NOTE:** The security cable is designed to act as a deterrent, but it might not prevent the computer from being mishandled or stolen.

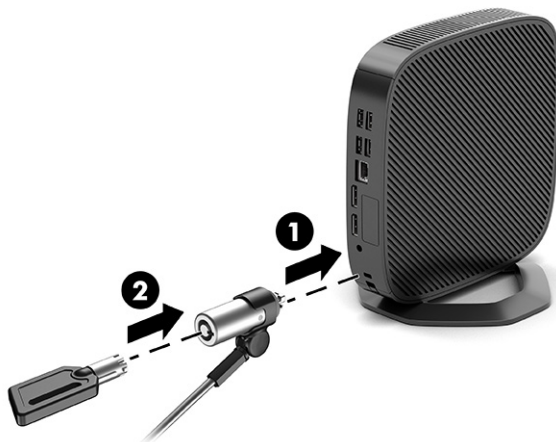

Connecting the power cord

Connect a power cord to your computer by following these steps.

1. Connect the power cord to the power adapter (1).
2. Connect the power cord to an AC outlet (2).
3. Connect the power cord to the thin client (3).

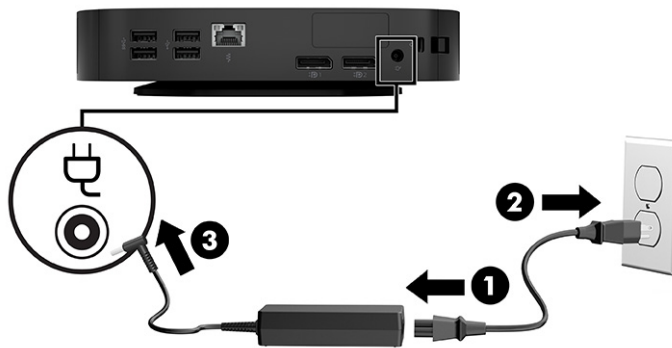

Hardware changes

You can change or replace certain thin client hardware.

Removing and replacing the access panel

Remove the access panel to replace or upgrade internal components.

Removing the access panel

To remove the access panel, use these procedures.

-
- ⚠ WARNING!** Before removing the access panel, be sure that the thin client is turned off and the power cord is disconnected from the AC outlet.
-

To remove the access panel:

1. Remove or disengage any security devices that prohibit opening the thin client.
2. Remove all removable media, such as USB flash drives, from the thin client.
3. Turn off the thin client properly through the operating system, and then turn off any external devices.
4. Disconnect the power cord from the AC outlet and disconnect any external devices.

-
- ⚠ CAUTION:** Regardless of the power-on state, voltage is always present on the system board as long as the system is plugged into an active AC outlet. You must disconnect the power cord to avoid damage to the internal components of the thin client.
-

5. Remove the stand from the thin client.
 - a. Turn the thin client upside down and locate the two screw holes in the grid on the bottom of the thin client.
 - b. Loosen the captive screws to release the stand (1) and pull the stand off the thin client (2).

Tower orientation

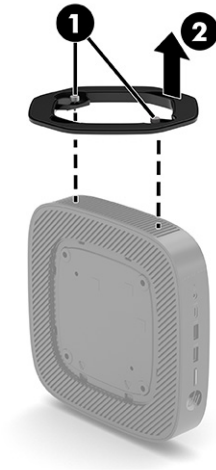

Horizontal orientation

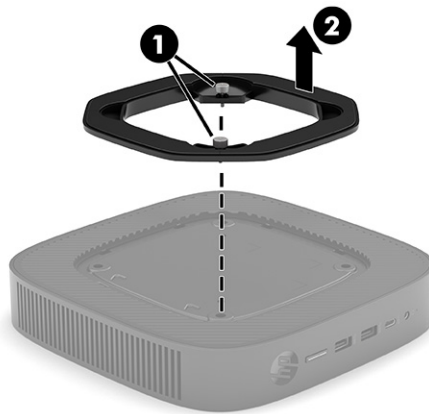

6. Lay the unit flat on a stable surface with the left side up and the rear I/O panel facing you.
7. Release the latch (1) on the right side of the rear I/O panel, carefully rotate the I/O panel (2) to the left, and then lift it off the thin client.

⚠ CAUTION: If you use too much force when removing the panel, the plastic clips might break.

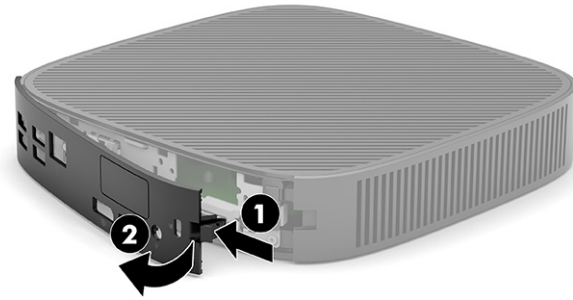

8. Press the panel release button (1) that secures the access panel to the chassis.
9. Rotate the access panel upward (2) and lift it off the thin client (3).

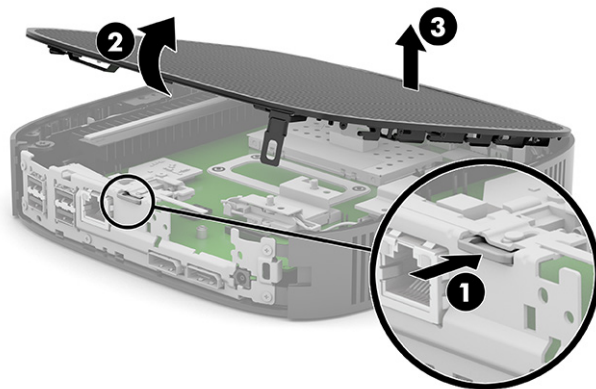

Replacing the access panel

To replace the access panel, use this procedure.

-  **NOTE:** When replacing the access panel, orient the panel so that the edge with the metal tab is nearest you. Be sure that you align the two metal clips on the front edge of the access panel to the two retainers inside the thin client.

1. Place the front edge of the access panel into the slot at the front of the thin client (1), then lower the panel in place, ensuring the metal tab is on the outside of the I/O panel (2). There will be an audible click when the panel is replaced.

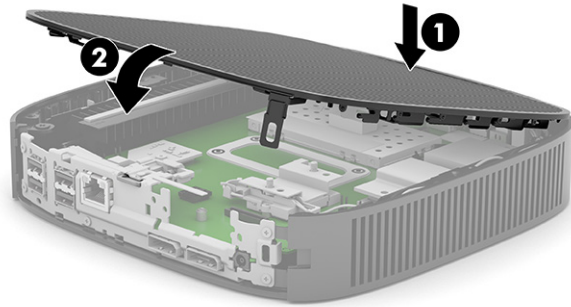

2. Insert the hooks on the left side of the rear I/O panel (1) into the left side of the back of the chassis, rotate the right side (2) to the chassis, and then press it gently to the chassis until the latch clicks in place.

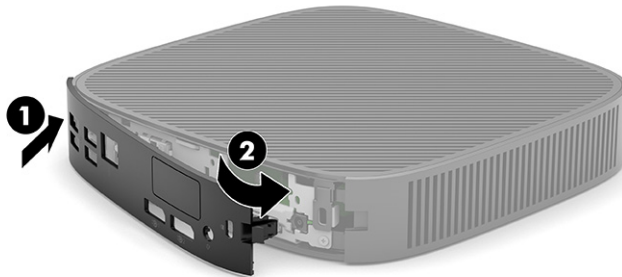

3. Replace the thin client stand.
4. Reconnect the power cord and turn on the thin client.
5. Lock any security devices that were disengaged when the thin client access panel was removed.

Locating internal components

Use this illustration and table to identify thin client internal components.

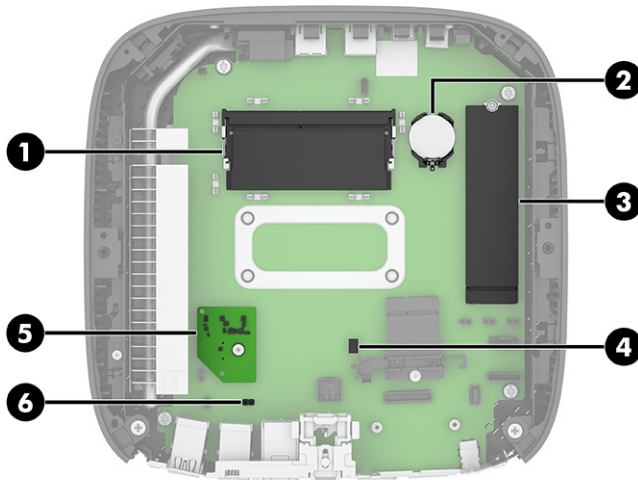

Table 1-4 Identifying the internal components

Item	Component
1	System memory module
2	Battery
3	M.2 socket for a 30 mm (2230) or 80 mm (2280) M.2 storage module
4	BIOS reset switch
5	eMMC storage module
6	BIOS password reset jumper

Replacing the M.2 storage module

You can install a 30 mm (2230) or an 80 mm (2280) M.2 primary storage module in the thin client. To replace the M.2 storage module, use these procedures.

IMPORTANT: You must unplug the power cord and wait approximately 30 seconds for the power to drain before adding or removing the M.2 storage module. Regardless of the power-on state, voltage is always supplied to the M.2 storage module as long as the thin client is plugged into an active AC outlet. Adding or removing the M.2 storage module while voltage is present can cause irreparable damage to the M.2 storage module or system board.

Static electricity can damage the electronic components of the thin client. Before beginning the following procedures, be sure that you are discharged of static electricity by briefly touching a grounded metal object. For more information, see [Electrostatic discharge on page 52](#).

When handling an M.2 storage module, be careful not to touch any of the contacts. Doing so can damage the module.

To replace the M.2 storage module:

1. Remove the thin client access panel. See [Removing the access panel on page 16](#).

WARNING! To reduce risk of personal injury from hot surfaces, allow the internal system components to cool before you touch them.

2. Locate the M.2 socket on the system board. See [Locating internal components on page 19](#).
3. Loosen the screw securing the storage module until the end of the module can be raised.
4. Pull the storage module out of the socket.

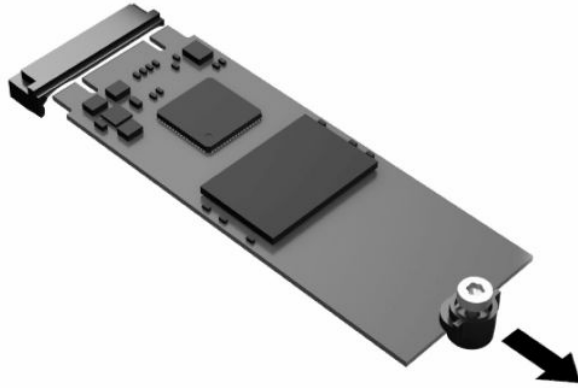

5. Pull the screw kit off the storage module and attach it to the replacement storage module.



6. Slide the new storage module into the M.2 socket on the system board at approximately a 30° angle, and then press the module connectors firmly into the socket.



NOTE: A storage module can be installed in only one way.

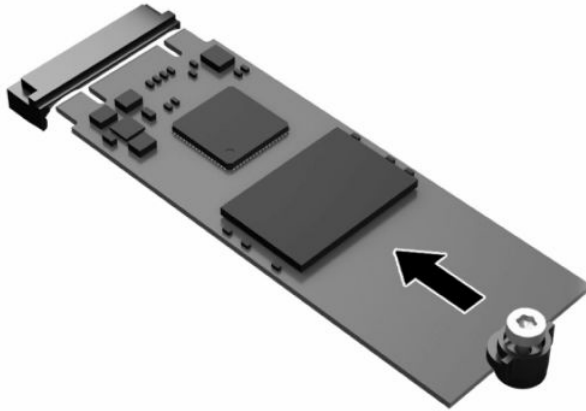

7. Press the storage module down and use a screwdriver to tighten the screw and secure the module to the system board.

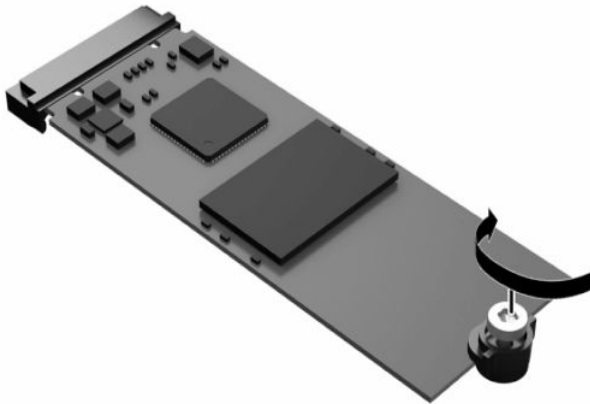

8. Replace the access panel. See [Replacing the access panel on page 18](#).

The thin client automatically recognizes the new M.2 storage module when you turn on the thin client.

Replacing an eMMC storage module

To replace an eMMC storage module, use these procedures.

 **IMPORTANT:** You must unplug the power cord and wait approximately 30 seconds for the power to drain before adding or removing the eMMC storage module. Regardless of the power-on state, voltage is always supplied to the eMMC storage module as long as the thin client is plugged into an active AC outlet. Adding or removing the eMMC storage module while voltage is present can cause irreparable damage to the eMMC storage module or system board.

Static electricity can damage the electronic components of the thin client. Before beginning the following procedures, be sure that you are discharged of static electricity by briefly touching a grounded metal object. For more information, see [Electrostatic discharge on page 52](#).

When handling an eMMC storage module, be careful not to touch any of the contacts. Doing so can damage the module.

To install an eMMC storage module:

1. Remove the thin client access panel. See [Removing the access panel on page 16](#).

⚠ WARNING! To reduce risk of personal injury from hot surfaces, allow the internal system components to cool before you touch them.

2. Locate the eMMC storage module on the system board. See [Locating internal components on page 19](#).
3. To remove the eMMC storage module, remove the screw that secures the module, and then carefully lift the module from the thin client.

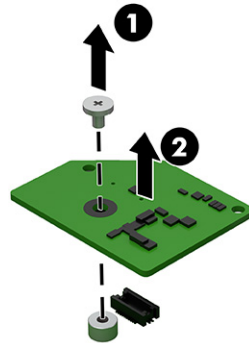

4. Carefully seat the new eMMC storage module onto the system board, and then replace the screw that secures the module.
5. Replace the access panel. See [Replacing the access panel on page 18](#).

The thin client automatically recognizes the new eMMC storage module when you turn on the thin client.

Removing and replacing the battery

To remove and replace the battery, use these procedures.

⚠ WARNING! Before removing the access panel, be sure that the thin client is turned off and the power cord is disconnected from the AC outlet.

To remove and replace the battery:

1. Remove the thin client access panel. See [Removing the access panel on page 16](#).

⚠ WARNING! To reduce risk of personal injury from hot surfaces, allow the internal system components to cool before you touch them.

2. Locate the battery on the system board. See [Locating internal components on page 19](#).
3. To release the battery from its holder, squeeze the metal clamp that extends above one edge of the battery. When the battery pops up, lift it out **(1)**.

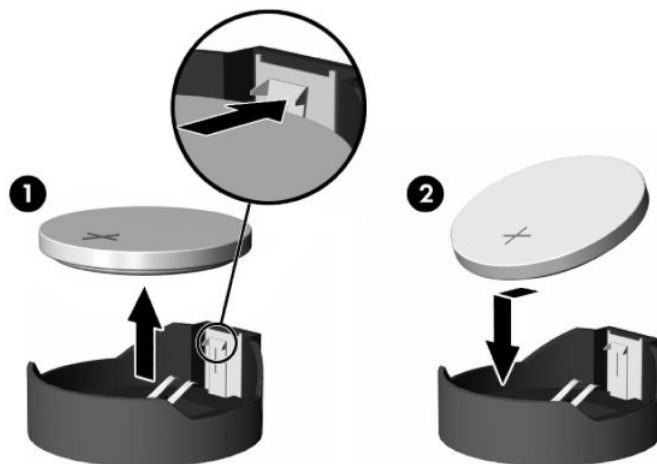

- To insert the new battery, slide one edge of the replacement battery under the holder's lip with the positive side up. Push the other edge down until the clamp snaps over the other edge of the battery (2).



- Replace the access panel. See [Replacing the access panel on page 18](#).

HP encourages customers to recycle used electronic hardware, HP original print cartridges, and rechargeable batteries. For more information about recycling programs, go to <http://www.hp.com> and search for "recycle."

Table 1-5 Battery icon definitions

Icon	Definition
	Do not dispose of batteries, battery packs, and accumulators with the general household waste. In order to forward them to recycling or proper disposal, use the public collection system or return them to HP, an authorized HP partner, or their agents.
	The Taiwan EPA requires dry battery manufacturing or importing firms, in accordance with Article 15 or the Waste Disposal Act, to indicate the recovery marks on the batteries used in sales, giveaways, or promotions. Contact a qualified Taiwanese recycler for proper battery disposal.

Upgrading system memory

The memory socket on the system board is populated with one memory module. To achieve the maximum memory support, you can populate the memory socket with up to 16 GB of memory.

For proper system operation, the memory module must adhere to the following specifications:

- Industry-standard 260-pin Small Outline DIMM (SODIMM)
- Unbuffered non-ECC PC4-19200 DDR4-3200 MHz
- 1.2 volt DDR4-SDRAM memory module

The thin client supports the following:

- Single-rank and dual-rank modules
- Single-sided and double-sided memory modules

A higher-speed DDR4 SODIMM module operates at a maximum system memory speed of 3200 MT/s.

 **NOTE:** The system does not operate properly when an unsupported memory module is installed.

Installing a memory module

To install a memory module, use these procedures.

 **IMPORTANT:** You must unplug the power cord and wait approximately 30 seconds for the power to drain before adding or removing the memory module. Regardless of the power-on state, voltage is always supplied to the memory module as long as the thin client is plugged into an active AC outlet. Adding or removing the memory module while voltage is present can cause irreparable damage to the memory module or system board.

The memory module socket has gold-plated metal contacts. When upgrading the memory, it is important to use a memory module with gold-plated metal contacts to prevent corrosion or oxidation resulting from having incompatible metals in contact with each other.

Static electricity can damage the electronic components of the thin client. Before beginning the following procedures, be sure that you are discharged of static electricity by briefly touching a grounded metal object. For more information, see [Electrostatic discharge on page 52](#).

When handling a memory module, be careful not to touch any of the contacts. Doing so can damage the module.

To install a memory module:

1. Remove the thin client access panel. See [Removing the access panel on page 16](#).

 **WARNING!** To reduce risk of personal injury from hot surfaces, allow the internal system components to cool before you touch them.

2. Locate the memory module on the system board. See [Locating internal components on page 19](#).
3. Remove the EMI shield that is over the memory module.

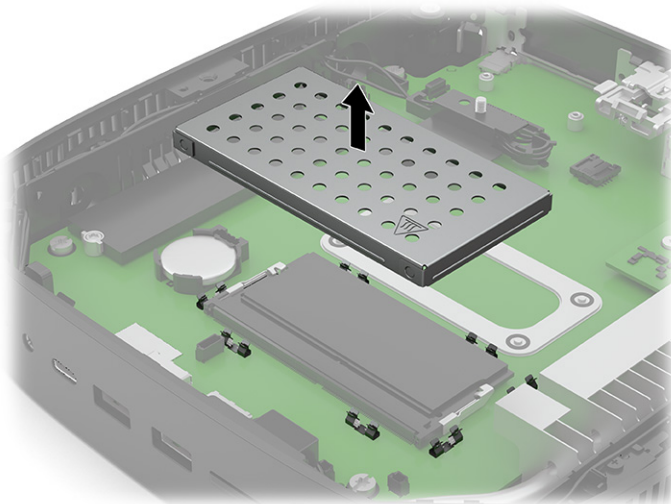

4. To remove the memory module, press outward on the latches on each side of the memory module (1), rotate the memory module up, and then pull the memory module out of the socket (2).

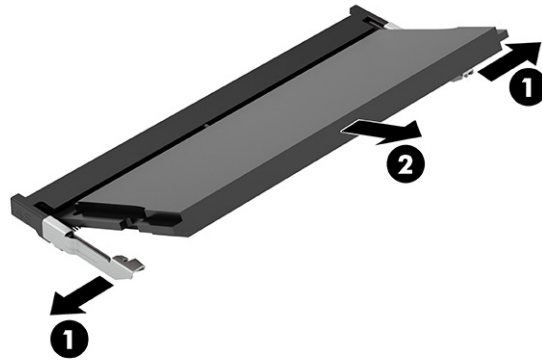

5. Slide the new memory module (1) into the socket at approximately a 30° angle, and then press the memory module down (2) so that the latches lock it in place.



NOTE: A memory module can be installed in only one way. Match the notch on the module with the tab on the memory socket.



6. Replace the access panel. See [Replacing the access panel on page 18](#).

The thin client automatically recognizes the new memory when you turn on the thin client.

2 Troubleshooting

This chapter provides you with information to help with troubleshooting your thin client.

Computer Setup (F10) Utilities

This information provides details of the Computer Setup Utility.

Use Computer Setup (F10) Utility to do the following tasks:

- Change settings from the defaults or restore the settings to default values.
- Set the system date and time.
- Set, view, change, or verify the system configuration, including settings for processor, graphics, memory, audio, storage, communications, and input devices.
- Modify the boot order of bootable devices such as solid-state drives or USB flash media devices.
- Select **POST Messages Enabled** or **POST Messages Disabled** to change the display status of Power-On Self-Test (POST) messages. **POST Messages Disabled** suppresses most POST messages, such as memory count, product name, and other non-error text messages. If a POST error occurs, the error is displayed regardless of the mode selected. To manually switch to **POST Messages Enabled** during POST, press any key except **f1** through **f12**.
- Enter the Asset Tag or property identification number assigned by the company to this computer.
- Enable the power-on password prompt during system restarts (warm boots) as well as during startup.
- Establish a setup password that controls access to the Computer Setup (F10) Utility and the settings described in this section.
- Secure integrated I/O functionality, including the USB, audio, or embedded NIC, so that they cannot be used until they are unsecured.

Using Computer Setup (F10) Utilities

You can access Computer Setup only by turning the computer on or restarting the system.

To access the Computer Setup Utilities menu, complete these steps:

1. Turn on or restart the computer.
2. Press either **esc** or **f10** while the “Press the ESC key for Startup Menu” message is displayed at the bottom of the screen.

Pressing **esc** displays a menu that allows you to access different options available at startup.

 **NOTE:** If you do not press **esc** or **f10** at the appropriate time, you must restart the computer and again repeatedly press **esc** or **f10** when the power button light turns white to access the utility.

 **NOTE:** You can select the language for most menus, settings, and messages using the Language Selection option using the **f8** key in Computer Setup in the HP Setup Utility.

3. If you pressed **esc**, press **f10** to enter Computer Setup.

A choice of five headings appears in the Computer Setup Utilities menu: File, Storage, Security, Power, and Advanced.

4. Use the arrow (left and right) keys to select the appropriate heading. Use the arrow (up and down) keys to select the option that you want, and then press **enter**. To return to the Computer Setup Utilities menu, press **esc**.
5. To apply and save changes, select **File**, and then select **Save Changes and Exit**.
 - If you have made changes that you do not want applied, select **Ignore Changes and Exit**.
 - To reset to factory settings, select **Apply Defaults and Exit**. This option restores the original factory system defaults.

 **IMPORTANT:** Do not turn the computer power off while the BIOS is saving the Computer Setup (F10) changes because the BIOS settings could become corrupted. It is safe to turn off the computer only after exiting the F10 Setup screen.

Computer Setup—File

This table provides information about the Computer Setup File menu.

 **NOTE:** Support for specific Computer Setup options can vary, depending on the hardware configuration.

Table 2-1 Computer Setup—File

Option	Description
System Information	Lists: <ul style="list-style-type: none">• Product name• SKU number• System board CT number• Processor type• Processor speed• Processor stepping• Cache size (L1/L2/L3)• Memory size• Integrated MAC• System BIOS• USB Type-C PD FW Version• TPM Firmware Version• Chassis serial number• SKU Number• UUID• Asset tracking number• Feature Byte• Build ID
About	Displays copyright notice.
Flash System BIOS	Allows you to flash system BIOS or device firmware from a USB recovery key.
Set Time and Date	Allows you to set system time and date.
Default Setup	Allows you to: <ul style="list-style-type: none">• Save Current Settings as Default• Restore Factory Settings as Default
Apply Defaults and Exit	Applies the original factory system configuration settings for use by a subsequent Apply Defaults and Exit action.
Ignore Changes and Exit	Exits Computer Setup without applying or saving any changes.
Save Changes and Exit	Saves changes to current system configuration, exits Computer Setup, and reboots.

Computer Setup—Storage

This table provides information about the Computer Setup Storage menu.



NOTE: Support for specific Computer Setup options can vary, depending on the hardware configuration.

Table 2-2 Computer Setup—Storage

Option	Description
Device configuration	<p>Lists all installed BIOS-controlled storage devices. When a device is selected, detailed information and options are displayed. The following options can be presented:</p> <ul style="list-style-type: none">• Hard Disk—Size, model, firmware version.• Secure Erase—Allows you to use the software utility to issue a Secure Erase instruction to a target storage device during the next boot. <p>NOTE: The Secure Erase option is visible only after you select a specific hard disk to view.</p> <p>NOTE: To access the Secure Erase option, you must have a setup password defined. If you do not have one, create a setup password, save the changes, and then restart the thin client. When the thin client starts up, you will be able to select Launch Secure Erase.</p>
Storage Options	<p>External USB Storage Boot—Allows you to set USB storage device.</p>
Boot Order	<p>Allows you to:</p> <ul style="list-style-type: none">• Specify the order for checking EFI boot sources (such as a internal drive, USB hard drive, or USB optical drive) for a bootable operating system image. Each device on the list can be individually excluded from or included for consideration as a bootable operating system source. EFI boot sources always have precedence over legacy boot sources.• Specify the order for checking legacy boot sources (such as a network interface card, internal drive, or USB optical drive) for a bootable operating system image. Each device on the list can be individually excluded from or included for consideration as a bootable operating system source.• Specify the order of attached hard drives. The first hard drive in the order has priority in the boot sequence and is recognized as drive C (if any devices are attached). <p>NOTE: You can use f5 to disable individual boot items, as well as disable EFI boot or legacy boot.</p> <p>Shortcut to Temporarily Override Boot Order</p> <p>To boot one time from a device other than the default device specified in Boot Order:</p> <ol style="list-style-type: none">1. Restart the computer.2. Complete one of these tasks:<ul style="list-style-type: none">• Press esc (to access the Startup menu) and then f9 (Boot Menu).• Press f9 (skipping the Startup menu) when the power button light turns white.After POST is completed, a list of bootable devices is displayed.3. Use the arrow keys to select the preferred bootable device and press enter. <p>The computer then boots from the selected device for this one time.</p>

Computer Setup—Security

This table provides information about the Computer Setup Security menu.



NOTE: Support for specific Computer Setup options can vary, depending on the hardware configuration.

Table 2-3 Computer Setup—Security

Option	Description
Setup Password	Allows you to set and enable a setup (administrator) password. NOTE: If the setup password is set, you must supply the password to change Computer Setup options, flash the BIOS, use the Secure Erase feature, and then make changes to certain plug and play settings under Windows®.
Power-On Password	Allows you to set and enable a power-on password. The power-on password prompt appears after a power cycle or reboot. If you do not enter the correct power-on password, the unit will not boot.
Password Options (This selection shows only if a power-on password or setup password is set.)	Allows you to enable or disable: <ul style="list-style-type: none">• Stringent Password—When set, enables a mode that does not permit physical bypass of the password function. If disabled, you can reset the setup password by removing the password jumper, which restores access to computer setup functions, even if you have forgotten the password. If Strong Password is enabled, removing the password jumper from the system board will have no effect. You must be able to enter the setup password. See Resetting the setup and power-on passwords on page 38.• Password Prompt on F9 & F12—Default is enabled. If enabled, pressing either f9 or f12 during system startup prompts you to enter Setup Password. If disabled, even if you have a setup password defined, these menus can be accessed without entering a password.• Setup Browse Mode—Allows viewing, but not changing, the F10 Setup Options without entering the setup password. Default is enabled.
Device Security	Allows you to set Device Available (default) or Device Hidden for: <ul style="list-style-type: none">• System audio• Network controller• M.2 Storage 0
USB Security	Allows you to set Enabled (default) or Disabled for: <ul style="list-style-type: none">• Front USB ports• Rear USB ports
Slot Security	Allows you to disable the WLAN slot to disable the WLAN card. Default is enabled.
Network Boot Security	Enables/disables the computer's ability to start from an operating system installed on a network server. Default is enabled.
System IDs	Allows you to set: <ul style="list-style-type: none">• Asset tag (18-byte identifier)—A property identification number assigned by the company to the computer• Ownership tag (80-byte identifier)

Table 2-3 Computer Setup–Security (continued)

Option	Description
System Security	<p>Provides these options:</p> <ul style="list-style-type: none">• Data Execution Prevention (enable or disable)—Helps prevent operating system security breaches. Default is enabled.• Virtualization Technology (enable or disable)—Controls the virtualization features of the processor. Changing this setting requires turning the computer off and then back on. Default is disabled. For optimum security and performance, HP recommends that this setting remains disabled.• TPM Device—Lets you set the Trusted Platform Module (TPM) as available or hidden.• TPM State—Select to enable the TPM.• Clear TPM—Select to reset the TPM to an unowned state. After the TPM is cleared, it is also turned off. To temporarily suspend TPM operations, turn the TPM off instead of clearing it. <p>IMPORTANT: Clearing the TPM resets it to factory defaults and turns it off. You will lose all created keys and data protected by those keys.</p> <p>NOTE: Hiding, disabling, or clearing the TPM might cause the thin client to become inoperable. If disk encryption is used on ThinPro, the internal storage device becomes unreadable, and you might have to reload the operating system.</p>
Secure Boot Configuration	<p>The options on this setup page are only for Windows 10 and ThinPro 8.0 and above, and other operating systems that support Secure Boot. Changing the default setting of the setup options on this page for operating system that do not support Secure Boot can prevent the system from starting successfully.</p> <p>Secure Boot (enable or disable)—You can enable this item only when the Legacy Support is disabled. This item is for Secure Boot flow control. Secure Boot is possible only if the system runs in user mode.</p> <p>Key Management</p> <ul style="list-style-type: none">• Clear Secure Boot Keys (Clear or Don't Clear)—Lets you clear the Secure Boot Key.• Key ownership (HP keys or Customer keys)—Lets you change the keys of different owners. <p>Fast Boot (Enable or Disable)—Enabling Fast Boot causes the system to boot by initializing a minimal set of devices, which is required to launch the Active Boot option. This option has no effect for BIOS Boot Specification (BBS) boot options.</p>

Computer Setup–Power

This table provides information about the Computer Setup Power menu.



NOTE: Support for specific Computer Setup options can vary, depending on the hardware configuration.

Table 2-4 Computer Setup–Power

Option	Description
OS Power Management	<p>Runtime Power Management (enable or disable)—Allows certain operating systems to reduce processor voltage and frequency when the current software load does not require the full capabilities of the processor. Default is enabled.</p> <p>Idle Power Savings (Extended or Normal)—Allows certain operating systems to decrease the processor's power consumption when the processor is idle. Default is extended.</p>

Table 2-4 Computer Setup–Power (continued)

Option	Description
Hardware Power Management	S5 Maximum Power Savings–Turns off power to all nonessential hardware when the system is off to meet the EUP Lot 6 requirement of less than 0.5 Watt power usage. Default is disabled.

Computer Setup–Advanced

This table provides information about the Computer Setup Advanced menu.

 **NOTE:** Support for specific Computer Setup options can vary, depending on the hardware configuration.

Table 2-5 Computer Setup–Advanced

Option	Heading
Power-On Options	<p>Allows you to set:</p> <ul style="list-style-type: none">• POST messages (enable or disable). Default is disabled.• Press the esc key for Startup Menu (Displayed or Hidden).• After Power Loss (off, on, or previous state). Default is Power off. Set this option as follows:<ul style="list-style-type: none">– Power off causes the computer to remain off when power is restored.– Power on causes the computer to turn on automatically as soon as power is restored.– Previous state causes the computer to turn on automatically as soon as power is restored, if it was on when power was lost. <p>NOTE: If you turn off power to the computer using the switch on a power strip, you cannot use the suspend/sleep feature or the Remote Management features.</p> <ul style="list-style-type: none">• POST Delay (in seconds)–Enabling this feature adds a user-specified delay to the POST process.• Bypass f1 Prompt on Configuration Changes (enable or disable).• Remote Wakeup Boot Source (Local Hard Drive or Remote Server). Allows you to set the source the computer gets its boot files from when it is remotely awakened.
BIOS Power-On	Allows you to set the computer to turn on automatically at a time you specify.
Onboard Devices	Allows you to set resources for or disable legacy devices.
Bus Options	<p>On some models, you can enable or disable the following settings. HP recommends that you do not change these settings.</p> <ul style="list-style-type: none">• PCI SERR# Generation. Default is enabled.• PCI VGA Palette Snooping: Default is disabled. This sets the VGA palette snooping bit in PCI configuration space. It is needed only when more than one graphics controller is installed. HP recommends that this option remains disabled.

Table 2-5 Computer Setup—Advanced (continued)

Option	Heading
Device Options	<ul style="list-style-type: none"> Integrated Graphics (Auto or Force)—HP recommends that you use the default setting, which is Auto. S5 Wake on LAN (enable or disable). Default is enabled. HP recommends leaving this option enabled so that remote management solutions can perform administrative functions. Prompt for Power-On Password on Wake-On LAN. Num Lock State at Power-On (off or on). Default is off. Internal Speaker (does not affect external speakers). Default is enabled. High-Resolution mode: When you connect to a USB Type-C[®] dock (for example, the HP USB-C Dock G5) on an Alt mode dock, you can enable the High-Resolution mode in the BIOS to allow the dock to support higher resolution monitors. <p>NOTE: For details about supported resolutions with and without High Resolution mode, go to http://www.hp.com/go/quickspecs/ and search for HP Dock QuickSpecs.</p>
Option ROM Launch Policy	Allows you to set the onboard NIC PXE Option ROMs (UEFI, Legacy PXE, or Do not launch). HP recommends using the default value of UEFI.

Changing BIOS Settings from the HP BIOS Configuration Utility (HPBCU)

You can change some BIOS settings locally within the operating system without having to go through the F10 utility. This table identifies the items that you can control with this method.

For more information about the HP BIOS Configuration Utility, see the *HP BIOS Configuration Utility (BCU) User Guide* at www.hp.com.

Table 2-6 Identifying the front panel components

BIOS setting	Default value	Other values
Language	English	Francais, Espanol, Deutsch, Italiano, Dansk, Suomi, Nederlands, Norsk, Portugues, Svenska, Japanese, Simplified Chinese
Set time	00:00	00:00:23:59
Set Day	01/01/2011	01/01/2011 to current date
Default Setup	None	Save Current Settings as Default; Restore Factory Settings as Default
Apply Defaults and Exit	Disable	Enable
USB Storage Boot	Before internal storage	After internal storage
Secure Erase	Disable	Enable
UEFI Boot Sources	Windows Boot Manager	USB Floppy/CD; USB hard drive
Legacy Boot Sources	USB floppy/CD	Hard drive
System Audio	Device available	Device hidden

Table 2-6 Identifying the front panel components (continued)

BIOS setting	Default value	Other values
Network Controller	Device available	Device hidden
M.2 Storage 0	Device available	Device hidden
Front USB Ports	Enable	Disable
USB Port 1, 2	Enable	Disable
Rear USB Ports	Enable	Disable
USB Port 3, 4, 5, 6	Enable	Disable
M.2 PCIe x	Enable	Disable
Network Boot	Enable	Disable
Asset Tracking Number		
Ownership Tag		
BIOS Update	Disable	Auto; Force
BIOS Image File Name		
Data Execution Prevention	Enable	Disable
Virtualization Technology	Disable	Enable
TPM Device	Disable	Enable
TPM State	Enable	Disable
Clear TPM	Do not reset	Reset
Legacy Support	Enable	Disable
		NOTE: The default value depends on the OS.
Secure Boot	Disable	Enable
		NOTE: The default value depends on the OS.
Clear Secure Boot Keys	Don't Clear	Clear
Key Ownership	HP Keys	Custom Keys
Fast Boot	Disable	Enable
		NOTE: The default value depends on the OS.
Runtime Power Management	Enable	Disable
Idle Power Savings	Extended	Normal
S5 Maximum Power Savings	Disable	Enable
S5 Wake on LAN	Disable	Enable
POST Messages	Disable	Enable

Table 2-6 Identifying the front panel components (continued)

BIOS setting	Default value	Other values
Press the ESC key for Startup Menu	Displayed	Hidden
After Power Loss	Off	On, Previous State
POST Delay (in seconds)	None	5, 10, 15, 20, 60
Bypass F1 Prompt on Configuration Changes	Disable	Enable
Remote Wakeup Boot Source	Local Hard Drive	Remote Server
Power on Sunday - Saturday	Disable	Enable
Power on Time (hh:mm)	00:00	00:00:23:59
Serial Port A	IO=3F8h; IRQ=4	Disable, IO=3F8h; IRQ=4, IO=3F8h; IRQ=3, IO=2F8h; IRQ=4, IO=2F8h; IRQ=3
PCI SERR# Generation	Enable	Disable
PCI VGA Palette Snooping	Disable	Enable
Integrated Graphics	Auto	Disable, Force
UMA Frame Buffer Size	512M	256M, 512M, 1G, 2G
Num Lock State at Power-On	Off	On
Internal Speaker	Enable	Disable
PXE Option ROMs	Enable	Disable

Updating or restoring a BIOS

Use this information to update and restore the BIOS.

HP Device Manager

Use HP Device Manager to update the BIOS of a thin client. Customers can use a prebuilt BIOS or the standard BIOS upgrade package with an HP Device Manager File and Registry template. For more information about HP Device Manager File and Registry templates, review the HP Device Manager User Guide found at www.hp.com/go/hpdm.

BitLocker Drive Encryption / BIOS Measurements

If you have Windows BitLocker Drive Encryption (BDE) enabled on your system, HP recommends that you temporarily suspend BDE before updating the BIOS. Be sure that you have your BDE recovery password or recovery PIN before you suspend BDE. After you flash the BIOS, you can resume BDE.

To make a change to BDE, select **Start**, select **Control Panel**, select **BitLocker Drive Encryption**, select **Suspend Protection** or **Resume Protection**, and then select **Yes**.

As a general rule, updating the BIOS modifies measurement values stored in the Platform Configuration Registers (PCRs) of the system's security module (TPM). Temporarily disable technologies that use these PCR values to determine platform health (BDE is one such example) before you update the BIOS. After you update the BIOS, re-enable the functions and restart the system so that you can take new measurements.

BootBlock Emergency Recovery Mode

In the event of a failed BIOS update (for example, if power is lost while updating), the System BIOS can become corrupted. BootBlock Emergency Recovery Mode detects this condition and automatically searches the root directory of the storage device and any USB media sources for a compatible binary image. Copy the binary (.bin) file in the DOS Flash folder to the root of the storage device, and then turn on the computer. After the recovery process locates the binary image, it attempts the recovery process. The automatic recovery continues until it successfully restores or updates the BIOS. If the system has a BIOS Setup password, you might have to use the Startup Menu or Utilities submenu to flash the BIOS manually after providing the password.

You might find that there are restrictions for the BIOS versions that are allowed to be installed on a platform. If the BIOS that was on the system had restrictions, then you can use only the allowable BIOS versions for recovery.

Updating the firmware for Power-on from Keyboard

You may need to update the firmware to enable the Power-on from Keyboard feature. To update the firmware:

1. Open the Computer Setup (F10) Utility. See [Using Computer Setup \(F10\) Utilities on page 27](#) for details.
2. In the Computer Setup (F10) Utility, select the **File** menu, and then select **Flash System BIOS**.
3. Select **Wake from Keyboard in S5 HOST FW**. The next dialog box shows the current firmware version on your computer and the latest firmware version available. The current firmware version is displayed on the first line, **Working Wake from Keyboard in S5 FW** version. The newest firmware version available is displayed on the second line, **Wake from Keyboard in S5 FW** version in BIOS ROM.
4. If a new firmware version for your computer is available, select **Update USB Keyboard Controller FW**.

Diagnostics and troubleshooting LEDs

To identify the troubleshooting LEDs, use this illustration and table.

Table 2-7 Identifying the diagnostics and troubleshooting LEDs

LED	Status
Power LED Off	When the computer is plugged into the wall socket and the Power LED is off, the computer is off. However, the network can trigger a Wake On LAN event to perform management functions.

Table 2-7 Identifying the diagnostics and troubleshooting LEDs (continued)

LED	Status
Power LED On	<p>On during boot sequence and while the unit is on. During boot sequence, hardware initialization is processed and startup tests are performed on the following:</p> <ul style="list-style-type: none">• Processor initialization• Memory detection and initialization• Video detection and initialization <p>NOTE: If one test fails, the computer stops, but the LED stays on. If the video test fails, the unit beeps. There are no messages sent to video for any of these failed tests.</p> <p>NOTE: After the video subsystem is initialized, anything that fails will have an error message.</p>
Activity LED is Off	<p>When the computer is on, but the Activity light is off, the system is not accessing the internal storage device.</p>
Activity LED is blinking	<p>Indicates the system is accessing the internal storage device.</p>

NOTE: Network LEDs are located inside the network connector on the rear panel of the thin client. The LEDs are active only when a live cable (connected to a hub, switch, or router) is installed. Blinking green indicates network activity, and amber indicates a 1000 Mbps speed connection.

Startup sequence

At startup, the flash boot block code initializes the hardware to a known state, and then performs basic power-on diagnostic tests to determine the integrity of the hardware.

Initialization performs the following functions:

1. Initializes CPU and memory controller.
2. Initializes and configures all PCI devices.
3. Initializes the video to a known state.
4. Initializes USB devices to a known state.
5. Performs power-on diagnostics.
6. The computer boots the operating system.

Resetting the setup and power-on passwords

You can reset the setup and power-on passwords in just a few steps.

1. Turn off the computer and disconnect the power cord from the power outlet.
2. Remove the rear I/O panel and the side cover. See [Removing the access panel on page 16](#).
3. Remove the password jumper from the system board header labeled PSWD. See [Locating internal components on page 19](#).
4. Replace the access panel and the rear I/O panel.
5. Connect the computer to AC power, and then turn on the computer.

6. Turn off the computer and disconnect the power cord from the power outlet.
7. Remove the access panel and the rear I/O panel.
8. Replace the password jumper.
9. Replace the access panel and the rear I/O panel.

Power-on diagnostic tests

The power-on diagnostics perform basic integrity tests of the hardware to determine its functionality and configuration. If a diagnostic test fails during hardware initialization, the computer stops. There are no messages sent to video.



NOTE: You can try to restart the computer and run through the diagnostic tests a second time to confirm the first shutdown.

The following table lists the tests that are performed on the computer.

Table 2-8 Startup diagnostic test

Test	Description
Boot Block Checksum	Tests boot block code for proper checksum value
DRAM	Tests the first 640 Kbytes of memory using a simple write/read pattern
Serial Port	Tests the serial port using simple port verification test to determine if ports are present
	NOTE: This test applies only if the optional serial port is installed.
Timer	Tests timer interrupt by using polling method
RTC CMOS battery	Tests integrity of RTC CMOS battery
NAND flash device	Tests for proper NAND flash device ID present

Interpreting POST diagnostic front panel lights and audible codes

This section identifies the front panel light codes as well as the audible codes that can occur before or during POST that might not have an error code or text message associated with them.



CAUTION: When the computer is plugged into an AC power source, voltage is always applied to the system board. To reduce the risk of personal injury from electrical shock or hot surfaces, be sure to disconnect the power cord from the AC outlet and allow the internal system components to cool before touching.



NOTE: Recommended actions in the following table are listed in the order in which they should be performed.

Not all diagnostic lights and audible codes are available on all models.

Table 2-9 Interpreting POST diagnostic front panel lights and audible codes

Activity	Beeps	Possible cause	Recommended action
Power light on (white).	None	Computer on.	None
Power light blinks every 2 seconds (white).	None	Computer in Suspend to RAM mode (some models only) or normal Suspend mode.	None required. Press any key or move the mouse to wake the computer.
Power light flashes red four times, and then the power light flashes white two times, once every second, followed by a 2-second pause. Beeps stop after fifth iteration but light continues until problem is solved.	4.2	Processor thermal protection activated. OR The heat sink assembly is not properly attached to the processor. OR The unit has vents blocked or is in a location where the ambient temperature is too high.	<ol style="list-style-type: none"> Be sure that the computer air vents are not blocked. Contact an authorized reseller or service provider.
Power light flashes red three times, and then the power light flashes white four times, once every second, followed by a 2-second pause. Beeps stop after fifth iteration but light continues until problem is solved.	3.4	Power failure (power supply is overloaded). OR The incorrect external power supply adapter is being used on the unit.	<ol style="list-style-type: none"> Check whether a device is causing the problem by removing all attached devices. Turn on the computer. If the computer enters the POST, then shut down and replace one device at a time. Repeat this procedure until failure occurs. Replace the device that is causing the failure. Continue adding devices one at a time to ensure all devices are functioning properly. Replace the power supply. Replace the system board.
Power light flashes red three times, and then the power light flashes white two times, once every second, followed by a 2-second pause. Beeps stop after fifth iteration but light continues until problem is solved.	3.2	Prevideo memory error.	<p>IMPORTANT: To avoid damage to the DIMM or the system board, you must unplug the computer power cord before attempting to reseat, install, or remove a DIMM module.</p> <ol style="list-style-type: none"> Reseat the memory module. Replace third-party memory with HP memory. Replace the system board.
Power light flashes red three times, and then the power light flashes white three times, once every second, followed by a 2-second pause. Beeps stop after fifth iteration, but light continues until problem is solved.	3.3	Prevideo graphics error.	Replace the system board.

Table 2-9 Interpreting POST diagnostic front panel lights and audible codes (continued)

Activity	Beeps	Possible cause	Recommended action
Power light flashes red two times, and then the power light flashes white three times, once every second, followed by a 2-second pause. Beeps stop after fifth iteration, but light continues until problem is solved.	2.2	Invalid ROM based on bad checksum.	<ol style="list-style-type: none"> 1. Reflash the system ROM with the latest BIOS image. 2. Replace the system board.
System does not turn on, and light is not blinking.	None	System cannot start.	<p>Press and hold the power button for less than 4 seconds. If the hard drive light turns white, the power button is working correctly.</p> <ol style="list-style-type: none"> 1. Remove the power cord from the computer. 2. Open the computer and press the yellow CMOS button on the system board for 4 seconds (located near the front USB ports). 3. Verify that the power cord is plugged into the power supply. 4. Close the unit and reattach the power cord. 5. Try to start the computer. 6. Replace the unit.

Basic troubleshooting

If the thin client is experiencing operating problems or will not turn on, review the following items.

Table 2-10 Basic troubleshooting

Issue	Procedures
The thin client is experiencing operating problems.	<p>Verify that the following connectors are securely plugged into the thin client unit:</p> <p>Power connector, keyboard, mouse, network jack, display</p>
The thin client does not turn on.	<ol style="list-style-type: none"> 1. Verify that the power supply is good by installing it on a known working unit and testing it. If the power supply does not work on the test unit, replace the power supply. 2. If the unit does not work properly with the replaced power supply, have the unit serviced.
The thin client turns on and displays a splash screen, but does not connect to the server.	<ol style="list-style-type: none"> 1. Verify that the network is operating and the network cable is working properly. 2. Verify that the unit is communicating with the server by having the system administrator ping the unit from the server: <ul style="list-style-type: none"> • If the thin client pings back, then the signal was accepted and the unit is working. This indicates a configuration issue. • If the thin client does not ping back and the thin client does not connect to the server, reimaging the unit.

Table 2-10 Basic troubleshooting (continued)

Issue	Procedures
No link or activity on the network LEDs or the LEDs do not illuminate blinking green after turning on the thin client. (The network LEDs are located inside the network connector on the top, rear panel of the thin client. Indicator lights are visible even when an Ethernet cable is connected.)	<ol style="list-style-type: none">1. Verify that the network is operating.2. Verify that the network cable is good by installing the cable on a known working device. If a network signal is detected, then the cable is good.3. Verify that the power supply is good by replacing the power cord to the computer with a known working power cord and testing it.4. If network LEDs still do not light and you know the power supply is good, then reimage the computer.5. If network LEDs still do not light, run the IP configuration procedure.6. If network LEDs still do not light, have the computer serviced.
A newly connected unknown USB peripheral does not respond, or USB peripherals connected before the newly connected USB peripheral do not complete their device actions.	You can connect and disconnect a USB peripheral to a running platform as long as you do not reboot the system. If problems occur, disconnect the USB peripheral and reboot the platform.
Video does not show.	<ol style="list-style-type: none">1. Verify that the monitor brightness is set to a readable level.2. Verify that the monitor is good by connecting it to a known working computer and checking whether its front LED turns green (if the monitor is Energy Star compliant). If the monitor is defective, replace it with a working monitor, and repeat testing.3. Reimage the thin client and turn on the monitor again.4. Test the thin client on a known working monitor. If the monitor does not display video, replace the thin client.
Video does not display after power loss when the monitor is connected the rear USB Type-C port.	<ol style="list-style-type: none">1. Turn off the thin client.2. Disconnect the power cord from the AC outlet and disconnect any external devices.3. Disconnect the USB Type-C cable from the back of the thin client.4. Reconnect the USB Type-C cable, connect the power cord, and turn on the thin client.5. If video does not display, reimage the thin client.

Configuring a PXE server

All PXE software is supported by authorized service providers on a warranty or service contract basis.

Before you configure a PXE server, the following services must be running, and they can be running on different servers:

1. Domain Name Service (DNS)
2. Remote Installation Services (RIS)



NOTE: HP recommends Active Directory DHCP, but it is not required.

Using HP ThinUpdate to restore the image

HP ThinUpdate allows you to download images and add-ons from HP, capture an HP thin client image, and create bootable USB flash drives for image deployment.

HP ThinUpdate is preinstalled on some HP thin clients, and it is also available as an add-on at <http://www.hp.com/support>.

- The Image Downloads feature lets you download an image from HP to either local storage or a USB flash drive. The USB flash drive option creates a bootable USB flash drive that you can use to deploy the image to other thin clients.
- The Image Capture feature lets you capture an image from an HP thin client and save it to a USB flash drive that you can use to deploy the image to other thin clients.
- The Add-on Downloads feature lets you download add-ons from HP to either local storage or a USB flash drive.
- The USB Drive Management feature lets you do the following tasks:
 - Create a bootable USB flash drive from an image file on local storage
 - Copy an .ibr image file from a USB flash drive to local storage
 - Restore a USB flash drive layout

You can use a bootable USB flash drive created with HP ThinUpdate to deploy an HP thin client image to another HP thin client of the same model with the same operating system.

System requirements

To create a recovery device for the purpose of reflashing or restoring the software image on the flash, you need:

- One or more HP thin clients.
- USB flash device in the following size or larger:
 - ThinPro: 8 GB
 - Windows 10 IoT (if using the USB format): 32 GB

 **NOTE:** Optionally, you can use the tool on a non-thin-client Windows computer connected to the internet.

This restore method will not work with all USB flash devices. USB flash devices that do not show up as removable drives in Windows do not support this restore method. USB flash devices with multiple partitions generally do not support this restore method. The range of USB flash devices available on the market is constantly changing. Not all USB flash devices have been tested with the HP ThinUpdate.

Device management

The thin client includes a license for HP Device Manager and has a Device Manager agent preinstalled.

HP Device Manager is a thin-client-optimized management tool used to manage the full life cycle of HP thin clients to include Discovery, Asset Management, Deployment, and Configuration. For more information about HP Device Manager, go to <http://www.hp.com/go/hpdm>.

If you want to manage the thin client with other management tools, go to www.hp.com/us-en/solutions/cloud-computing/thin-client-software.html for more information.

Statement of Volatility

Thin Client products typically have three types of memory devices: RAM, ROM, and flash memory devices.

Data stored in the RAM memory device is lost after the power is removed from the device. RAM devices are powered only when the system is connected to main power (AC outlet) and in a power-on state.

Data stored in the ROM or flash memory devices retains its data even if the power is removed to the device. Manufacturers of flash devices usually specify a period of time (approximately 10 years) for data retention.

Definition of power states:

- **Main power**—Power available when the computer is turned on.
- **Aux or Standby power**—Power available when the unit is in the off state and the power supply is connected to an active AC outlet.
- **Battery power**—Power from a coin battery present in Thin Client systems. Battery power maintains the Real Time Clock (RTC).

 **NOTE:** Thin Client systems do not use rotating hard drives with moving parts. Instead, a solid-state drive (SSD) contains the image of the operating system. Only an administrator can write to the flash device. A special software tool is required to format the flash devices and clear the data stored in them.

Although the SSD retains its data when power is removed from the system, desktop Thin Clients are supplied with a Secure Erase feature that permits the SSD to be erased, permanently preventing data access.

The table below lists the available memory devices and their types per the models.

Table 2-11 Available memory devices

Memory devices	Types
RTC (CMOS)	RAM RTC - Battery retains function when power is removed.
RAM memory	Dynamic RAM - Data is retained only when operating with main power.
SSD	Solid state drive - Data is retained regardless of supplied power.

3 Using HP PC Hardware Diagnostics

You can use the HP PC Hardware Diagnostics utility to determine whether your computer hardware is running properly. The three versions are HP PC Hardware Diagnostics Windows, HP PC Hardware Diagnostics UEFI (Unified Extensible Firmware Interface), and (for select products only) Remote HP PC Hardware Diagnostics UEFI, a firmware feature.

Customizing Remote HP PC Hardware Diagnostics UEFI settings

Using the Remote HP PC Hardware Diagnostics setting in Computer Setup (BIOS), you can perform several customizations.

- Set a schedule for running diagnostics unattended. You can also start diagnostics immediately in interactive mode by selecting **Execute Remote HP PC Hardware Diagnostics**.
- Set the location for downloading the diagnostic tools. This feature provides access to the tools from the HP website or from a server that has been preconfigured for use. Your computer does not require the traditional local storage (such as a hard drive or USB flash drive) to run remote diagnostics.
- Set a location for storing the test results. You can also set the user name and password that you use for uploads.
- Display status information about the diagnostics run previously.

To customize Remote HP PC Hardware Diagnostics UEFI settings, follow these steps:

1. Turn on or restart the computer, and when the HP logo appears, press **f10** to enter Computer Setup.
2. Select **Advanced**, and then select **Settings**.
3. Make your customization selections.
4. Select **Main**, and then **Save Changes and Exit** to save your settings.

Your changes take effect when the computer restarts.

4 Power cord set requirements

The power supplies on some computers have external power switches.

The power cord set received with the computer meets the requirements for use in the country where you purchased the equipment.

Power cord sets for use in other countries must meet the requirements of the country where you use the computer.

General requirements

These requirements are applicable to all countries.

1. The power cord must be approved by an acceptable accredited agency responsible for evaluation in the country where the power cord set will be installed.
2. The power cord set must have a minimum current capacity of 10A (7A Japan only) and a nominal voltage rating of 125 V AC or 250 V AC, as required by each country's power system.
3. The diameter of the wire must be a minimum of 0.75 mm² or 18AWG, and the length of the cord must be between 1.8 m (6 ft) and 3.6 m (12 ft).

The power cord should be routed so that it is not likely to be walked on or pinched by items placed upon it or against it. Particular attention should be paid to the plug, electrical outlet, and the point where the cord exits from the product.

 **WARNING!** Do not operate this product with a damaged power cord set. If the power cord set is damaged in any manner, replace it immediately.

Japanese power cord requirements

For use in Japan, use only the power cord received with this product.

 **IMPORTANT:** Do not use the power cord received with this product on any other products.

Country-specific requirements

This information provides additional requirements specific to a country.

Table 4-1 Power cord country-specific requirements

Country	Accrediting Agency	Country	Accrediting Agency
Australia (1)	EANSW	Italy (1)	IMQ
Austria (1)	OVE	Japan (3)	METI
Belgium (1)	CEBC	Norway (1)	NEMKO
Canada (2)	CSA	Sweden (1)	SEMKO

Table 4-1 Power cord country-specific requirements (continued)

Country	Accrediting Agency	Country	Accrediting Agency
Denmark (1)	DEMKO	Switzerland (1)	SEV
Finland (1)	SETI	United Kingdom (1)	BSI
France (1)	UTE	United States (2)	UL
Germany (1)	VDE		

1. The flexible cord must be Type HO5VV-F, 3-conductor, 0.75mm² conductor size. Power cord set fittings (appliance coupler and plug) must bear the certification mark of the agency responsible for evaluation in the country where it will be used.
2. The flexible cord must be Type SVT or equivalent, No. 18 AWG, 3 conductor. The plug must be a 2-pole grounding type with a NEMA 5-15P (15 A, 125 V) or NEMA 6-15P (15 A, 250 V) configuration.
3. Appliance coupler, flexible cord, and plug must bear a T mark and registration number in accordance with the Japanese Dentori Law. Flexible cord must be Type VCT or VCTF, 3-conductor, 0.75 mm² conductor size. Plug must be a 2-pole grounding type with a Japanese Industrial Standard C8303 (7 A, 125 V) configuration.

5 Computer operating guidelines, routine care, and shipping preparation

Follow these guidelines to ensure the best performance and useful life of your computer.

Operating guidelines and routine care

HP has developed guidelines to help you properly set up and care for the computer and monitor.

- Keep the computer away from excessive moisture, direct sunlight, and extreme heat and cold.
- Operate the computer on a sturdy, level surface. Leave a 10.2 cm (4 inch) clearance on all vented sides of the computer and above the monitor to permit the required airflow.
- Never restrict the airflow into the computer by blocking any vents or air intakes. Do not place the keyboard, with the keyboard feet down, directly against the front of the desktop unit because this also restricts airflow.
- Never operate the computer with the access panel or any of the expansion card slot covers removed.
- Do not stack computers on top of each other or place computers so near each other that they are subject to each other's recirculated or preheated air.
- To operate a computer within a separate enclosure, intake and exhaust ventilation must be provided on the enclosure, and the previous operating guidelines still apply.
- Keep liquids away from the computer and keyboard.
- Never cover the ventilation slots on the monitor with any type of material.
- Install or enable power management functions of the operating system or other software, including sleep states.
- Turn off the computer before you do either of the following tasks:
 - Wipe the exterior of the computer with a soft, damp cloth as needed. Cleaning products might discolor or damage the finish. See [Removing dirt and debris from your computer on page 49](#) for the recommended steps to clean the high-touch, external surfaces on your computer. After you remove the dirt and debris, you can also clean the surfaces with a disinfectant. See [Cleaning your computer with a disinfectant on page 49](#) for guidelines to help prevent the spread of harmful bacteria and viruses.
 - Occasionally clean the air vents on all vented sides of the computer. Lint, dust, and other foreign matter can block the vents and limit the airflow.

Cleaning your computer

Cleaning your computer regularly removes dirt and debris so that your device continues to operate at its best. Use the following information to safely clean the external surfaces of your computer.

Removing dirt and debris from your computer

Here are the recommended steps to clean dirt and debris from your computer.

1. Wear disposable gloves made of latex (or nitrile gloves, if you are latex-sensitive) when cleaning the surfaces.
2. Turn off your device and unplug the power cord and other connected external devices. Remove any installed batteries from items such as wireless keyboards.

 **CAUTION:** To prevent electric shock or damage to components, never clean a product while it is turned on or plugged in.

3. Moisten a microfiber cloth with water. The cloth should be moist, but not dripping wet.

 **IMPORTANT:** To avoid damaging the surface, avoid abrasive cloths, towels, and paper towels.

4. Wipe the exterior of the product gently with the moistened cloth.

 **IMPORTANT:** Keep liquids away from the product. Avoid getting moisture in any openings. If liquid makes its way inside your HP product, it can cause damage to the product. Do not spray liquids directly on the product. Do not use aerosol sprays, solvents, abrasives, or cleaners containing hydrogen peroxide or bleach that might damage the finish.

5. Start with the display (if applicable). Wipe carefully in one direction, and move from the top of the display to the bottom. Finish with any flexible cables, like power cord, keyboard cable, and USB cables.
6. Be sure that surfaces have completely air-dried before turning the device on after cleaning.
7. Discard the gloves after each cleaning. Clean your hands immediately after you remove the gloves.

See [Cleaning your computer with a disinfectant on page 49](#) for recommended steps to clean the high-touch, external surfaces on your computer to help prevent the spread of harmful bacteria and viruses.

Cleaning your computer with a disinfectant

The World Health Organization (WHO) recommends cleaning surfaces, followed by disinfection, as a best practice for preventing the spread of viral respiratory illnesses and harmful bacteria.

After cleaning the external surfaces of your computer using the steps in [Removing dirt and debris from your computer on page 49](#), you might also choose to clean the surfaces with a disinfectant. A disinfectant that is within HP's cleaning guidelines is an alcohol solution consisting of 70% isopropyl alcohol and 30% water. This solution is also known as rubbing alcohol and is sold in most stores.

Follow these steps when disinfecting high-touch, external surfaces on your computer:

1. Wear disposable gloves made of latex (or nitrile gloves, if you are latex-sensitive) when cleaning the surfaces.
2. Turn off your device and unplug the power cord and other connected external devices. Remove any installed batteries from items such as wireless keyboards.

 **CAUTION:** To prevent electric shock or damage to components, never clean a product while it is turned on or plugged in.

3. Moisten a microfiber cloth with a mixture of 70% isopropyl alcohol and 30% water. The cloth should be moist, but not dripping wet.

 **CAUTION:** Do not use any of the following chemicals or any solutions that contain them, including spray-based surface cleaners: bleach, peroxides (including hydrogen peroxide), acetone, ammonia, ethyl alcohol, methylene chloride, or any petroleum-based materials, such as gasoline, paint thinner, benzene, or toluene.

 **IMPORTANT:** To avoid damaging the surface, avoid abrasive cloths, towels, and paper towels.
4. Wipe the exterior of the product gently with the moistened cloth.

 **IMPORTANT:** Keep liquids away from the product. Avoid getting moisture in any openings. If liquid makes its way inside your HP product, it can cause damage to the product. Do not spray liquids directly on the product. Do not use aerosol sprays, solvents, abrasives, or cleaners containing hydrogen peroxide or bleach that might damage the finish.
5. Start with the display (if applicable). Wipe carefully in one direction, and move from the top of the display to the bottom. Finish with any flexible cables, like power cord, keyboard cable, and USB cables.
6. Be sure that surfaces have completely air-dried before turning the device on after cleaning.
7. Discard the gloves after each cleaning. Clean your hands immediately after you remove the gloves.

Shipping preparation

If you have to ship your computer, follow these tips to keep your equipment safe.

1. Back up the hard drive files to an external storage device. Be sure that the backup media is not exposed to electrical or magnetic impulses while stored or in transit.

 **NOTE:** The hard drive locks automatically when the system power is turned off.
2. Remove and store all removable media.
3. Turn off the computer and external devices.
4. Disconnect the power cord from the AC outlet, and then from the computer.
5. Disconnect the system components and external devices from their power sources and then from the computer.

 **NOTE:** Be sure that all boards are seated properly and secured in the board slots before shipping the computer.
6. Pack the system components and external devices in their original packing boxes or similar packaging with sufficient packing material to protect them.

6 Specifications

This section provides specifications for your thin client.

For the latest specifications or additional specifications on the thin client, go to <http://www.hp.com/go/quickspecs/> and search for your specific thin client to find the QuickSpecs.

Table 6-1 Specifications

	Metric	U.S.
Dimensions (without stand)		
Height	35 mm	1.38 in
Width	200 mm	7.87 in
Depth	200 mm	7.87 in
Dimensions (with stand)		
Height	152 mm	5.98 in
Width	200 mm	7.87 in
Depth	208 mm	8.18 in
Weight (without stand)		
	969 g	2.13 lb
Weight (with stand)		
	1019 g	2.24
Temperature range		
Operating	10°C to 40°C	50°F to 104°F
Nonoperating	-30°C to 60°C	-22°F to 140°F
NOTE: Operating temperature is derated 1.0°C per 300 m (1000 ft) to 3000 m (10,000 ft) above sea level; no direct sustained sunlight. Maximum rate of change is 10° C/hr. The upper limit might be limited by the type and number of options installed.		
Maximum altitude (unpressurized)		
Operating	3,048 m	10,000 ft
Nonoperating	9,144 m	30,000 ft
Relative humidity (noncondensing)		
Operating	10% to 90%	
Nonoperating (38.7°C max wet bulb)	5% to 95%	
Power supply		
Operating voltage range	90 V ac to 264 V ac	
Rated voltage range	100 V ac to 240 V ac	
Rated line frequency	50 Hz to 60 Hz	
Operating line frequency	47 Hz to 63 Hz	
Standard efficiency		
	45 W, 87% efficient	

7 Electrostatic discharge

Electrostatic discharge is the release of static electricity when two objects come into contact—for example, the shock you receive when you walk across the carpet and touch a metal door knob.

A discharge of static electricity from fingers or other electrostatic conductors may damage electronic components.

 **IMPORTANT:** To prevent damage to the computer, damage to a drive, or loss of information, observe these precautions:

- If removal or installation instructions direct you to unplug the computer, first be sure that it is properly grounded.
 - Keep components in their electrostatic-safe containers until you are ready to install them.
 - Avoid touching pins, leads, and circuitry. Handle electronic components as little as possible.
 - Use nonmagnetic tools.
 - Before handling components, discharge static electricity by touching an unpainted metal surface.
 - If you remove a component, place it in an electrostatic-safe container.
-

8 Accessibility

HP's goal is to design, produce, and market products, services, and information that everyone everywhere can use, either on a standalone basis or with appropriate third-party assistive technology (AT) devices or applications.

HP and accessibility

Because HP works to weave diversity, inclusion, and work/life into the fabric of the company, it is reflected in everything HP does. HP strives to create an inclusive environment focused on connecting people to the power of technology throughout the world.

Finding the technology tools you need

Technology can unleash your human potential. Assistive technology removes barriers and helps you create independence at home, at work, and in the community. Assistive technology helps increase, maintain, and improve the functional capabilities of electronic and information technology.

For more information, see [Finding the best assistive technology on page 54](#).

The HP commitment

HP is committed to providing products and services that are accessible for people with disabilities. This commitment supports the company's diversity objectives and helps ensure that the benefits of technology are available to all.

The HP accessibility goal is to design, produce, and market products and services that can be effectively used by everyone, including people with disabilities, either on a standalone basis or with appropriate assistive devices.

To achieve that goal, this Accessibility Policy establishes seven key objectives to guide HP actions. All HP managers and employees are expected to support these objectives and their implementation in accordance with their roles and responsibilities:

- Raise the level of awareness of accessibility issues within HP, and provide employees with the training they need to design, produce, market, and deliver accessible products and services.
- Develop accessibility guidelines for products and services, and hold product development groups accountable for implementing these guidelines where competitively, technically, and economically feasible.
- Involve people with disabilities in the development of accessibility guidelines and in the design and testing of products and services.
- Document accessibility features, and make information about HP products and services publicly available in an accessible form.
- Establish relationships with leading assistive technology and solution providers.
- Support internal and external research and development that improves assistive technology relevant to HP products and services.

- Support and contribute to industry standards and guidelines for accessibility.

International Association of Accessibility Professionals (IAAP)

IAAP is a not-for-profit association focused on advancing the accessibility profession through networking, education, and certification. The objective is to help accessibility professionals develop and advance their careers and to better enable organizations to integrate accessibility into their products and infrastructure.

As a founding member, HP joined to participate with other organizations to advance the field of accessibility. This commitment supports HP's accessibility goal of designing, producing, and marketing products and services that people with disabilities can effectively use.

IAAP will make the profession strong by globally connecting individuals, students, and organizations to learn from one another. If you are interested in learning more, go to <http://www.accessibilityassociation.org> to join the online community, sign up for newsletters, and learn about membership options.

Finding the best assistive technology

Everyone, including people with disabilities or age-related limitations, should be able to communicate, express themselves, and connect with the world using technology. HP is committed to increasing accessibility awareness within HP and with our customers and partners.

Whether it's large fonts that are easy on the eyes, voice recognition that lets you give your hands a rest, or any other assistive technology to help with your specific situation—a variety of assistive technologies make HP products easier to use. How do you choose?

Assessing your needs

Technology can unleash your potential. Assistive technology removes barriers and helps you create independence at home, at work, and in the community. Assistive technology (AT) helps increase, maintain, and improve the functional capabilities of electronic and information technology.

You can choose from many AT products. Your AT assessment should allow you to evaluate several products, answer your questions, and facilitate your selection of the best solution for your situation. You will find that professionals qualified to do AT assessments come from many fields, including those licensed or certified in physical therapy, occupational therapy, speech/language pathology, and other areas of expertise. Others, while not certified or licensed, can also provide evaluation information. You will want to ask about the individual's experience, expertise, and fees to determine if they are appropriate for your needs.

Accessibility for HP products

These links provide information about accessibility features and assistive technology, if applicable and available in your country or region, that are included in various HP products. These resources will help you select the specific assistive technology features and products most appropriate for your situation.

- HP Aging & Accessibility: Go to <http://www.hp.com>, type **Accessibility** in the search box. Select **Office of Aging and Accessibility**.
- HP computers: For Windows 7, Windows 8, and Windows 10, go to <http://www.hp.com/support>, type **Windows Accessibility Options** in the **Search our knowledge** search box. Select the appropriate operating system in the results.
- HP Shopping, peripherals for HP products: Go to <http://store.hp.com>, select **Shop**, and then select **Monitors** or **Accessories**.

If you need additional support with the accessibility features on your HP product, see [Contacting support on page 57](#).

Additional links to external partners and suppliers that may provide additional assistance:

- [Microsoft Accessibility information \(Windows 7, Windows 8, Windows 10, Microsoft Office\)](#)
- [Google Products accessibility information \(Android, Chrome, Google Apps\)](#)

Standards and legislation

Countries worldwide are enacting regulations to improve access to products and services for persons with disabilities. These regulations are historically applicable to telecommunications products and services, PCs and printers with certain communications and video playback features, their associated user documentation, and their customer support.

Standards

The US Access Board created Section 508 of the Federal Acquisition Regulation (FAR) standards to address access to information and communication technology (ICT) for people with physical, sensory, or cognitive disabilities.

The standards contain technical criteria specific to various types of technologies, as well as performance-based requirements which focus on functional capabilities of covered products. Specific criteria cover software applications and operating systems, web-based information and applications, computers, telecommunications products, video and multimedia, and self-contained closed products.

Mandate 376 – EN 301 549

The European Union created the EN 301 549 standard within Mandate 376 as an online toolkit for public procurement of ICT products. The standard specifies the accessibility requirements applicable to ICT products and services, with a description of the test procedures and evaluation methodology for each requirement.

Web Content Accessibility Guidelines (WCAG)

Web Content Accessibility Guidelines (WCAG) from the W3C's Web Accessibility Initiative (WAI) helps web designers and developers create sites that better meet the needs of people with disabilities or age-related limitations.

WCAG advances accessibility across the full range of web content (text, images, audio, and video) and web applications. WCAG can be precisely tested, is easy to understand and use, and allows web developers flexibility for innovation. WCAG 2.0 has also been approved as [ISO/IEC 40500:2012](#).

WCAG specifically addresses barriers to accessing the web experienced by people with visual, auditory, physical, cognitive, and neurological disabilities, and by older web users with accessibility needs. WCAG 2.0 provides characteristics of accessible content:

- **Perceivable** (for instance, by addressing text alternatives for images, captions for audio, adaptability of presentation, and color contrast)
- **Operable** (by addressing keyboard access, color contrast, timing of input, seizure avoidance, and navigability)
- **Understandable** (by addressing readability, predictability, and input assistance)
- **Robust** (for instance, by addressing compatibility with assistive technologies)

Legislation and regulations

Accessibility of IT and information has become an area of increasing legislative importance.

The [HP policy landscape](#) website provides information about key legislation, regulations, and standards in the following locations:

- United States
- Canada
- Europe
- Australia

Useful accessibility resources and links

These organizations, institutions, and resources might be good sources of information about disabilities and age-related limitations.



NOTE: This is not an exhaustive list. These organizations are provided for informational purposes only. HP assumes no responsibility for information or contacts you encounter on the internet. Listing on this page does not imply endorsement by HP.

Organizations

These organizations are a few of the many that provide information about disabilities and age-related limitations.

- American Association of People with Disabilities (AAPD)
- The Association of Assistive Technology Act Programs (ATAP)
- Hearing Loss Association of America (HLAA)
- Information Technology Technical Assistance and Training Center (ITTATC)
- Lighthouse International
- National Association of the Deaf
- National Federation of the Blind
- Rehabilitation Engineering & Assistive Technology Society of North America (RESNA)
- Telecommunications for the Deaf and Hard of Hearing, Inc. (TDI)
- W3C Web Accessibility Initiative (WAI)

Educational institutions

Many educational institutions, including these examples, provide information about disabilities and age-related limitations.

- California State University, Northridge, Center on Disabilities (CSUN)
- University of Wisconsin - Madison, Trace Center

- University of Minnesota computer accommodations program

Other disability resources

Many resources, including these examples, provide information about disabilities and age-related limitations.

- ADA (Americans with Disabilities Act) Technical Assistance Program
- ILO Global Business and Disability network
- EnableMart
- European Disability Forum
- Job Accommodation Network
- Microsoft Enable

HP links

These HP-specific links provide information that relates to disabilities and age-related limitations.

[HP comfort and safety guide](#)

[HP public sector sales](#)

Contacting support

HP offers technical support and assistance with accessibility options for customers with disabilities.



NOTE: Support is in English only.

- Customers who are deaf or hard of hearing who have questions about technical support or accessibility of HP products:
 - Use TRS/VRS/WebCapTel to call (877) 656-7058 Monday through Friday, 6 a.m. to 9 p.m. Mountain Time.
- Customers with other disabilities or age-related limitations who have questions about technical support or accessibility of HP products:
 - Call (888) 259-5707 Monday through Friday, 6 a.m. to 9 p.m. Mountain Time.

Index

- A**
 - accessibility 53, 54, 56, 57
 - accessibility needs
 - assessment 54
 - Advanced menu, Computer Setup 33
 - assistive technology (AT)
 - finding 54
 - purpose 53
 - AT (assistive technology)
 - finding 54
 - purpose 53
 - audible codes 39
- B**
 - beep codes 39
 - blinking lights 39
- C**
 - caring for your computer 48
 - changing BIOS Settings 34
 - cleaning your computer 48
 - disinfecting 49
 - removing dirt and debris 49
 - components 1, 2
 - computer operating guidelines 48
 - Computer Setup
 - Advanced menu 33
 - File menu 28
 - Power menu 32
 - Security menu 30
 - Storage menu 29
 - Computer Setup Utility 27
 - configuring a PXE server 42
 - country power cord set requirements 46
 - customer support, accessibility 57
- E**
 - electrostatic discharge 52
 - error
 - codes 39
- F**
 - F10 Setup 27
 - File menu, Computer Setup 28
- H**
 - hardware changes 16
 - HP Assistive Policy 53
 - HP Quick Release 4
- I**
 - installing a memory module 25
 - installing an eMMC storage module 22
 - installing the stand 13
 - International Association of Accessibility Professionals 54
- L**
 - lights
 - blinking PS/2 keyboard 39
- M**
 - mounting the thin client 4
- O**
 - orienting the thin client 4
- P**
 - power
 - connecting 16
 - power cord set requirements
 - country specific 46
 - Power menu, Computer Setup 32
 - power supply
 - operating voltage range 51
 - power-on diagnostic tests 39
 - Power-on from Keyboard 37
 - product ID location 2
- R**
 - Remote HP PC Hardware
 - Diagnostics UEFI settings
 - customizing 45
 - removing the access panel 16
 - replacing the access panel 18
 - replacing the battery 23
 - replacing the M.2 storage module 20
 - resetting setup and power-on passwords 38
 - resources, accessibility 56
- S**
 - Section 508 accessibility standards 55
 - securing the thin client 15
 - Security menu, Computer Setup 30
 - serial number location 2
 - setup 3
 - setup, order of 43
 - shipping preparation 50
 - specifications
 - computer 51
 - standards and legislation, accessibility 55
 - startup sequence 38
 - Statement of Volatility 44
 - Storage menu, Computer Setup 29
- T**
 - troubleshooting 41
 - troubleshooting LEDs 37
- U**
 - upgrading system memory 24
 - using Computer Setup Utilities 27
- V**
 - ventilation guidelines 48