

Acer LCD Monitor

User's Guide

Copyright © 2023. Acer Incorporated.
All Rights Reserved.

Acer LCD Monitor User's Guide
Original Issue: 01/2023

Changes may be made periodically to the information in this publication without obligation to notify any person of such revisions or changes. Such changes will be incorporated in new editions of this manual or supplementary documents and publications. This company makes no representations or warranties, either expressed or implied, with respect to the contents hereof and specifically disclaims the implied warranties of merchantability or fitness for a particular purpose.

Record the model number, serial number, purchase date and place of purchase information in the space provided below. The serial number and model number are recorded on the label affixed to your computer. All correspondence concerning your unit should include the serial number, model number and purchase information.

No part of this publication may be reproduced, stored in a retrieval system, or transmitted, in any form or by any means, electronically, mechanically, by photocopy, recording or otherwise, without the prior written permission of Acer Incorporated.

Acer LCD Monitor User's Guide

Model number: _____

Serial number: _____

Date of purchase: _____

Place of purchase: _____

Acer and the Acer logo are registered trademarks of Acer Incorporated. Other companies' product names or trademarks are used herein for identification purposes only and belong to their respective companies.

Special notes on LCD monitors

The following are normal with the LCD monitor and do not indicate a problem.

- Due to the nature of the fluorescent light, the screen may flicker during initial use. Turn off the power switch and then turn it on again to make sure the flicker disappears.
- You may find slightly uneven brightness on the screen depending on the desktop pattern you use.
- The LCD screen has 99.99% or more effective pixels. It may include blemishes of 0.01% or less such as a missing pixel or a pixel lit all the time.
- Due to the nature of the LCD screen, an afterimage of the previous screen may remain after switching the image, when the same image is displayed for hours. In this case, the screen is recovered slowly by changing the image or turning off the power switch for a few hours.

Information for your safety and comfort

Safety instructions

Read these instructions carefully. Keep this document for future reference.

Follow all warnings and instructions marked on the product.

Cleaning your monitor

Please carefully follow these guidelines when cleaning the monitor:

- Always unplug the monitor before cleaning.
- Use a soft cloth to wipe the screen and cabinet front and sides.

Connecting/disconnecting the device

Observe the following guidelines when connecting and disconnecting power from the LCD monitor:

- Make sure the monitor is attached to its base before connecting the power cord to the AC power outlet.
- Make sure both the LCD monitor and the computer are turned off before connecting any cable or unplugging the power cord.
- If the system has multiple sources of power, disconnect power from the system by unplugging all power cords from the power supplies.

Accessibility

Be sure that the power outlet you plug the power cord into is easily accessible and located as close to the equipment operator as possible. When you need to disconnect power from the equipment, be sure to unplug the power cord from the electrical outlet.

Safe listening

To protect your hearing, follow these instructions.

- Gradually increase the volume until you can hear it clearly and comfortably and without distortion.
- After setting the volume level, do not increase it after your ears have adjusted.
- Limit the amount of time listening to music at high volume.
- Avoid turning up the volume to block out noisy surroundings.
- Turn the volume down if you can't hear people speaking near you.

Warnings

- Do not use this product near water.
- Do not place this product on an unstable cart, stand or table. If the product falls, it could be seriously damaged.
- Slots and openings are provided for ventilation to ensure reliable operation of the product and to protect it from overheating. These openings must not be blocked or covered. The openings should never be blocked by placing the product on a bed, sofa, rug or other similar surface. This product should never be placed near or over a radiator or heat register, or in a built-in installation unless proper ventilation is provided.
- Never push objects of any kind into this product through cabinet slots as they may touch dangerous voltage points or short-out parts that could result in a fire or electric shock. Never spill liquid of any kind onto or into the product.
- To avoid damage of internal components and to prevent battery leakage, do not place the product on a vibrating surface.
- Never use it under sporting, exercising, or any vibrating environment which will probably cause unexpected short current or damage internal devices.

Using electrical power

- This product should be operated from the type of power indicated on the marking label. If you are not sure of the type of power available, consult your dealer or local power company.
- Do not allow anything to rest on the power cord. Do not locate this product where people will walk on the cord.
- If an extension cord is used with this product, make sure that the total ampere rating of the equipment plugged into the extension cord does not exceed the extension cord ampere rating. Also, make sure that the total rating of all products plugged into the wall outlet does not exceed the fuse rating.
- Do not overload a power outlet, strip or receptacle by plugging in too many devices. The overall system load must not exceed 80% of the branch circuit rating. If power strips are used, the load should not exceed 80% of the power strip's input rating.
- This product's power cord is equipped with a three-wire grounded plug. The plug only fits in a grounded power outlet. Make sure the power outlet is properly grounded before inserting the power cord plug. Do not insert the plug into a non-grounded power outlet. Contact your electrician for details.



.....

Warning! The grounding pin is a safety feature. Using a power outlet that is not properly grounded may result in electric shock and/or injury.



.....

Note: The grounding pin also provides good protection from unexpected noise produced by other nearby electrical devices that may interfere with the performance of this product.

- Use the product only with the supplied power supply cord set. If you need to replace the power cord set, make sure that the new power cord meets the following requirements: detachable type, UL listed/CSA certified, type SPT-2, rated 7 A 125 V minimum, VDE approved or its equivalent, 4.5 meters (15 feet) maximum length.

Product servicing

Do not attempt to service this product yourself, as opening or removing covers may expose you to dangerous voltage points or other risks. Refer all servicing to qualified service personnel.

Unplug this product from the wall outlet and refer servicing to qualified service personnel when:

- the power cord or plug is damaged, cut or frayed
- liquid was spilled into the product
- the product was exposed to rain or water
- the product has been dropped or the case has been damaged
- the product exhibits a distinct change in performance, indicating a need for service
- the product does not operate normally after following the operating instructions



.....

Note: Adjust only those controls that are covered by the operating instructions, since improper adjustment of other controls may result in damage and will often require extensive work by a qualified technician to restore the product to normal condition.

Potentially explosive environments

Switch off your device in any area with a potentially explosive atmosphere and obey all signs and instructions. Potentially explosive atmospheres include areas where you would normally be advised to turn off your vehicle engine. Sparks in such areas could cause an explosion or fire resulting in bodily injury or even death. Switch off the device near gas pumps at service stations. Observe restrictions on the use of radio equipment in fuel depots, storage and distribution areas; chemical plants; or where blasting operations are in progress. Areas with a potentially explosive atmosphere are often, but not always, marked. They include below deck on boats, chemical transfer or storage facilities, vehicles using liquefied petroleum gas (such as propane or butane), and areas where the air contains chemicals or particles such as grain, dust or metal powders.

Additional safety information

Your device and its enhancements may contain small parts. Keep them out of the reach of small children.

IT Equipment Recycling Information

Acer is strongly committed to environmental protection and views recycling, in the form of salvaging and disposal of used equipment, as one of the company's top priorities in minimizing the burden placed on the environment. We at Acer are very conscious of the environmental effects of our business and strive to identify and provide the best working procedures to reduce the environmental impact of our products. For more information and help when recycling, please go to this website:

<https://www.acer-group.com/sustainability/en/our-products-environment.html>

Visit www.acer-group.com for further information on the features and benefits of our other products.

Disposal instructions

Do not throw this electronic device into the trash when discarding. To minimize pollution and ensure utmost protection of the global environment, please recycle. For more information on the Waste from Electrical and Electronics Equipment (WEEE) regulations, visit

<https://www.acer-group.com/sustainability/en/our-products-environment.html>



Recycling Information for the United States of America

Acer encourages information technology (IT) equipment owners to responsibly recycle their equipment when it is no longer needed. Acer offers programs and services to assist equipment owners with this process.

For more information on recycling IT equipment, please go to:

<https://www.acer.com/ac/en/US/content/recycling>

LCD pixel statement

The LCD unit is produced with high-precision manufacturing techniques. Nevertheless, some pixels may occasionally misfire or appear as black or red dots. This has no effect on the recorded image and does not constitute a malfunction.

This product has been shipped enabled for power management:

- Activate display's Sleep mode within 15 minutes of user inactivity.
- Activate computer's Sleep mode within 30 minutes of user inactivity.

Tips and information for comfortable use

Computer users may complain of eyestrain and headaches after prolonged use. Users are also at risk of physical injury after long hours of working in front of a computer. Long work periods, bad posture, poor work habits, stress, inadequate working conditions, personal health and other factors greatly increase the risk of physical injury.

Incorrect computer usage may lead to carpal tunnel syndrome, tendonitis, tenosynovitis or other musculoskeletal disorders. The following symptoms may appear in the hands, wrists, arms, shoulders, neck or back:

- numbness, or a burning or tingling sensation
- aching, soreness or tenderness
- pain, swelling or throbbing
- stiffness or tightness
- coldness or weakness

If you have these symptoms, or any other recurring or persistent discomfort and/or pain related to computer use, consult a physician immediately and inform your company's health and safety department.

The following section provides tips for more comfortable computer use.

Finding your comfort zone

Find your comfort zone by adjusting the viewing angle of the monitor, using a footrest, or raising your sitting height to achieve maximum comfort. Observe the following tips:

- refrain from staying too long in one fixed posture
- avoid slouching forward and/or leaning backward
- stand up and walk around regularly to remove the strain on your leg muscles

Taking care of your vision

Long viewing hours, wearing incorrect glasses or contact lenses, glare, excessive room lighting, poorly focused screens, very small typefaces and low-contrast displays could stress your eyes.

The following sections provide suggestions on how to reduce eyestrain.

Eyes

- Rest your eyes frequently.
- Give your eyes regular breaks by looking away from the monitor and focusing on a distant point.
- Blink frequently to keep your eyes from drying out.

Display

- Keep your display clean.
- Keep your head at a higher level than the top edge of the display so your eyes point downward when looking at the middle of the display.
- Adjust the display brightness and/or contrast to a comfortable level for enhanced text readability and graphics clarity.
- Eliminate glare and reflections by:
 - placing your display in such a way that the side faces the window or any light source
 - minimizing room light by using drapes, shades or blinds
 - using a task light
 - changing the display's viewing angle
 - using a glare-reduction filter
 - using a display visor, such as a piece of cardboard extended from the display's top front edge
- Avoid adjusting your display to an awkward viewing angle.
- Avoid looking at bright light sources, such as open windows, for extended periods of time.

Developing good work habits

Develop the following work habits to make your computer use more relaxing and productive:

- Take short breaks regularly and often.
- Perform some stretching exercises.
- Breathe fresh air as often as possible.
- Exercise regularly and maintain a healthy body.
- In order to prevent damage to the monitor, do not lift the monitor by its base.



Declaration of Conformity

We,

Acer Incorporated

8F, 88, Sec. 1, Xintai 5th Rd., Xizhi, New Taipei City 221

And,

Acer Italy s.r.l.

Viale delle Industrie 1/A, 20044 Arese (MI), Italy

Tel: +39-02-939-921 ,Fax: +39-02 9399-2913

www.acer.it

Product:	LCD Monitor
Trade Name:	Acer
Model Number:	UT242Y
SKU Number:	UT242Y xxxxxx;
	("x" = 0-9, a-z, A-Z, or blank)

We, Acer Incorporated, hereby declare under our sole responsibility that the product described above is in conformity with the relevant Union harmonization legislations as below Directive and following harmonized standards and/or other relevant standards have been applied:

EMC Directive: 2014/30/EU

<input checked="" type="checkbox"/> EN 55032:2015+A11:2020 Class B	<input checked="" type="checkbox"/> EN 55035:2017+A11:2020
<input checked="" type="checkbox"/> EN EN IEC 61000-3-2:2019 Class D	<input checked="" type="checkbox"/> EN EN61000-3-3:2013+A1: 2019

LVD Directive: 2014/35/EU

EN 62368-1: 2014+A11:2017

RoHS Directive: 2011/65/EU

EN IEC 63000: 2018

ErP Directive: 2009/125/EC

(EU) 2019/ 2021; EN 50564:2011

Year to begin affixing CE marking: 2022.

RU Jan / Sr. Manager
Acer Incorporated (New Taipei City)

Dec.30,2022
Date



Acer America Corporation
333 West San Carlos St., San Jose
Suite 1500
CA 95110, U. S. A.
Tel : 254-298-4000
Fax : 254-298-4147
www.acer.com



Federal Communications Commission Declaration of Conformity

This device complies with Part 15 of the FCC Rules. Operation is subject to the following two conditions: (1) this device may not cause harmful interference, and (2) this device must accept any interference received, including interference that may cause undesired operation.

The following local Manufacturer /Importer is responsible for this declaration:

Product:	LCD Monitor
Model Number:	UT242Y
SKU Number:	UT242Y xxxxxx; (“x” = 0~9, a ~ z, A ~ Z or Blank)
Name of Responsible Party:	Acer America Corporation
Address of Responsible Party:	333 West San Carlos St. Suite 1500 San Jose, CA 95110 U. S. A.
Contact Person:	Acer Representative
Phone No.:	254-298-4000
Fax No.:	254-298-4147



ENERGY STAR®

Acer's ENERGY STAR qualified products save you money by reducing energy costs and helps protect the environment without sacrificing features or performance. Acer is proud to offer our customers products with the ENERGY STAR mark.

What is ENERGY STAR?

Products that are ENERGY STAR qualified use less energy and prevent greenhouse gas emissions by meeting strict energy efficiency guidelines set by the U.S. Environmental Protection Agency. Acer is committed to offer products and services worldwide that help customers save money, conserve energy and improve the quality of our environment. The more energy we can save through energy efficiency, the more we reduce greenhouse gases and the risks of climate change. More information refers to <http://www.energystar.gov>.

Acer ENERGY STAR qualified products:

- Produce less heat and reduce cooling loads, and warmer climates.
- Automatically go into "display sleep" within 5 minutes of inactivity.
- Wake the monitor when it is in Active Off mode, move the mouse or press any keyboard key.

ENERGY STAR and the ENERGY STAR mark are registered U.S. marks

Contents

Special notes on LCD monitors	iii
Information for your safety and comfort	iii
Safety instructions	iii
Cleaning your monitor	iii
Connecting/disconnecting the device	iii
Accessibility	iii
Safe listening	iv
Warnings	iv
Using electrical power	iv
Product servicing	v
Additional safety information	vi
IT Equipment Recycling Information	vi
Disposal instructions	vi
Recycling Information for the United States of America	vi
LCD pixel statement	vii
Tips and information for comfortable use	vii
CE Declaration of Conformity	ix
Federal Communications Commission	
Declaration of Conformity	x
ENERGYSTAR	xi
Unpacking	1
Screen position adjustment	2
Connecting the power cord	3
Power saving	3
Display Data Channel (DDC)	3
Connector pin assignment	4
Standard timing table	6
Installation	7
User controls	8
Adjusting the OSD settings	11
Adjusting the Color setting	12
Adjusting the Audio setting	13
Adjusting the Performance setting	13
Adjusting the OSD setting	14
Product the System setting	15
Product the Information setting	15
Save Setting to... (User mode only)	16
Troubleshooting	17
HDMI/DP model	17

Unpacking

Please check that the following items are present when you unpack the box, and save the packing materials in case you need to ship or transport the monitor in the future.

LCD monitor

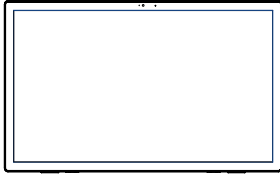

Quick start guide

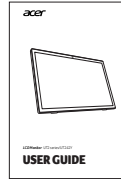

AC power cord

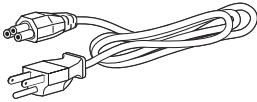

*DP cable (Option)

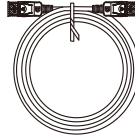

*HDMI cable (Option)

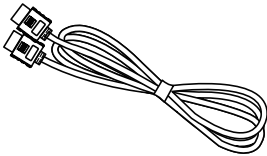

*USB cable (Option)

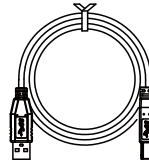

Screen position adjustment

In order to optimize the best viewing position, you can adjust the tilt of the monitor.

- **Tilt**

Please see the illustration below for an example of the tilt range.

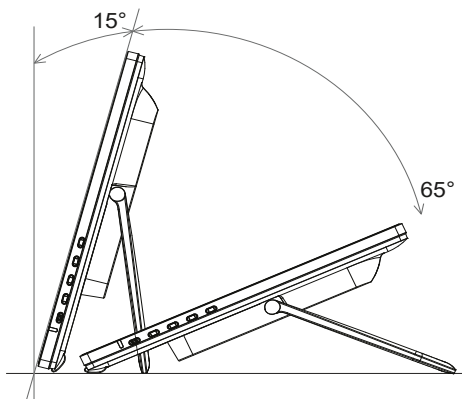

Connecting the power cord

- Check first to make sure that the power cord you use is the correct type required for your area.
- The monitor has a universal power supply that allows operation in either 100/120 V AC or 220/240 V AC voltage area. No user-adjustment is required.
- Plug one end of the power cord to the AC inlet, and plug the other end into an AC outlet.
- For units using 120 V AC: Use a UL-listed cord set, type SVT wire and plug rated 10 A/125 V.
- For units using 220/240 V AC: Use a cord set consisting of H05VV-F cord and plug rated 10 A/250 V. The cord set should have the appropriate safety approvals for the country in which the equipment will be installed.

Power saving

The monitor will be switched to "power saving" mode by the control signal from the display controller, as indicated by the orange-colored power LED.

Model	LED light
On	Blue
Power saving	Amber

The power saving mode will be kept until a control signal has been detected or the keyboard or mouse is activated. The recovery time from "power saving" mode back to "on" is around 3 seconds.

Display Data Channel (DDC)

To make installation easier, so long as your system supports the DDC protocol, the monitor is able to plug-and-play. The DDC is a communication protocol through which the monitor automatically informs the host system about its capabilities; for example, supported resolutions and corresponding timing. The monitor supports the DDC2B standard.

Connector pin assignment

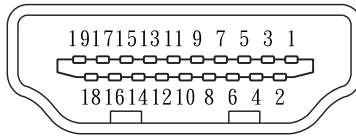

19-pin color display signal cable

PIN No.	Description	PIN No.	Description
1	TMDS data 2+	11	TMDS clock shield
2	TMDS data 2 shield	12	TMDS clock-
3	TMDS data 2-	13	CEC
4	TMDS data 1+	14	DDC-serial data
5	TMDS data 1 shield	15	SCL
6	TMDS data 1-	16	SDA
7	TMDS data 0+	17	DDC/CEC Ground
8	TMDS data 0 shield	18	+5V Power
9	TMDS data 0-	19	Hot Plug Detect
10	TMDS clock+		

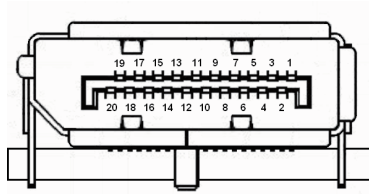

20-pin color display signal cable

PIN No.	Description	PIN No.	Description
1	Lane0 (p)	11	GND
2	GND	12	Lane3 (n)
3	Lane0 (n)	13	Config 1
4	Lane1 (p)	14	Config 2
5	GND	15	AUX_CH (n)
6	Lane1 (n)	16	GND
7	Lane2 (p)	17	AUX_CH (p)
8	GND	18	Hot Plug Detect
9	Lane3 (n)	19	DP Power_Return
10	Lane3 (p)	20	DP Power

Standard timing table

Mode		Resolution		
1	VGA	640×480	60	Hz
2	Mac	640×480	66	Hz
3	VGA	640×480	72	Hz
4	VGA	640×480	75	Hz
5	SVGA	800×600	56	Hz
6	SVGA	800×600	60	Hz
7	SVGA	800×600	72	Hz
8	SVGA	800×600	75	Hz
9	Mac	832×624	75	Hz
10	XGA	1024×768	60	Hz
11	XGA	1024×768	70	Hz
12	XGA	1024×768	75	Hz
13	SXGA	1280×1024	60	Hz
14	SXGA	1280×1024	75	Hz
15	720P	1280×720	60	Hz
16	WXGA+	1440 ×900	60	Hz
17	WSXGA+	1680×1050	60	Hz
18	FULL HD	1920×1080	60	Hz
19	FULL HD	1920×1080	75	Hz

Installation

To install the monitor on your host system, please follow the steps below:

Steps

1. Turn off your computer and unplug your computer's power cord.
2. Connect the signal cable to the DP (optional) and/or HDMI (optional) input socket of the monitor, and the DP (optional) and/or HDMI (optional) output socket of the graphics card on the computer. Then tighten the thumbscrews on the signal cable connector.
3. Connect the USB Cable(Optional)
Connect one end of the USB cable to the USB terminal of the monitor, and connect the other end of the USB cable to an appropriate USB port on your device.

Note: The USB downstream port does not provide power while the monitor switch is off.
USB output: 5V/0.9A

4. Insert the monitor power cable into the power port at the back of the monitor.
5. Plug the power cords of your computer and your monitor

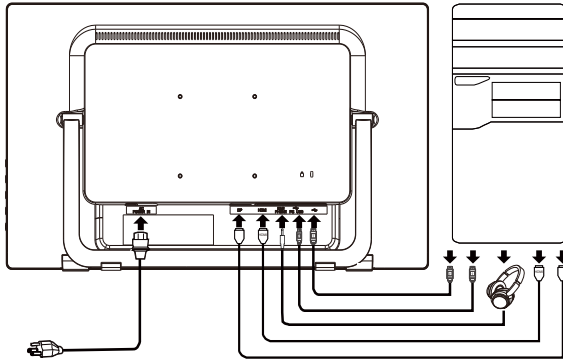



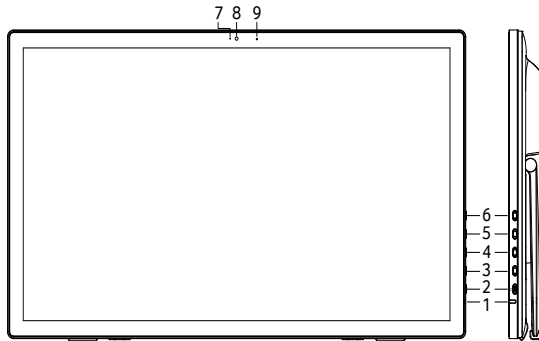

*Users may go to the local service network to replace /purchase the qualified replaceable parts.
For local service centers and service contacts, please refer to <https://www.acer.com/ac/en/US/content/support>

User controls



Using the Shortcut Menu

Press the function button to open the shortcut menu. The shortcut menu lets you quickly select the most commonly accessed settings.

1	LED Indicator	Blue indicates power on. Amber indicates standby/power saving mode.
2	Power button	Turns the monitor on/off.
3	Function key 	<ol style="list-style-type: none"> Press to view Main page. Press again to enter next function in the Function Menu. When the OSD menu is active, this button will act as the exit key (exit OSD menu).
4	Function key 	<ol style="list-style-type: none"> Press to view Main page. Press again to enter Input select function. When the Function Menu is active, press to enter a selection in the OSD.
5	Function key 	<ol style="list-style-type: none"> Press to view Main page. Press again to enter hotkey 2 function. Press this button to select the desired item when in OSD menu.
6	Function key 	<ol style="list-style-type: none"> Press to view Main page. Press again to enter hotkey 1 function. Press this button to select the desired item when in OSD menu.
7	Webcam LED indicator	Indicator of Webcam. It will light up when webcam is in use.
8	Webcam	Allows you to video chat, record video, and record still images.
9	Microphone	Monitor microphones.

NOTE: For Webcam and Microphone to work, connect the USB upstream cable from the PC to the monitor.

FreeSync(DP/HDMI) :

It can allow a FreeSync supported graphics source to dynamically adjust display refresh rate based on typical content frame rates for power efficient, virtually stutter free and low-latency display update.

Using the Shortcut Menu

Main page

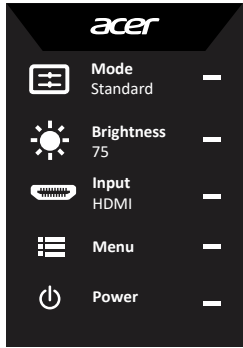
	<ol style="list-style-type: none">Hot Key 1 Modes, Brightness, Volume, Gamma, Contrast, Low Blue Light, Over DriveHot Key 2 Modes, Brightness, Contrast, Volume, Gamma, Low Blue Light, Over DriveHot Key 3 Input Switch Hot KeyMain Menu
---	--

Hot key 1 (default: Standard mode)

To choose scenario mode (sRGB, Reading, Darkroom, User, Standard, ECO, Graphics, Movie)

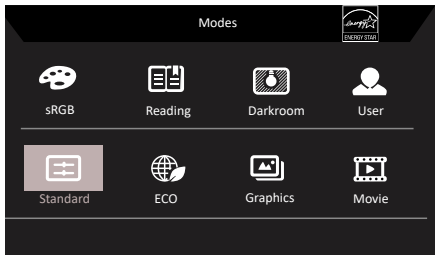

Hot key 2 (default: Brightness)

Open the Brightness control and select your preferred brightness setting.

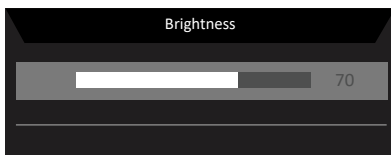

Selecting the input

Open the Input control and select HDMI, DP or Auto Source.

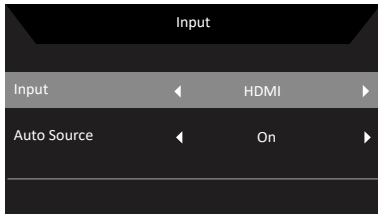

Touch support operation system

	Mouse	Single Touch	Multi Touch	Plug and Play
Win7/Win8/Win10/Win11	○	○	○	○
Android* ¹	○	○	○	○
Linux* ¹	○	○	○	○
Mac OS* ²	○	○	○	○
Chorme OS	○	○	○	○

*¹ : Kernel above 3.8 version.

*² : Please download the driver form acer website.

○: Supported

Adjusting the OSD settings



Note: The following content is for general reference only. Actual product specifications may vary.





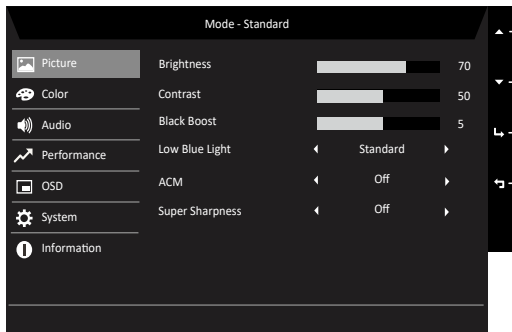

Note: This product qualifies for ENERGY STAR in the “factory default” setting and this is the setting in which power savings will be achieved.
Changing the factory default picture settings or enabling other features will increase power consumption that could exceed the limits necessary to qualify for ENERGY STAR rating

The OSD can be used for adjusting the settings of your LCD Monitor. Press the  key to open the OSD. You can use the OSD to adjust the picture quality, OSD setting and general settings. For advanced settings, please refer to following page:

Adjusting the picture quality



1. Press the  key to bring up the OSD.
2. Using the / keys, select Picture from the OSD menu. Then navigate to the picture element you wish to adjust.
3. Use the / keys to adjust the sliding scales.
4. The Picture menu can be used to adjust the current Brightness, Contrast, Black Boost, Low Blue Light, ACM, Super Sharpness qualities.
5. Brightness: Adjust the brightness from 0 to 100.



Note: Adjusts the balance between light and dark shades.

6. Contrast: Adjust the contrast from 0 to 100.



Note: Sets the degree of difference between light and dark areas.

7. Black Boost: Adjust the black level from 0 to 10. Enhances shadows by increasing the brightness without changing lighter shades.

- Low Blue Light: Filters out blue light to protect your eyes by adjusting how much blue light is shown -- Standard, Level 1, Level 2, Level 3 or Level 4.



Note: A higher value allows more blue light to pass through, so in order to achieve the best protection, please select a lower value, of which 50% is in the best state and has been tested by TÜV Rheinland and meet the requirements of TÜV Rheinland's "Low Blue Light Content" standard.

- ACM: Turn ACM on or off.



Note: Set to "On", will be based on the current screen to dynamic contrast adjustment.

- Super Sharpness: Turn the Super Sharpness On or Off. Super Sharpness technology can simulate high-resolution images by boosting the pixel density of the original source to make images sharper and clearer.



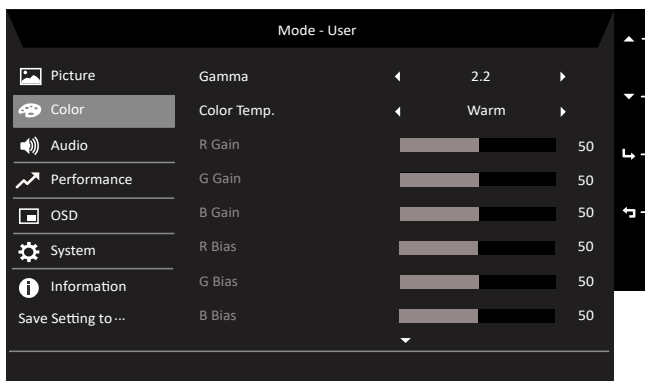

Adjusting the Color setting

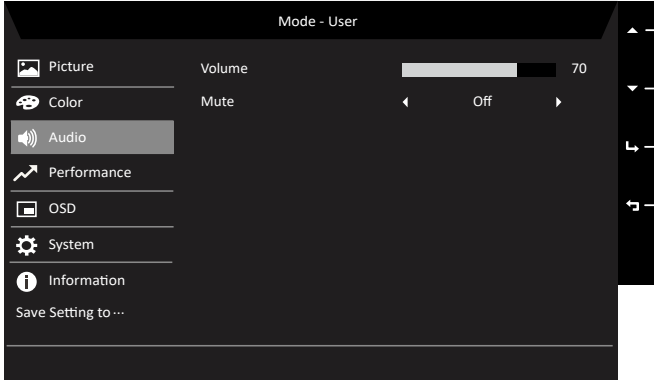

- Press the key to bring up the OSD.
- Using the / keys, select Color from the OSD menu. Then navigate to the feature you wish to adjust.
- Use the / keys to adjust the sliding scales.
- The Color menu can be used to adjust the current Gamma, Color Temp. Modes, sRGB Mode, Grayscale Mode and other color-related qualities.
- Color temperature: Default is warm. You can choose Cool, Normal, Warm, Low Blue light or User.
- Modes: To choose scenario mode.
- sRGB Mode: Default is off. You can turn sRGB mode on or off to better color match with peripheral devices, such as printers and digital cameras.
- Grayscale Mode: To choose Grayscale mode.
- 6-axis Hue: Adjust the red, green, blue, yellow, magenta and cyan hue.
- 6-axis Saturate: Adjust the red, green, blue, yellow, magenta and cyan saturation.





Adjusting the Audio setting

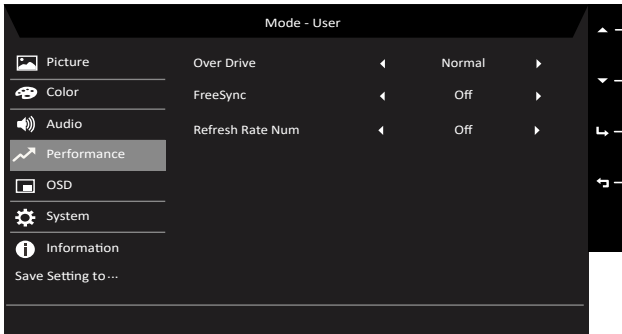

1. Press the  key to bring up the OSD.
2. Using the / keys, select Audio from the OSD. Then navigate to the feature you wish to adjust.
3. Use the / keys to adjust the sliding scales.

Adjusting the Performance setting









1. Press the  key to bring up the OSD.
2. Using the / keys, select Performance from the OSD menu. Then navigate to the feature you wish to adjust.
3. Use the / keys to adjust the sliding scales.
4. The Performance menu can be used to adjust the screen Over Drive, Freesync and Refresh Rate Num.

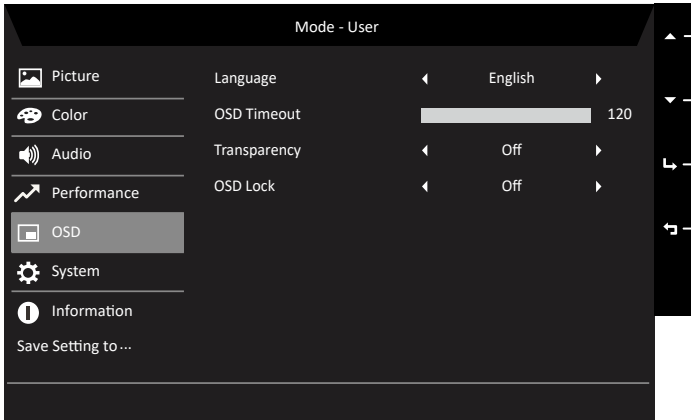

Note: If FreeSync set "On" you can see the V Frequency to changes in the OSD.

Adjusting the OSD setting



1. Press the  key to bring up the OSD.
2. Using the / keys, select OSD from the OSD menu. Then navigate to the feature you wish to adjust.
3. Use the / keys to adjust the sliding scales.
4. The Setting menu can be used to adjust the screen Language, OSD Timeout and other important settings.
5. OSD timeout: Adjust the delay before turning off the OSD menu.
6. Transparency: Select the transparency when using gaming mode. The transparency can be 0% (OFF), 20%, 40%, 60%, or 80%.
7. OSD Lock: To control OSD Key lock On/Off.



Note:

OSD Locked:





- Set the OSD Lock to “On” by the OSD option and press “Enter” to execute the All Key lock function.
- The “OSD Locked” message will be displayed in the middle of the screen.
- LED lights will be changed from blue light to orange light.
- Press any Key screen to prompt “OSD Locked” message.

OSD Unlocked:

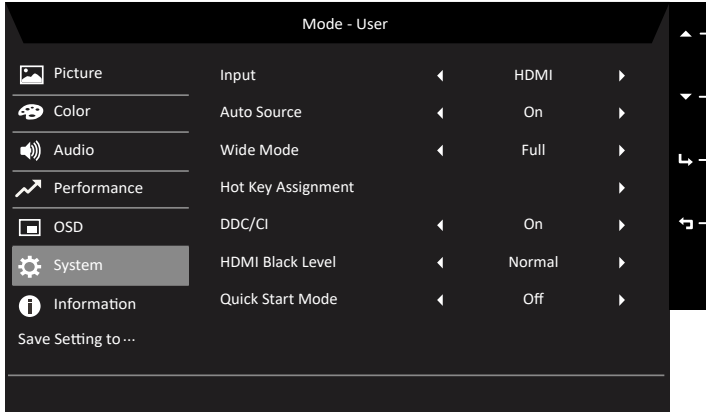
- In normal display condition to press the “Navi Key” in the middle of more than 3 seconds to trigger “OSD Unlock”.
- The “OSD Unlock” message will be displayed in the middle of the screen.
- LED lights will be restored to blue light.

Product the System setting



1. Press the  key to bring up the OSD.
2. Using the / keys, select System from the OSD. Then navigate to the feature you wish to adjust.
3. Use the / keys to adjust the sliding scales.
4. The Performance menu can be used to adjust the Input, Auto Source, Wide Mode, Hot Key Assignment and other important settings.
5. DDC/CI: Allows the monitor settings to be set through the software on the PC.





Note: DDC/CI, short for Display Data Channel/Command Interface, which allows monitor controls to be sent via software.

6. HDMI Black level: Select to set HDMI black level.
7. Quick start mode: Select Off or On. Turn on to speed up boot speed.

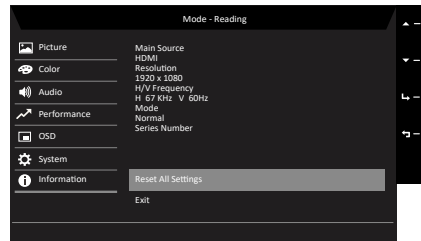
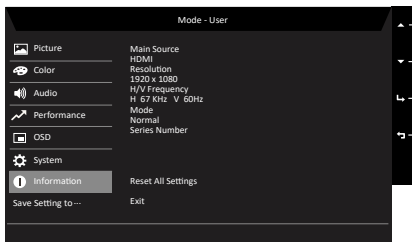



Product the Information setting

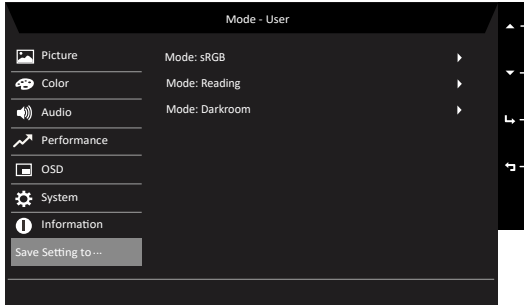

1. Press the  key to bring up the OSD.
2. Using the / keys, select Information from the OSD. The basic information of LCD monitor will show up for current input.
3. The Information menu can be used to adjust the Reset All Settings and Exit settings.

Save Setting to... (User mode only)



1. Press the  key to bring up the OSD.
2. Using the / keys to select "Save Setting to..." from the OSD. Then use the  key to adjust the sliding scales.
3. Save Setting to Game mode: There are three user-defined profiles available. When you have decided what settings suit you, save them and system will be able to recall the settings in the future when you turn on gaming mode.

Troubleshooting

Before sending your LCD monitor for servicing, please check the troubleshooting list below to see if you can self-diagnose the problem

HDMI/DP model

Problem	LED status	Remedy
No picture visible	Blue	Using the OSD, adjust brightness and contrast to maximum or reset to their default settings.
	Off	Check the power switch. Check if the power cord is properly connected to the monitor.
	Orange	Check if the video signal cable is properly connected at the back of monitor. Check if the computer system is switched on and in power saving/standby mode.
Unstable picture		Check if the specification of graphics adapter and monitor is in compliance which may be causing the input signal frequency mismatch.
Abnormal picture	Image is missing, off-center, too large or too small on the screen.	Check the display setting on your system. In case of a missing image, please select another resolution or vertical refresh rate.
		Wait for a few seconds after adjusting the size of the image before changing or disconnecting the signal cable or switching off the monitor.

Note: Acer monitor is purposed for video and visual display of information obtained from electronic devices.



Product Information for EU Energy Label