

EDGE+

Quick Installation Guide
EVC5ZB Cloud Bullet Camera

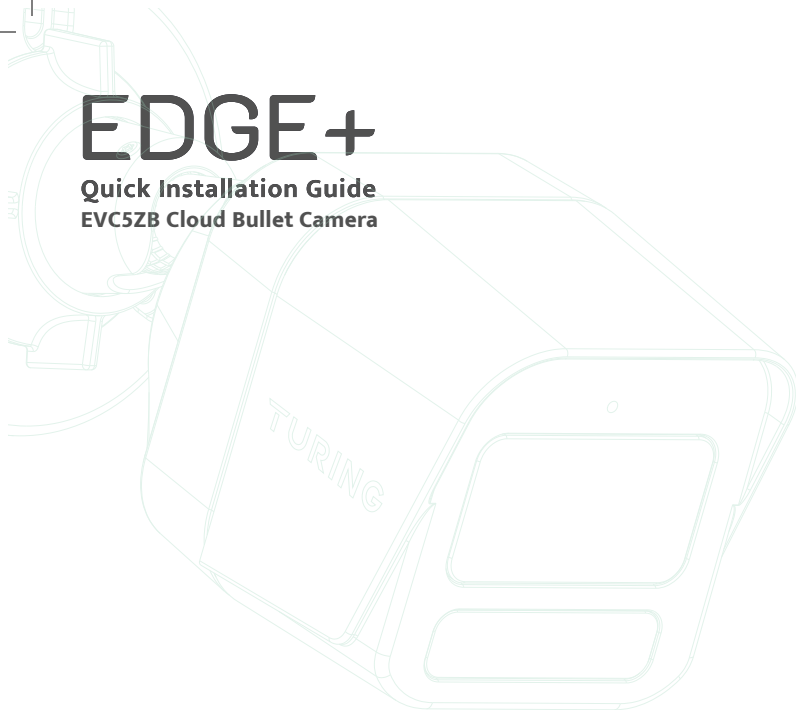

TURING



TABLE OF CONTENT

- 1 What's included
- 2 Tools you'll need
- 3 Know your EDGE+
- 4 Mount EDGE+
- 5 Activate EDGE+
- 6 Safety
- 7 Limited warranty

WHAT'S INCLUDED

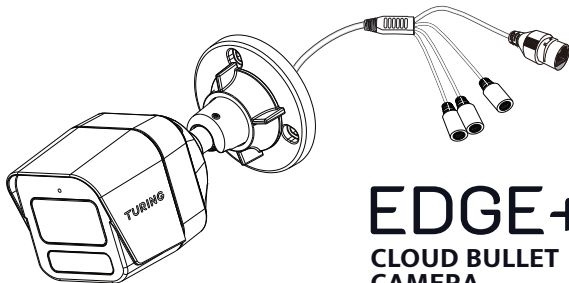

EDGE+ CLOUD BULLET CAMERA



M4 x 25
Screws (x4)



Plastic Screw
Anchors (x4)



M2.5 x 8
Screws (x1)



Screw wrench

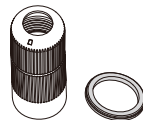

Cable gland



Quick Guide



Mounting Template

TOOLS YOU'LL NEED

Connection

24/7 broadband internet connection

Ethernet cable

Smart phone (iOS or Android) or computer
(Mac or Windows)

Power

PoE switch or PoE injector that is IEEE 802.3af
compatible

Mounting

Tip size#2 Philips screwdriver or bit (PH2)

Power drill

1/8" (3mm) drill bit for pilot holes

1/4" (6mm) drill bit for anchors

Optional: 5/8" (16mm) bit or hole cutter
for the network cable

KNOW YOUR EDGE+

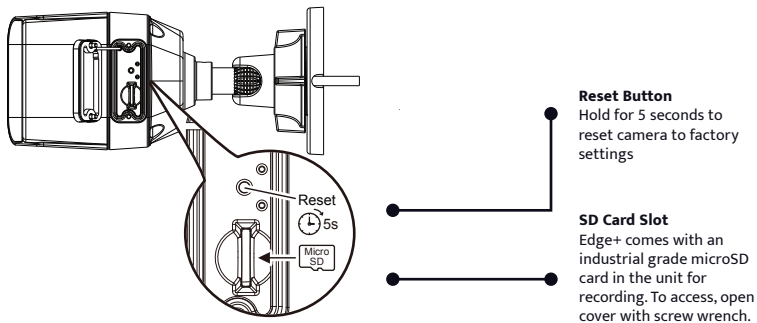
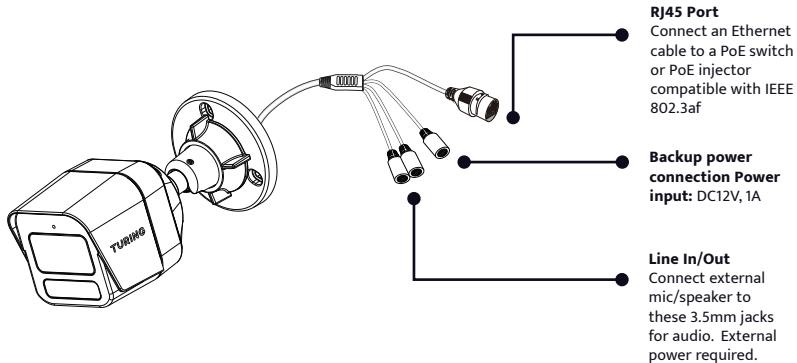



MOUNT **EDGE+**



Find Installation Spot

Mounting a camera requires a little bit of planning. It saves time to plan ahead before drilling holes in your wall.

The EVC5ZB, with IP66 and IK10 rating, is weatherproof and vandal resistant. It can be installed indoor and outdoor, operating between -22°F and 140°F. 7 to 10 feet above the ground, tilted downward, is best — this is high enough to let you see people's faces and wide enough to cover most areas with its field of view of 106° to 32°.

Avoid positioning the camera behind the glass and under the overhangs. They may reflect IR light into the camera and cause issues in the camera night vision.

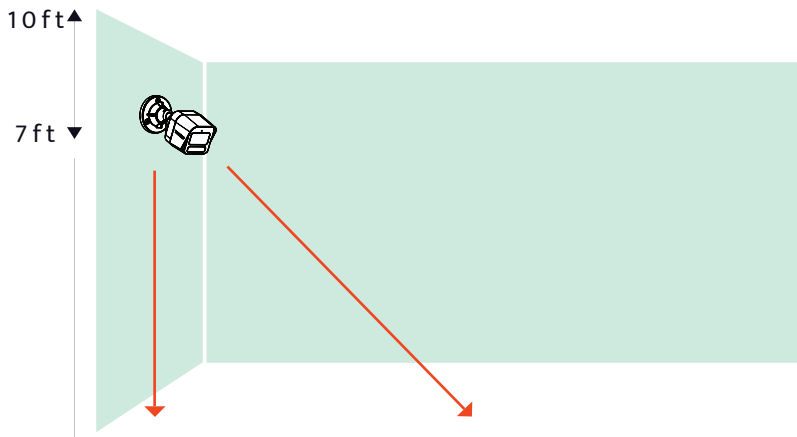

DRILL MOUNTING HOLES

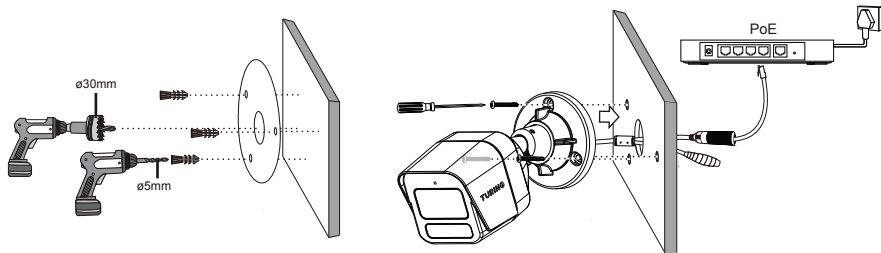

Attach and Secure the Cable

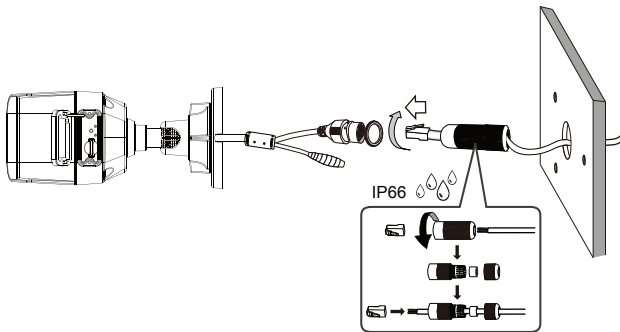

BEST MOUNTING PRACTICE

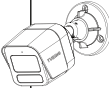
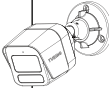
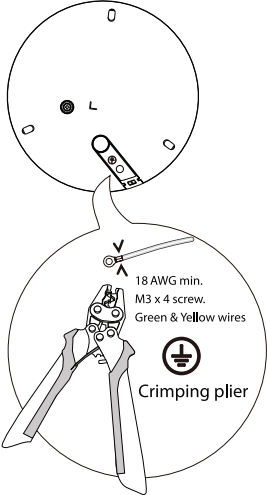

POWER IT UP

A Plug the other end of the Ethernet cable into a PoE switch or PoE

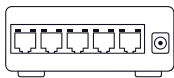

B Connect the PoE switch or PoE injector to a router with access to the Internet.

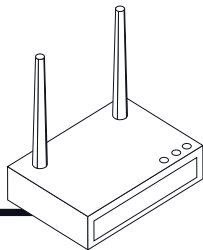

C Prepare a mobile device or computer with access to the Internet for adding the camera.

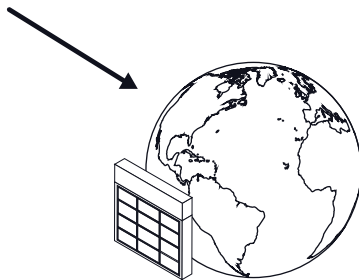

ADJUST THE ANGLE

Pan and tilt the camera and check its video in the Turing Vision app to fine-tune the position. Fasten the tilt screw to fix the tilt angle.

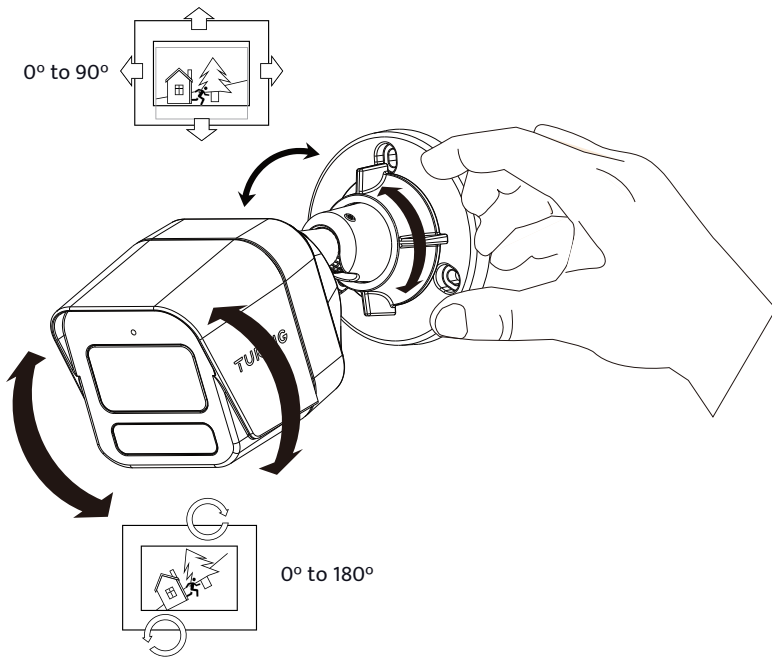



ACTIVATE **EDGE+**

PREPARE YOUR TPP INFO

Write down your TPP number here before adding and activating the cameras. You will need it in the next step. By entering your TPP number, you can view your customer's contact information, update the device firmware, and monitor their device health remotely from the Partners Portal.

My TPP Number is ____ _

The TPP number is the unique identifier you receive when you join the Turing Partner Program.

Not a Turing Partner yet?

Join our Turing Partner Program today.



Partner
Co-Marketing



Product
Training



Preferred
Pricing



Priority
Support



Partners
Portal



sales@turingvideo.com



877.730.8222



turing.ai/tp



CREATE ACCOUNT

- 1 Log into the Partner Portal.



<https://partner-portal.turingvideo.com>



Get the Partner App by downloading it from the App Store or Google Play.

- 2 Create a customer account

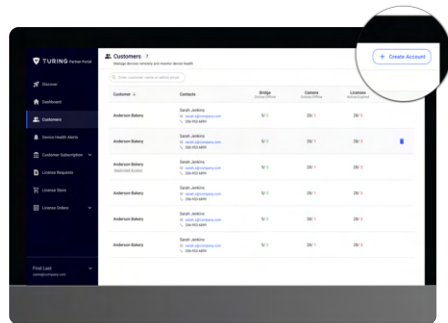
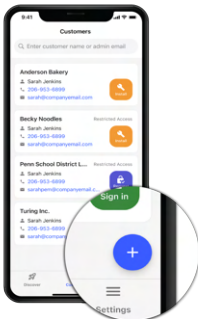

ADD SYSTEM

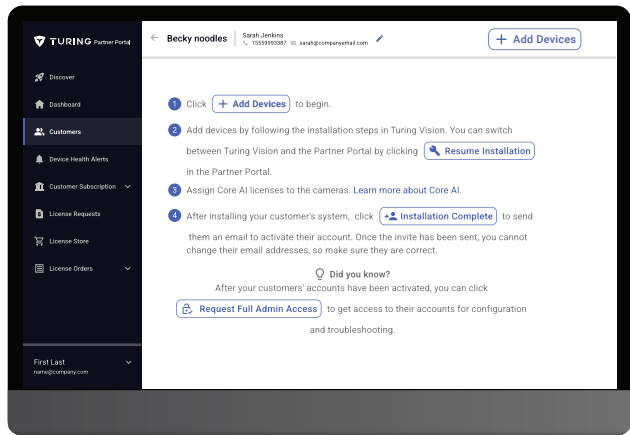
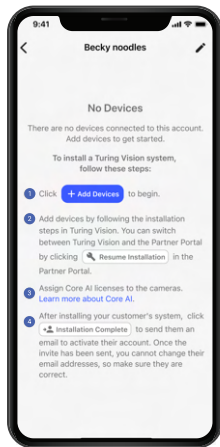

After setting up the customer account, proceed with the installation steps. Once the installation is finished, make sure to click on "Installation Complete" to send an invitation to the customer to activate their account.

Once the customer activates their account, request full admin access to configure or add more systems, and troubleshoot any issues with their account.

INSTALL IN 3 CLICKS

Get Started

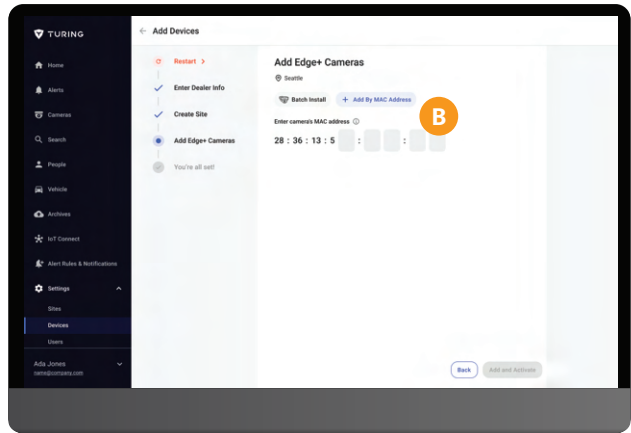

A Scan the QR Code

or **B** Enter a MAC Address

The QR code and MAC address can be found on the back of your device or the product package.

INSTALL IN 3 CLICKS

Auto Search

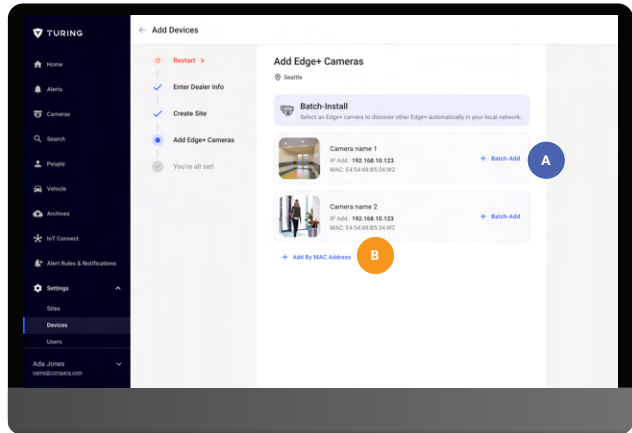
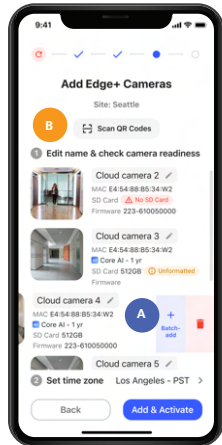

A To speed up the setup process, we recommend using the "+ Batch-Add" feature to automatically detect other Edge+ cameras on your local network. On the web, simply click the "+ Batch-Add" icon next to a camera to start the search. On mobile, swipe left on any camera and tap the "+ Batch-Add" icon.

B However, if you prefer, you can manually scan the QR codes or enter the MAC addresses instead.

INSTALL IN 3 CLICKS

Batch Add

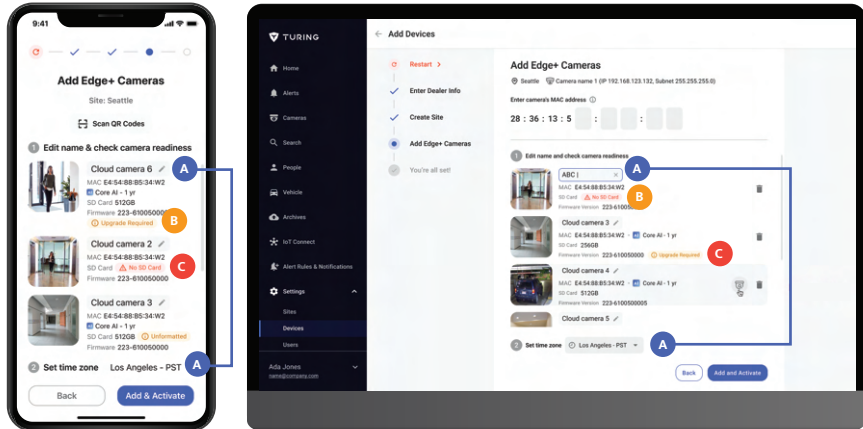

- A** To add cameras to the customer's account, edit their names and time zone, and click "Add & Activate."
- B** If a camera does not meet the minimum firmware requirement, our system will automatically upgrade the camera firmware upon activation.
- C** Additionally, any unformatted SD cards will be initialized during this process.

SAFETY

The product must be installed and protected in a location that is not easily accessible, and is away from impacts or heavy vibration.

Do not install the product on an unstable mount or surface.

Do not disassemble the camera or perform maintenance task when power is connected.

The product should be used in compliance with local laws and regulations.

Before installation, the product should be stored in a dry and ventilated environment.

Use only accessories that comply with the technical specifications of the product.

Power over Ethernet (PoE) shall be provided by listed Information Technology Equipment meeting IEEE 802.3af PoE standards. If an external power supply is used, to ensure compliance with electrical safety standards, CSA Certified/UL Listed LPS or Class 2 power adaptors are required.



This device complies with Part 15 of the FCC Rules. Operation is subject to the following two conditions:
(1) this device may not cause harmful interference, and (2) this device must accept any interference received, including interference that may cause undesired operation.

LIMITED WARRANTY

Turing AI is pleased to offer up to ten (10) years of limited warranty for Turing-branded cameras purchased from our authorized distributors and authorized dealers, with a continuous Turing Video CORE AI license subscriptions.

Without Turing Video CORE AI license subscriptions, all Turing-branded cameras, recorders, and bridge devices purchased from our authorized distributors and authorized dealers come standard with a three (3) year limited warranty.

Enjoy the security and peace of mind with Turing products anytime, anywhere.

Some restrictions may apply. For complete details, please refer to the Turing AI Limited Warranty Policy available in the link below

<https://turing.ai/legal/warranty>

CONTACT

No worries. We are here for you.

Contact us at



support@turingvideo.com



866.816.7426

Visit



<https://turing.ai>



| [Turing.ai](https://turing.ai)



EDGE+

Quick Installation Guide
EVC5ZB Cloud Bullet Camera



TURING