



Evanescence Plus Series

In-Ceiling Electric Motorized Front Projection Screen

User's Guide – E/H type (RC1) V1.0

Visit www.eliteproav.com for latest updated version.

Important Safety & Warning Precautions

Make sure to read this user's guide and follow the procedures below.

Caution: The screen's Black Top Drop is already set to its maximum drop limit. There is **NO** extra black drop material in the roller. Please be aware that altering the vertical limit switch to drop the screen material off the roller voids your warranty with Elite ProAV®. Unapproved changes or modifications (except for cutting the power cord for hardwire installations) to this unit are prohibited and will void your warranty.

For more information, please contact our Technical Support Department at www.eliteproav.com

Elite ProAV allows a 1.5% tolerance within the viewing surface for expansion and contraction of the screen materials over time.

- Please retain this user's guide for future reference.
- To avoid damaging the unit, do not use with any unauthorized accessories not recommended by the manufacturer.
- Handle the unit carefully during transportation to avoid any damages.
- To ensure safe and reliable operation, direct connection to a properly grounded power source is advised.
- The power outlet supplying power to the unit should be close to the unit and easily accessible.
- Do not install the unit on uneven, inclined surfaces.
- Do not install in damp places to avoid an electric shock or short circuit.
- Do not place any heavy objects over the power cord.
- Position the power cord properly to avoid creating a trip obstacle.
- To avoid an electrical shock or fire, due to a loose contact or short circuit, do not overload the power cord.
- The internal & external parts of this unit are not end user serviceable. Do not attempt to disassemble this unit by yourself. No one except authorized technicians can open and make repairs to this unit.
- Make sure the power source that this unit is connected to has a continuous power flow.
- If there is need to use an extension cord, make sure the cord has an equal rating as the appliance to avoid overheat.
- Do not handle the power plug when your hands are wet or your feet are in contact with water.
- Properly dispose of this equipment according to the environmental regulations in your area when product is no longer of service.

Do not use this unit under the following circumstances.

- Disconnect the power cord under the conditions of heavy rain, wind thunder or lightning.
- Avoid direct sun light, rain shower and moisture.
- Keep away from fire sources and high temperature to prevent this device from overheating.
- Cut off the power supply first before transportation or maintenance.
- To avoid possible injury and/or an electric shock, do not attempt to use this screen if there is obvious damage or if there are any evident broken parts.

Installation Warning

Due to various installation environments, the instructions provided in this user's guide are for reference only. Please consult a professional installation company for further installation and safety advice. The installer must ensure that proper mounting hardware is used to provide adequate strength suitable for the installation. Elite ProAV is not liable for any faulty installations.

Individual modifications to this product are prohibited and will void the warranty. Please contact Elite ProAV Customer Service for any questions.

NOTE:

This equipment has been tested and found to comply with the limits for a Class B digital device, pursuant to Part 15 of the FCC Rules.

These limits are designed to provide reasonable protection against harmful interference in a residential installation. This equipment generates and can radiate radio frequency energy and, if not installed and used in accordance with the instructions, may cause harmful interference to radio communications.

However, there is no guarantee that the interference will not occur on a particular installation. If this equipment causes harmful interference to radio or television reception, which can be determined by turning the equipment off and on, the user is encouraged to try to correct the interference by one or more of the following measures.



- ✓ **Reorient or relocate the receiving antenna of the device which may be causing the interference.**
- ✓ **Increase the separation between the screen and the device's receiver.**
- ✓ **Connect the equipment into a different power outlet other than the device.**

Pre-Installation

1. Carefully unpack the screen.
2. Always handle the screen in a leveled position on a clean surface.
3. In order to protect the screen from exposure to stains, keep the screen out of contact with foreign particles such as dust, sawdust, and/or liquids.

NOTE

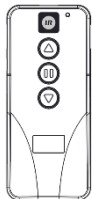
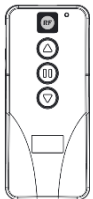
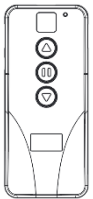
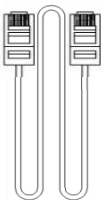
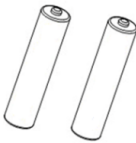
Regardless of the mounting method, the screen should be securely supported so that the vibration or pulling on the viewing surface will not cause the casing to become loose or fall. The installer must ensure the fasteners that are used are of adequate strength and suitable for the installation location.

Evanesce Plus series Controls and Accessories					
A. IR Remote ZRC1-IR	B. RF Remote ZRC1-RF	C. Wall box controller ZRC1-WB	D. RJ50 Cable ZRC1-RJ50	E. AAA batteries	F. Bubble Level
					

Screen operation

Electric Current: 100 ~ 110v voltage

1. After ensuring the power outlet & screen are compatible (voltage), plug the power cord into the power outlet.
2. Once the screen has power, you'll be able to control it using any of the 5 methods described below.

5 Ways to control your Evanesce screen

1. IR Remote control (Item A, Fig 1): The Infrared functions by direct line of sight contact using an effective beam range of 25 feet within a 30-degree angle. Aim the IR remote directly at either the IR receiver on the Wall Box Controller or on the screen to operate the screen.

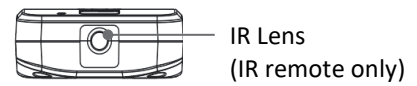

Note: Assure there is no obstruction between the IR remote and IR receiver.

2. RF Remote Control (Item B): The radio waves eliminate the need for a direct line of sight and has a longer distance control range.

The RF remote is already pre-synced/paired and ready to use. If synchronization/ pairing is needed, please follow the steps below.

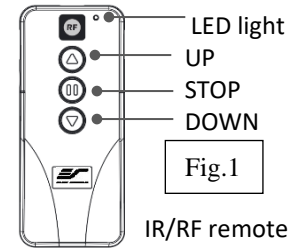

How to synchronize/pair a new RF remote:

- Press & hold the “**Programming Key**”, then press the “**Up Key**” on the **Wall box controller** (wall-box LED flashes). *Reference the wall box controller section for programming key location.*
- Then press the “**Up Key**” on the **RF remote**.
- The **Wall box LED** will flash 5 times, to indicate the RF remote has been properly synchronized/paired.

How to change the RF code (For use when multiple screens/RF remotes are owned)

Changing the RF code avoids controlling multiple screens at the same time and prevents electrical interference leading to accidental control of the screen.

1. Remove the batteries
2. Change the RF code switch
3. Insert the batteries
4. Synchronize it with the wall box controller

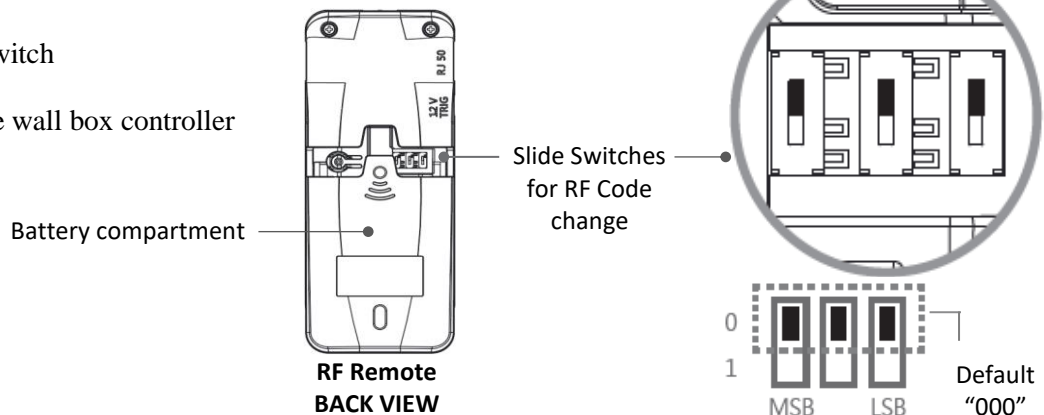

3. Wall box controller (Item C, Fig 2): The wall box controller switch is a wall mounted control box with an up/stop/down button. It plugs directly into the screen’s RJ50 port.

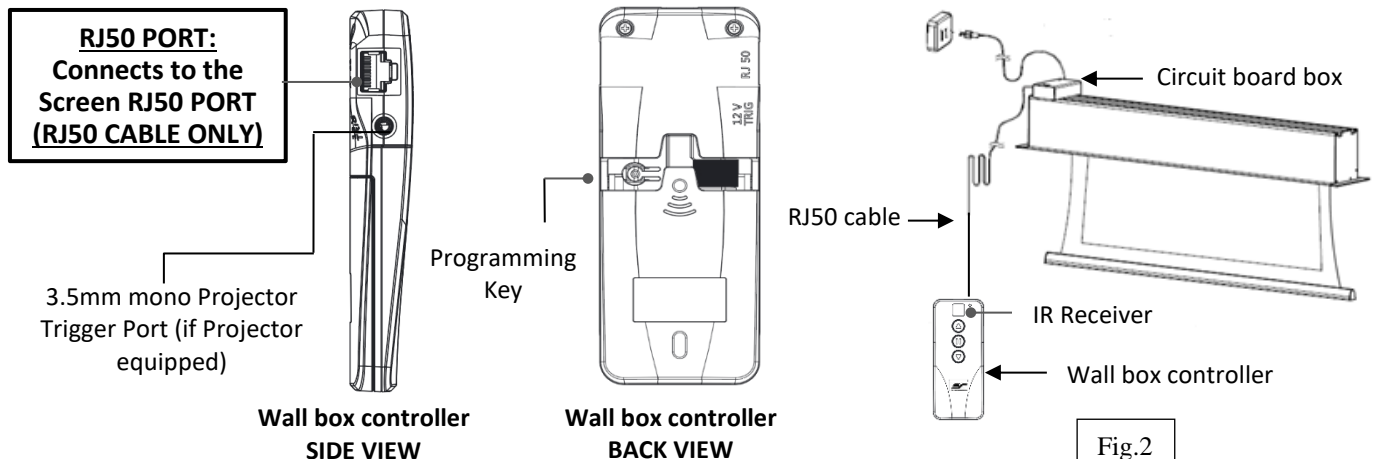

4. Wired 5-12 volt trigger (Fig 3): Requires a 3.5mm to 3.5mm mono cable (not included)

Step 1: Connect one end of the RJ50 cable to the screen and the other end to the Wall box controller.

Step 2: Then connect one end the 3.5mm mono cable to the wall box controller and the other to the projector.

Once the two cables have been connected, the wired trigger feature is ready to synchronize the screen's up/down operation with the projector's power cycle.

- Projector on, screen drops
- Projector off, screen raises

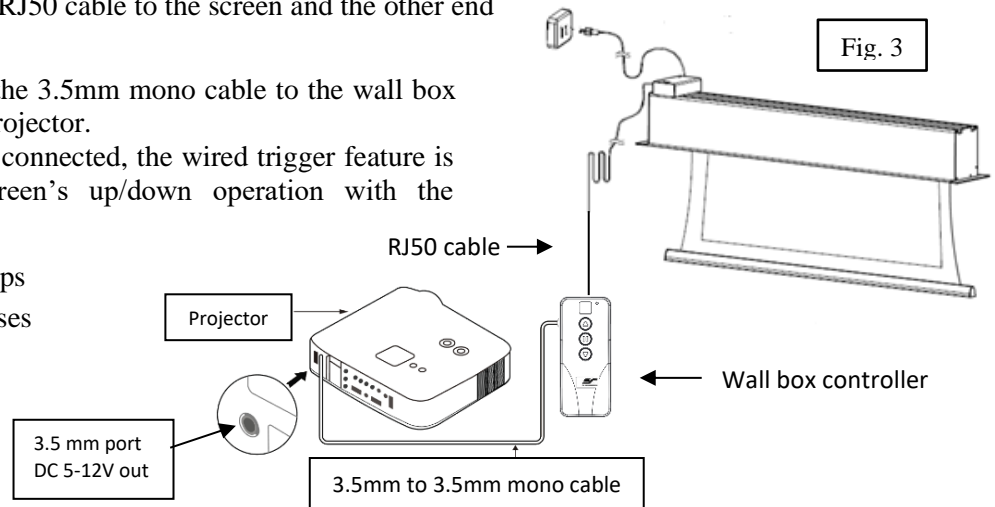

5. Wireless 5-12 volt trigger (Fig 4): Requires a 3.5mm to 3.5mm mono cable (not included).

The Radio Frequency (RF) remote control serves as a dual purpose, independently as a handheld remote control, or as a Wireless 5-12 volt trigger. The radio frequency technology sends a wireless signal that synchronizes the screen's drop & rise with the projector's power cycle.

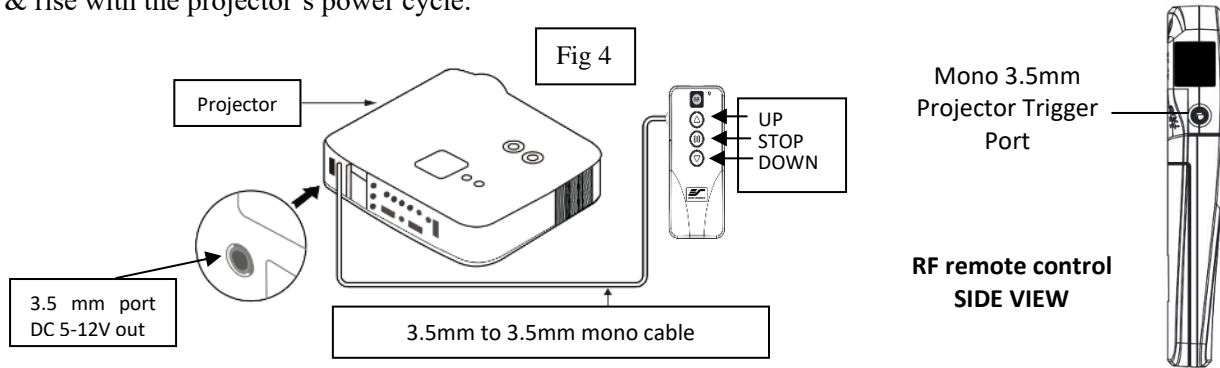

Here's how to set up your Wireless 5-12 volt trigger

The 5-12V wireless trigger should already be synced and ready to work.

Step 1: Connect one end of the 3.5 mm mono trigger cable to the RF remote.

Step 2: Connect the other 3.5 mm mono end of the cable to your projector

Step 3: Turn on the projector and the screen should automatically deploy.

Step 4: Turn off your projector and the screen should automatically retract.

(Please be aware, the projector on/off cycle may take longer to fully activate. It usually takes around 20- 30 seconds for full off and on cycle each time)

Note: If the wireless trigger feature does not work, please resync the RF remote to the Wall box controller per the instructions in the Radio Frequency remote section.

ADVANCED Programming Key Instructions: (FOR ADVANCED USERS ONLY)

* Wall box controller must be connected to the screen.

ATTENTION: Reducing the factory's full screen drop may produce waves/wrinkles on the projection surface on tab-tension screens. The full drop is recommended to allow the screen to rely on the tab-tension system to maintain the projection surface flat and taut on all sides.

The same applies on non-tensioned screens, although some level of waves may be present due to the nature of the screen not being tensioned. If wrinkles/waves develop after making the adjustment to the desired drop position, reset it to the factory's default position per the instructions below.

FLATNESS AFFECTED BY NEW PROGRAMMED VERTICAL POSITION IS NOT COVERED UNDER A REPLACEMENT WARRANTY.

1. Preset the Screen's Drop Position:

Use the RF/IR remote or Wall Box Controller to Drop the screen to the desired position you want to set it at. Press & hold the "Programming Key", then press the "Down key" on the Wall Box Controller. The LED will flash 5 times to confirm new programmed drop position.

PROGRAMMING NOTE:









The programmed vertical position relies on a time-count which adjusts itself according to the programmed timed difference. Multiple up/down programming will result in the vertical position being off a few inches. It is recommended that programming is done the **first-time** the desired vertical position is determined or RESET it to factory default and programming the desired vertical position afterwards.

2. Clear/Reset the Screen's Drop Position to factory default:

Press & hold the "Programming Key + "Stop key" on the wall box controller.

Hardware Parts List for Evanesce Plus Series

Please make sure all parts listed below are included before proceeding with the installation.

A. Hexagonal nut x 4	B. M6x13 hex screw x 8	C. Hanging bracket x 2	D. Washer x 12	E. Turnbuckle x 4	F. Suspension Bar x 4	G. M6 nut x 4	H. End cover flange panel
							

Power

The Evanesce includes a 3-Prong Power Cord for use in a non-concealed power outlet. If your installation will be entirely concealed (including the power outlet), Elite ProAV strongly recommends a hardwire connection. Please refer to the image below for both 110v & 220v wiring information.

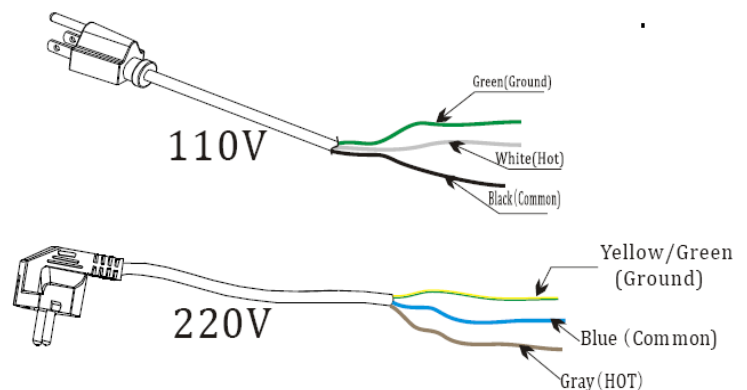

Assembly

1. Insert the **M6x13 hex screw (B)** through the **Hanging Bracket's (C)** screw hole and secure with the **Hexagonal nut (A)**. Slide the **Hanging Bracket (C)** through the railing on top of the case. Repeat the same for the other side.

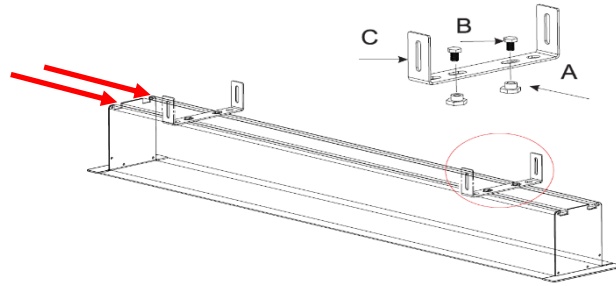

2. Attach the **Turnbuckle (E)** to the bottom of the **Suspension Bar (F)** and secure with the **Hex Screw (B)**, **Washer (D)** and **Hex Nut (H)**.

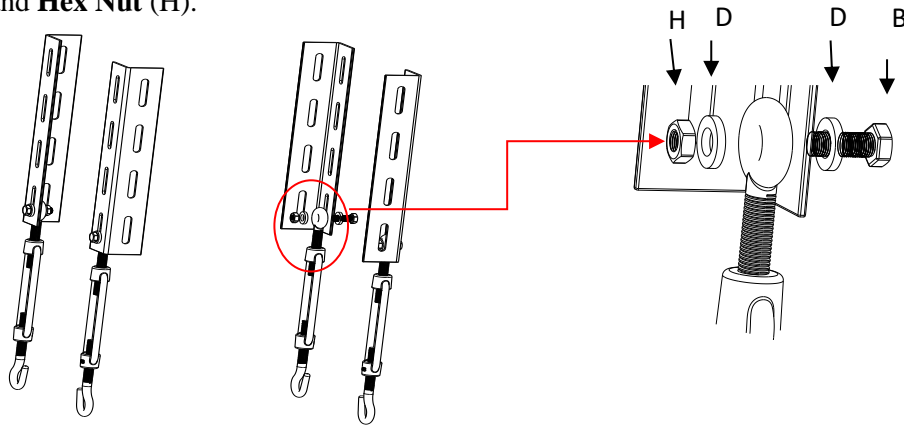

3. Attach the Turnbuckle (G) to the **Hanging Bracket (C)** as shown in figure below. Install the **Suspension Bars (D)** to your ceiling according to their distance.

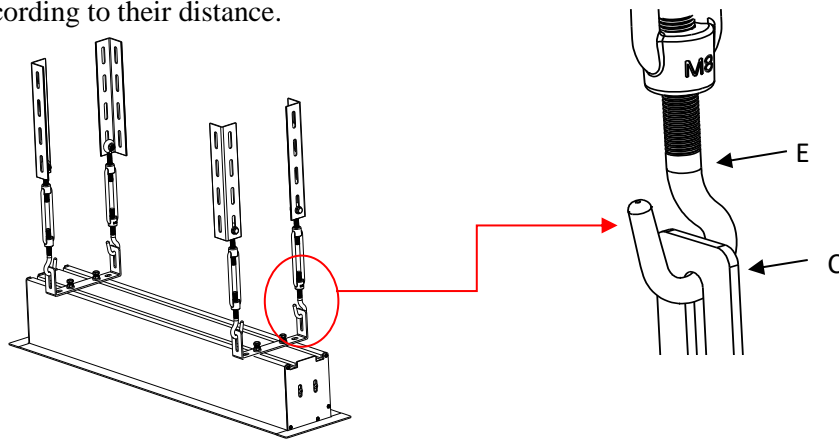

Rotate the turnbuckle as needed to adjust the height level.

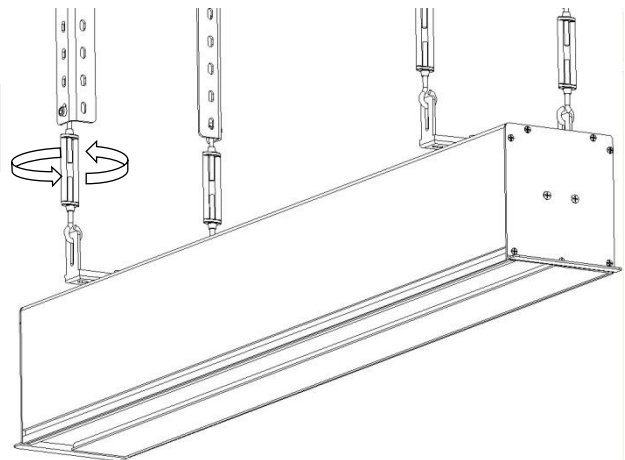

4. Attach the **end flange piece (C)** on the long edge of the housing as shown below to complete the assembly. The screen is now ready for installation.

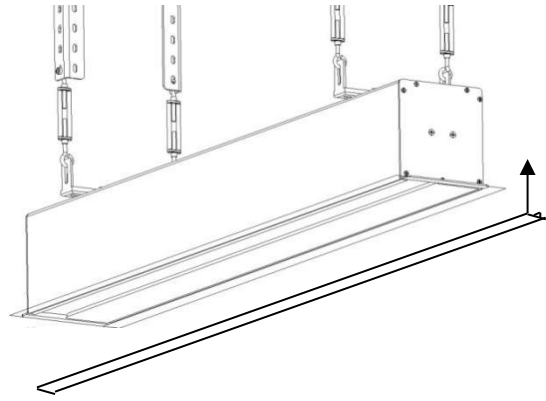

Side view diagram:

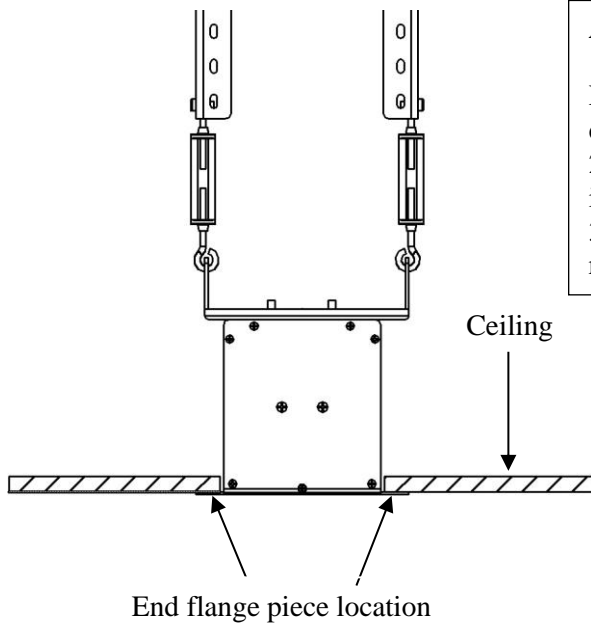
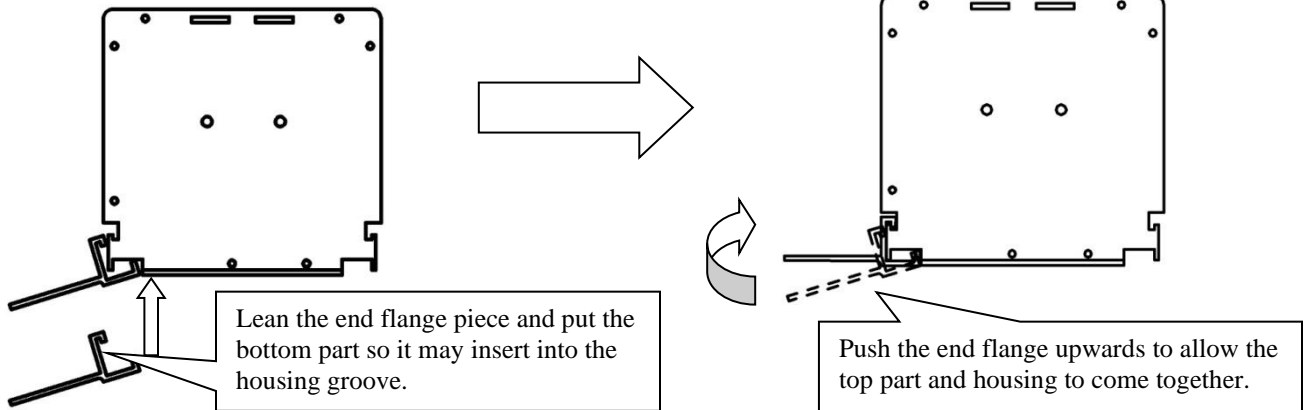

Attention:

1. The end flange panels can easily warp. Please be careful when handling them and during installation.
2. Make sure the end flanges are properly installed and leveled with the housing.
3. As a safety precaution four people are required for this installation.

For local Elite ProAV contact or Technical Support, please visit www.eliteproav.com