



User Guide

SUMMARY

This guide provides information about components, network connection, power management, security, backing up, and more.

Legal information

© Copyright 2022 HP Development Company, L.P.

Microsoft and Windows are either registered trademarks or trademarks of Microsoft Corporation in the United States and/or other countries. The microSD logo and microSD are trademarks of SD-3C LLC. USB Type-C and USB-C are registered trademarks of USB Implementers Forum.

The information contained herein is subject to change without notice. The only warranties for HP products and services are set forth in the express warranty statements accompanying such products and services. Nothing herein should be construed as constituting an additional warranty. HP shall not be liable for technical or editorial errors or omissions contained herein.

Second Edition: November 2022

First Edition: October 2022

Document Part Number: N25492-002

Product Notice

This guide describes features that are common to most products. Some features may not be available on your computer.

Not all features are available in all editions or versions of Windows. Systems may require upgraded and/or separately purchased hardware, drivers, software or BIOS update to take full advantage of Windows functionality. Windows is automatically updated, which is always enabled. High-speed internet and Microsoft account required. ISP fees may apply and additional requirements may apply over time for updates. See <http://www.windows.com>. **If your product ships with Windows in S Mode:** Windows in S Mode works exclusively with apps from the Microsoft Store within Windows. Certain default settings, features, and apps cannot be changed. Some accessories and apps that are compatible with Windows may not work (including some antivirus, PDF writers, driver utilities, and accessibility apps), and performance may vary, even if you switch out of S Mode. If you switch to Windows, you cannot switch back to S Mode. Learn more at [Windows.com/SmodeFAQ](https://www.windows.com/SmodeFAQ).

To access the latest user guides, go to <http://www.hp.com/support>, and follow the instructions to find your product. Then select **Manuals**.

Software terms

By installing, copying, downloading, or otherwise using any software product preinstalled on this computer, you agree to be bound by the terms of the HP End User License Agreement (EULA). If you do not accept these license terms, your sole remedy is to return the entire unused product (hardware and software) within 14 days for a full refund subject to the refund policy of your seller.

For any further information or to request a full refund of the price of the computer, please contact your seller.

About this guide

This guide provides basic information for using and upgrading this product.





-
-  **WARNING!** Indicates a hazardous situation that, if not avoided, **could** result in serious injury or death.
 -  **CAUTION:** Indicates a hazardous situation that, if not avoided, **could** result in minor or moderate injury.
 -  **IMPORTANT:** Indicates information considered important but not hazard-related (for example, messages related to property damage). Warns the user that failure to follow a procedure exactly as described could result in loss of data or in damage to hardware or software. Also contains essential information to explain a concept or to complete a task.
 -  **NOTE:** Contains additional information to emphasize or supplement important points of the main text.
 -  **TIP:** Provides helpful hints for completing a task.
-

Table of contents

1	Locating HP resources	1
	Product information	1
	Support	1
	Product documentation	2
	Product diagnostics	2
	Product updates	3
2	Computer features	4
	Standard features	4
	Mobile head unit features	6
	Integrated features	7
	Docking stand	7
	Basic I/O connectivity base components	8
	Advanced I/O connectivity base components	8
	Multicharger components	9
	Connecting an AC adapter to power	9
	Locating the mobile system power button	10
	Locating the I/O connectivity base power button	10
	Adjusting the mobile head unit	11
	Mobile system serial number location	11
	I/O connectivity base serial number location	11
	Installing a security cable on the I/O connectivity base	12
	Installing a security cable on the mobile system column	12
3	Hardware setup	13
	Tools needed	13
	Warnings and cautions	13
	Locking and releasing the mobile head unit	13
	Attaching the mobile head unit to the dock	14
	Removing the mobile head unit from the dock	14
	Attaching an I/O connectivity base to the mobile system	15
	Connecting a standalone I/O connectivity base to the mobile system	17
	Configuring the I/O connectivity base powered serial ports	18
	Attaching the standard case to the mobile head unit	19
	Attaching the rugged case to the mobile head unit	20

Mounting the mobile system to a countertop.....	21
Connecting a standalone optional fingerprint reader to the I/O connectivity base	23
Attaching an optional fingerprint reader to the I/O connectivity base.....	24
4 Configuring the software	26
Touch screen calibration.....	26
Configuring optional HP integrated peripheral modules	26
Updating the mobile system	26
Downloading HP Firmware Installer	26
Installing updates	27
5 Computer operating guidelines, routine care, and shipping preparation.....	28
Operating guidelines and routine care	28
Cleaning your computer	28
Removing dirt and debris from your computer.....	29
Cleaning your computer with a disinfectant	29
Shipping preparation	30
6 Specifications	31
Computer specifications	31
Input power	31
7 Electrostatic discharge	32
8 Accessibility.....	33
HP and accessibility	33
Finding the technology tools you need.....	33
The HP commitment.....	33
International Association of Accessibility Professionals (IAAP)	34
Finding the best assistive technology.....	34
Assessing your needs	34
Accessibility for HP products.....	34
Standards and legislation.....	35
Standards.....	35
Mandate 376 – EN 301 549	35
Web Content Accessibility Guidelines (WCAG).....	35
Legislation and regulations.....	35
Useful accessibility resources and links	36
Organizations	36
Educational institutions	36
Other disability resources	36
HP links	37
Contacting support	37
Index	38

1 Locating HP resources

Read this chapter to learn about where to find additional HP resources.

Product information

To locate resources that provide product details, how-to information, and more, use this table.

Table 1-1 Where to find product information

Topic	Location
Technical specifications	To find the QuickSpecs for your product, go to http://www.hp.com/go/quickspecs , and then select the link. Select Search all QuickSpecs , type your model name in the search box, and then select Go .
<i>Regulatory, Safety, and Environmental Notices</i>	See the <i>Regulatory, Safety, and Environmental Notices</i> for product regulatory information. You can also see the Agency/Environmental label. To access this guide: <ul style="list-style-type: none">■ Select the Search icon (select products only) in the taskbar, type HP Documentation in the search box, and then select HP Documentation.
System board	A diagram of the system board is located on the inside of the chassis. Additional information is located in the computer <i>Maintenance and Service Guide</i> on the web at http://www.hp.com/support . Follow the instructions to find your product, and then select Manuals .
Serial number, Agency/Environmental, and operating system labels	The serial number, Agency/Environmental, and operating system labels might be on the bottom of the computer, on the rear panel of the computer, or under the service door.

Support

To locate resources that provide support and warranty information, use this table.

Table 1-2 Where to find support information

Topic	Location
Product support	For HP support, go to http://www.hp.com/support . Here you can access the following types of support: <ul style="list-style-type: none">• Online chat with an HP technician• Support telephone numbers• HP service center locations

Table 1-2 Where to find support information (continued)

Topic	Location
Warranty information	<p>To access this document:</p> <ul style="list-style-type: none">■ Select the Search icon (select products only) in the taskbar, type <code>HP Documentation</code> in the search box, and then select HP Documentation. <p>– or –</p> <ul style="list-style-type: none">■ Go to http://www.hp.com/go/orderdocuments. <p>IMPORTANT: You must be connected to the internet to access the latest version of the warranty.</p> <p>You can find your HP Limited Warranty located with the user guides on your product. The warranty might be on a CD or DVD provided in the box. In some countries or regions, HP might provide a printed warranty in the box. For countries or regions where the warranty is not provided in printed format, you can request a copy from http://www.hp.com/go/orderdocuments. For products purchased in Asia Pacific, you can write to HP at POD, PO Box 161, Kitchener Road Post Office, Singapore 912006. Include your name, phone number, address, and product name.</p>

Product documentation

To locate resources that provide product documentation, use this table.

Table 1-3 Where to find product documentation

Topic	Location
HP user documentation, white papers, and third-party documentation	User documentation is located on your hard drive. Select the Search icon (select products only) in the taskbar, type <code>HP Documentation</code> in the search box, and then select HP Documentation . For the latest online documentation, go to http://www.hp.com/support and follow the instructions to find your product. Then select Manuals . The documentation includes this user guide and the <i>Maintenance and Service Guide</i> .
Product notifications	Subscriber's Choice is an HP program that allows you to sign up to receive driver and software alerts, proactive change notifications (PCNs), the HP newsletter, customer advisories, and more. Sign up at https://h41369.www4.hp.com/ .
Technical specifications	The Product Bulletin application contains QuickSpecs for HP computers. QuickSpecs include information about the operating system, power supply, memory, processor, and many other system components. To access the QuickSpecs, go to http://www.hp.com/go/quickspecs/ .
Bulletins and Notices	<p>To find advisories, bulletins, and notices:</p> <ol style="list-style-type: none">1. Go to http://www.hp.com/support.2. Follow the instructions to find your product.3. Select Advisories or Bulletins and Notices.

Product diagnostics

To locate resources that provide product diagnostics tools, use this table.

Table 1-4 Where to find diagnostics tools

Topic	Location
Diagnostics tools	For additional information, see the computer <i>Maintenance and Service Guide</i> at http://www.hp.com/support . Follow the instructions to find your product, and then select Manuals .
Audible beep and light code definitions	See the computer <i>Maintenance and Service Guide</i> at http://www.hp.com/support . Follow the instructions to find your product, and then select Manuals .
POST error codes	See the computer <i>Maintenance and Service Guide</i> at http://www.hp.com/support . Follow the instructions to find your product, and then select Manuals .

Product updates

To locate resources that provide product updates, use this table.

Table 1-5 Where to find product updates

Topic	Location
Driver and BIOS updates	Go to http://www.hp.com/support and select Software and Drivers to verify that you have the latest drivers for the computer.
Operating systems	For information about Windows® operating systems, go to http://www.support.microsoft.com .

2 Computer features

This chapter provides you with an overview of your computer's features.

Standard features

To identify a typical computer configuration, read this section. Features vary depending on the model.

Mobile system with grip



Connecting system with grip



The HP Engage Go 10 is designed for long-term deployment within general retail, hospitality, and other markets. It includes the following features:

- Integrated connecting form factor available in mobile and connecting systems, both with a grip.
- **34.3 cm (13.5 in)** display panel; high definition (1800 × 1200) resolution, 340 nit, multitouch, Corning Gorilla Glass 5

- Docking stand
- Major integrated peripherals:
 - Barcode scanner with integrated audio/video feedback and trigger button (configurable as upward facing or downward facing)
 - Optional fingerprint reader
 - NFC authentication
 - Optional contactless payment card scanner (available in the US only)
 - Multicharge (only available for mobile system with grip version)
- Basic I/O connectivity base
 - Three powered serial ports (0 V, 5 V, 12 V)
 - Four USB 2.0 ports
 - Two USB SuperSpeed 5 Gbps ports
 - RJ-11 (modem) jack
 - RJ-45 (network) jack
 - Video-out USB Type-C® port
 - USB Type-C power connector
 - Security cable slot
 - microSD card reader
 - Audio-out (headset) jack
 - Power connector
- Advanced I/O connectivity base
 - Two powered serial ports (0 V, 5 V, 12 V)
 - Two 12 V powered USB ports
 - 24 V powered USB port
 - Four USB SuperSpeed 5 Gbps ports
 - RJ-11 (cash drawer) jack
 - RJ-45 (network) jack
 - Video-out USB Type-C port
 - USB Type-C power port
 - Security cable slot
 - microSD card reader

- Audio-out (headset) jack
- Power connector

Mobile head unit features

To identify the mobile head unit features, use this illustration and table.

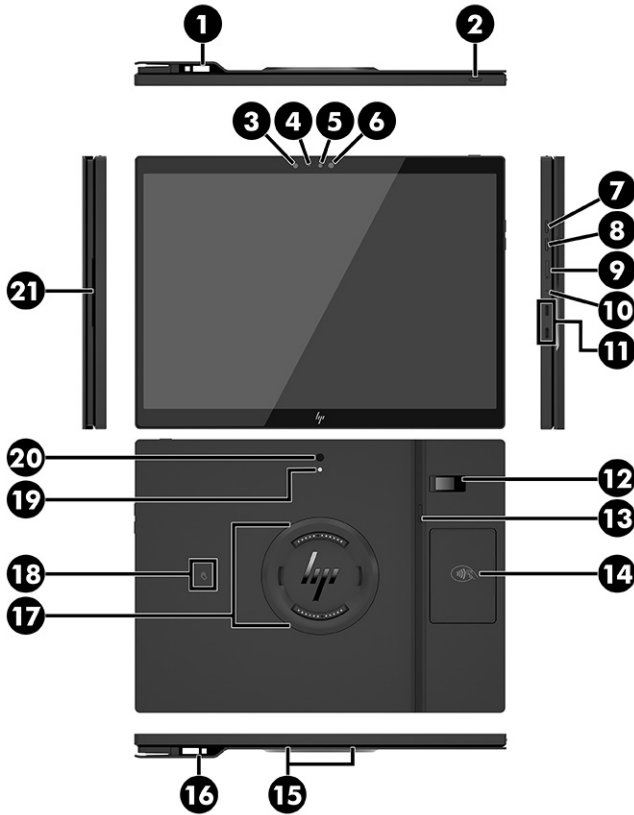

Table 2-1 Identifying the mobile head unit features

Features			
1	Upward-facing laser barcode scanner* (optional)	12	Fingerprint reader (optional)
2	Power button	13	Barcode scanner button (optional)
3	Ambient light sensor	14	Contactless payment card scanner (optional)**
4	Camera light	15	Microphones (2)
5	Camera	16	Downward-facing laser barcode scanner* (optional)
6	Infrared light	17	Docking connector (optional)
7	Volume up button	18	Near-field communication (NFC)
8	Volume down button	19	Rear-facing camera light
9	SIM card slot (optional)	20	Rear-facing camera
10	Charging LED	21	Payment card slot (optional)**
11	USB Type-C ports (2)		

Table 2-1 Identifying the mobile head unit features (continued)

Features
* The barcode scanner button is always active when the computer is docked or undocked.
**Only available in the US.

Integrated features

To identify the computer features, use this illustration and table.

 **NOTE:** The integrated devices shown are optional.



Table 2-2 Identifying the integrated features

Features		
1	34.3 cm (13.5 in), 1800 × 1200, high definition display	4 Mobile case
2	Docking release button	5 Biometric fingerprint reader (optional)
3	I/O connectivity base	

Docking stand

You can use the mobile system with the docking stand.

 **NOTE:** You can use the docking stand only with convertible models.



Basic I/O connectivity base components

To identify the basic I/O connectivity base features, use this illustration and table.



Table 2-3 Identifying the basic I/O connectivity base features

Features	
1	RJ-11 (modem) jack
2	Power connector
3	USB Type-C® powered port
4	Powered serial ports (3)
5	USB 2.0 ports (4)
6	USB SuperSpeed 5 Gbps ports (2)
7	USB Type-C port
8	RJ-45 (network) jack
9	Security cable slot
10	microSD™ card reader (select products only)
11	Headset jack

IMPORTANT: To avoid damage to the computer, **do not** plug a telephone cable into the modem jack.

Advanced I/O connectivity base components

To identify the advanced I/O connectivity base features, use this illustration and table.

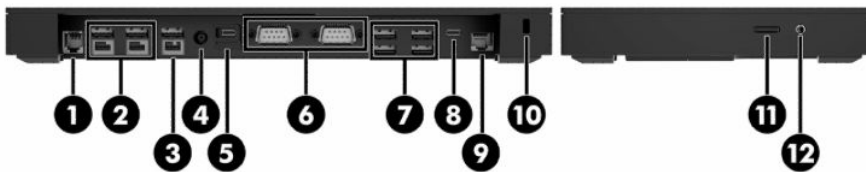

Table 2-4 Advanced I/O connectivity base features

Features	
1	RJ-11 (modem) jack
2	Powered USB 12 V ports (2)
3	Powered USB 24 V port
4	Power connector
5	USB Type-C powered port
6	Powered serial ports (2)
7	USB SuperSpeed 5 Gbps ports (4)
8	USB Type-C port
9	RJ-45 (network) jack
10	Security cable slot
11	microSD card reader (select products only)
12	Headset jack

IMPORTANT: To avoid damage to the computer, **do not** plug a telephone cable into the modem jack.

Multicharger components

You can charge up to four mobile head units in the multicharger. To identify charger features, use this illustration and table.

 **NOTE:** You can use the multicharger only with grip models, whether mobile or convertible systems.



Table 2-5 Identifying the multicharger features

Features			
1	Locking dial	4	Power light
2	RJ-45 (network) jack	5	Power connector
3	Power switch	6	Security cable slot

Connecting an AC adapter to power

To connect an AC adapter to the I/O connectivity base, use this procedure and illustration.

- To connect an AC adapter to the I/O connectivity base, connect one end of the power cord to the AC adapter (1) and the other end to a grounded AC outlet (2), and then connect the AC adapter to the power connector on the I/O connectivity base (3).

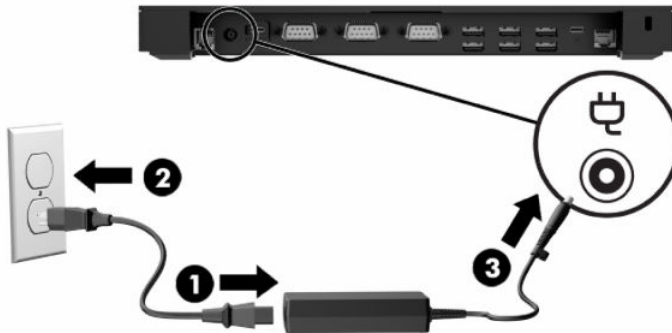

- To connect an AC adapter to the mobile system when it is not connected to an I/O connectivity base, connect the AC adapter to a grounded AC outlet (1), and then connect the power adapter's USB Type-C connector to the USB Type-C power port on the underside of the stand or stability base (2).

 **NOTE:** The power light illuminates when a valid AC adapter is used. If an invalid AC adapter is used, the light does not turn on, even if the adapter is plugged into a wall socket.

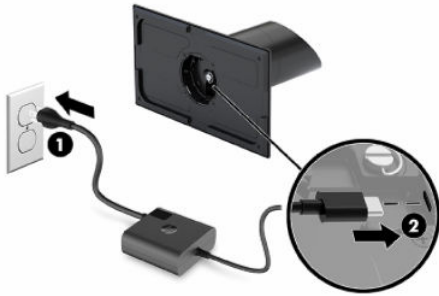

Locating the mobile system power button

The computer power button is located on the top-right edge of the bezel.



Locating the I/O connectivity base power button

The power button is located on the underside of the I/O connectivity base.

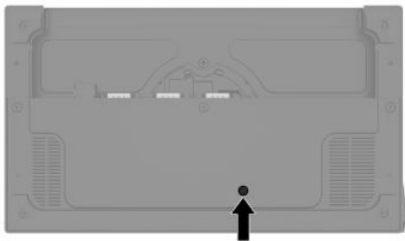

The head unit controls the I/O connectivity base. When the head unit is turned off, the I/O connectivity base is turned off, and power is not available from the I/O connectivity base ports. The exception is the I/O connectivity base USB port that connects to the head unit. That port remains powered so that it can continue to communicate with the head unit and allow the I/O connectivity base to turn back on when the head unit is turned on.

After the system is turned off, you can press the power button on the underside of the I/O connectivity base to allow power to be available on the I/O connectivity base ports while the head unit remains turned off.

Adjusting the mobile head unit

You can tilt the mobile head unit by as much as 10° when you set the angle between 50° and 60°.



You can swivel the mobile head unit 180° in either direction.



Mobile system serial number location

Each computer has a unique serial number and a product ID number that are located on the exterior of the computer. Keep these numbers available when you contact customer service for assistance.



I/O connectivity base serial number location

Each I/O connectivity base has a unique serial number and a product ID number that is located on the exterior of the base. Keep these numbers available when you contact customer service for assistance.

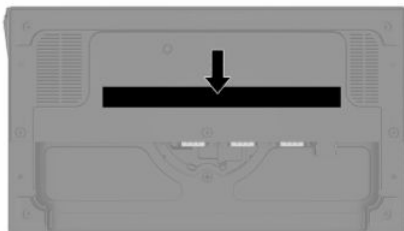

Regulatory information is located in the base plate or wall mount. To see this information, you must disassemble the base plate or wall mount. Be sure to install the base plate or wall mount back after disassembly.

Installing a security cable on the I/O connectivity base

You can secure the I/O connectivity base to a fixed object with an optional keyed security cable lock and an optional security cable available from HP.

 **NOTE:** The security cable is sold separately as an aftermarket option kit only.

1. Locate the security cable slot on the back of the I/O connectivity base.
2. Insert the security cable lock into the slot, and then use the key to lock it.

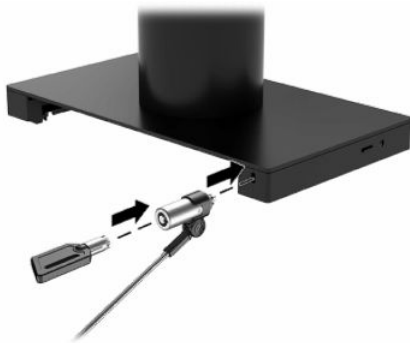

Installing a security cable on the mobile system column

You can secure the I/O connectivity base to a fixed object with an optional security cable and an optional security cable lock available from HP.

 **NOTE:** The security cable lock and security cable are sold separately as an aftermarket option kit only.

1. Remove the screw from the bottom of the column **(1)**.
2. Attach the security cable lock to the bottom of the column using the tamper-resistant screw **(2)** included with the security cable extension.
3. Secure the other end of the security cable lock with a security cable **(3)**, and then lock it in place with the key.

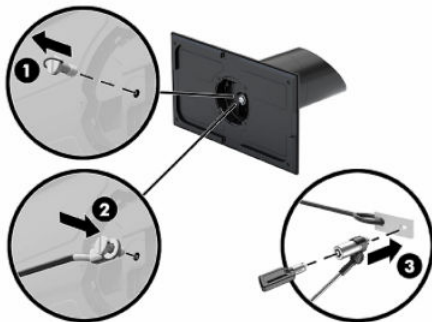

3 Hardware setup

Use these sections to set up and configure your mobile system.

Tools needed

You need a Phillips screwdriver and a Torx T15 screwdriver to complete the procedures described in this guide.

Warnings and cautions

Before performing upgrades, be sure to carefully read all of the applicable instructions, cautions, and warnings in this guide.

-
-  **WARNING!** To reduce the risk of personal injury from electric shock, hot surfaces, or fire:
- Disconnect the power cord from the AC outlet before removing the enclosure. Energized parts are inside.
 - Allow the internal system components to cool before you touch them.
 - Replace and secure the enclosure before restoring power to the equipment.
 - Do not connect telecommunications or telephone connectors to the network interface controller (NIC) receptacles.
 - Do not disable the power cord grounding plug. The grounding plug is an important safety feature.
 - Plug the power cord in a grounded (earthed) AC outlet that is easily accessible at all times.

For your safety, do not place anything on power cords or cables. Arrange them so that no one can accidentally step on or trip over them. Do not pull on a cord or cable. When unplugging from the AC outlet, grasp the cord by the plug.

To reduce the risk of serious injury, read the *Safety & Comfort Guide*. It describes proper workstation setup and provides guidelines for posture and work habits that increase your comfort and decrease your risk of injury. It also provides electrical and mechanical safety information. This guide is located on the web at <http://www.hp.com/ergo>.

-  **IMPORTANT:** Static electricity can damage the electrical components of the computer or optional equipment. Before beginning these procedures, be sure that you are discharged of static electricity by briefly touching a grounded metal object.

When the computer is plugged into an AC power source, voltage is always applied to the system board. You must disconnect the power cord from the power source and wait 30 seconds before opening the computer to prevent damage to internal components.

Locking and releasing the mobile head unit

The mobile head unit automatically locks to the dock when attached. To release the mobile head unit, press the lock release button on the front of the dock's column.

You can use two authentication methods to release the mobile head unit. Set up the authentication methods using the HP SureLock wizard.

- Windows® user authentication: You can define a group that allows users to release the mobile head unit based on their Windows login password.
- PIN authentication: A PIN is required to release the mobile head unit.

 **NOTE:** You can require one, both, or no authentication method to release the mobile head unit. The default setting requires no authentication.

The light on the dock lock release button indicates the locking status.

- Amber: The mobile head unit is locked and cannot be released without the proper Windows login permission.
- White: The mobile head unit is locked and might require a PIN to release it.
- Green: The mobile head unit is not locked and can be removed.

Attaching the mobile head unit to the dock

To attach the mobile head unit to the dock, use this procedure and illustration.

To attach the mobile head unit to the dock:

- Align the rear of the mobile head unit with the top of the dock's column, and place the mobile head unit onto the dock. The mobile head unit automatically locks to the dock when attached.



Removing the mobile head unit from the dock

To remove the mobile head unit from the dock, use this procedure and illustration.

 **NOTE:** Your system might require a PIN to unlock the mobile head unit from the dock. See [Locking and releasing the mobile head unit on page 13](#).

To remove the mobile head unit from the dock:

- Press the lock release button (1) on the front of the dock's column, and then lift the mobile head unit (2) off the dock.



Attaching an I/O connectivity base to the mobile system

You can attach an I/O connectivity base to the bottom of the stand.

To attach an I/O connectivity base:

1. Turn off the mobile system properly through the operating system, and turn off any external devices.
2. Disconnect the power cords from the mobile system and I/O connectivity base.

 **IMPORTANT:** Regardless of the power state, voltage is always present on the system board as long as the system is plugged into an active AC outlet. You must disconnect the power cord and wait approximately 30 seconds for the power to drain to avoid damage to the internal components.

3. Remove the cover from the I/O connectivity base by removing the four screws on the underside of the I/O connectivity base (1) and then lifting the cover off the I/O connectivity base (2).

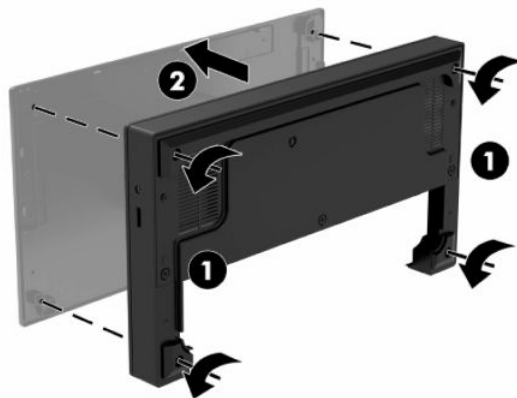

4. Connect the USB Type-C power cord to the USB Type-C port on the underside of the stand column.

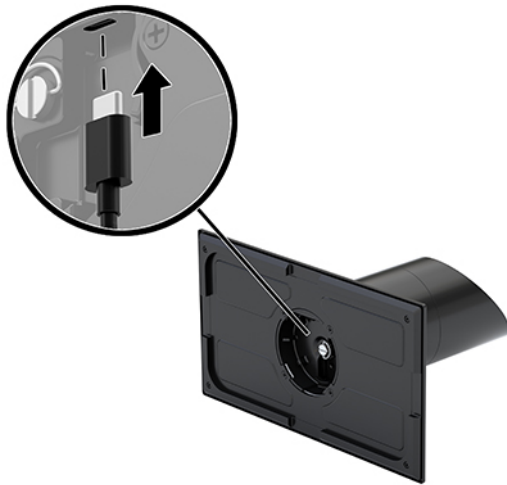

5. Place the I/O connectivity base onto the bottom of the stand (1), and then tighten the four screws on the underside of the I/O connectivity base (2) to secure the I/O connectivity base to the dock. Be sure that the USB Type-C power cable is routed through the gap between the back of the I/O connectivity base and the stand.

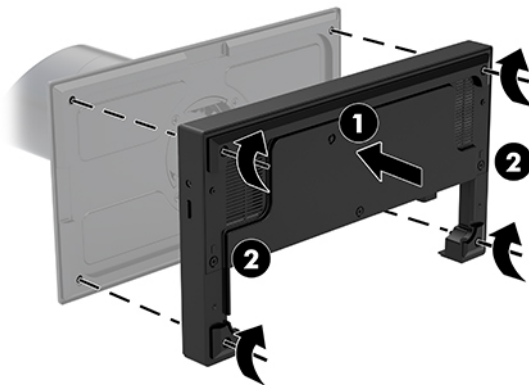

6. To connect and secure the USB Type-C power cable, attach the cable clip to the cable (1), insert the cable tie into the hole (2) below the USB Type-C port on the I/O connectivity base, and then slide the cable clip onto the cable tie and connect the cable to the port (3).

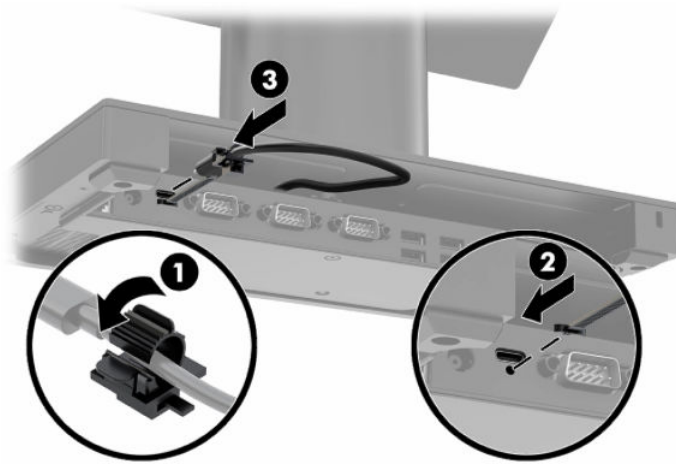

7. Connect the AC adapter to the I/O connectivity base and a grounded AC outlet. See [Connecting an AC adapter to power on page 9](#).

Connecting a standalone I/O connectivity base to the mobile system

You can connect a standalone I/O connectivity base to the mobile system.

To connect a standalone I/O connectivity base:

1. Turn off the mobile system properly through the operating system, and turn off any external devices.
2. Disconnect the power cords from the mobile system and I/O connectivity base.

 **IMPORTANT:** Regardless of the power state, voltage is always present on the system board as long as the system is plugged into an active AC outlet. You must disconnect the power cord and wait approximately 30 seconds for the power to drain to avoid damage to the internal components.

3. Connect the USB Type-C power cable to the USB Type-C port on the underside of the stand's column and to the USB Type-C power port on the I/O connectivity base.

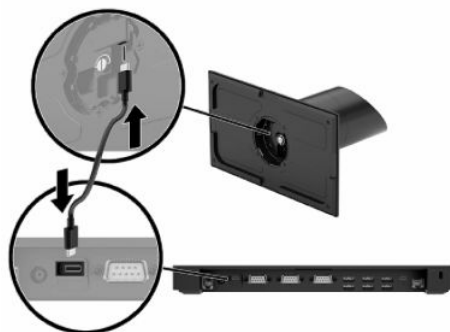

4. Connect the AC adapter to the I/O connectivity base and a grounded AC outlet. See [Connecting an AC adapter to power on page 9](#).

Configuring the I/O connectivity base powered serial ports

You can configure the serial ports as standard (unpowered) serial ports or powered serial ports. Some devices use a powered serial port. If the serial port is configured as a powered port, devices that support a powered serial interface do not require an external power source.

 **IMPORTANT:** The system must be turned off before connecting or disconnecting serial port devices.

 **NOTE:** The I/O connectivity base ships with all serial ports configured in standard unpowered serial mode (0 volts) by default.

Each serial port has three voltage settings.

- 0 volts
- 5 volts
- 12 volts

To change the voltage settings for a powered serial port:

1. Turn off the mobile system properly through the operating system, and turn off any external devices.
2. Disconnect the power cord.

 **NOTE:** Regardless of the power state, voltage is always present on the system board as long as the system is plugged into an active AC outlet. You must disconnect the power cord and wait approximately 30 seconds for the power to drain to avoid damage to the internal components of the computer.

3. Remove the five screws on the underside of the I/O connectivity base (1) that secure the bottom plate to the I/O connectivity base, and then remove the bottom plate from the I/O connectivity base (2).

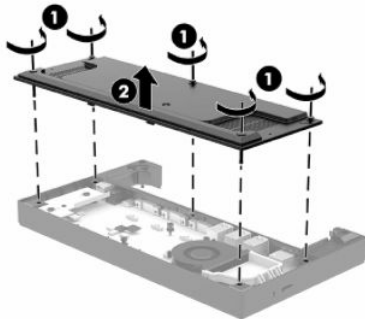

4. Adjust the voltage select switch behind each serial port to the setting that you want.

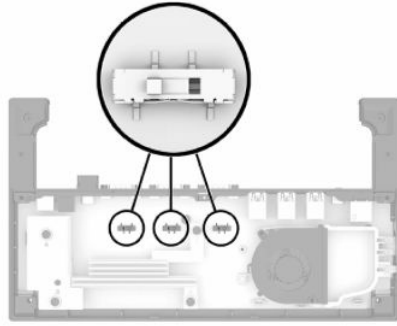

5. Place the bottom plate onto the I/O connectivity base (1), and then secure the plate to the I/O connectivity base with the five screws (2).

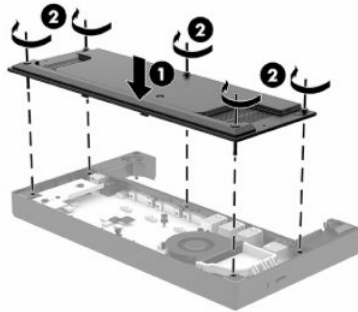

6. Reconnect the I/O connectivity base power cord and peripheral devices.

Attaching the standard case to the mobile head unit

You can help protect your mobile head unit from accidental drops and bumps with the optional standard case. You can also attach a shoulder strap to the case for hands-free use.

To attach the case:

1. Remove the mobile head unit from the dock if it is attached.

 **NOTE:** The case ships with a filler piece. Remove the piece for installation onto models with a payment bump.

- Slide the payment bump side of the mobile head unit into the case (1), rotate the unit down into the case (2), and then securely snap the lip of the case around the unit (3).

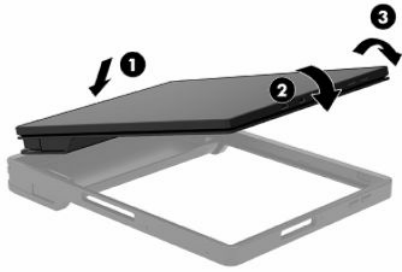

- If your mobile head unit includes a fingerprint reader, remove the fingerprint reader insert from the case.

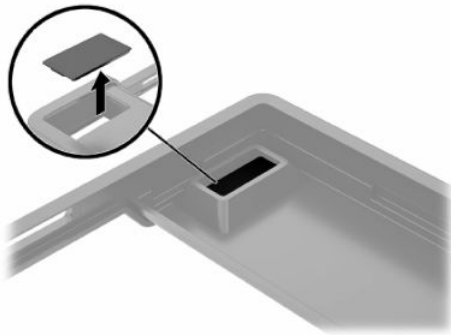

Attaching the rugged case to the mobile head unit

You can help protect your mobile head unit from accidental drops and bumps with the optional rugged case. You can also attach a shoulder strap to the case for hands-free use.

 **NOTE:** You can only use the rugged case with mobile system with grip models and convertible system with grip models.

To attach the case:

- Remove the mobile head unit from the dock if it is attached.
- Slide the payment bump side of the mobile head unit into the case (1), rotate the unit down into the case (2), and then securely snap the lip of the case around the unit (3).

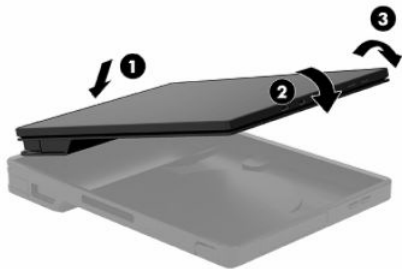

Mounting the mobile system to a countertop

You can use an optional countertop mounting bracket to mount the computer head unit and column to a countertop.

 **NOTE:** The mounting bracket requires an 80 mm (3 in) hole in the countertop. The thickness of the countertop must be 10 mm (0.4 in) to 50 mm (2 in).

To mount the mobile system:

1. If the dock's stability base is attached to the column, remove the screw on the underside of the column (1), and then remove the base (2) from the column.

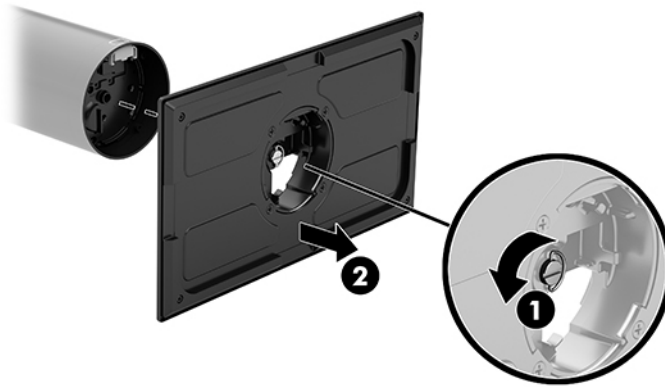

2. Route the cables through the routing hole on the top piece of the mounting bracket (1) and attach the cables to the bottom of the column (2).

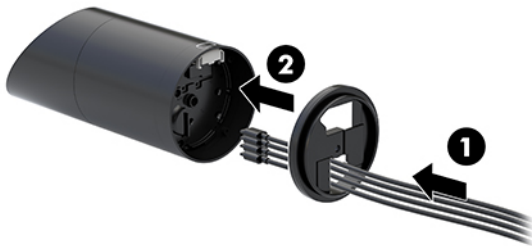

3. Hold the top piece of the mounting bracket against the bottom of the column, route the cables through the hole in the mounting surface, and then place the column over the hole on the mounting surface.

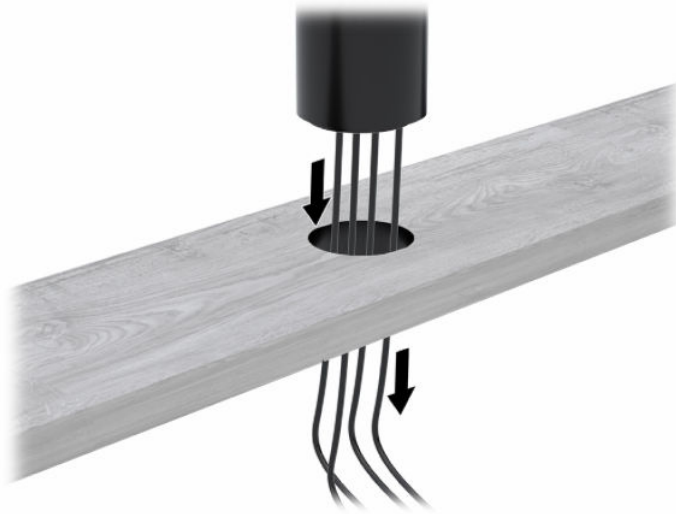

4. The bottom piece of the mounting bracket can be oriented in two ways, depending on the thickness of your mounting surface. Orient the bracket properly for your application before attaching it.

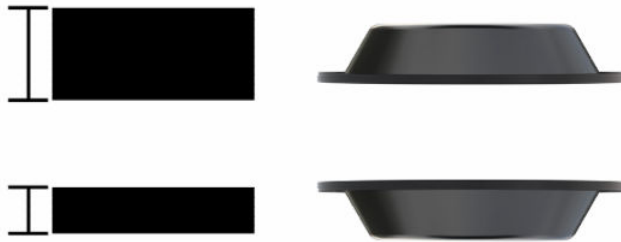

5. Route the cables through the hole in the bottom piece of the mounting bracket (1). Press the mounting bracket against the bottom of the mounting surface (2), and then insert the screw (3) through the mounting bracket. Tighten the screw (4) so that the screw is fully inserted into the column, and then tighten the wing nut (5) on the screw to fasten the bracket to the mounting surface.

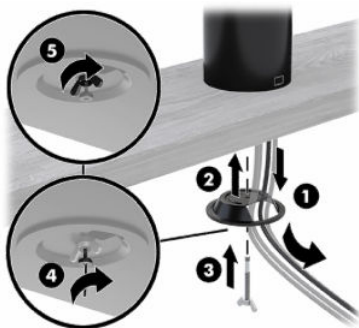

Connecting a standalone optional fingerprint reader to the I/O connectivity base

You can use the optional fingerprint reader as a standalone device, or you can attach it to the I/O connectivity base.

To connect a standalone optional fingerprint reader to the I/O connectivity base:

1. Turn off the mobile system properly through the operating system, and turn off any external devices.
2. Disconnect the power cords from the mobile system and I/O connectivity base.

 **IMPORTANT:** Regardless of the power state, voltage is always present on the system board as long as the system is plugged into an active AC outlet. You must disconnect the power cord and wait approximately 30 seconds for the power to drain to avoid damage to the internal components.

3. Connect the USB cable to the fingerprint reader (1), and route the cable through the routing channel (2) on the fingerprint reader.

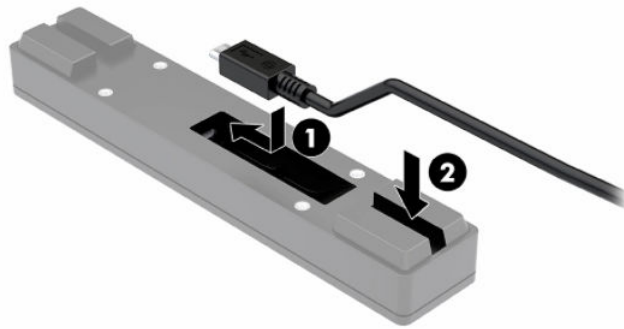

4. Connect the fingerprint reader USB cable to a USB Type-A port on the I/O connectivity base.

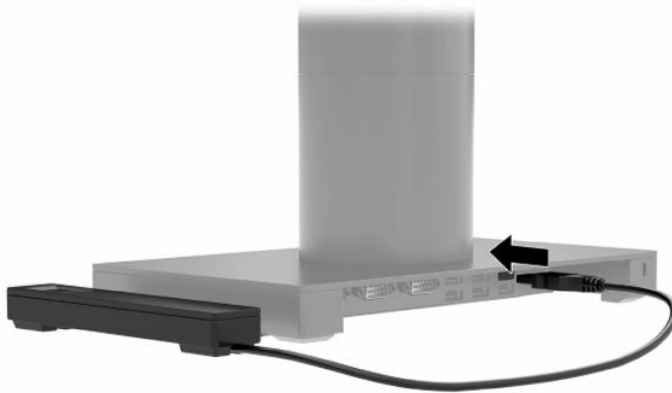

5. Reconnect the I/O connectivity base and power cords.

Attaching an optional fingerprint reader to the I/O connectivity base

You can use the optional fingerprint reader as a standalone device, or you can attach it to the I/O connectivity base.

To connect an optional fingerprint reader to the I/O connectivity base.

 **NOTE:** You can attach the fingerprint reader to either side of the I/O connectivity base, but if you attach it to the left side of the I/O connectivity base, the fingerprint reader covers the microSD slot and the headset jack on the I/O connectivity base.

1. Turn off the mobile system properly through the operating system, and turn off any external devices.
2. Disconnect the power cords from the mobile system and I/O connectivity base.

 **IMPORTANT:** Regardless of the power state, voltage is always present on the system board as long as the system is plugged into an active AC outlet. You must disconnect the power cord and wait approximately 30 seconds for the power to drain to avoid damage to the internal components.

3. Place the fingerprint reader (1) on the riser (2), and then attach the mounting bracket (3) and cable routing clip (4) to the fingerprint reader and riser with the two long screws (5) that are included with the fingerprint reader.

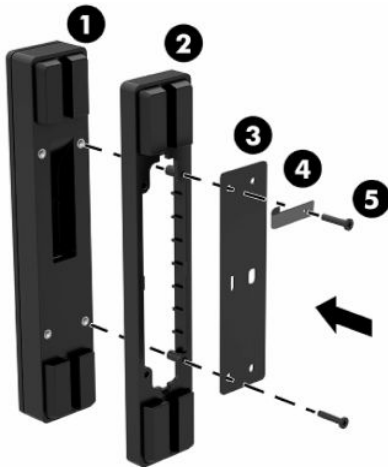

4. Connect the USB cable to the fingerprint reader (1) and route the cable under the routing clip on the fingerprint reader (2). Remove the mounting screw (3) from the underside of the I/O connectivity base,

and then attach the bracket on the fingerprint reader assembly to the underside of the I/O connectivity base (4) using the screw that was removed from the base and the short screw included in the kit.

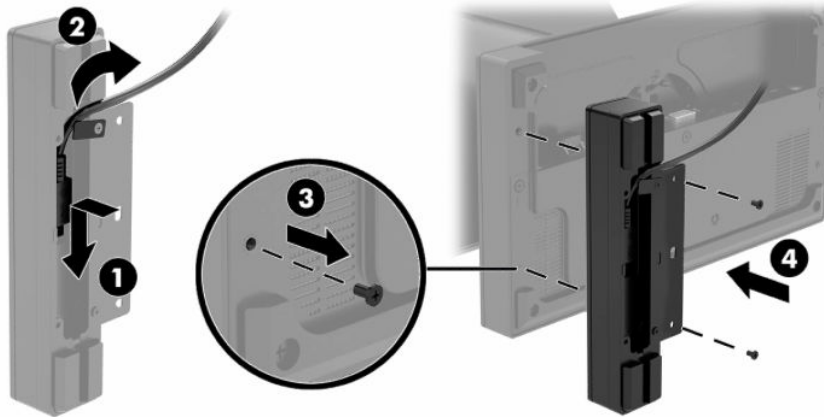

5. Connect the fingerprint reader cable to a USB Type-A port on the I/O connectivity base.

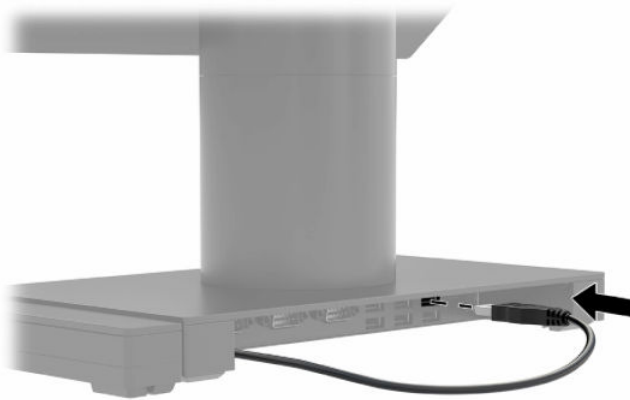

6. Reconnect the I/O connectivity base and power cords.

4 Configuring the software

You can configure the computer and integrated peripherals and calibrate the touch screen.

Touch screen calibration

The Windows calibration tool works only in digitizer touch mode. If you install a retail touch utility, it sets the touch screen to POS mode (mouse mode) by default and does not allow the Windows calibration tool to run.

To calibrate the touch module:

1. Select the Search icon (select products only) in the taskbar, type `Control Panel`, and then select **Control Panel**.
2. Type `calibrate` in the Search box. Under **Tablet PC Settings**, tap the **Calibrate the screen for pen or touch input** link. In the Tablet PC Settings dialog box, tap the **Calibrate** button.
3. Follow the on-screen instructions to press the target marks on the touch screen. At the end of the calibration process, the touch module should be aligned with the video, and the touch points will be accurate.

Configuring optional HP integrated peripheral modules

Use this information to configure peripheral modules.

To configure the integrated USB peripheral, see the HP Point of Sale Configuration Guide (available in English only). The guide is located with the documentation on your retail computer and at <http://www.hp.com/support>. To access the guide on the retail computer, select **Start**, and then select **HP Point of Sale Information**.



NOTE: Check <http://www.hp.com/support> for updated software or documentation that became available between the time your product was manufactured and the time it was delivered to you.

Updating the mobile system

Use these sections to update the mobile system.

Downloading HP Firmware Installer

Use these steps to download the firmware installation app.

1. Go to <http://www.hp.com/support>.
2. Select **Software and Drivers**, and follow the on-screen instructions to find your docking station.
3. Follow the on-screen instructions to select and download **HP Firmware Installer**.
4. Complete the installation wizard.
5. Choose to restart now or later. The computer might not work until the next restart. Select **Finish**.

Installing updates

You can update the mobile system immediately or the next time it is shut down.

To install updates:

1. Open Windows Explorer, and navigate to where you saved HP Firmware Installer.
2. Double-click **HPFirmwareInstaller.exe**, and then select **OK**.
3. Verify that updates are available, select which updates to install, and then select **Install**.



TIP: You must be connected to the internet for new updates to download to HP Firmware Installer.

4. Select one of the following options:

- **Shut down now:** Installs the update immediately.



NOTE: You might see the display flicker and hear some audio clicks, your internet connection might be intermittent, and your mouse and keyboard could become unresponsive until installation is complete.

- **Close and shut down later:** Installs the update the next time you shut down the computer.

The computer turns on automatically after the firmware update is complete.

5 Computer operating guidelines, routine care, and shipping preparation

Follow these guidelines to ensure the best performance and useful life of your computer.

Operating guidelines and routine care

HP has developed guidelines to help you properly set up and care for the computer and monitor.

- Keep the computer away from excessive moisture, direct sunlight, and extreme heat and cold.
- Operate the computer on a sturdy, level surface. Leave a 10.2 cm (4 inch) clearance on all vented sides of the computer and above the monitor to permit the required airflow.
- Never restrict the airflow into the computer by blocking any vents or air intakes. Do not place the keyboard, with the keyboard feet down, directly against the front of the desktop unit because this also restricts airflow.
- Never operate the computer with the access panel or any of the expansion card slot covers removed.
- Do not stack computers on top of each other or place computers so near each other that they are subject to each other's recirculated or preheated air.
- To operate a computer within a separate enclosure, intake and exhaust ventilation must be provided on the enclosure, and the previous operating guidelines still apply.
- Keep liquids away from the computer and keyboard.
- Never cover the ventilation slots on the monitor with any type of material.
- Install or enable power management functions of the operating system or other software, including sleep states.
- Turn off the computer before you do either of the following tasks:
 - Wipe the exterior of the computer with a soft, damp cloth as needed. Cleaning products might discolor or damage the finish. See [Removing dirt and debris from your computer on page 29](#) for the recommended steps to clean the high-touch, external surfaces on your computer. After you remove the dirt and debris, you can also clean the surfaces with a disinfectant. See [Cleaning your computer with a disinfectant on page 29](#) for guidelines to help prevent the spread of harmful bacteria and viruses.
 - Occasionally clean the air vents on all vented sides of the computer. Lint, dust, and other foreign matter can block the vents and limit the airflow.

Cleaning your computer

Cleaning your computer regularly removes dirt and debris so that your device continues to operate at its best. Use the following information to safely clean the external surfaces of your computer.

Removing dirt and debris from your computer

Here are the recommended steps to clean dirt and debris from your computer.

1. Wear disposable gloves made of latex (or nitrile gloves, if you are latex-sensitive) when cleaning the surfaces.
2. Turn off your device and unplug the power cord and other connected external devices. Remove any installed batteries from items such as wireless keyboards.

 **CAUTION:** To prevent electric shock or damage to components, never clean a product while it is turned on or plugged in.

3. Moisten a microfiber cloth with water. The cloth should be moist, but not dripping wet.

 **IMPORTANT:** To avoid damaging the surface, avoid abrasive cloths, towels, and paper towels.

4. Wipe the exterior of the product gently with the moistened cloth.

 **IMPORTANT:** Keep liquids away from the product. Avoid getting moisture in any openings. If liquid makes its way inside your HP product, it can cause damage to the product. Do not spray liquids directly on the product. Do not use aerosol sprays, solvents, abrasives, or cleaners containing hydrogen peroxide or bleach that might damage the finish.

5. Start with the display (if applicable). Wipe carefully in one direction, and move from the top of the display to the bottom. Finish with any flexible cables, like power cord, keyboard cable, and USB cables.
6. Be sure that surfaces have completely air-dried before turning the device on after cleaning.
7. Discard the gloves after each cleaning. Clean your hands immediately after you remove the gloves.

See [Cleaning your computer with a disinfectant on page 29](#) for recommended steps to clean the high-touch, external surfaces on your computer to help prevent the spread of harmful bacteria and viruses.

Cleaning your computer with a disinfectant

The World Health Organization (WHO) recommends cleaning surfaces, followed by disinfection, as a best practice for preventing the spread of viral respiratory illnesses and harmful bacteria.

After cleaning the external surfaces of your computer using the steps in [Removing dirt and debris from your computer on page 29](#), you might also choose to clean the surfaces with a disinfectant. A disinfectant that is within HP's cleaning guidelines is an alcohol solution consisting of 70% isopropyl alcohol and 30% water. This solution is also known as rubbing alcohol and is sold in most stores.

Follow these steps when disinfecting high-touch, external surfaces on your computer:

1. Wear disposable gloves made of latex (or nitrile gloves, if you are latex-sensitive) when cleaning the surfaces.
2. Turn off your device and unplug the power cord and other connected external devices. Remove any installed batteries from items such as wireless keyboards.

 **CAUTION:** To prevent electric shock or damage to components, never clean a product while it is turned on or plugged in.

3. Moisten a microfiber cloth with a mixture of 70% isopropyl alcohol and 30% water. The cloth should be moist, but not dripping wet.

 **CAUTION:** Do not use any of the following chemicals or any solutions that contain them, including spray-based surface cleaners: bleach, peroxides (including hydrogen peroxide), acetone, ammonia, ethyl alcohol, methylene chloride, or any petroleum-based materials, such as gasoline, paint thinner, benzene, or toluene.

 **IMPORTANT:** To avoid damaging the surface, avoid abrasive cloths, towels, and paper towels.

4. Wipe the exterior of the product gently with the moistened cloth.

 **IMPORTANT:** Keep liquids away from the product. Avoid getting moisture in any openings. If liquid makes its way inside your HP product, it can cause damage to the product. Do not spray liquids directly on the product. Do not use aerosol sprays, solvents, abrasives, or cleaners containing hydrogen peroxide or bleach that might damage the finish.

5. Start with the display (if applicable). Wipe carefully in one direction, and move from the top of the display to the bottom. Finish with any flexible cables, like power cord, keyboard cable, and USB cables.
6. Be sure that surfaces have completely air-dried before turning the device on after cleaning.
7. Discard the gloves after each cleaning. Clean your hands immediately after you remove the gloves.

Shipping preparation

If you have to ship your computer, follow these tips to keep your equipment safe.

1. Back up the hard drive files to an external storage device. Be sure that the backup media is not exposed to electrical or magnetic impulses while stored or in transit.

 **NOTE:** The hard drive locks automatically when the system power is turned off.

2. Remove and store all removable media.
3. Turn off the computer and external devices.
4. Disconnect the power cord from the AC outlet, and then from the computer.
5. Disconnect the system components and external devices from their power sources and then from the computer.

 **NOTE:** Be sure that all boards are seated properly and secured in the board slots before shipping the computer.

6. Pack the system components and external devices in their original packing boxes or similar packaging with sufficient packing material to protect them.

6 Specifications

This chapter provides specifications for your computer.

Computer specifications

This section provides specifications for your computer. When you travel with your computer, the computer dimensions and weights, as well as input power ratings and operating specifications, provide helpful information.

Table 6-1 Computer specifications

	Metric	U.S.
Temperature		
Operating	5°C to 35°C	41°F to 95°F
Nonoperating	-20°C to 60°C	-4°F to 140°F
Relative humidity (noncondensing)		
Operating	10% to 90%	
Nonoperating	5% to 95%	
Maximum altitude (unpressurized)		
Operating	-15 m to 3,048 m	-50 ft to 10,000 ft
Nonoperating	-15 m to 12,192 m	-50 ft to 40,000 ft

Input power

The power information in this section may be helpful if you plan to travel internationally with the computer.

The computer operates on DC power, which can be supplied by an AC or a DC power source. The AC power source must be rated at 100 V-240 V, 50 Hz-60 Hz. Although the computer can be powered from a standalone DC power source, it should be powered only with an AC adapter or a DC power source supplied and approved by HP for use with this computer.

The computer can operate on DC power within the following specifications. The voltage and current for your computer is located on the regulatory label.

Table 6-2 Input power

Input power	Rating
Operating voltage and current	5 V dc @ 3 A / 9 V dc @ 3 A / 10 V dc @ 5 A / 12 V dc @ 5 A / 15 V dc @ 4.33 A / 20 V dc @ 3.2 A - 65 W USB-C®

7 Electrostatic discharge

Electrostatic discharge is the release of static electricity when two objects come into contact—for example, the shock you receive when you walk across the carpet and touch a metal door knob.

A discharge of static electricity from fingers or other electrostatic conductors may damage electronic components.

 **IMPORTANT:** To prevent damage to the computer, damage to a drive, or loss of information, observe these precautions:

- If removal or installation instructions direct you to unplug the computer, first be sure that it is properly grounded.
 - Keep components in their electrostatic-safe containers until you are ready to install them.
 - Avoid touching pins, leads, and circuitry. Handle electronic components as little as possible.
 - Use nonmagnetic tools.
 - Before handling components, discharge static electricity by touching an unpainted metal surface.
 - If you remove a component, place it in an electrostatic-safe container.
-

8 Accessibility

HP's goal is to design, produce, and market products, services, and information that everyone everywhere can use, either on a stand-alone basis or with appropriate third-party assistive technology (AT) devices or applications.

HP and accessibility

Because HP works to weave diversity, inclusion, and work/life into the fabric of the company, it is reflected in everything HP does. HP strives to create an inclusive environment focused on connecting people to the power of technology throughout the world.

Finding the technology tools you need

Technology can unleash your human potential. Assistive technology removes barriers and helps you create independence at home, at work, and in the community. Assistive technology helps increase, maintain, and improve the functional capabilities of electronic and information technology.

For more information, see [Finding the best assistive technology on page 34](#).

The HP commitment

HP is committed to providing products and services that are accessible for people with disabilities. This commitment supports the company's diversity objectives and helps ensure that the benefits of technology are available to all.

The HP accessibility goal is to design, produce, and market products and services that can be effectively used by everyone, including people with disabilities, either on a standalone basis or with appropriate assistive devices.

To achieve that goal, this Accessibility Policy establishes seven key objectives to guide HP actions. All HP managers and employees are expected to support these objectives and their implementation in accordance with their roles and responsibilities:

- Raise the level of awareness of accessibility issues within HP, and provide employees with the training they need to design, produce, market, and deliver accessible products and services.
- Develop accessibility guidelines for products and services, and hold product development groups accountable for implementing these guidelines where competitively, technically, and economically feasible.
- Involve people with disabilities in the development of accessibility guidelines and in the design and testing of products and services.
- Document accessibility features, and make information about HP products and services publicly available in an accessible form.
- Establish relationships with leading assistive technology and solution providers.
- Support internal and external research and development that improves assistive technology relevant to HP products and services.
- Support and contribute to industry standards and guidelines for accessibility.

International Association of Accessibility Professionals (IAAP)

IAAP is a not-for-profit association focused on advancing the accessibility profession through networking, education, and certification. The objective is to help accessibility professionals develop and advance their careers and to better enable organizations to integrate accessibility into their products and infrastructure.

As a founding member, HP joined to participate with other organizations to advance the field of accessibility. This commitment supports HP's accessibility goal of designing, producing, and marketing products and services that people with disabilities can effectively use.

IAAP will make the profession strong by globally connecting individuals, students, and organizations to learn from one another. If you are interested in learning more, go to <http://www.accessibilityassociation.org> to join the online community, sign up for newsletters, and learn about membership options.

Finding the best assistive technology

Everyone, including people with disabilities or age-related limitations, should be able to communicate, express themselves, and connect with the world using technology. HP is committed to increasing accessibility awareness within HP and with our customers and partners.

Whether it's large fonts that are easy on the eyes, voice recognition that lets you give your hands a rest, or any other assistive technology to help with your specific situation—a variety of assistive technologies make HP products easier to use. How do you choose?

Assessing your needs

Technology can unleash your potential. Assistive technology removes barriers and helps you create independence at home, at work, and in the community. Assistive technology (AT) helps increase, maintain, and improve the functional capabilities of electronic and information technology.

You can choose from many AT products. Your AT assessment should allow you to evaluate several products, answer your questions, and facilitate your selection of the best solution for your situation. You will find that professionals qualified to do AT assessments come from many fields, including those licensed or certified in physical therapy, occupational therapy, speech/language pathology, and other areas of expertise. Others, while not certified or licensed, can also provide evaluation information. You will want to ask about the individual's experience, expertise, and fees to determine if they are appropriate for your needs.

Accessibility for HP products

These links provide information about accessibility features and assistive technology, if applicable and available in your country or region, that are included in various HP products. These resources will help you select the specific assistive technology features and products most appropriate for your situation.

- **HP Aging & Accessibility:** Go to <http://www.hp.com>, type **Accessibility** in the search box. Select **Office of Aging and Accessibility**.
- **HP computers:** For Windows products, go to <http://www.hp.com/support>, type **Windows Accessibility Options** in the **Search our knowledge** search box. Select the appropriate operating system in the results.
- **HP Shopping, peripherals for HP products:** Go to <http://store.hp.com>, select **Shop**, and then select **Monitors** or **Accessories**.

If you need additional support with the accessibility features on your HP product, see [Contacting support on page 37](#).

Additional links to external partners and suppliers that may provide additional assistance:

- [Microsoft Accessibility information \(Windows and Microsoft Office\)](#)
- [Google Products accessibility information \(Android, Chrome, Google Apps\)](#)

Standards and legislation

Countries worldwide are enacting regulations to improve access to products and services for persons with disabilities. These regulations are historically applicable to telecommunications products and services, PCs and printers with certain communications and video playback features, their associated user documentation, and their customer support.

Standards

The US Access Board created Section 508 of the Federal Acquisition Regulation (FAR) standards to address access to information and communication technology (ICT) for people with physical, sensory, or cognitive disabilities.

The standards contain technical criteria specific to various types of technologies, as well as performance-based requirements which focus on functional capabilities of covered products. Specific criteria cover software applications and operating systems, web-based information and applications, computers, telecommunications products, video and multimedia, and self-contained closed products.

Mandate 376 – EN 301 549

The European Union created the EN 301 549 standard within Mandate 376 as an online toolkit for public procurement of ICT products. The standard specifies the accessibility requirements applicable to ICT products and services, with a description of the test procedures and evaluation methodology for each requirement.

Web Content Accessibility Guidelines (WCAG)

Web Content Accessibility Guidelines (WCAG) from the W3C's Web Accessibility Initiative (WAI) helps web designers and developers create sites that better meet the needs of people with disabilities or age-related limitations.

WCAG advances accessibility across the full range of web content (text, images, audio, and video) and web applications. WCAG can be precisely tested, is easy to understand and use, and allows web developers flexibility for innovation. WCAG 2.0 has also been approved as [ISO/IEC 40500:2012](#).

WCAG specifically addresses barriers to accessing the web experienced by people with visual, auditory, physical, cognitive, and neurological disabilities, and by older web users with accessibility needs. WCAG 2.0 provides characteristics of accessible content:

- **Perceivable** (for instance, by addressing text alternatives for images, captions for audio, adaptability of presentation, and color contrast)
- **Operable** (by addressing keyboard access, color contrast, timing of input, seizure avoidance, and navigability)
- **Understandable** (by addressing readability, predictability, and input assistance)
- **Robust** (for instance, by addressing compatibility with assistive technologies)

Legislation and regulations

Accessibility of IT and information has become an area of increasing legislative importance. These links provide information about key legislation, regulations, and standards.

- [United States](#)
- [Canada](#)
- [Europe](#)
- [Australia](#)

Useful accessibility resources and links

These organizations, institutions, and resources might be good sources of information about disabilities and age-related limitations.



NOTE: This is not an exhaustive list. These organizations are provided for informational purposes only. HP assumes no responsibility for information or contacts you encounter on the internet. Listing on this page does not imply endorsement by HP.

Organizations

These organizations are a few of the many that provide information about disabilities and age-related limitations.

- American Association of People with Disabilities (AAPD)
- The Association of Assistive Technology Act Programs (ATAP)
- Hearing Loss Association of America (HLAA)
- Information Technology Technical Assistance and Training Center (ITTATC)
- Lighthouse International
- National Association of the Deaf
- National Federation of the Blind
- Rehabilitation Engineering & Assistive Technology Society of North America (RESNA)
- Telecommunications for the Deaf and Hard of Hearing, Inc. (TDI)
- W3C Web Accessibility Initiative (WAI)

Educational institutions

Many educational institutions, including these examples, provide information about disabilities and age-related limitations.

- California State University, Northridge, Center on Disabilities (CSUN)
- University of Wisconsin - Madison, Trace Center
- University of Minnesota computer accommodations program

Other disability resources

Many resources, including these examples, provide information about disabilities and age-related limitations.

- ADA (Americans with Disabilities Act) Technical Assistance Program

- ILO Global Business and Disability network
- EnableMart
- European Disability Forum
- Job Accommodation Network
- Microsoft Enable

HP links

These HP-specific links provide information that relates to disabilities and age-related limitations.

[HP comfort and safety guide](#)

[HP public sector sales](#)

Contacting support

HP offers technical support and assistance with accessibility options for customers with disabilities.



NOTE: Support is in English only.

- Customers who are deaf or hard of hearing who have questions about technical support or accessibility of HP products:
 - Use TRS/VRS/WebCapTel to call (877) 656-7058 Monday through Friday, 6 a.m. to 9 p.m. Mountain Time.
- Customers with other disabilities or age-related limitations who have questions about technical support or accessibility of HP products:
 - Call (888) 259-5707 Monday through Friday, 6 a.m. to 9 p.m. Mountain Time.

Index

- A**
- accessibility 33-35, 37
 - accessibility needs assessment 34
 - adjusting the mobile head unit 11
 - advanced I/O connectivity base
 - features 8
 - assistive technology (AT)
 - finding 34
 - purpose 33
 - AT (assistive technology)
 - finding 34
 - purpose 33
 - attaching
 - I/O connectivity base to the mobile system 15
 - mobile head unit from the dock 14
 - rugged case to mobile head 20
 - standard case to mobile head 19
- B**
- basic I/O connectivity base
 - components 8
- C**
- calibrating the touch screen 26
 - caring for your computer 28
 - cleaning your computer 28
 - disinfecting 29
 - removing dirt and debris 29
 - computer operating guidelines 28
 - computer specifications 31
 - configure
 - peripheral modules 26
 - powered serial ports 18
 - configuring the software 26
 - connecting
 - optional fingerprint reader to the I/O connectivity base 24
 - power to the I/O connectivity base 9
 - standalone I/O connectivity base to the mobile system 17
 - standalone optional fingerprint reader to the I/O connectivity base 23
- D**
- customer support, accessibility 37
 - diagnostics 2
 - docking stand 7
 - documentation 2
 - downloading HP Firmware Installer 26
- E**
- electrostatic discharge 32
- F**
- features 8
 - firmware update 26
- H**
- hardware setup 13
 - HP Assistive Policy 33
 - HP resources 1
- I**
- input power 31
 - installing
 - security cables 12
 - updates 27
 - integrated features 7
 - International Association of Accessibility Professionals 34
- L**
- locking and releasing the mobile head unit 13
- M**
- mobile head unit features 6
 - mount mobile system to a countertop 21
 - multicharger features 9
- P**
- power button
 - I/O connectivity base 10
 - mobile system 10
 - product information 1
- R**
- removing mobile head unit from the dock 14
 - resources, accessibility 36
- S**
- Section 508 accessibility standards 35
 - serial number location
 - I/O connectivity base 11
 - mobile system 11
 - setup 13
 - shipping preparation 30
 - software 26
 - specifications
 - computer 31
 - input power 31
 - specifications, computer 31
 - standards and legislation, accessibility 35
 - support
 - general resources 1
 - HP resources 1
- T**
- tools needed 13
 - touch screen calibration 26
- U**
- update mobile system 26
 - updates 3
- V**
- ventilation guidelines 28