

SAMSUNG

User Manual

Table of contents

Getting started

- 3 About this manual
- 7 Layout
- 16 Turning the computer on and off
- 18 Unlocking the screen
- 18 Windows
- 27 Fingerprint recognition
- 29 Memory card slot
- 32 External display
- 34 Wireless LAN
- 36 Bluetooth
- 38 Thunderbolt™ 4

Basics

- 20 Keyboard
- 22 Touchpad
- 25 SIM or USIM card (nano-SIM card) tray (LTE models only)
- 26 Cellular data (LTE models only)

Applications

- 40 Using applications
- 41 Samsung Settings
- 42 Samsung Security
- 45 Samsung Update
- 46 Online Support (S Service)
- 47 Samsung PC Cleaner
- 48 Screen Recorder
- 49 Quick Search

- 50 Samsung Flow
- 50 Samsung Studio Plus
- 51 Samsung Voice Note
- 51 Samsung Gallery

Settings & Upgrade

- 52 Display brightness
- 54 Volume
- 55 BIOS (Setup utility)
- 61 Battery

Troubleshooting

- 64 Samsung Recovery
- 69 Windows recovery function
- 69 Q&A

Appendix

- 72 Product specifications
- 73 Ergonomic tips
- 77 Safety precautions
- 87 Important safety information
- 90 Replacement parts and accessories
- 93 Regulatory compliance statements
- 102 WEEE symbol information
- 104 Samsung package Take-Back program (USA only)

Getting started

About this manual

- This user manual is specially designed to detail the computer's functions and features.
 - The user manual supplied with the computer may vary depending on the model.
 - Please read this manual before using the computer to ensure safe and proper use.
 - Optional accessories, some devices, and software referred to in this manual may not be provided or may not be subject to upgrades. Note that the computer environment referred to in the user manual may not be the same as your environment.
 - Descriptions are based on the computer's default settings and the Windows 10 operating system. Available features and additional services may vary depending on the computer or operating system.
- This user manual describes procedures for using the touchpad, mouse and touch screen. Instructions for using the touch screen are for models with the touch screen feature.
 - Images and screenshots are those of the representative model of the series and may differ in appearance from the actual product.
 - Content may differ from the final product and is subject to change without prior notice. For the latest version of the manual, refer to the Samsung website, www.samsung.com.

Instructional icons and expressions



Warning: situations that could cause injury to yourself or others



Caution: situations that could cause damage to the computer or other equipment



Note: notes, usage tips, or additional information



The path you should follow to carry out an instruction. For example, “select **Settings** → **Devices**” indicates that you should select **Settings** and then **Devices**.

Select Click the mouse or tap the touchpad or touch screen.

Copyright

Copyright © 2021 Samsung Electronics Co., Ltd.

This manual is protected under international copyright laws.

No part of this manual may be reproduced, distributed, translated, or transmitted in any form or by any means, electronic or mechanical, including photocopying, recording, or storing in any information storage and retrieval system.

Computer specifications or the contents of this manual may be changed without prior notice due to an upgrade of the computer's functions.

Trademarks

- Samsung and the Samsung logo are trademarks or registered trademarks of Samsung Electronics Co., Ltd.
- Intel and Core are trademarks or registered trademarks of the Intel Corporation.
- Microsoft, MS-DOS, and Windows are trademarks or registered trademarks of the Microsoft Corporation.
- Bluetooth® is a registered trademark of Bluetooth SIG, Inc. worldwide.



- Wi-Fi®, Wi-Fi Direct™, Wi-Fi CERTIFIED™, and the Wi-Fi logo are registered trademarks of the Wi-Fi Alliance.

- HDMI, the HDMI logo, and the term High Definition Multimedia Interface are trademarks or registered trademarks of HDMI Licensing LLC.



- Thunderbolt and the Thunderbolt logo are trademarks of Intel Corporation in the U.S. and/or other countries.
- Manufactured under license from Dolby Laboratories. Dolby, Dolby Atmos, and the double-D symbol are trademarks of Dolby Laboratories.
- All other trademarks and copyrights are the property of their respective owners.

As an ENERGY STAR® Partner, Samsung has determined that this product meets the ENERGY STAR® guidelines for energy efficiency.



- The ENERGY STAR Program has reduced greenhouse gas emissions and saved energy through voluntary labeling.
- Power management setting of this product has been enabled by default, and has various timing settings from 1 minute to 5 hours.
- The product can wake with a button press on the chassis from sleep mode.

Data precautions

Samsung shall not be liable for any data loss. Please take care to avoid losing any important data and back up your data to prevent any such data loss.

Operating system and software support

If you change the product's factory OS (Operating System) to another OS or if you install software which is not supported by the product's original factory OS, you will not receive any technical support, product exchange or refund, and a fee will be charged when requesting a service.

Please use your computer with the original factory OS. If you install an OS other than the factory OS, data may be deleted or the computer may not start.

* Please use Windows 10 64-bit only for this model.

Product capacity representation

Storage capacity representation

The capacity of the storage device (HDD, SSD) of the manufacturer is calculated assuming that 1 KB = 1,000 Bytes.

However, the operating system (Windows) calculates the storage device capacity assuming that 1 KB = 1,024 Bytes. Therefore, the available capacity of the HDD in Windows is smaller than the actual capacity due to the difference in capacity calculation. For example, for an 80 GB HDD, Windows calculates the capacity as 74.5 GB, $(80 \times 1,000 \times 1,000 \times 1,000) \text{ Bytes} / (1,024 \times 1,024 \times 1,024) \text{ Bytes} = 74.505 \text{ GB}$.

In addition, the capacity representation in Windows may be even smaller because some programs, such as Samsung Recovery, may reside in a hidden area of the HDD.

Memory capacity representation

The available memory capacity in Windows is less than the actual capacity of memory. This is because some memory is required for regular system operations.

For example, for 1 GB (= 1,024 MB) memory installed, Windows may report the capacity as 1,022 MB or less.

Layout



Leaving the screen idle for extended periods may result in afterimages (screen burn-in) or ghosting. Turn off the screen, or turn on the screen saver or power saving mode when you are not using the computer.



- Features or options may differ depending on the model.
- The items marked as optional may not be provided or may be provided in different locations.
- Since some space on the storage device is reserved for system recovery and operations, the available space on the storage device may be less than the actual capacity.

Front view

► For 13.3 inch models

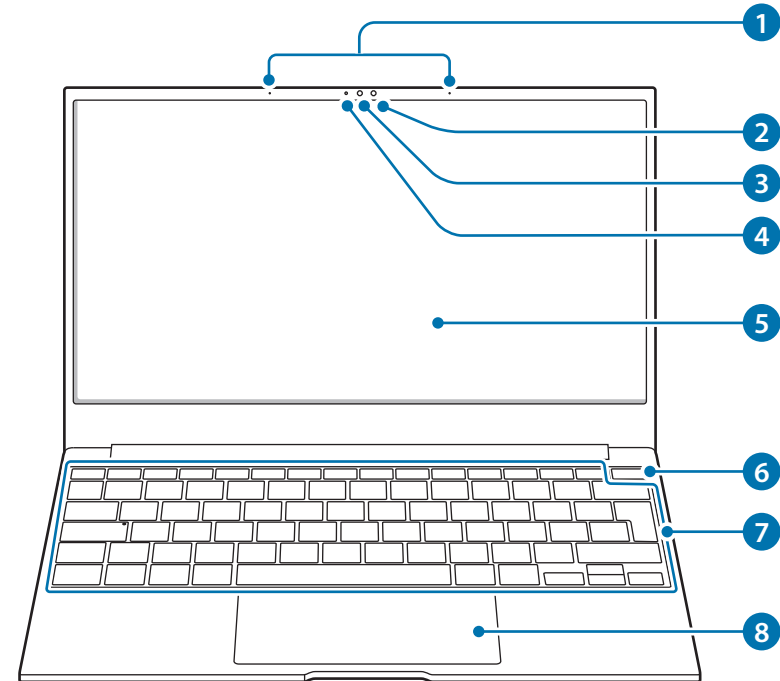

Number/Name	Description
1 Microphone	<ul style="list-style-type: none"> You can use the built-in microphone.
2 Ambient light sensor	<ul style="list-style-type: none"> Recognizes the brightness of the environment where you use the computer. When the surroundings become dark, the keyboard backlight turns on. When the surroundings become bright, the keyboard backlight turns off. <p> Do not cover the ambient light sensor.</p>
3 Camera	<ul style="list-style-type: none"> Using this camera, you can take still pictures and record video.
4 Camera indicator light	<ul style="list-style-type: none"> This indicates the camera operating status.
5 Display	<ul style="list-style-type: none"> The screen's images are displayed here.

Number/Name	Description
6 Power button/ Fingerprint recognition sensor	<ul style="list-style-type: none"> Turns the computer on and off. The fingerprint recognition sensor recognizes fingerprints. Scans a fingerprint to sign in to Windows, apps, and services.
7 Keyboard	<ul style="list-style-type: none"> Enter text or control computer functions.
8 Touchpad	<ul style="list-style-type: none"> Moves the cursor and selects options. Functions as a mouse.

► For 15.6 inch models

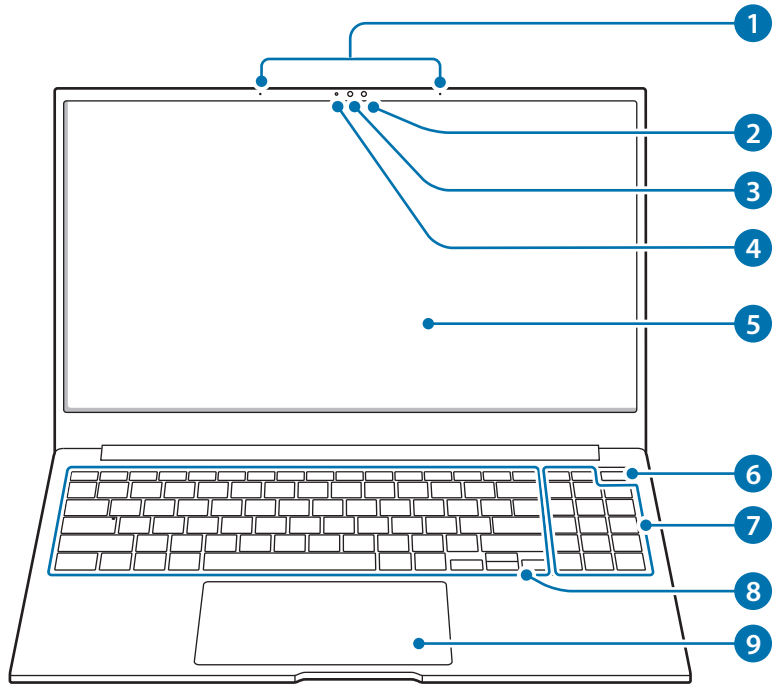

Number/Name	Description
1 Microphone	<ul style="list-style-type: none"> You can use the built-in microphone.
2 Ambient light sensor	<ul style="list-style-type: none"> Recognizes the brightness of the environment where you use the computer. When the surroundings become dark, the keyboard backlight turns on. When the surroundings become bright, the keyboard backlight turns off. <p> Do not cover the ambient light sensor.</p>
3 Camera	<ul style="list-style-type: none"> Using this camera, you can take still pictures and record video.
4 Camera indicator light	<ul style="list-style-type: none"> This indicates the camera operating status.
5 Display	<ul style="list-style-type: none"> The screen's images are displayed here.

Number/Name	Description
6 Power button/ Fingerprint recognition sensor	<ul style="list-style-type: none">• Turns the computer on and off.• The fingerprint recognition sensor recognizes fingerprints. Scans a fingerprint to sign in to Windows, apps, and services.
7 Numeric keypad	<ul style="list-style-type: none">• Enter numbers.
8 Keyboard	<ul style="list-style-type: none">• Enter text or control computer functions.
9 Touchpad	<ul style="list-style-type: none">• Moves the cursor and selects options.• Functions as a mouse.

Right view

► For 13.3 inch models

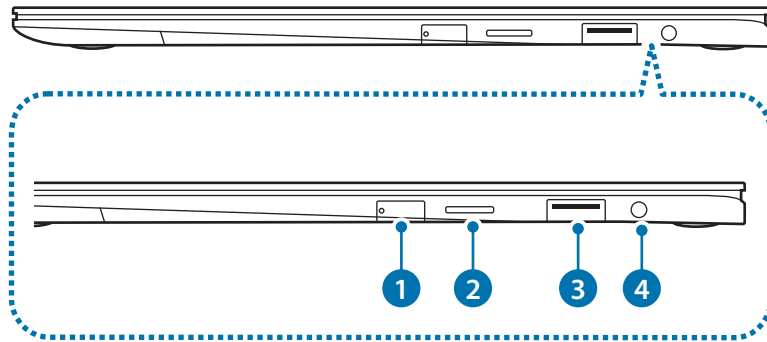

Number/Name	Description
1 SIM card tray (LTE models only)	<ul style="list-style-type: none"> Insert the SIM or USIM card.
2 Memory card slot	<ul style="list-style-type: none"> Insert a memory card into the slot.
3 USB 3.2 port	<ul style="list-style-type: none"> Connect various peripheral devices, such as a mouse, camera, or keyboard.
4 Earpiece/Headset jack	<ul style="list-style-type: none"> Connect an earpiece or a headset to the computer to listen to audio.

► For 15.6 inch models

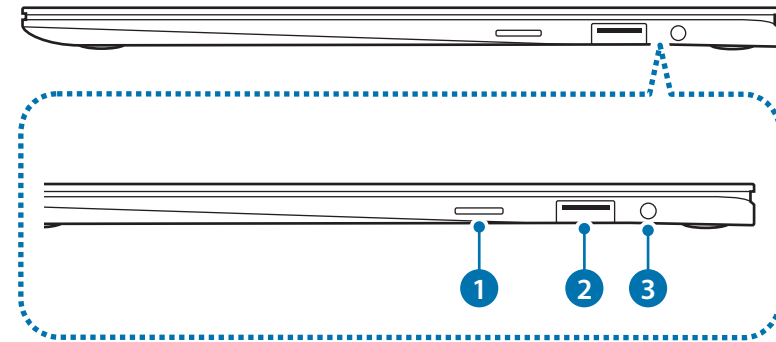

Number/Name	Description
1 Memory card slot	<ul style="list-style-type: none"> Insert a memory card into the slot.
2 USB 3.2 port	<ul style="list-style-type: none"> Connect various peripheral devices, such as a mouse, camera, or keyboard.
3 Earpiece/Headset jack	<ul style="list-style-type: none"> Connect an earpiece or a headset to the computer to listen to audio.

Left view

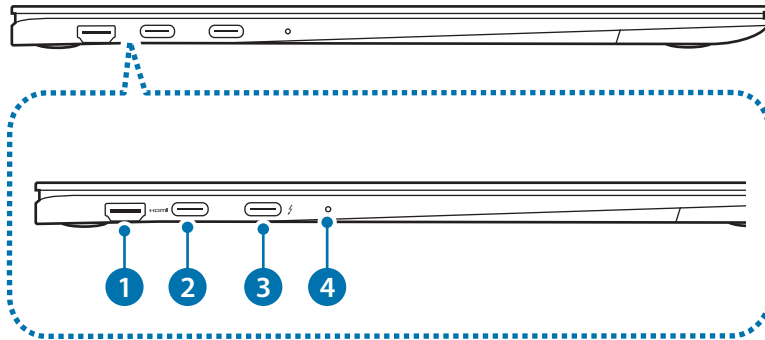

Number/Name	Description
1 HDMI port HDMI	<ul style="list-style-type: none"> Used to connect an HDMI cable to an external device.
2 USB Type-C port	<ul style="list-style-type: none"> This port allows the USB PD AC adapter to be used to supply power to the computer. It can also be used to charge USB Type-C devices or to connect external display devices.
3 Thunderbolt™ 4 port ⚡	<ul style="list-style-type: none"> Connect and charge a USB Type-C device and Thunderbolt™ device, or connect to an external display device. <p> Some features may not be supported depending on your device's specifications.</p>
4 Operating status LED	<ul style="list-style-type: none"> Shows the operating status of the computer.

The charging feature of the USB Type-C port or Thunderbolt™ 4 port

Charging the computer

Connect an external power supply (sold separately) to the USB Type-C port or Thunderbolt™ 4 port to use it as the auxiliary power or charge the computer.

Use an external power supply (sold separately) with a rating level higher than 10 W (5 V, 2 A) that supports USB Type-C or USB BC 1.2.

Charging a USB Type-C device or Thunderbolt™ device

Connect and charge your USB Type-C or Thunderbolt™ device by connecting it to the computer.



- It may take longer to charge the battery when charging a connected device.
- The battery power level may be reduced when charging a connected device while the computer is powered by the battery.
- The charging status of the connected device is not displayed on the computer.
- This charging feature may not be available on some devices.
- To charge another device when the computer is in hibernation mode or is turned off, connect to the USB Type-C port or Thunderbolt™ 4 port.

Operating status LED and Ambient light sensor

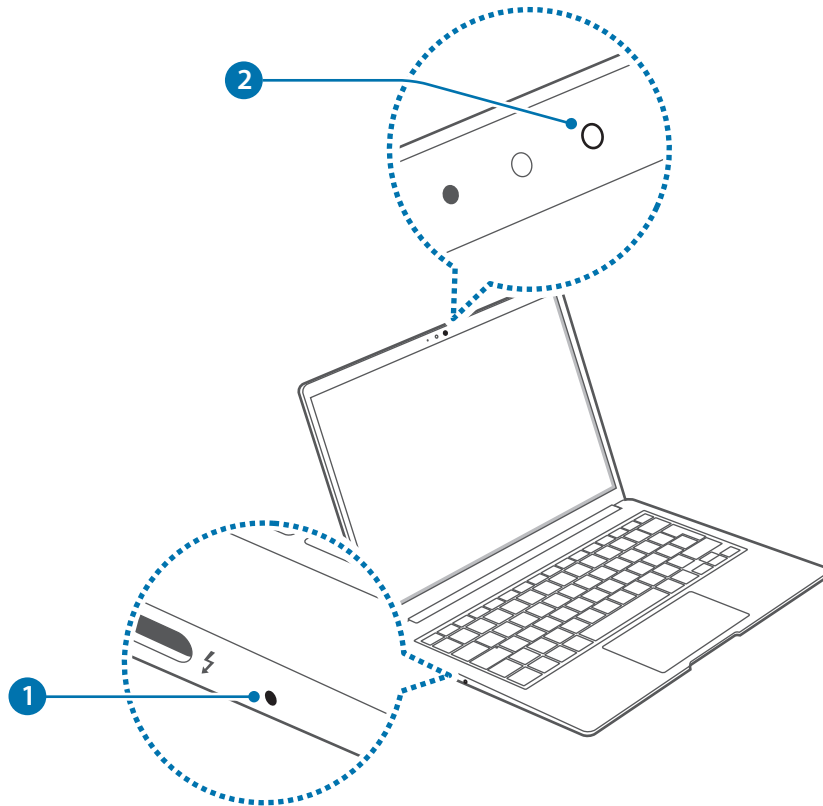

Number/Name	Description
1 Operating status LED	<ul style="list-style-type: none">Shows the operating status of the computer.<ul style="list-style-type: none">Red: ChargingGreen: Fully chargedBlue: Turned on
2 Ambient light sensor	<ul style="list-style-type: none">Recognizes the brightness of the environment where you use the computer.When the surroundings become dark, the keyboard backlight turns on.When the surroundings become bright, the keyboard backlight turns off. <p> Do not cover the ambient light sensor.</p>

Bottom view

► For 13.3 inch models

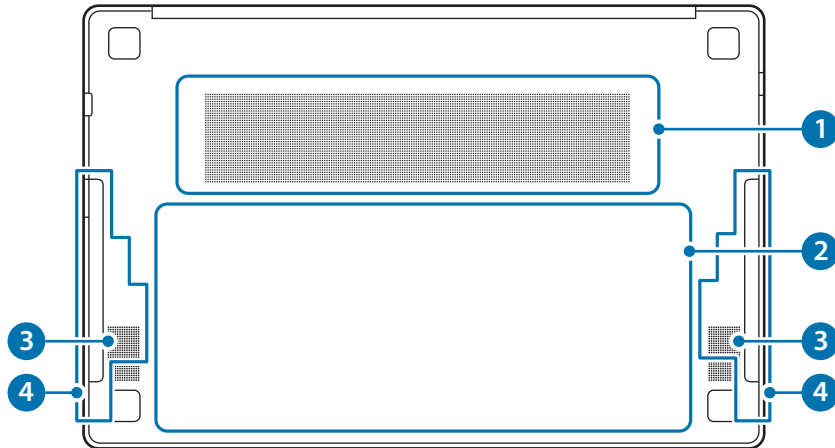

► For 15.6 inch models

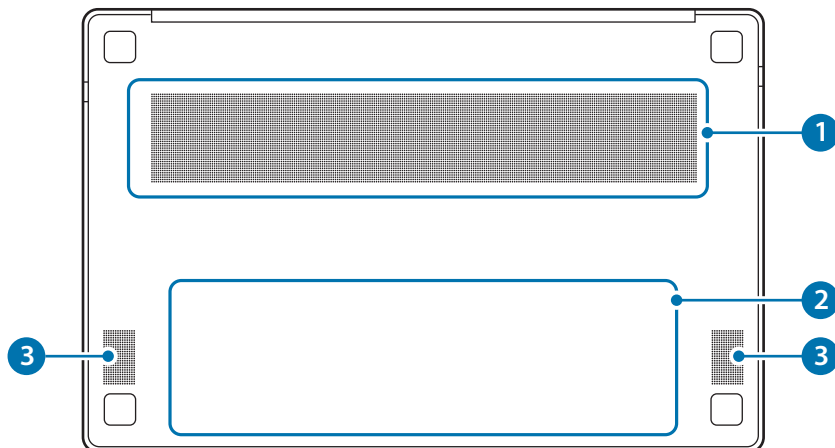

Number/Name	Description
1 Fan vents	<ul style="list-style-type: none"> Sucks in outside air and discharges heat generated inside the computer through these holes. If the vents are blocked the computer may overheat. Avoid blocking the vents as this may be dangerous.
2 Internal battery	<ul style="list-style-type: none"> Provides power to the computer when not connected to an AC adapter. To remove or replace the internal battery, take it to a Samsung Service Center. You will be charged for this service.
3 Speaker	<ul style="list-style-type: none"> Sound is emitted from the speakers.
4 LTE antenna (LTE models only)	<ul style="list-style-type: none"> Transmits and receives radio waves.



If the case on the bottom of the device is replaced, the laser-carved model name, serial number, and various logos will not be displayed anymore. For more information, contact a Samsung Service Center.

Turning the computer on and off



Fully charge the battery using the AC adapter before using the computer **for the first time**.

Turning the computer on

- 1 Before turning on the computer, check that the battery is charged and charge it if necessary.
- 2 Open the display panel.

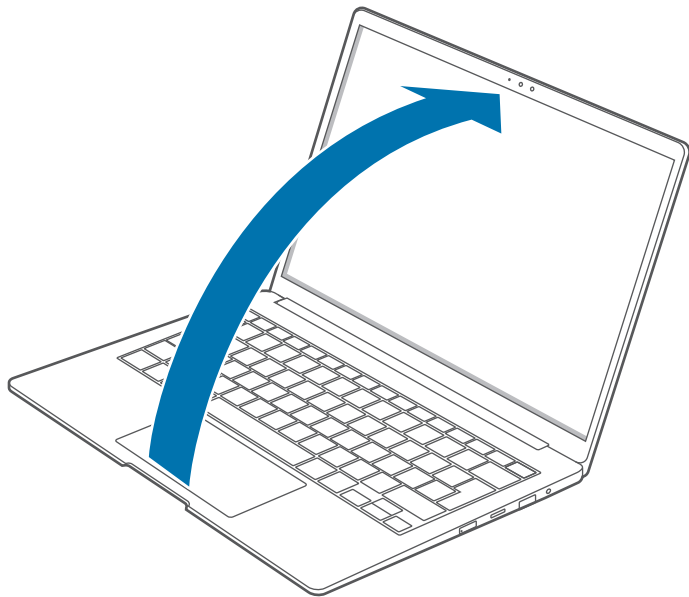

- 3 The computer turns on automatically when the display panel is opened.

If the computer does not turn on automatically, press the Power button.

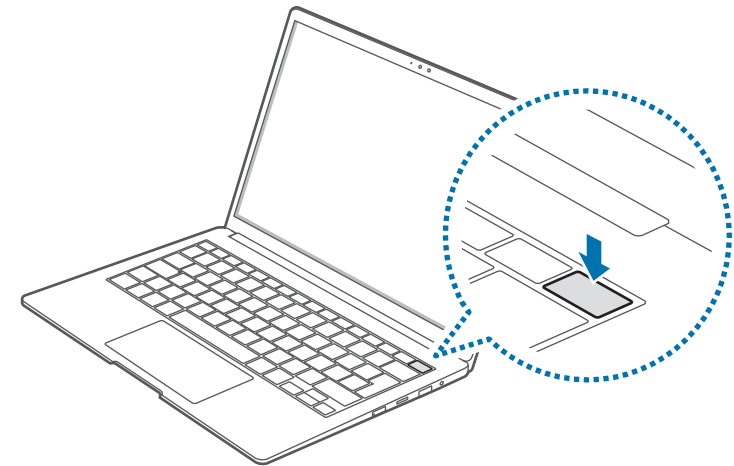

Set the device to not turn on the computer automatically when the display panel is opened.

1. Select the Start button (Windows logo) → **Samsung Settings**.
2. Select **System** → **Auto booting** → **Off**.

About Windows Activation

When you turn the computer on for the first time, the Windows activation screen appears.

Follow the activation procedures according to the instructions on the screen to use the computer.

The computer's date and time may be incorrect when you turn it on for the first time. They may also be incorrect if the battery has been fully discharged or removed. To set the date and time, go to the desktop taskbar and right-click the date and clock area. Then, select **Adjust date/time** and set the current date and time.

Turning the computer off

- 1 Select the Start button (■).
- 2 Select  → **Shut down**.

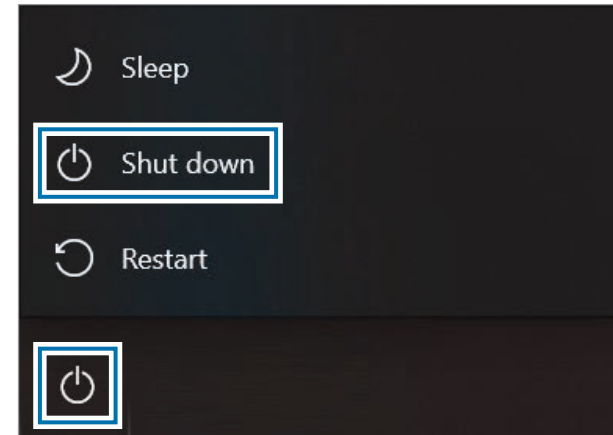

Save all data before turning off the computer.

Unlocking the screen

To unlock the lock screen, do one of the following:

- **Mouse:** Click the lock screen.
- **Keyboard:** Press any key.
- **Touchpad:** Tap the touchpad.

If the account has a password, enter the password to log in after unlocking the screen.

Windows



Microsoft Windows is an operating system that is used to control a computer.



- Images and available features may differ depending on the model and operating system.
- This manual is designed for Windows 10 and content may differ depending on the OS version.
- The image displayed on the desktop screen may differ between models and OS versions.

Configuring the Windows Settings

You can configure the basic system settings, such as installing or uninstalling apps and managing accounts, on the Windows Settings screen.

Select the Start button () → .

Then, select an option you want to change after the Windows Settings screen appears.



You can also configure the settings from the Control Panel like previous OS versions. Select the Start button () → **Windows System** → **Control Panel**.

Action Center



The Windows 10 action center allows you to receive system notifications, such as updates, and push notifications, such as emails and SNS updates. You can also adjust settings conveniently. For example, you can select wireless network options or adjust the volume and screen brightness via quick actions in the action center.

Checking notifications

1 Select  on the taskbar.

2 When the action center panel appears, select a message to check it.



- You can enable or disable push notifications for applications. You can also set personalized quick actions to appear in the action center by selecting the Start button () →  → **System** → **Notifications & actions**.
- Select **Expand** or **Collapse** to expand or minimize the action center menu and select the feature you want to use.

Basics

Keyboard

Enter text or access computer functions with the keyboard.



- Images and available features may differ depending on the model and operating system.
- The keyboard layout may differ depending on the country. The hot keys will be mainly explained in this manual.

Using hot keys

To use keyboard hot keys, do one of the following:

- Press and hold the **Fn** key and press a hot key.

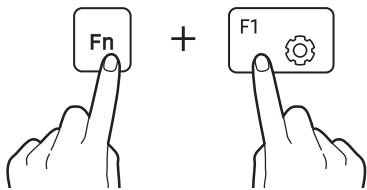



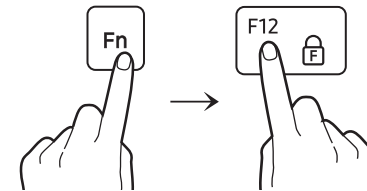









- Press and hold the **Fn** key and press the **F12** key. When the Fn Lock feature turns on, press a hot key.



When the Fn Lock feature is on, hot keys are activated without pressing the **Fn** key.

Hot key functions

Key/Icon	Description
F1 	<ul style="list-style-type: none"> • Samsung Settings: Launch the Samsung Settings application.
F2 	<ul style="list-style-type: none"> • Screen brightness control: Adjust the brightness of the display.
F3 	
F4 	<ul style="list-style-type: none"> • Display/External monitor: Switch between the display and an external display device when an external display device is connected to the computer.
F5 	<ul style="list-style-type: none"> • Touchpad: Turn the touchpad function on or off.
F6 	<ul style="list-style-type: none"> • Mute: Mute or unmute the audio.
F7 	<ul style="list-style-type: none"> • Volume control: Adjust the volume level.
F8 	

Key/Icon	Description
F9 	<ul style="list-style-type: none"> • Keyboard backlight brightness: Turn the keyboard backlight on or off and adjust its brightness.
F10 	<ul style="list-style-type: none"> • Blocking Recording mode: Limit the use of the camera and the microphone to prevent recording.
F11 	<ul style="list-style-type: none"> • Performance mode: Change the system's performance mode.
F12 	<ul style="list-style-type: none"> • Fn Lock: Lock the Fn key so that hot keys can be used without pressing the Fn key.



If the hot keys do not work properly, install the **Samsung Settings** application.

Touchpad

Use the touchpad to move the cursor or select an item. The left and right buttons of the touchpad act the same as the left and right buttons of a mouse.



- Use the touchpad only with fingers. The touchpad will not recognize actions of other objects.
- Images and the touchpad layout may differ depending on the model.

Basic touchpad functions

Moving

To move the cursor, move a finger on the touchpad.

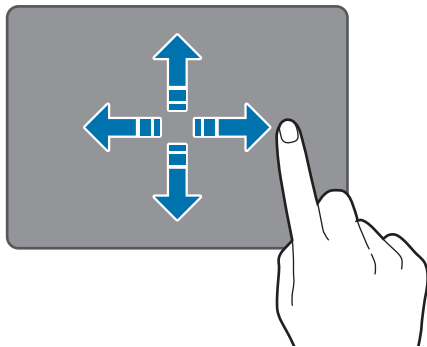

Clicking

Tap the touchpad or press the left touchpad button.

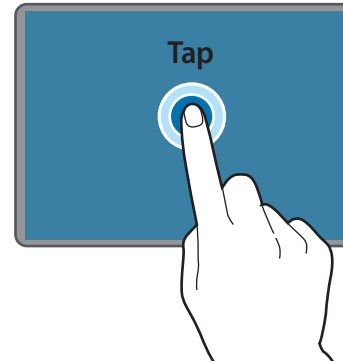

or

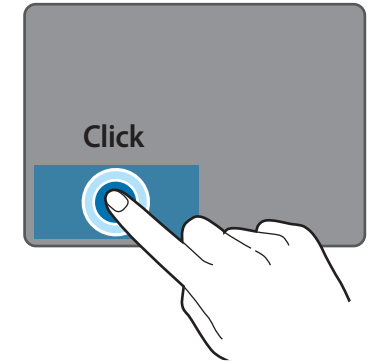

Double-clicking

Double-tap the touchpad or press the left touchpad button twice.

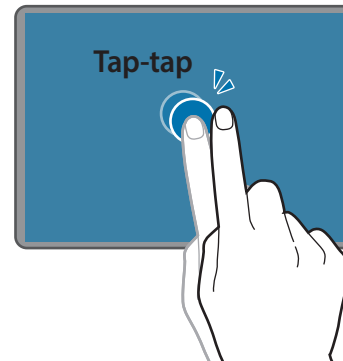

or

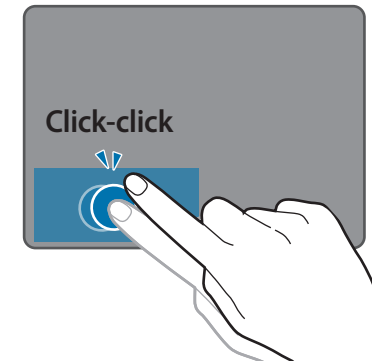

Right-clicking

This function enables right-clicking.

To right-click an item, press the right touchpad button.

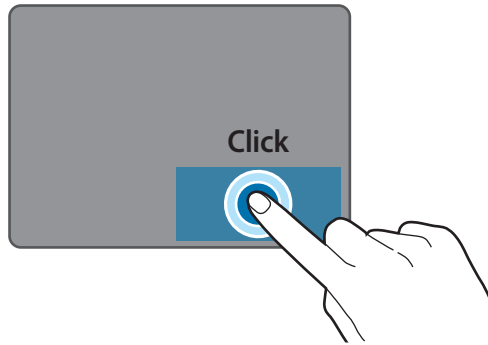

Dragging

To move an icon or an app tile to a desired location, press and hold it and then drag it to the target position with the left touchpad button pressed.

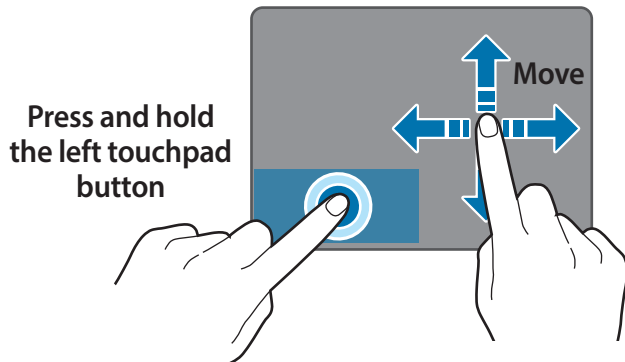

Gesture functions

Swiping

To scroll up, down, left or right to a desired location, swipe with two fingers on the touchpad.

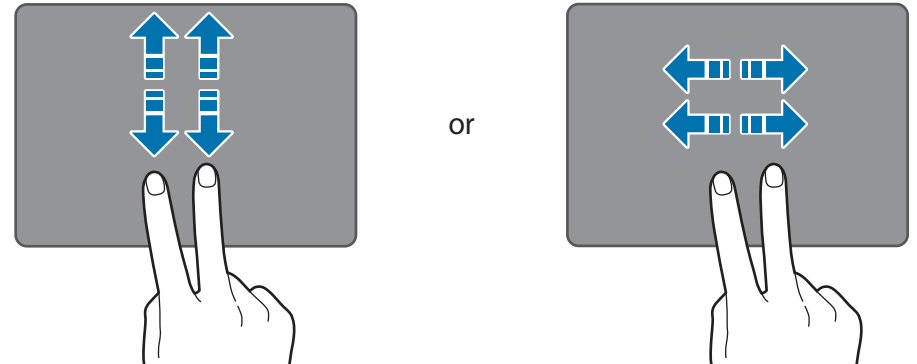

Pinching

To zoom in, spread two fingers apart while viewing a website, map, or image. Pinch to zoom out.

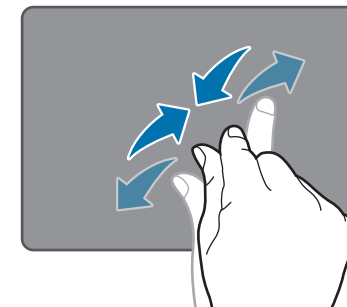

Configuring touchpad gestures

Configure touchpad gestures to use the touchpad more efficiently.

Select the Start button (■) → ⚙️ → **Devices** → **Touchpad** → desired options.



Some options in the touchpad settings may not be available depending on the model.

Touchpad lock

Press and hold the **Fn** key and press the **F5** key to lock the touchpad.

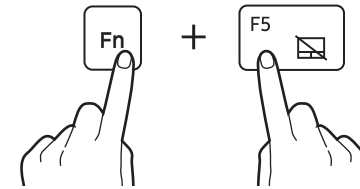

SIM or USIM card (nano-SIM card) tray (LTE models only)

Insert the SIM or USIM card.



- Use only a nano-SIM card (sold separately).
- Use caution not to lose or let others use the SIM or USIM card. Samsung is not responsible for any damages or inconveniences caused by lost or stolen cards.



- It is only for data network. The calling feature is not supported.
- Some services that require a network connection may not be available depending on the service provider.

Installing the SIM or USIM card

1 Insert the ejection pin into the hole on the tray to loosen the tray.



Ensure that the ejection pin is perpendicular to the hole. Otherwise, the device may be damaged.

2 Pull out the tray gently from the tray slot.



Be careful to not hurt your fingertip while pulling out the tray.

3 Place the SIM or USIM card on the tray with the gold-coloured contacts facing downwards.

4 Gently press the SIM or USIM card into the tray to secure it and insert the tray back into the tray slot.

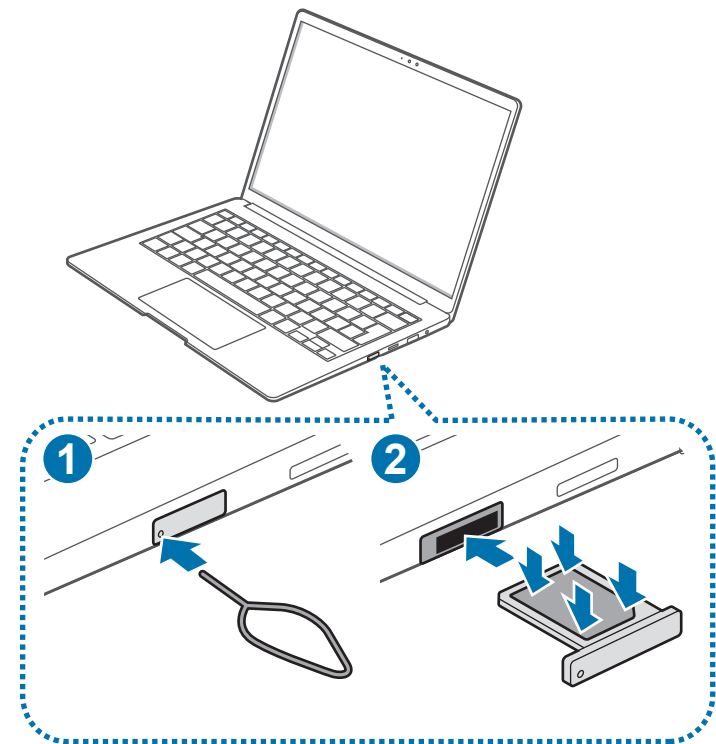

Cellular data (LTE models only)

You can insert the SIM or USIM card so you can access the Internet using your cellular data connection.



You may incur additional charges when using a mobile network.

Turning the cellular data on

On the taskbar, select  → **Cellular**.

Cellular data will be connected.

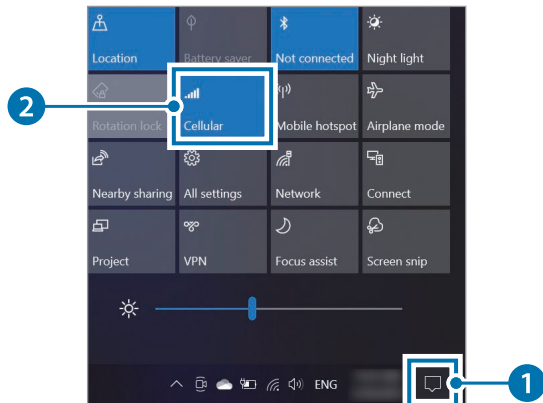

Turning the cellular data off

To save battery power, turn off the cellular data when not in use.

1 On the taskbar, select .

2 Select **Cellular**.

Cellular data will be disconnected.

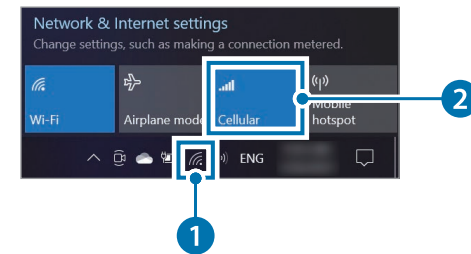



Fingerprint recognition

You can sign in to Windows, apps, and services by teaching Windows to recognize your fingerprint.

Registering your fingerprint

Create a password and PIN first to use the fingerprint scan feature.

- 1 Select the Start button () →  → **Accounts** → **Sign-in options**.

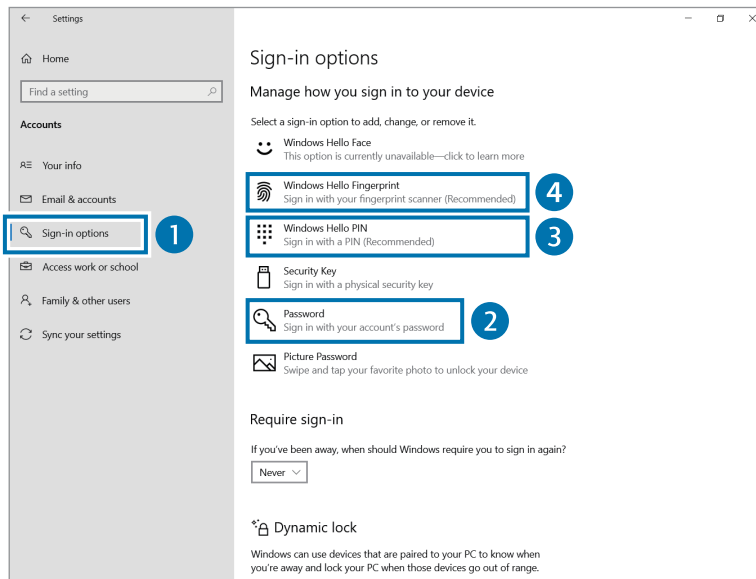

- 2 Select **Password** → **Add** to create a password.
- 3 Select **Windows Hello PIN** → **Add** to create a PIN number.
- 4 Select **Windows Hello Fingerprint** → **Set up** to start the fingerprint registration.
- 5 Select **Get started** on the **Windows Hello setup** window.
- 6 Enter your PIN in the **Making sure it's you** window.
- 7 Repeatedly lift and rest your finger on the fingerprint recognition sensor until setup is complete.

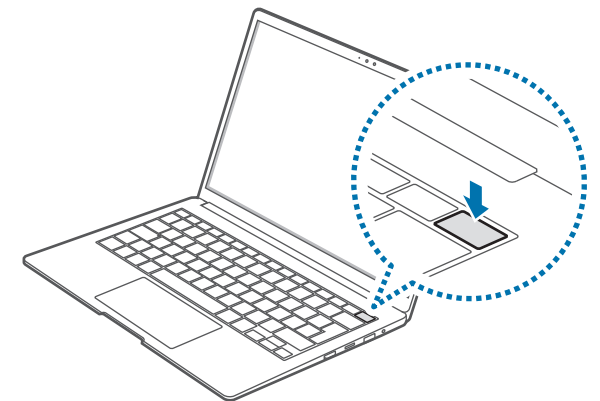
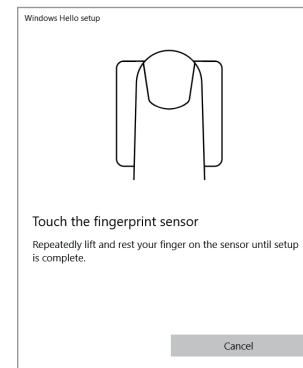

The fingerprint recognition sensor's location may vary depending on the model.

8 Fingerprint registration is complete.

If you want to add another fingerprint, select **Add another**.

Removing a fingerprint

1 Select the Start button (■) → ⚙️ → **Accounts** → **Sign-in options**.

2 Select **Windows Hello Fingerprint** → **Remove**.

The fingerprint will be removed.

Unlocking the screen with a fingerprint

You can unlock the screen by resting your fingerprint on the fingerprint recognition sensor.

Place a registered finger on the fingerprint recognition sensor.

The screen will be unlocked if the fingerprint is scanned correctly.

For better fingerprint recognition

- Prevent the fingerprint recognition sensor from being scratched or damaged by metal objects, such as coins, keys, and necklaces.
- Ensure that the fingerprint recognition sensor and your fingers are clean and dry.
- The fingerprint recognition sensor may not recognize fingerprints that are affected by wrinkles or scars.
- The fingerprint recognition sensor may not recognize fingerprints from small or thin fingers.
- If you bend your finger or use your fingertips, the fingerprint recognition sensor may not recognize your fingerprints. Make sure to cover the entire fingerprint recognition sensor with your finger.
- To improve recognition performance, register the fingerprints of the hand you use most often to perform tasks.
- In dry environments, static electricity can build up in the computer. Avoid using this feature in dry environments or before using the feature, discharge static electricity by touching a metal object.

Memory card slot

Use a memory card to transfer data to other devices. You can use data stored on your device, such as digital cameras, smartphones, or tablets, on your computer, or you can take your saved data to another device.

Memory cards are sold separately.

This computer supports the following types of memory cards.

Abbreviation	Description
micro SD	• micro Secure Digital
micro SDHC	• micro Secure Digital High Capacity
micro SDXC	• micro Secure Digital eXtended Capacity



- Some memory cards may not be fully compatible with the computer. Using an incompatible card may damage the computer or the memory card, or corrupt the data stored in it.
- Use caution to insert the memory card in the indicated direction.
- Store the card separately to prevent losing the card when moving the computer.
- Memory card speeds vary.

Inserting a memory card

- 1 If a dummy card or a memory card adapter is inserted in the memory card slot, remove it.
- 2 Insert a memory card into the memory card slot in the indicated direction until it clicks into place.

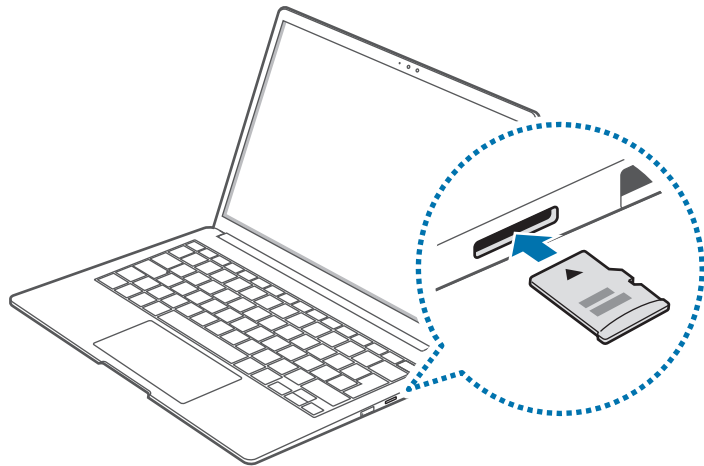

- 3 If a pop-up message appears, choose an action.
- 4 Select **Open folder to view files**.
- 5 Save, move, or delete data on the memory card.
The memory card folder opens only on the desktop.

Removing a memory card

When you push the card, it clicks and disengages from the memory card slot. Grasp the end of the card and pull it out of the slot.

Formatting a memory card

Format the memory card to remove all data or before using it for the first time.

 Formatting a memory card deletes all data saved on the card. If necessary, back up important data before formatting the card.

- 1 On the taskbar, select File Explorer ()
- 2 Right-click the memory card drive, and then select **Format**.

3 Select **Start**.



- To use a memory card to exchange data with a digital device, such as a digital camera, formatting the data with the digital device is recommended.
- When trying to use a formatted memory card in another digital device, format the memory card again in the device.
- Data protected by copyright laws cannot be reviewed or modified.
- Inserting and removing a memory card repeatedly may damage the memory card.
- Secure Digital Input Output (SDIO) is not supported.
- If the write-protect tab is in the locked position, you cannot format, write, or delete data on the card.

External display

Connecting the computer to an external display device can be useful for presentations or when watching a movie. The cables and adapters required to connect an external display are sold separately. The computer supports HDMI cables, USB Type-C and Thunderbolt™ display cables.

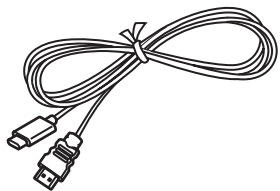

USB Type-C or Thunderbolt™ display cable

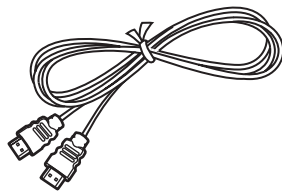

HDMI cable



Check the available ports on the display device to ensure that it is compatible with the computer.

Connecting to a display

- 1 Connect the cable to the USB Type-C port or Thunderbolt™ 4 port of the computer.

- 2 Connect the other end of the cable to the HDMI port of the external display.



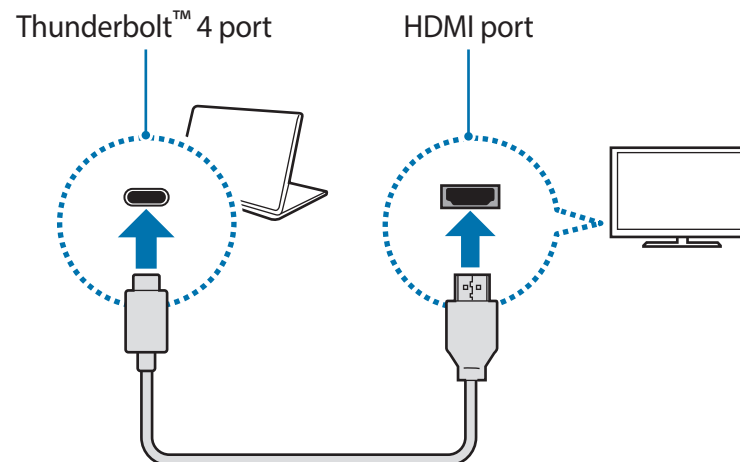

<When using a USB Type-C or Thunderbolt™ display cable>

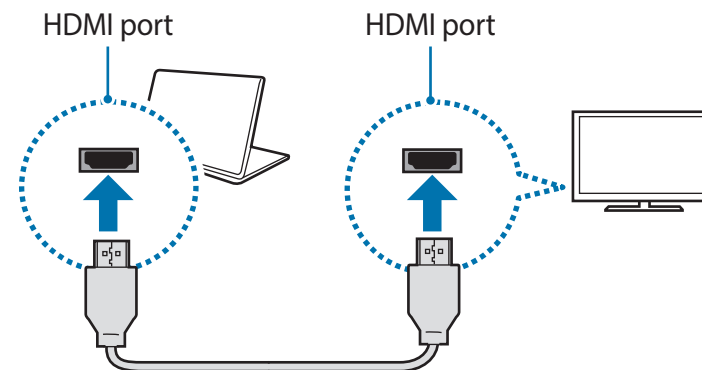



<When using an HDMI cable>



- 3 Connect the power cord to the external display.
- 4 Turn on the display and change its display mode to one that supports an external input.
- 5 Press and hold the **Fn** key and press the **F4** key.
- 6 Select a mode.

	PC screen only Show the screen on the computer monitor only.
	Duplicate Show the screen on both the computer and the external display.
	Extend Extend the screen to the external display.
	Second screen only Show the screen on the external display only.



You can also select the display mode in Windows settings. Select the Start button () →  → **System** → **Display**, and then select **Detect** on the **Multiple displays** option.

Wireless LAN

Connect the computer to a wireless network to use the Internet.



The descriptions below are for computer models with a Wireless LAN card or device. A Wireless LAN device is optional. The pictures in this manual may differ from the actual product depending on the wireless LAN device model.

About Access Point (AP)

An Access Point (AP) is a network device that bridges wired and wireless LANs and corresponds to a wireless hub in a wired network. Multiple devices can be connected to an AP.

Connecting to a Wi-Fi network

1 On the taskbar, select  → **Network**.

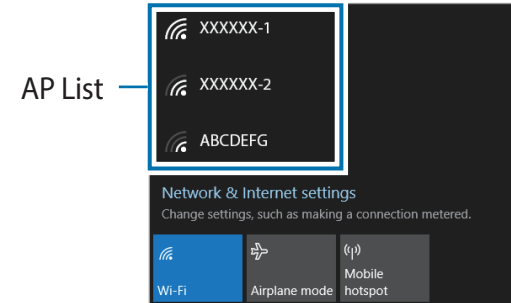

- 2 Select a network from the list of detected wireless networks and select **Connect automatically** → **Connect**.

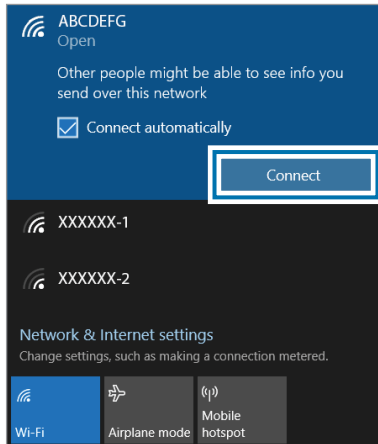

- 3 Enter a password, if necessary, and select **Next**.

Once the computer has been connected to a wireless network, it will attempt to connect to it automatically when it is available. If you require a network password, contact the system administrator.

Deactivating the Wi-Fi feature

When you are not using the Wi-Fi feature, turn it off to save battery power.

- 1 Select  on the taskbar.
- 2 Select **Wi-Fi**.
The Wi-Fi feature is deactivated.

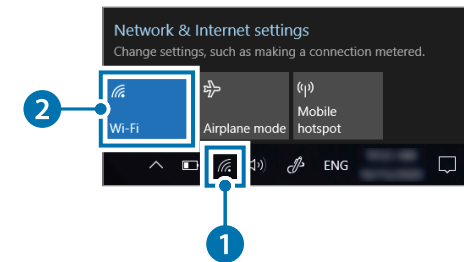

Airplane mode

This disables all wireless functions on your computer. You can use only non-network services.

To activate **Airplane mode**, on the taskbar, select  → **Airplane mode**.

Bluetooth

Use Bluetooth to listen to music or exchange data or media files with other Bluetooth-enabled devices.



- Samsung is not responsible for the loss, interception, or misuse of data sent or received via Bluetooth.
- Always ensure that you share and receive data with devices that are trusted and properly secured. If there are obstacles between the devices, the operating distance may be reduced.
- Some devices, especially those that are not tested or approved by the Bluetooth SIG, may be incompatible with your device.
- Do not use the Bluetooth feature for illegal purposes (for example, pirating copies of files or illegally tapping communications for commercial purposes). Samsung is not responsible for the repercussion of illegal use of the Bluetooth feature.

Pairing with other Bluetooth devices

- 1 Select  on the taskbar.
- 2 Check if the Bluetooth feature is on.

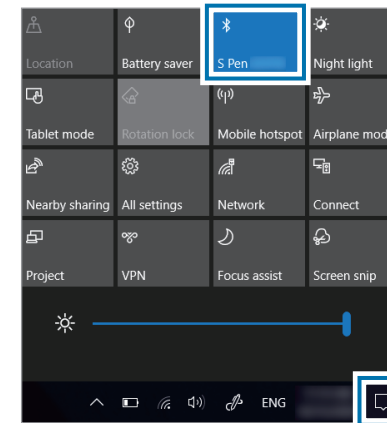

Select **Expand** to expand the action center menu when the Bluetooth menu does not appear.

- 3 Select the Start button () →  → **Devices** → **Bluetooth & other devices** → **Add Bluetooth or other device**.

- 4 Select **Bluetooth** to select a device you want to add and finish pairing.

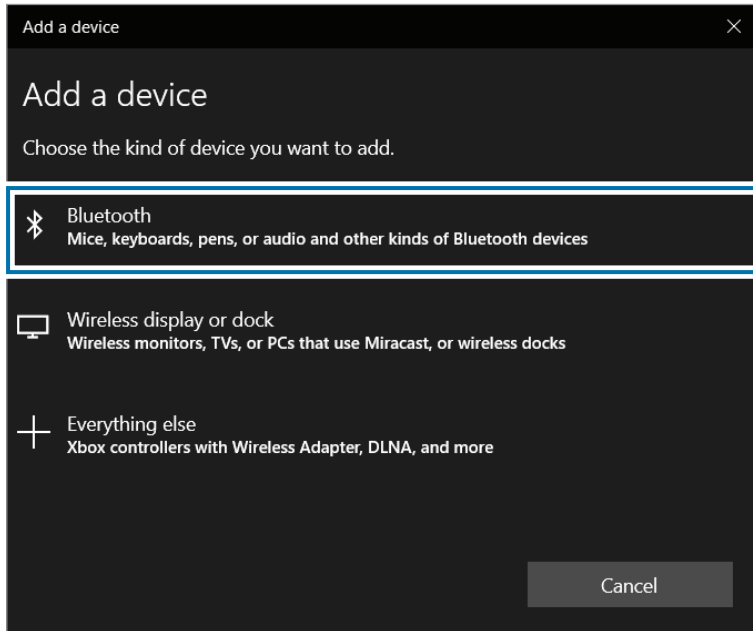

Unpairing Bluetooth devices

- 1 Select the Start button (Windows logo) → Settings (gear icon) → **Devices**.
Your computer will display the paired devices.
- 2 Select the device to unpair from your computer and select **Remove device** → **Yes**.
The connection to the Bluetooth device will be disconnected.

Thunderbolt™ 4

You can use Thunderbolt™ devices or share files and printers by connecting two computers that support Thunderbolt™.

Using Thunderbolt™ devices

Connect the Thunderbolt™ device to the Thunderbolt™ 4 port.

Connecting two computers that support Thunderbolt™

- 1 Use a Thunderbolt™ cable (sold separately) to connect the computers via their Thunderbolt™ 4 ports.
- 2 Select the Start button (🪟) → Windows System → Control Panel → Network and Internet → Network and Sharing Center → Change advanced sharing settings.

- 3 Set your network profile sharing options and select **Save changes** to save your settings.

The following screen is an example of selecting **Turn on network discovery** and **Turn on file and printer sharing**.

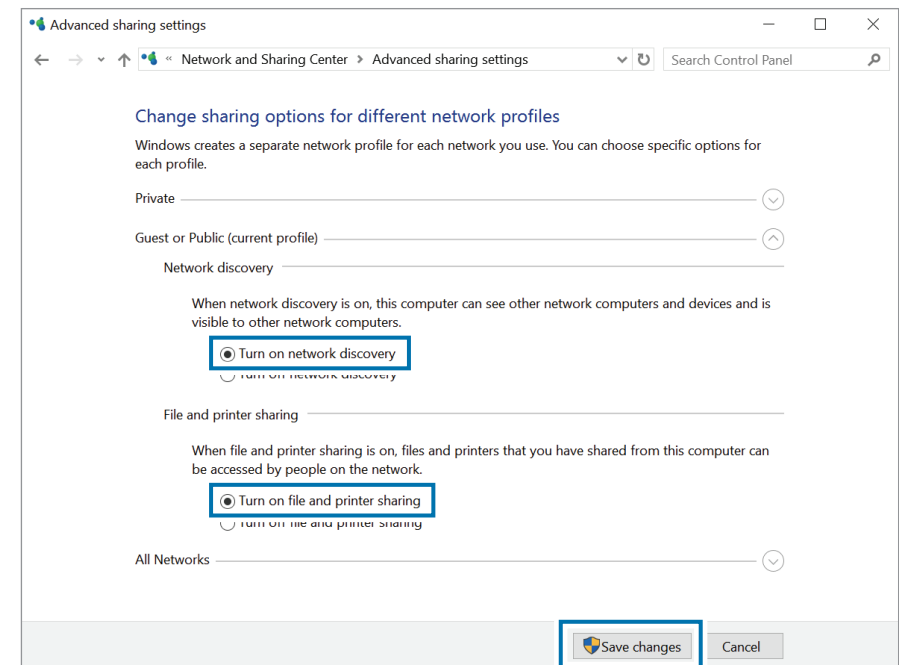

- 4 On the main computer's Desktop, select the icon for the connected computer to access the folder being shared.



If the computer does not properly scan your Thunderbolt™ device after connecting it

After removing a Thunderbolt™ device, you can connect a new Thunderbolt™ device after a few seconds. Your computer may fail to recognize a device connected immediately after removing the previous device.

Applications

Using applications



- Images and features may differ depending on the model and the application version.
- Some applications may not be supported depending on the model.
- Applications that are provided by Samsung can be installed from **Samsung Update**.
- **Third-party software related services**
For descriptions about and service requests for third-party applications, please contact the relevant manufacturer. Some troubleshooting actions in response to service requests may not work depending on the application manufacturer.

Samsung Settings

Samsung Settings, a Samsung-integrated settings application, offers various settings functions.



Images and features may differ depending on the model and the application version.

- 1 Select the Start button (■) → **Samsung Settings**.
- 2 Select an option to configure the corresponding function.

Menu	Description
System	<ul style="list-style-type: none"> • Set system settings.
Connections	<ul style="list-style-type: none"> • Set connection settings, such as the Bluetooth connection.
Display	<ul style="list-style-type: none"> • Set the appropriate color for the user environment and related settings.
Battery	<ul style="list-style-type: none"> • Set battery settings.
Audio	<ul style="list-style-type: none"> • Set sound settings.
Input	<ul style="list-style-type: none"> • Set input functions and settings.
Camera	<ul style="list-style-type: none"> • Set Camera app settings.
Quick settings	<ul style="list-style-type: none"> • Manage the quick settings displayed on the taskbar.
About	<ul style="list-style-type: none"> • View the application version.

Samsung Security

Create a privacy folder to hide private files on your computer from other users. Also, you can set the various privacy protection feature such as the secret screen feature or blocking recording feature.



Features may differ depending on the model and the application version.

Using the privacy folder

Set a folder as the privacy folder and hide private files in your computer from other users. To set the privacy folder, you need a password set up for Windows.



- You cannot create more than one privacy folder. If you have already set up a privacy folder, change or unlock it to use a new one.
- Folders located on the desktop or certain folders related to Windows cannot be selected as privacy folders.

Setting the privacy folder

1 Select the Start button (■) → **Samsung Security**.

2 Select **Privacy Folder** → **Create Windows password**.

Follow the on-screen instructions to create a password.



If you have already set a Windows password, this step will not appear.

3 Select **Set folder settings**, and enter your password, then select **OK**.

4 Select **Select Folder** and select a folder as the privacy folder. When folder setup is complete, the folder will be changed to hidden.

Showing the privacy folder

1 Press and hold the  key and press the **F12** key.

Alternatively, select the Start button (■) → **Samsung Security** → **Privacy Folder** and select the **Hide** switch.

2 Enter the password and select **OK**.

3 Check the privacy folder in the File Explorer. You can save or move files into the privacy folder.

Hiding the privacy folder

Press and hold the  key and press the **F12** key to hide the privacy folder.

Alternatively, select the Start button () → **Samsung Security** → **Privacy Folder** and select the **Show** switch.

The privacy folder will not appear in the File Explorer.



If the **Fn Lock** key turns on, the hot key of the privacy folder may not work. Press the hot key and use the feature when the **Fn Lock** key turns off.

Setting the secret screen

When you work with your private information or open a window you wish to keep private, create a secret window to prevent an invasion of your privacy.

1 Select the Start button () → **Samsung Security**.

2 Select **Secret Screen**.

3 Select a secret screen effect and drag the adjustment bar to set the opacity or darkness level.

- **Dark Screen Effect:** Make the window black.
- **Opacity Effect:** Make the window transparent.

Using the secret screen

Press and hold the  key and press the **F11** key to enable the secret screen.



- The secret screen feature may not be available depending on the program in use.
- If the **Fn Lock** key turns on, the hot key of the secret screen may not work. Press the hot key and use the feature when the **Fn Lock** key turns off.

Using block recording

If your computer is hacked, the block recording feature prevents the use of the camera and the microphone. You can protect your computer system and your privacy safely.

Select the Start button () → **Samsung Security** → **Block Recording** and then select the switch to turn on the block recording feature.

Using the security cam feature

Use the security cam feature on the login screen when you leave your seat while turning on your computer. If someone tries to use your computer without permission, you will receive an email containing the usage information and a picture of the person who tried to use your computer.

- 1 Select the Start button () → **Samsung Security**.
- 2 Select **Security Cam** and then select the switch to turn on the security cam feature.
- 3 Follow the on-screen instructions to complete the security cam feature's settings.

The security cam feature will now run on the login screen.



If you turn off the security cam feature, the entered email information will be removed.

Samsung Update

Install and update Samsung applications and drivers on the computer easily and conveniently. This application enables the user to search for or download the BIOS, drivers, and applications over the Internet. Keep the computer performing better and more stably with **Samsung Update**.



- To check for available updates, the computer must be connected to the Internet.
- Only applications that have been installed with this application can be updated.
- Images and features may differ depending on the model and the application version.

1 Select the Start button () → **Samsung Update**.

2 Read and agree to the User Agreement.

This step appears only when the application runs for the first time.

3 Select **Update all**. Or, select **Install** or **Update** of the item to be updated.

The items will be updated.

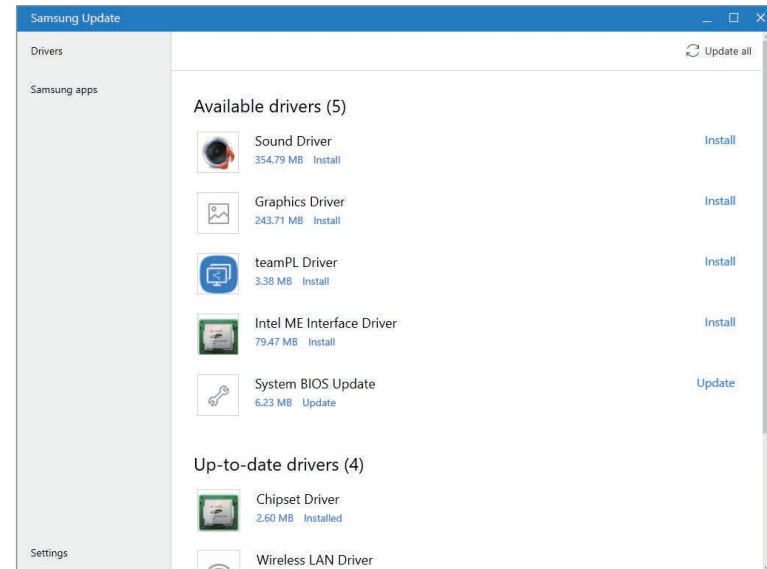

Online Support (S Service)

A service associate can resolve any problems you have with your computer using the online chat and remote control program. You can receive the help when you are having trouble using Samsung software.

You can access the online service for free for a certain period of time after purchasing your computer.



- **Online Support (S Service)** may not be offered or its version may be different depending on the model you are using.
- If **Online Support (S Service)** is not installed, select the Start button (Windows logo) → **Microsoft Store** (Microsoft Store icon) and, search for **S Service** to download it.

1 Select the Start button (Windows logo) → **Online Support (S Service)**.

2 Select **Online Support (S Service)** on the main page. Enter the **Contents** and select **Request**.

Online Support (S Service)

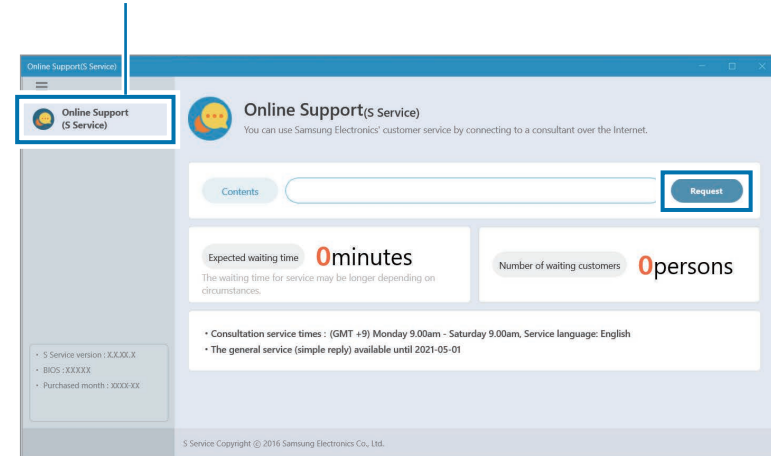

3 You can speak to a service associate to resolve your computer's problems.



Waiting times may vary depending on the network and number of waiting customers.

Samsung PC Cleaner

Samsung PC Cleaner helps your computer maintain its performance by using the timeline manager feature and the system cleaner feature.



The screen and available features may differ depending on the model and the application version.

Select the Start button () → **Samsung PC Cleaner**.

System Cleaner

Timeline manager

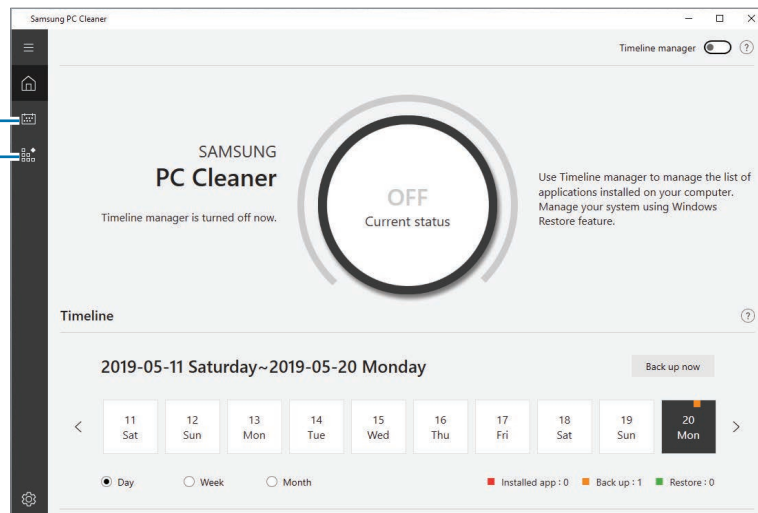

Timeline manager

Timeline manager tracks your application installation history and helps you manage computer performance by automatically managing your Windows backup points. You can manage the list of applications installed on your computer and your system using the Windows Restore feature.

System Cleaner

You can optimize the computer's performance by freeing up system resources that are not in use.

Screen Recorder

Record the screen while using your computer.

- 1 Select the Start button (■) → **Screen Recorder**.

The screen recorder toolbar will appear on the top of the screen.



- 2 Select **Screen Recorder** to start recording.

After a countdown, recording will start.

- To change the screen recorder settings, select ⚙ before starting recording.
- To capture the screen, select 📹.
- To record the screen with a video overlay of yourself, select 👤. The web cam window will appear on the top left of the screen.
- To write or draw on the screen, select ✎. The available toolbar will appear on the right side of the screen.



- 3 When you are finished recording the screen, select ■. You can view the file in **This PC** → **Videos** or **Pictures**.

- 4 Select ✕ to finish the screen recorder toolbar.



- When the screen recorder toolbar disappears, move the mouse cursor to the top-center of the screen to make it reappear.
- If there is not enough space to save the file, the Screen Recorder application will automatically end.
- If your computer enters sleep mode while recording the screen, the recording will be paused and continue after waking up from sleep mode.
- If your computer turns off abnormally while recording the screen, the recorded file will not play normally.
- You cannot record the gaming screen with the Screen Recorder application, and some programs may not support the screen record or capture feature.

Setting the video resolution

- 1 Select the Start button () → **Screen Recorder**.
The screen recorder toolbar will appear on the top of the screen.
- 2 Select .
The **Settings** window will appear.
- 3 Select **Display** and select the resolution you want under **Set video resolution**.

Quick Search

Search for content on the computer quickly.

- 1 Select the Start button () → **Quick Search**.
- 2 Tap the search field to enter a keyword.
Content on your computer will be searched.
If you choose a search category, you can get more exact results.

Samsung Flow

Samsung Flow allows you to easily connect your mobile device to your computer to complete tasks, such as checking notifications or sharing content, more conveniently.

- 1 Select the Start button (🖱️) → **Samsung Flow**.
- 2 On your mobile device, launch the Samsung Flow application. If Samsung Flow is not installed, download it from the Galaxy Store or Play Store.
- 3 Tap **Start**.
- 4 Select your mobile device from the detected devices list.
- 5 Confirm the passkey on both devices and tap **Ok**.
The devices will be connected.



- This feature is only available on some Samsung Android devices.
- Refer to the mobile device's user manual for more information about how to use Samsung Flow.

Samsung Studio Plus

Create and edit videos easily using photos and videos in your computer.

- 1 Select the Start button (🖱️) → **Samsung Studio Plus**.
- 2 Select **New project**.
- 3 Select **Add Files** or **Add a folder** to add files and tap **OK**.
- 4 Edit the video by inserting music or text.



- 5 When you are finished editing the video, tap **Export** to save the video.

Samsung Voice Note

While recording lectures or meetings, insert a bookmark or write a memo at important content.

- 1 Select the Start button (🗄️) → **Samsung Voice Note**.
- 2 Tap **Start Samsung Voice Note**.
- 3 Tap 📍 to start recording.

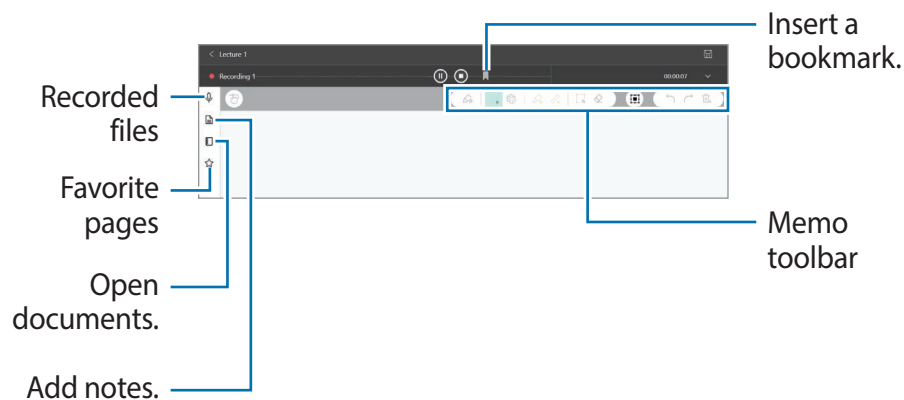

- 4 Tap 🛑 to finish recording.
- 5 Enter a file name and tap **Save**.

Samsung Gallery

View images and videos stored in your computer. You can also sync content with the cloud to update in real time and safely store content across the devices using the same account.

Syncing with the cloud

- 1 Select the Start button (🗄️) → **Samsung Gallery**.
- 2 Tap ⋮ → **Settings**.
- 3 Tap the **Sync with Cloud** switch.

The content in the **Samsung Gallery** application and the cloud will be synced.



To use this feature, you must sign in to your Samsung account.

Settings & Upgrade

Display brightness

Adjust the display brightness to reduce eye strain and save power.

Controlling brightness using the keyboard

- To dim the display screen, press and hold the **Fn** key and press the **F2** key.

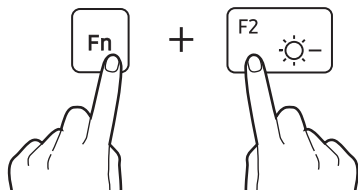

- To brighten the display screen, press and hold the **Fn** key and press the **F3** key.

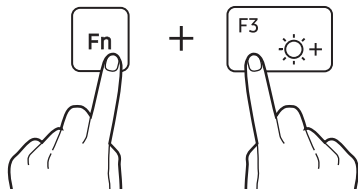

Controlling brightness using the taskbar

- 1 On the taskbar, select .
- 2 Drag the adjustment bar to the desired brightness.

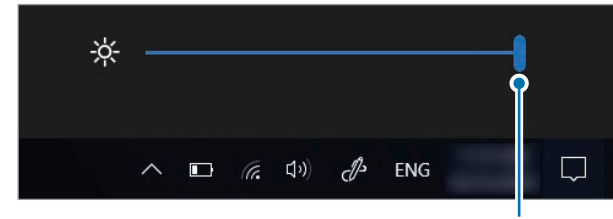

Brightness adjustment bar

-  • The display screen is automatically set to the brightest level when the AC adapter is connected. The display screen automatically becomes dimmer when the AC adapter is disconnected.
- The computer has an automatic screen brightness adjustment to extend the battery usage time. When necessary, the screen brightness is gradually adjusted.

Changing display mode

Select the optimal screen settings based on your activity.



Some options may not be available depending on the model.

- 1 Select the Start button (■) → **Samsung Settings**.
- 2 Select **Display** → **Auto mode**, and then select an option.
 - **Auto mode**: Optimizes the screen automatically for the currently running program.
 - **Vivid (AMOLED native)**: Makes scenes more vivid and clear using AMOLED color space.
 - **Natural (sRGB)**: Make videos natural using sRGB color space.
 - **PhotoEdit (Adobe RGB)**: Optimizes photo editing using Adobe RGB color space.
 - **Movie (DCI-P3)**: Optimizes for movies using DCI-P3 color space.

Optimizing the full screen color balance

Optimize the screen color by adjusting the color tones to your preference.

- 1 Select the Start button (■) → **Samsung Settings**.
- 2 Select **Display** → **Advanced color settings**.
- 3 Drag the color adjustment bar to the desired color tone.

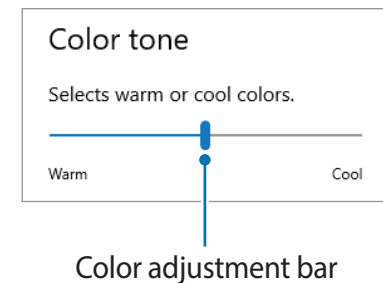

Volume

Adjust the system volume or sound volume when playing music or video.

Controlling volume using the keyboard

- To turn down the volume, press and hold the **Fn** key and press the **F7** key.

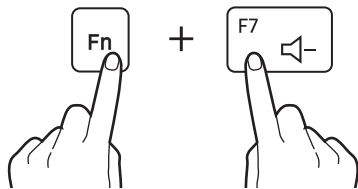

- To turn up the volume, press and hold the **Fn** key and press the **F8** key.

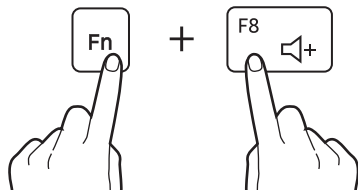

- To mute or unmute the volume, press and hold the **Fn** key and press the **F6** key.

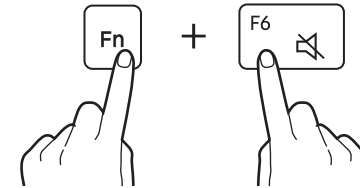

Controlling volume using the taskbar

- 1 Select  on the taskbar.
- 2 Drag the adjustment bar to the desired volume.

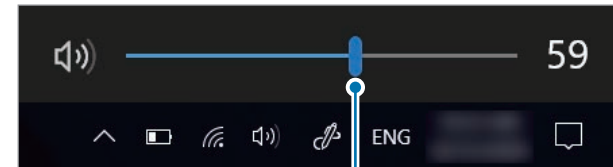

Volume adjustment bar

BIOS (Setup utility)

Define a boot password, change the boot priority, or configure the installed chipsets.



- Incorrect settings may cause the system to malfunction or crash.
- The BIOS setup screens, menus, and items may appear differently depending on the model and BIOS version.
- BIOS setup functions are subject to upgrades.

Entering the BIOS screen

- 1 Turn on the computer.
- 2 Before the Samsung logo appears, press the **F2** key several times.
 - If the computer is password-protected, press the **F2** key several times before the password screen appears.
 - If the password screen or the Windows start screen appears, restart the computer and try again.

The BIOS screen

The BIOS setup screen appears as shown below.

You can change BIOS settings using the keyboard or mouse.

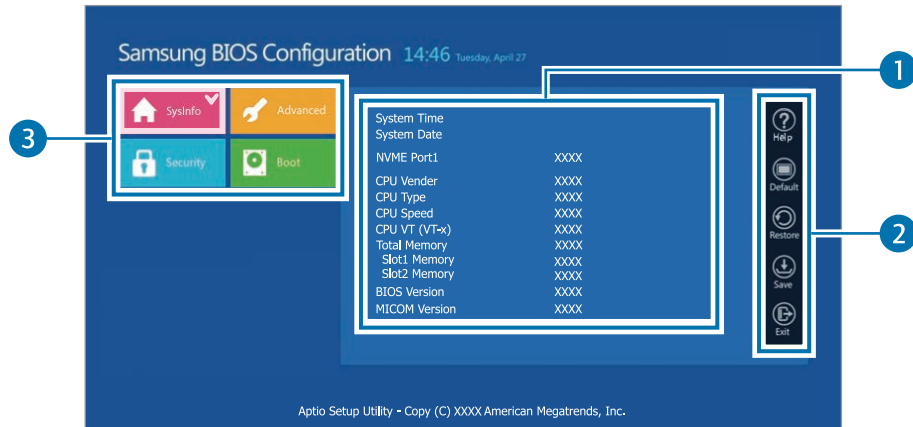

Number	Name
1	<ul style="list-style-type: none"> • Setup items
2	<ul style="list-style-type: none"> • Setup tools <ul style="list-style-type: none"> – Help: View the help for BIOS set up. – Default: Return to the default settings. – Restore: Cancel changes. – Save: Save settings. – Exit: Exit BIOS setup.
3	<ul style="list-style-type: none"> • Setup menu <ul style="list-style-type: none"> – SysInfo: View the basic specifications of the computer. – Advanced: Configure the chipsets and additional functions. – Security: Configure security functions. – Boot: Configure peripherals and boot-related settings.



The BIOS setup screen appears only in English.

Boot password

Setting a password with the BIOS enhances protection against viruses and hacking attacks.



- Do not forget your password or expose it to others.
- If you forget the **Supervisor Password** or **HDD Password**, request assistance from the Samsung Service Center. In this case, a service fee will be charged.
- If you forget the **User Password**, disable the **Supervisor Password**, and the **User Password** will also be automatically disabled.

Setting passwords

There are three password settings available: **Supervisor Password**, **User Password**, and **HDD Password**.

- **Supervisor Password** (low security level): This password is required when turning on the computer or entering the BIOS setup.
- **User Password** (low security level): This password is required to enter the BIOS setup. This password will be deactivated automatically if the **Supervisor Password** is disabled.
- **HDD Password** (high security level): This password is required to access the hard disk drive (HDD) from another computer. This password may not be supported, depending on the model or storage device.

Setting a boot password

- 1 Turn on the computer.
- 2 Before the Samsung logo appears, press the **F2** key several times.
- 3 Access the **Security** menu.
- 4 Select a password type (**Supervisor Password**, **User Password**, or **HDD Password**).

If you cannot select an item or the **HDD Password Frozen** message appears, turn off the computer and turn it on again. Then, press the **F2** key several times before the Samsung logo appears to enter the BIOS setup screen.

- 5 Enter a password and select **Ok**.
The password can be up to 20 characters.
- 6 Enter the password again to confirm it and select **Ok**.
- 7 Select **Save** → **Ok** to save and restart.



- To enable the **Password On Boot** option, set a **Supervisor Password** and enter the password when starting up the computer.
- For some models, if the password entered message appears in the Setup Notice window, select **Ok** to complete the setup.

Removing a password

- 1 Turn on the computer.
- 2 Before the Samsung logo appears, press the **F2** key several times.
- 3 Access the **Security** menu.
- 4 Select a password type (**Supervisor Password**, **User Password**, or **HDD Password**).
- 5 Enter the current password and select **Ok**.
- 6 Without entering any characters, select **Ok** → **Ok**.
- 7 Select **Save** → **Ok** to save and restart.



For some models, to cancel the password, select **Cancel** in the Setup Notice window.

Boot priority

Change the boot priority from the BIOS setup.

- 1 Turn on the computer.
- 2 Before the Samsung logo appears, press the **F2** key several times.
- 3 Access the **Boot** menu.
- 4 Select **Boot Device Priority**.
- 5 Select an option menu to open the list.
- 6 Select an option.
- 7 Select **Save** → **Ok** to save and restart.
Select **Exit** → **Ok** to restart without saving the changes.

Using the Battery Calibration Function

When charging/discharging the battery repeatedly for a short time only, the battery usage time may be reduced by the difference between the actual battery charge and the remaining charge display.

You can make the actual battery charge and the remaining charge display the same by discharging the battery completely using the Battery Calibration function, and then recharging it again.



The screen images and terms may differ from the actual product depending on the computer model and driver version.

- 1 Turn off the computer and then disconnect the AC power adapter.
- 2 Turn the computer back on, and press the **F2** key to enter the Setup screen.

- 3 Select **Advanced** → **Smart Battery Calibration**.

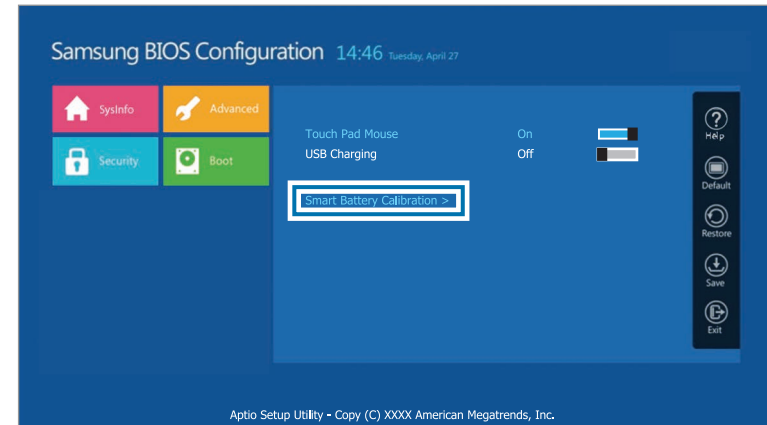

- 4 The Battery Calibration function is activated and the battery is forcefully discharged. To stop the operation, press the **Esc** key. This operation requires 3–5 hours depending on the battery capacity and the remaining battery charge.

Battery

Fully charge the battery using the AC adapter before using the computer for the first time.



- Use only Samsung-approved AC adapters, batteries, and cables. Unapproved adapters or cables can cause the battery to explode or damage the computer.
- Incorrectly connecting the charger may cause serious damage to the computer.
- This computer is equipped with an internal battery. The battery is not user-serviceable or user-replaceable.
- To safely remove or replace the battery, take the device to a Samsung Service Center. You will be charged for this service.
- You can use the computer while it is charging, but the battery charging time may increase. If the battery temperature rises too much, the charging may stop as a safety measure.



To restore the battery power after cutting it, connect the AC adapter.

Charging the battery

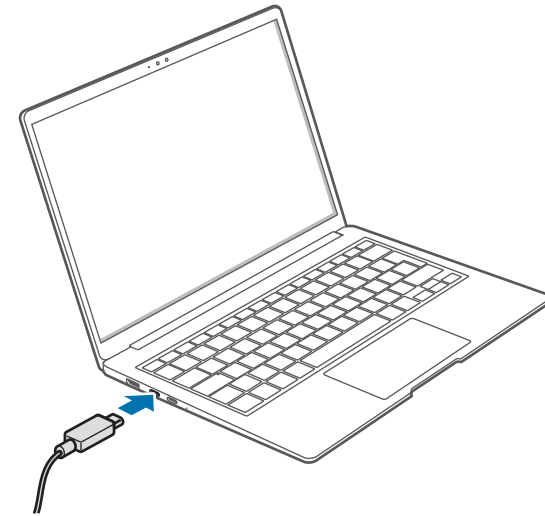

- 1 Connect the AC adapter to the Thunderbolt™ 4 or the USB Type-C port of the computer.

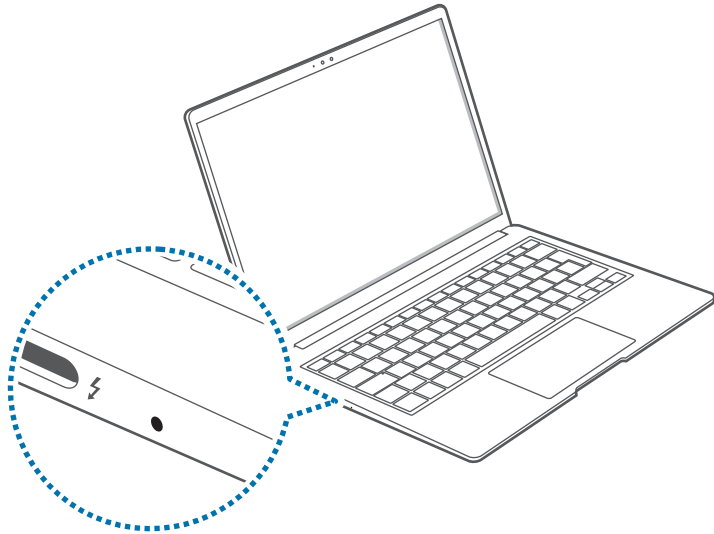

- 2 Plug the AC adapter into an electric socket.

- When the battery is fully charged, the operating status LED turns green. Disconnect the AC adapter from the computer.



Operating status LED	Status
	• Red: Charging
	• Green: Fully charged
	• Blue: Turned on

- Unplug the AC adapter from the electric socket.



Do not allow the adapter to make contact with your skin for a long time. A low-temperature burn may result.

Battery status

When the AC adapter is removed, move the cursor over the battery icon on the taskbar to view the current battery charge.

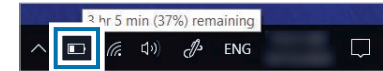

Viewing the current battery charge when the computer is turned off

Connect or disconnect the AC adapter from the computer to view the current battery charge when the computer is turned off.

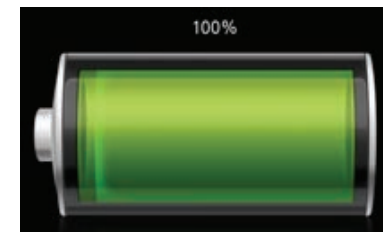

Saving battery power

On the taskbar, select  → **Battery saver**.

Battery saver mode is activated.



Battery saver mode is disabled when the AC adapter is connected.

Battery usage time

Batteries are replaceable items and over time the battery's capacity to hold a charge and its power level is reduced. If a battery can only hold its charge for half of the time that it could when new, it is recommended to purchase a new, replacement battery.

Checking battery life instruction messages

When the battery has expired, an instruction message may appear on the screen. To prevent the computer from losing data and to use the computer safely, follow the on-screen instructions.

When battery expiration is imminent

Batteries are consumable parts and the remaining battery life is currently low. Continued use may result in charge or discharge failures. Whether or not batteries can be used is determined based on safety evaluations. Please replace it with a new battery (genuine) to prevent data loss and ensure safe usage.

When the battery has expired

Batteries are consumable parts and the current battery cannot be used as the battery life has expired. Please replace it with a new battery (genuine) to prevent data loss and ensure safe usage. Whether or not batteries can be used is determined based on safety evaluations. To prevent data loss while replacing batteries, please be sure to save your work first.



Instruction messages related to battery life are displayed properly when the **Samsung Settings** application is installed on your computer. The messages may vary depending on the model and software version.

Troubleshooting

Samsung Recovery

When a problem occurs with the computer, it is easy to restore the computer back to the factory default settings by using the **Samsung Recovery** application (Recovery/Backup). It is also possible to restore the computer to a previously backed up point. Back up important data regularly before a problem occurs with the computer.



- The **Samsung Recovery** application may not be provided in models with less than 64 GB of storage. If you cannot access the Samsung Recovery application, refer to **Windows recovery function**.
- Some functions may differ or may be unavailable depending on the version. Refer to the application's help information.
- The **Samsung Recovery** application (Recovery/Backup) is not available when using CD/DVD drives.
- Recovering the computer erases the data or applications saved after a backup point. Therefore, back up important data regularly before a problem occurs with the computer.
- When you launch the application for the first time, read and accept the Terms and Conditions when they display on the screen.

Recovering to factory default

You can restore the computer to its factory default settings. If necessary, back up important data to an external storage device before restoring the system. See **Backing up data**.

- 1 **When the computer starts Windows:**
Select the Start button () → **Samsung Recovery**.

When the computer does not start Windows:

Turn on the computer and press the **F4** key several times before the Samsung logo appears.

- 2 Select **PC factory reset** → **Start factory reset**.

Follow the on-screen instructions to complete the recovery to its initial status.

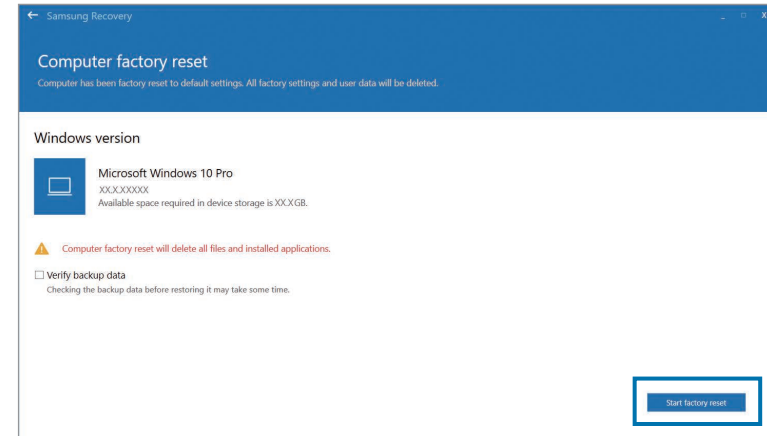

Backing up data

Back up important data to an alternate internal drive or an external storage device regularly to prevent data loss.

Backing up the current system

You can back up the factory default system or current system to an alternate internal drive or an external storage device.

- 1 Select the Start button (■) → **Samsung Recovery** → **Back up computer**.

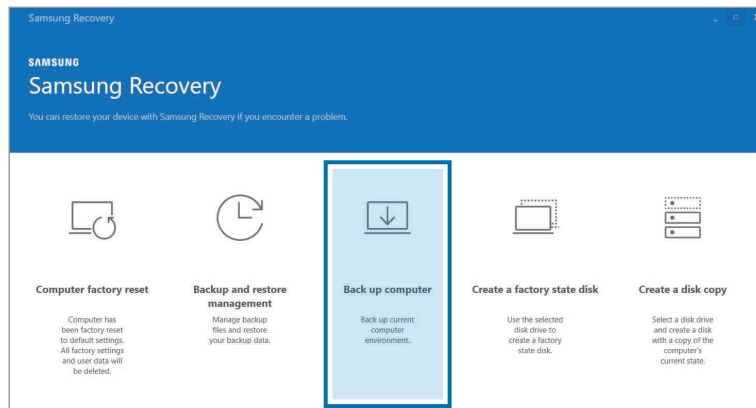

- 2 Select a drive to save the backed up data → **Start backup**.
 - When backing up to an external storage device, connect the device to the computer and then select the external drive.
- 3 Follow the on-screen instructions to complete the backup.

Backing up user data

You can back up data files and folders.

- 1 Turn on the computer and press the **F4** key several times.
- 2 Select **Back up user data**.
- 3 Select the files or folders to back up and choose a storage device to save the data to and then select **Start backup**.
 - The backed up folders or files can be saved only on an external storage device. Connect an external storage device to your computer first and then select the external drive.
- 4 Follow the on-screen instructions to complete the backup.

Recovering after a backup

Select a backup point saved on an alternate internal drive or an external storage device to recover the computer to that point.

- 1 When backing up to an external storage device, connect the device to the computer.
- 2 Select the Start button () → **Samsung Recovery**.

- 3 Select **Backup and restore management**.
- 4 Select **Restore** of the data you want to recover → **Start restore**.

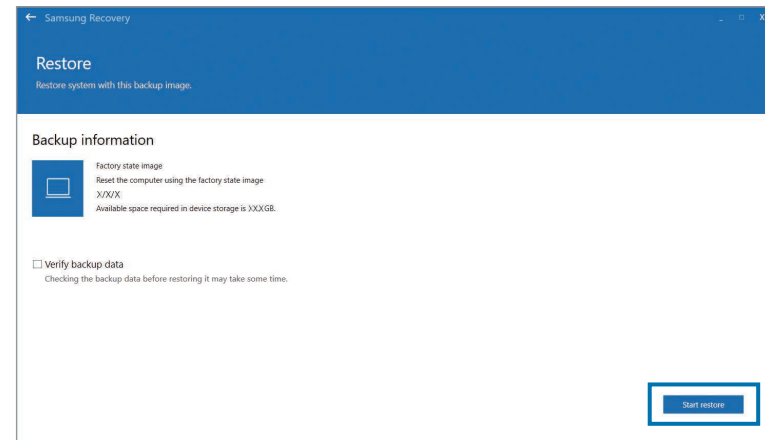

- 5 Follow the on-screen instructions to complete data recovery.

Copying the drive (making a disk image)

To replace the drive, move the data to the new drive by making a disk image. The new drive must be large enough to hold the data from the current drive. Purchase an external hard drive connector separately to connect the new drive to the computer.



When Windows is installed on a non-user replaceable disk, such as an eMMC, you cannot copy the drive.

- 1 Connect the new drive to the computer with an external hard drive connector.
- 2 Select the Start button (Windows logo) → **Samsung Recovery**.
- 3 Select **Create a factory state disk** or **Create a disk copy**.

- 4 Select a disk to be copied → **Start copy**.

The data on the disk is copied to the new disk.

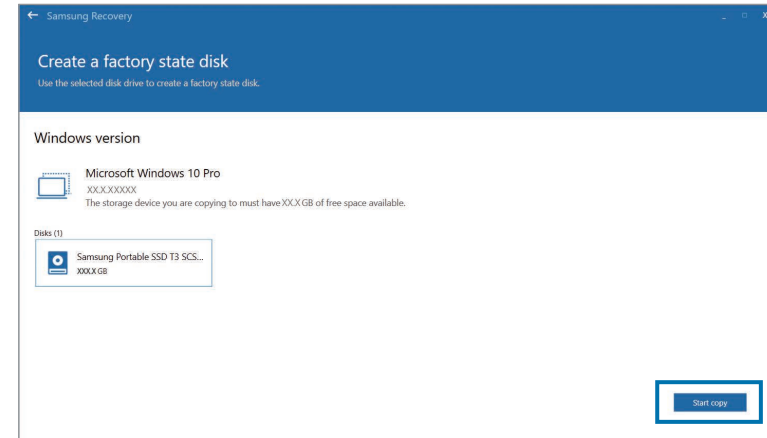

Windows recovery function

If the **Samsung Recovery** application is not supported by the computer, reinstall Windows using the recovery function of Windows.

 Reinstalling Windows will erase all data saved on the computer. Back up applications and personal data to an external storage device before reinstalling Windows.

- 1 Select the Start button (🪟) → ⚙️ → **Update & Security** → **Recovery**.
- 2 Select **Reset this PC** → **Get started**.
- 3 Select **Keep my files** or **Remove everything**.

 After the system is recovered, select the Start button (🪟) → **Samsung Update** to install the required Samsung applications.

Q&A

When experiencing problems with the computer, try these solutions.

Windows

How can I uninstall an application?

- 1 Select the Start button (🪟) → ⚙️ → **Apps** → **Apps & features**.
- 2 On the list, select an app to delete, and then select **Uninstall**.

Samsung Recovery

What is a Recovery Area?

The computer has an additional partition for restoring data or saving backup files (only for models with the **Samsung Recovery** application). This partition is called a Recovery Area and it includes a recovery image comprised of the operating system and applications.

Why is the capacity representation of the hard disk drive (HDD) in Windows different from the product specifications?

The capacity of the storage device (HDD or SSD) of the manufacturer is calculated assuming that 1 KB = 1,000 Bytes. However, the operating system (Windows) calculates the storage device capacity assuming that 1 KB = 1,024 Bytes, and therefore the capacity representation of the HDD in Windows is smaller than the actual capacity. The capacity representation in Windows may be smaller than the actual capacity because some applications occupy a certain area of the HDD outside of Windows.

For models with the **Samsung Recovery** application, the HDD capacity representation in Windows may be smaller than the actual capacity because the **Samsung Recovery** application uses a hidden area of 5–20 GB of the HDD to save the recovery image, and that hidden area is not counted towards the total size available to Windows. The size of the **Samsung Recovery** application varies by model.

What is a recovery image?

This refers to the operating system, drivers, and software that are converted to a data image. It is required to recover the computer and is embedded in the computer's HDD. However, this is not provided for storage devices where the capacity is less than 64 GB.

How can I restore a computer that does not have the Samsung Recovery application?

Restore the computer with the recovery function provided by Windows. Refer to the Recover Functionality item in the help for more details.

Miscellaneous

The camera and the microphone are not working. How do I turn them on again?

When recording protect mode is activated, the camera and microphone will not work.

Select the Start button () → **Samsung Security** → **Block Recording** and tap the switch to turn the features off.

The computer does not turn on automatically when the display panel is opened.

To turn on the computer, the display panel should be opened greater than a certain angle.

The angle may differ depending on the model.

If the computer LED does not turn on automatically, press the Power button.

Appendix

Product specifications

The system specifications may differ depending on the derived model. For detailed system specifications, refer to the product catalog.

Item	Specification
Operating environment	<ul style="list-style-type: none">• Temperature: -5–40 °C for storage, 10–35 °C when operating• Humidity: 5–90 % for storage, 20–80 % when operating
AC/DC rating	<ul style="list-style-type: none">• Input: 100–240 VAC, 50–60 Hz• Output: (PDO) 5 V, 3 A / 9 V, 3 A / 15 V, 3 A / 20 V, 3.25 A (PPS) 5–20 V, 3.25 A
PC rating	<ul style="list-style-type: none">• 20 VDC, 3.25 A (65 W)



- Optional components may not be provided or different components may be provided depending on the model.
- The system specifications are subject to change without notice.
- The Storage device capacity of a computer in which **Samsung Recovery** is installed is smaller than the product specification.
- For some models, it is not possible to add storage or add or replace memory due to the computer's design. To replace the storage, contact the Samsung Service Center. You will be charged for this service.
- The amount of memory that Windows can use may be smaller than the actual amount of memory available.

Ergonomic tips

Maintaining proper posture during computer use is very important to prevent physical injury. Improper or prolonged keyboard use may result in repetitive strain injury. Viewing the monitor screen for extended periods of time may result in eye strain. Therefore, please follow these guidelines carefully when setting up and using the computer.

Back and neck

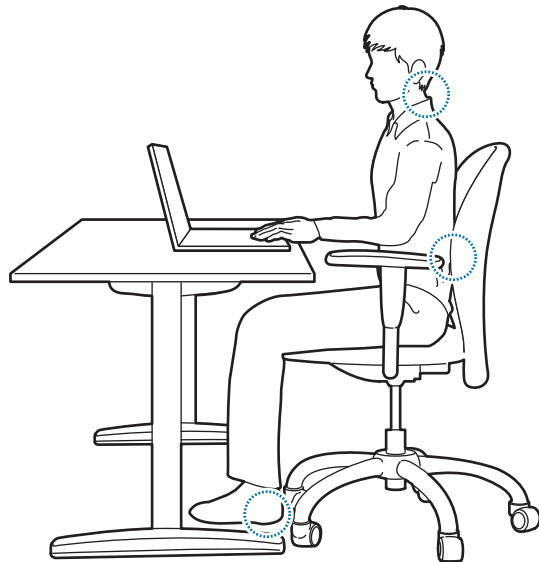

- Use an adjustable chair with firm, comfortable support.
- Adjust the height of your chair so that thighs are horizontal to the floor and feet are flat on the floor.
- The back of the chair should support the lower back. Adjust the backrest to fit your body properly.
- Sit back fully in your chair and straighten the back and neck. Avoid leaning forward or craning your neck toward the computer screen.
- Avoid using the computer while lying down or on your lap. If the computer's temperature increases, there is a danger of burn injury.



- The instructions in this manual have been prepared so that they can be applied to the range of needs of general users. If the user is not included in the range, the recommendations should be applied according to the user's needs.
- Images may differ from actual products.

Arms and hands

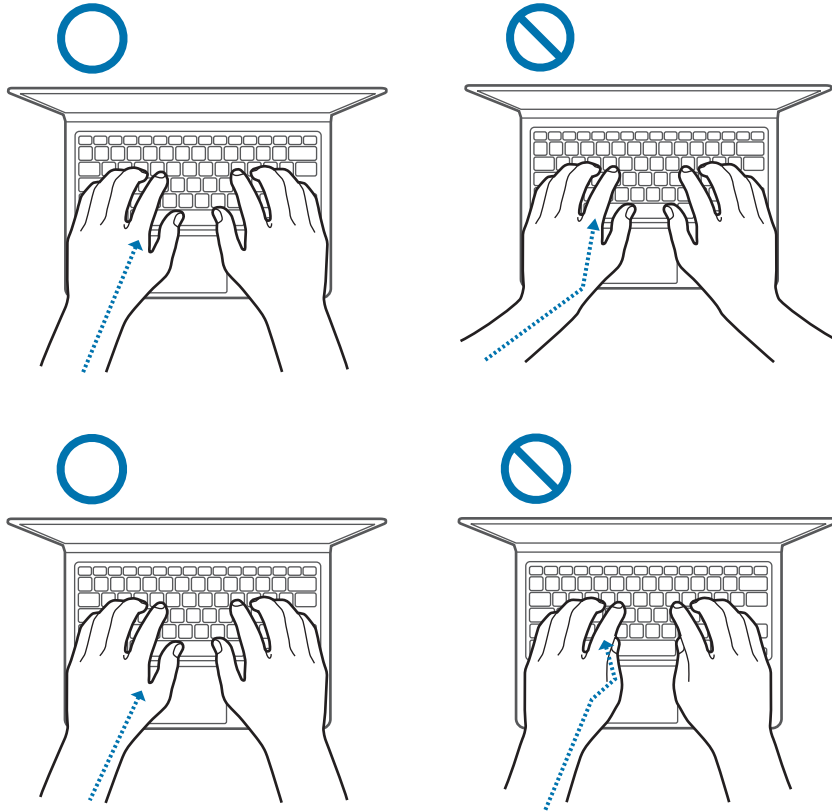

- When using the keyboard and touchpad, the shoulders should be relaxed. The upper arm and forearm should form an angle that is slightly greater than a right angle, with the wrist and hand in almost a straight line.
- Use a light touch when typing or using the touchpad and keep the hands and fingers relaxed. Avoid rolling the thumbs under your palms or supporting the wrists on the desk while typing.
- Use an external keyboard and mouse when using the computer for long periods. When using an external keyboard and mouse, position the devices at the same height as the computer and within comfortable reach.

Eye position and display illumination

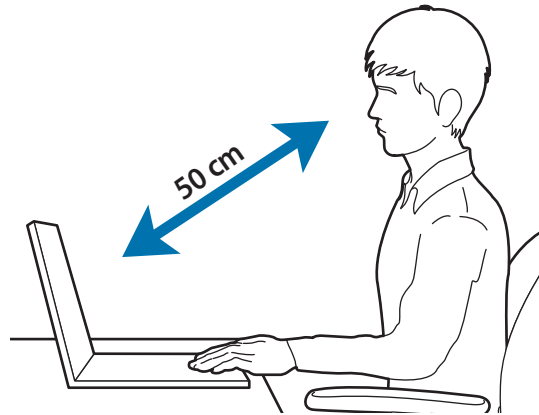

- Position the screen at least 50 cm away from your eyes.
- Adjust the height of the screen so that its top edge is equal to or just below the level of your eyes.
- Avoid setting the screen's brightness settings excessively high.
- Keep the screen clean.
- If wearing glasses, clean them before using the computer.
- When referring to printed content while typing, use a static paper holder to hold the paper at about the same height as the monitor.

Hearing and volume control

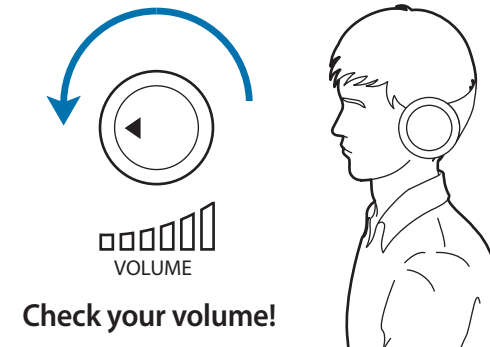

- Ensure that the volume is not too loud before using a headset or earphones. Excessive exposure to loud sounds can cause hearing damage.
- Always turn the volume down before plugging the earphones into an audio source and use only the minimum volume setting necessary to hear your conversation or music.
- Avoid using earphones for long periods of time.
- Default audio settings can be changed by software and driver updates without your knowledge. Always recheck equalizer and volume settings before listening to audio.
- To prevent possible hearing damage, do not listen at high volume levels for long periods.



Operating conditions

- Take at least a 10 minute break every hour.
- Avoid using the computer in dark locations. Use the computer with as much ambient light as you would when reading a book.
- Indirect illumination is recommended. Use a curtain to prevent reflections and glare on the screen.
- While operating a computer and talking on a phone, use a headset. Using the computer while holding a phone on your shoulder or with your neck may lead to muscle strain or injury.
- Keep frequently used items within reach.
- Only use the computer within the temperature and humidity ranges specified in this manual.

Use caution when exposed to flashing lights.

- While using your computer, leave some lights on in the room and do not hold the screen too close to your eyes.
- Seizures or blackouts can occur when you are exposed to flashing lights while watching videos or playing Flash-based games for extended periods. If you feel any discomfort, stop using the computer immediately.

- If anyone related to you has experienced seizures or blackouts while using a similar product, consult a physician before using the computer.
- If you feel discomfort, such as a muscle spasm, or disoriented, stop using the computer immediately and consult a physician.
- To prevent eye strain, take frequent breaks while using the computer.

Reduce the risk of repetitive motion injuries.

When you repetitively perform actions, such as pressing keys, drawing characters on a touch screen with your fingers, or playing games, you may experience occasional discomfort in your hands, neck, shoulders, or other parts of your body. When using your computer for extended periods, hold the computer with a relaxed grip, press the keys lightly, and take frequent breaks. If you continue to have discomfort during or after such use, stop using the computer and consult a physician.

Safety precautions

For your safety and security and to prevent damage, carefully read the following safety instructions. This 'Safety precautions' relate to computer use. Some of the content may not be applicable to your computer.



- Since this is commonly applied to Samsung computers, some pictures may differ from actual products.
- The product mentioned in this guide refers to all items supplied with the computer including the battery, the AC adapter, and all other Samsung-provided accessories.



Warning

Failure to follow the instructions marked with this symbol may result in physical injury or fatality.

Power related

Handle the power cord with care.

- Do not touch with wet hands.
- Do not use a damaged power cord.
- Do not overload a multi-outlet or an extension cord beyond the specified voltage/current capacity.
- Firmly insert the power cable into the AC adapter.
- Do not unplug the power cord by pulling on the cable.
- Unplug the wall-mount AC adapter (integrated plug and power adapter) from the wall outlet while holding the body and pulling it in the direction of the arrow.

Failure to do so may result in electric shock or fire.

Connect the power cord to the AC adapter firmly.

An improper connection may result in a fire.

Use the approved adapter or cable included in the product box.

If you use the unapproved adapter or cable, it cause the damage or malfunction of the computer.

Use only properly earthed electric sockets or extension cords.

Unearthed electric sockets or extension cords may cause electric shock. Any connection to unearthed electric sockets or extension cords may produce an electric field from a current leak.

If water or other substances enter the product, disconnect the power cable and contact a Samsung Service Center. For notebook computers that are supplied with an optional removable battery, disconnect the battery.

Failure to do so may result in electric shock or fire due to computer malfunction.

Do not let dust accumulate on the power cord or the electric socket. Regularly wipe the power cord and the electric socket with a dry cloth.

Failure to do so may result in electric shock or fire.

Do not bend or damage the power cable or the AC adapter with a heavy or sharp-edged object.

A damaged cable or cord may result in electric shock or fire.

Keep the battery, AC adapter, and power cord away from infants, children, and pets.

Failure to do so may result in electric shock or damage.

Battery usage related

Use manufacturer-approved batteries, chargers, accessories, and supplies.

- Using generic batteries or chargers may shorten the life of your product or cause the computer to malfunction. They may also cause a fire or cause the battery to explode.
- Use only Samsung-approved battery and charger specifically designed for your device. Incompatible battery and charger can cause serious injuries or damage to your device.
- Samsung cannot be responsible for the user's safety when using accessories or supplies that are not approved by Samsung.

Take care to not allow metal objects such as a key or clip to touch the battery terminals (metal parts).

This may cause excessive current and result in fire, burns, or damage to the battery.

If the computer or the computer battery leaks, emits strange odors, or swells, immediately stop using the computer and contact a Samsung Service Center.

Failure to do so may result in an explosion or fire.

Replace a run-down battery with a new, Samsung-approved battery.

Dispose of worn-out batteries properly.

- There is a danger of fire or explosion.
- The battery disposal method may differ depending on your country and region. Dispose of the used battery in an appropriate way.

When removing the real time clock (RTC) battery, keep it away from infants and children.

If a child swallows the battery, the child may suffocate. If this happens, immediately contact a doctor.

Do not throw or disassemble the battery and do not put it into water.

There is a danger of injury, fire or explosion.

Charge the battery according to the instructions in the manual.

Failure to do so may cause an explosion or fire.

Usage related

Do not use the computer on heated floors or electric pads, or on beds, blankets, or cushions that block the ventilation of the computer.

A blocked vent causes the computer to overheat, resulting in an explosion, fire, burns, or computer malfunction.

Do not use the computer in hot or humid locations, such as a bathroom, sauna, or inside a car during summer.

Failure to do so may result in computer malfunction or electric shock.

The computer can be used in locations with an ambient temperature of 10 °C to 35 °C and a relative humidity of 20 % to 80 %RH.

To avoid suffocation, keep the plastic bag away from infants and children.

Putting a plastic bag over the head may result in suffocation.

Never heat the computer (or the battery) or put the computer (or the battery) into a fire or microwave.

Failure to do so may result in an explosion or fire.

Before cleaning the computer, disconnect all the cables that are connected to the computer. For notebook computers that are supplied with an optional removable battery, disconnect the battery.

Failure to do so may result in electric shock or fire.

Keep the computer away from water or liquid.

Water or liquid entering the computer may short-circuit the computer, resulting in electric shock or fire.

If the computer is dropped or broken, disconnect the power cord and contact a Samsung Service Center. For notebook computers that are supplied with an optional removable battery, disconnect the battery.

Using a broken computer may result in electric shock or fire.

Do not touch the computer's surface or the vents for extended periods while the computer is on.

Contact with the vent or the surface for extended periods may result in low-temperature burns, such as redness on the skin.

Do not carry your device in your back pockets.

- The device may be damaged, explode, or result in a fire if too much pressure is applied to it.
- You may be injured if you are bumped or fall.



Failure to follow instructions marked with this symbol may result in minor physical injury or damage to the computer.

Installation related

Do not block the ports (holes), vents, etc., of the product and do not insert objects.

Damage to a component within the computer may cause electric shock or fire.

When using the computer on its side, ensure the vents are clear and facing upwards.

Failure to do so, may cause the internal temperature of the computer to rise and the computer to malfunction or halt.

Keep the computer's vents at least 15 cm away from walls and other objects.

Failure to do so may result in physical injury.

Do not place or use the computer on slanted or vibrating surfaces.

Failure to do so may result in computer malfunction or damage.

Do not place heavy objects on the product.

This may cause a problem with the computer. In addition, the object may fall and cause injury or damage the computer.

Properly shut down, disconnect and secure the computer cables before moving it.

Failure to do so may damage the computer or cause someone to trip over a loose cable.

Usage related

Do not use the pen for unintended purposes, such as poking the body, like eyes or ears, and do not put it in your mouth.

Doing so may result in physical injury.

Do not place a candle, lit cigar, etc., over or on the product.

There is a danger of fire.

Make sure to have the product tested by a safety service engineer after repairing the product.

Using a repaired product without testing it for safety may cause an electric shock or fire.

In case of lightning, immediately turn the system off, then disconnect the power cord from the wall outlet and phone line from modem.

There is a danger of electric shock or fire.

Connect only permitted devices to the connectors or ports of the computer.

Failure to do so may result in an electric shock or fire.

Close the display panel only after checking if the notebook computer is turned off.

The temperature may rise and it may cause deformation of the product.

Do not press the eject button while the CD-ROM drive is in operation.

You might lose data and the disc might be suddenly ejected and could cause an injury.

Do not drop or hit the computer against anything.

Failure to do so may result in physical injury or computer malfunction.

When handling computer parts, follow the instructions on the manual supplied with the parts.

Failure to do so may result in damage to the product.

If the product emits smoke or there is a burning smell, disconnect the power plug from the wall outlet and contact a Samsung Service Center immediately. For notebook computers that are supplied with an optional removable battery, disconnect the battery.

There is a danger of fire.

Do not store your device near or in heaters, microwaves, hot cooking equipment, or high pressure containers.

- The battery may leak.
- Your device may overheat and cause a fire.

Do not use damaged or illegally modified CDs.

There is a danger of damaging the product or personal injury.

Do not insert your fingers into the ports (holes), card slot, or vents.

There is a danger of injury or electric shock.

Use recommended computer cleansing solutions when cleaning the product and only use the computer when it is completely dry.

Failure to do so may result in electric shock or fire.

You should not use a paper clip to perform an emergency disc ejection while the disc is in motion. Make sure to use the emergency disc eject method only when the Optical Disc Drive has stopped.

There is a danger of injury.

Do not place your face close to the Optical Disc Drive tray when it is operating.

There is a danger of injury due to an abrupt ejection.

Do not use the product if it is cracked or broken.

Broken glass or acrylic could cause injury to your hands and face. Take the device to a Samsung Service Center to have it repaired.

When using wireless communication (LAN, Bluetooth, etc.) always follow applicable instructions. For example, airlines and hospitals have strict requirements.

Avoid exposing a drive to magnetic fields. Security devices with magnetic fields include airport walk-through devices and security wands. The airport security devices that check carry-on luggage use X-rays instead of magnetism and will not damage a drive.

Keep the computer away from magnetic material.

- Magnetic materials may cause computer malfunction or cause the battery to discharge.
- To avoid damaging the computer or magnetic stripe cards, such as credit cards, keep magnetic stripe cards away from the computer.

Do not use your computer in a hospital or on an aircraft that can be interfered with by radio frequency.

- Avoid using your computer within a 15 cm range of a pacemaker, if possible, as your computer can interfere with the pacemaker.
- To minimize possible interference with a pacemaker, use your computer only on the side of your body that is opposite the pacemaker.
- If you use medical equipment, contact the equipment manufacturer before using your computer to determine whether or not the equipment will be affected by radio frequencies emitted by the computer.
- When in a hospital, turn off your computer and follow all hospital regulations. Radio frequencies emitted from the computer may affect medical equipment.

Upgrade Related

Do not attempt to upgrade the computer, unless you are qualified. Otherwise, contact a Samsung Service Center or an authorized technician.

When you upgrade permitted devices, according to the manual, follow the specified instructions in the manual to upgrade them. Do not disassemble any other parts by yourself.

Failure to do so may result in computer malfunction, electric shock, or fire.

Take care when touching the product or parts.

The computer may be damaged or you may be injured.

Do not disassemble the power supply unit in any circumstances.

Failure to do so may result in electric shock, fire, or an explosion.

Shut down the computer and disconnect all cables before disassembling the computer. For notebook computers that are supplied with an optional removable battery, disconnect the battery.

Failure to do so may cause electric shock.

Make sure to close the computer cover before connecting the power after a reassembly.

There is a danger of electric shock if your body touches an internal part.

Never disassemble or repair the product by yourself.

There is danger of an accident. Use an authorized Samsung Service Center.

To connect a device that is not manufactured or authorized by Samsung, enquire at a Samsung Service Center before connecting the device.

There is a danger of damaging the product.

Storage and movement related

Do not store the computer in an enclosed space, such as a computer bag, while it is running.

Failure to do so may result in fire. Completely shut down the computer before putting the computer into an enclosed space.

When carrying the notebook computer with other items, such as the adapter, mouse, books etc., take care not to press anything against the notebook computer.

If a heavy object is pressed against the notebook computer, a white spot or stain may appear on the display.

Do not operate or look at the computer while driving a vehicle.

There is a danger of a traffic accident. Please concentrate on driving.

For long periods of inactivity or storage, discharge the battery and separate it from the computer (for external or removable battery types).

Cautions on preventing data loss (storage device (e.g., HDD, SSD, eMMC) management)

Take care not to damage the data on a storage device (e.g., HDD, SSD, eMMC).

- Subjecting the device to physical impacts may result in data loss.
- Data may be lost when the computer is turned off or reset by a power failure while the storage device (e.g., HDD, SSD, eMMC) is operating.
- Data may be lost and irrecoverable due to a computer virus.
- Data may be lost if the power is turned off while running an application.
- Samsung is not liable for any loss of data on a storage device (e.g., HDD, SSD, eMMC).

To prevent data loss due to damage to a storage device (e.g., HDD, SSD, eMMC), please back up the data frequently.

Display bad pixels

Samsung observes strict specifications regarding the quality and reliability of the display. However, there is a small chance that a few pixels may be bad. A large number of bad pixels can cause problems with the display, but a small number of bad pixels does not generally affect computer performance.

Samsung's quality standards for bad pixels are as follows:

- **Bright dot:** 2 or fewer
- **Black dot:** 4 or fewer
- **Combination (bright and dark):** 4 or fewer

Clean the display screen with a soft cloth dampened with computer cleansing detergent.

Do not use excessive force. Doing so may damage the display screen.

Important safety information

Safety instructions

The system is designed and tested to meet the latest standards for safety of information technology equipment. However, to ensure safe use of this product, it is important that the safety instructions marked on the product and in the documentation are followed.



Always follow these instructions to help guard against personal injury and damage to the system.

Setting up the system

- Read and follow all instructions marked on the product and in the documentation before operating the system. Retain all safety and operating instructions for future use.
- Do not use this product near water or a heat source such as a radiator.
- Set up the system on a stable work surface.
- The product should be operated only with the type of power source indicated on the rating label.
- Ensure that the electrical outlet to power the equipment is easily accessible in case of fire or short circuit.
- If the computer has a voltage selector switch, make sure that the switch is in the proper position for your area.
- Openings in the computer case are provided for ventilation. Do not block or cover these openings. Make sure you provide adequate space, at least 6 inches (15 cm), around the system for ventilation when setting up your work area. Never insert objects of any kind into the computer ventilation openings.

- Ensure that the fan vents on the bottom of the casing are clear at all times. Do not place the computer on a soft surface, doing so will block the bottom vents.
- When using an extension cord with this system, make sure that the total power rating on the products plugged into the extension cord does not exceed the extension cord power rating.
- For computers with glossy display bezels the user should consider the placement of the computer as the bezel may cause reflections from surrounding light and bright surfaces.

Care during use

- Do not walk on the power cord or allow anything to rest on it.
- Do not spill anything on the computer or its components. The best way to avoid spills is to not eat or drink near the computer or its components.
- Some products have a replaceable CMOS battery on the system board. There is a danger of explosion if the CMOS battery is replaced incorrectly. Replace the battery with the same or equivalent type recommended by the manufacturer. Dispose of batteries according to the manufacturers instructions. If the CMOS battery requires replacement ensure that a qualified technician performs the task.
- When the computer is turned off, a small amount of electrical current still flows through the computer.
To avoid electrical shock, always unplug all power cables, remove the battery and modem cables from the wall outlets before cleaning the system.

- Unplug the system from the wall outlet and contact a Samsung Service Center if:
 - The power cord or plug is damaged.
 - Liquid has been spilled into the computer.
 - The computer does not operate properly when the operating instructions are followed.
 - The computer was dropped or the casing is damaged.
 - The computer performance changes.

Operating instructions

- 1 When installing and operating devices please refer to safety requirements in the user manual.
- 2 Devices can be used only with the equipment specified in the technical specifications of the devices.
- 3 If any smell of burning or smoke is detected from the computer the unit should be switched off and the battery removed. The unit should be checked by a qualified technician before reuse.
- 4 Service and repair of devices should be carried out by authorized service centers.
- 5 Do not allow the portable computer to operate with the base resting directly on exposed skin for extended periods of time. The surface temperature of the base will rise during normal operation (particularly when AC Power is present). Allowing sustained contact with exposed skin can cause discomfort or eventually a burn.

Replacement parts and accessories

Use only replacement parts and accessories recommended by manufacturer.

 To reduce the risk of fire, use only No. 26 AWG or larger telecommunications line cord.

 Do not use this product in areas classified as hazardous. Such areas include patient care areas of medical and dental facilities, oxygen rich environments, or industrial areas.

Battery disposal

 Do not put rechargeable batteries or products powered by non-removable rechargeable batteries in the garbage.

Contact the Samsung Service Center for information on how to dispose of batteries that you cannot use or recharge any longer. Follow all local regulations when disposing of old batteries.

 THERE IS RISK OF EXPLOSION IF BATTERY IS REPLACED BY AN INCORRECT TYPE.
DISPOSE OF USED BATTERIES ACCORDING TO THE INSTRUCTIONS.

Laser safety

All systems equipped with CD or DVD drives comply with the appropriate safety standards, including IEC 60825-1. The laser devices in these components are classified as “Class 1 Laser Products” under a US Department of Health and Human Services (DHHS) Radiation Performance Standard. Should the unit ever need servicing, contact an authorized service location.



- **Laser Safety Note:** Use of controls or adjustments or performance of procedures other than those specified in this manual may result in hazardous radiation exposure. To prevent exposure to laser beams, do not try to open the enclosure of a CD or DVD drive.
- Class 1M laser radiation when operating part is open. Do not view directly with optical instruments.
- Class 3B invisible laser radiation when open. Avoid exposure to the beam.

Connecting and disconnecting the AC adapter

The socket-outlet shall be installed near the equipment and shall be easily accessible.

Do not unplug the power cord by pulling the cable only.

Power cord requirements

The power cord set (all plugs, cable and AC adapter plugs) you received with your computer meets the requirements for use in the country where you purchased your equipment.

Power cord sets for use in other countries must meet the requirements of the country where you use the computer. For more information on power cord set requirements, contact your authorized dealer, reseller, or service provider.

India only

The power cord set must have a minimum current capacity and a nominal voltage rating, as required by country's power system.

General requirements

The requirements listed below are applicable to all countries:

- All power cord sets must be approved by an acceptable accredited agency responsible for evaluation in the country where the power cord set will be used.
- The power cord set must have a minimum current capacity of 7A and a nominal voltage rating of 125 or 250 volts AC, as required by each country's power system (USA only).
- The appliance coupler must meet the mechanical configuration of an EN 60 320/IEC 320 Standard Sheet C7 (or C5) connector, for mating with appliance inlet on the computer.

Regulatory compliance statements

Wireless guidance

(If fitted with 2.4 G band or 5 G band)

Low power, Radio LAN type devices (radio frequency (RF) wireless communication devices), operating in the 2.4 GHz/5 GHz Band, may be present (embedded) in the notebook system. The following section is a general overview of considerations while operating a wireless device.

Additional limitations, cautions, and concerns for specific countries are listed in the specific country sections (or country group sections). The wireless devices in the system are only qualified for use in the countries identified by the Radio Approval Marks on the system rating label. If the country you will be using the wireless device in, is not listed, please contact your local Radio Approval agency for requirements. Wireless devices are closely regulated and use may not be allowed.

The RF field strength of the wireless device or devices that may be embedded in the notebook are well below all international RF exposure limits as known at this time. Because the wireless devices (which may be embedded into the notebook) emit less energy than is allowed in radio frequency safety standards and recommendations, manufacturer believes these devices are safe for use. Regardless of the power levels, care should be taken to minimize human contact during normal operation.

Some circumstances require restrictions on wireless devices.

Examples of common restrictions are listed on the next page:



- Radio frequency wireless communication can interfere with equipment on commercial aircraft. Current aviation regulations require wireless devices to be turned off while traveling in an airplane.
802.11ABGN (also known as wireless Ethernet or Wi-Fi) and Bluetooth communication devices are examples of devices that provide wireless communication.
- In environments where the risk of interference to other devices or services is harmful or perceived as harmful, the option to use a wireless device may be restricted or eliminated. Airports, hospitals, and oxygen or flammable gas laden atmospheres are limited examples where use of wireless devices may be restricted or eliminated. When in environments where you are uncertain of the sanction to use wireless devices, ask the applicable authority for authorization prior to use or turning on the wireless device.
- Every country has different restrictions on the use of wireless devices. Since your system is equipped with a wireless device, when traveling between countries with your system, check with the local Radio Approval authorities prior to any move or trip for any restrictions on the use of a wireless device in the destination country.
- If the system came equipped with an internal embedded wireless device, do not operate the wireless device unless all covers and shields are in place and the system is fully assembled.
- Wireless devices are not user serviceable. Do not modify them in any way. Modification to a wireless device will void the authorization to use it. Please contact the manufacturer for service.
- Only use drivers approved for country in which the device will be used. See the manufacturer System Restoration Kit, or contact the manufacturer's technical support for additional information.

United States of America and Canada

USA and Canada Safety Requirements and Notices

Do not touch or move antenna while the unit is transmitting or receiving.

Do not hold any component containing the radio such that the antenna is very close to touching any exposed parts of the body, especially the face or eyes, while transmitting.

Do not operate the radio or attempt to transmit data unless the antenna is connected; if not, the radio may be damaged.

Use in specific environments:

The use of wireless devices in hazardous locations is limited by the constraints posed by the safety directors of such environments.

The use of wireless devices on airplanes is governed by the Federal Aviation Administration (FAA) in the USA and Transport Canada Civil Aviation (TCCA) in Canada.

The use of wireless devices in hospitals is restricted to the limits set forth by each hospital.



Explosive Device Proximity Warning

Do not operate a portable transmitter (such as a wireless network device) near unshielded blasting caps or in an explosive environment unless the device has been modified to be qualified for such use.



Use On Aircraft Caution

FCC, FAA, and TCCA regulations prohibit airborne operation of radio-frequency wireless devices because their signals could interfere with critical aircraft instruments.

Other wireless devices

Safety notices for other devices in the wireless network:

Refer to the documentation supplied with wireless Ethernet adapters or other devices in the wireless network.



The Part 15 radio device operates on a non-interference basis with other devices operating at this frequency. Any changes or modification to said product not expressly approved by Intel could void the user's authority to operate this device.

Unintentional emitter per FCC Part 15

Responsible Party – U.S. Contact Information

Samsung Electronics America, Inc.

85 Challenger Road.

Ridgefield Park, NJ 07660

Phone: 1-800-SAMSUNG (726-7864)

This device complies with Part 15 of the FCC Rules. Operation is subject to the following two conditions: (1) this device may not cause harmful interference, and (2) this device must accept any interference received, including interference that may cause undesired operation.



This equipment has been tested and found to comply with the limits for a Class B digital device pursuant to Part 15 of the FCC Rules. These limits are designed to provide reasonable protection against harmful interference in a residential installation. This equipment generates, uses, and can radiate radio frequency energy. If not installed and used in accordance with the instructions, it may cause harmful interference. If this equipment does cause harmful interference to radio or television reception, which can be determined by turning the equipment off and on, the user is encouraged to try to correct the interference by one or more of the following measures:

- Reorient or relocate the receiving antenna.
- Increase the separation between the equipment and receiver.
- Connect the equipment into an outlet on a circuit different from that to which the receiver is connected.
- Consult the dealer or an experienced radio/TV technician for help.

If necessary, the user should consult the dealer or an experienced radio/television technician for additional suggestions. The user may find the following booklet helpful: "Something About Interference."

This is available at FCC local regional offices. Our company is not responsible for any radio or television interference caused by unauthorized modifications of this equipment or the substitution or attachment of connecting cables and equipment other than those specified by our company. The correction will be the responsibility of the user. Use only shielded data cables with this system.

Intentional emitter per FCC Part 15

(If fitted with 2.4 G band or 5 G band)

Low power, Radio LAN type devices (radio frequency (RF) wireless communication devices), operating in the 2.4 GHz/5 GHz Band, may be present (embedded) in the notebook system. This section is only applicable if these devices are present. Refer to the system label to verify the presence of wireless devices.

Wireless devices that may be in the system are only qualified for use in the United States of America if an FCC ID number is on the system label.

This device is restricted to indoor use due to its operation in the 5.15 to 5.25 GHz frequency range. FCC requires this product to be used indoors for the frequency range 5.15 to 5.25 GHz to reduce the potential for harmful interference to co-channel Mobile Satellite systems. High power radars are allocated as primary users of the 5.25 to 5.35 GHz and 5.65 to 5.85 GHz bands. These radar stations can cause interference with and/or damage this device.

Operation of this device is subject to the following two conditions:

(1) This device may not cause harmful interference, and (2) this device must accept any interference received, including interference that may cause undesired operation of the device.



Wireless devices are not user serviceable. Do not modify them in any way.

Modification to a wireless device will void the authorization to use it. Contact manufacturer for service.

Health and safety information

Exposure to Radio Frequency (RF) Signals Certification Information

This product can contain an embedded radio transmitter and receiver. It is designed and manufactured not to exceed the exposure limits for radio frequency (RF) energy set by the Federal Communications Commission (FCC) of the U.S. government. These FCC exposure limits are derived from the recommendations of two expert organizations, the National Council on Radiation Protection and Measurement (NCRP) and the Institute of Electrical and Electronics Engineers (IEEE). In both cases, the recommendations were developed by scientific and engineering experts drawn from industry, government, and academia after extensive reviews of the scientific literature related to the biological effects of RF energy.

Before a new model is available for sale to the public, it must be certified to the FCC that it does not exceed the exposure limit established by the FCC. Evaluation per each model is performed in positions and locations (e.g. at the bottom on the body) as required by the FCC.

For body worn operation, this model meets the FCC RF exposure guidelines when used with Samsung accessory designated for this product. Non-compliance with the above restrictions may result in violation of FCC RF exposure guidelines.

RF exposure or SAR information can be viewed on-line at www.fcc.gov/oet/ea/fccid/. This site uses this product FCC ID number on the outside of the product. Sometimes it may be necessary to remove the battery pack to find number. Once you have the FCC ID number for a particular product, follow the instructions on the website and it should provide RF exposure information or values for typical or maximum SAR for particular product.

For corresponding model only

The Specific Absorption Rate (SAR) is a measure of the rate of absorption of RF energy by the human body expressed in units of watts per kilogram (W/kg). The FCC wireless devices to comply with a safety limit of 1.6 watts per kilogram (1.6 W/kg).

SAR level of this device while operating can be well below the maximum value. This is because the device is designed to operate at multiple power levels so as to use only the power required to reach the network. In general, the closer you are to a wireless base station antenna, the lower the power output.

Manufacturer information

Samsung Electronics Co., Ltd.

129, Samsung-Ro, Yeongtong-Gu, Suwon-City, Gyeonggi-Do,
443-742, Korea

Samsung Electronics Vietnam Co., Ltd.

Khu Cong nghiep Yen Phong 1, Yen Trung, Yen Phong, Bac Ninh,
Viet Nam

Tel: +84-222-369-6875

For the web or the phone number of the Samsung Service Center,
see the Warranty or contact the retailer where you purchased your
product.

RTC caution

CAUTION: Danger of explosion if battery is incorrectly replaced.
Replace only with the same or equivalent type recommended
by the manufacturer. Discard used batteries according to the
Manufacturer's instruction.

Canada

Innovation, Science and Economic Development Statement:

This device contains licence-exempt transmitter(s)/receiver(s) that comply with Innovation, Science and Economic Development Canada's licence-exempt RSS(s). Operation is subject to the following two conditions:

1. This device may not cause interference.
2. This device must accept any interference, including interference that may cause undesired operation of the device.

Industry Canada Caution

The device for operation in the band 5150-5250 MHz is only for indoor use to reduce the potential for harmful interference to co-channel mobile satellite systems.

Innovation, Sciences et Développement économique Canada

L'émetteur/récepteur exempt de licence contenu dans le présent appareil est conforme aux CNR d'Innovation, Sciences et Développement économique Canada applicables aux appareils radio exempts de licence. L'exploitation est autorisée aux deux conditions suivantes :

1. L'appareil ne doit pas produire de brouillage.
2. L'appareil doit accepter tout brouillage radioélectrique subi, même si le brouillage est susceptible d'en compromettre le fonctionnement.

Avertissement:

Les dispositifs fonctionnant dans la bande 5 150-5 250 MHz sont réservés uniquement pour une utilisation à l'intérieur afin de réduire les risques de brouillage préjudiciable aux systèmes de satellites mobiles utilisant les mêmes canaux.

WEEE symbol information



Correct disposal of this product (Waste Electrical & Electronic Equipment)

■ (Applicable in countries with separate collection systems)

This marking on the product, accessories or literature indicates that the product and its electronic accessories (for example, charger, headset, USB cable) should not be disposed of with other household waste at the end of their working life.

To prevent possible harm to the environment or human health from uncontrolled waste disposal, please separate these items from other types of waste and recycle them responsibly to promote the sustainable reuse of material resources.

Household users should contact either the retailer where they purchased this product, or their local government office, for details of where and how they can take these items for environmentally safe recycling.

Business users should contact their supplier and check the terms and conditions of the purchase contract. This product and its electronic accessories should not be mixed with other commercial wastes for disposal.

For information on Samsung's environmental commitments and product regulatory obligations, e.g. REACH, WEEE or Batteries, visit our sustainability page available via www.samsung.com.

India only

For more information on safe disposal and recycling visit our website www.samsung.com/in or contact our Helpline numbers - 18002668282, 180030008282.

This product is RoHS compliant.



Correct disposal of batteries in this product

(Applicable in countries with separate collection systems)

This marking on the battery, manual or packaging indicates that the batteries in this product should not be disposed of with other household waste at the end of their working life. Where marked, the chemical symbols Hg, Cd or Pb indicate that the battery contains mercury, cadmium or lead above the reference levels in EC Directive 2006/66. If batteries are not properly disposed of, these substances can cause harm to human health or the environment.

To protect natural resources and to promote material re-use, please separate batteries from other types of waste and recycle them through your local, free battery return system.

PO BOX 12987, DUBLIN, IE

Removing the battery (Europe only)

- To remove the battery, contact an authorised service centre. To obtain battery removal instructions, please visit www.samsung.com/global/ecodesign_energy.
- For your safety, you **must not attempt to remove** the battery. If the battery is not properly removed, it may lead to damage to the battery and device, cause personal injury, and/or result in the device being unsafe.
- Samsung does not accept liability for any damage or loss (whether in contract or tort, including negligence) which may arise from failure to precisely follow these warnings and instructions, other than death or personal injury caused by Samsung's negligence.

USA only

This Perchlorate warning applies only to primary CR (Manganese Dioxide) Lithium coin cells in the product sold or distributed ONLY in California USA.

“Perchlorate Material- special handling may apply, see www.dtsc.ca.gov/hazardouswaste/perchlorate.”

Dispose unwanted electronics through an approved recycler.

To find the nearest recycling location, go to our website: www.samsung.com/recycling or call, 1-800-SAMSUNG.

For battery recycling go to call2recycle.org; or call 1-800-822-8837.

Samsung package Take-Back program (USA only)

In partnering with select recyclers, Samsung offers packaging take-back at no cost to you.

Simply call the following number for the locations nearest you.

CRT Processing, LLC

(877) 278-0799

Kathy Severson – Logistics contact

Dispose unwanted electronics through an approved recycler.

To find the nearest recycling location, go to our website:

www.samsung.com/recycling or call, 1-800-SAMSUNG.

Some content may differ from the computer depending on the region, service provider, software version, or computer model, and is subject to change without prior notice.

SAMSUNG